



This is a digital copy of a book that was preserved for generations on library shelves before it was carefully scanned by Google as part of a project to make the world's books discoverable online.

It has survived long enough for the copyright to expire and the book to enter the public domain. A public domain book is one that was never subject to copyright or whose legal copyright term has expired. Whether a book is in the public domain may vary country to country. Public domain books are our gateways to the past, representing a wealth of history, culture and knowledge that's often difficult to discover.

Marks, notations and other marginalia present in the original volume will appear in this file - a reminder of this book's long journey from the publisher to a library and finally to you.

### Usage guidelines

Google is proud to partner with libraries to digitize public domain materials and make them widely accessible. Public domain books belong to the public and we are merely their custodians. Nevertheless, this work is expensive, so in order to keep providing this resource, we have taken steps to prevent abuse by commercial parties, including placing technical restrictions on automated querying.

We also ask that you:

- + *Make non-commercial use of the files* We designed Google Book Search for use by individuals, and we request that you use these files for personal, non-commercial purposes.
- + *Refrain from automated querying* Do not send automated queries of any sort to Google's system: If you are conducting research on machine translation, optical character recognition or other areas where access to a large amount of text is helpful, please contact us. We encourage the use of public domain materials for these purposes and may be able to help.
- + *Maintain attribution* The Google "watermark" you see on each file is essential for informing people about this project and helping them find additional materials through Google Book Search. Please do not remove it.
- + *Keep it legal* Whatever your use, remember that you are responsible for ensuring that what you are doing is legal. Do not assume that just because we believe a book is in the public domain for users in the United States, that the work is also in the public domain for users in other countries. Whether a book is still in copyright varies from country to country, and we can't offer guidance on whether any specific use of any specific book is allowed. Please do not assume that a book's appearance in Google Book Search means it can be used in any manner anywhere in the world. Copyright infringement liability can be quite severe.

### About Google Book Search

Google's mission is to organize the world's information and to make it universally accessible and useful. Google Book Search helps readers discover the world's books while helping authors and publishers reach new audiences. You can search through the full text of this book on the web at <http://books.google.com/>

NEDL. TRANSFER



HN 538E R

640 360  
K.H.E.



**Harvard College Library.**

---

Bought with  
Money received from the  
sale of duplicates.

30 Mar. 1875.









THE  
AMERICAN CYCLOPÆDIA.

---

VOL. IX.  
HORTENSIUS—KINGLAKE.



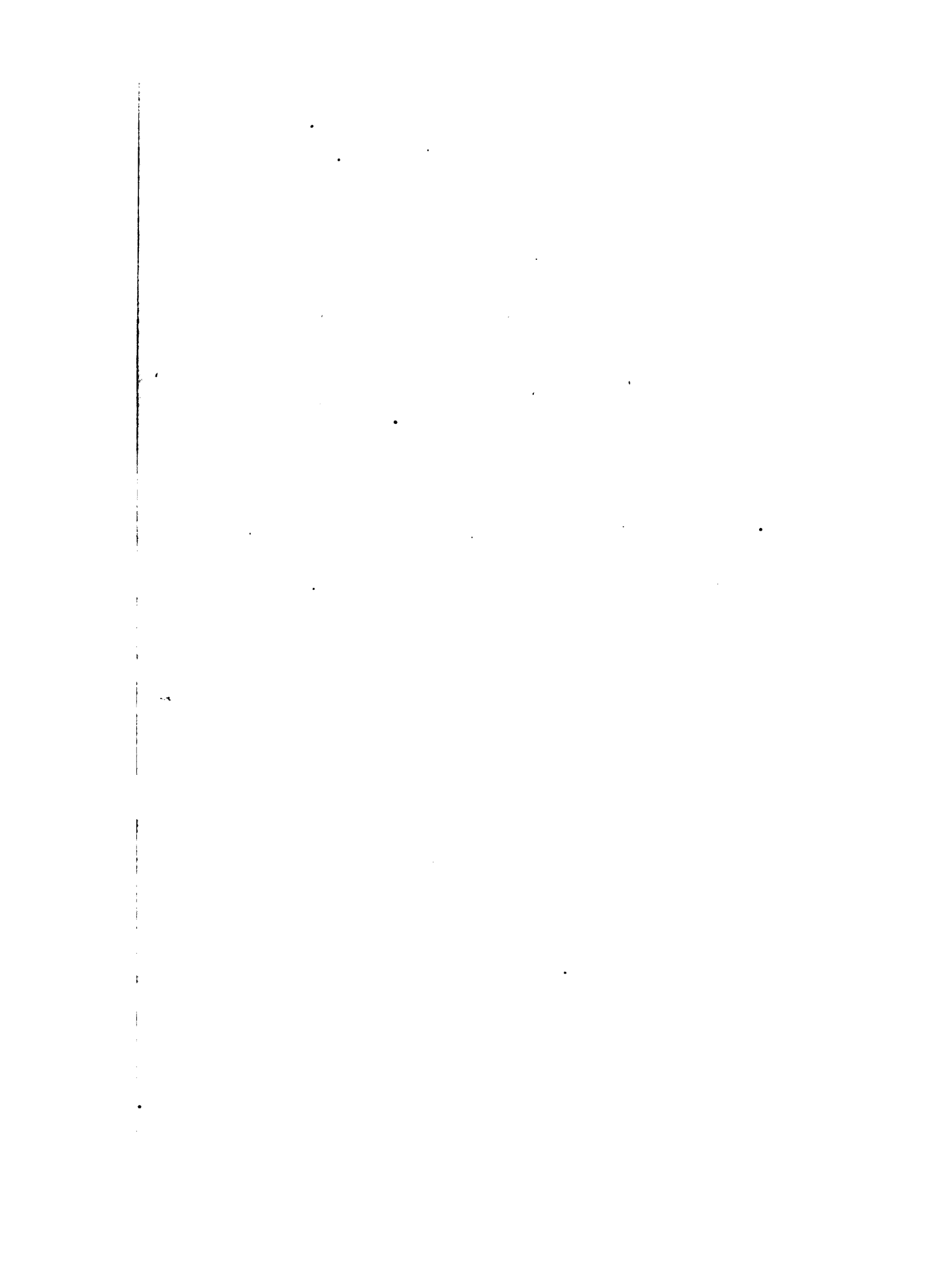

THE  
AMERICAN CYCLOPÆDIA:

A  
Popular Dictionary  
OF  
GENERAL KNOWLEDGE.

EDITED BY  
GEORGE RIPLEY AND CHARLES A. DANA.

VOLUME IX.  
HORTENSIUS—KINGLAKE.

NEW YORK:  
D. APPLETON AND COMPANY,  
549 AND 551 BROADWAY.  
LONDON: 16 LITTLE BRITAIN.  
1874.

~~RR 2160, 12~~  
64v 360

H. 222 1/3

1875, March 30.  
Bought with  
Bill. Henry.

ENTERED, according to Act of Congress, in the year 1860, by D. APPLETON AND COMPANY, in the Clerk's Office of the District Court of the United States for the Southern District of New York.

ENTERED, according to Act of Congress, in the year 1874, by D. APPLETON AND COMPANY, in the Office of the Librarian of Congress, at Washington.

*Among the Contributors to the Ninth Volume of the Revised Edition are the following :*

- Prof. CLEVELAND ABBE**, Washington, D. C.  
HURRICANE.
- WILLARD BARTLETT**.  
INDIA.  
INDIAN ARCHIPELAGO.  
KANGAR.  
KROKAN.
- Prof. C. W. BENNETT**, D. D., Syracuse University.  
HUNTINGDON, SELINA, Countess of.  
JAMES, EDMUND STONER.  
KIDDER, DANIEL PARISH.
- JULIUS BING**.  
ISMAIL PASHA, Khedive of Egypt.  
KAULBACH, WILHELM VON,  
and other articles in biography, geography, and history.
- FRANCIS C. BOWMAN**.  
HUMMEL, JOHANN NEPOMUK.  
JOSQUIN DES PRÉS.  
KELLOGG, CLARA LOUISA.
- T. S. BRADFORD**, U. S. Coast Survey, Washington, D. C.  
HYDROGRAPHY.
- EDWARD L. BURLINGAME**, Ph. D.  
JOANNA I. and II., Queens of Naples,  
JOHN, Archduke of Austria,  
KEFF, England,  
and other articles in biography, geography, and history.
- ROBERT CARTER**.  
HOTTENTOTS,  
HOUSTON, SAM,  
HUGHES, THOMAS,  
HUNA,  
JAY, JOHN,  
JAY, WILLIAM,  
and other articles in biography and history.
- JOHN D. CHAMPLIN, JR.**  
HOUGHTON, RICHARD MONCKTON MILNES, Lord,  
HUXLEY, THOMAS HENRY,  
IRON MASK, Man in the,  
JIDDAH,  
KIDD, WILLIAM,  
and other articles in biography, geography, and history.
- Prof. E. H. CLARKE**, M. D., Harvard University.  
HYPOPHOSPHITES,  
HYPOSULPHATES,  
IODINE,  
and other articles in materia medica.
- T. M. COAN**, M. D.  
KALAKAPA, DAVID.  
KAFAL.  
KILAUEA.
- Hon. T. M. COOLEY**, LL. D., Michigan University, Ann Arbor.  
HUSBAND AND WIFE,  
and other legal articles.
- Rev. S. S. CUTTING**, D. D., Rochester University, N. Y.  
JUDSON, ADONIRAM.  
JUDSON, ANN HASKELTIER.  
JUDSON, SARAH HALL.  
JUDSON, EMILY CHUBBECK.
- Prof. J. C. DALTON**, M. D.  
HYBRID,  
HYDROPHOBIA,  
HYGIENE,  
INOCULATION,  
and other medical and physiological articles.
- EATON S. DRONE**.  
ILLINOIS,  
INDIANA,  
IOWA,  
KANSAS,  
KENTUCKY,  
and other articles in American geography.
- Prof. THOMAS M. DROWN**, M. D., Lafayette College, Easton, Pa.  
IRON.
- ROBERT T. EDES**, M. D., Harvard University.  
Articles in materia medica.
- W. M. FERREISS**.  
HUGO, VICTOR MARIE.  
HUNTER, JOHN.  
KRAENT, PHILIP.
- Prof. W. E. GRIFFIS**, Imperial College, Tokio, Japan.  
JAPAN.  
KANAGAWA.
- ALFRED H. GUERNSEY**.  
JACKSON, THOMAS JONATHAN,  
JOHNSTON, JOSEPH EGGLESTON,  
and other articles in biography and history.
- J. W. HAWES**.  
HOUSTON, TEXAS,  
IDAHO,  
IDIOCY,  
INDIAN TERRITORY,  
JERSEY CITY,  
KANSAS CITY,  
KEY WEST,  
and other articles in American geography.
- Hon. CHARLES C. HAZEWELL**, Boston, Mass.  
JACKSON, ANDREW.
- M. HEILPRIN**.  
HUNGARY.
- J. C. HEPBURN**, M. D., LL. D., Yokohama, Japan.  
JAPAN, LANGUAGE OF.
- CHARLES L. HOGEROOM**, M. D.  
HUYGENS, CHRISTIAN.  
HYDRAULIC RAM.  
HYDROMECHANICS.  
HYDROMETER.  
INFLAMMATION.  
INSANITY.
- OLIVER WENDELL HOLMES**, M. D., Boston.  
JACKSON, CHARLES.  
JACKSON, JAMES, M. D.
- ROSSITER JOHNSON**.  
INGELOW, JEAN.  
IRVING, WASHINGTON,  
JOHNSON, ANDREW,  
and other articles in biography and geography.

- Prof. C. A. JOY, Ph. D., Columbia College,  
New York.  
INDIUM,  
and other chemical articles.
- Prof. S. KNEELAND, M. D., Mass. Inst. of  
Technology, Boston.  
HOUND,  
HUMMING BIRD,  
HYENA,  
HYDROIDS,  
ICHTHYOLOGY,  
ICHTHYOSAURUS,  
KING CRAB,  
KING FISH,  
and other articles in zoology.
- Rev. FRANKLIN NOBLE.  
HOWARD, OLIVER OTIS,  
HUDSON BAY,  
INDEPENDENTS,  
JACQUELINE OF BAVARIA,  
JOHN, King of Saxony,  
and other articles in biography.
- Rev. BERNARD O'REILLY, D. D.  
ICELAND,  
ICONOCLASTS,  
IMMACULATE CONCEPTION,  
INDULGENCE,  
INFALLIBILITY,  
JESUITS,  
and other articles in ecclesiastical history.
- Prof. S. F. PECKHAM, University of Minnesota,  
Minneapolis, Minn.  
KEROGENE.
- Count L. F. DE POURTALÈS, Museum of Com-  
parative Zoology, Cambridge, Mass.  
INDIAN OCEAN,  
JUAN FERNANDEZ.
- RICHARD A. PROCTOR, A. M., London.  
JUPITER.
- Prof. ROSSITER W. RAYMOND, Ph. D.  
IRON MANUFACTURE,  
IRON ORES.
- PHILIP RIPLEY.  
HUBBERT, WILLIAM HENRY,  
HUBBUT, STEPHEN AUGUSTUS,  
INDUSTRIAL EXHIBITIONS,  
KRELE, JOHN.
- W. E. ROGERS, Late Capt. Corps of Engineers,  
U. S. A.  
INFANTRY.
- ERNEST SATOW, Japanese Secretary H. B. M.  
Legation, Tokio, Japan.  
JAPAN, LITERATURE OF.
- JOHN SAVAGE.  
IRELAND.
- Prof. A. J. SCHEM.  
IRELAND, CHURCH OF,  
JANSENISTS, CORNELIUS,  
JANSENISTS,  
and articles in biography and history.
- J. G. SHEA, LL. D.  
Hurons,  
ILLINOIS (Indians),  
IROQUOIS,  
KANSAS,  
KEECHIEA,  
KICKAPOO.
- Prof. J. A. SPENCER, D. D., College of the  
City of New York.  
HOWSON, JOHN SAUL,  
HUDSON, HENRY NORMAN,  
HUNTINGTON, FREDERICK DAN,  
JOWETT, BENJAMIN,  
KATE, JOHN.
- N. L. THIEBLIN.  
INTERNATIONAL ASSOCIATION.
- Prof. GEORGE THURBER.  
HOTBED,  
HYACINTH,  
IMMORTELLES,  
INDIAN SHOT,  
INSECT FERTILIZATION,  
INSECTIVOROUS PLANTS,  
IVY,  
JUNIPER,  
KALMIA,  
and other botanical articles.
- Prof. G. A. F. VAN RIJN, Ph. D.  
INDIA, RACES AND LANGUAGES OF,  
INDIA, RELIGIONS AND RELIGIOUS LITERATURE OF,  
INDO-CHINESE RACES AND LANGUAGES,  
IRANIC RACES AND LANGUAGES,  
ITALIC RACES AND LANGUAGES,  
JAVA, LANGUAGE AND LITERATURE OF,  
and other archeological, oriental, and philologi-  
cal articles.
- I. DE VEITELLE.  
HUANCVELICA,  
HUANUCO,  
ITURBIDE, AGUSTIN DE,  
JAMAICA,  
JORULLO,  
JUAREZ, BENITO PABLO,  
and other Spanish American articles.
- C. S. WEYMAN.  
HUNGARY, WINES OF,  
ITALY, WINES OF.
- Gen. JAMES HARRISON WILSON.  
IRON-CLAD SHIPS.

THE  
AMERICAN CYCLOPÆDIA.

---

HORTENSIVS

**HORTENSIVS**, Quintus, a Roman orator, born in 114 B. C., died in 50. At the age of 19 he made a speech in the forum, and gained the applause of the orators Crassus and Scævola. He joined the side of Sulla in the civil war, and afterward was a constant supporter of the aristocratic party. When Cicero first came to the forum Hortensius was called the *rex iudiciorum*. Though professionally rivals, they seem to have lived on friendly terms; and in the beginning of the *De Claris Oratoribus*, Cicero pays an eloquent tribute to the memory of Hortensius. When obliged to leave the city on account of the impeachment of Clodius, however, Cicero was bitter against the supposed duplicity of Hortensius, and it was not till some time after his return that he was convinced of the injustice of his suspicion. In 81 Hortensius was made quæstor; in 75, ædile; in 72, prætor; and in 69, consul, with Q. Cecilius Metellus. The year before his consulship occurred the trial of Verres, in which the two rival orators were opposed. After his consulship, Hortensius took an active part against Pompey, opposing the Gabinian law, which gave Pompey the control of the Mediterranean sea, and the Manilian law, which transferred to his command the army against Mithridates. Cicero subsequently joined the same party, and we find them pleading often in common. They defended together C. Rabirius, L. Murena, and P. Sulla. Ten years before his death Hortensius withdrew from public life. He had acquired great wealth, and owned villas at Tusculum, Bauli, and Laurentum.

**HORTICULTURE**, the most perfect method of tilling the earth so as to produce the best results, whether the products are objects of utility or of beauty. It is difficult to define the line between horticulture and improved agriculture upon the one side, and landscape architecture upon the other. Horticulture or gardening has been pursued from the earliest

HORTICULTURE

times of civilization or national refinement. Among the Romans, according to Pliny, small gardens filled with roses, violets, and other sweet-scented flowers were in repute; while many of the choicest plants and flowers which we now cherish were cultivated by the ancient Greeks. Horticultural art declined, however, with the fall of Rome, and not until long after did it revive under the monastic institutions. A part of the policy of Charlemagne was the establishment of gardens by royal edict, prescribing the very plants which were to be grown. In the 16th century several botanic gardens were founded by Alfonso d'Este, duke of Ferrara, and in consequence many other noblemen had fine gardens of their own. The Venetians and Paduans followed the example, and in 1555 a garden founded at Pisa by Cosmo de' Medici had become so rich in plants as to excite admiration. The garden at Montpellier in France, founded by Henry IV., contained before the end of the 16th century upward of 1,300 French, Alpine, and Pyrenean plants. At this time the garden at Breslau in Germany, to which the celebrated botanist Fuchs was attached, was in existence; and in 1577, at the suggestion of Bontius, was founded the garden at Leyden. In England, pleasure gardens with fountains and shady walks, with hedges and designs, were known from the time of the conquest, but it was not until the construction of conservatories for the preservation of tender plants that horticulture made much progress. According to Loudon, it was not till 1717 that such structures were furnished with glass roofs, and from this time a new era in gardening began. The education and training of young persons to the practice of gardening raised the occupation to an art, and has brought horticulture in European countries especially to a high rank.—We have considered horticulture as the acme of agriculture; and those familiar only with ordinary farm tillage

would be surprised to find how productive land can be made when husbanded by practical gardening. In the best market gardens the soil, by abundant manuring and working, is kept up to the highest attainable state of fertility, and is made to produce always two, and frequently three and four crops in a year. It often happens that a single acre near a large city yields the cultivator a greater profit than many entire farms bring to their owners. Within the last 30 or 40 years horticulture in the United States has rapidly advanced, and its progress has been largely due to the influence of the various horticultural societies, especially those of Pennsylvania and Massachusetts. In this country there are very few magnificent gardens; but in the diffusion of a knowledge of horticulture among the people at large there has been a steady advance, and a special literature pertaining to the science and practice of horticulture has sprung up. The large works of other countries upon the general subject are superior to any yet published here, but our works upon separate topics are more thorough and practical than those of any European country. Among the earlier horticultural works published in this country is "The American Gardener," by William Cobbett (New York, 1819). "The American Gardener's Calendar," by B. McMahon (Philadelphia, 1819), is one of the few works embracing every department of horticulture. In landscape gardening the leading authors are A. J. Downing, Copeland, Weidenmann, and Scott; in arboriculture, Warder, Hoopes, and Bryant; in flower gardening, including roses, Breck, Buist, Rand, Parkman, and Parsons. In floriculture under glass, "Practical Horticulture," by Peter Henderson (New York, 1868), is the only recent work. Among works on vegetable gardening, the most prominent are Burr's "Vegetables of America," White's "Gardening for the South," Quinn's "Money in the Garden," and Henderson's "Gardening for Profit." The leading agricultural journals have each a horticultural department with a competent editor, and there are now only three journals devoted solely to horticulture; these are: "The Horticulturist" (New York), established by A. J. Downing in 1846, and now (1874) edited by H. T. Williams; "The Gardener's Monthly" (Philadelphia, 1859), Thomas Meehan, editor; and "The California Horticulturist" (San Francisco, 1871), C. Stephens, editor.

**HORTUS SICCUS.** See HERBARIUM.

**HORUS,** a god of the Egyptians, son of Osiris and Isis. He represented the rising sun. He pierces with a spear the serpent Apophis or Apap, the vapors of dawn. He avenges his father Osiris, whom Set or Soutekh, also called Baal, kills, and whom the prayers of Isis resuscitate. The death of Osiris, the grief of Isis, and the final defeat of Set, the god of evil, are common themes in oriental mythologies, and recur in the stories of Cybele and Atys, and of Venus and Adonis. The youthful

Horus was held forth as a model for all princes, and as a type of royal virtues. He was often represented as a little child, sometimes in the lap of Isis, and always with a finger on his mouth, which is the common Egyptian sign indicative of extreme youth or infancy. The Greeks identified Horus with their god Harpocrates, whom they represented also with a finger on the lips; but mistaking the significance of the sign, they regarded it as a symbol of silence, secrecy, and mystery, and ascribed these attributes to the deity. He became accordingly a favorite subject for speculation with the later philosophers. His worship was also carried into Rome, where, probably on account of excesses committed in the mysterious rituals, it was for a while forbidden. The peach was considered the sacred fruit of the god. The Egyptians also believed that Horus held in conjunction with Anubis the balance in which the hearts of the dead are weighed before Osiris and the 42 assessors, and that he or Smon beheaded those found wanting on the *nemna* or infernal scaffold.

**HORVÁTH, Mihály,** a Hungarian historian, born at Szentes, Oct. 20, 1809. He was ordained as priest in 1830, and became in 1844 professor of the Hungarian language and literature in the Theresianum at Vienna. In 1848, during the Hungarian revolution, he was made bishop of Csanád, and *ex officio* a member of the upper house in the diet; and in 1849 he was minister of public worship and education. The Hungarian uprising having been overthrown, he took refuge first in France, and afterward in Belgium, Switzerland, and Italy, where for several years he prosecuted his studies in Hungarian history. In the mean while the Austrian government sentenced him to death in his absence. In 1866 he was permitted to return to his native country, and in 1869 he was unanimously elected member of the diet for Szegedin. His works on Hungarian history, in Hungarian, include "Hungarian History" (4 vols., Pápa, 1842-'6; abridged in 1 vol., Pesth, 1847; enlarged in 6 vols., 1859-'68; German translation, 2d ed., 1861); "Twenty-five Years of Hungarian History" (2 vols., Geneva, 1863; German translation, Leipsic, 1866); "History of the War of Independence in Hungary" (3 vols., Geneva, 1865); and "Reply to the Letters of Kossuth," a pamphlet setting forth the great importance for Hungary of the compromise with Austria in 1867. He has also published a collection of Hungarian historical documents in 4 vols.

**HOSACK, David,** an American physician, born in New York, Aug. 31, 1769, died Dec. 23, 1835. He studied in Columbia college from 1786 to 1788, thence went to Princeton college, where he graduated in 1789, and received his degree as doctor of medicine in Philadelphia in 1791. He subsequently continued his medical studies in London and Edinburgh; and on his return home in 1794 brought with him a cabinet of minerals obtained from Wer-

ner, and a collection of duplicate specimens of plants from the herbarium of Linnæus. This collection of dried plants gathered by Linnæus now constitutes a part of the museum of the lyceum of natural history of New York. In 1795 he was appointed professor of botany in Columbia college, and in 1797 of materia medica. In 1807 he became professor of materia medica and of midwifery in the newly created college of physicians and surgeons, and in 1811 of the theory and practice of physic and clinical medicine, to which were afterward added obstetrics and the diseases of women and children. He retained his post after the union of the two rival medical faculties of Columbia college and the college of physicians and surgeons in September, 1813. Resigning with the rest of the faculty in 1826, he aided in organizing the Rutgers medical school, which ceased in 1830. Dr. Hosack held several public medical offices, and was prominent in the promotion and management of municipal institutions. He founded in 1810, with Dr. Francis, the "American Medical and Philosophical Register," and was a fellow of the royal societies of London and Edinburgh. Among his works are: "A Biographical Memoir of Hugh Williamson, M. D., LL. D." (8vo, 1820); "Essays on Various Subjects of Medical Science" (3 vols., 1824-'30); "System of Practical Nosology" (1829); "Memoirs of De Witt Clinton" (4to, 1829); "Lectures on the Theory and Practice of Physic," edited by the Rev. H. W. Ducachet, M. D. (1838).

**HOSANNA** (Heb. *hoshi'ah na*, Save, we pray), in Jewish antiquity, a form of acclamation on joyous and triumphal occasions. At the feast of tabernacles it was customary to sing Ps. cxviii. 25, which contains the words *hoshi'ah na*, while the people carried green boughs of palm and myrtle and branches of willow. Hence the prayers were called hosanna, and the seventh day of the feast the great hosanna. The term was employed as a salutation to Christ on his public entry into Jerusalem.

**HONAI**, the first of the minor prophets. He was the son of Beeri, commenced his prophecy about 785 B. C., and exercised his office at intervals for about 60 years. He was a resident of the kingdom of Israel, against which most of his prophecies are directed, rebuking and threatening the people for their sins, and exhorting them to repentance. His style is concise, sententious, and abrupt; and his prophecies are in one continued series, without any distinction as to the times when they were delivered or their subjects.

**HOSMER, Harriet C.**, an American sculptor, born in Watertown, Mass., Oct. 9, 1830. She studied sculpture in the studio of Mr. Stevenson in Boston, also with her father, a physician, and in the medical college of St. Louis. In the summer of 1851 she commenced her first original work, a bust of Hesper. Late in 1852 she went to Rome, entered the studio of Gibson, and passed her first winter in modelling

from the antique. Her busts of Daphne and Medusa were her first attempts at original design in Rome, and were followed by a statue of Cenone. For the public library of St. Louis she also executed her "Beatrice Cenci." In 1855 she modelled a statue of Pluck, the popularity of which procured her orders for nearly 30 copies. In 1859 she finished a colossal statue of "Zenobia in Chains." This was followed by a statue of Thomas H. Benton in bronze for Lafayette park, St. Louis, and a "Sleeping Faun." She still resides in Rome (1874).

**HOSPITAL** (Lat. *hospitalia*, apartments for guests), an institution for the reception and relief of the sick, wounded, or infirm. The word has undergone great changes of signification. The earliest known hospital for the sick was founded in the latter part of the 4th century at Cæsarea; St. Chrysostom built one at his own expense in Constantinople; and Fabiola, the friend of St. Jerome, founded one at Rome. The Hôtel-Dieu in Paris, founded in the 7th century, has long been the largest and finest hospital in the world. It was rebuilt in the 12th century, and has been extended from time to time until now it covers five acres. The Hôtel-Dieu of Lyons, said to have been founded by Childebert in the 6th century, almost equals it. Rome had 24 hospitals in the 9th century; and in the 11th they began to be established for pilgrims in the Holy Land. Archbishop Lanfranc built a hospital at Canterbury in 1070. The oldest hospitals in London are St. Bartholomew's, which dates from 1546; Bethlehem, 1547; and St. Thomas's, 1553. In all civilized countries every considerable city now has one or more hospitals, sustained by charity, endowment, or government grants. Frequently they are connected with medical schools, for mutual advantage. Many have elaborate and costly buildings; but the latest theories are not in favor of permanent structures, which are believed to harbor the germs of disease. Military field hospitals, first known in the 6th century, have now, in connection with the ambulance system (see **AMBULANCE**), been made highly efficient. A yellow flag is the sign of a hospital.

**HOSPITALLERS.** See **SAINT JOHN OF JERUSALEM, KNIGHTS OF.**

**HOTBED**, in gardening, a bed of earth enclosed by a frame, which is covered by movable sashes, and heated from below by means of fermenting vegetable matter. In large establishments the hotbed is replaced by a glass structure heated by flues or by hot-water pipes. (See **GREENHOUSE**.) When vegetables are made to grow out of their proper season, they are said to be forced; large quantities of lettuce, radishes, &c., are forced for market in hotbeds during the winter months. The most general use of the hotbed is in starting such seeds as would germinate very slowly, if at all, in the open ground, and to forward plants for an early crop of those kinds that are later sown in the open air; by the use of the hotbed, plants six





THE  
AMERICAN CYCLOPÆDIA.

---

VOL. IX.  
HORTENSIUS—KINGLAKE.

of the Hermitage which her sister-in-law Mme. d'Épinay had fitted up for Rousseau, she renewed her acquaintance with the latter, whom she had previously met in her relative's house in Paris. He fell in love with her, and idealized her in his *Julia, ou la nouvelle Héloïse*, describing the vicissitudes of his passion and of his relation with her in his *Confessions*; but the countess protested against his exaggerations, and according to Rousseau's account as well as her own she remained faithful to her lover Saint-Lambert, although she felt much flattered by Rousseau's admiration. She had fine hair, but was far from handsome. When Saint-Lambert became idiotic in his old age she nursed him. Her husband, who died some 10 years before her lover, never lost his regard for her. Her son became a lieutenant general, and his three sons acquired eminence respectively in civil and military life and in literature.

**HOUDIN, Robert**, a French conjurer, born in Blois, Dec. 6, 1803, died there in June, 1871. His father, a watchmaker, gave him a good education at the college of Orleans, and at 18 years of age placed him in a lawyer's office; but having an extraordinary taste for mechanics, his father consented that he should learn watchmaking. While engaged in this occupation, the perusal of works on natural magic and a friendship formed with a travelling conjurer inspired him with an inclination for juggling. Having married, he went to Paris and engaged in his trade. He employed himself for a year in reconstructing a complicated machine, and so overstrained his mind as to lose all mental power for five years. After recovering he devoted himself for some time to making mechanical toys and automata, and at the Paris exhibition of 1844 obtained a medal for several curious figures of this kind. In 1845 he opened a series of exhibitions in juggling which became famous throughout Europe, and in 1848 he performed with great success in England. In 1855, at the great Paris exhibition, he gained the gold medal for his scientific application of electricity to clocks, and shortly after relinquished his exhibition to his brother-in-law Hamilton, retiring with a fortune to Blois. In 1856 the French government, finding that the Arabs in Algeria were frequently stirred up to rebellion by the pretended miracles of their marabouts or priests, invited Houdin to visit that colony, and if possible excel the magicians in their own tricks. He completely succeeded, passing through several very singular adventures while so doing. In 1857 he published *Robert Houdin, sa vie, ses œuvres, son théâtre*, and in 1859 his *Confidences*, which has been translated into English (Philadelphia, 1859). In 1861 he published *Les tricheries des Grecs dévoilées*, exposing the cheats of gamblers.

**HOUDON, Jean Antoine**, a French sculptor, born in Versailles, March 20, 1741, died in Paris, July 13, 1828. Having gained the first prize for sculpture in the royal academy at Pa-

ris, he passed ten years in Rome, and finished, among other works, the statue of St. Bruno in the church of Sta. Maria degli Angeli. Returning to Paris, he executed during the next 15 years admirable busts of Rousseau, Diderot, D'Alembert, Gluck, Turgot, Franklin, Mirabeau, and many other distinguished men; statues of Voltaire and Tourville; the "Diana" for the empress of Russia; the "Shivering Woman," and other works, which placed him in the first rank of French sculptors, and procured his admission to the academy. He made at this time the statue of a muscular skeleton of the human body, which he afterward reproduced in smaller size, and which has been often copied and used for the artistic study of anatomy. In 1785 he accompanied Franklin to the United States, to prepare the model for the statue of Washington ordered by the state of Virginia, and passed two weeks at Mount Vernon for that purpose. The statue, bearing the sculptor's legend, *Fait par Houdon, citoyen français*, 1788, in the hall of the capitol at Richmond, according to the testimony of Lafayette and other personal friends of Washington, is the best representation of him ever made. Among his later works were busts of Napoleon and Josephine and other celebrities of the first empire, and the statue of Cicero in the Luxembourg palace.

**HOUGHTON**, a N. W. county of the upper peninsula of Michigan, bounded N. W. by Lake Superior, indented on the N. E. by Keweenaw bay, and drained by Sturgeon river and other streams; area, about 2,000 sq. m.; pop. in 1870, 13,879. The surface is uneven and rocky, the N. W. portion consisting of the upper half of Keweenaw point, a peninsula lying between Lake Superior and Keweenaw bay, through which runs the Mineral range, and which contains Torch lake and Portage lake, discharging into the bay. Silver and iron ore are found, but the great wealth of the county is in its copper mines, which are situated in the Mineral range near Portage lake, the most productive being the Calumet and Hecla mine on the N. border. According to the census of 1870, there were 11 copper mines, employing 2,961 hands, and producing \$3,231,888 worth of ore. The product of 1872 was 12,602 tons (four fifths of the product of the Lake Superior region), of which the Calumet and Hecla mine yielded 9,800 tons. The ore is in a nearly pure state. The chief productions in 1870 were 8,595 bushels of oats, 22,040 of potatoes, and 703 tons of hay. There were 3 manufactories of clothing, 2 of iron castings, 1 of machinery, 1 of soap and candles, 12 of copper (milled and smelted), 4 of tin, copper, and sheet-iron ware, 4 breweries, 2 planing mills, and 5 saw mills. Capital, Houghton.

**HOUGHTON, Richard Newkton Mimes**, lord, an English author, born in Yorkshire, June 19, 1809. He graduated at Trinity college, Cambridge, in 1831, entered parliament as member for Pontefract in 1837, and represented that

constituency till Aug. 20, 1868, when he was raised to the peerage as Baron Houghton. He began his political life as a conservative, but soon allied himself with the liberals. In the house of commons he advocated popular education, religious equality, and measures for the reformation of criminals, and proved himself a warm friend of Italy in its struggles for unity and freedom. In early life he travelled much in southern Europe and in the East, and he has published several volumes of travels and a number of poems, some of the latter descriptive of oriental life and scenery. His works are: "Memorials of a Tour in Greece" (1833); "Memorials of a Residence on the Continent, and Historical Poems," and "Poetical Works" (1838); "Poetry for the People, and other Poems" (1840); "Memorials of Many Scenes: Poems" (1843); "Palm Leaves: Eastern Poems," "Poems Legendary and Historical," and "Poems of Many Years" (1844); "Good Night and Good Morning" (1859); "Monographs, Personal and Social" (1873); and "Poetical Works" (1874). He edited the letters and literary remains of John Keats, with a memoir (1848), has published many pamphlets and speeches on political topics, including "Thoughts on Party Politics," "Real Union of England and Ireland," and "Events of 1848, especially in their relation to Great Britain," and has contributed articles to the "Westminster Review" and other periodicals.

**HOUGHTON, William**, an English clergyman, born in Norwich in 1807. He graduated at Highbury college, London, in 1832, and in 1838 became minister of the Congregational church at Windsor. In 1844 he succeeded Dr. Robert Vaughan as minister of the Congregational society at Kensington, and in 1855 was elected chairman of the Congregational union of England and Wales, and delivered the "Congregational lecture," his subject being "The Ages of Christendom." Dr. Houghton has travelled extensively in the East, and has written many books, the most important of which is "The Ecclesiastical History of England" (4 vols., London, 1870). Among his other works is "Country Walks of a Naturalist with his Children" (1849). He represented the English Independents at the meeting of the evangelical alliance held in New York in 1873.

**HOUND** (*canis sagax*), the name of several varieties of large and powerful dogs hunting by scent, and trained to pursue the stag, the fox, the hare, and other animals, and even man. The progenitors of the hound races were probably, according to Hamilton Smith, the jungle koola (*lyciaeus tigris*, H. Smith) and the *loansuah* (*canis primævus*, Hodg.), both of the warmer parts of Asia. (See Dog.) These were domesticated after the more wolf-like varieties, and display in all the breeds a tendency to the three colors of white, black, and tan, characterizing them in their wild state. The cranium has a larger cerebral cavity than in less sagacious dogs, with a more convex fore-

head, wider space between the eyes for the organ of smell, and broader jaws; most varieties have also a wide nose, full and prominent eyes, large hanging ears, a raised and truncated tail, and often a spurious toe on the hind feet. There are two races, the one with short hair, the hounds proper, and the other with long hair, like the setter and spaniel, and used as gun and water dogs; the pointer seems to occupy an intermediate place between them. The faculties which make the hounds so useful in hunting must have existed in the original species, and have been cultivated in regard to special game according to the fancy of man; the blood, stag, and fox hounds have no intuitive tendency to pursue respectively man, the deer, and the fox, and these only, but have been trained with great care to hunt a single game. The most ancient form of hound figured upon the Egyptian monuments resembles much the bloodhound, which was formerly so much esteemed for its sagacity, strength, and olfactory acuteness. The bloodhound, once employed to trace felons, enemies, and fugitives, or to bring the huntsman to the retreat of a wounded animal, has been fully described under that title; it is now kept in civilized countries rather for show than use. The stag hound is but little smaller than the bloodhound, and like it is slow, sure, and steady; in fact it is a mongrel bloodhound, the cross being either some greyhound or swift fox hound; it has a large, rather short and sharp head, long hanging ears, muscular limbs, small feet, and tail carried high; the color is always more or less white with fulvous markings. Stag hunting, as performed in the fatiguing and cruel manner of the 17th and 18th centuries, is now rare, and this form of hound has become nearly if not entirely extinct. The fox hound of the present day is a perfect model of

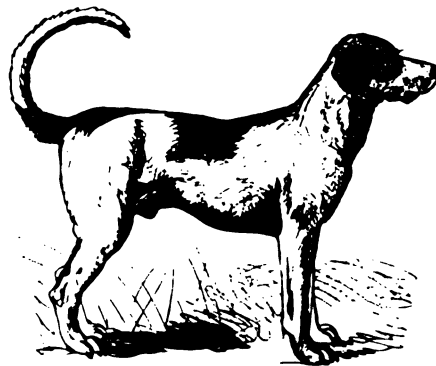

English Fox Hound.

a hunting dog, and is a carefully bred cross between the bloodhound and the greyhound, probably with the intermixture of the southern English and perhaps other hounds; exactly how it has attained its present character it is impossible to determine. It is lower at the shoulders

and more slenderly built than the stag hound, with shorter hair, and the color is white, with larger clouds of black and tan, one on each side of the head, covering the ears, another on each flank, and a third at the root of the tail. Its speed is such that none but a thoroughbred hunter can keep up with it, and its endurance so great that a pack has been known to run for ten hours, tiring out three changes of horses, and severely testing the strength of the sportsmen. Breeders differ as to the best size for fox hounds, but from 22 to 24 in. high at the shoulder is generally considered the most advantageous. The best food is thought to be oatmeal and well boiled horse flesh, attention being paid to their constitution, the season of the year, and amount of work to be done. The cry of a pack of hounds, once so cheering and melodious, has lost much of its romantic interest from the change man has effected in the character of these animals; the other good points of a hound, such as pureness of stock, beauty of form, speed, endurance, and acuteness of smell, are more highly prized in a pack than harmonious voices. The average value of an established pack of fox hounds may be set down at about £1,000, though some have been sold for more than twice that sum; single hounds are often sold as high as 100 guineas. (See BEAGLE, BLOOD-HOUND, DOG, GREYHOUND, and HARRIER.)

**HOUNSLOW**, a town of Middlesex, England, 10 m. W. S. W. of London; pop. in 1871, 9,994. It consists of a single street, which stretches along the Great Western road from London. On Hounslow heath, which previous to the present century was frequently the scene of highway robberies, now stand gunpowder mills.

**HOUR** (Gr. *ώρα*; Lat. *hora*), a measure of time equal to  $\frac{1}{24}$  of a mean solar day, or this proportion of the period between sunrise and sunset at the time of the equinoxes. Thus applied, it becomes a definite measure; but as employed by the ancients to designate  $\frac{1}{24}$  of the natural day, it was an indefinite period, varying with the times of rising and setting of the sun, times which continually changed with the season, and between increasing extremes as the observations were made in higher and higher latitudes. Even in the latitude of Rome, the length of the hour on June 25 was about  $\frac{1}{14}$  part of 15 hours 6 minutes, as now reckoned, and on December 23 it was only  $\frac{1}{14}$  part of 8 hours 54 minutes. At the two equinoxes only would the hour agree with its present measure. Hours thus divided were known as "temporary hours," in reference to their constant change of length. When the day was thus first divided is unknown. Herodotus states that the Greeks obtained the practice from the Babylonians. Wilkinson, however, says that "there is reason to believe that the day and night were divided, each into 12 hours, by the Egyptians, some centuries before that idea could have been imparted to the Greeks from Babylon." The division of the night as well as the day into 12 equal parts was

not practised by the Romans until the time of the Punic wars, and the use of equinoctial hours was not adopted till toward the end of the 4th century of our era; the first calendar known to have been made after this system is the *Calendarium Rusticum Farnesianum*. Hours are now reckoned in common practice in two series of 12 each, from midnight to midday, and from this to midnight, which corresponds to the supposed divisions of the ancient Egyptians. Astronomers count 24 hours from one midday to the next; and the Italians 24 hours from one sunset to the next, changing the commencement of the day with the season. The Chinese divide the day into 12 hours, one of their hours being equal to two of ours. They reckon from an hour (of our time) before midnight. In the use of clocks in the 11th century it was the duty of the sacristans of the churches to regulate the *horologia* each morning.

**HOUR CIRCLES**, or **Hourly Circles**, great circles of the sphere, passing through the poles, and consequently perpendicular to the equator. They are meridians at every  $\frac{1}{24}$  part of the circumference, their planes thus making angles of 15° with each other.

**HOURIS**, the black-eyed damsels of the Mohammedan paradise, formed of pure musk, and made by a peculiar creation perpetual virgins. They dwell in green gardens and pearl pavilions, among lotus and acacia trees, with fruits in abundance, near flowing streams, reposing on lofty couches adorned with gold and precious stones. Some of the pavilions which they occupy are 60 miles square. The very meanest of the faithful will have 72 houris, besides the wives which he married when living. They join in concert with the angel Israfil, the most melodious of God's creatures, and the branches of the trees give an *Æolian* accompaniment. They may, if they desire, have children, which within an hour shall be conceived, born, and grow to maturity. Algazali regards the descriptions of the houris in the Koran as allegorical, and designed to convey an impression of the spiritual beatitude of the saints; and the orientalist Hyde affirms that an enlightened belief prevails among the wiser Mohammedans.

**HOURS**, in mythology. See **HORA**.

**HOUSATONIC**, a river of New England, which rises in Berkshire co., Mass., flows into Connecticut, winds through Litchfield co., forms a part of the boundary between New Haven co. and Fairfield co., and falls into Long Island sound below Milford. Its entire length is about 150 m. Its scenery in general is very picturesque, and on its banks are numerous large mills. The Housatonic railroad follows its course for about 75 m.

**HOUSELEEK** (*sempervivum*, Linn.), a genus of plants of the natural order *crassulacea*, having thick succulent stems and leaves, the former frequently short, with the leaves so closely crowded upon them as to form a dense rosette,

l ornamental flowers, either yellow or red. e houseleeks are found in the mountains of thern and central Europe, the Canaries, l various parts of Asia and Africa. The mon houseleek (*S. tectorum*, Linn.) has y thick, succulent leaves, disposed about a



Common Houseleek (*Sempervivum tectorum*).

ort stem in a circular manner. It will grow the most scanty soils and where it is exposed drought, patches of it several feet in circumference thriving for years upon the exposed faces of rocks that are partially shaded. In rope it is very common upon the thatched of houses; it was formerly supposed to ve as a protection from lightning, and in

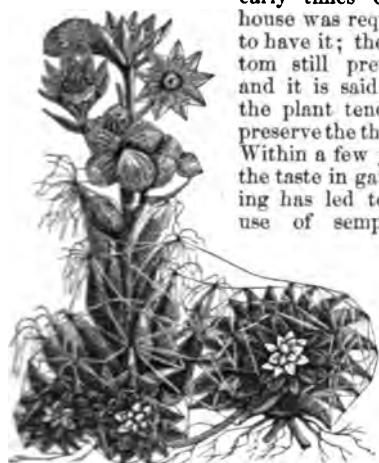

Cobweb Houseleek (*Sempervivum arachnoideum*).

ns and other succulents for forming beds a mosaic of living plants. The neat com- t habit of the houseleeks and the related yledons, echeverias, &c., as well as the va- ry in color presented by the leaves, espe-

cially adapt them to this purpose; and these plants, which were formerly kept as single specimens by the curious, are now raised by the florists in large quantities for ornamental planting. One of the most valued for this purpose is *S. calcareum* from the Alps (incorrectly *S. Californicum* of florists), and several others are employed. A very striking and interesting little species is the cobweb houseleek (*S. arachnoideum*), also an alpine species; its rosettes, about an inch across, grow close together in large clumps; the tiny leaves are connected by a fine down which passes from tip to tip, making the plant look as if an industrious spider had spun its web over it. Where sparrows abound the plant cannot be grown in perfection, as these birds rob it of the web to use in their nests. The tree houseleek (*S. arboreum*), from the Canaries, has a branching stem 3 ft. or more high, each branch terminated by a handsome rosette



Tree Houseleek (*Sempervivum arboreum*).

of green leaves, or in the varieties yellow margined or purple. It is a greenhouse plant, and was formerly common as a window plant. —The houseleeks are not remarkable for useful qualities. The fresh leaves of the *ensdo* of Madeira (*S. glutinosum*, Aiton) are used by the fishermen to rub upon their nets, to preserve them. Malic acid combined with lime exists in *S. tectorum*. Its juices are considered cooling, and its bruised leaves are used in domestic practice as applications to burns, ulcers, and inflammation, and from them also a simple and cooling salve is prepared.

**HOUSSA**, or **Hausa**, a country of central Africa, bounded N. by the Sahara, E. by Bornoo, S. by Nufi, and W. by the Quorra. The people are negroes, and the Foolahs or Fellatahs are the ruling race. Barth found the country divided into 10 provinces. Kano, in the province of the same name, is the principal city in point of commerce, and has about 30,000 inhabitants; it is in lat. 12° 0' 19" N. and

lon. 8° 40' E. Katagum, E. by N. of Kano, has from 7,000 to 8,000 inhabitants. Sackatoo, in the N. W. part of the country, has upward of 20,000 inhabitants, and has one of the best supplied markets in central Africa. Wurno, 15 m. N. E. of Sackatoo, on the river Rima, is a new town founded in 1831; its population is about 12,000. Zaria, the capital of the province of Zegzeg, is in lat. 10° 59' N. and lon. 8° E.; it is surrounded by a beautiful and highly cultivated country, and its population is estimated at 50,000. Houssa is well watered, being traversed by the rivers Sackatoo, Mariadi, Zirmie, Bugra, Zoma, and other tributaries of the Niger. It is considerably elevated above the sea, and its climate is consequently cooler and more healthy than that of the other countries of central Africa. The land is well cultivated, the principal crop being Indian corn, of which two harvests are annually produced. Cotton is largely raised, and Kano is famous throughout central Africa for its dyed cloths. Tobacco, indigo, rice, and various kinds of grain and fruits are diligently cultivated. At Sackatoo there are extensive manufactures of leather, iron, and cotton cloths; and an active commerce is carried on in all the cities by means of open markets, which are frequented by traders from the neighboring countries and from remote parts of the continent. The people of Houssa are mostly Mohammedans. They have attained to some degree of civilization, have a written language, and have historical records reaching back to the 13th century of our era. They were converted to Mohammedanism in the 16th century, and were conquered by the Foolaahs in 1807, when Katsena, then their principal city, surrendered after a desperate defence of seven years.

**HOUSSAYE.** I. Arsène, a French author, born at Bruyères, near Laon, March 28, 1815. While young he went to Paris, where his two novels, *La couronne de bluets* and *La pêcheuse*, appeared in 1836. The friendship of Jules Janin and Théophile Gautier, and his association in work with Jules Sandeau, aided to establish him in the literary world. From 1844 to 1849 he was editor of *L'Artiste*, and his *Histoire de la peinture flamande et hollandaise* (fol., 1846) was aided by a subscription of 50,000 francs from the government. This work was received with popular favor, although charged with plagiarism. At the revolution of 1848 he was thrown into political prominence, and was an unsuccessful candidate for the assembly. He was manager of the Théâtre Français from 1840 to 1856, and he became one of the most notorious courtiers of the second empire. In 1861 he became one of the proprietors and the managing editor of *La Presse*. His numerous writings include poetry, plays, essays, and popular sketches of celebrated and fashionable women. Among them are *Nos grandes dames* (4 vols., 1868), *Les Parisiennes* (4 vols., 1869-'70), and *Mademoiselle Cléopâtre* (new ed., 1874). II. Henry, a French author, son of the prece-

ding, born in Paris, Feb. 24, 1848. He became known in 1867 by his *Histoire d'Apollon*, and his subsequent works include *Histoire d'Alcibiade et de la république athénienne depuis la mort de Périclès jusqu'à l'avènement des trente tyrans* (2 vols., Paris, 1874).

**HOUSTON.** I. A central county of Georgia, bounded E. by the Ocmulgee river, which is navigable by steamboats, and drained by several of its affluents; area, 875 sq. m.; pop. in 1870, 20,406, of whom 15,332 were colored. The surface is undulating, and the soil, of limestone formation, is very fertile. The Southwestern railroad passes through the county. The chief productions in 1870 were 3,536 bushels of wheat, 363,895 of Indian corn, 40,107 of sweet potatoes, and 3,819 bales of cotton. There were 834 horses, 2,730 mules and asses, 1,502 milch cows, 3,890 other cattle, and 10,963 swine; 1 manufactory of agricultural implements, 3 of carriages, 1 of cotton goods, 1 flour mill, and 7 saw mills. Capital, Perry. II. A S. E. county of Texas, bounded E. by Neches river, and W. by Trinity river, both navigable; area, 1,090 sq. m.; pop. in 1870, 8,147, of whom 3,542 were colored. It has a highly fertile soil, and a rolling surface diversified in some places with hills, and well timbered with oak, pine, ash, hickory, black walnut, &c. The Houston and Great Northern railroad traverses it. The chief productions in 1870 were 33,163 bushels of Indian corn, 5,779 of sweet potatoes, and 920 bales of cotton. There were 297 horses, 2,684 cattle, and 3,171 swine. Capital, Crockett. III. A N. W. county of Tennessee, formed since the census of 1870, bounded W. by the Tennessee and N. E. by Cumberland river; area, about 350 sq. m. The surface is undulating and the soil fertile. The Louisville and Nashville and Great Southern railroad passes through the N. part. The assessed value of property in 1871 was \$344,775. Capital, Erin. IV. A S. E. county of Minnesota, separated on the E. from Wisconsin by the Mississippi, bordering on Iowa on the S., and intersected by Root river; area, about 575 sq. m.; pop. in 1870, 14,936. The surface is undulating and mostly wooded, only about a fifth being occupied by prairie. The soil, resting on magnesian limestone, is very fertile. The Southern Minnesota and the Chicago, Dubuque, and Minnesota railroads intersect it. The chief productions in 1870 were 623,557 bushels of wheat, 249,761 of Indian corn, 227,688 of oats, 81,182 of barley, 32,065 of potatoes, 27,560 lbs. of hops, 14,286 of wool, 229,183 of butter, and 14,776 tons of hay. There were 2,917 horses, 3,614 milch cows, 4,536 other cattle, 4,697 sheep, and 6,305 swine; 1 car factory, 6 flour mills, and 2 saw mills. Capital, Caledonia.

**HOUSTON,** a city and the capital of Harris co., Texas, the second city in the state in population and importance, situated at the head of tide water on Buffalo bayou, 45 m. above its mouth in Galveston bay, 46 N. W. of Galves-

ton, and 150 m. E. S. E. of Austin; pop. in 1860, 4,845; in 1870, 9,882, of whom 3,691 were colored; in 1874, estimated by the local authorities at 20,000. It is built on the left bank of the bayou, which is spanned by several bridges, the principal ones being of iron, and embraces an area of 9 sq. m. The city hall and market house of brick, just finished at a cost of \$400,000, is 272 ft. long by 146 ft. wide, and has two towers, 14 by 21 ft. and 114 ft. high. It contains a hall, 70 by 110 ft., fitted up for public entertainments and capable of seating 1,300 persons. The masonic temple is a handsome structure costing \$200,000. The principal hotel, the largest in the state, has accommodations for 500 guests. The city is lighted with gas, and is easily drained. The construction of street railroads and grading of streets are in progress. Houston is the centre

of the railroad system of the state, and attracts the trade of the surrounding country, which is rich in grazing and agricultural products. There are six diverging lines: the Houston and Texas Central; the Houston and Great Northern and International; Houston Tap and Brazoria; Galveston, Houston, and Henderson; New Orleans and Texas; and Buffalo Bayou, Brazos, and Colorado. The bayou opposite the city has a depth of 5 ft., but owing to bars in Galveston bay vessels drawing more than 4 ft. cannot reach this point. Improvements are in progress by the United States government and an incorporated company, which will render Houston accessible by vessels drawing 9 ft. The navigation of the bayou is mainly controlled by the Houston direct navigation company, which has a capital of \$300,000, and owns 6 steamers, 4 tugs, and 24 barges. The



Market and Opera House, Houston.

whole number of vessels regularly engaged in the trade of the bayou in 1872 was 71, viz.: steamers, 10; tugs, 6; barges, 30; schooners, mostly employed in the lumber trade with the Sabine, Louisiana, and Florida coasts, 25. An extensive lumber trade is also carried on by flatboats with the bayous emptying into Buffalo bayou and San Jacinto river. The principal business, however, is manufacturing, in which Houston surpasses all other places in the state. The chief establishments, besides the extensive machine shops of the railroads, are 2 cotton factories, 4 iron and brass foundries, 3 car factories, 4 planing mills and wood works, 5 manufacturing of furniture, 2 of soap, 1 of cement pipe, 1 of bone dust, 5 sheet-iron and tin works, 2 carriage and wagon works, 1 beef-packing and ice-manufacturing establishment, and 7 brick yards. There are three nurseries, two

fire and marine insurance companies, a cotton press company, two national banks with a capital of \$200,000, and a state bank with \$500,000 capital. The valuation of property in 1873 was \$7,669,625. The state fair is held here annually. The city contains 14 public schools, which in 1872 had 26 teachers and 1,228 pupils, two public libraries with about 3,000 volumes, three daily and six weekly newspapers, two monthly periodicals, and 12 churches.—Houston was settled in 1836, and in 1837 was temporarily the seat of government.

**HOUSTON, Sam**, an American soldier, born near Lexington, Va., March 2, 1793, died at Huntersville, Texas, July 25, 1863. His father served in the revolutionary war, and held the post of inspector of brigade till his death in 1807. His mother, after her husband's death, emigrated with her six sons and three daugh-



ters to East Tennessee, within 8 m. of the Cherokee country. Sam had read a few books, among them Pope's translation of the Iliad, of which he could repeat nearly the whole from memory. He desired to learn Greek and Latin, but was refused by his schoolmaster, upon which he left the school, and entered a store as clerk. This occupation he had no relish for, and absconding, he crossed the Tennessee river, and lived with the Indians about three years. Though under 18 years of age, he was six feet high and an active hunter, and stood high in the esteem of his savage associates. Oolooteka, one of their chiefs, adopted him as his son. In 1811 he returned to his family, and opened a school. In 1813, during the war with Great Britain, he enlisted as a common soldier, was promoted to be an ensign, and fought under Jackson against the Indians at the battle of the great bend of the Tallapoosa, March 24, 1814, where he was severely wounded. After the ratification of peace in 1815 he was promoted to be a lieutenant, and was stationed near Knoxville, Tenn., and afterward at New Orleans. In November, 1817, he was appointed a subordinate Indian agent to carry out the treaty with the Cherokees which had just been ratified. In the following winter he conducted a delegation of Indians to Washington. Complaints were made against him to the government on account of his exertions to prevent the unlawful importation of African negroes through Florida, then a Spanish province. He was acquitted of all blame by the government; but conceiving himself to be ill treated, he resigned his commission in the army, March 1, 1818, settled in Nashville, and began to study law. In six months he was admitted to the bar, and began practice in Lebanon, 30 m. E. of Nashville. He was soon appointed adjutant general of the state, with the rank of colonel; and in 1819 he was elected district attorney of the Davidson district, and took up his residence in Nashville. In 1821 he was elected major general of militia, and in 1823 a representative in congress. He was re-elected in 1825 by an almost unanimous vote, and in August, 1827, was chosen governor of Tennessee. In January, 1829, he was married, and in April, for reasons unknown to the public, separated from his wife, resigned his office, went to the west of Arkansas, to which his former friends the Cherokees had removed, and presented himself before Oolooteka, who had now become the principal chief of the tribe. He was kindly received, and by an official act of the ruling chiefs, Oct. 21, 1829, was formally admitted to all the rights and privileges of the Cherokee nation. In 1832 he went to Washington to remonstrate against the frauds and outrages practised upon the Indians. This resulted in the removal of five government agents from office, and he became involved in a series of personal and legal contests with the removed agents and their friends. He was accused in the house of rep-

resentatives by W. R. Stansbury of Ohio of having attempted to obtain from government a fraudulent contract for Indian rations. This led to a personal rencontre between Houston and Stansbury, who was severely beaten. For this Houston was arrested, and publicly censured by the speaker of the house. He was also tried for assault, and fined \$500; but the sentence of the court was not enforced, and the fine was afterward remitted by President Jackson. A committee of which Mr. Stansbury was chairman was appointed to investigate the charge of fraud, but reported that it was not sustained. Houston returned to his wigwam, and in December, 1832, went to Texas, where a revolutionary movement was organizing against the Mexican government. In the constitutional convention, which met April 1, 1833, Houston exercised a controlling influence. When the war with Mexico began he was chosen general of the military district east of the Trinity, and in October, 1835, mustered his forces and led them to the camp of Gen. Austin, who was besieging Bexar. He was soon elected commander-in-chief of the Texan army. After the declaration of Texan independence, he resigned his command, and was immediately reelected commander-in-chief of the army of the new republic. On March 10, 1836, he went to the camp of Gonzalez and took command of the army of 374 men, ill organized, poorly armed, and without supplies. The fort of the Alamo had just been taken by the Mexicans, and its garrison of about 170 put to death. On March 12 information reached the camp of this massacre, accompanied by the statement that the president of Mexico, Santa Anna, was close at hand with an army of 5,000 men. The wildest panic seized the Texan camp. Houston promptly restored order, and fell back to the Colorado, receiving from time to time small reinforcements, till at length the entire number of his force was 650 men. He had no artillery, and Col. Fannin, who was stationed at Goliad with 500 men well armed and supplied with artillery, was ordered to join him; but he was intercepted by a vastly superior force, and after a desperate defence capitulated, March 20, and with his command of 357 was massacred in cold blood, March 27. Santa Anna advanced to Harrisburg, the capital, which he laid in ashes, and marched upon the town called New Washington. Here upon the San Jacinto he was encountered by Houston, who had at length received two six-pounders from Cincinnati. His force had been increased till it numbered 783 men, all volunteers, most of whom had never seen a battle; but, led in a general charge by Houston, with shouts of "Remember the Alamo!" "Remember Goliad!" they utterly routed (April 21) the Mexican force of 1,600 regulars, of whom 630 were killed and nearly all the remainder captured. The Texans had only 8 killed and 25 wounded. The next day Santa Anna, disguised as a common soldier, was captured and brought

before Houston, who rebuked him for the cruel and perfidious massacres of Goliad and the Alamo, but protected him from the wrath of the Texans. A treaty made with the captive president secured the independence of Texas. Houston, who had been severely wounded in the ankle, was relieved from the command of the army, and sailed for New Orleans, where he arrived almost in a dying condition. In July, however, he returned to his home in Nacogdoches. In the following September he was elected president of Texas, and was inaugurated Oct. 22, 1836. He appointed his political rivals to important offices, liberated Santa Anna, and opened negotiations with the United States government for the annexation of Texas to the Union. His presidential term expired Dec. 12, 1838; and as the constitution made him ineligible for the next term, he was succeeded by Mirabeau B. Lamar. During the three years of the next presidential term Texas became involved in wars with the Indian tribes on her borders, in disastrous expeditions against the Mexican territories, and in debt to an enormous amount. The expenditures for the year 1841 amounted to \$1,176,288, and the receipts to only \$442,604. Houston, who had meantime been twice elected to congress, was reelected president in September, 1841, by more than three quarters of the votes. After a stormy administration, beset at the outset with difficulties of the gravest character, which were met with firmness and overcome with great judgment and ability, he retired from his second presidential term in December, 1844. He had paid off a large amount of the national debt, had kept the expenditures far within the revenues, restored peace and trade with Mexico, made treaties with all the hostile Indian tribes, and lastly had negotiated successfully the great measure of annexation to the United States, though its final confirmation did not take place till after the expiration of his constitutional term of office, when he was once more ineligible. Texas became one of the United States in 1845, and Sen. Houston and Thomas J. Rusk were the first senators she sent to Washington. Houston was reelected at the end of his term in 1859, and remained in the senate till March 4, 1860. As a senator, he was the zealous advocate of justice and humanity to the Indians. He opposed the Kansas and Nebraska bill, in a speech March 3, 1854, and gave in his adhesion to the "Know-Nothing" or American party. In 1858 he voted against the Lecompton constitution of Kansas. On Aug. 1, 1859, he was elected governor of Texas. He opposed secession in 1861, and long resisted the clamor for an extra session of the Texas legislature; and he finally resigned his office in preference to taking the oath required by the convention.

**HOVEDEN, Roger de**, an English chronicler, born in Yorkshire about the middle of the 12th century. He was attached to the court of Henry II., and was employed in visiting mon-

asteries, and in watching over the revenues that accrued to the king on the death of the superiors. His history, *Annales Rerum Anglicarum*, is a continuation of the ecclesiastical history of Bede, beginning where he left off (731), and extending to 1202, the third year of the reign of King John. Its accuracy is attested by Sir Henry Savile, Selden, Leland, and Nicolson. It was published in Savile's *Scriptores post Bedam* (London, 1595), and translated by H. T. Riley for Bohn's "Antiquarian Library."

**HOVEY, Alvah**, an American clergyman, born in Thetford, Vt., March 5, 1820. He graduated at Dartmouth college in 1844. Having taught in the academy at New London one year, he studied theology at Newton, Mass., completing the course in 1848. He was pastor of the Baptist church at New Gloucester, Me., for one year, and in 1850 returned to Newton theological institution, and taught in the department of Biblical literature till 1853. He became professor of ecclesiastical history in 1853 and of theology and Christian ethics in 1855, which latter post he still retains (1874). He received the degree of D. D. from Brown university in 1856. He has published a translation of Perthes's "Life of Chrysostom," jointly with the Rev. D. B. Ford (Boston, 1854); "Life and Times of Backus" (1858); "The State of the Impenitent Dead" (1859); "The Miracles of Christ as Attested by the Evangelists" (1863); "The Scriptural Law of Divorce" (1866); and "Religion and the State" (1874).

**HOWARD**, the name of eight counties in the United States. **I.** A central county of Maryland, bounded N. E. by the Patapsco river, and S. W. by the Patuxent; area, 225 sq. m.; pop. in 1870, 14,150, of whom 3,474 were colored. It has an uneven surface, rising in some places into hills. The valleys are generally fertile. The Baltimore and Ohio railroad and the Washington branch pass through it. The chief productions in 1870 were 128,376 bushels of wheat, 415,719 of Indian corn, 204,877 of oats, 97,929 of potatoes, 182,980 lbs. of tobacco, 189,646 of butter, and 7,445 tons of hay. There were 2,958 horses, 3,100 milch cows, 3,056 other cattle, 2,516 sheep, and 8,441 swine; 3 cotton mills, 1 woollen mill, and 5 flour mills. Capital, Ellicott City. **II.** A S. W. county of Arkansas, formed in 1873 from portions of Hempstead, Pike, Polk, and Sevier cos. It is well watered by affluents of Little river and of the Little Missouri. The surface is irregular, consisting of hills, valleys, and river bottoms. The valleys and bottoms produce corn and cotton; the hills are better adapted to the smaller grains and fruit. Timber is abundant, and lead, silver, and marl are found. Capital, Centre Point. **III.** A central county of Indiana, traversed by Wildcat creek, an affluent of the Wabash; area, 279 sq. m.; pop. in 1870, 15,847. It has a level surface and an excellent soil. The Pittsburgh, Cincinnati, and St. Louis, and the Indianapolis, Peru, and Chicago railroads intersect at the

county seat. The chief productions in 1870 were 287,875 bushels of wheat, 356,401 of Indian corn, 34,031 of oats, 37,668 of potatoes, 46,429 lbs. of wool, 121,777 of butter, and 4,250 tons of hay. There were 3,803 horses, 2,687 milch cows, 4,424 other cattle, 14,393 sheep, and 14,656 swine; 5 flour mills, 3 planing mills, 36 saw mills, and 3 woollen factories. Capital, Kokomo. **IV.** A N. E. county of Iowa, bordering on Minnesota, and watered by the Wapsipinicon, Turkey, and Upper Iowa rivers; area, about 480 sq. m.; pop. in 1870, 6,282. It is well timbered, and has tracts of prairie. The Iowa and Minnesota division of the Milwaukee and St. Paul railroad crosses the N. E. corner. The chief productions in 1870 were 321,514 bushels of wheat, 120,234 of Indian corn, 263,258 of oats, 30,713 of potatoes, 408,351 lbs. of butter, and 14,880 tons of hay. There were 2,175 horses, 2,734 milch cows, 3,922 other cattle, 1,648 sheep, and 2,640 swine. Capital, New Oregon. **V.** A central county of Missouri, bounded S. and W. by the Missouri river, and drained by some of its small tributaries; area, 430 sq. m.; pop. in 1870, 17,233, of whom 5,198 were colored. It abounds in anthracite coal, and has quarries of limestone and sandstone. The surface is rolling, and the soil fertile. The chief productions in 1870 were 400,410 bushels of wheat, 917,335 of Indian corn, 152,490 of oats, 42,422 of potatoes, 788,132 lbs. of tobacco, 66,554 of wool, 126,216 of butter, and 3,856 tons of hay. There were 5,799 horses, 2,425 mules and asses, 4,103 milch cows, 7,326 other cattle, 19,156 sheep, and 35,094 swine; 2 manufactories of carriages, 4 of saddlery and harness, and 4 flour mills. Capital, Fayette. **VI.** A S. E. county of Kansas, bordering on the Indian territory, and drained by Suicide creek and other branches of the Arkansas, and by Fall river; area, 1,271 sq. m.; pop. in 1870, 2,794. The surface is undulating and the soil fertile. The chief productions in 1870 were 4,766 bushels of wheat, 26,795 of Indian corn, 2,710 of oats, 2,304 of potatoes, and 150 tons of hay. There were 243 horses, 502 milch cows, 1,348 other cattle, 592 sheep, and 435 swine. Capital, Elk Falls. **VII.** An E. central county of Nebraska, intersected by Loup fork of the Platte river and its branches; area, 576 sq. m.; not included in the census of 1870. **VIII.** A N. W. county of Dakota, bordering on Montana, recently formed and not included in the census of 1870; area, about 3,500 sq. m. It is bounded N. by the Missouri, intersected by the Little Missouri, and watered by other streams.

**HOWARD, Charles**, Lord Howard of Effingham, an English admiral, born in 1536, died Dec. 14, 1624. His father, William, son of Thomas, second duke of Norfolk, was lord high admiral of England and lord privy seal. The son was sent to France in 1559 to congratulate Francis II. on his accession to the throne, and served with credit on land and sea for many years. In 1585 he was appointed lord high ad-

miral, and in 1588 succeeded in averting from the English coasts the attack of the Spanish armada. In 1596 he participated with the earl of Essex in the capture of Cadiz and the destruction of the Spanish shipping there, for which service he was created earl of Nottingham. The appointment of Essex in the succeeding year to be hereditary earl marshal, with precedence over the lord high admiral, induced Lord Howard to resign the latter office; but he subsequently resumed it, and in 1599, during the alarm at the prospect of another Spanish invasion, and of an insurrection under Essex in Ireland, was appointed by the queen lieutenant general of England. He commanded the party which captured Essex in London, and retained his office under James I. until a few years before his death, when he resigned it in favor of Buckingham, receiving in compensation a pension of £1,000, and the acquittal of a debt of £1,800 due the crown.

**HOWARD, Henry**, earl of Surrey. See **STURRY**.

**HOWARD, John**, an English philanthropist, born in Enfield, Sept. 2, 1726, died in Kherson, Russia, Jan. 20, 1790. At 16 years of age he was apprenticed to a grocer in London; but upon the death of his father soon after, he purchased his indentures and travelled on the continent. Returning to England, he occupied himself with medical and scientific studies at Stoke Newington. About the age of 25 he experienced a severe attack of illness, and upon his recovery testified his gratitude to his landlady, who had nursed him, and who was 27 years his senior, by marrying her. She died at the end of three years, and Howard in 1756 embarked for Lisbon, with a view of doing something to alleviate the calamity of the great earthquake. On the voyage he was taken prisoner by a French privateer and carried into Brest, where he witnessed the inhuman treatment of prisoners of war. Having procured the exchange of himself and his fellow captives, he returned to England, married a second time in 1758, and settled upon an estate at Cardington, Bedfordshire, which he had inherited from his father. His career of active philanthropy may be said to date from this time. He built schools and model cottages for the peasantry, the latter the first erected in England for their benefit; and Cardington, formerly a wretched and filthy village, now attracted attention by its neatness and the healthful and thrifty appearance of its inhabitants. In 1765 his second wife died, and for several years he was employed in his studies and reformatory plans, and in travelling on the continent. He was named for the office of sheriff of Bedfordshire in his absence, and upon his return in 1773 accepted, and visited in his official capacity the Bedford jail, in which John Bunyan wrote his "Pilgrim's Progress." The wretched condition of the prisoners made a deep impression upon him; and the confinement of many innocent persons for months and sometimes for years, from in-

ability to pay their fees of jail delivery, so shocked him that he proposed to the magistrates to pay regular salaries to the jailers, in place of the fees collected from the prisoners. The magistrates, unprepared for such an innovation, asked for a precedent, and, in his fruitless exertions to find one, Howard visited every town in England containing a prison. He collected a mass of information respecting prison abuses, which he communicated in a report to the house of commons, who gave him a vote of thanks, and in 1774 passed bills "for the relief of acquitted prisoners in the matter of fees" and "for preserving the health of prisoners." At his own expense he caused copies of the new laws to be sent to every jailer in the kingdom. The prominence thus given to his name secured his election from Bedford to the house of commons; but his sympathy with the American revolution aroused the ministry to oppose him, and a parliamentary scrutiny unseated him. He never afterward participated in political life, but gave his whole time to the philanthropic plans in which he had embarked. He reexamined the principal penal establishments of England, and visited those of France, Germany, and the Low Countries; then made a new tour through England, examining the operation of the new jail act, and relieving much distress among poor debtors, and revisited a large portion of the continent. The result of these researches appeared in his "State of the Prisons in England and Wales, with Preliminary Observations and an Account of some Foreign Prisons" (4to, 1777). One of the first fruits of this publication was the determination of the ministry to make a trial of the discipline of hard labor in one of the large prisons. But as no building was adapted to the purpose, Howard undertook in 1778 another tour to collect plans and information, in the course of which he visited the Low Countries, Germany, Italy, and France, and travelled upward of 4000 miles. In the succeeding year he made another survey of English prisons, and in 1780 published an appendix to his work. A bill, drafted by Sir William Blackstone and Mr. Eden, was now passed for building two penitentiaries on the hard labor system, of which Howard was appointed the first supervisor. To escape controversy as to the site of the buildings, he resigned his office, and between 1781 and 1784 travelled through Denmark, Sweden, Russia, Poland, Spain, and Portugal, publishing in 1784 a second appendix and a new edition of his work. His labors for a period of more than ten years had left him with impaired pecuniary resources and shattered health; but he embarked upon a second series of philanthropic researches with a zeal surpassing his physical powers, volunteering to procure for the British government information relating to quarantine establishments. The French government was incensed against him for having published in 1780 a translation of a suppressed French account of the interior of

the Bastille, and refused him a passport. He therefore travelled through the country in various disguises, and, after a series of romantic adventures and several narrow escapes from the police, who were constantly on his track, succeeded in visiting the new lazaretto at Marseilles. He proceeded thence to Malta, Zante, Smyrna, and Constantinople, fearlessly exposing his person in infected places. That he might speak with authority on the subject of pest houses, he went to Smyrna, sought out a foul ship, and sailed in her for Venice. After a voyage of 60 days, during which he assisted the crew in beating off an attack of pirates, he arrived at his destination and was subjected to a rigorous confinement in the Venetian lazaretto, under which his health suffered severely. He returned to England in February, 1787, after an absence of 16 months, and published his second great work, "An Account of the Principal Lazarettos of Europe, with various Papers relating to the Plague, together with further Observations on some Foreign Prisons and Hospitals, and additional Remarks on the Present State of those in Great Britain and Ireland" (4to, 1789), in the preface to which he announced his intention to pursue his inquiries in the same direction, observing that his conduct was not from rashness or enthusiasm, but a serious conviction of duty. In the summer of 1789 he started on his last continental tour, meaning to pass through Russia to the East, but was cut off by camp fever which he contracted from a patient at Kherston, on the Black sea. He expended nearly the whole of his fortune in various benefactions. In his private relations he was pure-minded, pious, and upright.—See Hepworth Dixon's "Howard and the Prison World of Europe" (2d ed., London, 1850); also the memoirs by Dr. Aikin, J. B. Brown, the Rev. J. A. Field, and T. Taylor. A marble statue of him was erected in St. Paul's cathedral, London.

**HOWARD, John Eger**, an American revolutionary soldier, born in Baltimore co., Md., June 4, 1752, died Oct. 12, 1827. In 1776 he commanded a company in the flying camp under Gen. Mercer, which took part in the battle of White Plains. Upon the disbanding of his corps in 1776, he was commissioned major in the 4th Maryland regiment of the line, with which he took part in the battles of Germantown and Monmouth. In 1780, as lieutenant colonel of the 5th Maryland regiment, he fought at Camden under Gates (Aug. 16), and in the latter part of the year joined the army under Greene. In the battle of Cowpens, Jan. 17, 1781, he displayed great gallantry, and the bayonet charge of the Maryland troops under his command secured victory to the Americans. At one period of the day he held in his hands the swords of seven officers of the 71st British regiment who had surrendered to him. This was said to have been the first occasion in the war on which the bayonet was effectively used by the American troops. For his ser-

vices in this battle Col. Howard received from congress a silver medal. He fought at Guilford Court House (March 15), materially aiding Greene in effecting his retreat, and again at Hobkirk's Hill (April 25). After the latter battle he succeeded to the command of the 2d Maryland regiment. At Eutaw Springs (Sept. 8) his troops were so cut up that the command was reduced to Col. Howard, a single commissioned officer, and 30 men. With this small force he was returning to the charge when he was severely wounded. He was governor of Maryland from 1789 to 1792, United States senator from 1796 to 1803, and in 1798 was selected by Washington, in anticipation of war with France, for one of his brigadier generals. During the panic in Baltimore subsequent to the capture of Washington by the British troops in 1814, he was one of the most earnest opponents of the capitulation.

**HOWARD, Oliver Otis**, an American soldier, born at Leeds, Maine, Nov. 8, 1830. He graduated at Bowdoin college in 1850, and at West Point in 1854, and became instructor in mathematics there in 1857. He resigned his commission as first lieutenant June 4, 1861, to take command of a regiment of Maine volunteers. At the battle of Bull Run he commanded a brigade, and was made brigadier general of volunteers, Sept. 3. He was assigned to a brigade in the army of the Potomac, and in the battle of Fair Oaks, June 1, 1862, lost his right arm. After the battle of Antietam he took command of a division of the 2d corps, and at the battle of Chancellorsville he commanded the 11th corps. At Gettysburg, after the death of Reynolds, he commanded during the first day of the battle. He afterward received a commission as major general of volunteers, dating from Nov. 29, 1862. He was engaged at Lookout Valley, Oct. 29, 1863, at Chattanooga, Nov. 23-25, and in the operations for the relief of Knoxville in December. On July 27, 1864, he took command of the army of the Tennessee. He was in most of the battles of the Georgia campaign ending in the capture of Atlanta, and commanded the right wing of Sherman's army in its march to the sea and through the Carolinas. He was appointed a brigadier general in the regular army, his commission to date from Dec. 21, 1864; and brevet major general March 13, 1865. On May 12, 1865, he was appointed commissioner of the freedmen's bureau, and held that office until the closing of the bureau by law, June 30, 1872. He was made a trustee of Howard university March 19, 1867, president of that institution April 6, 1869, and resigned in 1873. He was appointed special commissioner to the Indians March 6, 1872, and spent eight months on that duty in New Mexico and Arizona. In March, 1874, he was tried by court martial on charges of pecuniary dishonesty in the management of the freedmen's bureau, and was acquitted.

**HOWARD, Thomas**, third duke of Norfolk, an English statesman, born about 1473, died

July 18, 1554. In 1518 he became high admiral of England, and in the same year aided his father in gaining the battle of Flodden field, for which he was created earl of Surrey. He afterward quelled an insurrection in Ireland under O'Neal, and one incited by the Catholics in the north of England. Though a staunch Catholic, he succeeded by his prudent conduct in disarming for a long time the suspicion and jealousy of Henry VIII., who however condemned to death his son, the accomplished earl of Surrey. The duke himself was finally condemned to be beheaded for treason; but the king dying before his execution, a respite was granted him, and he was kept a prisoner in the tower throughout the reign of Edward VI. On the accession of Mary in 1553 he was restored to his rank and property.

**HOWARD, Thomas**, earl of Arundel. See ARUNDEL.

**HOWARD UNIVERSITY**, an institution of learning in Washington, D. C., organized by a special act of congress in 1867, and named from Gen. O. O. Howard, one of its founders. It was designed to afford advanced instruction especially to colored students, but in the admissions no distinction is made as to color or sex, and among its instructors and students are white and colored persons of both sexes. The university grounds are near the head of Seventh street, where are grouped nine buildings, the chief of which is four stories high and contains rooms for lectures and recitations, a chapel, library, philosophical apparatus, museum, and offices. Miner hall is three stories high, with rooms for 100 young women, while Clark hall has accommodations for 200 male students. The general management of the institution is vested in a board of 21 trustees. The university comprises a normal department with a two years' course of study, including also, for younger students, the model school and the Miner school; the preparatory, with a course of three years; the collegiate, four years; the theological, two years; the law, two years; the medical, three years; and the military, commercial, and musical departments. An examination is required for admission to the collegiate department, and upon the completion of the course the degree of A. B. is conferred. Special efforts have been made to give the law department the most complete facilities for imparting a thorough legal education. From this school have graduated 49 young men and one young woman. The whole number of instructors connected with the university is 28, including 4 in the collegiate, 5 in the theological, 3 in the law, and 9 in the medical department. The number of students in 1872-'3 was 238 in the normal, 100 in the preparatory, 35 in the collegiate, 26 in the theological, 67 in the law, 45 in the medical, 84 in the commercial, and 21 in the musical department; total, after deducting repetitions, 567. About two thirds of the students are colored. Indigent students may be relieved from paying the tuition fee.

The university possesses a library of 7,500 volumes, a mineralogical cabinet, a museum of curiosities, and a picture gallery. Although the government of the United States aided in the establishment of the university, it is now dependent upon contributions and fees received from students. More than \$100,000 toward a proposed endowment of \$300,000 has been subscribed. Gen. Howard was president of the university until the latter part of 1873, when he resigned, and John M. Langston (colored), dean of the law department, was appointed vice president.

**HOWE**, the name of three British officers connected with American history, all of them sons of Emanuel Scrope Howe, Viscount Howe in the peerage of Ireland. **I. George Augustus**, general, born in 1724, killed at Ticonderoga, July 8, 1758. In 1757 he was sent to America in command of the 60th regiment, and arrived at Halifax in July. On Sept. 28 he was put in command of the 55th foot, and on Dec. 29 was made brigadier general. On July 6, 1758, he landed under Abercrombie at the outlet of Lake George. Coming suddenly upon a French force, he fell in the ensuing skirmish. The general court of Massachusetts appropriated £250 for a monument to him, which was erected in Westminster abbey. **II. Richard**, admiral, born in London in 1725, died there, Aug. 5, 1799. He entered the navy at the age of 14, and served with distinction against the French from 1745 to 1759. After the conclusion of peace he obtained a seat at the admiralty board. In 1765 he was appointed treasurer of the navy, and entered parliament for Dartmouth. Five years later he was made rear admiral of the blue, and commanded a fleet in the Mediterranean. In 1776 he sailed for North America with the rank of vice admiral of the blue, and as joint commissioner with his brother William for restoring peace. He was variously employed against the American forces for two years, and in August, 1778, had an indecisive encounter with a superior French fleet under Count d'Estaing, off the coast of Rhode Island, both fleets being much shattered by a severe storm. In April, 1782, he was made a peer of Great Britain, under the title of Viscount Howe, having since 1758 borne the Irish title of the same grade, inherited from his brother George. In the latter part of 1782 he succeeded in bringing into the harbor of Gibraltar the fleet sent to the relief of Gen. Elliott, then besieged there by the combined French and Spanish forces. For these and previous services he was in August, 1788, created Earl and Baron Howe of Langar. In 1793 he was put in command of the channel fleet. On June 1, 1794, he gained a victory over the French off the western coast of France, and received the thanks of parliament. In the succeeding year he was made admiral of the fleet, and in 1797 a knight of the garter. His last important service was the suppression of the mutiny in the fleet at Spithead in 1797. His memoirs were

compiled by Sir John Barrow (London, 1838).

**III. William**, general, born Aug. 10, 1729, died July 12, 1814. He commanded the light infantry under Wolfe in the battle on the heights of Abraham, near Quebec (1759), and in 1775 succeeded Gen. Gage as commander of the British forces in America. He commanded at the battle of Bunker Hill, and after the evacuation of Boston retired to Halifax. Subsequently he defeated the Americans on Long Island, Aug. 27, 1776, took possession of New York, Sept. 15, directed the movements in the Jerseys and in Pennsylvania, and repelled the American attack at Germantown, Oct. 4, 1777. He was succeeded by Sir Henry Clinton in May, 1778. His conduct was severely criticised, but an investigation ordered by parliament in 1779 freed him from blame. He succeeded his brother Richard in the Irish viscounty, and at the time of his death was a privy councillor and governor of Plymouth.

**HOWE, Elias**, an American inventor, born in Spencer, Mass., July 9, 1819, died in Brooklyn, N. Y., Oct. 3, 1867. He lived with his father, who was both farmer and miller, till 1835, working upon the farm and in the mill, and attending the district school during the winters. He then went to Lowell, and was employed in a manufactory of cotton machinery, and afterward worked in a machine shop in Boston. Here he developed his invention of the sewing machine, completing his first machine in May, 1845, and securing a patent Sept. 10, 1846. After constructing four machines in the United States, he visited England in 1847, and remained two years. He returned to Boston entirely destitute, and resumed his trade. From this period till 1854 he was involved in expensive lawsuits, when the principal infringers of his patents acknowledged his rights, and arranged to manufacture sewing machines under licenses from him. His income now steadily increased, reaching \$200,000; and his fortune realized from his invention is said to have amounted to \$2,000,000. During the civil war he enlisted as a private in a Connecticut regiment, and when the payment of the regiment was delayed by the government, he advanced the necessary money. (See SEWING MACHINE.)

**HOWE, John**, an English clergyman, born at Loughborough, Leicestershire, May 17, 1630, died in London, April 2, 1705. He graduated at Christ's college, Cambridge, became pastor of a nonconformist church in Great Torrington, and was selected by Cromwell in 1657 for his domestic chaplain. After the restoration and the act of uniformity he led a wandering life, and continued to preach in private houses. He passed five years in Ireland, where he was chaplain to Lord Massarene in the parish of Antrim, was pastor of a congregation in London from 1675 to 1684, travelled on the continent with Lord Wharton in 1685, became pastor of the English church at Utrecht, and returned to England in 1687, when James II. published his declaration for liberty of con-

science. A complete edition of his works, with a life by the Rev. John Hunt, appeared in London in 8 vols. (1810-'22; new ed., 1868), and with a life by Edmund Calamy in 1 vol. (1838). A biography, by Henry Rogers, was published in 1836.

**HOWE, I. Samuel Gridley**, an American philanthropist, born in Boston, Nov. 10, 1801. He studied in the Boston grammar school, thence went to Brown university, where he graduated in 1821, and studied medicine in Boston. In 1824 he went to Greece, and served as a surgeon in the patriot army and in various other capacities till 1830. In 1831 he returned to the United States, and soon became interested in the project for establishing an institution for the blind in Boston. He accepted the charge of it, and embarked at once for Europe, to acquire the necessary information and engage teachers, visiting the schools of France and England for this purpose. While in Paris he was made president of the Polish committee, and undertook to carry and distribute funds for the relief of the detachment of the Polish army which had crossed into Prussia. In the discharge of this duty he was arrested and imprisoned for about six weeks by the Prussian government. He was then liberated, and escorted over the French frontier by night. In 1832 the Perkins institution for the blind, in Boston, was put in operation under his charge. A notable achievement in this institution is the education of Laura Bridgman, a blind deaf mute. (See BRIDGMAN, LAURA.) He took a prominent part in founding the experimental school for the training of idiots, which resulted in the organization, in 1851, of the Massachusetts school for idiotic and feeble-minded youth. He was actively engaged in the anti-slavery movement, and was a free-soil candidate for congress from Boston in 1846. He engaged earnestly in the sanitary movement in behalf of the soldiers during the civil war. In 1867 he again went to Greece as bearer of supplies for the Cretans in their struggle with the Turks, and subsequently edited in Boston "The Cretan." In 1871 he was one of the commissioners to visit Santo Domingo and report upon the question of the annexation of that island to the United States, of which he has since been an earnest advocate. He has published a "Historical Sketch of the Greek Revolution" (1828), and a "Reader for the Blind," in raised characters (1839). **II. Julia Ward**, an American poetess, wife of the preceding, born in New York, May 27, 1819. Her early education comprised an unusually wide range of studies. In 1843 she was married to Dr. Howe, with whom she made a tour in Europe. In 1850 she again went to Europe, being absent more than a year, a great part of the time in Rome. After her return she published "Passion Flowers," a volume of poems (1854); "The World's Own," a drama (1855); "Words for the Hour" (1856); "Lenore," a tragedy (1857); and "Hippolytus," a tragedy (1858).

During the winter of 1858-'9 she visited and in 1860 published "A Trip to Cuba" volume of poems, "Later Lyrics," appeared in 1866. In 1867 she accompanied her husband to Greece, and published "From the Olive" (1868). She is a prominent one in behalf of woman's rights.

**HOWELL**, a S. county of Missouri, born on Arkansas, and drained by Spring river; affluent of the N. fork of the White; about 900 sq. m.; pop. in 1870, 4,218, of 24 were colored. The surface is hilly, a soil in the valleys fertile. There are forests of pine. The chief productions were 15,356 bushels of wheat, 115,728 bushels of corn, and 8,454 of oats. There were 1,132 horses, 3,201 cattle, 2,707 sheep, 5,656 swine. Capital, West Plains.

**HOWELL, James**, an English author, born at Brecknock, Wales, in 1596, died in 1666. He was educated at Jesus college, Oxford, and passed many years on the continent, as a cantile agent, as travelling tutor, or in a domestic capacity. In 1640 he was appointed clerk to the council at Whitehall, but after breaking out of the civil war he was taken into the Fleet, where he languished until the death of Charles I. After the restoration he was appointed historiographer royal, an office which he retained until his death. His publications number about 40, the greater part as well as the best of them being in Latin. His *Epistolæ Ho-Eliaenæ*, or "Familiar Letters," first printed in 1645-'55, and of many editions have appeared, was the first published collection of epistolary literature in the English language.

**HOWELLS, William Dean**, an American author, born in Martinsville, Belmont co., Ohio, Oct. 1, 1837. He learned the printing business at his father's office, and worked at that trade for 12 years. He then became connected with the "Ohio State Journal" as assistant editor, and up to 1860 had published poems in the "Atlantic Monthly," besides reviews of Abraham Lincoln, and, with John J. Green, a volume of verse called "Poems of Friends." He was appointed by President Lincoln United States consul at Venice, where he remained till 1865. On his return he joined the staff of the "Nation," and afterwards became assistant editor of the "Nation," which magazine passed into his sole control as editor in July, 1871. His publications are: "Venetian Life" (London and New York, 1866); "Italian Journeys" (1867); "No Lost," a poem (1868); "Suburban Sket" (1869); "Their Wedding Journey" (1870); and "A Chance Acquaintance" (1873).

**HOWITT, I. William**, an English author, born at Heanor, Derbyshire, in 1795. His parents were members of the society of Friends, and in 1823 he married Mary Botham, a member of the society. They made a religious excursion through Great Britain, and subsequently embarked in literature, w

several books in common, the first being "The Forest Minstrel and other Poems" (1831). In 1840 he went to Heidelberg for the education of his children. In 1847 he established "Howitz's Journal," which was published only a short time. In 1852-'4 he was engaged in gold mining in Australia. His principal works are: "Book of the Seasons" (1831); "Popular History of Priestcraft" (1834); "Rural Life of England" (1837); "Colonization and Christianity" (1838); "Boy's Country Book" (1839); "Visits to Remarkable Places" (1839); "Student Life of Germany" (1841); "Rural and Domestic Life of Germany" (1842); "Jack of the Mill" (1844); "The Aristocracy of England" (1846); "Homes and Haunts of the British Poets" (1847); "The Year Book of the Country" (1847); "The Hall and the Hamlet" (1847); "Stories of English Life" (1853); "Natural History of Magic" (1854); "Land, Labor, and Gold" (1855); "The Man of the People" (1860); "Illustrated History of England" (1861); "The Ruined Castles and Abbeys of Great Britain" (1861); "History of the Supernatural in all Ages and Nations" (1863); "Discoveries in Australia" (1865); and "The Mad War Planet, and other Poems" (1871). **M. Mary Botham**, an English authoress, wife of the preceding, born at Uttoxeter about 1804. She is joint author with her husband of several of the books above mentioned. Among her numerous separate publications are the novels "Wood Leighton" (1836) and "The Heir of West Wayland" (1851). She has written many volumes, in prose and verse, designed for the young, and has made numerous translations from the Swedish of Fredrika Bremer, the Danish of Andersen, and the German of various authors. Her later works are: "Biographical Sketches of the Queens of England" (1862); "The Cost of Carrawyn" (1864); "Birds and their Nests" (1871); and "A Pleasant Life" (1871).—**ANNA MARY**, daughter of the preceding, married in 1859 to Mr. A. A. Watts, has published "An Art Student in Munich" (1853) and "The School of Life" (1857). Her sister **MARGARET** has published "Twelve Months with Fredrika Bremer in Sweden" (2 vols., 1866).

**HOWITZER**. See ARTILLERY, vol. i., p. 786.

**HOWSON, John Saul**, an English clergyman, born in 1816. He graduated at Trinity college, Cambridge, a double first, in 1837, and in each of the next three years obtained a prize for an essay. In 1845 he took orders and became senior classical master in Liverpool college, of which he was principal from 1849 to 1865. In 1866 he was made vicar of Wisbeach, Cambridgeshire, and in 1867 dean of Chester. He has made numerous contributions to Biblical literature, his principal publication being "The Life and Epistles of St. Paul" (2 vols. 4to, 1850-'52), which he wrote conjointly with the Rev. W. J. Conybeare, furnishing the historical, geographical, and descriptive matter. He has also published

"The Character of St. Paul" (1864) and "Metaphors of St. Paul" (1868).

**HOWTH, Hill of**, a peninsula of Ireland, county Dublin, forming the N. boundary of Dublin bay. It is a rocky and picturesque elevation, rising to the height of 563 ft., 3 m. long and 2 m. broad, having at its extremity a lighthouse. Howth gives the title of earl to the family of St. Lawrence, the descendants of its Anglo-Norman conquerors. A harbor of 52 acres has been formed at Howth, costing £500,000.

**HÖXTER**, a town of Prussia, in the province of Westphalia, on the Weser, crossed here by a stone bridge, 28 m. E. N. E. of Paderborn; pop. in 1871, 5,041. It is a thriving manufacturing and commercial place, and paper, cotton goods, and linen are made. Höxter was formerly the capital of the ecclesiastical principality of Korvei, and belonged to the Hanseatic league. It abounds with reminiscences of the battles of Charlemagne against the Saxons, and the watch tower on the neighboring Brunsberg is according to some traditions the relic of a formidable Saxon fortress built by Bruno, brother of Wittikind. The town endured many military vicissitudes during the 17th century.

**HOYLE, Edmund**, an English writer on games, born in 1672, died in 1769. So generally is his principal work accepted as authority in card playing, that "according to Hoyle" has become a proverb. There have been many editions of his book, among which are "Hoyle's Games, Improved and Enlarged by G. H." (London, 1853); "Hoyle's Games made Familiar" (London, 1855); and "Hoyle's Games, containing the Rules for playing Fashionable Games" (Philadelphia, 1859).

**HRABANTS MAURIS**. See RABANTS.

**HUACA**, a Peruvian word, signifying something sacred, applied particularly to sepulchral mounds. Among the Peruvians all persons remarkable for their inventions, or for having in any way ameliorated the condition of mankind, were the recipients of a kind of hero worship. Few had temples, their shrines being generally their tombs, called *huacas*. The Peruvians made sacrifices to the huacas, which were supposed to respond to petitions and questions supported by appropriate offerings made in a proper spirit. The inner chambers of these oracular tombs were sometimes inhabited by priests; and generally they seem to have been devices whereby an inferior class of priests obtained their support. Some were of great extent, and erected over the remains of the incas, who were entitled to divine honors after death, and over the chiefs of provinces. In accordance with an invariable custom, the wealth of these high personages was buried with them. The violation of their tombs was commenced soon after the conquest, and from some of them vast treasures were taken. A single huaca among the ruins of Chimu, near the port of Trujillo in Peru, opened in 1563 by Garcia Gutierrez, afforded so large a treasure of gold and silver, that he paid 85,547 castellanos of



gold, as the royal fifth, into the treasury of Trujillo. But he did not obtain the whole of it, for in 1592 it was again opened, and 47,020 castellanos of gold were paid into the treasury as the royal fifth. So it seems that not less than 677,600 castellanos of gold, equal to \$931,000, were taken from this single tomb. The name huaca, as applied to aboriginal graves, gradually became extended to the provinces adjacent to Peru on the north, where they were also found to contain more or less of treasure. The name has also been applied to Indian graves in the district of Chiriqui in Colombia, whence many golden ornaments and images have been extracted.

**HUALLAGA**, a river of Peru, rising on the E. slope of the Eastern Cordillera, about lat. 10° S. and lon. 75° 30' W., flowing N. W. parallel to that range as far as lat. 8°, where it curves to the N. E., and joining the Marañon or Upper Amazon at La Laguna, lat. 4° 50' S. and lon. 75° 40' W., after a tortuous course of some 600 m., mainly through the Pampa de Sacramento, a region of which little is definitely known. For 60 m. from its mouth the Huallaga is navigable by the largest vessels; above that point rapids occur at intervals of about 50 m., but these do not impede the passage of canoes, especially in the upper portion of the river.

**HUAMANGA**. See AYACUCHO.

**HUANCAMELICA**. I. An inland department of Peru, occupying a portion of the valley bordered by the Eastern and Western Cordilleras S. E. of the department of Lima. The surface is intersected by numerous hills, and watered by the Jauja and other rivers, and numerous lakes. The climate is mostly very cold, and the soil rather inferior to that of other parts of the republic. There being no forests, wood is scarce, and the chief combustible used is a species of grass called *ichu*. Gold is found, silver is abundant, and there is some copper; but the principal mineral product is mercury, especially that from the mine in the Cerro de Santa Barbara, discovered in 1563, the mean annual yield of which for 200 years was from 400,000 to 600,000 lbs. Large numbers of cattle, sheep, and llamas are reared, and wool of excellent quality is exported. II. A city, capital of the department, and of a province of the same name, 150 m. S. E. of Lima; pop. about 8,000. The streets are regular, and the houses solidly constructed of stone; several stone bridges cross the streams intersecting the town. Owing to the elevation, 12,670 ft. above the sea, the climate is very cold, and the town is exposed to fierce tempests, thunder, hail, and frost. Husbandry, cattle rearing, and mining are the chief occupations. In the immediate vicinity are numerous mercury furnaces; and excellent colors are extracted from a peculiar species of metalliferous clay which abounds in the neighborhood.

**HUANTA**, a town of Peru, in the department of Ayacucho, 205 m. S. E. of Lima; pop.

about 5,000. It is in a very picturesque and fertile region, is well built of stone, and has a large trade in cattle, sheep, grain, fruit, coca, dragon's blood, cinnamon, honey, &c.

**HUANUCO**. I. An inland department of Peru, occupying a portion of the valley bordered by the Eastern and Western Cordilleras, N. of the department of Lima. The surface is irregular, being intersected by hills mostly densely wooded, and delightful vales, watered by the Huallaga, Jauja, and numerous minor streams. The climate, hot in the low and cold in the elevated regions, is very salubrious, and the soil is extremely fertile and well cultivated. Precious woods, particularly cedar, and coca leaves are important articles of commerce. The sugar cane thrives well, and sugar is manufactured in several places; and coffee of superior quality is grown. The plains, though of inconsiderable extent, afford good pasturage for large herds of cattle and sheep; and the horses of Concepcion are highly esteemed. The district of Cerro de Pasco, formerly the capital of the department, has long been celebrated as the principal mining region of Peru. There are weaving factories at Tarma and elsewhere. Ruins of towns, temples, palaces, and fortresses, in various parts of the department, attest the opulence and civilization of the ancient Incas, once the exclusive lords of the soil. II. A city, capital of the department, and of a province and district of the same name, near the river Huallaga, 165 m. N. N. E. of Lima; pop. about 7,000. The only objects of interest still remaining in this once flourishing city are the ruins of edifices attesting its early splendor, and particularly a palace and temple of the sun, built by the Incas. Besides mining and agriculture, the manufacture of sweetmeats, much prized in Lima, occupies many of the inhabitants. It was founded in 1539 by Gomez Alvarado, who named it Leon de los Caballeros.

**HUARAZ**, an inland city of Peru, capital of the department of Ancacha, and of a district of its own name, 192 m. N. N. W. of Lima; pop. about 6,000. It is situated in the valley of Huaraz, one of the most fertile in the republic, and derives its importance from the large quantities of wheat and other grains, sugar, fruit, and cattle which it exports. Wood is here extremely scarce, and in its stead a species of peat called *champa* is used for fuel. The mineral productions, including gold, silver, and copper, are of considerable value. A railway is in course of construction (1874) from Huaraz to Chimbote, 172 m.

**HUASTECAS**. See QUETZALCOATL.

**HUBBARD**, William, an American historian, born in England in 1621, died in Ipswich, Mass., Sept. 14, 1704. He graduated at Harvard college in 1642, and was ordained in 1658 as minister at Ipswich, where he continued during the remainder of his life. In 1688 he was temporary rector or president of Harvard college. He is the author of "A Narra-

five of the Troubles with the Indians from 1667 to 1677, with a Discourse" (4to, Boston, 1677), the map accompanying which is supposed to be the first executed in America, and "Memoir of Gen. Denison" (1684). He left also in manuscript a general history of New England, for which the colony paid him £50. For the most of the earlier annals he was indebted to Winthrop's MS. journal, and his MS. has been used by other historians and annalists. It was published by the Massachusetts historical society in 1815 (8vo, Cambridge).

**HUBBARDTON**, a town of Rutland co., Vermont, 48 m. S. W. of Montpelier; pop. in 1870, 606. It is noted for a battle between the British and Americans, July 7, 1777. The American army under Gen. St. Clair having been forced to evacuate Ticonderoga, July 6, their main body marched through Hubbardton to Castleton, leaving a rear guard of 1,000 half equipped men under Cois. Warner, Francis, and Haile, to wait at Hubbardton for the stragglers. Here on the following morning they were overtaken by about double their number of British, commanded by Gen. Fraser. The battle began at 7 A. M. The charge of the Americans at first forced the enemy to give way, but they soon formed again, while at the same time Col. Francis was mortally wounded, his men fell back, and Gen. Riedesel appeared on the field with a heavy reinforcement for the British. Warner was obliged to retreat, leaving 30 of his men killed and 294 wounded and prisoners, while the British acknowledged a loss of 183 killed and wounded, though, according to Ethan Allen, they lost 300. Col. Haile withdrew from the field with 300 men without coming into action. He demanded a court martial to investigate the charge of cowardice brought against him, but died in captivity before it could be held. A monument on the battle field was inaugurated July 7, 1859.

**HUBER**, François, a Swiss naturalist, born in Geneva, July 2, 1750, died in Lausanne, Dec. 21, 1831. At 15 years of age a too close devotion to the study of the natural sciences, which he had followed from childhood, affected his health and eyesight, and he was taken to Paris for medical treatment. His health was soon restored, but the disease of his eyes was pronounced incurable, and he soon after became totally blind. Before that time he had won the affections of a young lady, Mlle. Lefebvre, who married him, and until the close of his life was unremitting in her devotion to him. Being left by his father in comfortable circumstances, he resumed his investigations in natural science, in which he was aided by his wife, and a faithful attendant named Burdet, who ultimately became his reader and amanuensis. He had previously given much attention to the habits of bees, and believing that many of the statements of Réaumur and Bonnet on the subject were erroneous, he proceeded, with the assistance of his wife and attendant, to make a vast number of original

observations, which, having been digested and systematically arranged by him, were first published in his *Lettres à Ch. Bonnet* (1792). The work was reprinted in 1796, and again in 1814, under the title of *Nouvelles observations sur les abeilles*, both times with important additions. The last edition contained his *Mémoire sur l'origine de la cire*, in preparing which he was assisted by his son Pierre. The impregnation of the queen bee, and many other important facts in the economy of the beehive, were first made known in this work, which from its intrinsic merits, as well as the unusual circumstances under which it was prepared, made Huber's name famous throughout Europe. Subsequently, with the coöperation of Senebier, he produced a *Mémoire sur l'influence de l'air et des diverses substances gazeuses dans la germination des différentes plantes* (Geneva, 1801).—**PIERRE**, his son, born in Geneva in 1777, was the author of several valuable papers relating to bees and butterflies, and published *Recherches sur les fourmis indigènes* (1810). He died at Yverdon in 1840.

**HUBER**, Jean Rodolphe, a Swiss painter, born in Basel in 1668, died in 1748. He studied in Switzerland and in Italy, and executed works for various German princes, including historical pictures for the palace of the duke of Würtemberg at Stuttgart. He excelled in correctness of drawing and vigorous coloring, and on account of his surprising facility in portrait painting was called the Tintoretto of Switzerland, though greatly inferior to that master.

**HUBER**, Johann Nepomuk, a German theologian, born in Munich, Aug. 18, 1830. He graduated at the university of Munich in 1854, and became professor in 1859. His *Philosophie der Kirchenräter* (Munich, 1859) was in 1860 placed on the prohibitory index, and an effort was made to prevent students from attending his lectures. His rupture with the ultramontanes became still wider in 1863, when in an assembly of Roman Catholic scholars he stood alone in asserting the right of free investigation in theology. In 1871 he became the foremost adversary of the society of Jesus, and one of the principal leaders of the Old Catholic movement in Bavaria, in opposition to the papal decree of infallibility. His works include *Johann Scotus Erigena* (Munich, 1859); *Idee der Unsterblichkeit* (1861); *Die Proletarier* (1864); *Professor Stöckl in Münster*, and *Offener Brief an Professor Stöckl*, exposing the pantheism of Thomas Aquinas (1864); *Studien* (1867); *Freiheiten der französischen Kirche* (1870); *Das Papstthum und der Staat* (1870); *Die Lehre Darwins kritisch betrachtet* (1870); and *Kleine Schriften* (1871).

**HUBER**, Marie, a Swiss authoress, born in Geneva in 1695, died in Lyons, June 13, 1753. She was the daughter of a merchant, received a scientific education, never married, and spent her whole life in seclusion, study, and charitable labor. Her principal works are: *Système des théologiens anciens et modernes conciliés*

(Geneva, 1731; enlarged ed., 1739); and *Lettres sur la religion essentielle à l'homme* (1739; new ed., enlarged, 6 vols., 1754).

**HÜBER.** I. **Michael**, a German scholar, born at Frontenhausen, Bavaria, in 1727, died in Leipsic, April 15, 1804. He resided in Paris for several years, and went to Leipsic in 1766, where he became a teacher of the French language. He translated into French many poems of Klopstock, Wieland, Lessing, and others (*Choix de poésies allemandes*, 4 vols., Paris, 1766), and other works, among which is Winckelmann's *Kunstgeschichte* (3 vols., Leipsic, 1781), and wrote *Notices générales des graveurs et des peintres* (Dresden, 1787). II. **Ludwig Ferdinand**, son of the preceding, born in Paris in 1764, died near Leipsic, Dec. 24, 1804. In 1798 he became editor of the *Allgemeine Zeitung* in Stuttgart. He translated dramas from the English and French, and wrote a number of plays and collections of tales. He also published *Friedenaprüliminarien* (10 vols., Berlin, 1793-'6). A collection of his later works was published by his widow (4 vols., Tübingen, 1806-'19). III. **Therese**, wife of the preceding, born in Göttingen, May 7, 1764, died in Augsburg, June 15, 1829. She was a daughter of Heyne, and was first married to the traveller Johann Georg Forster, and afterward in 1794 to Huber, under whose name many of her writings were published. In 1819 she became editor of the *Morgenblatt* at Stuttgart, and published *Forster's Briefwechsel* with a biographical sketch (2 vols., Leipsic, 1828-'9). A collection of her *Erzählungen* was published by her son (6 vols., Leipsic, 1830-'33). IV. **Victor Almé**, son of the preceding, born in Stuttgart, March 10, 1800, died at Wernigerode, July 19, 1869. He studied medicine, travelled extensively, and was professor in various places, lastly in 1843 of languages and literature at Berlin, retiring in 1850. As a publicist he opposed the revolutionary movements of 1846-'9, but subsequently left the ranks of the ultra conservatives. His later writings embrace popular politico-economical subjects, but his reputation rests mainly on his works relating to the English and Spanish languages and literature. The more celebrated of them, besides those treating of the history of the Cid, are: *Skizzen aus Spanien* (4 vols., Göttingen, 1828-'35); *Die neuromantische Poesie in Frankreich* (Leipsic, 1833); *Die englischen Unirritäten* (2 vols., Cassel, 1839-'40); and *Reisebriefe aus Belgien, Frankreich und England* (2 vols., Hamburg, 1855). His biography by Elvers was published in 1872.

**HÜBNER, Karl**, a German painter, born in Königsberg, June 14, 1814. He is a disciple of the Düsseldorf school, and excels in *genre* pictures. In 1864 he was appointed professor at Düsseldorf. Many of his works have been brought to the United States.

**HÜBNER, Rudolf Julius Benno**, a German historical painter, born in Prussian Silesia in 1806. He studied in Berlin under Schadow, and fol-

lowed his master to Düsseldorf. Among his earlier works were illustrations of Goethe's ballad of the "Fisherman," and "Orlando delivering Isabella," a scene in Ariosto's epic. He has also gained reputation as a painter of cartoons and portraits. He became a resident of Dresden in 1839, and professor at the academy there in 1841. He sent to the universal exposition of 1867 a historical painting of the "Discussion between Luther and Eck," and two religious paintings, "Jesus at the Age of twelve," and the "Magdalen by the Body of Christ."

**HUC, Évariste Régis**, a French missionary and traveller, born in Toulouse, Aug. 1, 1818, died in Paris, March 31, 1860. He studied theology in his native city, and taught in the seminary there for a while, after which he entered the order of Lazarists, and was ordained priest in Paris in 1839. Resolving to devote himself to the Chinese missions, he set sail from Havre a few days after his ordination, and reached Macao about the month of August. He passed 18 months in the Lazarist seminary at this place, preparing himself for the work he was about to undertake, and in the early part of 1840, shaving his head with the exception of the queue which he had carefully cultivated since his arrival, dyeing his skin, and putting on the Chinese costume, he started from Canton for the interior of the empire. After directing a Christian mission in the southern provinces, he went to Peking, where he perfected himself in the Chinese language, and subsequently established himself at He-Shuy (valley of Black Waters), in Mongolia, just north of the great wall and not far from Peking, where there was a considerable population of Chinese Christians. He visited various parts of Mongolia, acquiring the dialect of the country, and translating into Mongol several books of prayer and instruction. In 1844 the vicar apostolic of Mongolia directed M. Huc and another French Lazarist, Joseph Gabet, to make a journey through the vicariate, for the purpose of ascertaining its extent and studying the character and manners of the Tartars. Adopting the costume of the Thibetan lamas or priests, and accompanied by a young lama convert, named Samdadshiamba, they set out in September, travelling S. W. along the Mongolian side of the great wall. Their caravan consisted of a horse, a mule, and three camels. Their only guides were a map and a compass. At night they slept in tents, and their food during 18 months was generally confined to tea and a little meal. After a few days' journey they arrived at the city of Tolon-noor, where they completed their outfit. At the large new town of Shagan-kooren they crossed the Hoang-ho river and entered the sandy steppes of the Ortoos country, where they suffered for want of water and forage. Crossing the Hoang-ho again with great difficulty at a season of inundation, they entered the N. E. part of the Chinese province of Kansu in the early part of November, and remained two days at a frontier

town. In January, 1845, they reached Tang-kium, on the boundary between Kansu and the territory of Koko-nor. From Lassa, the capital of Thibet, their point of destination, they were yet distant four months' journey across a desert utterly uninhabited except by robbers. They consequently resolved to wait here eight months for the arrival of a Thibetan embassy on its way home from Peking, under whose escort they might travel in safety. During their stay they studied the Thibetan language and Buddhist books with the assistance of a teacher, and after a while they were invited to take up their abode in the famous lamasery of Koonboon, about 30 m. distant. In this establishment, which numbers about 4,000 lamas, they remained three months, treated, as they were in all parts of Mongolia, with great kindness. At the end of that time they removed to Chogortan, a summer establishment belonging to the lamasery. Toward the end of September the embassy arrived, and the missionaries joined the caravan, which consisted of 2,000 men and 3,700 animals. In crossing the desert and climbing the snow-covered mountains over which their route led them, they suffered the most terrible hardships. M. Gabet fell ill and was every moment expected to die, but they were obliged to press on with the sick man fastened to his camel. On Jan. 29, 1846, they entered Lassa. After a few days they were summoned before the *kalon* or regent, the real ruler of the country under the nominal supremacy of the grand lama, who received them well, gave them a residence of his own, and allowed them to preach and set up a little chapel. The Chinese ambassador, Kshen, who had conducted the negotiations with the British at Canton in 1840-41, soon interposed on political grounds, and they were sent to Chingtoofoo, capital of the Chinese province of Sechuen, and their neophyte Samtschidamba back to his own country. MM. Hue and Gabet left Lassa March 15, and traveled in palanquins with great state, having a mandarin and a body of soldiers for escort. They wore the richest Chinese robes, and insisted upon putting on the yellow cap and red sash reserved for members of the imperial family. These precautions secured respectful treatment throughout their journey. Their expenses were defrayed by government. At Chingtoofoo they were put on trial, and it was resolved to send them to Canton. The journey was performed in the same state, sometimes overland, sometimes on the Yangtse-kiang and other navigable rivers. In October, 1846, they arrived at Canton, and soon went to the Lazarus seminary at Macao. Here M. Hue remained between two and three years, arranging for publication his notes of travel. M. Gabet returned to Europe in November, and thence proceeded to South America, where he died soon afterward at Rio de Janeiro. In 1849 M. Hue set out for Peking, intending to revisit his missions in Mongolia; but an inundation

obliged him to remain six months at a Christian station in the province of Chekiang, and shortly after his arrival at the capital the shattered state of his health induced him to return home. He sailed from Macao Jan. 1, 1852, visited Ceylon, India, Egypt, Palestine, and Syria, and landed at Marseilles in June of the same year. He subsequently fixed his residence in Paris. His *Souvenirs d'un voyage dans la Tartarie, le Thibet et la Chine* appeared in 1852 (2 vols. 8vo, Paris), and was translated into English by William Hazlitt (London, 1852). This work is not only one of the most interesting books of travel which have been written during the present generation, but is stored with valuable information with regard to the history, inhabitants, and geography of the previously almost unknown region of Mongolia. *L'Empire chinois* (2 vols. 8vo, 1854; English translation, London, 1855) relates the adventures of the missionaries during their journey from Lassa to Canton; it is written in an attractive style, enlivened with much humor, and a large part of it is devoted to a general account of the manners, customs, government, laws, and internal condition of the Chinese empire. He also wrote *Le Christianisme en Chine, en Tartarie et au Thibet* (4 vols., 1857-'8; translated into English, 3 vols.).

**HUCKLEBERRY.** See WHORTLEBERRY.

**HUDDERSFIELD**, a market town and parliamentary borough of England, in the West riding of Yorkshire, on the Colne, 35 m. S. W. of York, and 204 m. by railway N. N. W. of London; pop. in 1871, of the borough, 70,253, of the town, 38,658. There are in the town 34 places of worship, of which 9 belong to the established church, 5 to the Congregationalists, and 14 to the Methodists. There are two colleges, a philosophical hall, and a mechanics' institute. It is connected by canals with the Mersey and the Humber. It is one of the chief seats of the woollen manufacture in England, of which nearly every variety is produced. It has an extensive cloth hall, where a fair is held each Tuesday attended by upward of 600 manufacturers. There are also cotton mills, breweries, chemical works, and dye houses.

**HUDSON**, a N. E. county of New Jersey, bounded E. by the Hudson river and New York bay, S. by the Kills, separating it from Staten island, S. W. and W. by Passaic river and Newark bay, and N. W. by the Hackensack, which also intersects the S. W. part; area, 75 sq. m.; pop. in 1870, 129,067. It has a diversified surface, rising into hills on each side of the Hackensack. Limestone, copper, and magnetic iron ore are found. The Morris canal passes through it, and numerous railroads radiate from Jersey City and Hoboken. The value of farms in 1870 was \$3,134,000; of farm productions, chiefly market vegetables, \$312,920. There were 333 manufacturing establishments, with an aggregate capital of \$3,280,526, and an annual product of \$24,256,017. The most important were 1 manufactory of boxes,

19 of bread, &c., 1 of cars, 25 of clothing, 1 of cooperage, 3 of crucibles, 2 of drugs and chemicals, 1 of feathers, 3 of gas, 1 of heating apparatus, 1 of India-rubber goods, 11 of iron, 3 of jewelry, 11 of machinery, 5 of marble and stone work, 2 of molasses and sirup, 4 of oakum, 1 of castor oil, 2 of paints, 2 of paper, 1 of polishing preparations, 3 of silk goods, 4 of soap and candles, 3 of steel, 8 of tin, copper, and sheet-iron ware, 37 of cigars, 1 of watches, 1 flour mill, 4 breweries, 2 saw mills, and 4 pork-packing establishments. Capital, Jersey City.

**HUDSON**, a city and the capital of Columbia co., New York, situated on the E. or left bank of the Hudson river, at the head of ship navigation. 116 m. above New York city and 29 m. below Albany; pop. in 1850, 6,280; in 1860, 7,187; in 1870, 8,615. It is beautifully situated on rising ground, and presents a highly picturesque appearance, especially when seen from the river at a distance. A slate bluff rises abruptly from the water to a height of 60 ft., whence a ridge slopes upward for  $1\frac{1}{2}$  m., terminating in Prospect hill, 500 ft. above the river. The principal street runs along this ridge, from Prospect hill to a public square laid out on the summit of the bluff. The city is divided into four wards, and is regularly laid out, with streets crossing each other at right angles. The principal public buildings are the court house, a handsome marble and limestone building, 116 ft. long and 60 ft. high, surmounted by a dome and faced by an Ionic portico, and the city hall, a brick edifice, containing the post office. Hudson is a terminus of the Hudson and Boston railroad, and an important station on the Hudson River railroad. It has regular steamboat communication with Albany and New York; and from Athens on the opposite bank of the river, with which it is connected by a steam ferry, a branch of the New York Central railroad extends to Schenectady. The wharves are built on two bays at either side of the public square, and are accessible by large ships. It is said that at one time Hudson owned a larger amount of shipping than New York. It was made a port of entry in 1795, had an extensive commerce with the West Indies and Europe, and owned a number of whaling and fishing vessels. Its commerce was destroyed during the embargo and the war of 1812; and although the whaling business was resumed, it has since been entirely abandoned. Its trade, however, is still important, the principal article of export being pressed hay for the New York market. The chief manufactures are of iron. The Hudson iron company and the Columbia iron works together turn out from 60 to 75 tons of pig iron per day. There are two machine shops, two iron foundries, a stove foundry, manufactories of steam fire engines, paper car wheels, tiles, and pianos, six carriage factories, two breweries, three rectifying establishments, knitting mills, a spoke factory, a pump and block factory, a tannery, a flour mill, three national

banks with a capital of \$750,000, a savings bank, and 10 hotels. The city is lighted with gas, is supplied with drinking water through iron pipes from a spring 2 m. distant, and has an efficient fire department. There are 8 public schools with about 1,000 pupils, an academy, three public libraries, two daily and three weekly newspapers, an orphan asylum, and 10 churches.—Hudson, originally known as Clav rack Landing, was settled in 1783. It was incorporated as a city in 1785. A lunatic asylum was established here in 1832, but given up on the opening of the state asylum at Utica.

**HUDSON**, a township and village of Summit co., Ohio, at the junction of the Cleveland and Pittsburgh and the Cleveland, Mt. Vernon, and Columbus railroads, 25 m. S. by E. of Cleveland and 120 m. N. E. of Columbus; pop. in 1871, 1,520. The village is pleasantly situated and neatly built. It is the seat of the Western Reserve college, chartered in 1826, which has handsome grounds and five substantial college halls. In 1872-'3 the academical department had 8 professors and instructors, 52 students and a library of 10,000 volumes; the preparatory department had 2 instructors and 47 pupils. The medical department (Cleveland medical college) is in Cleveland; it was founded in 1843, and in 1871-'2 had 14 professors and instructors, 76 students, and a library of 6,000 volumes. There is also a female seminary.

**HUDSON, Henry**, a British navigator and discoverer, born about the middle of the 16th century. He was first employed by a company of London merchants to search for the N. W. passage in 1607, when he sailed in a small vessel with a crew of only ten men and a boat to the E. coast of Greenland, lat. 80°, where he was stopped by ice. After three months of fruitless exploration he returned to England whence he sailed again, April 21, 1608, hoping to find the passage between Nova Zembla and Spitzbergen, but was again hindered by ice, not being able to get to the eastward of the former land. On April 6, 1609, he began another voyage to the N. E. of Asia, sailing from Amsterdam in the service of the Dutch East India company. His crew being unable to endure the climate, he sailed for Davis strait but came to the American coast in lat. 44° Sailing S., he discovered the mouth of the river which has received his name. Having sailed up the river to the head of navigation and explored it in a boat for some miles further, he afterward followed the coast S. as far as Chesapeake bay, he returned to England. In April 1610, he began his fourth voyage with 23 sailors, passing in June and July through the strait and into the bay which now bears his name. Finding, however, that this did not give him an open route westward, he resolved to winter there and resume explorations in the spring. His provisions ran short, and he was compelled to return. It is said that he incautiously declared that in their destitute condition he would have to leave some behind, and in a mutiny he

was seized and placed with his son and seven others who remained faithful to him in an open boat, and abandoned. His fate was revealed by one of the mutineers, and an expedition was sent from England in quest of him, but no trace of him was ever discovered. "A Collection of Documents forming a Monograph of the Voyages of Henry Hudson," edited, with an introduction, by George Asher, was published in London by the Hakluyt society in 1860. See also "Historical Inquiry concerning Henry Hudson," by J. M. Read, jr. (Albany, 1866).

**HUDSON, Henry Norman**, an American essayist, born in Cornwall, Vt., Jan. 28, 1814. His early youth was passed on a farm; from his 18th to his 21st year he lived in Middlebury as an apprentice at the trade of coachmaking, during which time he prepared himself for college. He graduated at Middlebury college in 1840, and went to Kentucky, where he remained a year engaged in teaching, an occupation which he subsequently followed for two years in Huntsville, Ala. Having during this time applied himself especially to the study of Shakespeare, he wrote and delivered at Huntsville a course of lectures on the great dramatist, which he subsequently delivered in different parts of the country, and finally printed (2 vols. 12mo, New York, 1848). In 1844 he became a communicant of the Episcopal church, and was ordained to the priesthood in New York in 1849. He has since edited the works of Shakespeare (11 vols. 12mo, Boston, 1850-57), and for a short time edited the "Churchman." He was pastor of the Episcopal church in Litchfield, Conn., in 1859 and 1860. In the winter of 1860-61 he delivered a new course of Shakespearean lectures. During the civil war he was a chaplain in the army, and subsequently taught school in Boston, and for two years edited the "Saturday Evening Gazette." He has published "A Chaplain's Campaign with the Rebels" (1865), a "School Shakespeare" (1867), "Shakespeare, his Life, Art, and Character" (1872), and "Sermons" (1874).

**HUDSON, Jeffery**. See DWARF.

**HUDSON BAY**, an inland sea of British North America, between lat. 51° and 64° N., and lon. 77° and 105° W. It is of irregular shape, 850 m. long N. and S., and 600 m. broad. Its S. extremity is called James bay. In its mouth, at the northeast, lies Southampton island; out of it it communicates with Davis strait between the arms of Hudson strait, and E. of Southampton island Fox channel extends N. The shores are generally high, rocky, and rugged. The depth of the middle of the bay has been taken at 150 fathoms, but it is probably more. Southampton island is formed of high rocky hills and seems to be composed of several small islands separated by straits, always closed in winter time. There are many other islands, with many reefs and sand banks. The principal rivers flowing into the bay are the Great Whale river, on the E. coast; the Main, Abitibi, Moose, and Albany, into James bay; and

the Weenisk, Severn, Hayes, Nelson, Churchill, and Seal, on the W. coast. It was formerly supposed that there were two tides in the bay, one from the east and another from the west; and this error led to the belief in a channel communicating with the western sea, which was thought to be not far distant. Navigation is possible only during two months, the bay being completely frozen over or obstructed by drift ice during the rest of the year. Before the navigation of the bay was understood, it was usual to take two seasons for a voyage from England; and the captain who succeeded in returning the same year was awarded a prize of £50. Accounts differ as to the abundance of fish in Hudson bay. The Hudson bay company gave little attention to fisheries, yet the white whale is found there, and the whale fishery was once of considerable importance.

**HUDSON BAY TERRITORY**. See NORTHWEST TERRITORIES.

**HUDSON RIVER**, in New York, one of the most beautiful and important rivers in the United States. Its remote sources are in the Adirondack mountains, in the N. E. part of the state, more than 4,000 ft. above the sea. Its principal head streams rise in Hamilton and Essex cos., serving as the outlets to a great number of small highland lakes. Several of these streams unite in the S. W. part of Essex co., and the river formed by their junction flows in a tortuous course S. E. to about the centre of Warren cos., where it receives the outlet of Schroon lake on the east, about 8 m. W. of the S. part of Lake George. It runs from this point nearly S. to the town of Corinth, on the boundary between Warren and Saratoga cos., receiving on its way the Sacondaga river from the west, and some smaller streams, and then turns sharply to the east, following that general direction with several bends until it reaches Glen's Falls, where it has a fall of 50 ft. Soon after passing this point it sweeps around to the south, and flows in that direction with little deviation to its mouth, a distance of about 190 m., separating Washington, Rensselaer, Columbia, Dutchess, Putnam, Westchester, and New York cos., on the east, from Saratoga, Albany, Greene, Ulster, Orange, and Rockland cos., and the state of New Jersey on the west. From Glen's Falls to Troy its course is much broken by rapids, but at the latter place, 151 m. from its mouth, it is affected by the tide and becomes a broad, deep, sluggish stream. From Albany, 6 m. below Troy, its general width is from 300 to 700 yards, though it greatly exceeds this in certain places. Its banks are elevated and picturesque throughout nearly its whole course. The upper part of the river is bordered by gentle eminences, covered with cultivated fields, interspersed with pleasant towns and villages, while in Greene and Ulster cos. its valley is bounded W. by the Catskill mountains, which in the former approach within 7 m. of the river. A short distance below Newburgh, 61 m. from New York, it begins its passage through



ceded to the French, but has never been occupied by them.

**HUELVA.** I. A S. W. province of Spain, forming the W. extremity of Andalusia, bordering on Portugal, the Atlantic, and the provinces of Cadiz, Seville, and Badajoz; area, 4,118 sq. m.; pop. in 1870, 196,469. The larger portion of the province is a picturesque mountain land, being traversed by a continuation of the Sierra Morena, known as the Sierra de Aroche. It is but little cultivated and thinly peopled. It has mines of copper, iron, lead, and coal, salt works, and mineral springs. The copper mines on the Rio Tinto are celebrated. The chief rivers are the Guadiana, which forms part of its western frontier, and the Tinto. The principal towns, besides the capital, are Moguer, Ayamonte, Cartaya, La Palma, Valverde del Camino, and Aracena. II. A town, capital of the province, situated on a peninsula between the mouths of the Tinto and the Odiel, 50 m. W. S. W. of Seville; pop. about 10,000. It has broad, clean streets, two churches, two hospitals, a high school, a theatre, barracks, a beautiful promenade, and an ancient aqueduct. Copper is largely exported, and there is a brisk coasting trade with Cadiz and Seville. It is the site of the ancient *Urbs* of which considerable remains exist.

**HUERFANO,** a S. county of Colorado, drained by a river of the same name; area, about 5,000 sq. m.; pop. in 1870, 2,250. The surface is generally mountainous. The land along the Huertano and its branches is fertile, and Indian corn grows well, but stock raising is the chief industry. Some gold and silver is found in the mountains. The Denver and Rio Grande railroad traverses the county. The crop productions in 1870 were 5,597 bushels of wheat, 23,080 of Indian corn, 2,170 of oats, 20,777 lbs. of wool. There were 281 horses, 1,087 milch cows, 2,349 other cattle, 17,4 sheep, and 413 swine. Capital, Buñito.

**HUESA.** I. A province of Spain, in Aragon, bordering on France and the provinces of Lérida, Saragossa, and Navarre; area, 5,872 sq. m.; pop. in 1870, 274,623. The N. part, which is crossed by offsets of the Pyrenees, is rugged and mountainous; but the S. is level and fertile. The principal rivers are the Cinca, Alcanar, Isuela, Gallego, and Aragon, all tributaries of the Ebro. Wine, oil, and cattle are raised. Iron, copper, and lead are found, and there is little mining. The manufactures are linen, woollen, and hempen fabrics. The principal towns are Huesca, Barbastro, Fraga, Monzon, and Jaca. II. A town, capital of the province, on the Ebro, 67 m. N. E. of Saragossa; pop. about 10,000. It is a place of great antiquity. Scarcely a hundred years ago a college for the instruction of Spanish youth in Greek and Roman literature. Julius Cæsar raised it to the dignity of a *colonia*, and honored it with the title of *Augusta* *Victrix*. In 1096 Pedro I. of Aragon recovered this city from the Moors,

who called it Weshha, and annexed it to his dominions. It is the seat of a bishop, has a beautiful Gothic cathedral, four churches, an episcopal seminary, two colleges, a theatre, and barracks. The university, which was founded by Pedro IV. of Aragon in 1354, has recently been abolished. The industry is confined to tanning and weaving of coarse linen.

**HUET, Pierre Daniel,** a French scholar, born in Caen, Feb. 8, 1650, died in Paris, Jan. 26, 1721. He studied at Caen and Paris, and travelled in Holland and Sweden in 1652. In 1670 he was appointed by the king sub-preceptor under Bossuet of the dauphin, and he directed for his royal pupil the preparation of the Delphin edition of the classics (*ad usum Delphini*). He was received into the French academy in 1674, became bishop of Avranches in 1680, resigned that office after ten years, and soon afterward entered an establishment of the Jesuits at Paris. His principal works are: *De Interpretatione* (Paris, 1661); *Lettre sur l'origine des romans* (1670), full of curious researches; *Demonstratio Evangelica* (1679); *Censura Philosophiæ Cartesianæ* (1689), in which he appears as an opponent of Cartesianism; *Histoire du commerce et de la navigation des anciens* (Lyons, 1716); and *Traité philosophique de la faiblesse de l'esprit humain* (Amsterdam, 1723), which caused him to be classed among skeptics. He wrote memoirs of his life in Latin (1718; French translation by Charles Nisard, Paris, 1853). His complete works appeared in 1856, in 6 vols.

**HUFELAND, Christoph Wilhelm,** a German physician, born at Langensalza, Thuringia, Aug. 12, 1762, died in Berlin, Aug. 25, 1836. He studied at Jena and Göttingen, graduated as M. D. in 1783, and was appointed professor of medicine at Jena in 1793. In 1798 he removed to Berlin, and after the establishment of the university of Berlin (1809) he became professor there of special pathology and therapeutics. His work on the art of prolonging life (*Makrobiotik, oder die Kunst das menschliche Leben zu verlängern*, Jena, 1796; 8th ed., Berlin, 1860) was translated into several European languages. Among his other works is one on scrofulous diseases (*Ueber die Natur, Erkenntnismittel und Heilart der Skrophelkrankheit*, Jena, 1795). His work on the physical training of infants (*Guter Rath an Mütter über die wichtigsten Punkte der physischen Erziehung der Kinder in den ersten Jahren*, Berlin, 1799; 10th ed., 1866) produced many reforms in the system of education; while his *Enchiridion Medicum* (Berlin, 1836; 10th ed., 1857), which gives the experiences of his 50 years of practice, is still consulted. His *System der praktischen Heilkunde* (Jena and Leipsic, 1800-55), and his *Geschichte der Gesundheit* (Berlin, 1812), are much esteemed. He introduced the system of mortuary houses for the prevention of burying alive, the first of which was erected at Weimar under his superintendence; and endowed charitable institutions for poor physicians and phy-



described without. His art history, published by Cassell, was published in 1894.

**HÜGEL, Karl Alexander Anselm**, Baron, a German travel writer, born in Fürstentum, Aug. 25, 1817; died in Bremen, June 2, 1877. He studied law in the university, served as an Austrian officer in 1848-49, and held an appointment in the embassy sent to Prince Christian, the temporary king of Norway, to resign. In 1851 he went in a diplomatic capacity to Naples, and afterward lived several years in Vienna. In 1851 he set out to visit Greece, Asia Minor, Egypt, Barbary, and remote portions of India and central Asia. He returned to Europe in 1857, bringing with him a collection illustrating ethnography and natural history, as well as antique coins, manuscripts, jewelry, paintings, and silver vessels. The whole collection was purchased for the imperial museum in Vienna. He wrote *Botanisches Archiv* (Vienna, 1837); *Kashmir und das Reich der Sikhs* (4 vols., Stuttgart, 1840-42); and *Das Ländchen von Kabul* (2 vols., Vienna, 1851-2).

**HUGER, I. Isaac**, an American revolutionary general, born at Limerick plantation, S. C., March 19, 1742; died in Charleston in November, 1797. He was one of five patriot brothers active in the revolution. Their parents were wealthy, and the sons completed their education in Europe. Isaac first served under Col. Middleton in the expedition against the Cherokees in 1769. He was made lieutenant colonel of the 1st South Carolina regiment, June 17, 1775, and subsequently colonel of the 5th regiment; took a conspicuous part in the engagements connected with the siege of Savannah in 1778; was made a brigadier general Jan. 19, 1779; commanded a force of cavalry at the siege of Charleston in 1780, which was surprised and dispersed by Tarleton; and commanded the Virginia brigade which formed the right wing in the battles of Guilford Court House, March 15, 1781, and Hobkirk's Hill, April 25, 1781. **II. Francis Kinloch**, an American officer, nephew of the preceding, born in 1764; died in Charleston, S. C., Feb. 15, 1855. His father, Major Benjamin Huger, was killed before the lines of Charleston in 1779. After being a pupil of Dr. John Hunter, and a fellow student of Dr. Physick in Philadelphia, he joined with Dr. Eric Bollmann in a daring but unsuccessful attempt to rescue Lafayette from Olmütz. (See BOLLMANN.) Huger was arrested and for eight months kept in severe confinement. He returned home, and in 1798 became a captain in the army, was a colonel in the war of 1812, and served in both branches of the legislature of his state. **III. Benjamin**, son of the preceding, born in Charleston in 1806. He graduated at West Point in 1825, and was commander at Fortress Monroe from 1841 to 1846. He served as chief of ordnance to Gen. Scott in the Mexican war, was successively brevetted as major, lieutenant colonel, and colonel, and from 1854 to 1860 was in command of the arsenal at Pikesville, Md. He resigned

his commission in April, 1861, entered the Confederate service, and was soon made major general. His conduct during the campaign on the peninsula was severely censured, and he was banished from active service soon after.

**HUGGINS, William**, an English astronomer, born in London, Feb. 7, 1804. He was educated at the city of London school, and by private tutors, and devoted himself successively to natural philosophy, astronomy, and microscopy, attaining great proficiency in each. In 1827 he erected an observatory near his residence at Upper Tulse hill, furnishing it with a transit instrument and an equatorial of 8 in. aperture manufactured in Cambridge, Mass. At first he was occupied with observations of double stars, and he also made drawings of Mars, Jupiter, and Saturn; but later he gave almost his entire attention to the application of spectrum analysis to the examination of comets and nebulae, and his most valuable achievements have been in this field. In 1862, as a preliminary task, he spent several months in mapping the spectra of 26 chemical elements; the results are published in the "Philosophical Transactions" for 1864. In his prismatic observation of the stars he was assisted by Dr. William A. Miller, and the gold medal of the royal astronomical society was awarded to them jointly in 1867. Mr. Huggins having received one of the royal medals in 1866. He has proved that the proper motion of a star in the line of sight can be determined by any small change of position in the lines of the spectrum, and thus he calculates that Sirius is moving away from the earth at the rate of 27 m. a second. He has made valuable observations on the solar prominences, showing how their forms may be seen, and has detected the heat received at the earth from some of the fixed stars. In 1869 he delivered the Rede lecture at Cambridge, in which he gave an account of his discoveries. In 1871 the royal society placed at his disposal a telescope of 15 in. aperture, which was placed in a new observatory at Upper Tulse hill. For an account of his observations of the spectra of comets, see COMET, vol. v., p. 141.

**HUGH CAPET**, king of France and the founder of the Capetian dynasty, born about 940; died Oct. 24, 996. When still a child he inherited from his father, Hugh the Great, the duchy of France and the county of Paris, thus taking rank among the most powerful princes of his country. On the death of Louis V., the last of the Carolingian kings, a number of nobles and bishops from all parts of the country assembled at Senlis to settle the succession, and selected Hugh Capet in preference to the Carolingian duke Charles of Lorraine, the uncle of the late king. Hugh was consequently crowned at Noyon, July 3, 987, by the archbishop of Rheims. Notwithstanding this election, Charles supported his claims to the crown of France by the sword, and after four years' hostilities was apparently on the point of suc-

ceeling, when he was treacherously made prisoner by Adalbéron, bishop of Laon, who delivered him to his rival. The unfortunate prince was sent to Orleans, where he soon breathed his last in a dungeon. Hugh, having thus secured possession of the crown, associated his son Robert in the government, which he settled on the principle of hereditary succession. (See CAPETIANS.)

**HUGHES, Ball**, an American sculptor, born in London, England, Jan. 19, 1804, died in Boston, Mass., March 5, 1868. When only 12 years old he made out of wax candle ends a bas-relief copy of a picture representing the wisdom of Solomon, which was afterward cast in silver. He spent seven years in the studio of Edward Hodges Bailey, and competed successfully for the prizes awarded by the royal academy and the society of arts and sciences. Among his works at this period, besides several ideal statues, were busts of George IV. and the dukes of Sussex, York, and Cambridge. In 1829 he emigrated to New York, where he executed a marble statue of Hamilton, which was destroyed in the merchants' exchange, in the great fire of 1835. He also made a monumental alto-relief, of life size, in memory of Bishop Hobart, which is now in Trinity church. Several of his casts are in the Boston atheneum, and his bronze statue of Nathaniel Bowditch is in Mt. Auburn cemetery, Cambridge, Mass. He also appeared as a lecturer on art.

**HUGHES, John**, an American archbishop, born near Clogher, county Tyrone, Ireland, in 1797, died in New York, Jan. 3, 1864. He was, in his own words in his well known letter to Mayor Harper, "the son of a farmer of moderate but comfortable means." Being the youngest of three sons, he was allowed to indulge in an early passion for books, and was sent for a time to a Latin school. In 1816 his father came to the United States. John followed him in 1817, and in 1818 the whole family settled near Chambersburg, Pa. Toward the end of that year John obtained admission to the college of Mount St. Mary's, at Emmettsburg, Md. "I was to superintend the garden," he afterward wrote, "as a compensation for my expenses, until I might be appointed teacher, presenting meanwhile my studies under a private tutor." Toward the close of 1825 he was ordained priest, and placed in charge of a small mission at Bedford, Pa. A few weeks afterward he was appointed pastor of St. Joseph's church, Philadelphia, where he soon gained reputation as a pulpit orator. On May 31, 1822, he preached a sermon on Catholic emancipation, which was published in pamphlet form and dedicated to O'Connell. In 1830 he accepted a challenge from the Rev. John Breckenridge, D. D., a distinguished Presbyterian clergyman, to discuss through the press the question, "Is the Protestant religion the religion of Christ?" In 1831-'2 he built St. John's church, Philadelphia, of which he was the rector as long as he remained in that city. In 1834

he accepted a second challenge from Dr. Breckenridge to a public oral discussion of the question, "Is the Roman Catholic religion hostile to liberty?" The debate created much interest, was brought to an unsatisfactory termination, and afterward appeared in book form. Mr. Hughes was appointed coadjutor bishop of New York in 1837, received episcopal consecration Jan. 7, 1838, and in 1839 became administrator of the diocese, which then comprised the entire state of New York and part of New Jersey, with a Catholic population of 200,000, and only 40 clergymen. He forthwith set to work to remedy the evils springing from the "trustee system" of holding church property. The titles were vested in laymen, who frequently came into conflict with the episcopal authority, and were sometimes supported in their opposition by priests suspended from their office. Several churches had in consequence been closed to divine worship; most of them had become deeply involved in debt, and of the eight churches in New York city, five were on the point of being sold. Bishop Hughes set about consolidating these debts, removing the lay trustees, and securing the titles in his own name. In spite of every obstacle he succeeded, and thus put an end to scandalous contentions. He next purchased a large property at Fordham, Westchester co., with the intention of opening there a college and theological seminary. For the purpose of obtaining money and the aid of religious communities for the institutions which he planned, he went to Europe in 1839. During his absence the Catholics of New York set up an organized opposition to the public school system. To prevent this movement from becoming a purely political one, Bishop Hughes on his return took himself the lead, and drew up a petition to the common council praying, in the name of the Catholic citizens, that seven parochial schools should be designated as "entitled to participate in the common-school fund, upon complying with the requirements of the law." Remonstrances to this petition were sent in by the public school society and the pastors of the Methodist Episcopal church, and on Oct. 29 both parties appeared before the common council. Bishop Hughes met and answered, for several days in succession, the array of eminent counsel opposed to him, and supported his petition in an elaborate speech; but his demands were rejected by the common council. The matter was then brought before the legislature; but being baffled in his suit there, he recommended Catholics to nominate independent candidates in the ensuing elections; a movement which developed such unexpected strength that a modification of the school system was soon afterward effected. In 1841 he was able to open regular courses of classical and theological instruction in St. John's college, Fordham. In 1842, after the death of Bishop Dubois, Dr. Hughes succeeded him as titular bishop of New York. In August of

that year was held the first diocesan synod of New York, whose decrees on secret societies and the tenure of church property were published officially by the bishop in September; and this legislation was further supplemented by the publication in 1845 of "Rules for the Administration of Churches without Trustees." On March 10, 1844, he consecrated as his coadjutor the Rev. John McCloskey, D. D. During the spring and summer of this year fears were entertained of anti-Catholic riots in New York, such as had taken place in Philadelphia. Bishop Hughes thereupon addressed a letter to Mayor Harper, which calmed the public excitement, and in a series of letters denounced the editor of the "New York Herald" for attacks on himself. A second visit to Europe in December, 1845, enabled him to secure the services of the Jesuits, Christian brothers, and sisters of mercy. On his return he was solicited by President Polk to accept a peace mission to Mexico, which he declined. In 1847 he delivered in the hall of representatives at Washington, by request of both houses of congress, a discourse on "Christianity, the only Source of Moral, Social, and Political Regeneration." During this year his diocese was divided by the creation of the sees of Albany and Buffalo. In 1850 the see of New York was raised to metropolitan rank, and Bishop Hughes received the pallium as archbishop in Rome at the hands of the pope. In 1853 the sees of Brooklyn, Burlington, and Newark were erected, and the new bishops were consecrated by the nuncio, Archbishop (afterward Cardinal) Bedini, Oct. 30. Archbishop Hughes presided in 1854 over the first provincial council of New York; was in Rome at the proclamation of the dogma of the immaculate conception, Dec. 8; and on his return was involved in a controversy with Mr. Erasmus Brooks, the letters on both sides being published in a volume entitled "Brookiana." On Aug. 5, 1855, he laid the corner stone of a new cathedral on Fifth avenue, New York, the largest yet planned in the United States. In the preceding autumn, while accompanying the nuncio to Canada, he was seized with lung fever, from the effects of which he never wholly recovered. He persisted nevertheless in the discharge of his daily duties, causing himself toward the end of his life to be carried to the altar when conferring confirmation. At the breaking out of the civil war, and before active operations had begun in Virginia, Archbishop Hughes, though in very feeble health, went to Washington to proffer the aid of his priests, sisters of charity, and sisters of mercy. In November, 1861, at the solicitation of President Lincoln, he went to Europe in company with Mr. Thurlow Weed, in order to secure the friendly neutrality of some governments, particularly of the French court. After visiting France and Italy, he preached at the laying of the corner stone of the Catholic university of Dublin, June, 1862. He ap-

peared at the New York academy of music in April, 1863, to make an appeal in favor of the famishing Irish, and in July made his last public address to quell the draft riots. Thenceforward his strength steadily declined until his death. His works have been published by L. Kehoe (2 vols., New York, 1864-'5); and his life has been written by John R. G. Hassar (8vo, New York, 1866).

**HUGHES, Thomas**, an English author, born near Newbury, Berkshire, Oct. 20, 1823. He was educated at Rugby, and graduated at Oriel college, Oxford, in 1845. He studied law, was called to the bar in 1848, and became queen's counsel in 1869. From 1865 to 1868 he was liberal member of parliament for the borough of Lambeth, and from 1868 to January, 1874 for the borough of Frome, which was not contested by the liberals in the election of February, 1874, and consequently a conservative took his place. While in parliament he supported the bills for the disestablishment of the Irish church, and for secularizing the universities, abolishing tests, and admitting dissenters to fellowship in Oxford and Cambridge. He took an active interest in educational and social questions and in all measures for the improvement of the laboring classes. In 1866 and 1870 he visited the United States, lecturing in the principal cities, and was well received. He is the author of "Tom Brown's School Days," a graphic description of life at Rugby school under Dr. Arnold (1856); a sequel to it entitled "Tom Brown at Oxford" (1861); "The Scouring of the White Horse" (1858); "Religio Laici," a semi-theological essay (1862); "Alfred the Great" (1869); and "Mémorial of a Brother" (1873). He has also written critical prefaces to English editions of a work on "Trades Unions" by the count de Paris Lowell's "Biglow Papers," and the poems of Walt Whitman.

**HUGHES**, a S. county of Dakota, bounded S. W. by the Missouri, recently formed and not included in the census of 1870; area, about 800 sq. m. It is intersected by East Medicine Knoll river, and watered by several small affluents of the Missouri.

**HUGO, Gustav**, a German jurist, born at Lörrach, Baden, Nov. 23, 1764, died in Göttingen Sept. 16, 1844. He studied at Göttingen from 1782 to 1785, and first became known by his edition of the "Fragments of Ulpian" (Göttingen, 1788). In 1788 he was appointed professor extraordinary and in 1792 regular professor of law at the university of Göttingen. He was one of the first to follow the example of Leibnitz and of Pütter, presenting the Roman law classified with reference to the principal eras of its history. His principal works are: *Lehrbuch der Geschichte des römischen Rechts* (Berlin, 1790; 9th ed., 1824); *Lehrbuch eines civilistischen Cursum* (7 vols., 1799-1812); and *Beiträge zur civilistischen Bücherkenntnis des letzten vierzig Jahre* (2 vols., 1829). He edited the *Civilistische Magazin* from 1814 to 1837.

**HUGO, Victor Marie**, a French poet and novelist, born in Besançon, Feb. 26, 1802. The son of an officer whose military duties called him out of France, he was carried in childhood to Elba, Corsica, Switzerland, and Italy. In 1809 he was taken to Paris; and here for two years, under the exclusive supervision of his mother and the care of an old priest, he commenced his classical studies in company with an elder brother, Eugène, and a young girl who afterward became his wife. In 1811, his father having been made general and appointed major-domo of Joseph Bonaparte, the new king of Spain, Victor went to Madrid, and entered the seminary of nobles with a view of becoming one of the pages of Joseph; but subsequent events defeated this design. In 1812 Mme. Hugo returned to Paris with her two sons, and had their classical education continued by the same clergyman who had already instructed them. On the fall of the empire a separation took place between the general and his wife; and thenceforth the young man was placed entirely under the control of the former. He entered a private academy to prepare himself for admission to the polytechnic school. Here he evinced some taste and ability for mathematics, but a much stronger inclination toward poetry; and his first poems gave promise of such talent that his father was finally persuaded to allow him to follow literature as his vocation. In 1817 he presented to the French academy a poem on *Les avantages de l'étude*. He afterward won three prizes in succession at the Toulouse academy of floral games. His first volume of *Odes et ballades* (1822) created a sensation. Two novels, *Han d'Islande* (1823) and *Bug-Jargat* (1825), exhibited him as an original and forcible prose writer, but already displayed the predilection for the horrible and monstrous which characterizes most of his greater productions. His second volume of *Odes et ballades* appeared in 1826. About this period, in conjunction with Sainte-Beuve, Antoine and Émile Deschamps, A. de Vigny, Bouffé, the painter, and David the sculptor, he formed a kind of literary association, called the *Club*, in the meetings of which new literary and artistic doctrines were debated. They also established a periodical, called *La revue française*, which attracted little attention. The drama of *Cromwell* (1827), although unprofitable for the stage, was presented as a specimen of the literary reforms aimed at by the generation; but it had much less importance than the preface, which was a treatise on aesthetics. Thenceforth Victor Hugo was the acknowledged leader of the romanticists, who waged earnest war against their opponents, the classicists. His claims to this distinction were strengthened in 1828 by the publication of *Les orientales*. *Le dernier jour d'un condamné*, which followed, fascinated the public by its vivid delineation of the mental tortures of a man doomed to execution. The contest

between the two opposite schools reached its climax when, on Feb. 26, 1830, the drama of *Hernani* was produced at the Théâtre Français. In 1831 Hugo won another dramatic triumph with *Marion Delorme*, while his lyrical poems *Les feuilles d'automne* and his novel *Notre Dame de Paris* were received with enthusiasm. The performance of his dramas, *Le roi s'amuse* (1832), *Lucrece Borgia* and *Mariae Tudor* (1833), *Angelo, tyran de Padoue* (1835), *Ruy Blas* (1838), and especially *Les burgraves* (1843), drew forth marked approbation; his political poems, *Les chants du crépuscule* (1835), *Les voix intérieures* (1837), and *Les rayons et les ombres* (1840), were highly popular; and his miscellaneous writings, *Claude Gueux*, *Étude sur Mirabeau*, *Littérature et philosophie mêlées* (1834), and *Le Rhin* (1842), were scarcely less successful. His literary reputation had secured his election to the French academy in 1841, notwithstanding the opposition of the members attached to the old classic school; and having thus reached the highest distinction in literature, he now indulged in political aspirations, which were partly gratified by his being created in 1845 a peer of France by King Louis Philippe. On the revolution of February, 1848, he was elected a deputy to the constituent assembly, where he generally voted with the conservative party. On his reelection to the legislative assembly, he evinced more democratic and socialistic tendencies. In vehement speeches he denounced the reactionary tendencies of the majority, and the secret policy of President Louis Napoleon. On the *coup d'état* of Dec. 2, 1851, Hugo was among those deputies who vainly attempted to assert the rights of the assembly and to preserve the constitution. His conduct led to his proscription; he took refuge in the island of Jersey, where, while resuming his literary pursuits, he continued his opposition to Louis Napoleon, publishing *Napoléon le Petit* (1852), and his bitter satires *Les châtiments* (1853). Two years later he was compelled, on account of some hostile manifestation to the French government, to remove to the island of Guernsey. He refused to accept the amnesty offered to political exiles in 1859. In 1856 he published *Les contemplations*, a collection of lyrical and personal poems, and in 1859 *La légende des siècles* (2 vols. 8vo), a series of poems mainly of an epical character. *Les misérables*, a romance which had been announced several years before, appeared in nine languages simultaneously at Paris, London, Brussels, Madrid, Berlin, St. Petersburg, Turin, and New York (April, 1862). Its success equalled that of any of his previous works. An illustrated edition, published in parts (Paris, 1863-'75), attained a sale of 150,000 copies. In 1865 he published *Chansons des rues et des bois*, in which all the peculiarities of the author were exhibited in an exaggerated degree. *Les travailleurs de la mer* (1866) was also very popular; but *L'homme qui rit* (1869),

in which the author's fondness for monstrous caricature was carried to its height, did not attain so great a success. In 1869 he again refused to avail himself of the privilege of returning to France afforded him by the emperor's proclamation of amnesty of Aug. 15. He published in the *Rappel* a protest against the *plébiscite* of May 8, 1870, ratifying the new reforms of the empire, the violence of which caused it to be officially condemned. After the fall of the emperor and the proclamation of the republic he returned to Paris, and soon after issued an address to the Germans calling upon them to proclaim a German republic and extend the hand of friendship to France. On Feb. 8, 1871, he was elected one of the 43 representatives of the department of the Seine in the national assembly. He there vehemently opposed the parliamentary treaty of peace between France and Germany. This aroused against him the anger of the party of "the right," and on March 8, when he attempted to address the assembly, the opposition was so violent that he left the tribune and immediately resigned his seat. Returning to Paris when the insurrection of the commune broke out, he vainly protested in the *Rappel* against the destruction of the Vendôme column, and soon after went to Brussels, where on May 26 he wrote a letter protesting against the course of the Belgian government in regard to the insurgents of Paris, and offering an asylum to the soldiers of the commune. This excited the hostility of the Belgian government and of the populace of Brussels; his house was surrounded in the night by a mob, and he escaped only by the intervention of the police. Being required by the government to quit Brussels, he went to London, and after the condemnation of the leaders of the commune he returned to Paris and interceded with M. Thiers energetically, though vainly, in behalf of Rossel, Rochefort, and others of the communist leaders. At the election in Paris on Jan. 7, 1872, he was presented by all the radical newspapers as their candidate, but was defeated. During the siege of Paris a new edition of *Les châtiments* was published, and more than 100,000 copies were sold. In 1872 he published a volume of poetry entitled *Les voix*, which depicting the miseries of France. On May 10 of that year he commenced, in company with his son François and others, the publication of a new series of works, called the *Œuvres complètes*. His first novel, *Quatrevingt-treize*, alludes to the war in the Vendée, and mentions Rossel, Danton, and Marat. It was published simultaneously in French, English, and Spanish. Spanish, Portuguese, Dutch, Italian, and other languages, have followed. Some of these from these translations were published in a volume of Hugo's works, called *Œuvres complètes*, published in Paris in 1875. In 1876 he published *Les Misérables*, a novel, which has since become a classic. It was published in 1876 in London, and in 1877 in New York.

and FRANÇOIS VICTOR (born in 1825, died Dec. 26, 1873), distinguished themselves as pupils of the Charlemagne college, and in 1848-50 contributed to the newspaper *L'Événement*, which supported the politics of their father. The elder, on account of an article on the death penalty, was sentenced to six months' imprisonment. Both accompanied their father in his exile, and devoted their leisure hours to literature. Charles published several light novels, among which *La Bohème dorée* was especially successful. François, after translating with considerable success the sonnets of Shakespeare into French, began in 1859 a translation of his dramatic works, which he completed in 1865. The brothers returned to France in 1869, and commenced the publication of the *Rappel* in company with Rochefort, who however soon separated from them. François at the time of his death had nearly completed an edition of a posthumous work by his brother Charles, *Les hommes de l'exil*.—One of the two brothers of Victor Hugo, JULES ABEL (born in 1798, died in 1855), deserves mention as a literary man. Among his many publications were: *Histoire de la campagne d'Espagne en 1823* (2 vols. 8vo, Paris, 1824); *France pittoresque, ou Description des départements et colonies de la France, &c.* (3 vols. 4to, 1833); *France militaire, histoire des armées françaises de terre et de mer de 1792 à 1833* (5 vols. 4to, 1834); and *France historique et monumentale, histoire générale de France depuis les temps les plus reculés jusqu'à nos jours* (5 vols. 4to, with maps and plans, 1836-'43).

**HUGUENOTS**, a name of uncertain origin, first applied by the Roman Catholics of France to all partisans of the reformation, but subsequently restricted to the Calvinists. Some derive it from one of the gates of the city of Tours called Hugons, at which these Protestants held some of their first assemblies; others from the words *Hue nos*, with which their protest commenced; others from *aigues* (Ger. *Eidgenossen*), a confederate. The *Dictionnaire de Trévoux* suggests its derivation from the hiding in secret places and appearing at night like King Hugon, the great hobgoblin of France. Prof. Malin, in his *Etymologische Untersuchungen*, who quotes no fewer than 15 different derivations, derives the word himself from Hugues, the name of some conspirator or heretic, from which it was formed by the addition of the French diminutive ending *ot*. The reformation in France was but little influenced by Luther, and when Calvin took the lead was almost entirely self-developed. "It was not," says *the Abbe*, "a foreign importation. It was born in France; it germinated in Paris; it flourished in the schools in the university itself, and in the city in Romanist Christendom." An early reformation had been at work in France at a very early age. Arius had for several centuries been the prevailing religion in the north of France, and though it was finally rooted out by the victory of the

Catholic Franks, there remained a widespread dissatisfaction with the religion of the victors. Throughout the middle ages the national sentiment of the race of Languedoc, as the history of the Albigenses and kindred sects amply proves, was prone to sympathize and to identify itself with demands for religious reform, and even with open secession from the church of Rome. (See CATHARISTS.) To these influences was added during the reign of Francis I. the very important aid of courtly fashion, or rather the sympathy of those nobles and scholars who had become interested in the revival of letters, and who in France, as in Germany and other countries of Europe, were involved in animated conflicts with the monks and the prominent theologians of the churches. These elements of courtly, scholarly, or popular opposition to the church gave birth not merely to the humor of Rabelais, but to the poetry and philosophy which sprung up around the beautiful Marguerite of Valois, queen of Navarre, from whom the spirit of the reformation was transmitted to Jeanne d'Albret, the mother of Henry IV. At this court all poets, scholars, and clergymen more or less tinged with the spirit of reform, such as Lefèvre, Farel, and Roussel, were welcome; and for a time it seemed as though the court and the government of France might be gained for the cause of the reformation. But at length Francis I., like his opponent the emperor Charles V., debbled in favor of the old church, as the papal nuncio succeeded in convincing him that "a new religion disseminated among the people must result in a change of kings." In the city of Meaux, around its bishop Briçonnet, a large body of men inclined to the new faith began, without formally professing schism, to act as reformers. Among these were Gérard Roussel, François Vatable, Martial Mazurier, José Chetillon, Michel d'Arande, and Guillaume Farel. Their labors, joined to the political and social agitations of the day, soon attracted persecution. It is remarkable that this persecution in France acted so effectually on the French reformation as to free it in a great measure from excesses such as those of the Anabaptists in Germany. Yet it would probably have fallen away had not the strong hand of Calvin taken it up (1528). Hence we find the French reformers embodying Calvin's ideas of church government and discipline in a common confession of faith, which was formally done at the celebrated general synod in May, 1559. During the reign of Henry II. (1547-59) the Huguenots gathered such strength as to entertain hopes of becoming the dominant political party; hopes which were confirmed by the fact that several of the royal family, such as the king of Navarre, his brother the prince de Condé, and many of the nobility, including the Châtillons and Admiral Coligni, favored the reformation. From this blending of religion with politics arose the conspiracy of Amboise, whose object was to overthrow

the power of Duke François of Guise and his brother the cardinal de Lorraine, who with Mary of Scotland ruled the kingdom through the feeble-minded boy-king Francis II. The king of Navarre and prince de Condé were deeply involved in this plot, and would have suffered death with their Calvinist friends had it not been for the unexpected demise of the king. This occasioned a pause in persecution, of which the queen mother, Catharine de' Medici, and the ruling party availed themselves for political purposes, becoming more moderate in their treatment of reformers. By extending toleration to the Augsburg confession, the cardinal de Lorraine shrewdly fomented quarrels between the Calvinists and Lutherans. This state of affairs, which led to terrible commotions, was again temporarily checked by the edict of January, 1562. At this time, during the reigns of two successive kings whose intellectual inferiority rendered a regency always necessary (after 1559), Catharine de' Medici held the reins of authority, while the dukes of Guise supported by the Catholics, and the princes of Bourbon by the Huguenots, contended for the regency. Some liberal concessions, made for the sake of policy by Catharine and the Guises to the Huguenots, excited the anger of the Catholics, and to allay these feelings war was renewed and raged till the peace of St. Germain (1570), when full liberty was guaranteed the Huguenots, and the king's sister given as wife to Henry of Navarre. The leading Protestants were invited to Paris to the nuptials, where on the day of St. Bartholomew, 1572, a general massacre of Protestants was attempted at the instigation of the queen mother. The Huguenots, with Henry of Navarre as leader, now battled against the holy league formed by the Guises and Philip II. of Spain. Charles IX. died a victim to nervous excitement (1574), and Henry III., disgusted with the tyranny of the league, had Henry, duke of Guise, and the cardinal put to death, and fled for safety to the Protestant camp. He was himself assassinated by the Dominican Clément (1589), and was succeeded by Henry of Navarre, who, to pacify these terrible disorders in France, became a Catholic, but secured full freedom of conscience and all political and religious rights to the Huguenots by the edict of Nantes (1598). The murder of Henry IV. by Ravaillac (1610) left the Protestants without a protector. Under his young son and successor Louis XIII. their rights were soon attacked. Cardinal Richelieu, determined to build up royal power and crush all jarring elements, at one time made war upon the Protestants, driving them into an unlucky league with England, which resulted in the siege and capitulation of La Rochelle. But his treatment of them was on the whole tolerant, though its ultimate result was to greatly diminish their numbers and weaken their power. From 1629 to 1691, under Richelieu and especially under his successor Mazarin, there was comparative rest. After the death of Mazarin

several edicts were again published in rapid succession which aimed at reducing and finally exterminating the Huguenots. Colbert, from considerations of national economy, made the utmost efforts to secure toleration for them, but they were of little avail. Two years after his death, in 1685, Louis XIV. published the celebrated revocation of the edict of Nantes, on which occasion at least 500,000 Protestants took refuge in foreign countries. From this time, for many years, their cause was completely broken in France. In the wild mountains of the Cévennes, the religious peasants, under the name of Camisards, waged war against the royal troops for the defence of Protestant principles; but they had finally to succumb. In 1795 there was not a single organized congregation of Huguenots left in all France. Soon, however, the scattered remnants were again collected and the church reorganized by the indefatigable Jean Court. Although under the reign of Louis XV. severe ordinances were again issued against them, they continued to increase, and in the middle of the century found a powerful aid in men like Montesquieu and Voltaire. Their position was greatly improved on the accession of Louis XVI. (1774), and finally the revolution restored to them their full rights, which have been substantially respected by all the succeeding governments of France. The right of convening general synods of the church was, however, not recovered till 1872. The term Huguenot had long before ceased to be the common name of the church, which is now known as the Reformed church of France.—So early as 1555, Coligni attempted, but without success, to establish a Huguenot colony in Brazil. In 1562 he sent out two ships, under the command of Jean Ribault, on a voyage of exploration to Florida, but the attempt to establish a colony was unsuccessful. Many departed for North America even before the revocation of the edict of Nantes. Some settled in and around New Amsterdam, now New York, where their family names are frequent. Others found homes in Massachusetts, Rhode Island, and Virginia. But South Carolina was their favorite resting place, and a large number of the foremost families in that state are of Huguenot origin. This class of emigrants has contributed, in proportion to its numbers, a vast share to the culture and prosperity of the United States. Wherever they settled they were noted for severe morality, great charity, and politeness and elegance of manners. Of seven presidents who directed the deliberations of the congress of Philadelphia during the revolution, three, Henry Laurens, John Jay, and Elias Boudinot, were of Huguenot parentage.—Among the copious existing sources of Huguenot history, the principal are: Beza, *Histoire ecclésiastique de l'Église réformée du royaume de France* (Antwerp, 1580); Weiss, *Histoire des réfugiés protestants de France* (Paris, 1843; translated by H. W. Herbert, New York, 1854); Gieseler,

*Lehrbuch der Kirchengeschichte* (Bonn, 1845-7); Berthold, *Deutschland und die Hugenotten* (Bremen, 1848); Félice, *Histoire des protestants de France* (Paris, 1851); the *Bulletin de la société de l'histoire du protestantisme français*; *La France protestante*, by Eugène and Émilie Haag (9 vols., Paris, 1859); Smiles, "The Huguenots: their Settlements, Churches, and Industries in England and Ireland" (London, 1867; American edition, New York, 1869, containing a valuable appendix on the Huguenots in the United States, by G. P. Disce-way, a descendant of a Huguenot family); Hugues, *Histoire de la restauration du protestantisme de France au XVIII<sup>e</sup> siècle* (2 vols., Paris, 1872).

**HULLIN**, or **HULLIN**, **Pierre Augustin**, count, a French general, born in Paris, Sept. 6, 1758, died Jan. 9, 1841. He enlisted in the army when scarcely 13 years old, entered the regiment of French guards, and was a sergeant when the revolution broke out. He sided with the people, distinguished himself by his valor and humanity at the taking of the Bastille, July 14, 1789, and was appointed captain in the national guards under Lafayette. During the reign of terror he was imprisoned, but was liberated after the fall of Robespierre. In 1796 he joined the army of Italy under Bonaparte, who appointed him adjutant general; he was governor of Milan in 1797-'8, and was in Paris on the 18th Brumaire, when he supported his general. He followed Bonaparte in Italy during the campaign of Marengo; was made brigadier general in 1803; presided over the court martial which sentenced the duke d'Enghien to death, March 21, 1804; received the rank of general of division and the command of the first military division in 1807; and was the next year created count of the empire. He held the command of Paris until the first restoration; and although, after the abdication of Napoleon, he had sent in his adhesion to the new government, he was dismissed by the Bourbons. He resumed his post during the hundred days, was arrested on the second restoration, and compelled to leave France, but was allowed to return in 1819. Under the title of *Explications offertes aux hommes impartiaux au sujet de la commission militaire instituée en l'an XII pour juger le duc d'Enghien* (Paris, 1823), he published a plain account of his part in that tragedy.

**HULL**, or **Kingston-upon-Hull**, a municipal and parliamentary borough and seaport of England, in the East riding of Yorkshire, on the river Hull, at its mouth in the Humber, 34 m. S. E. of York, 154 m. N. of London, and 20 m. from the sea; pop. in 1871, 121,598. It is built on a low plain, protected against inundation by artificial means, and extends more than 2 m. along the W. bank of the Hull, and nearly the same distance along the N. bank of the Humber. The streets are very irregular, but are mostly well paved, lighted, and drained. The residences of the wealthy inhabitants are principally in the parish of Sculcoates and the

quarter called Myton. A part of the town built along the left bank of the Hull is connected with the remainder by a bridge of four arches. On the point of land formed by the junction of the two rivers there is a fort which commands the whole harbor. Adjoining it is the Victoria dock. The old dock, opened in 1778 on the Hull, is nine acres in extent, and can accommodate 100 square-rigged ships. There is also a railway dock at the terminus of the Hull and Selby railway. Other docks have been built of late years, and the total area of all the docks of Hull in 1874 was about 87½ acres. The principal public buildings are the custom house, exchange, post

and zoölogical gardens and a "People's Park" of 27 acres given by Sir Z. C. Pearson in 1864. The manufactures include canvas, chains, machinery, earthenware, chemicals, leather, sugar, cotton and linen goods, &c. There are ship-building yards, rope walks, saw mills, grist mills, bone mills, and oil mills. The principal exports are hardware and manufactures of cotton and woollen; the imports, timber, tar, pitch, rosin, grain, wool, flax, hemp, iron, hides, tallow, horns, bones, &c. The trade is chiefly along the coast, with the Baltic ports, and with Germany, Holland, Belgium, Denmark, and America. Hull is an important station for steam packets which connect it with various ports of Great Britain and the continent, and also has railway communication with nearly all parts of the kingdom. The total imports in 1871 were valued at £15,076,095, the exports at £27,387,071. The entrances were 3,417 vessels, of 1,188,841 tons; clearances, 2,911 vessels, of 1,044,158 tons. Hull ranks as the third port in the kingdom.

**HULL, Isaac**, an American naval officer, born at Derby, Conn., March 9, 1775, died in Philadelphia, Feb. 3, 1843. He commenced his career in the merchant service, and was commissioned as lieutenant in the navy at the commencement of hostilities with France in 1798. In 1800 he was first lieutenant of the frigate *Constitution*, and performed a very gallant achievement in cutting out a French letter of marque from under the guns of a strong battery in the harbor of Port Platte, Santo Domingo. During the war with Tripoli, 1802-5, Hull served with distinction in the several attacks on the city of Tripoli in July, August, and September, 1804, and subsequently coöperated with Gen. Eaton in the capture of Derne. In 1806 he was made captain. At the opening of the war of 1812 between the United States and Great Britain, he was in command of the frigate *Constitution*, and in July of that year, while cruising off New York, he fell in with a British squadron consisting of a razeed of 64 guns and four frigates, which chased the *Constitution* closely for nearly three days and nights. By the greatest efforts, and the exercise of a skill in handling his ship which excited the admiration of his pursuers, he succeeded in escaping. After this remarkable feat, Hull went into Boston for a few days, whence he sailed Aug. 3, and on Aug. 19, in lat. 41° 41' N., lon. 55° 48' W., discovered a ship to leeward, which was soon made out to be an English frigate. The course of the *Constitution* was shaped to close with this vessel, which hove to to await an engagement. At 5 P. M. the English frigate opened her fire at very long range, and at a little after 6 the *Constitution* closed with her. After a desperate fight of about half an hour the English frigate was reduced to a wreck and surrendered. She proved to be the *Guerriere*, Capt. Daeres, one of the ships which had recently eluded the *Constitution*. Possession was taken of her soon after 7 P. M. The next



Town Hall, Hull.

Exchange, mansion house, courts of law, jail and house of correction, assembly rooms and museum, concert rooms, two theatres, several banks, and an exchange. The Holy Trinity church is a handsome cruciform edifice of several dates; the oldest portion was built in 1270. The town has several charitable schools, one of which educates 36 boys to be seamen, and is connected with the Trinity house founded in 1607 for the relief of decayed seamen and the support of seamen. There is a marine hospital attached to it. Hull college, founded in 1828 occupies a fine Grecian building. There are also a lunatic asylum, a general infirmary, a school of medicine and anatomy, various literary associations with libraries, and botanic



day she was discovered to be in a sinking condition, and after the removal of the prisoners she was set on fire and soon afterward blew up. The Constitution suffered somewhat aloft in this action, though but little in her hull. Her loss in killed and wounded was 14, and that of the *Guerriere* 79. The Constitution was the larger and heavier ship, mounting 54 guns, long 24s and 32-pounder carronades, the *Guerriere* mounting 49 guns, long 18s and 32-pounder carronades. As this was the first naval action of the war, it was regarded as very important. Capt. Hull carried his prisoners into Boston, where he was enthusiastically received. Congress at its next session presented a gold medal to him, and silver ones to each commissioned officer under his command in this engagement. After the war his principal services were in command of the navy yards at Boston and Washington, of the squadrons in the Pacific and Mediterranean, and in the board of navy commissioners.

**HULL, William**, an American soldier, born in Derby, Conn., June 24, 1753, died in Newton, Mass., Nov. 29, 1825. He graduated at Yale college in 1772, studied law at Litchfield, Conn., and was admitted to the bar in 1775. He entered the army of the revolution at Cambridge in 1775 as captain of a Connecticut company of volunteers; was made major in the 8th Massachusetts regiment in 1777, and lieutenant colonel in 1779, and was inspector of the army under Baron Steuben. He was in the battles at White Plains, Trenton, Princeton, Stillwater, Saratoga, Monmouth, and Stony Point. He commanded the expedition against Morrisania, for which he received the thanks of Washington and of congress. After the war he was major general of the 3d division of Massachusetts militia, and a state senator, and was appointed by Jefferson governor of Michigan territory in 1805. He remained in this office till 1812, when he was appointed as brigadier general to the command of the northwestern army. He marched his troops through the wilderness to Detroit, heard of the declaration of war, and of the fall of Michilimackinac, which let loose the Indians of the northwest upon him, crossed into Canada, but found his communications cut off, recrossed, and on the arrival of Gen. Brock surrendered to that officer the post of Detroit and the territory. For this act he was tried two years after by a court martial, and sentenced to be shot. The execution of the sentence was remitted by the president in consideration of his age and revolutionary services. In 1824 Gen. Hull published a series of letters in defence of his conduct in this campaign. In 1848 a volume was published in New York on his revolutionary services and the campaign of 1812, written by his daughter, Mrs. Maria Campbell of Georgia, and his grandson, the Rev. James F. Clarke of Massachusetts.

**HULLAH, John**, an English composer and teacher of music, born in Worcester in 1812.

His comic opera "The Village Coquettes," written in conjunction with Dickens, and produced in 1836, first made him known to the public. After the production of two other operas, he turned his attention about 1838 to the establishment in England of popular singing schools, similar to those which had proved so successful in Paris. In 1847 a spacious music hall was erected in London for his concerts, which was burned down in 1860. He is professor of vocal music and harmony in King's, Queen's, and Bedford colleges, London, organist of the Charterhouse, conductor of the orchestra and chorus in the royal academy of music, and musical inspector for the United Kingdom. He is the author of numerous works, essays, and lectures on the science and history of music.

**HULTSCH, Friedrich Otto**, a German philologist, born in Dresden, July 22, 1833. He became a teacher at Leipsic in 1857, subsequently at Zwickau, and afterward at Dresden, where in 1868 he became rector of the *Kreuzschule*. His principal works are *Griechische und römische Metrologie* (Berlin, 1862), and editions of the *Scriptores Metrologici* (Leipsic, 1864-'6), of Heron's *Geometrici et Stereometrici* (Berlin, 1864), of Censorinus *De Die Natali* (Leipsic, 1867), and of the "Histories" of Polybius (Berlin, 1867-'72).

**HUMBER**, a river or estuary of England, separating the counties of York and Lincoln. It is principally formed by the junction of the Ouse and the Trent. Its course is nearly E. as far as Hull, and S. E. thence to where it falls into the North sea. It is about 40 m. in length, and varies in breadth from 2 to 7 m. The chief towns on its banks are Hull, Goole, and Great Grimsby. By means of its numerous tributaries it drains an area of 10,000 sq. m. It is navigable for the largest ships to Hull, 20 m. from the sea, and throughout for vessels of considerable burden.

**HUMBOLDT**. I. A N. W. central county of Iowa, intersected by the Des Moines river and its W. branch; area, 576 sq. m.; pop. in 1870, 2,596. It has an undulating surface and a fertile soil. There are quarries of good building stone. The chief productions in 1870 were 59,101 bushels of wheat, 107,950 of Indian corn, 60,316 of oats, 12,416 of potatoes, 83,985 lbs. of butter, and 9,133 tons of hay. There were 999 horses, 1,021 milch cows, 1,614 other cattle, and 1,393 swine; 1 saw mill, and 2 flour mills. Capital, Dakota City. II. A N. W. county of California, bordering on the Pacific, and drained by Eel, Mad, and Bear rivers, and other streams; area, 2,800 sq. m.; pop. in 1870, 6,140. Humboldt bay lies near the N. W. corner, and Cape Mendocino, the westernmost point of the state, projects into the Pacific near the centre of the coast line. The surface is mountainous, and mostly covered with forests of redwood, pine, spruce, &c., which attain an enormous size. The bottom lands are fertile, but lumber is the chief source

alth. Petroleum has been found in the rt. The streams swarm with salmon. Chief productions in 1870 were 32,284 s of wheat, 137,022 of oats, 31,907 of 54,316 of peas and beans, 372,924 of es, 112,580 lbs. of butter, 51,867 of wool, 426 tons of hay. There were 4,329 5,691 milch cows, 12,056 other cattle, sheep, and 10,050 swine; 3 manufac- of carriages, 1 flour mill, and 8 saw Capital, Eureka. III. A N. W. county ada, bordering on Oregon; area, 19,000 ; pop. in 1870, 1,916, of whom 220 were e. The surface is generally mountain- e. E. portion being occupied by the Hum- range. Humboldt, Reese, and Quins and other streams that lose themselves aka," or lakes without outlet, water por- f the county. There are several lakes in part. On Humboldt river and in Para- d other valleys is some arable land, and is afford grazing; but the chief wealth e silver mines, which are mostly S. of mboldt river. Gold, copper, and lead o found. By the census of 1870, 14 vere returned, of which 12 were of sil- f gold, and 1 of lead. There were 10 mills, all except one for the production r. It is traversed by the Central Pa- froad. The chief productions were ashels of wheat, 30,209 of barley, 5,504 oes, and 2,219 tons of hay. There were ses, 2,186 cattle, 700 sheep, and 786 Capital, Unionville.

**HUMBOLDT, Friedrich Heinrich Alexander von,** German naturalist, born in Berlin, 1769, died there, May 6, 1859. He than ten years old at the death of his ho had been adjutant of Duke Ferdi- Brunswick in the seven years' war, rward a Prussian royal councillor. his elder brother Wilhelm were edu- home, with special care in the natural

In 1787 he studied at the university fort-on-the-Oder, returned to Berlin fllowing year, and applied himself to ology of manufactures and to the nguage. An acquaintance with the Willdenow led him to study the cryp- plants and the family of grasses. He year (1789-'90) at the university of , studying philology under Heyne, ding his knowledge of natural history, guidance of Blumenbach, Lichten- others. His first published work, of an excursion from the university, *die Basalte am Rhein, nebst Unter- über Syenit und Basalt der Alten* (1790). A rapid journey which he 1790. In company with George For- igh the Low Countries, England, and ve him a desire to visit the tropics, ed to Germany with the purpose, g himself to finance, and a- tantile academy at Ham- & bookkeeping, fam-

with counting-house affairs, and practicing modern languages. On arrival in Berlin in the following year he obtained permission to engage in practical mining, and he went to the mining academy at Freiberg, where for eight months he enjoyed the practical instruction of Werner and the assistance of Freiesleben, Von Buch, and Del Rio, two of whom 12 years later he found again in Mexico. He wrote with Werner describing of the subterranean fire and on several the experiments on the color of flame produced from the light and accompanied by mineral gases, entitled *Flame coloration, Philosophiae et Aphorismi ex Physiologia Minerali, Pyrum*, which first appeared in 1791. At Freiberg he made the first practical application of one of the Bohemian mineralogists. In 1792 he was appointed assessor in the mining department, and subsequently superior mining officer in the district of Upper Bavaria, Gafing, and was sent to Prussia. In 1794 he accompanied Hardenberg to Frankfurt, and was employed in his cabinet correspondence. He then he experimented on the action of arsenic in mines. In 1795 he made a geological journey through Tyrol, Lombardy, and Hungary. In 1796 he was sent as a minister to the headquarters of Gen. Buxarion in Italy. From the time when he first heard of Lavoisier's discovery he had been preparing himself for his work *Ueber die gewöhnlichen Nervenfasern, nebst Fortschritten der chemischen Process des Lebens in der Thier- und Pflanzenwelt* (2 vols., Berlin, 1807). He also familiarized himself with the astronomy, especially with the use of the sextant for determining geographical position. On the death of his mother he was to prosecute his purpose of a geological expedition. Leaving Berlin in 1797, he passed three months at Bonn, and then gained a second journey to Italy, to see the volcanoes Vesuvius and Mount Etna. The disturbed condition of Italy made his purpose impracticable, and he spent the winter in Salzburg and Innsbruck, occupied with meteorological observations. He accepted the invitation of the Spanish government to accompany him as an observer to Egypt, intending also to visit Palestine. He visited the Nile, and requisite scientific observations. In 1798, he learned that the French had arrested at Milan several persons from political designs in Italy. He left Paris, he became a member of the government in composition of his own country. In 1800 he returned to Berlin, in connection to Humboldt, without in- He had ac- Prussia in May, at constitutional Nicholas in per-

touch at many islands of the South sea, New Zealand, and Madagascar, and to return by the cape of Good Hope. Humboldt received permission to join the expedition, and to leave it when and where he wished. After several months of suspense, the necessities of war obliged the government to postpone the undertaking. Thus disappointed in his hopes of travel, Humboldt accepted an invitation to accompany the Swedish consul Skjöldebrand, who had been appointed to carry presents to the dey of Algiers, and he intended to proceed by way of Tunis to Egypt. The delay of the Swedish frigate, and the news from Barbary that during the war between the Turks and French every person arriving from a French port was thrown into prison, thwarted this purpose. He therefore, in company with Bonpland, resolved to spend the winter in Spain; and passing through Perpignan, Barcelona, Montserrat, and Valencia, making botanical, astronomical, and magnetic observations by the way, they reached Madrid in February, 1799. He was received with distinguished favor, and the Saxon minister at Madrid, Baron Forell, having overcome the scruples of the Spanish government and procured for him an interview with King Charles IV., all the Spanish possessions in Europe, America, and the East Indies were opened to him, with free permission to use all instruments for astronomical and geodetic observations, the measurement of mountains, the collection of objects of natural history, and investigations of every kind that might lead to the advancement of science. Such extensive privileges had never before been granted to any traveller. He left Madrid, measuring the elevations on his way through Old Castile, Leon, and Galicia, and on June 5, 1799, embarked with Bonpland in the frigate Pizarro from Corunna. Avoiding the English cruisers, they reached Tenerife on June 19, where they tarried to ascend the peak and to make many observations on the natural features of the island, and arrived at Cumaná, in Venezuela, July 16, 1799. After exploring the Venezuelan provinces for 18 months, residing the latter part of the time at Carácas, they set out for the interior from Puerto Cabello over the grassy plains of Calabozo to the river Apure, a branch of the Orinoco. In Indian canoes they made their way to the most southern post of the Spaniards, Fort San Carlos, on the Rio Negro, within two degrees of the equator. They could have advanced only by taking their boats over land, and therefore returned through the Cassiquiare to the Orinoco, which they followed to Angostura, proceeding thence to Cumaná. This journey through wild and unfrequented regions was the first which furnished any positive knowledge of the long disputed bifurcation of the Orinoco. They sailed to Havana, but after a few months hastened to seek some southern port, hearing a false report that Baudin, whom they had promised to join, had ap-

peared on the W. coast of South America. They embarked in March, 1801, from Havana on the S. coast of Cuba. The seasickness of the year forbade the execution of their plan of going to Cartagena and Panama, and they sailed for 54 days up the river Magdalena, in order to reach the high plains of Bogotá. Thence they made excursions to the most remarkable natural features of the surrounding country. In September, in spite of the rainy season, they began their journey southward, passed Ibagua, the highest encampment by night), Carapáyan, Almaguer, and the lofty plain of Pastos, and reached Quito, after experiencing the greatest difficulties for four months, 6, 1802. The next five months they spent in investigations of the elevated vale of Quito, and of the snow-capped volcanoes which surround it, ascending some of these to heights not before attained. On Chimborazo they reached (June 23, 1802) the altitude of 19,000 ft., about 3,500 ft. higher than the point reached by La Condamine on the Corazon in 1786; they were prevented only by a deep snow-drift from advancing to the summit. They were joined at Quito by a young scholar, Juan Montufar, son of the marquis of San Carlos, who attended them throughout their journey in Peru and Mexico and back to Europe. Over the pass of the Andes in the province of Asuay, by Cuenca and Loja, they descended into the vale of the upper Amazon at Bracamoras, and traversing the plateau of the jamarca, by the mountain city Micipu, upward of 11,000 ft. high, near the silver mines of Chota, they reached the western base of the Peruvian Andes. From the summit of Guanamarea (about 9,500 ft. high) they descended, joyed for the first time the long-southern view of the Pacific. They reached the coast at Callao, and travelled through the sand dunes of Lower Peru to Lima. After one of the principal designs of their Peruvian journey was fulfilled, they embarked on December 18, 1802, and reached Acapulco in Mexico in March 23, 1803. They arrived in the city of Mexico in April, remained there a few days, and then visited Guanajuato and Vera Cruz, the province of Michoacan near the coast, and the volcano of Jorullo, which was first broken out in 1759, and returned to Toluca to the capital, where they remained long enough to arrange their rich collection, and to reduce their various observations into order. In January, 1804, after having ascended the volcano of Toluca and the Perote, they descended through the mountains of Jalapa to Vera Cruz, where they compared their barometric measurements with that which they had formerly made of the eastern declivity of the highland of Mexico, with that which they had formerly made of the western declivity, and made

of the country from sea to sea, the first that was ever given of any entire country. On March 7, 1804, Humboldt sailed from the coast of Mexico for Havana, where during a two months' residence he completed the materials for his *Essai politique sur l'île de Cuba* (Paris, 1826). He embarked thence with Bonpland and Montufar for Philadelphia, enjoyed a friendly reception at Washington from President Jefferson, and leaving the new world landed at Bordeaux, Aug. 3, 1804, having spent five years in America, and gained a larger store of observations and collections in all departments of natural science, in geography, statistics, and ethnography, than all previous travellers. He selected Paris for his residence, and remained there till March, 1805, arranging his numerous collections and manuscripts, and experimenting with Gay-Lussac in the laboratory of the polytechnic school on the chemical elements of the atmosphere. He was accompanied by Gay-Lussac in a visit to Rome and Naples, and also by Von Buch on his return through Switzerland to Berlin, where, after an absence of nine years, he arrived Nov. 16, 1805. In the hope of modifying the ignominious treaty of Tilsit by negotiation, the government resolved in 1808 to send the young brother of the king, Prince William of Prussia, to the emperor Napoleon at Paris. During the French occupation of Berlin Humboldt had been busy in his garden, making hourly observations of the magnetic declination, and he now received the command of the king to accompany Prince William on his mission. As the condition of Germany made it impracticable to publish there his large scientific works, he was permitted by Frederick William III., as one of the eight foreign members of the French academy of sciences, to remain in Paris, which was his residence, excepting brief periods of absence, from 1808 to 1817. There appeared his *Voyage aux régions équinoxiales du nouveau monde* (3 vols. fol., with an atlas, Paris, 1809-25; translated into German, 6 vols., Stuttgart, 1825-32). When in 1810 his elder brother resigned the directorate of educational affairs in Prussia to become ambassador at Vienna, the former post was urged upon Alexander von Humboldt; he declined it, as the publication of his astronomical, zoological, and botanical works was not yet far advanced. He had also already decided upon a second scientific expedition through upper India, the region of the Himalaya and Thibet, in preparation for which he was diligently learning the Persian language. He accepted from Count Rumiantzeff in 1812 an invitation to accompany a Russian expedition over Kashgar and Yarkand to the highlands of Thibet, but the outbreak of war between Russia and France caused the abandonment of the plan. The political events between the peace of Paris and the congress of Aix-la-Chapelle gave him occasion for several excursions. He went to England in the suite of

the king of Prussia in 1814, again in company with Arago when his brother Wilhelm was appointed ambassador to London, and again in 1818 with Valenciennes from Paris to London and from London to Aix-la-Chapelle, where the king and Hardenberg wished to have him near them during the congress. He also accompanied the king to the congress of Verona and thence to Rome and Naples, and in 1827, at the solicitation of the monarch, gave up his residence in Paris, and returned by way of London and Hamburg to Berlin, where in the following winter he delivered public lectures on the cosmos. In 1829 began a new era in his active career. He undertook, under the patronage of the czar Nicholas, an expedition to northern Asia, the Chinese Dzungaria, and the Caspian sea, which was magnificently fitted out by the influence of the minister, Count Cancrin. The exploration of mines of gold and platinum, the discovery of diamonds outside of the tropics, astronomical and magnetic observations, and geognostic and botanical collections, were the principal results of this undertaking, in which Humboldt was accompanied by Ehrenberg and Gustav Rose. Their course lay through Moscow, Kazan, and the ruins of old Bulgari to Yekaterinburg, the gold mines of the Ural, the platinum mines at Nizhni Tagilsk, Bogoslovsk, Verkhoturye, and Tobolsk, to Barnaul, Schlagenberg, and Ustkamengorsk in the Altai region, and thence to the Chinese frontier. From the snow-covered Altai mountains the travellers turned toward the southern part of the Ural range, and, attended by a body of armed Cossacks, traversed the great steppe of Ishim, passed through Petropavlovsk, Omsk, Miyask, the salt lake of Imen, Zlatusk, Taganai, Orenburg, Uralsk (the principal seat of the Uralian Cossacks), Saratov, Dubovka, Tzaritzyn, and the Moravian settlement Sarepta, to Astrakhan and the Caspian sea. They visited the Calmuck chieftain Sereb Jab, and returned by Voronezh, Tula, and Moscow. The entire journey of over 10,000 miles was made in nine months; its results are given in Rose's *Mineralogisch-geognostische Reise nach dem Ural, Altai und dem Kaspischen Meere* (2 vols., Berlin, 1837-42), and in Humboldt's *Asie centrale, recherches sur les chaînes de montagnes et la climatologie comparée* (3 vols., Paris, 1843; translated into German by Mahlmann, 2 vols., Berlin, 1843-4). This expedition extended the knowledge of telluric magnetism, since in consequence of it the Russian imperial academy established a series of magnetic and meteorological stations from St. Petersburg to Peking, an example which was followed by the British government in the southern hemisphere. The convulsions of 1830 gave a more political direction to Humboldt's activity for several years, without interrupting his scientific career. He had accompanied the crown prince of Prussia in May, 1830, to Warsaw, to the last constitutional diet opened by the emperor Nicholas in per-

son, and he attended the king to the baths of Teplitz. On the news of the French revolution and the accession of Louis Philippe, he was selected to convey to Paris the Prussian recognition of the new monarch, and to send political advices to Berlin. The latter office fell to him again in 1834-'5, and he was called upon to fulfil it five times in the following twelve years, residing four or five months in Paris on each mission. To this period belongs the publication of his *Examen critique de la géographie du nouveau continent* (5 vols., Paris, 1835-'8; translated into German by Ideler, 5 vols., Berlin, 1836 *et seq.*). He made a rapid journey with King Frederick William IV. to England in 1841, to attend the baptism of the prince of Wales, to Denmark in 1845, and resided in Paris several months in 1847-'8, from which time he lived in Prussia, usually in Berlin, pursuing his scientific labors in his advanced age with undiminished zeal and energy.—Humboldt was distinguished, as a man of science, for the comprehensiveness of his researches, and especially for the skill and completeness with which he connected his own observations with all the stores of previous knowledge, and for the clearness with which he expounded facts in their relations. This tendency appeared in one of his earliest works on the contraction of the muscles and nerves, in which, after the progress of physiology for more than half a century, may still be seen the sagacity of his experiments on galvanism, and the truth of most of the inferences which he drew. In his travels he measured elevations, and investigated the nature of the soil and the thermometrical relations, at the same time collecting herbariums, and founding, by a combination of the materials in his hands, the new science of the geography of plants. Linnæus and some of his successors had observed some of the more palpable phenomena of the migrations of plants, without, however, considering elevation or temperature. It remained for Humboldt to bring together the vast series of facts collected from the most remote points, to combine them with his own observations, to show their connection with the laws of physics, and to develop the principles in accordance with which the infinitely numerous forms of the vegetable world have been spread over the earth. He was the first to see that this distribution is connected with the temperature of the air, as well as with the altitudes of the surface on which they grow, and he systematized his researches into a general exposition of the laws by which the distribution of plants is regulated. Connected with this subject he made those extensive investigations into the mean temperature of a large number of places on the surface of the globe which led to the drawing of the isothermal lines, so important in their influence in shaping physical geography and giving accuracy and simplicity to the mode of representing natural phenomena. By associating many important questions with bot-

any, he made it one of the most attractive of the natural sciences. He showed the powerful influence exercised by vegetable nature upon the soil, upon the character of a people, and upon the historical development of the human race. This view of the connection between the physical sciences and human history opened a path which has been followed by a school of subsequent investigators with novel and important results. Though wholly free from mystical meanings and obscure phraseology, his works are marked by poetical conceptions of nature wherever it is his aim to present broad and complete pictures. His delineations of the tropical countries give delight to readers who have no special knowledge of or interest in natural history. At the beginning of this century even the coasts of the immense Spanish colonies in America were scarcely known, and but little confidence was placed in the best maps. More than 700 places of which he made astronomical measurements were calculated anew by Oltmanna, whose work (2 vols., Paris, 1808-'10) forms the fourth part of Humboldt's "Travels." He himself made the map of the Orinoco and the Magdalena, and the greater part of the atlas of Mexico. He travelled with the barometer in his hands from Bogotá to Lima, ascended the peaks of Teneriffe, Chimborazo, and numerous other mountains, and made 459 measurements of altitude, which were often confirmed by trigonometrical calculations. His measurements in Germany and Siberia, combined with those made by other travellers, furnished valuable results to geography, and were the foundation of theories of the dispersion of plants and animals. Climatology was intimately connected with his researches. By his daily record of the meteorological, thermometrical, and electrical phenomena of the countries through which he passed, he instituted the science of comparative climatology. He was the first to entertain the idea of estimating the average elevation of continents above the sea, previous geographers and geologists having considered only the altitude of mountain chains and of the lower lands. His principal works in this department are: *Physique générale et géologie* (Paris, 1807); *Essai géognostique sur le gisement des roches dans les deux hémisphères* (1823-'6); and *Fragments de géologie et climatologie asiatique* (2 vols., 1831; translated into German by Löwenberg, Berlin, 1832). The phenomena of the volcanoes of South America and Italy he keenly observed and explained. With Bonpland he made very important observations on the sites, uses, and structure of plants. His principal botanical works are *Essai sur la géographie des plantes* (Paris, 1805), and *De Distributione Geographica Plantarum secundum Cæli Temperiam et Altitudinem Montium* (1817). The rich herbarium collected by him and Bonpland contained more than 5,000 species of phanerogamous plants, of which 3,500 were new. They were arranged and illustrated by Humboldt,

Bonpland, and Kunth, in the following works, which form the sixth part of his "Travels:": *Plantes équinoxiales, recueillies au Mexique, dans l'île de Cuba, &c.* (2 vols., 1809 et seq., with 144 plates); *Monographie des mélastomes et autres genres du même ordre* (2 vols., 1809-'23, with 120 colored plates); *Nova Genera et Species Plantarum, &c.* (7 vols., 1815-'25, with 700 plates); *Mimosas et autres plantes légumineuses du nouveau continent* (1819-'24, with 60 plates); *Synopsis Plantarum, &c.* (4 vols., 1822-'26); *Révision des graminées* (2 vols., 1829-'34, with 220 colored plates). The zoological results of his travels are contained in his *Recueil d'observations de zoologie et d'anatomie comparée* (2 vols., 1805-'32), in the publication of which he was aided by Cuvier, Latreille, and Valenciennes. Another costly work, the *Vues des Cordillères et monuments des peuples indigènes de l'Amérique* (1810, with 69 plates), contains elaborate pictures of the scenery of the Andes and of the monuments of the ancient civilization of the aborigines. The study of the great architectural works of the ancient Mexicans and Peruvians led Humboldt to investigations of their languages, records, early culture, and migrations. In this department his treatment was peculiar, for his *Essai politique sur le royaume de la Nouvelle Espagne* (2 vols., 1811) contained statistics united with the facts of natural history, and presented various doctrines of political economy from a new point of view. Especially original and influential were his reflections on the culture of the soil under different climates and on its effects upon civilization, and on the circulation of the precious metals. Besides his general works, he made many special investigations, as his treatise on the geography of the middle ages, in which he appears at once as historian, astronomer, and savant, his chemical labors with Gay-Lussac, his system of isothermal lines, his experiments on the gymnotus and on the respiration of fishes, and numerous contributions to physical geography. Soon after his return from America he gave a general sketch of the results of his inquiries in his *Ansichten der Natur* (Stuttgart, 1808), in which he aimed to present a picture of the physical world, exclusive of everything that relates to the turmoil of human society and the ambitions of individual men; and in the evening of his life he determined to give a systematic view of the results of his investigation and thought in the whole domain of natural science. This was the design of his *Kosmos* (5 vols., Stuttgart, 1845-'62), which explains the physical universe according to its dependencies and relations, grasps nature as a whole moved and animated by internal forces, and by a comprehensive description shows the unity which prevails amid its variety. He tried to complete this work, but the last volume was published after his death. It was translated into almost all the European languages, and has been without an equal in giving

an impulse to natural studies. To his personal influence is due nearly all that the Prussian government did for science in the latter part of his life. Agassiz says of him: "The personal influence he exerted upon science is incalculable. With him ends a great period in the history of science; a period to which Cuvier, Laplace, Arago, Gay-Lussac, De Candolle, and Robert Brown belonged." His personal habits were peculiar. He slept but four hours, rose at 6 in the winter and 5 in the summer, studied two hours, drank a cup of coffee, and returned to his study to answer letters, of which he received hundreds every day. From 12 to 2 he received visits, and then returned to study till the dinner hour. From 4 till 11 he passed at the table, generally in company with the king, but sometimes at the meeting of learned societies or in the company of friends. At 11 he retired to his study, and his best books are said to have been written at midnight. Many of the works of Humboldt are now almost inaccessible on account of their great cost. A new edition of his select works was published in Stuttgart in 1874, in 36 numbers, including *Kosmos*, with a biographical sketch by Bernhard von Cotta; *Ansichten der Natur*, with scientific explanations; and *Reise in die Äquinoctialgegenden des neuen Continents*, by Hermann Hauff, the only authorized German translation of this work. English translations of his "Travels," "Views of Nature," and "Kosmos" are contained in Boln's "Scientific Library," of which they constitute nine volumes. The translation of "Kosmos" has been republished in New York in 5 vols. 12mo. The centenary of Humboldt's birth, Sept. 14, 1869, was celebrated in Germany and the United States, and eulogies were pronounced by many of the foremost scientific men of the day, among whom were Bastian, Dove, Ehrenberg, Virchow, and Agassiz. Many biographies of him have been published, the best being *Alexander von Humboldt, eine wissenschaftliche Biographie*, edited by Karl Bruhns, a joint production of Avé-Lallemant, Carus, A. and H. W. Dove, Ewald, Grisebach, Löwenberg, Peschel, Wiedemann, Wandt, and the editor, aided by the friends and relatives of Humboldt, and by the Prussian government (3 vols., Leipzig, 1872; English translation by Jane and Caroline Lassells, "Life of Alexander von Humboldt," 2 vols., London, 1872). See also his *Briefe an Varnhagen von Ense aus den Jahren 1827-'58*, published by Ludmille Assing, with extracts from Varnhagen's diaries (Leipzig, 1860); and *Les barons de Forcell*, by Alexandre Duguët (Lausanne, 1873), containing many letters of Humboldt and an interesting account of his negotiations in Madrid for the exploration of the Spanish possessions in both hemispheres.

**HUMBOLDT, Karl Wilhelm von**, baron, a German scholar, brother of the preceding, born in Potsdam, June 22, 1767, died at Tegel, April 8, 1835. In 1788 he went to the university of

in which the author's fondness for monstrous caricature was carried to its height, did not attain so great a success. In 1869 he again refused to avail himself of the privilege of returning to France afforded him by the emperor's proclamation of amnesty of Aug. 15. He published in the *Rappel* a protest against the *plébiscite* of May 8, 1870, ratifying the new reforms of the empire, the violence of which caused it to be officially condemned. After the fall of the emperor and the proclamation of the republic he returned to Paris, and soon after issued an address to the Germans calling upon them to proclaim a German republic and extend the hand of friendship to France. On Feb. 8, 1871, he was elected one of the 43 representatives of the department of the Seine in the national assembly. He there vehemently opposed the parliamentary treaty of peace between France and Germany. This aroused against him the anger of the party of "the right," and on March 8, when he attempted to address the assembly, the opposition was so violent that he left the tribune and immediately resigned his seat. Returning to Paris when the insurrection of the commune broke out, he vainly protested in the *Rappel* against the destruction of the Vendôme column, and soon after went to Brussels, where on May 26 he wrote a letter protesting against the course of the Belgian government in regard to the insurgents of Paris, and offering an asylum to the soldiers of the commune. This excited the hostility of the Belgian government and of the populace of Brussels; his house was surrounded in the night by a mob, and he escaped only by the intervention of the police. Being required by the government to quit Brussels, he went to London, and after the condemnation of the leaders of the commune he returned to Paris and interceded with M. Thiers energetically, though vainly, in behalf of Rossel, Rochefort, and others of the communist leaders. At the election in Paris on Jan. 7, 1872, he was presented by all the radical newspapers as their candidate, but was defeated. During the siege of Paris a new edition of *Les châtiments* was published, and more than 100,000 copies were sold. In 1873 he published a volume of poetry entitled *L'Année terrible*, depicting the misfortunes of France. On May 10 of that year he commenced, in company with his son François and others, the publication of a democratic journal called *Le Peuple Souverain*. His latest novel, *Quatre-vingt-treize* (1874), relates to the war in the Vendée, and introduces Robespierre, Danton, and Marat. It was published simultaneously in French, English, Russian, Italian, Spanish, Portuguese, Dutch, Hungarian, and other languages, Hugo deriving 80,000 francs from these translations alone. The latest edition of Hugo's works, complete to the time of publication, was published in Paris in 1862-'3, in 20 vols., 12mo.—Two of his sons, CHARLES

and FRANÇOIS VICTOR (born in 1828, died Dec. 26, 1873), distinguished themselves as pupils of the Charlemagne college, and in 1848-'50 contributed to the newspaper *L'Événement*, which supported the politics of their father. The elder, on account of an article on the death penalty, was sentenced to six months' imprisonment. Both accompanied their father in his exile, and devoted their leisure hours to literature. Charles published several light novels, among which *La Bohème dorée* was especially successful. François, after translating with considerable success the sonnets of Shakespeare into French, began in 1859 a translation of his dramatic works, which he completed in 1865. The brothers returned to France in 1869, and commenced the publication of the *Rappel* in company with Rochefort, who however soon separated from them. François at the time of his death had nearly completed an edition of a posthumous work by his brother Charles, *Les hommes de l'exil*.—One of the two brothers of Victor Hugo, JULES ABEL (born in 1798, died in 1855), deserves mention as a literary man. Among his many publications were: *Histoire de la campagne d'Espagne en 1823* (2 vols. 8vo, Paris, 1824); *France pittoresque, ou Description des départements et colonies de la France, &c.* (3 vols. 4to, 1833); *France militaire, histoire des armées françaises de terre et de mer de 1792 à 1833* (5 vols. 4to, 1834); and *France historique et monumentale, histoire générale de France depuis les temps les plus reculés jusqu'à nos jours* (5 vols. 4to, with maps and plans, 1836-'43).

**HUGUENOTS**, a name of uncertain origin, first applied by the Roman Catholics of France to all partisans of the reformation, but subsequently restricted to the Calvinists. Some derive it from one of the gates of the city of Tours called Hugons, at which these Protestants held some of their first assemblies; others from the words *Huc nos*, with which their protest commenced; others from *aignos* (Ger. *Eidgenosse*), a confederate. The *Dictionnaire de Trévoux* suggests its derivation from the hiding in secret places and appearing at night like King Hugon, the great hobgoblin of France. Prof. Mahn, in his *Etymologische Untersuchungen*, who quotes no fewer than 15 different derivations, derives the word himself from Hugues, the name of some conspirator or heretic, from which it was formed by the addition of the French diminutive ending *ot*. The reformation in France was but little influenced by Luther, and before Calvin took the lead was almost entirely self-developing. "It was not," says *D'Alembert*, "a foreign importation. It was born on French soil; it germinated in Paris; it put forth its shoots in the university itself, that second authority in Romish Christendom." Anti-Catholic influences had been at work in France from an early age. Arianism had for several centuries been the prevailing religion of a part of southern France, and though it was finally rooted out by the victory of the

Catholic Franks, there remained a widespread dissatisfaction with the religion of the victors. Throughout the middle ages the national sentiment of the race of Languedoc, as the history of the Albigenses and kindred sects amply proves, was prone to sympathize and to identify itself with demands for religious reform, and even with open secession from the church of Rome. (See CATHARISTS.) To these influences was added during the reign of Francis I. the very important aid of courtly fashion, or rather the sympathy of those nobles and scholars who had become interested in the revival of letters, and who in France, as in Germany and other countries of Europe, were involved in animated conflicts with the monks and the prominent theologians of the churches. These elements of courtly, scholarly, or popular opposition to the church gave birth not merely to the humor of Rabelais, but to the poetry and philosophy which sprung up around the beautiful Marguerite of Valois, queen of Navarre, from whom the spirit of the reformation was transmitted to Jeanne d'Albret, the mother of Henry IV. At this court all poets, scholars, and clergymen more or less tinctured with the spirit of reform, such as Lefèvre, Farel, and Roussel, were welcome; and for a time it seemed as though the court and the government of France might be gained for the cause of the reformation. But at length Francis I. like his opponent the emperor Charles V., decided in favor of the old church, as the papal nuncio succeeded in convincing him that "a new religion disseminated among the people must result in a change of kings." In the city of Meaux, around its bishop Bricconnet, a large body of men inclined to the new faith began, without formally professing schism, to act as reformers. Among these were Gérard Roussel, François Vatable, Martial Mazurier, José Clithou, Michel d'Arande, and Guillaume Farel. Their labors, joined to the political and social agitations of the day, soon attracted persecution. It is remarkable that this persecution in France acted so effectively on the French reformation as to free it in a great measure from excesses such as those of the Anabaptists in Germany. Yet it would probably have fallen away had not the strong hand of Calvin taken it up (1528). Hence we find the French reformers embodying Calvin's ideas of church government and discipline in a common confession of faith, which was formally done at the celebrated general synod in May, 1559. During the reign of Henry II. (1547-59) the Huguenots gathered such strength as to entertain hopes of becoming the dominant political party; hopes which were confirmed by the fact that several of the royal family, such as the king of Navarre, his brother the prince de Condé, and many of the nobility, including the Constable and Admiral Coligni, favored the reform. From this blending of religion with politics arose the conspiracy of Amboise, whose object was to overthrow

the power of Duke François of Guise and his brother the cardinal de Lorraine, who with Mary of Scotland ruled the kingdom through the feeble-minded boy-king Francis II. The king of Navarre and prince de Condé were deeply involved in this plot, and would have suffered death with their Calvinist friends had it not been for the unexpected demise of the king. This occasioned a pause in persecution, of which the queen mother, Catharine de' Medici, and the ruling party availed themselves for political purposes, becoming more moderate in their treatment of reformers. By extending toleration to the Augsburg confession, the cardinal de Lorraine shrewdly fomented quarrels between the Calvinists and Lutherans. This state of affairs, which led to terrible commotions, was again temporarily checked by the edict of January, 1562. At this time, during the reigns of two successive kings whose intellectual inferiority rendered a regency always necessary (after 1559), Catharine de' Medici held the reins of authority, while the dukes of Guise supported by the Catholics, and the princes of Bourbon by the Huguenots, contended for the regency. Some liberal concessions, made for the sake of policy by Catharine and the Guises to the Huguenots, excited the anger of the Catholics, and to allay these feelings war was renewed and raged till the peace of St. Germain (1570), when full liberty was guaranteed the Huguenots, and the king's sister given as wife to Henry of Navarre. The leading Protestants were invited to Paris to the nuptials, where on the day of St. Bartholomew, 1572, a general massacre of Protestants was attempted at the instigation of the queen mother. The Huguenots, with Henry of Navarre as leader, now battled against the holy league formed by the Guises and Philip II. of Spain. Charles IX. died a victim to nervous excitement (1574), and Henry III., disgusted with the tyranny of the league, had Henry, duke of Guise, and the cardinal put to death, and fled for safety to the Protestant camp. He was himself assassinated by the Dominican Clément (1589), and was succeeded by Henry of Navarre, who, to pacify these terrible disorders in France, became a Catholic, but secured full freedom of conscience and all political and religious rights to the Huguenots by the edict of Nantes (1598). The murder of Henry IV. by Ravaillac (1610) left the Protestants without a protector. Under his young son and successor Louis XIII. their rights were soon attacked. Cardinal Richelieu, determined to build up royal power and crush all jarring elements, at one time made war upon the Protestants, driving them into an unlucky league with England, which resulted in the siege and capitulation of La Rochelle. But his treatment of them was on the whole tolerant, though its ultimate result was to greatly diminish their numbers and weaken their power. From 1629 to 1661, under Richelieu and especially under his successor Mazarin, there was comparative rest. After the death of Mazarin



several edicts were again published in rapid succession which aimed at reducing and finally exterminating the Huguenots. Colbert, from considerations of national economy, made the utmost efforts to secure toleration for them, but they were of little avail. Two years after his death, in 1695, Louis XIV. published the celebrated revocation of the edict of Nantes, on which occasion at least 500,000 Protestants took refuge in foreign countries. From this time, for many years, their cause was completely broken in France. In the wild mountains of the Cévennes, the religious peasants, under the name of Camisards, waged war against the royal troops for the defence of Protestant principles; but they had finally to succumb. In 1705 there was not a single organized congregation of Huguenots left in all France. Soon, however, the scattered remnants were again collected and the church reorganized by the indefatigable Jean Court. Although under the reign of Louis XV. severe ordinances were again issued against them, they continued to increase, and in the middle of the century found a powerful aid in men like Montesquieu and Voltaire. Their position was greatly improved on the accession of Louis XVI. (1774), and finally the revolution restored to them their full rights, which have been substantially respected by all the succeeding governments of France. The right of convening general synods of the church was, however, not recovered till 1872. The term Huguenot had long before ceased to be the common name of the church, which is now known as the Reformed church of France.—So early as 1555, Coligni attempted, but without success, to establish a Huguenot colony in Brazil. In 1562 he sent out two ships, under the command of Jean Ribault, on a voyage of exploration to Florida, but the attempt to establish a colony was unsuccessful. Many departed for North America even before the revocation of the edict of Nantes. Some settled in and around New Amsterdam, now New York, where their family names are frequent. Others found homes in Massachusetts, Rhode Island, and Virginia. But South Carolina was their favorite resting place, and a large number of the foremost families in that state are of Huguenot origin. This class of emigrants has contributed, in proportion to its numbers, a vast share to the culture and prosperity of the United States. Wherever they settled they were noted for severe morality, great charity, and politeness and elegance of manners. Of seven presidents who directed the deliberations of the congress of Philadelphia during the revolution, three, Henry Laurens, John Jay, and Elias Boudinot, were of Huguenot parentage.—Among the copious existing sources of Huguenot history, the principal are: Beza, *Histoire ecclésiastique de l'Église réformée du royaume de France* (Antwerp, 1580); Weiss, *Histoire des réfugiés protestants de France* (Paris, 1843; translated by H. W. Herbert, New York, 1854); Gieseler,

*Lehrbuch der Kirchengeschichte* (Bonn, 1845-7); Berthold, *Deutschland und die Hugenotten* (Bremen, 1848); Félice, *Histoire des protestants de France* (Paris, 1851); the *Bulletin de la société de l'histoire du protestantisme français*; *La France protestante*, by Eugène and Émile Haag (9 vols., Paris, 1859); Smiles, "The Huguenots: their Settlements, Churches, and Industries in England and Ireland" (London, 1867; American edition, New York, 1869, containing a valuable appendix on the Huguenots in the United States, by G. P. Disoway, a descendant of a Huguenot family); Hugues, *Histoire de la restauration du protestantisme de France au XVIII<sup>e</sup> siècle* (2 vols., Paris, 1872).

**HULLIN**, or **HULLIN**, Pierre Augustin, count, a French general, born in Paris, Sept. 6, 1758, died Jan. 9, 1841. He enlisted in the army when scarcely 13 years old, entered the regiment of French guards, and was a sergeant when the revolution broke out. He sided with the people, distinguished himself by his valor and humanity at the taking of the Bastille, July 14, 1789, and was appointed captain in the national guards under Lafayette. During the reign of terror he was imprisoned, but was liberated after the fall of Robespierre. In 1796 he joined the army of Italy under Bonaparte, who appointed him adjutant general; he was governor of Milan in 1797-'8, and was in Paris on the 18th Brumaire, when he supported his general. He followed Bonaparte in Italy during the campaign of Marengo; was made brigadier general in 1803; presided over the court martial which sentenced the duke d'Enghien to death, March 21, 1804; received the rank of general of division and the command of the first military division in 1807; and was the next year created count of the empire. He held the command of Paris until the first restoration; and although, after the abdication of Napoleon, he had sent in his adhesion to the new government, he was dismissed by the Bourbons. He resumed his post during the hundred days, was arrested on the second restoration, and compelled to leave France, but was allowed to return in 1819. Under the title of *Explications offertes aux hommes impartiaux au sujet de la commission militaire instituée en l'an XII pour juger le duc d'Enghien* (Paris, 1823), he published a plain account of his part in that tragedy.

**HULL**, or **Kingston-upon-Hull**, a municipal and parliamentary borough and seaport of England, in the East riding of Yorkshire, on the river Hull, at its mouth in the Humber, 34 m. S. E. of York, 154 m. N. of London, and 20 m. from the sea; pop. in 1871, 121,598. It is built on a low plain, protected against inundation by artificial means, and extends more than 2 m. along the W. bank of the Hull, and nearly the same distance along the N. bank of the Humber. The streets are very irregular, but are mostly well paved, lighted, and drained. The residences of the wealthy inhabitants are principally in the parish of Seuloates and the

quarter called Myton. A part of the town built along the left bank of the Hull is connected with the remainder by a bridge of four arches. On the point of land formed by the junction of the two rivers there is a fort which commands the whole harbor. Adjoining it is the Victoria dock. The old dock, opened in 1778 on the Hull, is nine acres in extent, and can accommodate 100 square-rigged ships. There is also a railway dock at the terminus of the Hull and Selby railway. Other docks have been built of late years, and the total area of all the docks of Hull in 1874 was about 87½ acres. The principal public buildings are the custom house, exchange, post



Town Hall, Hull.

office, mansion house, courts of law, jail and house of correction, assembly rooms and museum, concert rooms, two theatres, several banks, and coin exchange. The Holy Trinity church is a handsome cruciform edifice of several dates; the oldest portion was built in 1270. The town has several charitable schools, one of which educates 36 boys to be seamen, and is connected with the Trinity house founded in 1667 for the relief of decayed seamen and the widows of seamen. There is a marine hospital attached to it. Hull college, founded in 1527, occupies a fine Grecian building. There are also a lunatic asylum, a general infirmary, a school of medicine and anatomy, various literary associations with libraries, and botanic

and zoological gardens and a "People's Park" of 27 acres given by Sir Z. C. Pearson in 1864. The manufactures include canvas, chains, machinery, earthenware, chemicals, leather, sugar, cotton and linen goods, &c. There are ship-building yards, rope walks, saw mills, grist mills, bone mills, and oil mills. The principal exports are hardware and manufactures of cotton and woollen; the imports, timber, tar, pitch, rosin, grain, wool, flax, hemp, iron, hides, tallow, horns, bones, &c. The trade is chiefly along the coast, with the Baltic ports, and with Germany, Holland, Belgium, Denmark, and America. Hull is an important station for steam packets which connect it with various ports of Great Britain and the continent, and also has railway communication with nearly all parts of the kingdom. The total imports in 1871 were valued at £15,076,095, the exports at £27,387,071. The entrances were 3,417 vessels, of 1,188,841 tons; clearances, 2,911 vessels, of 1,044,158 tons. Hull ranks as the third port in the kingdom.

**HULL, Isaac**, an American naval officer, born at Derby, Conn., March 9, 1775, died in Philadelphia, Feb. 3, 1843. He commenced his career in the merchant service, and was commissioned as lieutenant in the navy at the commencement of hostilities with France in 1798. In 1800 he was first lieutenant of the frigate *Constitution*, and performed a very gallant achievement in cutting out a French letter of marque from under the guns of a strong battery in the harbor of Port Platte, Santo Domingo. During the war with Tripoli, 1802-'5, Hull served with distinction in the several attacks on the city of Tripoli in July, August, and September, 1804, and subsequently cooperated with Gen. Eaton in the capture of Derne. In 1806 he was made captain. At the opening of the war of 1812 between the United States and Great Britain, he was in command of the frigate *Constitution*, and in July of that year, while cruising off New York, he fell in with a British squadron consisting of a razez of 64 guns and four frigates, which chased the *Constitution* closely for nearly three days and nights. By the greatest efforts, and the exercise of a skill in handling his ship which excited the admiration of his pursuers, he succeeded in escaping. After this remarkable feat, Hull went into Boston for a few days, whence he sailed Aug. 3, and on Aug. 19, in lat. 41° 41' N., lon. 55° 48' W., discovered a ship to leeward, which was soon made out to be an English frigate. The course of the *Constitution* was shaped to close with this vessel, which hove to to await an engagement. At 5 P. M. the English frigate opened her fire at very long range, and at a little after 6 the *Constitution* closed with her. After a desperate fight of about half an hour the English frigate was reduced to a wreck and surrendered. She proved to be the *Guerriere*, Capt. Daeres, one of the ships which had recently eluded the *Constitution*. Possession was taken of her soon after 7 P. M. The next

rooms and conservatories for months, feeding on sugar or honey and water and the insects attracted by these, and have become so tame as to take their sweetened fluids from the end of the finger. They are incidentally honey eaters, but essentially insectivorous: their barbed and viscid tongue is admirably adapted for drawing insects from the depths of tubular flowers, over which they delight to hover. The family of *trochilidae* may be recognized by their diminutive size, gorgeous plumage, long, slender, and acute bill, but little cleft at the base, and peculiar tongue; the species are very numerous, probably as many as 400, some of which have a very limited range. The bill when closed forms a tube, through which the long, divided, and thread-like tongue may be protruded into deep flowers; there are no bristly feathers around its base, as in birds which catch insects on the wing; the tongue has its cornua elongated backward, passing around the back to the top of the skull, as in woodpeckers; the wings are long and falconiform, with very strong shafts, the first quill of the ten the longest; the secondaries usually six; the tail is of various forms, but always strong, and important in directing the flight; the tarsi short and weak; the toes long and slender, and capable of sustaining them in a hanging position, as is known from their being not unfrequently found hanging dead from branches in the autumn after a sudden cold change in the weather.—The subfamily *gryppinae* have the bill slightly curved, and the tail long, broad, and wedge-shaped; of these

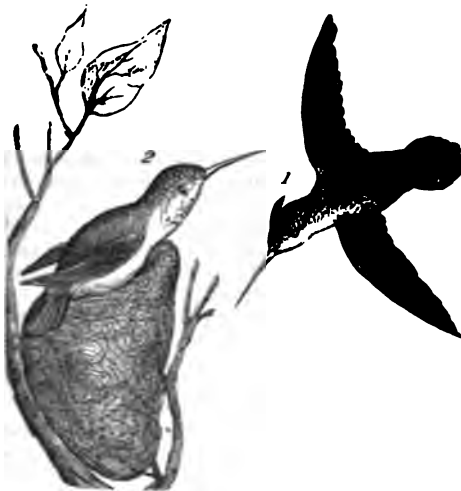

Ruf-necked Humming Bird (*Selasphorus rufus*).  
1. Male. 2. Female.

the genus *phainopepla* (Swains.) is found in the warmer parts of South America, and is numerous in species; *oreotrochilus* (Gould) inhabits the mountains of the western side of South America immediately beneath the line

of perpetual snow, feeding upon the small heterocerous insects which resort to the flowers; *grypus* (Spix) is found in the neighborhood of Rio de Janeiro. The ruff-necked humming bird (*Selasphorus rufus*, Swains.), of the western



Anna Humming Bird (*Althis Anna*).  
1. Male. 2. Female.

parts of North America, is about 3½ in. long, with a wedge-shaped tail; in the male the upper parts, lower tail coverts, and tail are cinnamon-colored, the latter edged or streaked with purplish brown; throat coppery red, with a ruff, and below it a white collar; in the female the back is greenish, and the metallic reflections are less brilliant. The Anna humming bird (*althis Anna*, Reich.) is somewhat larger, also inhabiting California and Mexico;

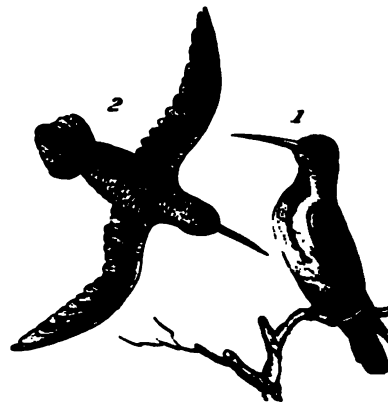

Mango Humming Bird (*Lamprolaima mango*).  
1. Male. 2. Female.

the tail is deeply forked; top of head, throat, and ruff metallic red, with purple reflections; rest of upper parts and band on breast green; tail purplish brown; in the female the tail is somewhat rounded, barred with black and

l with white, and the general color above lue green. A second species of the last enera is described by Prof. Baird in vol. the Pacific railroad reports.—The curved- humming birds, more than 100 species, ot represented in the United States, un- e mango humming bird (*Lampornis man- vains*.) be admitted; this may be distin- ed from the common species by the ab- of metallic scale-like feathers on the t, and by the serrations of the end of the the prevailing colors are metallic green olden above, and velvety bluish black be- with a tuft of downy white feathers under rings.—The common species throughout astern states, extending to the high cen- rains, and south to Brazil, is the ruby- ted humming bird (*Trochilus colubris*, ). The length of this "glittering frag- of the rainbow" (as Audubon calls it) out 3½ in. with an extent of wings of 4½



Ruby-throated Humming Bird (*Trochilus colubris*).

The upper parts are uniform metallic green, a ruby red gorget in the male, a white on the throat, and the deeply forked tail bluish violet; the female has not the red t, and the tail is rounded, emarginate, and d with black. The corresponding spe- n the Pacific coast is the black-chinned *alexandri* (Bourc. and Mulsant). The last belong to the subfamily of *trochilinae* or *virginiae*, having straight bills; their genus n by Gray as *mellinaga* (Briss.), of which are more than 100 species. The largest hummingbird belongs to this subfam- id is the *hylocharis gigas* (Vieill.); it is 8 in. long, brownish green above and reddish below; the wings are longer than the deeply forked tail, and the general appear- is that of a brilliant swallow, with a long ht bill.—Those wishing to study in detail the complicated arrangement of this beauti- nity are referred to the illustrated works sson, Temminck, Audebert, and Vieillot,

and especially to Gould's monograph on the *trochilidae*; also to vols. xiv. and xv. of the "Naturalists' Library."

**HUMPHREY, Heman**, an American clergyman, born in Simsbury, Conn., March 26, 1779, died in Pittsfield, Mass., April 3, 1861. From the age of 16 he was engaged for several successive winters as a teacher in common schools. He graduated at Yale college in 1805, studied theology, and was pastor of the Congregational church in Fairfield, Conn., from 1807 to 1817, and in Pittsfield, Mass., from 1817 to October, 1823, when he became president of Amherst college, then unincorporated. Principally through his influence it obtained an act of incorporation the next year, and he presided over it till 1845, when he resigned, and devoted himself to literary pursuits, residing in Hatfield, Mass., and afterward in Pittsfield. He was one of the earliest advocates of the temperance cause. In 1810 he preached six sermons on intemperance, and in 1813 drew up a report to the Fairfield consociation which is believed to have been the earliest tract on the subject. Among his writings are: a prize essay on "The Sabbath" (1830); "Tour in France, Great Britain, and Belgium" (2 vols. 12mo, New York, 1838); "Domestic Education" (1840); "Letters to a Son in the Ministry" (Amherst, 1845); "Life and Writings of N. W. Fiske" (1850); "Life and Writings of T. H. Gallaudet" (1857); "Sketches of the History of Revivals" (1859); and "Revival Sketches" (1860). A volume entitled "Memorial Sketches of Heman and Sophia Humphrey," by Z. M. Humphrey and Henry Neill, was printed for the use of the family.

**HUMPHREYS**, a N. W. county of Tennessee, bounded E. by Tennessee river, and intersected near its S. border by Duck river, a tributary of the former stream; area, 375 sq. m.; pop. in 1870, 9,326, of whom 1,295 were colored. The surface is moderately uneven, and the soil is fertile. The Nashville and Northwestern railroad passes through it. The chief productions in 1870 were 27,783 bushels of wheat, 491,355 of Indian corn, 29,967 of oats, 62,766 of peas and beans, 18,502 of Irish and 17,829 of sweet potatoes, 113,177 lbs. of tobacco, and 107 bales of cotton. There were 1,971 horses, 914 mules and asses, 2,355 milch cows, 4,488 other cattle, 8,937 sheep, and 18,418 swine; 1 manufactory of woollen goods, 1 of ground bark, 2 saw mills, 6 tanneries, and 5 currying establishments. Capital, Waverley.

**HUMPHREYS, Andrew Atkinson**, an American soldier, born in Pennsylvania about 1812. He graduated at West Point in 1831, and served mainly in topographical duty till 1836, when he resigned his commission in the army, and became a civil engineer in the United States service. In 1838 he was reappointed in the army, serving generally in the topographical department, and from 1844 to 1849 had charge of the coast survey office at Washington. In 1849-'50 he was engaged in making topographic

and hydrographic surveys of the delta of the Mississippi, continuing in general charge of the work till 1861, when he published a voluminous and very valuable "Report upon the Physics and Hydraulics of the Mississippi River." During the civil war he was on the staff of McClellan until his superseding by Burnside, was made brevet colonel for his services in the battle of Fredericksburg, commanded a division at Chancellorsville and at Gettysburg, and after the last battle became chief of the staff of Gen. Meade, being appointed major general of volunteers, July 8, 1863. He took an active part in the campaigns of 1864 and 1865, succeeding Hancock in the command of the 2d corps. He was brevetted brigadier general in the regular army for gallant conduct at Gettysburg, and major general for services at the battle of Sailor's Creek, the closing battle of the war (April 7, 1865). From July to December, 1865, he commanded the district of Pennsylvania, and thereafter he was in charge of the examination of the Mississippi levees till August, 1866, when he was appointed chief of engineers of the United States army, with the rank of brigadier general.

**HUMPHREYS, David**, an American poet, born in Derby, Conn., in July, 1752, died in New Haven, Feb. 21, 1818. He was educated at Yale college, entered the army at the beginning of the revolutionary war, and in 1780 became a colonel and aide-de-camp to Washington. He resided more than a year with Washington after his retirement to Virginia, and again in 1789. He accompanied Jefferson to Europe as secretary of legation in 1784, was elected to the legislature of Connecticut in 1786, and was soon associated with Lemuel Hopkins, John Trumbull, and Joel Barlow in the composition of the "Anarchiad," a series of poems which appeared in the "New Haven Gazette" and the "Connecticut Magazine." These poems were satirized as being the production of "four bards with Scripture names." An edition of them, purporting to be "the first published in book form, edited, with notes and appendices, by Luther G. Riggs," was published at New Haven in 1861. Humphreys was minister to Lisbon from 1791 to 1797, and afterward minister to Spain till 1802, and on his return imported from Spain 100 merino sheep, and engaged in the manufacture of woollens. He held command of two Connecticut regiments in the war of 1812, after which he lived in retirement. His principal poems are: an "Address to the Armies of the United States" (1782); a "Poem on the Happiness of America;" a tragedy, entitled "The Widow of Malabar," translated from the French of Le Mierre; and a "Poem on Agriculture." His "Miscellaneous Works" (New York, 1790 and 1804) contain besides his poems a biography of Gen. Putnam and several orations and other prose compositions.

**HUMUS** (Lat. *humus*, the soil), vegetable mould, or the product of the decay of vegeta-

ble matter. When portions of a decayed stump or the decayed matter of peat is digested in a weak solution of caustic potash or soda, a brown liquid is formed, which on the addition of an acid deposits a dark brown precipitate. This is a mixture, according to Mulder, of three substances, which he considers as compounds of water, or of water and ammonia, with three different acids, viz.: 1, geic acid,  $C_{20}H_{12}O_7$ ; 2, humic acid,  $C_{20}H_{12}O_8$ ; 3, ulmic acid,  $C_{10}H_{10}O_6$ . It has been doubted, however, whether humus has so definite a composition. Mulder also found that the brown substances formed by the prolonged action of boiling dilute acids upon sugar resemble ulmic and humic acids derived from mould, both in chemical composition and properties. Humus may be regarded as in a state of continuous decomposition or *eremacausis*, a species of slow combustion (see *EREMACAUISIS*), in which the hydrogen of the vegetable matter is more rapidly removed by oxidation than the carbon, so that it contains an excess of the latter element. The formation of water, carbonic acid, and ammonia, and the elimination of mineral constituents in the decay of woody fibre is one cause of the beneficial action of vegetable manures in promoting the growth of plants.

**HUMAYA**, a river of Honduras, rising at the S. extremity of the plain of Comayagua, and flowing due N. for a distance of about 100 m. to a point N. of the town of Yojoa, where it unites with the rivers Blanco and Santiago or Venta, forming the great river Ulua, which falls into the bay of Honduras, about 25 m. N. E. of the port of Omoa. For the greater part of its course it is a rapid stream, and only navigable for canoes. It is principally interesting in connection with the interoceanic railway through Honduras, in course of construction (1874) through its valley. Comayagua, the capital of Honduras, stands on its E. bank.

**HUNDRED**, the name given in some parts of England to the subdivision of a shire, which may have received the appellation from having comprised 100 families, 100 warriors, or 100 manors. The existing divisions of this name differ greatly in area and population. The hundred is by some considered to have been a Danish institution, adopted by King Alfred about 897, each county being divided into tithings, of which 10 or 12 made a hundred, presided over by a decanus, head borough, or hundred man. The hundreds were represented in the "shiremote," which, under the presidency of its earl and bishop or sheriff, regulated the affairs of the county. The jurisdiction of the hundred was vested in the sheriff, although it was sometimes a special grant from the crown to individuals, and he or his deputy held a court baron, or court leet. The hundred was held responsible for felons until delivered up.—The townships of the state of Delaware are called hundreds.

**HUNFALVY, I. Pál**, a Hungarian philologist, born at Nagy-Szálók, March 12, 1810. He

became in 1842 professor of jurisprudence at Kásmark, was a member of the Hungarian diet of 1848-'9, and has since lived in Pesth. He has written and edited a number of philological and ethnological publications, including *Chrestomathia Fennica* (Pesth, 1861), and "The Land of the Voguls" (3 vols., 1863), after the accounts of the Hungarian traveller Kézely. **H. János**, a Hungarian geographer, brother of the preceding, born at Gross-Schlagentorf, June 8, 1820. He became in 1846 professor of statistics and history at Kásmark, took part in the revolutionary movement of 1848-'9, and was imprisoned, but in 1850 resumed his duties at Kásmark, and was subsequently suspended for advocating the independence of Protestant education. He removed to Pesth in 1853, and became professor of statistics, geography, and history at the polytechnic institute of Buda. His works include a "Universal History" (3 vols., Pesth, 2d ed., 1862), "Physical Geography of Hungary" (3 vols., 1863-'6), the text to the pictorial work "Hungary and Transylvania" (3 vols., Darmstadt, 1859-'64), and a Hungarian edition of the "Travels" of Ladislas Magyar (Pesth, 1859).

**HUNGARY** (Hung. *Magyarország*, Magyar land; Ger. *Ungarn*), a country of Europe, formerly an independent kingdom, subsequently united with Austria, from 1849 to 1867 a crown-land or province of the latter, and since 1867 one of the two main divisions of the Austro-Hungarian monarchy. Before 1849 it embraced in a constitutional sense, besides Hungary proper, Croatia, Slavonia, and the Hungarian Littoral (coast land on the Adriatic), and in its widest acceptance also Transylvania, the Military Frontier, and Dalmatia, with an aggregate population of about 15,000,000. All these dependencies were in 1849 detached, and besides them from Hungary proper the counties of Middle Szolnok, Zaránd, and Kraszna, and the district of Kővár, to be reunited with Transylvania, and the counties of Bács, Torontál, Temes, and Krassó, to form the new crown-land of the Serbian Waywodeship and Banat. In 1867 the changes made in 1849 were repealed; the Waywodeship was abolished, Transylvania reunited with Hungary, and Croatia and Slavonia recognized as a dependency of the Hungarian crown, which has its own provincial assembly, but also sends deputies to the Hungarian diet, and is subordinate to the Hungarian ministry. The Military Frontier, which formerly had its separate administration, was destined to gradual incorporation partly with Hungary proper and partly with Croatia. Dalmatia was united with Cisleithan Austria. Thus Hungary in the wider sense, also called Transleithania or Transleithan Austria, from the little river Leitha which constitutes part of the frontier between the two main divisions of the monarchy, now comprises (the reorganization of the Military Frontier having become complete in 1873) Hungary proper, Transyl-

vania, Croatia and Slavonia, and Fiume. The lands of the Hungarian crown have in common with Cisleithan Austria an imperial ministry, consisting of the departments of foreign affairs and the imperial house, of finances, and of war. In the article AUSTRIA we have treated of the Austro-Hungarian monarchy as a whole; and the articles CROATIA, MILITARY FRONTIER, SLAVONIA, and TRANSYLVANIA will contain what is or lately was peculiar to those sections. In this article we shall treat of the lands of the Hungarian crown with special reference to that section which is called Hungary proper. Hungary (in the wider sense) is situated between lat. 44° 11' and 49° 35' N., and lon. 14° 25' and 26° 30' E., and is bounded N. E., N., and W. by Cisleithan Austria, S. and E. by the Turkish provinces and dependencies Bosnia, Servia, and Roumania. The total area of the lands of the Hungarian crown is 125,045 sq. m., of which 87,045 belong to Hungary proper. The population, according to the census of 1869, was 15,509,455, of whom 11,530,397 lived in Hungary proper.—Hungary in its chief parts forms a large basin surrounded almost entirely by mountain ranges, of which the principal are: the Carpathians, which encircle the north, with their various offshoots, the Hungarian Ore mountains between the Waag and the Eipel, the Mátra E. of the preceding, and the wine-growing Hegyalja between the Theiss and the Hernád; the Leitha range, the wooded Bakony, and the Vértes, mostly continuations of the Noric and Carnic Alps, in the S. W. division; and the Transylvanian Alps on the S. E. frontier. The chief artery of the country is the Danube, which enters it between Vienna and Pre-burg, and on its course to the Black sea receives the waters of all the other rivers, excepting only the Poprád, which rises near the N. boundary and flows to the Vistula. The principal of these affluents of the Danube are: on the right, the Leitha, Raab, Sárviz, and the Drave, which separates Hungary proper from Slavonia, with the Mur, its affluent; on the left, the March, Waag, Neutra, Gran, Eipel, Theiss, and Temes. The Theiss rises in the northeast, in the county of Marmaros, and its chief affluents are the Bodrog, Hernád, Sajó, and Zagyva on the right, and the Szamos, Körös, and Maros on the left. Most of the rivers of Croatia and Transylvania are also tributaries of the Danube; among others, the Save on the Turkish frontier and the Alt from Transylvania. The S. W. division, which has the fewest rivers, includes the two principal lakes of the country, the Balaton and the Neusiedler. Various marshes, moors, soda lakes, and swamps extend near the banks of the great rivers, especially of the Theiss. There are also numerous mountain lakes called "eyes of the sea," and caverns, of which that of Agtelek in the county of Gömör is the most remarkable. Extensive islands are formed by the branches of the Danube; among others, the Great Schütt and Csepel in its upper course. The climate is in general mild,

son, and he attended the king to the baths of Teplitz. On the news of the French revolution and the accession of Louis Philippe, he was selected to convey to Paris the Prussian recognition of the new monarch, and to send political advices to Berlin. The latter office fell to him again in 1834-5, and he was called upon to fulfil it five times in the following twelve years, residing four or five months in Paris on each mission. To this period belongs the publication of his *Examen critique de la géographie du nouveau continent* (5 vols., Paris, 1835-'8; translated into German by Ideler, 5 vols., Berlin, 1836 *et seq.*). He made a rapid journey with King Frederick William IV. to England in 1841, to attend the baptism of the prince of Wales, to Denmark in 1845, and resided in Paris several months in 1847-'8, from which time he lived in Prussia, usually in Berlin, pursuing his scientific labors in his advanced age with undiminished zeal and energy.—Humboldt was distinguished, as a man of science, for the comprehensiveness of his researches, and especially for the skill and completeness with which he connected his own observations with all the stores of previous knowledge, and for the clearness with which he expounded facts in their relations. This tendency appeared in one of his earliest works on the contraction of the muscles and nerves, in which, after the progress of physiology for more than half a century, may still be seen the sagacity of his experiments on galvanism, and the truth of most of the inferences which he drew. In his travels he measured elevations, and investigated the nature of the soil and the thermometrical relations, at the same time collecting herbariums, and founding, by a combination of the materials in his hands, the new science of the geography of plants. Linnæus and some of his successors had observed some of the more palpable phenomena of the migrations of plants, without, however, considering elevation or temperature. It remained for Humboldt to bring together the vast series of facts collected from the most remote points, to combine them with his own observations, to show their connection with the laws of physics, and to develop the principles in accordance with which the infinitely numerous forms of the vegetable world have been spread over the earth. He was the first to see that this distribution is connected with the temperature of the air, as well as with the altitudes of the surface on which they grow, and he systematized his researches into a general exposition of the laws by which the distribution of plants is regulated. Connected with this subject he made those extensive investigations into the mean temperature of a large number of places on the surface of the globe which led to the drawing of the isothermal lines, so important in their influence in shaping physical geography and giving accuracy and simplicity to the mode of representing natural phenomena. By associating many important questions with bot-

any, he made it one of the most attractive of the natural sciences. He showed the powerful influence exercised by vegetable nature upon the soil, upon the character of a people, and upon the historical development of the human race. This view of the connection between the physical sciences and human history opened a path which has been followed by a school of subsequent investigators with novel and important results. Though wholly free from mystical meanings and obscure phraseology, his works are marked by poetical conceptions of nature wherever it is his aim to present broad and complete pictures. His delineations of the tropical countries give delight to readers who have no special knowledge or interest in natural history. At the beginning of this century even the coasts of the immense Spanish colonies in America were scarcely known, and but little confidence was placed in the best maps. More than 700 places which he made astronomical measurements were calculated anew by Oltmanns, whose work (2 vols., Paris, 1808-'10) forms the fourth part of Humboldt's "Travels." He himself made the map of the Orinoco and the Magdalena, and the greater part of the atlas of Mexico. He travelled with the barometer in his hand from Bogotá to Lima, ascended the peaks of Teneriffe, Chimborazo, and numerous other mountains, and made 459 measurements of altitude, which were often confirmed by trigonometrical calculations. His measurements in Germany and Siberia, combined with those made by other travellers, furnished valuable results to geography, and were the foundation of theories of the dispersion of plants and animals. Climatology was intimately connected with his researches. By his daily record of the meteorological, thermometrical, and electrical phenomena of the countries through which he passed, he instituted the science of comparative climatology. He was the first to entertain the idea of estimating the average elevation of continents above the sea, previous geographers and geologists having considered only the altitude of mountain chains and of the lower lands. His principal works in this department are: *Physique générale et géologie* (Paris, 1807); *Essai géognostique sur le gisement des roches dans les deux hémisphères* (1823-'6); and *Fragments de géologie et climatologie asiatique* (2 vols., 1831 translated into German by Löwenberg, Berlin, 1832). The phenomena of the volcanoes of South America and Italy he keenly observed and explained. With Bonpland he made very important observations on the sites, uses, and structure of plants. His principal botanical works are *Essai sur la géographie des plantes* (Paris, 1805), and *De Distributione Geographica Plantarum secundum Cæli Temperiem et Altitudinem Montium* (1817). The rich herbarium collected by him and Bonpland contained more than 5,000 species of phanerogamous plants, of which 3,500 were new. They were arranged and illustrated by Humboldt

Bonpland, and Kunth, in the following works, which form the sixth part of his "Travels:" *Plantes équinoxiales, recueillies au Mexique, dans l'île de Cuba, &c.* (2 vols., 1809 et seq., with 144 plates); *Monographie des mélastomes et autres genres du même ordre* (2 vols., 1809-'23, with 120 colored plates); *Nova Genera et Species Plantarum, &c.* (7 vols., 1815-'25, with 700 plates); *Mimosa et autres plantes légumineuses du nouveau continent* (1819-'24, with 60 plates); *Synopsis Plantarum, &c.* (4 vols., 1822-'61); *Révision des graminées* (2 vols., 1829-'34, with 220 colored plates). The zoological results of his travels are contained in his *Kecueil d'observations de zoologie et d'anatomie comparée* (2 vols., 1805-'32), in the publication of which he was aided by Cuvier, Latreille, and Valenciennes. Another costly work, the *Vues des Cordillères et monuments des peuples indigènes de l'Amérique* (1810, with 69 plates), contains elaborate pictures of the scenery of the Andes and of the monuments of the ancient civilization of the aborigines. The study of the great architectural works of the ancient Mexicans and Peruvians led Humboldt to investigations of their languages, records, early culture, and migrations. In this department his treatment was peculiar, for his *Essai politique sur le royaume de la Nouvelle Espagne* (2 vols., 1811) contained statistics united with the facts of natural history, and presented various doctrines of political economy from a new point of view. Especially original and influential were his reflections on the culture of the soil under different climates and on its effects upon civilization, and on the circulation of the precious metals. Besides his general works, he made many special investigations, as his treatise on the geography of the middle ages, in which he appears at once as historian, astronomer, and savant, his chemical labors with Gay-Lussac, his system of isothermal lines, his experiments on the gymnotus and on the respiration of fishes, and numerous contributions to physical geography. Soon after his return from America he gave a general sketch of the results of his inquiries in his *Ansichten der Natur* (Stuttgart, 1808), in which he aimed to present a picture of the physical world, exclusive of everything that relates to the turmoil of human society and the ambitions of individual men; and in the evening of his life he determined to give a systematic view of the results of his investigation and thought in the whole domain of natural science. This was the design of his *Kosmos* (5 vols., Stuttgart, 1845-'62), which explains the physical universe according to its dependencies and relations, grasps nature as a whole moved and animated by internal forces, and by a comprehensive description shows the unity which prevails amid its variety. He died before he completed this work, but the last volume was published after his death. It was translated into almost all the European languages, and has been without an equal in giving

an impulse to natural studies. To his personal influence is due nearly all that the Prussian government did for science in the latter part of his life. Agassiz says of him: "The personal influence he exerted upon science is incalculable. With him ends a great period in the history of science; a period to which Cuvier, Laplace, Arago, Gay-Lussac, De Candolle, and Robert Brown belonged." His personal habits were peculiar. He slept but four hours, rose at 6 in the winter and 5 in the summer, studied two hours, drank a cup of coffee, and returned to his study to answer letters, of which he received hundreds every day. From 12 to 2 he received visits, and then returned to study till the dinner hour. From 4 till 11 he passed at the table, generally in company with the king, but sometimes at the meeting of learned societies or in the company of friends. At 11 he retired to his study, and his best books are said to have been written at midnight. Many of the works of Humboldt are now almost inaccessible on account of their great cost. A new edition of his select works was published in Stuttgart in 1874, in 36 numbers, including *Kosmos*, with a biographical sketch by Bernhard von Cotta; *Ansichten der Natur*, with scientific explanations; and *Reise in die Äquinoctialgegenden des neuen Continents*, by Hermann Hauff, the only authorized German translation of this work. English translations of his "Travels," "Views of Nature," and "Kosmos" are contained in Bohn's "Scientific Library," of which they constitute nine volumes. The translation of "Kosmos" has been republished in New York in 5 vols. 12mo. The centenary of Humboldt's birth, Sept. 14, 1869, was celebrated in Germany and the United States, and eulogies were pronounced by many of the foremost scientific men of the day, among whom were Bastian, Dove, Ehrenberg, Virchow, and Agassiz. Many biographies of him have been published, the best being *Alexander von Humboldt, eine wissenschaftliche Biographie*, edited by Karl Bruhns, a joint production of Avé-Lallemant, Carus, A. and H. W. Dove, Ewald, Grisebach, Löwenberg, Peschel, Wiedemann, Wandt, and the editor, aided by the friends and relatives of Humboldt, and by the Prussian government (3 vols., Leipzig, 1872; English translation by Jane and Caroline Lassells, "Life of Alexander von Humboldt," 2 vols., London, 1872). See also his *Briefe an Varnhagen von Ense aus den Jahren 1827-58*, published by Ludmille Assing, with extracts from Varnhagen's diaries (Leipzig, 1860); and *Les barons de Forstl*, by Alexandre Daguët (Lausanne, 1873), containing many letters of Humboldt and an interesting account of his negotiations in Madrid for the exploration of the Spanish possessions in both hemispheres.

**HUMBOLDT, Karl Wilhelm von**, baron, a German scholar, brother of the preceding, born in Potsdam, June 22, 1767, died at Tegel, April 8, 1835. In 1788 he went to the university of



Frankfort-on-the-Oder, and thence to Göttingen, where he studied philology under the care of Heyne. He here became intimate with George Forster, and through him with Jacobi and Johannes von Müller. When the French revolution broke out, Wilhelm Humboldt, who had long been a reader of Rousseau, went to Paris (July, 1789), in company with Campe; and the result of his observations there was a great distrust of many theories and abstract ideas which he had previously held. Two years later he published his first work on the subject, a memoir in the *Berliner Monatschrift* (1792), entitled *Ideen über Staatsverfassung durch die neue französische Constitution veranlasst*, in which he combated the possibility of establishing a constitution on untried theories. He discussed the subject more fully at a later date in a separate book: *Ideen sur un essai de déterminer les limites de l'action que doit exercer l'état*. After completing this work he laid it aside, judging the time inopportune for its publication, and afterward lost the manuscript, which was not found or published until after his death; but there is every reason to believe that he always entertained the opinions expressed in it. The keynote of the work is individual liberty. It presents a lofty ideal of the rights and duties of the individual, and of the dignity and nobleness to which human nature is able and ought to attain. The government which hinders individual development the least is to him the best. About this time philology and archæology had become prominent objects of investigation, and Humboldt, under the guidance of Heyne and Wolf, entered upon the study of Greek literature and art. An early result of his studies appeared in his "Essay on the Greeks" (1792). In July, 1791, he had married Caroline Dacheröden, a brilliant woman, who shared with him his Greek studies. In 1793, at Jena, he contracted with Schiller an intimacy which had great influence on his studies, the poet inducing him to apply himself more closely to philosophy and æsthetics. To this intimacy was added that of Goethe, who was then writing "Hermann and Dorothea." This work owed much to the criticisms and care of Humboldt, who not only superintended its printing, but wrote a commentary on it which ranks as a masterpiece of German criticism. In 1797, having lost his mother, he began his travels. After remaining with his family some time at Dresden, he went to Vienna and thence to Paris, where he arrived in November. He resided a year and a half in Paris, and then went to Spain, where he travelled during six months. At this time he was occupied with his system of comparative anthropology, or a philosophical history of mental development, in which every phase of literature should be traced to a corresponding civilization. This he based on philology, and his first studies were directed to the old Spanish languages, and particularly the Basque. He returned to Germany in 1801,

and was soon after appointed Prussian resident minister in Rome, where he distinguished himself as much in diplomacy as in letters. His knowledge of art enabled him to cultivate friendly personal relations, and his residence became a point of union for the most intelligent men in Rome. His letters to Goethe and Schiller, his translations of Pindar and Æschylus, and the poems written during this period, indicate great activity and versatility. In 1806 the defeat of Prussia at Jena rendered his political position a most trying one. He remained unwillingly at Rome during 1807, being desirous of contributing his aid to his country while recovering from its disasters. In 1808 he was recalled by family affairs, and was immediately appointed minister of state for the departments of religion, public education, and medical establishments. He was called under very trying circumstances, in January, 1809, to reorganize public instruction in Prussia; and the prominent position which that country at present holds in education is in a great measure due to him. In the midst of the apathy and despondency bordering on despair which at that time affected the people and government of Prussia, he succeeded in establishing the university of Berlin, and from its foundation until his death his contributions formed the chief glory of its transactions. All his reforms were effected during a period of general confusion, and in the face of opposition which demanded great firmness, and often severity. When they were fairly established, he reentered the diplomatic service, and on June 14, 1810, was appointed minister at the court of Vienna. At Prague he met with the minister Stein, who was then flying from the pursuit of Napoleon, and with him concerted the part he was to take in the political struggles of the day. Stein had been greatly interested in the energetic reforms of Humboldt, and now gave him his full confidence. His task at the court of Vienna was to effect the reconciliation of Prussia and Austria, to consolidate the strength of Germany, and to excite it against Napoleon. The difficulty of the effort was greatly increased by the passive position assumed by Austria after the campaign of 1809, and the marriage of Maria Louisa to Napoleon in 1810. Finally in 1813, when Prussia rose against Napoleon, the conference of Prague was held. At this most critical period the perseverance of Humboldt succeeded in overcoming the hesitation of Metternich. Stein, at least, declared that the new course taken by Austria was entirely due to Humboldt, and Talleyrand said of him that there were not in all Europe three statesmen of his ability. He manifested the same shrewdness, reserve, and energy at the conferences of 1813-15 at Frankfort, Châtillon, Paris, and the congress of Vienna. But with the formation of the treaty known as the "holy alliance" Humboldt had nothing to do, the emperor of Russia insisting that the king of Prus-

sia should not permit Humboldt to know anything of the treaty until it was concluded. During his diplomatic career he showed great genius in debate, quickness of reply, and a most delicate, cutting irony. In 1816 he went to Frankfort as ambassador, and in 1818 to London and Aix-la-Chapelle. In 1819 he was called to the ministry. At this time the king of Prussia determined not to introduce the representative system which he had promised to the people. Other points of difficulty arose, and Humboldt disagreed with his colleagues. By a decree of Dec. 31, 1819, he was dismissed from the ministry and deprived of his state appointments. He now retired to private life, and devoted himself to literature. His contributions to philology from this time were very extensive, and of such importance that it has been said that before him great minds, such as Herder, Adelung, and Friedrich Schlegel, had led the way, but Humboldt was the first who made of philology a science. Having formed the intention to follow all the languages of the Pacific in detail in order to establish the connection between India and Europe, he began with his work *Ueber die Kausisprache auf der Insel Java* (3 vols. 4to, Berlin, 1836-'40), in which he traces the languages, history, and literature of the Malay races. The most valuable portion of the work is its introduction, *Ueber die Verschiedenheit des menschlichen Sprachbaues und ihren Einfluss auf die geistige Entwicklung des Menschengeschlechts*. This was published separately (4to, Berlin, 1836), and embodies the conclusions at which he had arrived in regard to the origin, development, and nature of language in general. Besides this, his principal works are a number of criticisms collected in the *Aesthetische Versuche* (Brunswick, 1799); a translation of the "Agamemnon" of Aeschylus, a work containing also valuable researches into the Greek language and metres; the *Berichtigungen und Zusätze zu Aschling's Mithridates* (Berlin, 1817); *Prüfung der Untersuchungen über die Ueberohner Spaniens, &c.* (1821); *Bhagavadghita* (1826); and *Ueber den Iuvallia* (1828). His collected works were published by his brother Alexander (7 vols. 8vo, Berlin, 1841-'52). His *Briefe an die Freundin* (2 vols., Leipsic, 1847; 6th ed., 1856; and in 1 vol., 2d ed., 1863; English translation by Catharine M. A. Couper, 2 vols., London, 1849), containing his letters to Charlotte Friede, whose acquaintance he had made in Primmont in 1788, are renowned for beauty of thought and feeling. Among other English translations of his writings is "The Sphere and Duties of Government," by J. Coulthard (1834). The best biography of Wilhelm von Humboldt is by Haym (Berlin, 1856). His collection of MSS. and books he bequeathed to the royal library of Berlin.

**HUMBOLDT RIVER**, a stream which rises in the N. E. part of Nevada in Elko county, flows E. & W. by S., then bends N., and afterward

flowing S. S. W. loses itself after a winding course of about 800 m. in the Humboldt "sink" or lake, on the border of Humboldt and Churchill counties, in the W. part of the state. It is in no part more than a few yards wide, and is not navigable. It flows through a treeless region, the valley, except immediately along the stream, consisting of sandy land covered with sage brush, which, however, by irrigation might be rendered productive. Numerous streams on either side of the valley rush down the mountain gorges, but sink before reaching the Humboldt, except in the case of a few in seasons of more than usual snow and rain in the mountains. Of these streams the principal are the Little Humboldt on the north, and Reese river on the south. Near its source in Elko county, the Humboldt receives its N. and S. forks. As the only considerable stream flowing E. and W. through the Great Basin, its valley formed the ordinary emigrant route from the Great Salt lake to California; the Central Pacific railroad now follows its banks throughout its whole course. The Humboldt "sink" has no outlet, and is merely a marshy spot in a sandy plain, 10 or 15 m. long and 30 or 40 m. in circumference; the extent of water surface is variable, the capacity of the sands to absorb and of the atmosphere to evaporate being generally in excess of the supply from the river.

**HUME, David**, a Scottish historian, born in Edinburgh, April 26, 1711, died there, Aug. 25, 1776. His father, proprietor of the estate of Ninewells in Berwickshire, died during David's infancy, leaving three children. Hume was intended for the bar. He passed through the university of Edinburgh, but was drawn away from his legal studies by that love for literature which became the ruling passion of his life. At 16 he was a skeptic in matters of religion. His inheritance as a younger son being small, in 1734 he entered a counting room at Bristol, whence after a few months he passed over into France, and lived for three years with great economy while composing his "Treatise of Human Nature." In 1738 he printed his work in London, which, as he says, "fell dead born from the press." Returning to live at Ninewells, he printed anonymously at Edinburgh, in 1742, the first volume of his "Essays." He next sought a professorship in the Edinburgh university, but his skeptical principles prevented his success. In 1745 he went to live as companion to the insane marquis of Anandale. In 1746 Gen. St. Clair invited him to become his private secretary, in an expedition designed for the invasion of Canada, but which was finally directed against the coast of France. Hume was also made judge advocate in the army, and was highly popular with his military associates. When St. Clair went as minister to Turin, he took Hume with him as his secretary. On his way to Italy he passed through Germany, sailed down the Danube, and at Vienna was presented to the empress Maria Theresa. While at Turin, his "Inquiry con-

cerning the Human Understanding," a new casting of the unfortunate "Treatise," was printed at London. On his return from Italy in 1749, he lived with his brother and sister at Ninewells, his mother being now dead, and there wrote the "Inquiry concerning the Principles of Morals" and his "Political Discourses" (1752). In 1752, after strong opposition, he was chosen librarian of the advocates' library of Edinburgh, and now began his "History of England." The first volume of the "History of the House of Stuart," containing the reigns of James I. and Charles I., came out toward the end of 1754, and was unfavorably received. In 1756 he published a second volume, embracing the reigns of Charles II. and James II., which was better received. Hume had now formed a wide acquaintance among the professional and literary men of Scotland, his amiable manners and pure morals having conquered the prejudices excited by his skeptical opinions. The general assembly of 1755, however, condemned his writings, and even threatened him with excommunication. In 1757 appeared his "Natural History of Religion," which Dr. Hurd attacked in a violent pamphlet. Hume meanwhile became the patron of the rising literature of Scotland. He aided the blind poet Blacklock, and encouraged Wilkie, author of the "Epigoniad." Toward the end of 1758 he went to London to publish the "History of the House of Tudor." It appeared in 1759, and was severely criticised. In 1761 he published two volumes containing the earlier portion of the English annals. He proposed to write two more volumes to embrace the reigns of William III. and Anne, but this design was not fulfilled. By the sale of his copyrights he had now gathered a moderate fortune, and lived in Edinburgh in philosophic ease. But in 1763 the marquis of Hertford invited him to accompany him to Paris, where the marquis was appointed minister. Hume at first declined the invitation, but finally attended the marquis, and was received at Paris with signal distinction. The whole royal family, the French philosophers, the nobility, and particularly the ladies of high rank and fashion, overwhelmed him with their attentions; and Hume wrote to his friends in Scotland that Louis XIV. had never suffered so much flattery in three weeks as he had done. When Lord Hertford left Paris Hume became chargé d'affaires. In the beginning of 1766 he returned to England, bringing with him Rousseau, who sought there a refuge from persecution; he provided him with retired lodgings in Derbyshire, and obtained for him a pension from the king. But Rousseau soon afterward wrote a letter to Hume, accusing him of desiring to destroy his fame. Their quarrel made a great sensation, and Hume in self-defence published the letters that had passed between them. In 1766 Hume went to Edinburgh, but was invited by Gen. Conway the next year to become under secretary of state. He remained in London until Conway was superseded, and

in 1769 returned to Edinburgh. His income being now £1,000 a year, he engaged in building a house, and in the pleasures of society. In March, 1775, his health began to decline. The next spring he wrote a congratulatory letter to Gibbon, who had sent him the first volume of the "Decline and Fall." In April, 1776, he finished his "Own Life," a concise narrative of his literary career. After a journey to Bath he returned to Edinburgh to die. Five days before his death he wrote to the countess de Boufflers: "I see death gradually approach without any anxiety or regret." He was buried in Calton hill graveyard, Edinburgh, where a monument to him was erected. As a historian Hume holds a high rank among English writers. His narrative is interesting, his style clear, and with happy ease he blends profound thought, distinct portraiture, and skilful appeals to the feelings. He lacks, however, accuracy and impartiality. His philosophical writings do not form a complete system. He discussed detached questions of metaphysics, and aimed at the refutation of what he considered erroneous opinions rather than at the attainment of positive results. He regarded utility as the basis of morals, maintaining that the moral quality of actions was to be decided by their consequences. He asserts that the mind is conscious only of impressions and ideas, the latter following the former, and that there is no clearer proof of the existence of the mind than there is of matter. He traces the course of thought to the law of association, which he founds upon resemblance, contiguity, and cause and effect. But the doctrine of cause and effect is only a habit of the mind, resulting from experience. Thus all is uncertainty, and the mind reduced to skepticism. His history was continued by Smollett down to the death of George II., and after that by various authors. A new edition of his "Philosophical Works," edited by T. H. Green and T. H. Grose, has been commenced in London (4 vols., 1874 *et seq.*).—See "Life and Correspondence of David Hume," edited by John Hill Burton (2 vols., Edinburgh, 1847).

**HUME, Joseph**, a British statesman, born in Montrose, Scotland, in January, 1777, died in Burnley hall, Norfolk, Feb. 20, 1855. At about the age of nine he lost his father, the master of a small vessel, but was enabled by his mother, who established a crockery shop in Montrose, to receive a tolerable education. About 1790 he was placed with an apothecary of Montrose, and three years later he became a student of medicine at the university of Edinburgh, where he remained till 1796, when he was admitted a member of the college of surgeons of Edinburgh. Being appointed surgeon to an East Indiaman, he made two voyages to India, and in 1799 joined the medical establishment in Bengal. Finding that few of the company's servants had acquired the native languages, he applied himself to the study of them, and was soon able to speak them with fluency.

At the outbreak of the Mahratta war he was attached to the army, and upon a sudden emergency officiated as Persian interpreter with so much efficiency, that he was appointed to that office permanently. At the same time he was at the head of the medical staff, and for long periods acted as paymaster, postmaster, prize agent, and commissary general. These employments brought him reputation and emoluments; and in 1808 he was able to retire from professional life, and to return to England with a considerable fortune. For several years he devoted himself to travel and study. In January, 1812, he was for a valuable consideration returned to the house of commons for Weymouth and Melcombe Regis, commencing his political career as a tory. Before the parliament was dissolved, in the succeeding July, he opposed a ministerial measure for the relief of the Nottingham framework knitters, on the ground that the masters would be thereby so much injured that the workmen would be reduced to a worse state than before. This so alarmed the conservative patrons of his borough that at the next election they refused him a seat, although he had bargained for a second return. This proceeding probably opened the eyes of the new member to the evils of the borough system, for, although offered seats from other boroughs, he refused to enter parliament again except as a perfectly free member, a contingency which did not occur for several years. During this interval he busied himself with a variety of projects for the improvement of the laboring classes; but his chief efforts were directed against the abuses of the East India direction. In January, 1819, he reentered parliament as a radical member for the Aberdeen district of burghs, comprehending his native town, Montrose. He continued to represent the Scotch burghs till 1850, when he was returned unopposed as one of the members for Middlesex. In 1837 he was defeated, but was immediately returned through the interest of Mr. O'Connell for Kilkenny, which he represented till 1841, when he was an unsuccessful candidate for the town of Leeds. In the succeeding year he offered himself once more to the electors of Montrose, in whose service he died. His legislative zeal and labors were hardly equalled by those of the most eminent of his contemporaries. He urged reforms in every department of government; and he lived to see the adoption of almost every important measure which he had advocated. In 1859 a statue of him was erected in his native town.

**HUMMEL, Johann Nepomuk**, a German composer, born in Presburg, Hungary, Nov. 17, 1778, died at Weimar, Oct. 17, 1837. At seven years of age he showed so much talent that Mozart assumed the direction of his musical studies. Later he received lessons in harmony, accompaniment, and counterpoint from Albrechtsberger, and valuable suggestions from Salieri. In 1803 he entered the service of Prince Ester-

házy, and composed his first mass, which won the approval of Haydn. From 1811 to 1816 he taught at Vienna, and after that was successively chapelmaster to the king of Würtemberg and the grand duke of Saxe-Weimar. He made many tours through Germany, France, Great Britain, and Russia, winning renown as a pianist. He excelled as a pianist, improvisator, and composer. His improvisations were remarkable for their originality and brilliancy, and were so carefully worked out as to have all the character of finished compositions. He took high rank as a composer, but it was unfortunate for his reputation that he was the contemporary of Beethoven, by whose genius he was overshadowed. He composed for the stage, the church, and the concert room. His compositions of the first class consist of operas, pantomimes, and ballets; of the second, of three masses for voice, organ, and orchestra. The third class is the most numerous, consisting of concerted pieces for various instruments, trios, quartets, quintets, and septets, with many works for the piano alone. He wrote also a complete pianoforte method, which in spite of its many merits has been superseded by later works in stricter relation to the requirements of modern art.

**HUMMING BIRD**, the common name of a large family (*trochilidæ*) of beautiful slender-billed birds, found in America and its adjacent islands. There are three subfamilies, *grypinae* or wedge-tailed humming birds, *lamporninae* or curved-billed humming birds, and *trochilinae* or straight-billed humming birds. The most brilliant species live in the tropical forests, amid the rich drapery of the orchids, whose magnificent blossoms rival the beauty of the birds themselves. As we leave the tropics their numbers decrease, and but a few species are found within the limits of the United States, some however reaching as high as lat. 57° N. In whatever latitude, their manners are the same; very quick and active, almost constantly on the wing, as they dart in the bright sun they display their brilliant colors. When hovering over a flower in which they are feeding, their wings are moved so rapidly that they become invisible, causing a humming sound, whence their common name, their bodies seeming suspended motionless in the air. They rarely alight on the ground, but perch readily on branches; bold and familiar, they frequent gardens in thickly settled localities, even entering rooms, and flitting without fear near passers by; they are very pugnacious, and will attack any intruder coming near their nests. The nest is delicate but compact, and lined with the softest vegetable downs; it is about an inch in diameter, and the same in depth, and placed on trees, shrubs, and reeds. The eggs, one or two in number, average about one half by one third of an inch, and are generally of a white color, and hatched in 10 or 12 days. It is very difficult to keep these birds in cages; but they have been kept in

rooms and conservatories for months, feeding on sugar or honey and water and the insects attracted by these, and have become so tame as to take their sweetened fluids from the end of the finger. They are incidentally honey eaters, but essentially insectivorous; their barbed and viscid tongue is admirably adapted for drawing insects from the depths of tubular flowers, over which they delight to hover. The family of *trochilidae* may be recognized by their diminutive size, gorgeous plumage, long, slender, and acute bill, but little cleft at the base, and peculiar tongue; the species are very numerous, probably as many as 400, some of which have a very limited range. The bill when closed forms a tube, through which the long, divided, and thread-like tongue may be protruded into deep flowers; there are no bristly feathers around its base, as in birds which catch insects on the wing; the tongue has its cornua elongated backward, passing around the back to the top of the skull, as in woodpeckers; the wings are long and falci-form, with very strong shafts, the first quill of the ten the longest; the secondaries usually six; the tail is of various forms, but always strong, and important in directing the flight; the tarsi short and weak; the toes long and slender, and capable of sustaining them in a hanging position, as is known from their being not unfrequently found hanging dead from branches in the autumn after a sudden cold change in the weather.—The subfamily *grypinae* have the bill slightly curved, and the tail long, broad, and wedge-shaped; of these



Ruff-necked Humming Bird (*Selasphorus rufus*).  
1. Male. 2. Female.

the genus *phatornis* (Swains.) is found in the warmer parts of South America, and is numerous in species; *oreotrochilus* (Gould) inhabits the mountains of the western side of South America immediately beneath the line

of perpetual snow, feeding upon the nipterous insects which resort to the *grypus* (Spix) is found in the neighborhood of Rio de Janeiro. The ruff-necked hum (*Selasphorus rufus*, Swains.), of the



Anna Humming Bird (*Althis Anna*).  
1. Male. 2. Female.

parts of North America, is about 3 with a wedge-shaped tail; in the upper parts, lower tail coverts, a cinnamon-colored, the latter edged with purplish brown; throat copper; a ruff, and below it a white collar; male the back is greenish, and the reflections are less brilliant. The Anna humming bird (*Althis Anna*, Reich.) is larger, also inhabiting California and



Mango Humming Bird (*Lampornis maximus*).  
1. Male. 2. Female.

the tail is deeply forked; top of head and ruff metallic red, with purple rest of upper parts and band on breast; tail purplish brown; in the female is somewhat rounded, barred with

tipped with white, and the general color above metallic green. A second species of the last two genera is described by Prof. Baird in vol. ix. of the Pacific railroad reports.—The curved-billed humming birds, more than 100 species, are not represented in the United States, unless the mango humming bird (*lampornis mango*, Swains.) be admitted; this may be distinguished from the common species by the absence of metallic scale-like feathers on the throat, and by the serrations of the end of the bill; the prevailing colors are metallic green and golden above, and velvety bluish black below, with a tuft of downy white feathers under the wings.—The common species throughout the eastern states, extending to the high central plains, and south to Brazil, is the ruby-throated humming bird (*trochilus colubris*, Linn.). The length of this "glittering fragment of the rainbow" (as Audubon calls it) is about 3½ in. with an extent of wings of 4½

and especially to Gould's monograph on the *trochilidae*; also to vols. xiv. and xv. of the "Naturalists' Library."

**HUMPHREY, Heman**, an American clergyman, born in Simsbury, Conn., March 28, 1779, died in Pittsfield, Mass., April 3, 1861. From the age of 16 he was engaged for several successive winters as a teacher in common schools. He graduated at Yale college in 1805, studied theology, and was pastor of the Congregational church in Fairfield, Conn., from 1807 to 1817, and in Pittsfield, Mass., from 1817 to October, 1823, when he became president of Amherst college, then unincorporated. Principally through his influence it obtained an act of incorporation the next year, and he presided over it till 1845, when he resigned, and devoted himself to literary pursuits, residing in Hatfield, Mass., and afterward in Pittsfield. He was one of the earliest advocates of the temperance cause. In 1810 he preached six sermons on intemperance, and in 1813 drew up a report to the Fairfield consociation which is believed to have been the earliest tract on the subject. Among his writings are: a prize essay on "The Sabbath" (1830); "Tour in France, Great Britain, and Belgium" (2 vols. 12mo, New York, 1838); "Domestic Education" (1840); "Letters to a Son in the Ministry" (Amherst, 1845); "Life and Writings of N. W. Fiske" (1850); "Life and Writings of T. H. Gallaudet" (1857); "Sketches of the History of Revivals" (1859); and "Revival Sketches" (1860). A volume entitled "Memorial Sketches of Heman and Sophia Humphrey," by Z. M. Humphrey and Henry Neill, was printed for the use of the family.

**HUMPHREYS**, a N. W. county of Tennessee, bounded E. by Tennessee river, and intersected near its S. border by Duck river, a tributary of the former stream; area, 375 sq. m.; pop. in 1870, 9,326, of whom 1,295 were colored. The surface is moderately uneven, and the soil is fertile. The Nashville and Northwestern railroad passes through it. The chief productions in 1870 were 27,783 bushels of wheat, 491,355 of Indian corn, 29,967 of oats, 62,766 of peas and beans, 18,502 of Irish and 17,829 of sweet potatoes, 113,177 lbs. of tobacco, and 107 bales of cotton. There were 1,971 horses, 914 mules and asses, 2,355 milch cows, 4,488 other cattle, 8,937 sheep, and 18,418 swine; 1 manufactory of woollen goods, 1 of ground bark, 2 saw mills, 6 tanneries, and 5 currying establishments. Capital, Waverley.

**HUMPHREYS, Andrew Atkinson**, an American soldier, born in Pennsylvania about 1812. He graduated at West Point in 1831, and served mainly in topographical duty till 1836, when he resigned his commission in the army, and became a civil engineer in the United States service. In 1838 he was reappointed in the army, serving generally in the topographical department, and from 1844 to 1849 had charge of the coast survey office at Washington. In 1849-'50 he was engaged in making topographic



Ruby-throated Humming Bird (*Trochilus colubris*).

on the upper parts are uniform metallic green, with a ruby red gorget in the male, a white collar on the throat, and the deeply forked tail brownish violet; the female has not the red throat, and the tail is rounded, emarginate, and banded with black. The corresponding species on the Pacific coast is the black-chinned *T. alexandri* (Bourc. and Mulsant). The last two belong to the subfamily of *trochilinae* or *mellisuginae*, having straight bills; their genus is given by Gray as *mellisuga* (Briss.), of which there are more than 100 species. The largest of the humming birds belongs to this subfamily, and is the *hylocharis gigas* (Vieill.); it is nearly 8 in. long, brownish green above and red reddish below; the wings are longer than the deeply forked tail, and the general appearance is that of a brilliant swallow, with a long straight bill.—Those wishing to study in detail the complicated arrangement of this beautiful family are referred to the illustrated works of Lesson, Temminck, Audobert, and Vieillot,

and hydrographic surveys of the delta of the Mississippi, continuing in general charge of the work till 1861, when he published a voluminous and very valuable "Report upon the Physics and Hydraulics of the Mississippi River." During the civil war he was on the staff of McClellan until his supersedure by Burnside, was made brevet colonel for his services in the battle of Fredericksburg, commanded a division at Chancellorsville and at Gettysburg, and after the last battle became chief of the staff of Gen. Meade, being appointed major general of volunteers, July 8, 1863. He took an active part in the campaigns of 1864 and 1865, succeeding Hancock in the command of the 2d corps. He was brevetted brigadier general in the regular army for gallant conduct at Gettysburg, and major general for services at the battle of Sailor's Creek, the closing battle of the war (April 7, 1865). From July to December, 1865, he commanded the district of Pennsylvania, and thereafter he was in charge of the examination of the Mississippi levees till August, 1866, when he was appointed chief of engineers of the United States army, with the rank of brigadier general.

**HUMPHREYS, David**, an American poet, born in Derby, Conn., in July, 1752, died in New Haven, Feb. 21, 1818. He was educated at Yale college, entered the army at the beginning of the revolutionary war, and in 1780 became a colonel and aide-de-camp to Washington. He resided more than a year with Washington after his retirement to Virginia, and again in 1788. He accompanied Jefferson to Europe as secretary of legation in 1784, was elected to the legislature of Connecticut in 1786, and was soon associated with Lemuel Hopkins, John Trumbull, and Joel Barlow in the composition of the "Anarchiad," a series of poems which appeared in the "New Haven Gazette" and the "Connecticut Magazine." These poems were satirized as being the production of "four bards with Scripture names." An edition of them, purporting to be "the first published in book form, edited, with notes and appendices, by Luther G. Riggs," was published at New Haven in 1861. Humphreys was minister to Lisbon from 1791 to 1797, and afterward minister to Spain till 1802, and on his return imported from Spain 100 merino sheep, and engaged in the manufacture of woollens. He held command of two Connecticut regiments in the war of 1812, after which he lived in retirement. His principal poems are: an "Address to the Armies of the United States" (1782); a "Poem on the Happiness of America;" a tragedy, entitled "The Widow of Malabar," translated from the French of Le Mierre; and a "Poem on Agriculture." His "Miscellaneous Works" (New York, 1790 and 1804) contain besides his poems a biography of Gen. Putnam and several orations and other prose compositions.

**HUMUS** (Lat. *humus*, the soil), vegetable mould, or the product of the decay of vegeta-

ble matter. When portions of a decayed stump or the decayed matter of peat is digested in a weak solution of caustic potash or soda, a brown liquid is formed, which on the addition of an acid deposits a dark brown precipitate. This is a mixture, according to Mulder, of three substances, which he considers as compounds of water, or of water and ammonia, with three different acids, viz.: 1, geic acid,  $C_{20}H_{15}O_7$ ; 2, humic acid,  $C_{20}H_{15}O_8$ ; 3, ulmic acid,  $C_{20}H_{15}O_9$ . It has been doubted, however, whether humus has so definite a composition. Mulder also found that the brown substances formed by the prolonged action of boiling dilute acids upon sugar resemble ulmic and humic acids derived from mould, both in chemical composition and properties. Humus may be regarded as in a state of continuous decomposition or *eremacausis*, a species of slow combustion (see *EREMACUSIS*), in which the hydrogen of the vegetable matter is more rapidly removed by oxidation than the carbon, so that it contains an excess of the latter element. The formation of water, carbonic acid, and ammonia, and the elimination of mineral constituents in the decay of woody fibre is one cause of the beneficial action of vegetable manures in promoting the growth of plants.

**HUMUYA**, a river of Honduras, rising at the S. extremity of the plain of Comayagua, and flowing due N. for a distance of about 100 m. to a point N. of the town of Yojoa, where it unites with the rivers Blanco and Santiago or Venta, forming the great river Ulua, which falls into the bay of Honduras, about 25 m. N. E. of the port of Omoa. For the greater part of its course it is a rapid stream, and only navigable for canoes. It is principally interesting in connection with the interoceanic railway through Honduras, in course of construction (1874) through its valley. Comayagua, the capital of Honduras, stands on its E. bank.

**HUNDRED**, the name given in some parts of England to the subdivision of a shire, which may have received the appellation from having comprised 100 families, 100 warriors, or 100 manors. The existing divisions of this name differ greatly in area and population. The hundred is by some considered to have been a Danish institution, adopted by King Alfred about 897, each county being divided into tithings, of which 10 or 12 made a hundred, presided over by a decanus, head borough, or hundred man. The hundreds were represented in the "shiremote," which, under the presidency of its earl and bishop or sheriff, regulated the affairs of the county. The jurisdiction of the hundred was vested in the sheriff, although it was sometimes a special grant from the crown to individuals, and he or his deputy held a court baron, or court leet. The hundred was held responsible for felons until delivered up.—The townships of the state of Delaware are called hundreds.

**HUNFALVY**. I. PÁL, a Hungarian philologist, born at Nagy-Szálók, March 12, 1810. He

became in 1842 professor of jurisprudence at Kásmark, was a member of the Hungarian diet of 1848-'9, and has since lived in Pesth. He has written and edited a number of philological and ethnological publications, including *Chrestomathia Fennica* (Pesth, 1861), and "The Land of the Voguls" (3 vols., 1863), after the accounts of the Hungarian traveller Keguly. **II. János**, a Hungarian geographer, brother of the preceding, born at Gross-Schlagendorf, June 8, 1820. He became in 1846 professor of statistics and history at Kásmark, took part in the revolutionary movement of 1848-'9, and was imprisoned, but in 1850 resumed his duties at Kásmark, and was subsequently suspended for advocating the independence of Protestant education. He removed to Pesth in 1853, and became professor of statistics, geography, and history at the polytechnic institute of Buda. His works include a "Universal History" (3 vols., Pesth, 2d ed., 1862), "Physical Geography of Hungary" (3 vols., 1863-'6), the text to the pictorial work "Hungary and Transylvania" (3 vols. Darmstadt, 1859-'64), and a Hungarian edition of the "Travels" of Ladislas Magyar (Pesth, 1859).

**HUNGARY** (Hung. *Magyarország*, Magyar land; Ger. *Ungarn*), a country of Europe, formerly an independent kingdom, subsequently united with Austria, from 1849 to 1867 a crown-land or province of the latter, and since 1867 one of the two main divisions of the Austro-Hungarian monarchy. Before 1849 it embraced in a constitutional sense, besides Hungary proper, Croatia, Slavonia, and the Hungarian littoral (coast land on the Adriatic), and in its widest acceptance also Transylvania, the Military Frontier, and Dalmatia, with an aggregate population of about 15,000,000. All these dependencies were in 1849 detached, and besides them from Hungary proper the counties of Middle Szolnok, Zaránd, and Kraszna, and the district of Kóvár, to be reunited with Transylvania, and the counties of Bács, Torontál, Temes, and Krassó, to form the new crown-land of the Serbian Waywodeship and Banat. In 1867 the changes made in 1849 were repealed; the Waywodeship was abolished, Transylvania reunited with Hungary, and Croatia and Slavonia recognized as a dependency of the Hungarian crown, which has its own provincial assembly, but also sends deputies to the Hungarian diet, and is subordinate to the Hungarian ministry. The Military Frontier, which formerly had its separate administration, was destined to gradual incorporation partly with Hungary proper and partly with Croatia. Dalmatia was united with Cisleithan Austria. The Hungary in the wider sense, also called Transilithania or Transleithan Austria, from the little river Leitha which constitutes part of the frontier between the two main divisions of the monarchy, now comprises (the reorganization of the Military Frontier having become complete in 1873) Hungary proper, Transyl-

vania, Croatia and Slavonia, and Fiume. The lands of the Hungarian crown have in common with Cisleithan Austria an imperial ministry, consisting of the departments of foreign affairs and the imperial house, of finances, and of war. In the article AUSTRIA we have treated of the Austro-Hungarian monarchy as a whole; and the articles CROATIA, MILITARY FRONTIER, SLAVONIA, and TRANSYLVANIA will contain what is or lately was peculiar to those sections. In this article we shall treat of the lands of the Hungarian crown with special reference to that section which is called Hungary proper. Hungary (in the wider sense) is situated between lat. 44° 11' and 49° 35' N., and lon. 14° 25' and 26° 30' E., and is bounded N. E., N., and W. by Cisleithan Austria, S. and E. by the Turkish provinces and dependencies Bosnia, Servia, and Roumania. The total area of the lands of the Hungarian crown is 125,045 sq. m., of which 87,045 belong to Hungary proper. The population, according to the census of 1869, was 15,509,455, of whom 11,580,397 lived in Hungary proper.—Hungary in its chief parts forms a large basin surrounded almost entirely by mountain ranges, of which the principal are: the Carpathians, which encircle the north, with their various offshoots, the Hungarian Ore mountains between the Waag and the Eipel, the Mátra E. of the preceding, and the wine-growing Hegyalja between the Theiss and the Hernád; the Leitha range, the wooded Bakony, and the Vértes, mostly continuations of the Noric and Carnic Alps, in the S. W. division; and the Transylvanian Alps on the S. E. frontier. The chief artery of the country is the Danube, which enters it between Vienna and Presburg, and on its course to the Black sea receives the waters of all the other rivers, excepting only the Poprád, which rises near the N. boundary and flows to the Vistula. The principal of these affluents of the Danube are: on the right, the Leitha, Raab, Sárviz, and the Drave, which separates Hungary proper from Slavonia, with the Mur, its affluent; on the left, the March, Waag, Neutra, Gran, Eipel, Theiss, and Temes. The Theiss rises in the northeast, in the county of Mármaros, and its chief affluents are the Bodrog, Hernád, Sajó, and Zagyva on the right, and the Szamos, Körös, and Maros on the left. Most of the rivers of Croatia and Transylvania are also tributaries of the Danube; among others, the Save on the Turkish frontier and the Alt from Transylvania. The S. W. division, which has the fewest rivers, includes the two principal lakes of the country, the Balaton and the Neusiedler. Various marshes, moors, soda lakes, and swamps extend near the banks of the great rivers, especially of the Theiss. There are also numerous mountain lakes called "eyes of the sea," and caverns, of which that of Artelek in the county of Gömör is the most remarkable. Extensive islands are formed by the branches of the Danube; among others, the Great Schütt and Csepel in its upper course. The climate is in general mild,



owing to the great northern barrier of the Carpathians. Often, when snow covers the northern mountain regions, the heat is considerable on the lowlands of the south, especially near the Maros. The climate of the great central plain resembles that of northern Italy; its sandy wastes, however, greatly contribute to the aridity of the summer winds. Blasts of wind and hailstorms are not unfrequent in the Carpathians. The spring is the most agreeable season, but the autumn often partakes of the character of the Indian summer in the United States.—The fertility of the soil, with the exception of several mountainous and sandy regions, is almost extraordinary. Among the vegetable productions are: the different species of grain, especially wheat, maize, hemp, flax, rapeseed, melons, often of immense size, apples, pears, apricots, and plums; cherries, mulberries, chestnuts, filberts, and walnuts; tobacco, which is now monopolized by the crown; wine of the most various kinds, including the Tokay of the Hegyalja; almonds, figs, and olives, on the southern border; anise, Turkish pepper, sweet wood, safflower, madder, and other dye plants; oaks, which yield large quantities of galls, the beech, fir, pine, ash, alder, and numerous other forest trees, often covering extensive tracts of land in the mountainous regions. Among the animals are the bear, wolf, lynx, wild cat, boar, chamois, marmot, deer, fox, hare; many fine breeds of horses and cattle (including buffaloes), dogs, sheep, and swine, the last of which are fattened in the forests on acorns. The birds comprise the golden and stone eagle, hawk, kite, bustard, heron, partridge, woodcock, nightingale, and lark. Fish, bees, and leeches abound. Of minerals, there are gold, iron, and copper in large quantities; silver, zinc, lead, coal, cobalt, nitre, antimony, arsenic, sulphur, alum, soda, saltpetre, potassium, marble, crystal, chalk; salt in immense mines, especially in Mármaros; jasper, chalcodony, hyacinths, amethysts, agates, and beautiful varieties of opal (in Sáros). There are more than 300 mineral springs, of which those of Buda, Trentschin, Pöstény, Bartfeld, Paráđ, and Szobráncz are among the most renowned. The chief articles of export are wheat, rapeseed, galls, honey, wax, wine, tobacco, copper, alum, potash, wood, cattle, sheep, swine, hides, wool, dried fruits, and brandies, especially *slivovitz* or plum liquor. For imports and manufactures Hungary relies mainly on Austria, the chief home manufactures, besides metals, being linen and woollens, leather, paper, pottery and clay pipes, soap and candles, and tobacco. The means of communication, formerly scanty, are now rapidly extending. Steamers ply on the Danube and Theiss; a network of railways connects the various parts of the country with each other and with the neighboring provinces. The principal seats of learning are at Pesth, which is also the literary centre, Presburg, Kaschau, Debreczin, Patak, Pápa, Erlau, Veszprém, Miskolcz, Sze-

gedin, Stuhl-Weissenburg, and Grosswardein.

—The variety of nationalities and languages rivals that of productions. There are Magyars or Hungarians proper, the predominant race (according to the census of 1869, about 5,688,000 in the lands of the Hungarian crown, including the Szeklers of Transylvania; 5,024,000 in Hungary proper), chiefly in the fertile regions of the centre and in the southwest; Slovaks (1,841,000) in the mountain regions of the northwest and north; Ruthenians (448,000) in those of the northeast; Croats and Serbs (Rascians) in the south and southwest (about 2,405,700, of whom about 800,000 are in Hungary proper); Roumans in the southeast (about 2,477,700, of whom about 1,270,000 are in Hungary proper); Germans (1,894,800; in Hungary proper, 1,592,000) and Jews (552,000, mainly in Hungary proper), chiefly in the towns of all regions; gypsies (50,000), settled in towns and villages, or migratory; besides Armenians, French, Bulgarians, &c. These various elements are distinguished not only by language, but also by peculiar costumes, manners, and moral characteristics. Of the inhabitants in 1869, 7,558,000 (in Hungary proper, 5,933,000) were Roman Catholics, 1,599,000 (in Hungary proper, 981,000) united Greeks, 2,589,000 (in Hungary proper, 1,414,000) non-united Greeks, 2,031,000 (in Hungary proper, 1,720,000) Calvinists (Reformed, popularly Hungarian church), 1,113,000 (in Hungary proper, 887,000) Lutherans, and 552,000 Jews. Public education was reorganized in 1868. The common schools are of two grades: elementary schools with from one to three classes (14,685 in 1869), and schools of a higher grade with as many as six classes (569 in 1869). Education is compulsory, and children are bound to attend school from their 6th to their 12th year, and after that until their 15th year a "school of review." The actual attendance, however, is as yet unsatisfactory, and in 1869 amounted to only 50 per cent. of the children of school age, the number of attendants being 1,226,000. In 1869 there were 152 gymnasia, 25 *Realschulen*, and a university at Pesth. In 1872 a second university was opened at Klausenburg. —The Hungarian diet consists of two houses, the table of magnates and the table of deputies. The former in 1873 was composed of the 3 archdukes who had landed estates in Hungary, 31 Roman Catholic and Greek archbishops, bishops, and high church dignitaries, 12 imperial banner bearers, 57 presidents of counties, 5 supreme royal judges, the count of the Saxons in Transylvania, the governor of Fiume, 3 princes, 218 counts, 80 barons, and 3 "regalists" of Transylvania. The table of deputies had 444 members, of whom 334 belonged to Hungary proper, 75 to Transylvania, 1 to Fiume, and 34 to Croatia and Slavonia. The diet meets annually, and new elections must take place every three years. The right of voting belongs to all who have a regular business or pay a small amount of direct taxes,

as provided by law. The language of the diet is the Hungarian, but the representatives of Croatia and Slavonia are permitted to use the Croatian language. The Hungarian ministry consists of a president and the heads of nine departments, viz.: the ministry of national defence, the ministry near the king's person (*ad laus*), the ministry of finance, of the interior, of education and public worship, of justice, of public works, of agriculture, industry, and commerce, and for Croatia and Slavonia. The administration of communes was regulated by law in 1871; that of *municipia*, which class comprises counties, districts, and the royal free cities, in 1870. The supreme court of the kingdom is the royal *curia* in Pesth, consisting of two divisions, the court of cassation and the supreme court. The royal tables of Pesth (for Hungary proper and Fiume) and of Maros-Vásárhely (for Transylvania) are courts of the second resort; 102 royal courts and 896 district courts have original jurisdiction. The public revenue of Hungary for the year 1872 amounted to \$82,187,809, the expenditure to \$112,853,765. To meet the interest on the common debt of the monarchy contracted prior to 1868, Hungary pays an annual contribution of \$13,630,000. It has also a special debt amounting to \$219,000,000. Politically, Hungary proper, according to ancient custom, is divided into four natural divisions or circles, subdivided into counties, and called, from the standpoint of Pesth, the Cis-Danubian (N. and E. of the Danube), Trans-Danubian (S. and W. of the Danube), Cis-Tibiscan (N. and W. of the Theiss), and Trans-Tibiscan (S. and E. of the Theiss), and three districts: Jazygia (*Jászváj*), with Great and Little Cumania (*Kunság*); the Barluk towns (*Hajlu-Városok*); and Kövár. The counties are as follows: Cis-Danubian circle—Presburg (*Pozsony*), Neutra (*Nyitra*), Trentschin (*Trenčény*), Arva, Turóc, Bars, Lepö, Zolyom, Hont, Nógrád, Pesth (*Pest*), Gran (*széregom*), Bács. Trans-Danubian circle—Wieselburg (*Mosony*), Oedenburg (*Soprony*), Vas, Zala, Somogy, Baranya, Tolna, Veszprém, Rab (*Győr*), Comorn (*Komárom*), Weisenburg (*Fejér*). Cis-Tibiscan circle—Heves, Borsod, Gömör, Zips (*Szepes*), Sáros, Torna, Abauj, Zemplén, Ung, Bereg. Trans-Tibiscan circle—Ugocsa, Máramaros, Szatmár, Szabolcs, Bihar, Békes, Arad, Csanád, Csongrád, Torontál, Temes, Krassó, Middle Szolnok, Kraszna, Zaránd.—Among the nations who occupied parts of Hungary before its conquest by the Magyars or Hungarians, we find the Dacians, Illyrians, Panonians, Bulgarians, Jazyges, Alans, Avars, Lains, Gepidae, Longobards, and Khazars. The Romans held the S. W. part of the country under the name of Pannonia, while the S. E. belonged to their province of Dacia. Various Slavic tribes, together with Wallachs, Bulgarians, and Germans, were the chief occupants at the time of the Magyar invasion. The Magyars, a warlike people of the Turanian race, had made various migra-

tions, and long dwelt in the vicinity of the Caucasian mountains, and afterward in the region between the Don and the Dniester, before they approached and crossed the Carpathians (about 887) under the lead of Álmos, one of their seven chiefs (*vezér*), and elected head (*fejedelem*) or duke. They were divided into seven tribes and 108 families, had a compact, consecrated by oaths, which guaranteed justice and equality among themselves, and a religion which in various features resembled the Aryan element worship of the Medo-Persians, but also included the notion of a supreme being (*Isten*). Árpád, the son of Álmos, conquered the whole of Hungary and Transylvania, organized the government, and also made various expeditions beyond the limits of these countries, among others against Svatopluk of Moravia, being invited by Arnulf of Germany. These expeditions were further extended under his son Zoltán (907-946) and grandson Taksony (946-972), spreading terror and devastation as far as the North sea, the south of France and Italy, and the Euxine. But various bloody defeats, especially near Merseburg (933) by the emperor Henry I., on the Lech (955) by Otho I., and in Greece (970), finally broke the desire of the Hungarians for booty and adventurous exploits, and turned the attention of their princes to the consolidation of their power within the natural limits of the country. Gejza (972-997), the son of Taksony, who married a Christian princess, promoted the introduction of Christianity, which was almost completed under his son Stephen I. (997-1038), whose religious zeal gained him a crown and the title of apostolic king from Pope Sylvester II. (1000), and afterward the appellation of saint. Assisted by Roman priests and German knights, he proclaimed the freedom of Christian slaves, introduced Latin schools, established bishoprics, built churches, chapels, and convents, elevated the bishops to the foremost rank in the state, compelled the people to pay tithes to the new clergy, and subdued the rebellious adherents of the national religion. The political and administrative institutions of the state were also organized. The original equality of the conquerors was limited by imitations of the western feudal aristocracy. The higher clergy, the higher nobility, consisting of distinguished national families and of foreign lords, and the common nobility, embracing the bulk of the national warriors, were the ruling classes; the two former, together with the dignitaries of the state, the palatine (*nádor*), the court judge (afterward land judge), &c., formed the senate, or the higher division of the legislative body. Against this new and foreign order of things the national party more than once violently rose, both under Stephen and his successors, Peter (1038-'46), against whom Aba Samuel was elected king, and who twice lost his throne, Andrew I. (1046-'61), who perished after being defeated by his brother Béla, and Béla I. (1061-'63), under whom the resistance

of the defenders of the ancient religion was finally broken. The civil strifes were not only kept up by the undefined succession to the throne by the house of Árpád, but also fomented by the intervention of the popes and the emperors. The emperor Henry III. in the reign of Andrew repeatedly invaded the country. The son of the latter, Solomon (1063-'74), lost his throne chiefly in consequence of his ill treatment of his gallant cousins and successors Gejza (1074-'77) and Ladislav (1077-'95), to whom he owed his elevation, and some splendid victories over invaders; and he vainly applied for aid both to the emperor Henry IV. and his antagonist Pope Gregory VII., who each claimed the rights of suzerainty over Hungary. Solomon died in exile. Ladislav was equally brave and pious. He is a saint in the Roman calendar, and his victories over the Cumans, who invaded Transylvania and the neighboring districts, and the conquest of Croatia and Halicz (eastern Galicia), made him one of the favorite princes of his nation. His nephew Coloman (1095-1114), surnamed the Scholar, was an enlightened and able ruler. He introduced various reforms, refused to accept the lead of the first crusade, closely watched the hosts which passed through his country, and routed or repulsed the more disorderly, though he received Godfrey of Bouillon as a friend. He annexed Dalmatia, but stained the close of his reign by cruelty toward his brother Álmos, who conspired against him. His son, the profligate Stephen II. (1114-'31), waged war against almost all his neighbors. Béla II., the Blind (1131-'41), the son of Álmos, and like his father the victim of Coloman, took bloody revenge on his former enemies on the occasion of the diet at Arad. Under his son Gejza II. (1141-'61) numerous Saxon colonies were settled in Zips and Transylvania, while their countrymen who joined the second crusade desolated the regions through which they passed. The disputed rights to Galicia and Dalmatia, and the often changing relations with the Byzantine empire, were now sources of frequent wars in the north and south. Stephen III. (1161-'73), Gejza's youthful son, who overcame the intrigues of Manuel Comnenus and the opposition of two rivals, Ladislav II. and Stephen IV., but succumbed to poison, was succeeded by his brother Béla III. (1173-'96), who, having been educated at the Greek court, and supported by it, introduced various imitations of its administrative organization, and was successful in Galicia, as well as in Dalmatia against the republic of Venice. His connection with the West in consequence of his marriage with Margaret of France induced numerous noble youths to visit the chief cities and schools of France, England, and Italy. His son Emeric (1196-1205) was tormented by the revolts of his brother Andrew, and in vain had his son Ladislav III. crowned before his death. Andrew II. (1205-'35) was successively under

the influence of his unscrupulous wife, who finally was assassinated; of the pope, who compelled him to undertake a crusade; of his financiers, Christian, Saracen, and Jewish, who monopolized the revenues of the impoverished kingdom; of the nobility, who in 1222 extorted from him the "Golden Bull," a Hungarian Magna Charta of freedom and privileges, including the right of armed resistance to tyranny; and finally of a combined violent opposition, to which belonged his son and successor Béla (IV.). The long reign of the latter (1235-'70) commenced with salutary reforms, but was afterward disturbed by the immigration of the Cumans and the invasion of the Tartars, who annihilated the Hungarian army on the Sajó (1241), and marked their way from the Carpathians to the Adriatic by sword and fire, famine and pestilence. Béla did his best to restore order and repeople the country by new immigrants, bestowed various rights on the cities, and promoted the culture of the vine; but his wars with Austria, Styria, &c., and the revolts of his son Stephen, destroyed order, and promoted only the usurpations of the high nobility. Stephen V. (1270-'72) was successful against Ottokar of Bohemia. His son Ladislav IV. (1272-'90), who succeeded at the age of 10, caused violent commotions and endless misery by his Cumanian amours and predilections, and was murdered at the instigation of one of his mistresses. A nephew of Béla IV., Andrew III. (1290-1301), was the last of the Árpáds, and after a disturbed reign, which various diets held on the plain of Rákos near Pesth could not consolidate, died probably by poison. The throne was now open for competition, and the royal dignity became purely elective. Charles Robert of Anjou, a nephew of the king of Naples, and by his mother a descendant of the extinct dynasty, being supported by the see of Rome, was the first elected; while another party, the leader of which was the powerful count Matthias Csák, successively elected Wenceslas, son of the king of Bohemia (1301-'5), and Otho of Bavaria (1305-'8), both of whom were by a similar title descendants of the Árpáds. Charles Robert's reign (1309-'42) was marked by great successes at home and abroad. The regal power was extended and consolidated, chiefly by a new military and financial organization; western refinement and luxury made the Hungarian lords more docile and the succession to the thrones of Poland and Naples was secured to the two sons of the king, Louis and Andrew. Visegrád, however, which replaced Stuhl-Weissenburg as the royal residence, witnessed many a princely crime. Buda became a still more splendid residence under Louis, surnamed the Great (1342-'82), who further developed the regal power, but with it the oppressive feudal institutions; and, excepting his repeated expeditions to Italy to revenge the assassination of his brother Andrew by his own wife, Joanna, he was successful in all his

undertakings, conquering among other territories Moldavia and Bulgaria. He also succeeded his uncle Casimir the Great, the last of the Piasts, as king of Poland. He was chivalrous, luxurious, and bigoted; he promoted commerce, but burdened the peasants, persecuted the Cuman pagans, and expelled the Jews, whom, however, his son-in-law Sigismund of Luxemburg brought back into the country. This prince having liberated his wife Mary, who had got rid of a rival, the Neapolitan Charles the Little, by assassination, but subsequently lost her throne and freedom, reigned together with her (1387-'95), and after her death alone (1395-1437), being also elected German emperor, and succeeding to the throne of his house in Bohemia. His long reign was full of civil strife, including the Hussite war in Bohemia, a revolt in Hungary, which for a short time deprived him of his liberty, and a rising of the peasants in Transylvania, and of wars against Venice and the Turks, who under Bajazet routed him in the battle of Nicopolis; but it was also marked by some salutary reforms in favor of the lower classes. Sigismund was succeeded by his son-in-law the emperor Albert (II.) of Hapsburg (1437-'9). He died after an unsuccessful campaign against Sultan Amurath, leaving his thrones to his wife Elizabeth, who offered her hand to Ladislas III. of Poland, a grandson of Louis the Great. The young Polish king after some struggle became also king of Hungary under the name of Ladislas I. (Hung. *László*), but, after several victories of his great general John Hunyady over the Turks, fell at Varna (1444), having broken his oath of peace to the infidels. Ladislas (V.), the posthumous child of Albert, whom his mother Elizabeth, shortly before her death, had carried together with the crown to her brother-in-law the emperor Frederick III., was now acknowledged as king (1445), Hunyady being appointed governor or regent. Frederick of Hapsburg, however, had to be compelled to restore the prince; powerful lords caused endless disturbances, and the Turks menaced Hungary, while preparing to strike the last blow at the Byzantine empire. Hunyady himself was defeated, but made good his escape, and died victorious, having repulsed Mohammed II., the conqueror of Constantinople, from the walls of Belgrade (1456). Of his two sons, Ladislas was executed by command of the ungrateful king, but Matthias, surnamed Corvinus, ascended the throne after the death of the latter (1457) and a protracted election struggle. The ablest monarch of Hungary (1458-'90), he repulsed the rebellious lords, and in numerous campaigns vanquished the emperor, Podiebrad of Bohemia, and the armies of Mohammed II. He restored order, law, and prosperity, promoted science and art more than any other prince of his age, and administered his kingdom with an impartiality the glory of which survived him in the popular adage, "King Matthias is dead, justice gone." But his works

perished with him. The indolent Uladsilsa (II.) of Bohemia (1490-1516) was as poor as he was contemptible, and let his lords do as they chose. Of these John Zápolya, waywode of Transylvania, suppressed with dreadful bloodshed a great insurrection of the peasantry under Dózsa (1514). Under the young and weak son of Uladislas, Louis II. (1516-'26), the country gradually ripened for a catastrophe. While the nobles disputed, Belgrade fell, and finally the battle of Mohács was rashly fought against Sultan Solyman the Magnificent. The Hungarian army was destroyed, Louis perished on his flight, and his wife, the sister of Ferdinand of Austria, hastened to carry the crown to her brother. This prince inaugurated the still reigning dynasty of the Hapsburgs, being acknowledged as king (1527-'64) by the nobility of the western counties, while the national party elected John Zápolya, who prevailed in Transylvania and the adjoining parts. The latter put himself under the protection of Solyman, who took Buda and even besieged Vienna (1529). Long campaigns and negotiations and short-lived treaties now followed each other, the final result of which was that Hungary was for about 150 years divided into three parts with often changing limits, under the Hapsburgs as kings, the pashas of the sultans, and the princes of Transylvania. The greater part of Hungary proper, however, including the whole northwest, was in the hands of the royal or imperial armies, the monarchs holding also the crown of Germany after the abdication of Charles V., and finding many a hero among their Hungarian subjects. Maximilian (1564-'76) was saved by the self-sacrificing heroism of Zrinyi, who fell with his little fortress Sziget and the last of his men only after the death of the besieger Solyman and the destruction of a part of his army (1566). All these services of the magnates, as well as of the nation, were ill repaid by the Austrian dynasty. The diets of Hungary, which for centuries remained the blood-covered bulwark of Christendom, more than once had to complain that the imperial soldiery did more to devastate the country and famish the people than the infidel conquerors. Rudolph I. (1576-1608) commenced the persecution of the Protestants. These, however, not only had a free home in Transylvania under the enlightened Stephen Báthori, afterward king of Poland (who had succeeded the younger Zápolya), but also a protector of their rights in Hungary in Boeskey, the Transylvanian successor of Sigismund Báthori, who suddenly raised the banner of freedom, sweeping all over the north, crushing the generals of Rudolph, and finally compelling the latter to the humiliating peace of Vienna (1606). The old emperor finally resigned his Hungarian crown to his brother Matthias (II.), whose tolerant reign, however, was too short for the pacification of the country (1608-'19). His successor Ferdinand II. (1619-'37), who commenced his reign amid the first flames of the

thirty years' war, was prevented from tearing the Hungarian charter of liberty, as he did the Bohemian, by the victories of the Transylvanian prince Bethlen Gábor (Gabriel Bethlen), the successor of the profligate tyrant Gabriel Báthori, who extorted from him the treaty of Nikolsburg (1622), which again sanctioned the rights of the Protestants. A similar treaty was concluded at Linz by Ferdinand III. (1637-57) with George I. Rákóczy of Transylvania (1645). Leopold I. (1657-1705), whose long reign in Hungary was but a series of wars, insurrections, and executions, found a less able opponent in the ambitious George II. Rákóczy of Transylvania, and excellent generals against the Turks in Montecuculi, who gained the battle of St. Gothard (1664), and Nicholas Zrinyi (the poet), but made an ignominious peace with the sultan, and sent against the insurgents of the northern counties the bloodthirsty Caraffa, Strasoldo, and others. The people rose again "for God and freedom" under Tökölyi (1678), who, being allied with Apafi of Transylvania, the Porte, and Louis XIV. of France, was near uniting the whole of Hungary under his banner, when the reverses of the Turks before Vienna (1683), and the subsequent victories of the imperialists, sealed the fate of the insurrection. Caraffa made the scaffold permanent in Eperies; the diet of Presburg had to consent to the demands of the emperor in making the throne hereditary in the house of Austria and abrogating the clause of the golden bull which guaranteed the right of resistance to oppression (1687); Prince Eugene completed the victories over the Turks, and conquered the peace of Carlovitz (1699); Transylvania was occupied, and Tökölyi, who tried in vain to recover it, died in exile in Asia Minor. Hungary was now a province of Austria, and treated as such, when the noble-hearted Francis Rákóczy, who had long lived in exile, suddenly appeared on the N. E. borders (1703) and renewed the struggle for religious and civil liberty. Protestants and Catholics flocked to his banners, which were triumphantly carried into the very vicinity of Vienna, when the emperor died. His son Joseph I. (1705-11) was inclined to peace, and Rákóczy was not opposed to it, though assisted by Louis XIV. and the perplexities of the new emperor in the war of Spanish succession. Diets and negotiations followed each other, but without success, while the victories of Eugene and Marlborough and violent dissensions in the camp of the insurgents enabled the emperor to restore the fortunes of the war in Hungary. In the absence of Rákóczy, who had gone to Poland to procure the alliance of Peter the Great, a peace was finally concluded at Szatmár (1711) with the representatives of the emperor, toleration and a strict observance of the constitution being promised. Joseph's successor Charles (VI. as emperor, III. as king, 1711-40) ratified the treaty, while Rákóczy absolved his followers from their oath of allegiance to him. The new emperor's favorite scheme, the pragmatic sanction, which was to secure the succession of the female line to all his possessions, was agreed to by the diet of 1722, which also enacted various other important laws. The peace of Passarowitz (1718), the result of Eugene's new victories, enlarged the kingdom with the Banat, the last province of the Turks in Hungary; but after another war Belgrade was ceded to the Turks by the treaty concluded in that city in 1739. Charles's mild reign disposed the nation to defend the disputed rights of his daughter Maria Theresa (1740-'80), who appeared in person before the diet of Presburg, and was greeted with lively acclamations by the chivalric nobles. Their *Moriumur pro rege nostro Maria Theresa* was no vain promise, for Hungarian blood was shed profusely in her wars against Frederick the Great and other enemies. She rewarded the fidelity of the people by mildness, and various ameliorations of the condition of the peasantry (the *Urbarium*) are among the merits of her reign; but she too was far from strictly observing the constitution, which her son Joseph II. (1780-'90), in his immoderate zeal for reforms and centralization, was eager to destroy. To avoid binding himself by the constitutional oath, he refused to be crowned in Hungary, autocratically dictated his liberal reforms, and imposed upon the country foreign officials, a foreign language, the German, and foreign official costumes. But his violent though well meant measures were opposed everywhere, and the rising in his Belgic provinces, the unfavorable issue of his war against Turkey, and finally the threatening events in France, compelled the philanthropic despot to revoke his decrees shortly before his death. His mild and dissolute brother Leopold II. (1790-'92), afraid of the growing storm in the West, hastened to appease the Hungarian nation, which had been aroused by ignominious treatment and the spectacle of its perishing neighbor Poland to a general desire of national regeneration. The diet of 1791 again sanctioned the most essential constitutional rights of the kingdom in general, and of the Protestants in particular, and for a series of years Francis, the son and successor of Leopold (1792-1835), was satisfied during his wars with France with the continual subsidies of Hungary in money and men. The rare manifestations of democratic convictions he stifled in the dungeons of his fortresses, or, as in the case of the priest Martinovics (1795), in the blood of the offenders. The magnates were flattered and remained faithful. Thus Napoleon in vain called upon the Hungarians to rise for national independence (1809). Scarcely, however, was Napoleon fallen, when Francis's minister Metternich began to undermine the constitution of Hungary, the only check on the unlimited sway of the Austrian rulers. Every means, secret or open, was resorted to, but in vain. The progress of enlightenment, the warning example of Poland, and the spirit of nationality, re-

kindled by the activity of Francis Kazinczy and others, had prepared the nation for a struggle for constitutionalism and liberal reforms, which Metternich, both under Francis and his imbecile son Ferdinand V. (I. as emperor of Austria, 1835-48), was unable effectively to resist. The Hungarian constitution had during the last few centuries undergone numerous modifications, without having at any period of its existence lost its vitality. As it was now, it was at the same time a charter of freedom, which shielded the people at large, and especially the non-Catholics, against bureaucratic sway, and secured to the nobility the greatest degree of personal liberty and immunity enjoyed by any class in Europe, and on the other hand an instrument of oppression in the hands of the nobility against all plebeian inhabitants of the country, especially the peasantry, which was degraded by numerous feudal burdens. The nobles were free from every tax and personal service, except in case of a hostile attack on the country itself, when they were obliged to rise in a body at their own expense; they enjoyed all the privileges of the right of *habeas corpus*, governed the counties by their regular assemblies ("congregations"), elected magistrates, and exercised the right of legislation by their deputies to the lower house of the diet. The higher nobility, or magnates, together with the chief dignitaries of the crown and the church, formed the upper house of the diet under the presidency of the palatine. The representation of the free royal towns was almost nominal. The diet was now regularly convoked by the monarch at Presburg, at intervals not exceeding three years. Its duration was unlimited. The chief royal organs of general administration were the Hungarian aulic chancery at Vienna, and the royal council at Buda. These decisions, however, very often met with opposition or delay in the county assemblies. This *vis inertiae* of the latter was the principal check on all despotic or unconstitutional attempts of the Vienna ministry, while their publicity and jealously guarded freedom of debate were the chief elements of progress and political enlightenment. Gradually to abolish the immunity of the nobles and the feudal burdens of the peasantry, to endow the great bulk of the people with political rights, and at the same time to fortify the old bulwarks of the constitution, now became the task of the patriots; and the great movement offered the rare spectacle of an aristocracy contending for the abolition of privileges and the equality of the people. Paul Nagy and Count Stephen Széchenyi were the champions of nationality at the diet of 1825, which inaugurated a long period of moderate but gradual reforms, the most important of which were carried through at the diets of 1832-3, 1839-40, and 1843-4. The rights of the non-noble citizens, peasantry, and Jews, the equality of the Christian confessions, the official use of the Hungarian language, and the freedom of speech were extended, the majority

of the educated lower nobility and a minority of the higher ardently contending against old abuses and aristocratic immunities, against bureaucratic despotism and religious intolerance. Among the leaders of the "liberal opposition" under Ferdinand were the members of the upper house Count Louis Batthyányi and Baron Eötvös; the deputies Deák, Beöthy, Klauzál, Ráday, Balogh, and Kubinyi; the Transylvanian agitator Baron Wesselényi, and the publicist Kossuth. The cabinet of Vienna chose the last five as its victims, prosecuting them for treason, and imprisoning Wesselényi and Kossuth for years. The old palatine Joseph, the uncle of the emperor, and the conservatives under the lead of Széchenyi and others, in vain strove to check the agitation. It reached its culminating point when Kossuth, after a lively struggle, was elected as representative of Pesth to the diet of 1847. A conflict with the government seemed imminent, when the general shock which followed the French revolution of February overthrew the rule of Metternich (March 13, 1848). Kossuth was greeted as liberator by the people of Vienna, and together with L. Batthyányi intrusted with the formation of an independent Hungarian ministry by Ferdinand. Pesth had its revolutionary *journée* on March 15. Batthyányi was president of the new ministry, Kossuth minister of finance. Having enacted the abolition of feudality, a new election law, and various other radical changes in the constitution, the last diet of Presburg dissolved, the new national assembly being appointed to meet in July at Pesth. The cabinet of Vienna commenced its intrigues against the new order of things on the very day when it sanctioned it. Jellachich and others were sent openly or secretly to organize insurrections among the southern Slavic tribes and the Wallachs and Saxons in Transylvania, the diet of which proclaimed its reunion with Hungary. Every new measure met with opposition or delay through the Vienna government or its tools. Negotiations had no result. The whole south of the country was soon in a flame. Croatia and Slavonia proclaimed their independence of Hungary, and Ban Jellachich occupied the Littorale, and threatened to cross the Drave. Against all these contingencies the only resource of the government was its own zeal and the enthusiasm of the people. Volunteer troops (*honvéds*, defenders of the land) were raised in the counties, contributions toward a national treasury were collected, and the militia was organized. The diet assembled in July and voted extensive levies and ample means for defence, but Ferdinand refused to sanction its resolutions. The Austrian troops which were still sent against the insurgents were led by traitors. A serious attempt under Mészáros against the Rascians in Biacs (August) failed; the new troops were slowly gathering. Jellachich finally crossed the Drave, and the Vienna government, having reconquered Lombardy, threw

off its mask and sent Count Lamberg to disperse the diet by force. The Batthyányi ministry now resigned, and a committee of defence was formed under the presidency of Kossuth. The revolution began. The old troops were transformed and blended with the new. Kossuth's eloquence brought the people of the central plain under arms. Single detachments of Hungarian troops returned with or without their officers from abroad. The fortress Comorn was secured. The archduke Stephen, the new palatine, fled from the country. Lamberg was massacred on the bridge of Pesth by a mob. Jellachich was defeated at Pákozd near Buda (Sept. 29) and fled toward Vienna, which rose in revolution (Oct. 6). The principal fortresses hoisted the national flag. On the other hand, Temesvár and Arad hoisted that of Austria. The war of races raged with terrible fury and varying success. Transylvania was entirely lost. The pursuit of Jellachich was executed with hesitation by Mózsa, a late Austrian general, the frontier river Leitha was crossed too late, and the hastily collected volunteers fled after a short fight at Schwechat (Oct. 30) against Windischgrätz and Jellachich, who thus became masters of Vienna. Katona, sent to reconquer Transylvania, was routed at Déas. Count Schlick entered Hungary from the north, and occupied Kaschau (Dec. 11). The Rascian Damjanics alone led the honvéds to victory on the S. E. frontier, while Perczel successfully defended the line of the Drave on the S. W. Unable to defend the W. frontier against Windischgrätz, Görgey, the new commander of the army of the upper Danube, retreated on the right bank of that river, evacuating Presburg, Raab, and, after the rout of the equally retreating Perczel at Moor (Dec. 29) and an engagement at Tétény, the capital Buda-Pesth itself (Jan. 5, 1849). The day before, Schlick dispersed the undisciplined army of the north under Mézsaáros, the minister of war. Thus the government and diet, which transferred their seat to Debreczin, would have had little prospect of security if the Polish general Bem had not begun in the latter half of December a new Transylvanian campaign, which cheered the patriots with a nearly unbroken series of successes over the imperialists. Görgey, too, who according to a new plan of operations returned westward on the left bank of the Danube, leaving a part of his troops with Perczel on the middle Theiss, succeeded in diverting the Austrian main army under Windischgrätz from a march on Debreczin. Then turning northward, he skilfully fought his way through the rugged region of the Ore mountains, amid continual perils, and, after a signal victory of his vanguard under Guyon over Schlick's corps on Mount Branyiszkö (Feb. 5), finally effected a junction with the army of the upper Theiss, which under Klapka had been successful against that Austrian general. The activity of Kossuth and his associates in supplying all these bodies of troops with men, ammunition, money, and

officers was admirable. The zeal of the committee of defence was worthily responded to by the confidence of the people, who, even when two thirds of the country were in the hands of the enemy, almost as willingly accepted "Kossuth's bills" as specie, and by the general bravery of the troops. But new dangers arose with the invasion of the Russians from the Danubian principalities into Transylvania, where Bem, after a triumphant march (January), was suddenly checked before Hermannstadt, and could save his position at Piski (Feb. 9, 10) only after the loss of a part of his troops; and within the national camp by the stubborn disobedience and intrigues of Görgey, which caused the unfavorable issue of the great battle of Kápolna (Feb. 26, 27), the retreat of the united main army beyond the Theiss, the deposition of its commander, the Pole Dembinski, and a considerable loss of time. Another heavy loss was that of the isolated fortress Eszék, which was surrendered with immense stores by its cowardly commanders. Elated by the despatches of Prince Windischgrätz, the young emperor Francis Joseph, who had succeeded his uncle at Olmütz, Dec. 2, 1848, now promulgated a new constitution (March 4), which with one stroke annihilated the constitution and national independence of Hungary, making it, with narrowed limits, a crownland of Austria. But the next few days brought a new series of Hungarian victories. Damjanics, who had been recalled from the south, routed the Austrians at Szolnok (March 5). Bem took Hermannstadt and drove the Russians through the Red Tower pass into Wallachia. After the occupation of Cronstadt, all Transylvania, except Carlsburg, was in the hands of the Polish general. Perczel swept over the Rascian Vendée. The temporary chief commander of the main army, Vetter, having fallen ill, Görgey finally received the command, and the offensive against Windischgrätz was resumed. He crossed the Theiss at various points, and, advancing toward the capital, defeated the enemy at Hatvan (April 2), Bieske, Izsaszeg, Waitzen, and Nagy-Sarló, rescued Comorn, which had withstood a long siege and bombardment, crossed the Danube, and gained a victory at Ács (April 26). During this short campaign the diet at Debreczin proclaimed the independence of the country (April 14), appointing Kossuth its governor, and Auclich entered Pesth. Instead, however, of continuing his victorious march to the capital of the enemy, Görgey returned with the bulk of his army to the siege of Buda, while a new and extensive Russian invasion was approaching. Buda was stormed (May 21), the government and diet returned to the capital, and Görgey again took the field, but injudiciously chose the N. bank of the Danube for his new campaign, and, without profiting by Kmetty's victory at Csorna, S. of that river (June 13), wasted the blood of his army on the Waag. The Russian armies and fresh Austrian troops under Hay-

nau were in the meanwhile pouring into the country from various quarters. Wysocki, the successor of Dembinski in command, retreated before Paskevitch; Temesvár was unsuccessfully besieged by Vécsey; Bem was paralyzed by a new and more terrible rising of the Wallachs, while his province, too, was invaded by the Russians. After various unsuccessful struggles on the line of the Waag, the loss of Raab, and a great battle at Szöny (July 2), Görgey, leaving Klapka in Comorn, finally retreated toward the middle Theiss; but after a bloody fight against Paskevitch at Waitzen (July 15), he turned northward, again and again repulsing the Russians, and crossed the Theiss at Tokay. The Russians crossed it at Fured, while the central Hungarian forces under the chief command of Dembinski retreated toward Szegedin. The government, leaving the former place, where the last session of the diet had been held, retired to Arad, which, having recently surrendered, was made the last point of general concentration, after the rout of Bem at Schäßburg by the Russians under Lüders, of one of Görgey's divisions under Nagy-Sándor before Iebreczin by the army of Paskevitch, and of Dembinski at Szőreg by Haynau. Dembinski, however, retreated toward Temesvár, where his army suffered a terrible defeat (Aug. 9). Görgey, who now arrived at Arad, summoned Kossuth to resign, and received from him the supreme civil and military command, Klapka's ally from Comorn and signal victory over the besieging Austrian army (Aug. 8) being unknown at Arad. Two days later Görgey surrendered his army at discretion to the generals of the czar at Világos (Aug. 13). Damjanics followed his example, and surrendered Arad. Kossuth, the late ministers Szemere and Casimir Batthyányi, the generals Bem, Dembinski, Mezős, Vetter, Perczel, Guyon, Kmetty, Wysocki, and others, fled into Turkey. Munkács, Peterwardein, and Comorn capitulated. But scarcely had the tricolor disappeared from the ramparts of the last named fortress, Oct. 4, when the work of revenge commenced on the side of the victors. Count Louis Batthyányi, who had been made captive on a mission of peaceful mediation, was executed at Pesth, Oct. 6, and the commanders Kis, Aulich, Danjanics, Nagy-Sándor, Török, Lahner, Vécsey, Knézi, Pöltenberg, Leiningen, Schweidel, Dessenwffy, and Lázár, all of whom had surrendered at discretion, were executed on the same day at Arad. Other executions followed. The dungeons of the empire were filled with prisoners for life or long terms. Görgey was confined at Klagenfurth. The remnants of the Hungarian troops were impressed into the Austrian army, and the estates of the rich patriots confiscated. The country remained under martial law, receiving new divisions, authorities, and tax regulations, and foreign officials. The German was made the language of the reorganized higher courts, offices, and schools. New contributions, military levies, and so-called

voluntary loans, followed each other. A conspiracy and an attempt on the emperor's life led to the resumption of wholesale executions in 1853. The Protestants and Jews were subjected to particular restrictions. This state of affairs ended with Austria's defeat in Italy (1859). The dismissal of the centralizing minister Bach, the appointment of Goluchowski, and the diploma of Oct. 20, 1860, were followed by the convocation of a Hungarian diet. This was opened in April, when Schmerling had taken the place of Goluchowski, and the patent of Feb. 26, 1861, that of the October diploma. (See AUSTRIA, vol. ii., pp. 149, 150.) As no representatives from Transylvania had been summoned, the diet considered itself incomplete, and this was to be expressed, together with other grievances, either by an address to Francis Joseph, as Deák proposed it, or merely by a resolution ignoring the royal rights of that emperor. When the debate was to open, May 8, the leading defender of the latter policy, Count Teleky, was found to have put an end to his career by a pistol shot. (See TELEKY.) Deák's address was carried, but as he emphatically demanded the restoration of the laws of 1848, the diet was dissolved in August. The country maintained its opposition to the Vienna schemes, and only the Saxons and Roumans of Transylvania were persuaded in 1863 to send representatives to the imperial Reichsrath. The joint intervention with Prussia in the Schleswig-Holstein affairs proving detrimental to Austria, chiefly from want of ready support on the part of the Hungarian and Slavic nationalities, Francis Joseph repaired to Pesth in June, 1865, dismissed Schmerling, replacing him by a federalist minister, Belcredi, suspended the imperial constitution, and convoked a new Hungarian diet. Deák ruled this as he did the preceding, and remained firm in his demands. Francis Joseph, on the eve of the great struggle with Prussia, prorogued the diet, but after the disastrous battle of Sadowa (July 3, 1866) was ready to submit to the demands of the Hungarians. His new leading minister Beust undertook the task of carrying through a compromise, and the result was the dualistic system of the Austro-Hungarian monarchy, as finally sanctioned in December, 1867. (See AUSTRIA, vol. ii., p. 141.) A national Hungarian ministry was appointed in February, 1867, of which Count Andrassy was the head. A general amnesty was proclaimed, and the emperor was crowned as king of Hungary (June 8) at Buda, with extraordinary pomp. The diet, having carried through various reforms, including the emancipation of the Jews, and settled the relations of Croatia to the Hungarian crown on a basis analogous to the relation of Hungary to the monarchy, closed its sittings in December, 1868. Two principal parliamentary parties had been formed, the conservative or Deák party, which had a decided majority, and the opposition party of the left, under Ghyezy and Tisza, aiming at a mere



personal union with Cisleithan Austria under the house of Hapsburg. The revolutionary extreme left numbered few adherents. The same was the position of affairs in the diet of 1869-72. Andrásy, who in the war of 1870 restrained Beust from interfering against Prussia, succeeded that statesman in November, 1871, as foreign minister of the monarchy, Lónyay taking his place in Hungary. A new agreement was entered into with Croatia, and the Military Frontier districts were gradually placed under civil jurisdiction. The finances of the country, however, became rapidly embarrassed by state subsidies, and Lónyay fell under personal attacks, Szlávy becoming his successor (December, 1872). The new cabinet was even less successful, and in March, 1874, made room for a coalition ministry under Bittó.

**HUNGARY, Language and Literature of.** The Hungarian language (Hung. *Magyar nyelv*) is an isolated branch of the Uralo-Altaic family, constituting a peculiar group with the now extinct idioms of the Uzes, Khazars, Petchenegs, and ancient Bulgarians. Leo Diaconus (10th century) called the Magyars Huns, and the people liked to consider themselves as such, being proud of Etels (Attila) and his brother Buda. The chronicle of the monastery of St. Wandrill and Dankovszki connect them both with the Huns and Avars. Some connect them with both the Ugurs and the westerly Ogors or Yugri. There are also various fanciful derivations of the name Magyar from roots belonging to the Hungarian language. The Byzantine emperor Constantine Porphyrogenitus names the people Turkoï. The Magyars and the Osmanlis agree in the belief that they are kindred, and the former are called "bad brothers" by the latter for having resisted them. Klaproth deduces the Hungarian language from a mixture of Tartaric or Turkish with Finnic. Malte-Brun considers the Magyars as Finns who were subjected to the Turks and to an unknown Uralian people. Bese found that Balkar tribes in the Caucasus boasted of being Magyars, and that the ruins of a Magyar town were yet visible S. W. of Astrakhan. Csoma de Kőrös, who went in search of the cradle of his nation, found many words in the Thibetan and other tongues of middle Asia akin in sound and sense to the Magyar, but was unable to solve the mystery of the original home of the race. Many Hungarian writers report that their ancestors brought from Asia works written in their national 34 characters, which were suppressed at the command of Pope Sylvester II. and with the aid of Stephen I., but which were taught as late as the beginning of our century in remote places among the Szeklers, and may be seen in S. Gyarmathy's grammar as well as in George Hiekes's *Linguarum Veterum Septentrionalium Theaurus* (3 vols. fol., Oxford, 1703-5), under the name of *Hunnorum litteræ*. The language is now accommodated to the Latin alphabet, and consists of 26 simple and 6

compound sounds, agreeing, unless otherwise noticed, with the Italian, viz.: 8 vowels: *a* (like English *a* in *what*, *swallow*), *e*, *é* (French), *i* (also *y*), *o*, *u*, *ö* (Fr. *eu*), *ü* (Fr. *u*); 18 consonants: *b*, *d*, *f*, *g* hard, *h* (German), *j* (German), *k*, *l*, *m*, *n*, *p*, *r*, *s* (Eng. *sh*), *t*, *v* (also *w*), *z* (French), *sz* (Eng. *s*), *zs* (or *'s*, Fr. *j*); 4 compounds with *y*: *gy* (*dy*, as in *gyár*, factory, pron. *dyar*, in one syllable), *ly* (as in Fr. *filles*), *ny* (Fr. *gn*), *ty*; and 2 compound sibilants: *cs* (written also *ch*, *ts*; Eng. *ch*) and *cz*, *c*, or *tz* (Eng. *ts*). With the addition of the vowels marked as long with the acute accent, as for instance *á* (long Italian *a*), *í*, *ó*, *é*, *ú*, *ü*, there are 38 sounds in all, besides *x*, which is used only in foreign names, as in Xerxes. As in Turkish and other kindred tongues, the whole mass of words and grammatical forms is divided into two groups, viz., into those of high and low sound. The former is determined by the presence of *e*, *ó*, *ü*, the latter by that of *a*, *o*, *u*, in the roots or stems; those with *é* or *i* constitute a neutral ground. All formative and relative suffixes have therefore a double form, in harmony with the roots to which they are attached; thus: *váll*, shoulder, *vállal* (shoulders), undertakes, *vállalat*, enterprise; but *becs*, worth, *becsül*, (he) respects, *becsület*, respect. Whatever changes the Magyar language may have undergone under adverse circumstances, amid hostile nations, it has yet retained its essential peculiarities of phonetism, grammar, and construction. Although it contains many Slavic, Latin, German, Greek, and other foreign words, it has digested them in its own way, assimilating them otherwise than the western nations have done with the same element; thus, *schola*, Slav. *klau*, Ger. *Schulur*, became *iskola*, *kaldás*, *sinór*. The concurrence of harsh sounds and of consonants is as much avoided as in all the languages of central and eastern Asia. The roots remain unaltered, and most frequently bear the accent in all their derivatives.—The most peculiar feature of Hungarian grammar is its system of suffixes. In the possessive forms of nouns they are varied according to the number and person of the possessor and the number of the object, giving 12 distinct terminations, as follows: *házam*, my house, *házaim*, my houses; *házad*, thy house, *házaid*, thy houses; *háza*, his or her house, *házai*, his or her houses; *házunk*, our house, *házaink*, our houses; *házatok*, your house, *házaitok*, your houses; *házok*, their house, *házaik*, their houses. In verbs they are made to indicate not only the voice, mood, and tense, and the person and number of the nominative, but the definiteness or indefiniteness of the object, and in one form (indicative present, first person singular) the person of the object, as *várlek*, I expect thee; *kérlek*, I ask thee. The following table exhibits the suffixes of the indicative present, the root being always the third person singular of the indefinite form, and the vowels varying, as above stated, in consonance with that of the root:

PER-SON.	ACTIVE.				PASSIVE.	
	Definite.		Indefinite.			
1st S.	-om	-em (-öm)	-ok	-ek (-ök)	-atom	-etem
2d S.	-od	-öd (-öd)	-sz		-atol	-etel
3d S.	-ik	-ik	(Root)		-atik	-etik
1st Pl.	-unk	-ünk	(unk)	-ünk	-atunk	-etünk
2d Pl.	-tok	-tok	-tok	-tek (-tek)	-attok	-ettek
3d Pl.	-nak	-nak	-nak	-nek	-atnak	-etnek

Examples: *várom*, I expect him, her, it, them, or the man; *várom*, I expect, wait; *váratom*, I am expected; *kéred*, thou askest him, &c.; *kérsz*, thou askest; *kéretel*, thou art asked; *látja*, he or she sees it; *lát*, he or she sees; *látjuk*, we see it; *látunk*, we see, &c. Other moods and tenses are formed by inserting new letters or syllables between the above suffixes and the root, or in a few cases by a change of the final vowel or consonant, and by auxiliaries: thus: *vára*, waited; *váránk*, we waited; *vártunk*, we have waited; *várnánk*, we would wait; *várandók*, I shall wait; *várjatok*, that ye wait. The auxiliaries are: *volt* or *vala*, for the pluperfect; *legyen*, for the conjunctive past; *volna*, for the optative past. The infinitive is formed by suffixing *ni* to the root, as *várni*, to expect. A combined future is formed by the infinitive with the auxiliary verb *fog*; thus, *várni fogok*, I shall wait; *várni fogom*, I shall expect it. Possession is indicated by the irregular verb *lenni*, to be; *van*, is; *vannak*, are; *volt*, was; *lesz*, will be, &c.; thus: *anyám van* (mother-my is), I have a mother; also with the mark of the dative, *nekem vannak kerteim* (to-me are gardens-my, *mihí sunt horti*), I have gardens. Negation is expressed by *nem*, not; *nincs*, is not, *nincsenek*, are not; *sem*, is neither. Various kinds of verbs are made by affixing certain syllables, thus: *at* or *tat*, causative; *gal*, *gat*, &c., frequentative; *dül*, inceptive; inserting *n*, diminutive; *hat*, potential; *ít*, *int*, &c., transitive; *kodik*, reciprocal; *odik*, *odik*, reflexive, &c. Examples: *ver*, he beats; *veret*, he causes to beat; *vereg* (*verdes*, *verdeg*), he beats often; *verint*, beats softly; *verekedik*, fights with; *verődik*, beats against; *verőlik*, beats himself (breaks) through; *verhet*, can beat; *verethet*, can cause to beat; *verinhet*, can beat gently; *verekedhetik*, can fight with somebody; *verődhetik*, can knock against; *vergődhetik*, can break through, &c. All these and similar derivatives can be conjugated throughout in the same way as the simple verb. There are besides these other compounds with prefixes: *alá*, down; *által*, through, by; *be*, in; *bele*, into; *el*, of, away; *ellen*, against; *fel*, up; *ki*, out; *össze*, together, &c.; and especially *meg*, which is an emphatic particle denoting attainment of the aim, accomplishment (like the German *er* and *be* in *erlangen*, *hegraben*).—There is no gender; he and she are expressed by the same word. The definite article *az* or *a* is of recent use. The adjective precedes the substantive, and receives the marks of relations only when standing by itself. The relations called cases and those

expressed by prepositions in Indo-European languages are denoted in all Altaic tongues by suffixes. The plural is formed by *k*. Cases: *é*, genitive; *nak*, genitive and dative; *t*, at, accusative; *ban*, in; *ba*, into; *ból*, out of; *ért*, for; *hoz*, to; *ig*, till; *ként*, like, instead, as; *kép*, in manner of; *kor*, at the time of (about); *nál* (Latin *apud*, German *bei*), at; *on*, upon; *ról*, down; *ül*, instead, as; *vá*, (changed) into; *val*, with, by, &c.; almost all the suffixes being harmonized with the stem. Examples: *szemeinkben*, eyes-our-in; *ebédeikkor*, dinners-their-at-the-time-of. The separable postpositions are of three categories: 1, answering to three questions, where? whither? whence? thus: *előtt*, before (where?); *elő*, before (whither?); *elől*, from before; such are *alatt*, below; *körött*, around; *között*, between, among; *megett*, behind; *mellett*, near by; 2, of two forms, as *hegyett*, *hegyé*, upon, &c.; 3, of one form, as *ellen*, against; *iránt*, regarding, &c. The comparative degree is formed by suffixing *bb*; the superlative by prefixing *leg* to the comparative; thus: *nagy*, great, *nagyobb*, greater, *legnagyobb*, greatest. Pronouns: 1st person, *én*, I; *enyém*, mine; *nekem*, to me; *engemet*, me; *mi*, we; *miénk*, ours; *nekünk*, to us; *minket*, us; 2d person, *te*, *tiéd*, *neked*, *tégedet*; *ti*, *tiétek*, *nektek*, *titeket*; 3d person, of both genders, *ő*, *övé*, *neki*, *öt*; *ők*, *övék*, *nekik*, *öket*. These are joined with relative prefixes, thus: *bennem*, in me; *delőled*, out of thee; *hosszod*, to them; *alattam*, under me; *alattad*, under thee, &c. In addressing a person we say *ön* (self), plural *önök*, or *kegyed* (thy grace), plural *kegyetek*, for both genders; or *az úr*, sir (the lord or gentleman); *uraságod*, sirship-thy; *az asszony*, lady; *asszonyád*, ladyship-thy; formerly *maga*, self; to persons of lower standing, *kend*, you. Numerals: *egy*, 1; *kettő*, *két*, 2; *három*, 3; *négy*, 4; *öt*, 5; *hat*, 6; *hét*, 7; *nyolcz*, 8; *kilencz*, 9; *tíz*, 10; *tizenegy*, 11, &c.; *húsz*, 20; *harmincz*, 30; *negyven*, 40, &c.; *száz*, 100; *ezer*, 1,000. Ordinals: *első*, 1st; *második*, 2d; the others are formed by suffixing *dik*, as *negyedik*, *századik*, &c. All other varieties are formed by suitable suffixes. The formation of parts of speech, and of various categories of signification, is extremely luxuriant by means of suffixed letters or syllables, so that an indefinite and yet ever intelligible mass of words may be made to suit all conceptions and shades of meaning. This plasticity of the Magyar, together with its free syntax, renders it capable of expressing the turns of other tongues and the Greek and Latin metres with more ease and fidelity than almost any other language. We subjoin an example of construction and of elegiac distichs:

*Férfiak! így midott Pannon sír-istene hajlam:*  
Men! so spake Pannonia's war-god (its) of old:

*Bollog földet adok, víjátok érte ha kell.*  
Blackseed country give-I, fight-ye for-it if need.

*'S vittanak elcsintan nagy hűtör nemzetek érte*  
and fought decidedly great brave nations for-it

*'S véresen a' diadalt, végre kinyerte magyar.*  
and bloodily the victory lastly gained (the) Hungarian.

*Ah de etiamly maradtott a' népek' lelkeis: a' föld*  
 Alas, but discord remained the nations' souls-in: the land  
*Bolloggi nem tud lenni az átok alatt*  
 happy-made not knows (can) be the curse under.  
 (Vörösmarty.)

This language is spoken by more than one third of the population of Hungary in its wider sense, by more than one fourth of that of Transylvania, and in some places of Moldavia, Wallachia, and Bukowina. It consists of four dialects, which do not differ so much as those of other tongues, viz.: the Györi, of Raab, or Trans-Danubian, and the Bihari on the Theiss, both represented in books; the Palócz in the Mátra mountains, in the contiguous districts of the counties of Heves, Borsod, Gömör, Hont, and Nógrád, with more genuine ancient Magyar words than the preceding; and the Székely in Transylvania and the contiguous countries, with many Tartaric words, and of a drawling pronunciation. The language has varied very little in progress of time.—HUNGARIAN LITERATURE is comparatively of late date. The introduction of the religion of Rome under King Stephen I. (997-1038) made the Latin, the language of its priests and teachers, predominant in the court, the higher institutions for education, administration, and justice, and among the higher classes in general, who found it the most convenient medium for communication with the representatives of the cultivated West and South in diplomacy, literature, or religion. Of the time of the Árpáds and the next following period only Latin chronicles are preserved, of which those of the "Anonymous Secretary of King Béla" (II.) and Simon Kéza, the *Chronicon Budense*, and the *Chronicon Rerum Hungaricarum* of John Turóczy (Thurocius), are the most remarkable. The court of Matthias Corvinus (1458-90) at Buda was adorned by distinguished native and foreign scholars. Of the latter, Bonfinus wrote an interesting though often legendary history of Hungary in *Decades IV.*, which was published with a continuation by Sambucus (Basel, 1568). Galeotus wrote on Matthias himself, whose librarian he was, and Callimachus on Attila and Uladislus I. Among the natives the poet Janus Pannonius holds the foremost rank. The preserved remnants of Hungarian writings of that period are very scanty. The spread of the reformation in the following century, as in most countries of Europe, promoted the culture of the native tongue. But the simultaneous disasters of the country, the Turkish and civil wars, and chiefly the introduction of the German element with the dynasty of the Hapsburgs, checked the development of a flourishing national literature. Parts of the Scriptures were translated into Hungarian during the 16th century by Komjáti, Erdösi, Heltai, Székely, Juhász, Károlyi, and others. Gül, Juhász, Kulcsár, Telegdi, Décsi, and Károlyi distinguished themselves as orators. Tinódi, Valkai, and Temesvári sang the

warlike exploits of their times in light verses, Kákonyi the deeds of Cyrus, Csáktornyi the heroes of the siege of Troy; Balassa, Rimai, and Erdösi composed lyrical poems of incomparably higher merit. In the 17th century the Hungarian muse found votaries in Zrinyi, the grandson of the defender of Sziget, who celebrated in rhymed alexandrines the deeds and death of that hero, in Liszti, Paskó, and Koháry, and especially in Gyöngyösi, who sang the defence of Murány by Maria Szécsi. Molnár and Káldi translated the Scriptures; the primat and cardinal Pázmán and Kecskeméti were distinguished as orators; Csere even published a cyclopædia of sciences and a treatise on logic in Hungarian. This national movement in literature was paralyzed by the growing influence of the German dynasty; the bloody persecutions of the patriots under Leopold I. (1657-1705) suppressed it almost entirely. The Latin again became predominant, being cultivated in the 18th century by a large number of scholars in every branch, who vied with each other in the purity of their dead idiom, and compared with whom the Magyar writers Faludi and Bessenyei, the founders of a classical and a French school in poetry, Orczy, Count Teleky, Baróczy, Révay, and others, formed but a feeble minority. A new and fertile period began about the close of the last century, chiefly in consequence of the Germanizing measures of Joseph II. (1780-90), which caused a lively and general reaction. Societies for the cultivation of the national tongue were formed, literary, political, and scientific periodicals started, national theatres established, and various linguistic theories developed. This movement, being identical with the general regeneration of the nation, triumphed over all foreign elements after the first quarter of the present century, about the beginning of which Francis Kazinczy, the great reformer of the language after Révay, and the popular poet Csokonai, appear as the foremost in literature. The poets Dayka, Verseghy, and Virág, and the novelist Dugonics, were their contemporaries. The lyrical "Loves of Himfy" (*Himfy szerelmei*), by Alexander Kisfaludy (1801), were received with general admiration, and were followed by his "Tales" (*Régiék*) and other poems. Berzsenyi wrote glowing odes in Roman metre. The poets Andrew Horváth, Döbrentei, Vitkovics, Kis, and Paul Szemere, belong both to the period of regeneration and to the golden age of Hungarian literature, which embraces the 30 years preceding the revolution of 1848-9. This period opens with the simultaneous activity of five classical writers, Charles Kisfaludy, the brother of Alexander, Kölcsey, Fáy, Czuczor, and Vörösmarty, of whom only the last three survived it. Kisfaludy may be regarded as the creator of the Hungarian drama by his tragedies, and still more by his really national comedies, some of which are as yet unsurpassed. Kölcsey's lyrical poems, ballads, and prose writings, inclu-

ding orations, are distinguished by a spirit of ardent patriotism. Fáy's "Fables" (*Mesék*) are excellent specimens of that kind of poetry, in the manner of Lessing. Czuczor, distinguished also as a grammarian and lexicographer, is chiefly renowned for his popular songs and his historical epics in hexameter, the "Battle of Augsburg" (*Augsburgi ütközet*) and "Assembly of Arad" (*Aradi gyűlés*). The latter, however, were excelled by the more numerous epics of Vörösmarty, "Cserhalom," "The Flight of Zalan" (*Zalan futása*), "Erlau" (*Eger*), &c., which, together with his tragedies, short novels, songs, and especially odes and ballads, gave him the foremost rank among the writers of his nation. In lyrical poetry, next to Vörösmarty and Kölcsey we find Bajza, who is also remarkable as an æsthetic critic and historical writer, Peter Vajda, John Erdélyi, Kunoss, Alexander Vachott, Császár, and Garay, whose ballads also rival those of Vörösmarty. Toward the close of the period appear the three youthful popular poets Tompa, Arany, and Petöfi, of whom the first two excelled chiefly in tales and legends, and the last in light and playful songs, whose subjects are love, liberty, independence, nature, and all that can touch the heart or inspire the imagination. Fictitious literature was chiefly cultivated, if not created, by Jósika, whose historical novels, "Abafi," "The Last of the Bathoris" (*Utolsó Bathory*), "The Bohemians in Hungary" (*Csehok Magyarországon*), &c., exercised the greatest influence upon the development of Hungarian prose after Kazinczy. Smaller though not inferior works were written by Peter Vajda. In many respects both were surpassed by Eötvös, whose "Carthusian" (*A carthusiai*), a philosophical romance, "Village Notary" (*A falu jegyzője*), an admirable picture of recent political life in Hungary, and "Hungary in 1514" (*Magyarország 1514-én*), a historical novel, place him among the most eminent writers of his age. Kuthy is often eminent in pictures of nature, and Ignatius Nagy in caricaturing characters; both produced imitations of Sue's "Mysteries," taken from Hungarian life, but disfigured by unnatural exaggerations. Kemény and Jókai belong also to a more recent period, both as novelists and publicists. The principal dramatic authors besides Kisfaludy and Vörösmarty were Katona (*Bakbái*), L. Tóth, Garay, Szigligeti, who is eminent in popular plays, Gál ("The Notary of Peleske"), I. Nagy, Emerik Vahot, Paul Kovács, and Czákó. Travels were written by Belenyei (America), Császár (Italy), Bartholomew Szemere, Irinyi, L. Tóth, and Gorove (western Europe), Méhes (Switzerland), Jerney (southeastern Europe), and Reguly (northern Russia, the work of Szemere being one of the most remarkable productions of the period; political works by Szechenyi, Wesselényi, Kossuth, Eötvös, Szalay, B. Szemere, and others; the best histories by M. Horváth, Péczely, and Jászay (Hungary), Bajza (the ancient world),

and Toldy (national literature); philosophical treatises by Szontágh, Márki, Gregus, and others; the best statistical works by Fényes, Vállas, and Kőváry. Natural sciences, theology, languages, and antiquities also found numerous representatives. The best grammatical and lexicographical works on the national language were written by Czuczor, Fogarassy, and Bloch. The beautiful songs of the people were published in various collections, among others by Erdélyi; miscellaneous writings by Pulszky, Lukács, Frankenburg, Gabriel Kazinczy, Gondol, Berecz, Pompéry, Amelia Bezerédy, Theresa Karacs, and others. Of translators we will mention only Szabó, who published an admirable metrical version of Homer. During the revolution of 1848-'9 the muses were silent, excepting only the stirring songs of war. The battle field closed many a glorious career, as in the case of Petöfi, and destroyed many an incipient genius, as in that of the eloquent Vasvári. After the close of the war the dungeon, the scaffold, and exile doomed the most gifted of the nation to silence. The last quarter of a century is therefore in a literary respect inferior to the preceding period, though productive of a large number of publications of different degrees of merit. Some of them, mostly belonging to the surviving representatives of the preceding period, are worthy of their great popularity. In poetry the imitators of Petöfi have been numerous. Among the most remarkable productions are the poems of Tompa, Arany, Sárosy, Lisznyai, Lévai, Gyulai, Nicholas Szemere, Szász, Jámbor (Hiador), Sükei, Szelestei, Bozzai, Losonczy, Székely, and others; the novels of Kemény, Jósika, Jókai, Pálffy, Gyulai, and Bérczy; the humorous writings of Bernát and Radakovics (Vas Gereben); the historical works of Szalay, Joseph Teleky, Jászay, Toldy, Csengery, Palugyai, Mészáros, Fejér, J. Hunfalvy, &c.; the political writings of Eötvös and Kemény; the translations of Stephen and Charles Szabó, P. Hunfalvy, Csengery, Irinyi, Szász, and Sükei; the travels of Emanuel Andrassy (India), Nendtwich (America), Podmaniczky (northern Europe), Magyar (southern Africa), Emma Teleky (Greece), &c.; and the dramas of Szigligeti and others. Journalism and oratory, both of which attained their highest development during the later period of Kossuth's agitation, have been revived by the restoration of the Hungarian constitution. This sketch, which includes various Magyar productions of the Transylvanian press, excludes all more modern non-Magyar literary productions of Hungary belonging to the Slavic, German, or other literatures.—Among the principal works on Hungarian history (in various languages) are those of Bel, Pray, Gelhardi, Katona, Fessler, Engel, Majláth, Horváth, Péczely, Toldy, A. de Gerando, Szalay, and Kerékgyártó. See also A. J. Patterson, "The Magyars: their Country and Institutions" (2 vols., London, 1869).

**HUNGARY, Wines of.** In respect to climate and soil Hungary may be considered a country unusually well adapted to the culture of the grape; but although wine is produced in almost every portion of it, only a comparatively small amount is available for the purposes of commerce. The total production may be estimated at nearly 400,000,000 gallons, not more than 50,000,000 of which are capable of being rendered fit for export. The amount annually leaving the country is in fact very much less than this, owing to the imperfect system of viticulture practised by the producers, and to defective and primitive treatment of wine in the cellar. The wines are of three kinds: *samorodny* or "natural wine;" *másldá*, which is made of dry and plump grape berries, used in certain proportions; and ordinary wine, made from plump grapes only. It is a peculiarity of the Hungarian vines that the grapes ripening earliest often burst and discharge a portion of their juice, after which they dry up and are converted into lumps of sugar, called *aszu* (Ger. *Trockenbeeren*) or dry berries. These very rarely comprise an entire bunch, but are interspersed with fully ripe and plump grapes. It is customary at the vintage to separate the dry berries from the others; but when the clusters are put into the press without undergoing this process, the product is known as natural wine. The choice varieties are made from the ordinary wine, with the addition of dry berries. This is *másldás*. It is of four qualities, according to the quantity of dry berries added to each cask of wine. When reinforced beyond these proportions, it is called *aszubor* or *Ausbruch*, the choicest kind of which is that running spontaneously from the musk-infused dry berries, known as "essence." These fortified wines are as a rule very alcoholic and sweet, and are the chief wines of commerce. The most famous product of the Hungarian vines is the Tokay wine, which is made in the vineyards covering the slopes of the Hegyalja range of hills, near the town of Tokay, in northern Hungary. Five qualities are classified: Essence, *ausbruch*, *másldás*, *samorodny*, and ordinary. Of these the first is probably the most costly wine in the world, selling, when 50 years old and upward, at from \$5 to \$15 the small Tokay bottle. Dr. Druitt in his "Report on Cheap Wines," commending the use of Tokay by invalids, describes the essence as "a wine of delicate pale tint, in which the sweetness and fragrance of the grape, though perceptible, are partly hidden by, or converted by age into, an exceedingly rich, aromatic, mouth-filling wine flavor, so that, rich as it may be, it is not cloying nor sickly; and in its admirable aroma there is a decided remembrance of green tea." This has long been considered peculiarly the wine of crowned heads and princes, and is rarely if ever for sale. The *ausbruch* and other qualities of Tokay also command high prices, and are usually found in limited quantities wherever costly wines are in the market.

Among other Hungarian wines of this class, but ranking below the Tokays, are enumerated the *Ménes Magyarat*, red *ausbruch*, and natural wines, yielding 3,000,000 gallons, and the wines of Ruduced in the country lying west of the Raab, and yielding annually between 1 and 900,000 gallons of white, strong, *ausbruch* and natural wine. Wines of the second class comprise those of *Somlyó*, *Csony*, *Nezsmély*, *Ermellék*, *Szerednye*, *Nád* and *Krassó*, which are white; and *Erláson* (called also *Schiller*), *Szegszárd*, *Várbuda* (*Ofner*), and *Krassó*, red wines. The wines of the third and fourth class are scarcely beyond the confines of the region in which they are produced. Hungarian wines, comparatively new at the present time in Great Britain and the United States, were introduced into the former country as early as the reign of James I., and, on the authority of a German author of the last century, "were the favorite wines of the kingdom." They were subsequently supplanted by port, sherry, and Madeira. Friedrich Hoffmann, professor of medicine at Halle, and a man of great mark in his profession, declared in 1685, in an essay on "the Excellent Nature, Virtue, and Use of Hungarian Wines," by which he means the wines of the Tokay order, that they are superior to other wines, in that they are strong, pure, and their sweetness, have spirit, odor, and are strengthening, and yet open the pores of the skin and other organs, so that they cause no headache nor languor; and that the wines keep for an unlimited time.—In connection with the wines of Hungary may be considered those of Austria, in many parts of which country the vine is largely cultivated. The average yield may be estimated between 200,000,000 and 300,000,000 gallons, including many wines of fair quality and keeping properties. Most of this is contained within the country. The finest varieties are those of *Vöslau*, *Goldeck*, and *Steinberg*, each of which there is a red and a white. The vines employed are those of *Portuguese*; their products are said to bear some resemblance both to port and burgundy. To resemble *Madeira* wines also in returning improved from a sea voyage of several months. The sparkling *Vöslauer*, an effervescent wine, has considerable flavor and a delicate bouquet. The vineyards producing these wines lie between the Hungarian hills and the Styrian Alps, and enjoy a climate well suited to the maturing of delicately flavored wines. Dr. Druitt sums up his opinion of them as follows: "The richness of the overripened grapes destined to produce the cabinet wine, the amplitude of the cellars excavated in the bowels of a hill; the vicinity of sulphur and volcanic débris; and the immense activity, and conscientiousness employed, speak a great future for these vines."

**HUNGER**, the sensation by which the necessity for food is made known to the system, referred to the stomach, but indicating the wants of the system at large; impelling us to supply the waste of the tissues consequent on all vital acts, and in proportion to the activity of the animal functions from exercise, &c. If the desire cannot be gratified, or if absent from disease, the phenomena of inanition or of starvation are induced, with a diminution of the bulk of nearly all the tissues and proportionate weakness. Hunger is greatest in the young and growing state, and least in old age, when the vital operations are deficient in activity. It varies with the amount of heat to be generated in the body; external cold increases hunger, while heat diminishes it; hence the voracious appetite of the arctic regions, and the general use of stimulating condiments in the tropics; it is also increased by any unusual drain upon the system, when accompanied by febrile action, as in lactation and diabetes, in the last of which especially hunger is almost insatiable. In health, the feeling of hunger is a very good indication of the demands of the system for food, and it becomes the stimulant to mental operations, automatic in infancy, but directed by intelligence in the adult, which have for their object the gratification of the desire. Hunger depends rather upon the demand of the system for aliment than upon the state of emptiness of the stomach. The sense of hunger may be, however, immediately dependent on some condition of the stomach; it is well known that the swallowing of indigestible and non-nutritious substances will temporarily relieve it. The demands of the stomach and of the general system in this respect are probably communicated to the sensorium by the pneumogastric nerves and by the sympathetic. On the other hand, mere emptiness of the stomach does not produce hunger, as is evident from the fact that an ample supply of food passes entirely from the stomach hours before this sensation is felt, and that in disease there may be no desire for food for many days with total abstinence from it. Moreover, hunger may be relieved by the injection of alimentary fluids into the large intestine, when the stomach cannot receive or retain food.

**HUNS** (Lat. *Hunni*), a people of northern Asia who in the 5th century invaded and conquered a great part of Europe. Of their origin little is known with certainty. Under the name of Chuni they were known to the Greeks, and are mentioned by Ptolemy as early as the 2d century. According to the theory of De Guignes in his *Histoire des Huns*, the Huns were a Tartar nation, the Hiung-nu, whose original country was the region immediately north of the great wall of China, which was built to protect that empire against their incursions. For several ages they carried on successful wars against the Chinese emperors, who were compelled to pay them tribute in order to purchase a precarious peace. Their

power was at length broken by the arms of the emperor Vouti and by their own dissensions, and in the first century of the Christian era the unconquered remnant of the nation abandoned their country and marched westward in search of a new home. One division established themselves on the E. side of the Caspian sea, where they became known as White Huns. The main body of the nation established themselves for a while in Russia on the banks of the Volga. In the 3d century they crossed this river and invaded the territory of the Alans, whom they conquered and amalgamated with themselves. The united nations pressed onward, and attacked the Goths in 375. The Goths were defeated, their king Ermanric put to death, and the Gothic nation driven to seek an asylum within the bounds of the Roman empire. The Huns established themselves on the banks of the Don and the Dnieper and in Pannonia. They soon became involved in war with the Romans, and in the 5th century under the leadership of Attila attained to a high degree of power and empire. (See **ATTILA**.) Their dominion fell to pieces after the death of Attila (about 453), and the people themselves were lost and swallowed up in fresh invasions of barbarians from the north and east. The Huns of the Byzantine authors included many distinct tribes which invaded Europe in successive waves, including the Avars. Howorth identifies the Hunnic Avars with the Iouan-Iouan, who appear in Chinese history in the beginning of the 3d century A. D. Some time later they are found on the Jaxartes, and invading Transoxiana, where they intermarried with the Yethas or Epthalitæ. They compelled these latter to emigrate to the south of the Oxus, and during the 4th and 5th centuries extended their power as far as India. The whole frontier of eastern Persia is then described by western writers as infested by enemies, to whom the name of White Huns is given. Cosmas Indicopleustes, who was in India about 525, gives the name of Hunnia to the vast territory separating India from China. Thus, while Europe and the west were flooded by one wave of Huns, eastern Persia and the Indian border were flooded by another. Howorth has also attempted to prove that the Khazars or Akatzirs were the same race as the Epthalitæ of the Persian frontier. According to some writers, the Huns were a tribe of Finnish stock, and the ancestors of the Hungarians or Magyars. They are described by the Roman writers as hideous in appearance, with broad shoulders, flat noses, and small black eyes, deeply buried in the head. "A fabulous origin was assigned to them," says Gibbon, "worthy of their form and manners; that the witches of Scythia, who for their foul and deadly practices had been driven from society, had copulated in the desert with infernal spirits; and that the Huns were the offspring of this execrable conjunction. The tale was greedily embraced by the credulous terror of

the Goths; but, while it gratified their hatred, it increased their fear, since the posterity of demons and witches might be supposed to inherit some share of the preternatural powers as well as of the malignant temper of their parents."—See *Histoire générale des Huns, Turcs, Mogols et autres Tartares occidentaux*, by Joseph de Guignes (5 vols. 4to, Paris, 1756-'8); and *Histoire d'Attila et de ses successeurs*, by A. Thierry (3d ed., Paris, 1865).

**HUNT**, a N. E. county of Texas, drained by the head streams of the Sabine river and by the S. fork of the Sulphur; area, 935 sq. m.; pop. in 1870, 10,291, of whom 1,078 were colored. It has a rolling and in some places hilly surface, and is well wooded. The soil is fertile. The chief productions in 1870 were 342,411 bushels of Indian corn, 31,480 of sweet potatoes, 163,267 lbs. of butter, and 4,272 bales of cotton. There were 9,941 horses, 977 mules and asses, 9,672 milch cows, 2,077 working oxen, 25,141 other cattle, 7,194 sheep, and 23,347 swine; 1 flour mill, and 1 wool-carding establishment. Capital, Greenville.

**HUNT, Henry**, an English politician, born at Upavon, Wiltshire, Nov. 6, 1773, died at Alresford, Hants, Feb. 13, 1835. He was a wealthy farmer, and in early life was noted for extreme loyalty, having in 1801, during the alarm at the projected French invasion, offered to place his personal property, valued at £20,000, at the disposal of government. He subsequently retired in disgust from the Everly troop of yeomanry on account of their refusal to volunteer their services out of the county, and joined the Marlborough troop. Having challenged his commander, Lord Bruce, he was tried and sentenced to pay a fine of £100, and to be imprisoned for six weeks in the king's bench. During his confinement he was visited by several prominent reformers, under whose influence he became a champion of the most radical section of the party, and the political associate of Sir Francis Burdett, Horne Tooke, and William Cobbett. For many years he attempted without success to secure a seat in parliament, addressing popular meetings in the large manufacturing towns and in other parts of the kingdom. In August, 1819, he presided over the reform meeting in Manchester, which for alleged illegality was dispersed by the military, after 11 persons had been killed and upward of 600 wounded; and an indictment for conspiracy was found against him. He was sentenced to 2½ years' confinement in Ilchester jail, and after his release made a public entry into London on Nov. 4, 1822. In 1830 and 1831 he was returned to the house of commons from Preston; but failing of an election to the next parliament, he made the tour of England in a handsome equipage, speaking in the principal towns, and offering for sale, under the name of "radical coffee," roasted grains of wheat, as a substitute for the heavily taxed coffee of the West and East Indies. Subsequently he made his ap-

pearance in London in a coach drawn by white horses, from which he sold a new kind of blacking invented by himself. He died of a stroke of paralysis while on a tour.

**HUNT. I. James Henry Leigh**, an English author, born in Southgate, Middlesex, Oct. 19, 1784, died at Putney, Aug. 28, 1859. His father, a West Indian, married an American lady, and practised law in Philadelphia till the revolution broke out, when he warmly espoused the cause of the crown and had to leave the country. He went to England, took orders, and became tutor to Mr. Leigh, nephew of the duke of Chandos, after whom he named his son. Leigh Hunt was educated at Christ's hospital, which he left in his 15th year, spent some time in the office of his brother, an attorney, and then obtained a place in the war office. He had written many verses while a boy, and in 1801 his father published for him "Juvenilia, or a Collection of Poems written between the Ages of Twelve and Sixteen." He now began to contribute to periodicals, and in 1805 became the dramatic critic of the "News," a Sunday paper established by his brother John, to which also he contributed literary articles. A volume of his theatrical criticisms was published in 1807. In 1808 he left the war office, and with his brother established the "Examiner," a liberal journal, which he edited for many years and rendered exceedingly popular; it was noted for the fearlessness of its criticism and the freedom of its political discussions. Three times the Hunts were prosecuted by the government: first, for the words, "Of all monarchs, indeed, since the revolution, the successor of George III. will have the finest opportunity of becoming nobly popular;" second, for denouncing flogging in the army; third, when a fashionable newspaper had called the prince regent an Adonis, for adding "a fat Adonis of fifty." On the first the prosecution was abandoned, on the second the verdict was for acquittal, but on the third the brothers were sentenced to a fine of £500 each, and two years' imprisonment. They rejected offers to remit the penalties on condition that the paper should change its tone, and underwent the full sentence; but so much popular sympathy was excited in their behalf that the cells were transformed into comfortable apartments, constantly supplied with books and flowers. Here Leigh was visited by Byron, Moore, Lamb, Shelley, and Keats, and here he wrote "The Feast of the Poets" (1814), "The Descent of Liberty, a Mask" (1815), and "The Story of Rimini" (1816), which immediately gave him a place among the poets. He also continued to edit the "Examiner" while in prison. In 1818 he published "Foliage, or Poems original and translated," and in 1819 he started the "Indicator," a small weekly on the model of the "Spectator." A selection of his best essays from this was published under the title of "The Indicator and Companion" (2 vols.

8vo, 1822). But his pecuniary affairs had become badly involved, and in June, 1822, on the invitation of Byron and Shelley, he went to Pisa, Italy, to assist them in editing the "Liberal," a journal intended to be ultra-liberal in both literature and politics. Shelley's death occurred in July, and Hunt resided with Byron for several months; but the journal proving a failure and the association uncongenial, the poets separated with decidedly unpleasant impressions of each other. Hunt remained in Italy for some years, and after his return to England published "Recollections of Lord Byron and some of his Contemporaries" (4to and 2 vols. 8vo, 1828). In this book the character of Byron was set forth in so unfavorable a light that his friends, especially Moore, retorted upon its author in the severest manner. Years afterward Hunt confessed that he was ashamed of it. From this time his life was constantly devoted to the production of books. He had always been sneered at as a cockney by certain critics, and was frequently in great pecuniary straits, until in 1847 he received a literary pension of £200, but plodded on with unceasing industry. He translated Tasso's *Aminta*, Redi's *Bacco in Toscana*, Boileau's *Lutrin*, and numerous other works; edited the plays of Wycherly, Congreve, Vanbrugh, Farquhar, and Sheridan, and an expurgated edition of Beaumont and Fletcher; and was a frequent contributor to the literary and political columns of newspapers and magazines. Among his other works are the following: "Sir Ralph Esher," a novel (1832; new ed., 1850); "Captain Sword and Captain Pen," a metrical satire against war (1835); "The Legend of Florence," a drama (1840); "The Scer," a collection of essays (1841); "The Palfrey," a love story in rhyme (1842); "Stories from the Italian Poets, with Lives of the Writers" (2 vols., 1846); "Men, Women, and Books" (2 vols., 1847); "The Town" (2 vols., 1849); "Autobiography" (1850); "Table Talk with Imaginary Conversations of Pope and Swift" (1851); "Religion of the Heart" (1853); and "The Old Court Suburb" (1855). Shortly before his death he collected and arranged a complete final edition of his poems. A selection from his correspondence was published in 1862. II. **Thornton**, an English author and art critic, son of the preceding, born in London, Sept. 10, 1810, died June 24, 1873. He studied the art of painting, but soon abandoned it for journalism, conducted the political department of the "Constitutional" until that journal ceased to exist, edited successively the "North Cheshire Reformer" and the "Glasgow Argus," and from 1840 to 1860 was connected with the London "Spectator." He published "The Foster Brother," a romance (1845), and edited his father's "Autobiography" (1850) and "Correspondence" (1862).

**HUNT, Richard Morris**, an American architect, born in Brattleboro, Vt., Oct. 28, 1828. In 1849 he went to Europe, where he studied his

profession at the school of fine arts in Paris, and under Hector Lefuel, and made a tour through various parts of Europe, Greece, Asia Minor, and Egypt. Returning to Paris, he was engaged as inspector under Lefuel, then architect to the emperor, on the new building connecting the Louvre and the Tuileries. On his return to America in 1855, he was employed upon the capitol extension at Washington. Since then he has executed many public and private works, of which the most important are the Presbyterian hospital, the Stevens apartment house, the Lenox library, and the Tribune building in New York; the Yale divinity college in New Haven; the Stuyvesant building, New York; the Brimmer houses, Boston; the residence of J. Q. A. Ward, New York; and several villas at Newport, R. I.

**HUNT, Thomas Sterry**, an American chemist, mineralogist, and geologist, born in Norwich, Conn., Sept. 5, 1826. He studied medicine for a time, but, devoting himself to chemistry, became in 1845 a private student with Prof. B. Silliman, jr., of New Haven, acting meanwhile as chemical assistant to Prof. Silliman, sr., in the laboratory of Yale college. After two years thus spent he was in 1847 made chemist and mineralogist to the geological survey of Canada, then just begun under the direction of Sir William Logan. He held this post for more than 25 years, but resigned it in 1872, and accepted the chair of geology in the Massachusetts institute of technology, where he succeeded Prof. William B. Rogers. His earlier studies were directed especially to theoretical chemistry, then assuming shape from the labors of Liebig, Dumas, Laurent, and Gerhardt. It was as the reviewer, interpreter, and critic of these chemists that Mr. Hunt first became known, while he at the same time developed from some germs in the writings of Laurent a new system essentially his own, in which all chemical compounds are deduced from simple types represented by one or more molecules of water or of hydrogen. These views, maintained by him in a series of papers in the "American Journal of Science," beginning in 1848, have at length been universally adopted, and are now recognized as one of the foundations of modern chemical theory. His philosophy of the sciences has been influenced by the study of Kant, and still more of Hegel and Stallò, as may be seen in his essays on "Solution," "Chemical Changes," and "Atomic Volumes," which first appeared in the "Journal" (1853-'4), and were republished in England and Germany. In these he attacks the atomic hypothesis and all its consequences, and asserts that solution is chemical union, and chemical union identification. His researches on the equivalent volumes of liquids and solids were a remarkable anticipation of those of Dumas, while in his inquiries into the polymerism of mineral species he has opened a new field for mineralogy, as set forth later in his essay on the "Objects and Method of Mineralogy." His philosophical studies



have however been only incidental to his labors in chemical mineralogy and chemical geology. His researches into the chemical and mineral composition of rocks have probably been more extended than those of any other living chemist; and his investigations of the chemistry of mineral waters, which are not less so, have enabled him to frame a complete theory of their origin and formation, and their relations to the origin of rock masses both crystalline and uncrystalline, and to lay the basis of a rational system of chemical geology. From his long series of studies of the salts of lime and magnesia he was enabled to explain for the first time the true relations of gypsums and dolomites, and to explain their origin by direct deposition. His views on this subject are now, after many years, finding recognition among geologists. He has also carefully investigated petroleum both in its chemical and geological relations. The phenomena of volcanoes and igneous rocks have been discussed by him from a new point of view, and he has revived and enforced the almost forgotten hypothesis of Keferstein that the source of these is to be sought in chemical reactions set up in the sedimentary deposits of the earth's crust through the agency of internal heat. In this discussion he was the first to point out and explain the relation between modern volcanic phenomena and great accumulations of comparatively recent sedimentary formations, as well as the nature of the relations between these and folded and contorted strata. He has sought to harmonize the facts of dynamical geology with the notion of a solid globe, which he early adopted in opposition to the generally received one of a globe with a liquid interior, and has also developed a theory of cosmogony based upon the chemical and physical conditions of a world consolidating from a vaporous mass, and has endeavored to show how the earth, air, and ocean have assumed their present condition under the slow operation of natural causes. His views on these questions will be found in an essay on "The Chemistry of the Earth" in the report of the Smithsonian institution for 1869; while his conclusions on many points of geology are embodied in his address delivered as retiring president before the American association for the advancement of science at Indianapolis in 1871, on "The Geognosy of the Appalachians and the Origin of Crystalline Rocks," and in others of his recent papers, such as "Notes on Granitic Rocks," "The Geognostical Relations of the Metals," and "The History of the Names Cambrian and Silurian in Geology." Besides his papers in the "American Journal of Science," which number more than 100, and numerous articles communicated to the French academy and the scientific journals of France, England, and Canada, he has contributed largely to the reports of the geological survey of Canada, and to the work entitled "Geology of Canada" (1863), the

latter half of which is from his pen. He is also the author of a summary of organic chemistry forming a part of Prof. Silliman's "First Principles of Chemistry" (1852). A volume of his collected scientific essays is now in press (1874). He is also known for his researches, both theoretical and practical, into the chemistry and metallurgy of iron and of copper, some of which will be found in the "Proceedings of the American Institute of Mining Engineers." Dr. Sterry Hunt received in 1854 the honorary degree of A. M. from Harvard college, and later the degrees of LL. D. and Sc. D. from the universities of Montreal and Quebec, in both of which he was for many years a professor, and in the latter of which he lectured in the French language. He was a member of the international jury at the exhibitions of Paris in 1855 and 1867, and is a member of various academies and learned societies both in Europe and America. He was made a fellow of the royal society of London in 1859, and of the national academy of the United States in 1873. He is also an officer of the French order of the legion of honor.

**HUNT, William Henry**, an English water-color painter, born in London in 1790, died Feb. 10, 1864. He became a member of the old society of painters in water colors in 1824, and from that time regularly contributed to their annual exhibitions. As a colorist he ranked among the first painters of the day.

**HUNT, William Holman**, an English painter, born in London in 1827. He studied in the school of the royal academy, and in 1846 exhibited his first picture, entitled "Hark," which was followed by a scene from "Woodstock" (1847), the "Flight of Madeline and Porphyro," from Keats's "Eve of St. Agnes" (1848), and "Rienzi vowing to obtain Justice for the Murder of his Brother," from Bulwer's novel (1849). In 1850 appeared his "Converted British Family sheltering a Christian Missionary from the Persecution of the Druids," the first fruits of the new "pre-Raphaelite" movement in British art. He had in the previous year associated himself with John Everett Millais and Dante Gabriel Rossetti, for the purpose of restoring to the art the earnestness and conscientious accuracy that animated the painters who preceded Raphael. Medievalism in theology and architecture was the prevailing mode of the day, and the young artists showed the influence which it had perhaps unconsciously exerted upon them, by styling themselves "pre-Raphaelites;" although they distinctly avowed their object to be chiefly the study of nature, to which they looked for inspiration, and the minutest details of which they proposed to copy with scrupulous accuracy. By common consent Hunt was regarded as the leader of the new school, which was shortly joined by Charles Collins and other young artists; and notwithstanding much hostile criticism and ridicule, he continued year by year to develop the idea with which he

started. In 1851 appeared his "Valentine rescuing Sylvia from Proteus," in 1852 "The Hireling Shepherd," and in 1853 "Claudio and Isabella" and "Our English Coasts," a pre-Raphaelite study of the downs at Hastings, all strongly imbued with the characteristics of the new style. In 1854 he produced two powerful pictures, "The Awakened Conscience" and "The Light of the World." The summer of 1855 was spent by Mr. Hunt on the shores of the Dead sea, where he took minute studies of the surrounding scenery, which were subsequently embodied in his picture of the "Scape Goat," exhibited in the succeeding year. To the universal exposition of 1867 in Paris he sent "After Sunset in Egypt." Mr. Hunt resided for some years in Jerusalem engaged in painting a picture recently finished, "The Shadow of Death," for which he received 10,000 guineas.

**HUNT, William Morris**, an American painter, born in Brattleboro, Vt., March 31, 1824. He entered Harvard college in 1840, but went to Europe on account of his health before the completion of his course, and in 1846 entered the academy at Düsseldorf, with the intention of studying sculpture. At the expiration of nine months he went to Paris, and in 1848 became a pupil of Couture. In 1855 he returned to the United States, and has since resided at Newport, R. I. His paintings comprise portraits, history, and *genre*, and among the most successful are several representing picturesque types of city life in Paris, of which the artist published a series of lithographs executed by himself in 1859. Among his later works are the "Morning Star," and the "Drummer Boy" and the "Bugle Call," illustrating incidents in the civil war.

**HUNTER, John**, a British surgeon and physiologist, born at Long Calderwood, Lanarkshire, July 14, 1728, died in London, Oct. 10, 1793. He was the son of a farmer, and the youngest of ten children. At 17 years he went to Glasgow to assist his brother-in-law, a cabinet maker; but soon returned home, and wrote to his brother William, who was already successful as a lecturer on surgery, offering to assist him in his anatomical labors. His brother's reply was favorable, and he went to London in September, 1748. He soon gave evidence of his abilities in the dissecting room. In 1749-'50 he attended the practice at Chelsea hospital, and in 1751 became a pupil at St. Bartholomew's hospital, continuing at the same time his labors in the dissecting room of his brother. In 1754 he became surgeon's pupil at St. George's hospital, of which he was appointed house surgeon two years later; and in the winter of 1755 he became a partner in the lectures of his brother. In the mean time he had succeeded in following more minutely than had before been done the ramifications of the olfactory nerve, in tracing the branches of the fifth pair of nerves, in discovering the system and functions of the lymphatic vessels in birds, and the cause and mode

of descent of the testis in the foetus. In 1759 he obtained the appointment of staff surgeon in the army, accompanied the expedition to Belleisle in 1761, and after the siege of that place served in Portugal until the peace of 1763. During this time he collected the materials for his work on gun-shot wounds, which was published after his death. He returned to London, was put on half pay, and was obliged to receive pupils in anatomy and surgery as a means of subsistence. Purchasing a small piece of ground about two miles from London, he built a house, and carried on there his investigations in comparative anatomy. He bargained with the keepers of menageries for the bodies of dead animals, spent all his available means in procuring rare species, and often exposed himself to personal danger in watching their habits and instincts and experimenting on their dispositions. His papers communicated to the royal society drew attention to his labors, and in 1767 he was elected a fellow of the society, and the following year surgeon of St. George's hospital and a member of the college of surgeons. In 1771 he married the sister of Sir Everard Home, his pupil and subsequently his biographer, and in the same year published his first original work, "Natural History of the Human Teeth" (4to), of which the second part appeared in 1778. In 1778 he commenced his first regular course of lectures, a task which he seldom succeeded in discharging with satisfaction to himself or his pupils, and as a preparation for which he was accustomed to dose himself with laudanum. In 1776 he was appointed surgeon extraordinary to the king, and at the request of the royal humane society drew up a paper on the best mode of restoring apparently drowned persons. He also published papers on the action of the gastric juice upon the stomach after death, the torpedo, electric eel, &c. Between 1777 and 1785 appeared his papers on the heat of vegetables and animals, the structure of the placenta, the organs of hearing in fishes, &c., and the six Croonian lectures on muscular motion. The paper on the placenta, claiming for the author the discovery of the union between the uterus and placenta, which William Hunter had claimed in 1775 in his "Gravid Uterus," caused an estrangement between the brothers which only terminated a short time before the death of William. In 1785 he removed his whole museum to a house erected for the purpose in Leicester square, to which he admitted the public in May and October of each year. It had now assumed enormous dimensions, and such was his reputation as a naturalist that no new animal was brought to the country which was not shown to him. In the same year he was prostrated by a severe spasmodic attack, and was obliged to relinquish practice for a time; and thenceforth until his death he was a constant sufferer, his paroxysms occurring after any mental excitement. He nevertheless persevered in his ex-

periments, and was constantly performing operations then new to the art of surgery. Soon after his attack in 1785 he practised the new method of tying the artery for popliteal aneurism, which has been called the most brilliant surgical discovery of the century. In 1786 appeared his "Treatise on the Venereal Disease" (4to, London; new ed. by Sir Everard Home, 1809, and by Joseph Adams, 1818), and "Observations on Certain Parts of the Animal Economy" (4to, London; new ed. by Prof. Owen, 1800, 1837), the latter a republication of papers from the "Philosophical Transactions," and of others on anatomical and physiological discoveries by the author. In the same year he was appointed surgeon general of the army, and in 1787 he received the Copley gold medal from the royal society for papers on the ovarium, the specific identity of the wolf, jackal, and dog, and on the structure and economy of whales. Soon after he published valuable papers on the treatment of inflamed veins, on intussusception, and on the mode of conveying food into the stomach in cases of paralysis of the œsophagus; and in 1792 he contributed his last paper to the "Philosophical Transactions," entitled "Observations on the Economy of Bees." In this year he resigned his lectureship at St. George's hospital, and devoted himself to the completion of his work on inflammation. On Oct. 16, 1793, while attending a meeting of the board of directors of St. George's hospital, he became violently excited by a remark made to him by one of his colleagues, and leaving the room instantly expired.—As a surgical operator John Hunter was undoubtedly one of the greatest men of his time. As an anatomist and physiologist, he displayed a keenness of intellect, a faculty of generalization, and a philosophic turn of mind, which must rank him among the greatest of modern natural philosophers, and of which he has left an enduring monument in the celebrated museum named after him, and in 1799 purchased by the nation and placed in the keeping of the college of surgeons. At the time of his death it contained more than 10,000 preparations illustrating human and comparative anatomy, physiology, pathology, and natural history, so arranged as to exhibit the gradations of nature from the simplest form of life up to man. The physiological series, which comprised considerably more than half the collection, contained 1,000 skeletons, 3,000 animals and plants illustrating natural history (the animals stuffed or preserved in spirits), and 1,200 fossils, besides monsters and other eccentric forms of animal life. He left in addition 19 MS. volumes of materials for a catalogue of his museum, the preparation of which occupied him during the last few years of his life. The completion of the work was assigned to Sir Everard Home, his executor, who was intrusted for that purpose with the ten most valuable volumes, which he subsequently burned, in accordance, as he said, with

Hunter's express desire; although there is little doubt that he destroyed them to conceal his own appropriation of their contents in the preparation of the anatomical papers which pass under his name. After his death appeared his "Treatise on the Blood, Inflammation, and Gun-shot Wounds," preceded by a biography by Sir Everard Home (4to, 1794); and in 1835-'7 his surgical works, with notes by J. F. Palmer, were published in 4 vols. 4to, with an atlas of 60 plates. Biographies of him have also been published by Jesse Foot (8vo, 1794) and Joseph Adams (8vo, 1816). His remains, after a repose of more than half a century under the church of St. Martin-in-the-Fields, were in March, 1859, disinterred by the royal college of surgeons, and on the 28th of the month deposited with much ceremony in Westminster abbey, next to the remains of Ben Jonson.—His wife, ANNE HOME HUNTER (born in 1741, died in 1821), published in 1802 a volume of poems, several of which were set to music by Haydn.

**HUNTER, Robert Mercer Tallaferra**, an American statesman, born in Essex co., Va., April 21, 1809. He graduated at the university of Virginia, studied law, and commenced practice in 1830. Having served in the Virginia house of delegates, he was in 1837 elected to congress, and in 1839 chosen speaker of the house of representatives. He was defeated in 1843, but re-elected in 1845. In 1846 he was chosen senator in congress, taking his seat in December, 1847. In 1849 he was made chairman of the committee on finance, which post he held until the opening of the civil war. In the mean while he bore a large part in the political discussions of the day. In 1860 he was a prominent candidate for the democratic nomination to the presidency, receiving upon several ballots in the convention at Charleston the next highest vote to that for Mr. Douglas. He took a leading part in the secession movement, and according to the original scheme was to have been president of the new government, Jefferson Davis to be commander-in-chief of the army. He was formally expelled from the United States senate in July, 1861. The confederate plan had been changed, Davis having been made president, and Robert Toombs secretary of state. Toombs was soon superseded by Hunter, and he in a short time by Judah P. Benjamin. Hunter, having been elected senator from Virginia, was classed in the opposition to the administration of Davis. In February, 1865, Hunter, Stephens, and Campbell were appointed peace commissioners to meet President Lincoln and Mr. Seward upon a vessel in Hampton Roads. The conference was futile, Lincoln refusing to treat upon the basis of recognizing the independence of the confederacy. A war meeting was then held in Richmond, over which Hunter presided, and resolutions were passed to the effect that the confederates would never lay down their arms until they should have achieved their independence.

About this time Gen. Lee urged upon the confederate congress the passage of a law authorizing the employment of negroes as soldiers, those thus employed to be made freemen. A bill to this effect was passed in the house of representatives, but was defeated in the senate by a single vote. Mr. Hunter at first voted against it, but having been instructed by the legislature of Virginia to vote for it, he did so, accompanying his vote with an emphatic protest against the passage of the bill, for which he was compelled to vote. He said: "When we left the old government, we thought we had got rid for ever of the slavery agitation. We insisted that congress had no right to interfere with slavery. We contended that whenever the two races were thrown together, one must be master and the other slave. We insisted that slavery was the best and happiest condition of the negro. Now, if we offer slaves their freedom as a boon, we confess that we were insincere and hypocritical. If the negroes are made soldiers, they must be made freemen. If we can make them soldiers, we can make them officers, perhaps to command white men. If we are right in this measure, we were wrong in denying to the old government the right to interfere with the institution of slavery and to emancipate slaves." After the close of the civil war he was arrested, but was released upon parole, and was in 1867 pardoned by President Johnson. In 1874 he was an unsuccessful candidate before the legislature of Virginia for the office of United States senator.

**HUNTER, WILLIAM**, a British physician and anatomist, elder brother of John Hunter, born at Long Calderwood, Lanarkshire, May 23, 1718, died in London, March 30, 1783. At the age of 14 he was sent to the university of Glasgow with the intention of studying for the ministry; but in 1737, not being inclined to the study of theology, he went to reside in Dr. William Cullen's family as a medical student. Three years after he formed a partnership with Cullen, by which he was to take charge of the surgical part of their practice. To prepare himself for this he studied in Edinburgh, and in 1741 went to London with letters of introduction to Dr. James Douglass. Douglass offered to employ him as tutor of his son and as dissector for a work on the anatomy of the bones which he was preparing. Hunter accepted the offer. Douglass died the following year, but Hunter continued to reside with the family as tutor, and to pursue his studies in anatomy and surgery. Concluding to remain in London, the partnership with Cullen was dissolved, but they remained warm friends through life. In the winter of 1746 he made his first appearance as a lecturer on surgery before the society of navy surgeons, and such was the favor with which he was received that he was invited to extend his course to anatomy. About the same time he began to acquire an extensive practice both as a surgeon and an accoucheur; but having in 1748 received the

appointment of surgeon accoucheur to the Middlesex hospital, and in 1749 to the British lying-in hospital, he abandoned surgery, and thenceforth devoted himself almost exclusively to obstetrics. About this time he established himself in a house in Jermyn street, where he commenced the formation of a large anatomical museum. In 1754 he entered into a professional partnership with his brother John, whose industry was of great use in adding to the contents of the museum. In consequence of the illness of John, however, the partnership terminated in 1759. In 1762 he officiated as consulting physician to Queen Charlotte, and two years later was appointed her physician extraordinary. In 1762-'4 appeared his "Medical Commentaries, Part I." (4to, London). In 1765 he applied to Mr. Grenville, then minister, for a piece of ground in the Mews for the site of an anatomical museum. Notwithstanding that he offered to expend £7,000 on the building, and to endow a professorship of anatomy, the application was unfavorably received, and he accordingly purchased a spot of ground in Great Windmill street, and erected the necessary buildings, into which he removed in 1770 with his whole collection. From time to time the collections of eminent practitioners were purchased and incorporated with it, and the zeal of friends and pupils procured him a great number of morbid preparations. Not contented with his anatomical collection, he began to accumulate fossils, books, coins, and other objects of antiquarian research. His library was said to contain "the most magnificent treasure of Greek and Latin works accumulated since the days of Mead;" and his coins, of a portion of which a description was published under the title of *Nummorum Veterum Populorum et Urbium, qui in Museo Guilielmi Hunteri asservantur, Descriptio, Figuris Illustrata*, cost upward of £20,000. In 1781 Dr. Fothergill's collection of shells, corals, and other objects of natural history, was added to the museum at an expense of £1,200. The whole collection, with a fund of £8,000 for its support and augmentation, was bequeathed to the university of Glasgow, where, under the name of the Hunterian museum, it is now deposited. In 1774 appeared his *Anatomia Humani Uteri Gravidii*, in Latin and English (atlas fol., with 34 plates, Birmingham; fol., London, 1828), on which he had been engaged since 1751. It has been called one of the most splendid medical works of the age. A work describing the engravings, entitled "An Anatomical Disquisition of the Human Gravid Uterus and its Contents" (4to, London), was published in 1794 by his nephew Dr. Baillie. The subsequent claim of John Hunter to the discovery of the mode of union between the placenta and the uterus, as described by William in this work, caused a bitter hostility between the brothers, which lasted until the elder was on his deathbed, when a reconciliation took place. In 1768 he

was appointed by the king professor of anatomy in the royal academy of arts. In 1767 he was elected a fellow of the royal society, and two years before his death he succeeded Dr. John Fothergill as president of the medical society. He contributed important papers to the medical and scientific periodicals of the day, and left several lectures and unfinished works in manuscript. He was esteemed one of the chief ornaments of the medical profession in the 18th century, and by his anatomy of the gravid uterus, and his description of varicose aneurism, materially advanced the sciences of anatomy and midwifery.

**HUNTERDON**, a W. county of New Jersey, separated from Pennsylvania on the W. by Delaware river, bounded N. W. by the Musconetcong, E. in part by the Lamington, and drained by branches of Raritan river; area, 480 sq. m.; pop. in 1870, 36,963. The surface is level in the centre and mountainous toward the N. and S. Limestone and freestone are abundant, and the hills are well timbered. The soil of the valleys is fertile. The New Jersey Central, the South Branch, the Belvidere Delaware, and Flemington branch, and the Delaware, Lackawanna, and Western railroads traverse it. The chief productions in 1870 were 340,393 bushels of wheat, 26,799 of rye, 1,021,251 of Indian corn, 902,737 of oats, 41,527 of buckwheat, 86,807 of potatoes, 67,863 lbs. of wool, 226,936 of flax, 965,243 of butter, and 38,110 tons of hay. There were 9,520 horses, 12,983 milch cows, 7,588 other cattle, 22,790 sheep, and 15,311 swine; 33 manufactories of carriages, 23 of clothing, 2 of cordage and twine, 1 of cotton goods, 2 of mirror and picture frames, 6 of hubs and wagon material, 1 of India-rubber goods, 5 of iron, 24 of masonry, 2 of wrapping paper, 19 of saddlery, 9 of sash, doors, and blinds, 48 flour mills, 24 saw mills, and 2 railroad repair shops. Capital, Flemington.

**HUNTINGDON**, a S. central county of Pennsylvania, drained by the Juniata river and its tributaries; area, 730 sq. m.; pop. in 1870, 31,251. It has a very diversified surface, occupied in part by mountains, and noted for its fine scenery. Iron, lead, coal, salt, and alum are found, and timber is abundant. The valleys are fertile. The Pennsylvania Central and the Huntingdon and Broad Top railroads traverse it. The chief productions in 1870 were 388,859 bushels of wheat, 78,480 of rye, 503,807 of Indian corn, 410,479 of oats, 148,679 of potatoes, 54,110 lbs. of wool, 465,027 of butter, and 27,815 tons of hay. There were 7,098 horses, 7,120 milch cows, 11,289 other cattle, 17,780 sheep, and 12,909 swine; 15 manufactories of carriages, 7 of clothing, 12 of furniture, 3 of bricks, 2 of bread, 3 of pig iron, 8 of iron castings, 5 of blooms, 5 of plaster, 8 of saddlery and harness, 13 of tin, copper, and sheet-iron ware, 4 of woollen goods, 14 flour mills, 20 tanneries, 9 currying establishments, 1 distillery, 2 planing mills, and 7 saw mills. Capital, Huntingdon.

**HUNTINGDON**, an extreme S. W. county of Quebec, Canada, divided into two parts by the angle of Chateauguay co., bordering S. on New York, and N. W. on the St. Lawrence river; area, 400 sq. m.; pop. in 1871, 16,304, of whom 6,886 were of Irish, 4,924 of French, 3,184 of Scotch, and 1,033 of English origin or descent. It is drained by the Chateauguay river and other streams, and is traversed by the Province Line division of the Grand Trunk railroad. The surface is undulating and the soil fertile. Capital, Huntingdon.

**HUNTINGDON**, Selma, countess of, a patron of the English Calvinistic Methodists, born in 1707, died June 17, 1791. She was the daughter of Washington Shirley, earl of Ferrers, and was married to Theophilus Hastings, earl of Huntingdon. The Hastings family early became interested in the Methodists, and through their influence and from severe family afflictions the countess was led to cherish a strong sympathy with the methods and principles of the evangelists, especially Whitefield. She was accustomed to frequent the Moravian societies in London; but at the withdrawal of Wesley she favored the Methodist party, and specially encouraged the leaders in the promotion of a lay ministry, which she considered an absolute necessity to the successful evangelization of the masses. Her house at Chelsea, near London, was the resort of fashionable and aristocratic persons, and after Whitefield was appointed her chaplain many of the wits and scholars of the age became his hearers. Her house was likewise the centre of a circle of women of noble rank, who were zealous in the cultivation of a high-toned piety in an irreligious age. Meanwhile the rapid success of Wesley, Whitefield, and their coadjutors had created a demand throughout the kingdom for chapels and meeting houses for the poor. The countess undertook to supply this need, and promoted in every way the labors of the evangelists. She dispensed with her luxurious equipage, and even sold her jewels, to obtain the means for carrying out her plans. Halls and theatres were purchased in London, Bristol, and Dublin, and fitted up for chapels, and accommodations for the societies were provided in England, Ireland, and Wales. She interested many of the noble and wealthy in her plans, met them in frequent conference, and often accompanied the preachers on their missionary tours. By her advice England was divided into six districts, and a scheme perfected for supplying destitute districts with religious instruction. The pressing need for a larger number of ministers led her at length to found a theological seminary at Trevecca in Wales, where pious candidates for the ministry, irrespective of sectarian character, were provided with board, tuition, and other aid, at the countess's expense. While strongly attached to the church of England, she was at length compelled to the avowal of dissent in order to protect the numerous chapels which she had founded from

suppression or appropriation by the establishment. Hitherto, by her strong practical sense and moral power, she had virtually controlled and directed the movements of Calvinistic Methodism. After the "Lady Huntingdon Connection" had taken their position among dissenters, the countess attempted to devise a plan for a closer and more organic union among the various societies. Its provisions were very similar to Wesley's model. In these attempts, however, she met with very little sympathy from her preachers, and after her death the chapels that she had founded became mostly Independent. At her decease she left £5,000 for charitable purposes, and the rest of her fortune for the support of 64 chapels which she had built.

**HUNTINGDONSHIRE**, an inland county of England, bordering on Cambridgeshire, Northamptonshire, and Bedfordshire; area, 359 sq. m., being the smallest county of England except Rutland and Middlesex; pop. in 1871, 63,672. The N. portion forms part of the fen district (see BEDFORD LEVEL), and is devoted chiefly to grazing. In the W. and S. parts the surface is slightly varied by the swell of two low ridges of hills. In the S. E. is an extensive plain of fertile land, and along the banks of the Ouse and Nene are rich meadows overflowed at high tides. The general character of the soil is either gravelly or clayey loam. Although the greater part of the county was once a royal forest, it is now very bare of timber. Agriculture is the only industry. The products are wheat, oats, and beans, with some barley, hops, hemp, turnips, and mustard seed. The chief rivers are the Ouse within the county, and the Nene along the border, with their tributaries. There were formerly several small meres or shallow lakes in the county, but these have all been drained and brought under cultivation. The principal towns are Huntingdon, St. Ives, St. Neots, and Ramsay. Huntingdon is on the Ouse, 59 m. N. of London; pop. of the municipal borough in 1871, 4,243. It was the birthplace of Oliver Cromwell.

**HUNTINGTON**, a N. E. county of Indiana, drained by Wabash and Salamonie rivers; area, 354 sq. m.; pop. in 1870, 19,036. The surface is slightly uneven and the soil fertile. The Wabash and Erie canal, and the Toledo, Wabash, and Western railroad, pass through it. The chief productions in 1870 were 367,521 bushels of wheat, 288,840 of Indian corn, 51,425 of oats, 42,655 of potatoes, 66,257 lbs. of wool, 320,098 of butter, and 12,079 tons of hay. There were 5,902 horses, 5,094 milch cows, 3,582 other cattle, 31,038 sheep, and 20,565 swine; 7 manufactories of carriages, 1 of baskets, 1 of boots and shoes, 4 of furniture, 1 of wagon material, 8 of lime, 5 of saddlery and harness, 2 of cigars, 3 of woollen goods, 3 tanneries, 3 currying establishments, 6 flour mills, and 25 saw mills. Capital, Huntington.

**HUNTINGTON**, I. Daniel, an American painter, born in New York, Oct. 14, 1816. While pursuing his studies at Hamilton college, he

made the acquaintance of Charles L. Elliott, the portrait painter, from whom he received a decided bias for art. In 1858 he entered the studio of S. F. B. Morse, then president of the national academy of design, and soon after produced "The Bar-Room Politician," "A Topper Asleep," &c., besides some landscapes and portraits. In 1836 he spent several months in the vicinity of the Hudson highlands, and executed views near Verplanck's, the Dunderberg mountain, and Rendout creek at twilight and sunset. In 1839 he went to Europe, and in Florence painted "The Sibyl" and "The Florentine Girl." Removing to Rome soon after, he painted "The Shepherd Boy of the Campagna" and "Early Christian Prisoners." Upon his return to New York he was employed for a time almost exclusively upon portraits, his only historical pieces of importance being "Mercy's Dream" and "Christiana and her Children," from "Pilgrim's Progress." For two years he was compelled by an inflammation of the eyes to relinquish his labors, and in 1844 went again to Rome, where he passed the succeeding winter, and whence he sent back to America "The Roman Penitents," "Italy," "The Sacred Lesson," "The Communion of the Sick," and some landscapes. After his return to New York in 1846 he again devoted himself chiefly to portraits. From 1862 to 1869 he was president of the national academy of design. Among his works are "Lady Jane Grey and Feckenham in the Tower," "Henry VIII. and Queen Catharine Parr," "The Marys at the Sepulchre," "Queen Mary signing the Death Warrant of Lady Jane Grey," and another picture of "Mercy's Dream," all of which have been made familiar by engravings. **II. Jedidiah Vincent**, an American clergyman, brother of the preceding, born in New York, Jan. 20, 1815, died in Pau, France, May 10, 1862. He studied medicine and practised for several years, but subsequently took orders in the Episcopal church, officiating for a time as rector in Middlebury, Vt. He afterward went to Europe, where in 1849 he became a Roman Catholic. Returning to America, he edited the "Metropolitan Magazine" in Baltimore, and subsequently the "Leader" in St. Louis. He afterward resided in New York, and finally again went to Europe. He published a volume of "Poems" (1843), and the novels "Lady Alice, or the New Una" (1849), "Alban" (1850), "The Forest" (1852), "Blonde and Brunette" (1859), and "Rosemary" (1860).

**HUNTINGTON**, Frederick Dan, an American bishop, born in Hadley, Mass., May 28, 1819. He graduated at Amherst college in 1839, and spent the three following years in the Cambridge divinity school. In 1842 he was ordained pastor of the South Congregational church in Boston, and in September, 1855, became preacher to Harvard university and Plummer professor of Christian morals. Although educated in the Unitarian belief, his views of

theology gradually underwent a change, and having become convinced that the doctrine of the Trinity is the true doctrine of the Scriptures, he applied for orders in the Episcopal church, was admitted to the ministry in 1860, and resigned his office at Harvard in 1864. He became rector of Emmanuel church, Boston, was elected bishop of Central New York in January, 1869, and was consecrated April 8. His principal publications are: "Sermons for the People" (1856; 9th ed., 1869); "Sermons on Christian Living and Believing" (1860); a course of lectures on "Human Society as illustrating the Power, Wisdom, and Goodness of God" (1860); "Lessons on the Parables of our Saviour"; "Elin," a collection of ancient and modern sacred poetry (1865); "Helps to a Holy Lent" (1872); and "Steps to a Living Faith" (1873). He has also edited various works of the Rev. William Mountford (1846), Archbishop Whately's "Christian Morals" (1856), and "Memorials of a Quiet Life," that is, of the Hare family (1874).

**HUNTINGTON, Samuel**, one of the signers of the American Declaration of Independence, born in Windham, Conn., July 3, 1732, died in Norwich, Jan. 5, 1796. He was educated to the law, and previous to 1775 held the offices of king's attorney and associate justice of the superior court of Connecticut. In January, 1776, he entered the continental congress as a delegate from his native state. In September, 1779, he succeeded John Jay as president of congress, and filled that office till 1781, when he resumed his seat on the Connecticut bench. He served again in congress from May to June, 1783, and in the succeeding year was appointed chief justice of the superior court of Connecticut. In 1785 he was elected lieutenant governor of Connecticut, and in 1786 he succeeded Roger Griswold as governor, to which office he was annually reelected until his death.

**HUNTINGTON, William**, an English preacher, born in 1744, died at Tunbridge Wells in August, 1813. His early life was passed in menial service and dissipation; but having been converted he came to be a zealous preacher among the Calvinistic Methodists, travelling through the country, and gaining many followers. He finally settled in London, and having married for his second wife the widow of a rich alderman, his later years were spent in affluence. He published a great number of discourses and tracts, which were collected in 20 vols. (London, 1820). A selection from these was published by his son (6 vols., London, 1838; 2d ed., 1856). To his name he appended the letters S. S., which he thus explained: "As I cannot get a D. D. for the want of cash, neither can I get an M. A. for want of learning; therefore I am compelled to fly for refuge to S. S., by which I mean sinner saved."

**HUNTSVILLE**. I. A city and the capital of Madison co., Alabama, on the Memphis and Charleston railroad, about 10 m. N. of the Tennessee river, and 165 m. N. of Montgom-

ery; pop. in 1870, 4,907, of whom 2,875 were colored. It is noted for its magnificent scenery, is well built, and contains a handsome court house and other public buildings, a foundery, two planing mills, gas works, water works, a bank, a tri-weekly and two weekly newspapers, and 11 churches, of which 5 are for colored people. Huntsville female seminary, under the charge of the Presbyterians, organized in 1829, in 1872 had 7 instructors and 101 students. Huntsville female college, Methodist, organized in 1853, had 11 instructors and 137 students. II. A town and the capital of Walker co., Texas, at the terminus of a branch (8 m. long) of the International and Great Northern railroad, about 12 m. S. W. of Trinity river and 135 m. E. by N. of Austin; pop. in 1870, 1,599, of whom 638 were colored. It is pleasantly situated on high ground, in the midst of a rich cotton region, has an active business, is well built, and is the seat of Austin college, a flourishing institution under the care of the Presbyterians, of the Andrew female institute (Methodist), and of the state penitentiary. The penitentiary was built in 1848-'9, and has a large tract of land connected with it, and facilities for the manufacture of cotton and woolen goods. A semi-weekly and a weekly newspaper are published.

**HUNYADY, János** (JOHN HUNYADES), a Hungarian general and statesman, born toward the close of the 14th century, died in 1456. His birth and youth are wrapped in legendary obscurity, as is the origin of his surname Corvinus (Hollósi). Under the reign of Albert (1437-'9) he became ban of a province south of the Danube, and under Ladislas I. (1439-'44) count of Temes and commander of Belgrade. Shortly after the latter appointment he repulsed a Turkish army of invasion from his province, and soon after routed the same in Transylvania (1442). In the following year he made a victorious campaign through Servia and across the Balkan, which conquered peace from the Turks. Ladislas, however, was induced by the legate of Eugenius IV. to break it, and perished with the greater part of his army at the battle of Varna (1444). Hunyady, who escaped, was made governor of Hungary during the minority and absence of Ladislas the Posthumous, son of Albert, who was detained by the emperor Frederick III. In 1448 Hunyady was defeated by Sultan Amurath at Kosovo, on the confines of Servia and Bulgaria, but in 1454 he was again victorious over the enemies of his country and Christendom, whose expulsion from Europe he made the task of his life. The heroic defence of Belgrade closed his career. Of his two sons, Ladislas died innocently on the scaffold, and Matthias (Corvinus) ascended the throne of Hungary.

**HUPPAZOLI, Francesco**, a Piedmontese centenarian, who lived in three centuries, born in Casale in March, 1587, died Jan. 27, 1702. His parents sent him to Rome to be educated, and obliged him to enter holy orders. He

d in Greece and the Levant, and in 1667 married at Scio and engaged in commerce.

At 82 years of age he was appointed ambassador to Venice at Smyrna. His habits were ; he drank no fermented liquors, ate and chiefly of game and fruits, never , and went to bed and rose early. He k for the first time in 1701, when he ever which lasted 15 days, and he re-deaf for three months after his re-

At the age of 100 years his hair, and eyebrows, which were white, be-gain black. At the age of 112 years two new teeth, but lost all his teeth be- death, and lived on soup. He suffered ast year of his life from the gravel, and a cold. He was five times married, d 24 legitimate and 25 illegitimate chil- By his fifth marriage, which took place 9th year, he had four children. He left al of the principal events of his life.

Richard, an English prelate, born at ve, Staffordshire, in 1720, died at Har- in 1808. He was the son of a farmer, s educated at Cambridge, where he be- fellow of Emmanuel college in 1742. tinned to reside at Cambridge till 1757, e became rector of Thurstaston. He eacher to the society of Lincoln's Inn ; archdeacon of Gloucester in 1767; of Lichfield and Coventry in 1775; pre- to the prince of Wales and the duke k in 1776; and bishop of Worcester in In 1763 George III. offered him the hopric of Canterbury, but he declined ; principal publications are: "Commen- Horace's *Ars Poetica*" (1749); "Dia-" (1758); "Select Works of Abraham " (1769); "Introduction to the Study Prophecies" (1772); several volumes rmons" (1776-'80); "Works of Bishop ton" (7 vols. 4to, 1788); "Life of ton" (1794); and "Addison's Works" , 1810). There is a collection of his with an autobiography (8 vols., 1811).

WAR, a town of British India, in the e and 100 m. N. N. E. of the city of pop. about 5,000, besides many fakirs bers of the mendicant order, who dwell a. It is a celebrated place of pilgrim- utifully situated at the foot of the Him- ountains, and on the right bank of the . Immense multitudes annually assem- e at the vernal equinox to bathe in the he religious ceremony consisting only in ion; but the desire of being among the plunge into the water is so strong that rding on the narrow passage leading to hing spot has often been attended with disturbances. Every 12th year is re- as especially holy, and as many as 30 pilgrims are said to assemble on such as. The fairs held at the time of the age are renowned.

HEAT, William Henry, an American jour- nalist in Charleston, S. C., July 8, 1827.

He graduated at Harvard college in 1847, and at the Cambridge divinity school in 1849. After preaching for some time at Salem, he went to Europe in 1849 and attended the lectures of Ritter, Von Raumer, and Ranke at Berlin, and returning to Cambridge in 1851 studied during the two following years in the law school. In 1855 he went to New York, joined the staff of "Putnam's Monthly" mag- azine, and was dramatic critic of the "Al- bion." From February, 1857, till after the presidential election of 1860, he was on the staff of the New York "Times." In 1861 he was a delegate to the peace convention at Al- bany. In June of that year, having gone on private business to Charleston, he was arrested as a suspected emissary from the north, and without trial was sent to Richmond, where he was imprisoned 14 months, but made his es- cape through the lines to Washington in Sep- tember, 1862. In October following he joined the editorial staff of the New York "World," and is still (1874) connected with that journal. He has been an indefatigable traveller, and in the discharge of his professional duties has visited at different times nearly every part of Europe, has been three times to Mexico, and has made extended tours in Central and South America. In 1867 he attended and reported for the "World" the celebration of the 18th centenary of the martyrdom of St. Peter at Rome, and in the same year the meeting of the emperors of Austria and France at Salzburg; in 1869 he was present at the opening of the Suez canal and the subsequent fêtes at Con- stantinople; in 1869-'70 he attended the open- ing and session of the œcumenical council at Rome; in 1871 he accompanied and re- ported the proceedings of the United States commission to Santo Domingo; and in 1878 he described in a series of letters the first pas- sage by steam of the higher Andes of Bolivia, and wrote fully concerning the earthquakes of San Salvador. He has written numerous po- ems, including hymns that hold a place in Unitarian collections; has published "Gan- Eden, or Pictures of Cuba," written during a health trip to that island in 1853 (Boston, 1854, and London, 1855), and "General Mc- Clellan and the Conduct of the War" (New York, 1864); has contributed to numerous peri- odicals in the United States and Great Brit- ain; and is now (1874) preparing a work on the Pacific countries of South America.

HURLBUT, Stephen Augustus, an American soldier, brother of W. H. Hurlbert, born in Charleston, S. C., March 24, 1815. He served as adjutant of a South Carolina regiment in the Seminole war in 1835, and practised law in Charleston till 1845, when he removed to Belvi- dere, Ill. He was a delegate to the state consti- tutional convention in 1847, and subsequently was repeatedly elected to the legislature. In May, 1861, he was appointed a brigadier gen- eral of volunteers, commanded at Fort Donelson after the capture, commanded the 4th division



in Gen. Grant's army in the movement up the Tennessee river, took part in the battles of Shiloh and Corinth, held command at Memphis in 1863, commanded a corps in Gen. Sherman's army in the movement to Meridian in 1864, succeeded Gen. Banks in command of the department of the gulf in May, 1864, and was mustered out of the service at the close of the war. He was minister to the United States of Colombia from 1869 to 1873, when he returned to Illinois, having been elected a member of congress.

**HURON.** I. A N. county of Ohio, drained by Huron and Vermilion rivers; area, 455 sq. m.; pop. in 1870, 28,532. It has a nearly level surface, and an excellent sandy soil. The Cleveland, Columbus, Cincinnati, and Indianapolis, the Lake Erie division of the Baltimore and Ohio, and the Lake Shore and Michigan Southern railroads pass through it. The chief productions in 1870 were 472,496 bushels of wheat, 777,083 of Indian corn, 519,905 of oats, 169,312 of potatoes, 445,909 lbs. of wool, 809,801 of butter, 60,842 of cheese, and 43,747 tons of hay. There were 8,550 horses, 10,113 milch cows, 10,182 other cattle, 92,627 sheep, and 15,244 swine; 5 manufactories of agricultural implements, 2 of boots and shoes, 12 of carriages, 2 of cheese, 12 of cooperage, 5 of iron castings, 2 of machinery, 1 of malt, 12 of saddlery and harness, 1 of sewing machines, 7 of tin, copper, and sheet-iron ware, 5 tanning and currying establishments, 4 distilleries, 1 brewery, 7 flour mills, 2 planing mills, and 15 saw mills. Capital, Norwalk.

**II.** An E. county of Michigan, forming the extremity of a point of land between Lake Huron on the E. and N. E. and Saginaw bay on the N. W.; area, 850 sq. m.; pop. in 1870, 9,049. The surface is nearly level, watered by Pigeon, Willow, and Berry rivers, and in some places marshy. Most of the county is covered with forests, from which in 1872 were produced 49,000,000 ft. of lumber. There are also salt wells, from which were obtained 30,615 barrels of salt. The chief productions in 1870 were 54,251 bushels of wheat, 50,194 of oats, 20,778 of peas and beans, 99,005 of potatoes, 10,097 lbs. of wool, 131,265 of butter, and 7,597 tons of hay. There were 624 horses, 1,788 milch cows, 1,197 working oxen, 1,596 other cattle, 2,576 sheep, and 1,033 swine; 4 manufactories of barrels and casks, 2 of hones and whetstones, 1 of salt, and 29 saw mills. Capital, Port Austin.

**HURON,** a W. county of Ontario, Canada, bordering on Lake Huron, and watered by the Maitland and its tributaries; area, 1,288 sq. m.; pop. in 1871, 66,165, of whom 23,740 were of Irish, 19,388 of Scotch, 16,558 of English, and 5,220 of German origin or descent. It is an excellent farming region, and has good facilities for lumbering and ship building. Near Goderich are extensive salt wells. The county is traversed by the Grand Trunk railway. Capital, Goderich.

**HURON, Lake,** one of the great lakes on the boundary between the United States and British America, lying between lat. 43° and 46° 15' N., and lon. 80° and 84° 40' W. It receives at its N. extremity the waters discharged from Lake Superior by St. Mary's river or strait, and also those of Lake Michigan through the strait of Mackinaw. Its outlet at the S. extremity is the St. Clair river. It is bounded W. and S. W. by the southern peninsula of Michigan, N. and E. by Ontario, Canada. Georgian bay, 120 m. long and 50 m. wide, lies wholly within Ontario, and is shut in from the main body of the lake by the peninsula of Cabot's head on the south and the Manitoulin chain of islands on the north; and N. of these islands is Manitou bay or the North channel. The whole width of Lake Huron, including Georgian bay, is about 190 m., and its length about 250 m. Its area is computed to be about 21,000 sq. m. Its elevation above the sea is rated by the state engineers of Michigan at 578 ft.; the Canadians make it 3 ft. less. The level of its waters fluctuates several feet at irregular periods, as is observed also of the other lakes. Various estimates are made of its average depth, the least being 800 ft., and the highest, which is that of the Michigan state report of 1838, 1,000 ft. In this report it is stated that soundings have been made in the lake of 1,600 ft. without finding bottom. Few harbors are found along the W. shore of Lake Huron. About 70 m. N. of the outlet Saginaw bay sets back into the land a distance of 60 m. toward the S. W., and under its islands and shores vessels find shelter from the storms which prevail from the N. E. or S. W. up and down its wide mouth and across the broadest expanse of the lake. Thunder bay is a much smaller extension of the lake into the land, about 140 m. from the outlet. Steamers usually stop here for supplies of wood, chiefly pine and birch, which, with the white pine largely cut for lumber, and excellent grindstones obtained from the sandstone rocks, constitute the only valuable products of these shores. At Presque Isle, 28 m. further N., is another harbor, where the land turns round toward the N. W., and a straight course is thence made for Mackinaw, 70 m. distant. This island is famous as a trading post and fort in the history of the northwest and of the fur trade, and is still a point of importance on the lake. The harbor is deep and well sheltered, on the S. side of the island, under high hills, upon which stands the United States fort. The fishing business is extensively carried on, whitefish of excellent quality abounding in the lake near by, and those of the northern part of Lake Michigan also finding a market here.—The shores on the Michigan side present few features of interest. The rock formations are sandstones and limestones of the several groups from the Helderberg to the coal measures, the latter being found in the upper portion of Saginaw bay, where, however, they are of little

importance. Beaches of sand alternate with others of limestone shingle, and the forests behind are often a tangled growth of cedar, fir, and spruce in impenetrable swamps, or a scrubby scattered growth upon a sandy soil. Calcareous strata of the upper Silurian stretch along the E. coast from the outlet nearly to Georgian bay, and are succeeded by the lower members of the same series down to the Hudson river slates and the Trenton limestone, which last two stretch across from Lake Ontario to Georgian bay. In the metamorphic rocks found in the upper portions of Manitoulin bay copper ores begin to appear, and have been worked at the Bruce mines. With the change in the rock formations the surface becomes more broken and hilly, rising to elevations 600 ft. or more above the lake.—The rivers that flow into Lake Huron are mostly of small importance. The principal streams from Michigan are Thunder Bay river, the Au Sable, and the Saginaw; from Ontario, the French (outlet of Nipissing lake), the Muskoka, the Severn (outlet of Lake Simcoe), and the Nottawasaga, all emptying into Georgian bay, and Saugeen, Maitland, and Aux Sables. The chief towns on its shores are Collingwood and Owen Sound (on Georgian bay), Goderich, and Sarnia (at the entrance of St. Clair river), in Ontario; in Michigan, Bay City at the head of Saginaw bay, and Port Huron opposite Sarnia. The season of navigation in Lake Huron is usually from the last of April or early part of May into December; and the finest season, during which the waters often continue smooth and the air mild and hazy for two or three weeks, is the latter portion of November.

**HURONS**, a once powerful tribe of American Indians, originally occupying a small territory near Georgian bay, a part of Lake Huron. They were the most northwesterly branch of the Huron-Iroquois family, the Hochelagas, occupying Montreal island in Cartier's time, being the most easterly, and the Tuscarroras the most southerly. When the French under Champlain began to occupy the St. Lawrence in 1609, the Hurons were allies of the Algonquins and Montagnais against the Iroquois or Five Nations, the most powerful tribe of the family to which the Hurons belonged. Champlain joined the alliance, and in 1609 accompanied a Huron-Algonquin party on an expedition, which defeated an Iroquois force on Lake Champlain. In 1615 he went up to the Huron country with the Franciscan missionary Joseph le Caron, and thence accompanied the Hurons on an expedition against a tribe in New York, belonging or allied to the Five Nations. The Franciscans continued missions among the Hurons in 1629, and Frère Sazard in his *Grand voyage au pays des Hurons* (Paris, 1632), and *Histoire du Canada* (Paris, 1636), describes them fully and gives a dictionary of their language. They consisted of four divisions: Attignawetans, Attigneenonguabac, Arendahronon, and Lohonteenrat; the first and second being

primitive, and the others subsequently adopted. They called themselves, as the Iroquois did, Ontwaonwes, real men, and as a tribe Wendat. Their country was of very limited extent for an Indian tribe, being only about 75 m. by 25, lying, as was estimated, in lat. 45° 30' N., near Lake Huron. In this space there were 30,000 Hurons in 25 towns of various size, Ossossane being the chief one. Those on the frontiers were fortified by a triple palisade, and gallery within, while many of the others were unprotected. The houses were long, containing several families, two to each fire; they were built of poles covered with bark. The Hurons raised corn, squashes, beans, and tobacco. When Canada was restored in 1632, the Jesuits began their famous Huron missions, which lasted till the destruction of the nation. Diseases had greatly enfeebled them. Then the Iroquois, supplied with firearms by the Dutch, took Ossossane in 1648, killing the missionary Daniel among his flock; the next year two other large towns were destroyed, Brebeuf and Lalemant perishing at the stake. The Hurons then dispersed. The Tohonteenrat surrendered in a body and removed to the Seneca country. The rest fled to Clarity island in Lake Huron and to Manitoulin, but famine swept many off. In 1650 Père Ragueneau led a few hundred to Quebec, who were placed on Isle Orléans, and were soon joined by those left at Manitoulin. In 1656 the Mohawks carried off a number before the eyes of the French garrison, and the Onondagas compelled others to join their canton. Under more vigorous French rule the Hurons began to thrive, and in 1667 they removed to Notre Dame de Foye, and in 1693 to Lorette, then after a time to Jeune Lorette, which has since been their abode. It is 8 or 9 m. from Quebec, on the river St. Charles, on an eminence, and consists of 40 or 50 houses of stone and wood. Their number in 1736 was reported at 60 or 70 men able to bear arms, and these by 1763 were reduced to 40. In 1815 the tribe numbered 250, and the official report of the Canadian government in 1872 gives 264, although in 1870 there were 329 reported. There are few of pure blood. Their own language has been superseded by French, and they have long been practical Catholics.—Their early Huron cosmogony was curious. A woman, Atænsic, flying from heaven, fell into an abyss of waters. Then the tortoise and the beaver, after long consultation, dived and brought up earth on which she rested and bore two sons, Tawescaron and Iouskeha, the latter of whom killed his brother. The son of Iouskeha, called Tharonbiawagon or Aireskoi, was the great divinity worshipped by the Hurons and Iroquois. The tribe was divided into clans or families, and governed by sachems hereditary in the female line. The totem of the whole nation was the porcupine. The Tionontates, called by English colonial writers Dinondadies, were neighbors of the Hurons, and were crushed soon

after them. These fled to Wisconsin, and are also called Hurons, but after their removal to Sandusky they assumed the name Wyandot. (See WYANDOTS.) A grammar of the Huron language, compiled by Père Chaumonot, founder of Lorette, was published at Quebec in 1831.

**HURRICANE** (Span. *huracan*), a word of undetermined origin, signifying a violent storm of wind and rain, generally accompanied with intense displays of lightning and thunder. Although this term was originally special in its application, it is now frequently used to designate not a peculiar class of storms, but in general the strength of the most violent winds known to mariners; thus we may have storms in any part of the world whose severest winds may attain to the force either of a gale, a storm, or a hurricane, according to the circumstances that attend their development. The hurricanes of the Pacific ocean, the China sea, and the northern portions of the Indian ocean are called typhoons, and are from a scientific as well as a practical point of view to be classed in the same category with the hurricanes proper; but in what follows we shall give only such facts and theoretical views as belong specially to the hurricanes of the Atlantic and southern Indian oceans. The general subject of storms in their various aspects will be treated under that title.—To a person occupying a stationary position toward which a hurricane is approaching, it is said that the storm is frequently heralded a day beforehand by a peculiar haziness of the atmosphere, a cessation of the regular trade winds, a lassitude perhaps induced by the hygrometric condition of the air, and an ominous stillness. Then follow a steady slow fall of the barometer, light breezes increasing to high winds from some new quarter of the compass, generally in the West Indies between S. E. and N. E., and the obscuration of the entire heavens by a uniform sheet of cloud of increasing density. When the storm has, in the course of from 4 to 24 hours, finally arrived at its greatest severity, the fury of the wind and the confusion of the scene become indescribable; in the midst of a drenching rain and a steady wind that fills the air with a deafening roar, there occur prolonged gusts whose violence equals or excels the force of the strongest waves; in such gusts the largest trees are uprooted, or have their trunks snapped in two, and few if any of the most massive buildings stand uninjured. In the midst of the confusion incident to the general destruction of property and life, there occurs a mysterious calm, while a break in the clouds and the diminished rainfall seem to denote the end of the storm. But in the course of from five minutes to five hours the wind bursts with additional force from a direction opposite to that which had before prevailed; whatever had escaped the destructive force of the first half of the hurricane is likely to yield to its subsequent fury, and the shipping which before perhaps had been blown out

to sea, is now driven back upon the shore. If now, instead of watching the storm from a fixed standpoint, we take a general survey of the ocean over which it rages, we shall observe that the interval of calm in the midst of the storm, as observed at the fixed station, corresponds to a central spot in a large region of violent winds and heavy rain; these winds are found to blow in spiral lines toward and around the central region of calms, increasing in force as they approach that centre. It will also be seen that the whole system of winds moves bodily over the surface of the earth. It is thus easily understood why the stations over which the centre of the hurricane passes should experience, after the central lull, a wind from the opposite quarter to that which prevailed immediately before.—In the "Philosophical Transactions" for 1698 Langford represents the hurricanes of the West Indies as whirlwinds advancing in a direction opposite to that of the trade wind. Dampier (1701) says the West Indian hurricanes and the Chinese typhoons are of the same nature. In 1801 Capper published a work on winds and monsoons, in which he advanced the opinion that the hurricanes at Pondicherry (1700) and Madras (1773) were of the nature of whirlwinds whose diameter would not exceed 120 miles. In 1820 and 1826 Brando broached the theory that the currents of air in great storms flow from all directions toward a central point. Dove (1828), in controverting the views of Brando, explained the observed directions of the winds on the assumption of general rotary currents or whirlwinds. In 1831 Mitchell expressed the opinion that the phenomena of storms are the result of a vortex or gyratory motion. The scanty observations accessible to the authors previously mentioned were supplemented in 1831 by Mr. Redfield of New York, who then published the first of a series of remarkable papers on the phenomena of storms, in all which he maintained that hurricanes were progressive vorticose whirlwinds. His views were for a long time controverted in America by Espy and Hare. Sir William Reid published his first papers on hurricanes in 1838, and subsequently other works, in which he developed views similar to those of Mr. Redfield. Of the authors previously mentioned, some laid a special stress on the tangential, and others on the centripetal movements of the winds; at present, however, following the studies of Redfield (1839-'56), Espy (1840-'57), Thom (1845), Piddington (1839-'54), Reid (1838-'50), Ferrel (1858), Meldrum (1851-'73), Mohn (1870), Reye (1872), and many others, it is generally acknowledged that the combination of both these movements with an upward one is an essential feature of every hurricane, so that the movement of the surface wind is more correctly described as an ascending spiral. Concerning the direction of this movement, Dove, and independently of him Redfield, concluded that in the storms of Europe and the American coast the winds move

in a circuit about the storm centre, contrary to the direction of the motion of the hands of a watch when the latter is laid on the ground with its face upward. Furthermore, Dove made the important remark that in the hurricanes of the southern hemisphere the air revolves in an opposite direction; this generalization, announced by him, apparently with some limitations, was by the labors of Reid (1838) converted into an accepted law. The law of the rotation of winds around the storm centre is considered to be of the highest importance in its practical bearings on the interests of navigation, and may be stated in other words as follows: If in the northern (or southern) hemisphere you stand with the centre of the hurricane on your left (or right) hand, the wind will be on your back. The determining cause of this law of rotation, and of the distinction between the hurricanes of the northern and southern hemispheres, was imperfectly understood by early writers, as Taylor and Herschel, but was rigidly demonstrated in a remarkable mathematical memoir by Ferrel in 1858, who showed that the rotation of the earth on its axis affects the direction not merely of north and south winds, but of every wind, in such a manner that in the northern hemisphere winds tend as they move forward to deflect to the right hand, but in the southern hemisphere to the left hand. This tendency, which is known either as Poisson's or as Ferrel's law, is in large storms sufficient to determine the direction of rotation, while in storms of comparatively small dimensions accidental circumstances may conspire to annul or even reverse the direction of rotation. Thus we are provided with the means of harmonizing, at least in great part, the views of Hare, Dove, and others, with those of Redfield and Ley.—There are unfortunately but few actual measurements of the velocity of the stronger winds that occur within the limits of a hurricane. In general it appears that the velocity increases as we proceed from the outer limits toward the centre of the storm, but suddenly diminishes to feeble irregular winds and calms in the central space. From the observed destructive force of some gusts it has also been calculated that a velocity of 10 m. per minute must have been momentarily attained, but the computations are not very satisfactory. The highest hurricane winds that have ever been actually observed have on the British coast attained a velocity of 130 m. per hour; in the comparatively small hurricane of August, 1871, the observers in Florida of the United States army signal corps recorded a velocity of 85 m. per hour; all these winds of course were interspersed with gusts of great violence. The diameter of the region of calms varies from 20 m. to a much smaller size, and probably even to nothing. It would seem that in some hurricanes, as frequently in the smaller ones on land, the so-called axis of the storm rises temporarily above the surface of

the earth. The central space in general, according to Redfield, increases in diameter as the storm moves away from the equator northward or southward.—A heavy rainfall extending far beyond the region of most violent winds attends all hurricanes. The quantity of water that falls during the prevalence of these storms forms a large percentage of the total annual rainfall over the hurricane regions, and in this respect they perform an important service to mankind. At Mauritius in the Indian ocean a single storm has been known to be attended by a rainfall of more than 10 inches. The area of cloud and rain is especially extended on the N. and E. quadrant of the storms of the North Atlantic; it is sometimes much contracted, though rarely wanting, on the west side of the hurricanes of both the northern and southern hemispheres. The movements of the clouds have been carefully observed, especially by Redfield (1832-'42) and Ley (1866-'70), and the result is well expressed by Reye (1872): "While on the earth's surface the storm wind in spiral curves gradually flows inward, it forces the flying storm clouds in spiral curves outward, and removes them away from the axis of the cyclone." This generalization was fully explained from a theoretical mechanical point of view by Ferrel, and was shown by him to be a consequence of the rising or upward movement of the masses of air that are drawn into the whirlwind. The clouds then must move in spirals opposed to the movements of the lower winds. Redfield estimates the angle between the winds below and the clouds above to be about 22.5°.—The barometric disturbance is one of the most remarkable features of a hurricane. The nearer one approaches the centre, the lower is the barometric pressure, and at the centre the depression is frequently two or three inches. The first notice of an approaching hurricane, when it is yet 100 to 400 m. distant, is usually given by the steady fall of the barometer; as we approach the centre the fall is more rapid. The law by which the pressure diminishes, as well as the variations from it, may be illustrated by two examples, the first showing a very regular depression, the second giving a great and rapidly increasing rate of fall. The first example is Redfield's Cuba hurricane of Oct. 4-7, 1844, for which we have the following pressures: at the centre, 27.7 in.; at 100 m. distance, 28.0 in.; at 200 m. 29.0 in.; at 300 m., 29.5 in.; at 400 m., 29.8 in. The second example is from Buchan (1871), and relates to the Bahama hurricane of October, 1866. On the evening of the 1st of October we have the following pressures: at the centre, 27.7 in.; at 15 m. distance, or the radius of the central column, 27.8 in.; at 300 m., 29.7 in.; at 500 m., 29.8 in.; and at 800 m., 30.0 in. The ratio at which at a fixed station the barometer falls on the approach of a hurricane differs from the preceding by reason of the progressive motion of the storm toward or

from the station; on board a vessel, the barometric fall is further complicated by the movement of the observer. The best idea of the barometric disturbance is given by a chart of synchronous observations on which isobarometric lines are drawn. These isobars will be found to be crowded together on one side (generally the advancing half) of the storm more than on the other, and to enclose a small oval or circular region of lowest pressure, almost if not quite identical with that of the area of calms, though sometimes apparently in advance of it. In a general way it may be stated that the velocity of the wind increases with the crowding of the isobarometric lines. The exact relation between the two is quite complicated, and may be deduced from the formulas of the above mentioned treatise by Ferrel, combined with the considerations introduced by Peslin in 1867 and Reye in 1872. It is evident that the law above given for the rotation of the wind may be converted into a rule for finding the centre of calms, which will also hold good for finding the centre of lowest barometer; this latter is generally spoken of as the storm centre or axis. Buys-Ballot has expressed this generalization in the form known as Buys-Ballot's rule, viz.: in the northern hemisphere stand with your back to the wind, and the lowest pressure will be on your left hand and somewhat in front thereof; a rule that applies especially to, and was apparently suggested by, the behavior of the winds of hurricanes and similar storms.—The dimensions of hurricanes generally increase from day to day until the dissipation of the entire storm, while the intensity of the winds is believed on the average to diminish somewhat; this will however depend upon the atmospheric conditions favoring the development or the decadence of the disturbance. Given a proper supply of warm moist air, and it can be shown that the central depression with the attendant wind and rain must steadily increase up to a certain limit. These favorable circumstances are generally found combined in a remarkable degree in the region of the Gulf stream, the Kuro Siwo, and similar ocean currents; accordingly, on reaching these the area of cloud and rain expands, as also do the diameters of the isobaric curves. The dimensions of the central depressions vary quite irregularly, but appear on the average to increase as the storm continues; while the actual height of the barometer at the centre changes much less, but is believed to diminish gradually so long as the intensity of the wind increases. If a curve, enclosing a region in which the winds attain the force ordinarily described as a moderate gale, be assumed as the limit of the storm, it will be found that in the earliest stages of the hurricane it has a diameter of from 50 to 200 m., which increases in the course of 5 or 10 days to from 400 to 1,200 m.; thus a disturbance that may have been originally designated as small or local, increases so as to involve half

the surface of the North Atlantic ocean. track of the centre of the hurricane is indication of the progress of the storm the earth, and much labor has been bestowed upon such collations of logs of vessels as elucidate this important branch of the subject. But notwithstanding the labor expended have as yet been very few hurricanes traced back to what appears to be very near origin, and in not a single instance has any takable evidence of their origin been adduced. The general position of hurricane tracks earlier parts of their course therefore remains obscure, although the immense accumulation of material by the labors of the various national government weather bureaus is rapidly dissolving our ignorance on this point. as the known hurricane tracks are considered it may be stated that in the North Atlantic ocean each uniformly appears to be a segment of a parabola having its axis coincident with the parallels of 25° to 35° N. latitude, and longitudes of whose apices fall between meridians 40° and 100° west of Greenwich; but mostly between 65° and 85°. The southern extremity of the parabolic track branch passes either to the north of or over the Windward islands, while the northern extremity passes to the south of or over Newfoundland. In a few cases the first portion of the track has been traced southeastward nearly to the coast of Senegambia, and the latter portion of the track northeastward to the ocean between Iceland and Scotland; some tracks curve northeastward before reaching land, and may even strike England or France. The hurricanes of the southern hemisphere describe similar parabolic tracks, which lie at a corresponding distance south of the equator, and are symmetrically disposed with reference thereto. Very few have been traced in the South Atlantic ocean, but in the eastern Indian ocean the majority of the hurricanes pass from Sumatra and Java southwestward to within 500 m. of Madagascar, then northeastward and southeastward. In general, (1870) and Reye (1872) state that all hurricanes (of which hurricanes are the grandest examples) move in the direction in which for the first time the warmest and moistest air has been rising, and producing the heaviest cloud and rainfall. If we combine with this the tendency of the whirlwind as a whole to move away from the equator, as proved by the fact that it seems to the writer that we have a close approximation to the full statement of the reason for the parabolic form of their tracks.—The rate of progression of the West Indian storm centres varies from 50 m. per hour in a few cases to 10 or 15 as the other extreme; that of the storms of the southern Indian ocean varies from 1 to 20 m. The rate of progression in the North Atlantic increases with the growth and northward movement of the storm, and, though sometimes quite variable, is not so much so as in the case of the southern

storms of the Indian ocean. The rate of progress must be carefully distinguished from the velocity of the wind, as the latter has no known relation to and far exceeds the former. —The waves and swells produced by the hurricane winds are a most important feature; these waves are the largest and most formidable known to the mariner. They form with greatest regularity at points directly in advance of the approaching storm centre; at other points they form a confused mass of crossed sea: in the neighborhood of the land the confusion is increased by the waves reflected from the shores. Such is the equality of the contest of opposing waves, that near the central region these sometimes lose their progressive movement and become stationary pyramidal waves, simply rising and falling. The smaller waves that are propagated in all directions from the region of severest winds, degenerate into long gentle swells that outrun the storm in its progress, and announce its presence several hours or a day in advance of its arrival. Besides these waves, it is believed that the extended region of low barometer allows the formation of a peculiar "cyclone wave," which is similar to the tidal wave of mid-ocean. The cyclone wave is coextensive with the area of low barometer; it is highest at the central lowest pressure, where its elevation above the ordinary sea level should be a foot or more for each inch of barometric depression.—From the earliest times the months from July to October have been known in the West Indies as the "hurricane season." A table published by Poey in 1855 gives the distribution by months of 355 hurricanes recorded on the Atlantic between 1493 and 1855. According to this work, there are recorded in this period in all in January 5, February 7, March 11, April 6, May 5, June 10, July 42, August 96, September 80, October 69, November 17, December 7; but the annual period is probably not very correctly shown by this list, because of the imperfections of the earlier records. More recently Poey has revised his list and added many later hurricanes, and has published in the *Paris Comptes Rendus* for Nov. 24, 1873, and Jan. 5, 1874, the results of a comparison between hurricanes and the frequency of solar spots. His results seem to remarkably confirm those of Meldrum, who had previously studied the hurricanes of the Indian ocean from the same point of view. Poey states that in the majority of cases the years of the greatest number of hurricanes are also the years of the greatest sun-spot frequency. The extensive researches of Köppen (1873) have shown that the amount of heat received from the sun varies annually with the sun spots, whence we infer that the variations in solar heat produce a similar variation in the terrestrial evaporation, and an increased tendency to the formation of hurricanes. The actual number of hurricanes visiting any limited region is of course very small. Since the year

1700 the centres of about 25 have been known to pass quite near the coast of Georgia and South Carolina, which is by far the most frequently visited portion of the United States. Nearly all those of the Indian ocean pass near to the islands of Mauritius, Rodriguez, &c.—Concerning the origin and cause of the hurricanes of the Atlantic ocean comparatively little is positively known, but it seems by analogy that they may originate wherever the lower stratum of warm moist air is rapidly elevated above the sea level, whether (1) by being pushed up over an elevated plateau or mountain chain, or (2) by the under-running of a layer of cold dry air, or (3) by the conflict of two opposed and nearly balanced currents of warm moist air. In numerous instances one or the other of these cases seems to have occurred; and as these, combined with (4) the radiation of heat into space, are the prevailing causes that determine the origin and growth of storms in general, there seems no reason in the case of hurricanes to appeal to more forced theories. The immense mechanical power stored up in the heat and vapor of moist air has been abundantly demonstrated by Espy, Peslin, and Reye. Whenever, by the action of either of the four causes just mentioned, the process of condensation of vapor into cloud, rain, or snow begins, there at once occurs an influx of air from all sides, and from below as well as from above, to fill up the partial vacuum thus created; this influx toward a central region is immediately followed, as shown by Ferrel, by the formation of a whirl whose subsequent development is entirely dependent on the supply of moist air. The hurricanes of the southern Indian ocean are thus generated in the region of calms between the N. W. monsoons and the S. E. trade winds of that ocean. Similarly hurricanes have been known to originate in the neighborhood of Florida when a cold north wind has swept under the warm moist air of the gulf and ocean. Another class originates in a similar manner in the western portion of the gulf of Mexico after a Texas norther has prevailed for a few days. A few begin in the interior of Texas when a high barometric pressure on the gulf, or a low pressure in the western territories, forces or draws the air of the gulf up over the plains of Texas. But by far the larger class of the Atlantic hurricanes, including those of greatest extent and violence, appear to originate between the Windward islands and the African coast, and generally quite near to the latter; apparently these begin with heavy rains in the region of calms, such as are accompanied on the African mainland by the peculiar harmattan and tornadoes of that coast, which may be, so far as we know, either the consequence or the determining cause of the heavy rains. The storms that originate here may either move as far west as the American coast before recurving toward Iceland and Norway, or may describe a much shorter route, and

finally arrive at Great Britain, or possibly at Portugal.—*Rules for the Avoidance of Hurricanes at Sea.* The researches of Redfield first led to the suggestion of certain rules for the direction of navigators. The erroneous theories of the purely circular and of the radial movement of the hurricane winds early led their respective advocates to the suggestion of rules for avoiding the dangers of these storms, which later and more correct views as to the spiral or vorticose movement have somewhat modified. It may in general be said that a vessel's safety can only be assured by the possession of a reliable barometer, either aneroid or mercurial; and having this, the navigator should proceed thus: First, as soon as the ocean swell, the falling barometer, the clouds, and the rain announce that a hurricane exists, though it may be 500 m. from him, he should at once lay to long enough to ascertain how rapidly the barometer is falling and the wind increasing, and in which direction the course of the wind is changing. If the wind increases without materially changing its direction, the storm centre is advancing directly toward him; if, however, the wind veers or backs, the direction in which the centre is at any moment may be approximately determined by the rule above given, viz.: "in the northern or southern hemisphere, stand with your back to the wind, and the centre will be on your left or right hand, and in front." The mariner may then by due consideration of his own desired course, and the customary track of hurricanes in that part of the ocean, so alter his course as to avoid the storm centre on the one hand and a lee shore on the other, and may indeed, if there be plenty of sea room, take advantage of the strong wind to hasten his own course. Further details on this subject are given in all works on navigation. It is very rare that a navigator cannot by cautious manœuvring thus avoid the dangerous portions of a hurricane; on the other hand, it is said that many ocean steamers, relying upon the power of their engines, the strength of their build, and their great speed, deliberately plough through the heart of the severest storms rather than incur a possible delay of a few hours in order to avoid them. The hurricane of August, 1873, which destroyed over 1,000 vessels on our Atlantic coast, and those of October, 1873, and February, 1874, afforded numerous instances of such bravado.

**HURST, John Fletcher**, an American clergyman, born near Salem, Md., Aug. 17, 1834. He graduated at Dickinson college in 1853, taught ancient languages two years at Ashland, N. Y., went to Germany and studied theology at Halle and Heidelberg, returned to the United States in 1858, and for eight years was pastor of Methodist Episcopal churches, chiefly in Passaic and Elizabeth, N. J. In the autumn of 1866 he took charge of the theological department of the mission institute of the German Methodist church in Bremen, Germany, which

was afterward removed to Frankfort under the name of the Martin mission institute, where he continued to be its director for three years, meantime visiting Russia, the Scandinavian countries, France, Switzerland, Italy, Great Britain, Greece, Syria, and Egypt. In 1871 he returned to the United States to become professor of historical theology in the Drew theological seminary at Madison, N. J. In 1873 he was elected president of that institution, retaining his chair of historical theology. Dr. Hurst has published a "History of Rationalism" (1865), "Outlines of Bible History" (1873), "Martyrs to the Tract Cause" (1873), and "Life in the Fatherland: the Story of a Five Years' Residence in Germany" (1874). He has translated portions of Hagenbach's "History of the Church in the 18th and 19th Centuries" (2 vols., 1869), Van Oosterzee's "Lectures in Defence of St. John's Gospel" (1869), and Lange's "Commentary on the Epistle to the Romans," with additions (1870).

**HURTER, Friedrich Emanuel von**, a Swiss historian, born in Schaffhausen, March 19, 1737, died in Gratz, Aug. 27, 1865. He studied theology at Göttingen, and was gradually promoted to high ecclesiastical offices; but he was opposed on account of his high-church views, and his *Geschichte Papst Innocens III. und seiner Zeitgenossen* (4 vols., Hamburg, 1834-'42) resulted in 1841 in his withdrawal from the church over which he presided in Schaffhausen, and he joined the church of Rome in 1844. In 1846 he was appointed historiographer of the emperor of Austria, who ennobled him. Among his later publications is *Geschichte des Kaisers Ferdinand II. und seiner Aeltern* (11 vols., Schaffhausen, 1850-'64).

**HUSBAND AND WIFE.** The laws which govern the marital relation, and determine the mutual rights and obligations of the parties, are among the most important of all laws; and it is to be regretted that in the United States they are less accurately determined and less ascertainable than any others of equal consequence. The reason is that we received from England this portion of the common law, and have only of late years perceived its repugnance to reason and justice. We now know that the feudal system, upon which the common law is founded, did not give to woman that place and those rights which she ought to have. It not only regarded husband and wife as one, but the husband as that one. The sentiment that the law needs vast change in this respect is proved to be universal by the fact that there is no one of our states in which it has not undergone great modification; and the difficulty in making the change in such a way that the essential character of the marriage relation may not be impaired, is proved by the great diversity in the provisions recently introduced, in the frequent changes among them, and in the very frequent expression of opinion that much harm has already been done. In the East woman has always been regarded as

a servant of her husband, as his property, and as his plaything; and man has always been held in absolute political subjection. In Greece there were republics and democracies, in name at least; and certainly that political tyranny which had prevailed among eastern nations was greatly lessened, and the domestic tyranny of the husband over the wife was modified about equally. But the liberty of Greece was the liberty of comparatively few, who were masters of the many; and the most conspicuous of the women of Greece were those who, like Sappho and Aspasia, had indeed escaped from the *gynæceum*, but had not found a home. In Rome there was a wider spread and better protection of personal right, for even under the most despotic emperors municipal rights and privileges were generally preserved throughout the Roman world; and woman had also advanced so far, that the Roman matron has been since regarded as the type of female dignity and purity. But much was yet wanted. The feudal system, built upon the ruins of western Rome by the Teutonic nations, a new race, acknowledging the new influence of Christianity, made an immense advance, because it gave to every man, even the serf, a definite place and definite rights, and in theory at least knew nothing of unlimited power; and to woman it gave the unspeakable advantage of Christian marriage. It introduced, probably as a means of remedying or of mitigating social mischiefs which it could not otherwise restrain, the spirit of chivalry, whose controlling principle was the sentiment of honor; and while this newly developed sentiment exerted a very wide and beneficial influence upon all the relations and all the departments of society, in nothing was it more useful than in the profound respect and tender care which it taught at least to inspire toward woman. It was under this feudal system that the law grew up which forms the basis of the law under which we live. It was by the gradual elevation of woman in social and domestic life, by the side of man as he rose toward the possession of political rights, that so much good was attained as exists in that law. That the law of husband and wife in the United States is in advance of any that has existed or now exists elsewhere, we are confident. The tendency of the law, however incomplete it may yet be, is to respect and secure the rights of woman in such wise as to preserve her influence and her happiness; and to make the relation of husband and wife not a form of servitude or the means of oppression, but the central origin of blessings which could spring from no other source, and may pervade the whole life of both sexes. As much the greater part of the common law is still in force with us, and whatever laws we have are but various modifications of that law, we purpose, first, to give a condensed view of the principles of the common law in its reference to the relation of husband and wife; and then to present a brief statement of

the principal variations from this law in all the states of this Union. Promises to marry, the contract of marriage, and settlements or contracts in view of marriage, will be considered in the article MARRIAGE. Here we shall treat only of the effect of marriage on the property of a woman, and of the husband's liability for her debts contracted previous to marriage, and of her power to bind him by her contracts, and of his obligations for her, after marriage.—1. A woman's real estate remains her own after marriage; but her husband acquires a right to it (or, in law language, an estate in it) for her life, and an estate in it for his own life as soon as a living child is born to them, by what is called tenancy by curtesy. He has therefore a life estate in her land either for her life or for his own life; but when this life estate ceases, her rights, or the rights of her heirs, revive absolutely. He cannot transfer her land by his deed, nor can she by her deed; but in this country it may be transferred by the joint deed of the two. In different states different precautions are provided by law, to make it sure that she executes such a deed of her own free will. Thus, in many of the states, she must be examined apart from her husband, by some magistrate, as to her willingness and her motives for thus disposing of her land. On the other hand, by her marriage, she acquires an indefeasible right of dower to the use of one third of his lands during her own life, of which she cannot be divested but by her own act. In this country she usually releases her right of dower, when she wishes to do so, by adding her release to her husband's deed of the premises; but his creditors cannot generally get it in any way without her consent. (See DOWER.) 2. A woman's personal property in possession becomes absolutely the husband's property by marriage. By this is meant all the money in her hands, and all her chattels, as furniture, plate, pictures, books, jewels, &c. Nor can he by common law give to her either of these or chattels of his own during marriage, because transfer of possession is essential to a valid transfer by gift, and her possession is his possession in law. He however may give to her by his will what he chooses to, and may doubtless make a valid transfer of anything in possession as a gift *causa mortis*. (See GIFT.) The reason why the personal property of the wife is thus absolutely transferred to the husband may have been, in part, the lingering influence of the falsity which regarded the wife herself as only the property of the husband; but it was much more, probably, the comparative worthlessness of personal possessions in the feudal ages, when the common law began. Whatever were the reasons, they have little force or application at present. A single woman may, in general, make whatever contracts a man can. If by such a contract she acquires and receives into her own hands any property, it is property in possession, of which we have spo-



ken. But if the thing which she purposes to obtain by the contract be money, or the right to dividends, or any other right, and it remains to be received or acquired after her marriage, she herself possesses not the thing, but a right to demand and receive the thing: and this right is a thing in action (usually called by the Norman French phrase a *chose in action*), and not a thing in possession. This chose in action, belonging to the wife, passes by marriage to the husband, but not absolutely. What he acquires is the right to reduce it to possession, and thereby make it absolutely his own. But he is not obliged to reduce it to possession; and if he does not, and dies, the wife surviving him, all his right is gone, and the chose in action remains as absolutely the property of the widow as it would have been had she never married. The principal choses in action to which this rule applies are notes, bills of exchange, and evidences of debt generally, and scrip or stocks standing in her name. The principal ways of reducing it to his possession are four: by collecting and receiving the debt for his own use; making a new contract with the debtor in his own name, in substitution for her name; having the scrip or certificates or other evidences of debt transferred to himself and his own name; or suing the debt and recovering a judgment upon it. If she dies before him, and before he has reduced them to his own possession, he may now do so as her administrator, and then retain them for his own benefit. If he dies (having survived her) without having reduced them to possession, his next of kin may take out letters as her administrator, and reduce the choses in action to possession for his heirs. In regard to the debts she owes at the time of marriage, the general rule is that the husband is answerable for all of these. The creditor may demand payment of the husband, and may sue him. This is equally true of the debts which had matured and become due before marriage, and of those which were not payable until afterward; and his liability for her debts is the same, whether he receives much with her, or little, or nothing. But this liability is not absolute; for if she dies before he pays the debt, and before a judgment is recovered against him, his liability ceases. But if she leaves choses in action not reduced to the husband's possession, these are still liable for her debts, and the husband, or whoever becomes her administrator, must apply them to pay these debts, and retain only the surplus for the husband or his next of kin. If he dies before he pays her debts, and before judgment is rendered against him, his estate is not liable, but the wife's liability, which was suspended during his life, revives at his death. This is true although he received a large property with her. But when a wife thus brings a considerable property to her husband, courts of equity sometimes interfere on her application and compel him and his assignees to make an equitable settlement out of it for the support of herself and of the children of the marriage, if any. 3. We will now consider the contracts or obligations of the wife made or entered into during marriage. In the first place, a married woman has at common law no power whatever to make a valid contract which shall bind herself or her husband. If money is due for her services, or for money lent by her, it is due not to her, but to him. Her time and her labor and her money are all his. But she may act as his agent in making a contract, and if authorized by him, he is bound. This authority may be express, or it may be implied from frequent acts of agency recognized by him, as when she acts as his clerk, accepting or paying bills, &c.; and then it does not differ in law from a common agency. There is, however, an important and peculiar agency of the wife, growing out of her duties; and this is an implied agency for the husband in all domestic matters, as the hiring of servants, and the purchase of provisions and of clothing for the family. As this grows out of necessity, it is measured by it; but the law means a reasonable necessity, and this is only an appropriateness. For any contract of this sort made by her, which is in due conformity with her husband's means, station, and manner of life, would bind him, and he would not be permitted to deny his authority. If they exceeded this necessity or appropriateness, the husband could be held only on some evidence of authority or assent, as that he knew the contract, or saw the things bought, and made no objection. The question then occurs, How far is the husband bound to supply the necessities of the wife? The general rule on this subject is, that he is bound to supply her with all necessaries, which means in this case all her reasonable wants, while they live together. If they separate because he drives her away without sufficient cause, the same liability continues; and then he is responsible for any debts she may contract for this purpose. Even Lord Eldon declared that "where a man turns his wife out of doors, he sends with her credit for her reasonable expenses." (8 *Espinasse*, 250.) There can hardly be a sufficient cause for thus casting her off without his liability for her subsistence, unless it be her adultery; but this certainly is sufficient. If, however, she voluntarily leaves him, she cannot carry his credit with her, unless she leaves with sufficient cause; and while it is not easy to determine in all cases what would be sufficient cause, perhaps it would be safe to say that any cause which would be sufficient for divorce, either from the bonds of matrimony or from bed and board, would justify her leaving. While the law is now pretty well settled, both in England and in this country, as to when the husband is liable for necessaries furnished to the wife, and when he is not, a question of much moment remains, and of late years has been much considered, viz.: On what ground does this liability rest? It must rest on his authority as proved, or as im-

plied by law; or else upon his marital duty as husband. If it stands upon the former foundation, it must follow that he may always prevent his liability by express refusal and prohibition; or, in other words, that he always has the power to limit or prevent his liability. If it stands on the foundation of his marital duty, this he is bound to discharge, and his prohibitions are of no effect. The former was the unquestionable rule in England and here until very recently, no other ground for the husband's liability being recognized in any way than his authority express or implied; and therefore it was held that if a wife lived with her husband, no one could recover from him the price of any necessaries supplied to her, under any circumstances, against his prohibition. Thus, Chief Justice Hale said (1 Siderfin, 109): "The law will not presume so much ill, as that a husband should not provide for his wife's necessities." At length, however, it began to be seen that there might be cases of incapacity, as where the husband was wholly insane, and could not be supposed to constitute an agent or confer authority upon any one; and yet it could not be supposed that the wife was to be deprived of the necessaries of life which her husband's means were amply sufficient for, because he could not authorize the purchase of them. Again, we have seen that the husband who drives his wife abroad sends his credit with her; but the absurdity of supposing that he constitutes her his agent struck the court. Baron Alderson said (Read v. Legard, 6 Exch., 636): "It is a monstrous proposition that a man who drives a woman out of doors, who hates, who abominates her, actually gives her authority to make contracts for him." In that case the principle was recognized that the right of a wife to a proper support grows out of the marital relation, and that the liability of the husband for necessaries supplied to her is a consequence of that right. This case was so decided in 1851; but like decisions had previously been made in this country, and are now the settled law. It must be remembered, however, that there is an essential difference between the case where husband and wife cohabit, and that where they live apart. In the first, the presumption of law is strong against the husband; and he can resist payment for supplies furnished only by showing that they were not necessaries, either because they were unreasonable and inappropriate in kind or in amount, or that the wife was sufficiently supplied elsewhere. But if she have separated from him, no such presumption exists. Whoever supplies the wife now, takes upon himself the risk of being able to show that she needed what he gave her, and that there was no such sufficient cause for the husband's withdrawing his support of her as would destroy his liability for what was furnished to her.—As to the separation of husband and wife by mutual consent, the law has always regarded it as a kind of voluntary divorce, and formerly refused to

admit or acknowledge it in any way. Of late years, however, it seems to be otherwise. It is still a rule of the common law that husband and wife cannot contract with each other, because they are not two persons, but one. Hence no bargain which they can make directly with each other has any force or effect at law. But if they make their bargain through and by means of a third person, by way of trustee, and enter into certain covenants with him, a court of equity, and for some purposes a court of law, would permit this trustee to maintain such actions as might be necessary to give full effect to the bargain, although its only purpose were to provide for the separation of the parties. There are, however, two qualifications to this rule. One is, that if the court see that the terms of separation are catching, oppressive, or unreasonable, they will not carry them into effect. The other is, that the *locus penitentiae* is always kept open. Although the bargain provides that the separation shall be perpetual, and all its terms are founded upon this supposition, and are clothed for this purpose in the most stringent language, yet, as soon as either party wishes the separation to cease, it must cease. The husband cannot deprive himself of his right to recall his wife; and she cannot deprive herself of her right to return. By the "custom of London," a married woman may be a sole trader there, but nowhere else in England. In the United States, partly by statute and partly by adjudication, a married woman would generally be permitted to carry on business on her own account, much as a single woman might, in case of continued abandonment, or long imprisonment of the husband, or alienage and non-residence, or with the knowledge and consent of the husband, which might be inferred from circumstances. It should be added that the husband is liable for the wife's wrong doings in many cases; as for her libel, slander, fraud, cheating, and generally for injurious misconduct. If she commit a crime in his presence, the law presumes that he ordered it; but he may remove this presumption by evidence of its falsity.—Important changes have been made in the common law by statutes in the several states of the American Union. In Maine, the property owned by the woman at marriage or acquired afterward remains hers, and she has the same rights as any other owner in respect to it, except that if the property came from the husband she cannot dispose of it without his joining. In New Hampshire, after three months' desertion or any act of the husband entitling her to divorce, she may hold and dispose of the property by her acquired and the earnings of the minor children, and the judge of probate may order provision made for her from her husband's property in the state, and her property shall descend on her death as if she were single. A married woman may will her property to any one except her husband, but not cut off his right by the curtesy. In Vermont, the su-

preme court may authorize a deserted wife to convey her estate and the personal estate which came to the husband by the marriage, and require the debtors of the husband in her right to make payment to her; and the proceeds of the earnings of herself and the minor children are to be at her disposal. The rents and profits of the wife's real estate, and the interest of the husband in it, are exempt from execution for his debts, and can only be conveyed by her joining in the deed. The wife may dispose of her property by will. In Massachusetts, a married woman may be a sole trader, and may dispose of her real estate by will, leaving to the husband his estate by the curtesy, and also her personal estate, but not more than one half of it away from the husband without his consent. She holds as her own all property howsoever acquired except by gift from her husband, but she cannot convey real estate or shares in a corporation except with his consent, or the consent of a judge of the supreme, common pleas, or probate court. Her real estate and corporate shares are not liable for the husband's debts. In Rhode Island, a married woman may dispose of her real estate by will, saving to the husband his estate by the curtesy, and whatever deposits are made by her in savings banks are her own. In Connecticut, the personal property acquired by the husband in right of the wife he holds as trustee for her, except to the extent he may have paid ante-nuptial debts, and his interest in her real estate cannot be taken for his debts during her life or the life of children. The proceeds of her real estate are deemed hers in equity and not subject to his debts, and all acquired by her personal services is hers absolutely. Her savings deposits are also her own, and there are further provisions in case of abandonment or abuse by the husband. In New York, the wife's property, acquired before or after marriage, is subject to her own control, and not liable for the husband's debts, but is liable for her own debts, while the husband is not liable except in case of neglect to take out administration on her estate on her death. In New Jersey, the real and personal estate of the wife, whenever acquired, remains hers, free from her husband's control and not liable for his debts. In case of his desertion she may have provision made for her from his estate. In Pennsylvania, the property of the married woman, acquired before or after marriage, remains hers, free from any control by the husband, and liable for her debts, but not for his. The husband is not liable for the wife's ante-nuptial debts. In case of desertion or neglect by the husband to provide for her, she has the rights of a *feme sole*. In North Carolina, the interest of the husband in the real estate of the wife cannot be taken on execution for his debts, nor can it be disposed of by the husband except with her consent. In Florida, the property of the wife remains hers, and the husband is not liable for her

ante-nuptial debts. The same is true in Alabama, and substantially so in Mississippi. In Louisiana the laws are peculiar, but it is competent for the married woman to carry on business as a sole trader, and to have all her property secured to her own use, or the property of the two may be in common. In Texas the laws are also peculiar, but the property of the wife owned at the marriage, or acquired by gift, devise, or descent afterward, remains her own, though subject to the husband's management. In California, the property owned by either the husband or wife at the time of the marriage remains his or hers, as does also any that either may acquire by gift, bequest, devise, or descent afterward, with the rents, issues, and profits thereof; but all other property acquired by either afterward is community property. Husband and wife may contract with each other or with third persons respecting property, as they might if unmarried; his separate property is not liable for her ante-nuptial debts, nor her separate property or earnings for his debts, and dower and curtesy are abolished. While the husband is liable for the wife's support, the wife is also liable for his support if he has no separate property and they have no community property, and he from infirmity is incompetent to support himself. The husband has the management of community property, and may dispose of it otherwise than by will. In Kentucky, a married woman may dispose of her separate property by will, and the husband during her lifetime has only the use of it. In Ohio, a married woman may dispose of her separate property by will, and the interest of the husband in any of her property cannot be taken for his debts during her life or the life of children. In Indiana, the wife's property remains hers and may be disposed of by will, and is not liable for the husband's debts. In the other western states, it may be said generally, the real and personal estate owned by the wife before marriage or acquired by her afterward is at her absolute disposal, by contract, conveyance, or will, and not subject to her husband's debts; while the husband is not liable for her debts contracted before marriage nor for those contracted afterward, except where she may have acted as his agent and with the proper authority. The recent changes in the southern states have been in the same direction. It is not easy to say exactly how the estate by the curtesy stands in the states where it is not expressly saved by statute, but we should say any valid conveyance of the wife's estate would cut it off, and in some states it has been decided that the broad terms in which statutes secure to married women their property will preclude curtesy attaching.—In other respects statutes have made important changes respecting the rights of women which do not depend on the status of marriage. Thus, in the territory of Wyoming the distinction of sex in the exercise of the elective franchise has been abol-

ished, and women of the requisite age are admitted to vote and are eligible to office. In Illinois, by statute, women passing the necessary examination may be admitted to the bar, and in some of the other states they have been admitted by the courts without question. Women who pay school taxes are voters at school meetings in a number of the states, and in recent elections in some, notably in Illinois and Iowa, women have been chosen county superintendents of schools. In Michigan a woman has for several years been state librarian.

**HUSBANDRY, Patrons of**, an organization of agriculturists in the United States. Its origin is attributed to Mr. O. H. Kelley, a native of Boston, who in 1866, being then connected with the department of agriculture in Washington, was commissioned by President Johnson to travel through the southern states and report upon their agricultural and mineral resources. He found agriculture in a state of great depression consequent upon the radical changes wrought by the civil war and the abolition of slavery. At the same time there was much dissatisfaction among the farmers of the west and northwest in consequence of the alleged high charges and unjust discriminations made by railroad companies in the transportation of their products. The farmers also complained of the exorbitant prices exacted by middlemen for agricultural implements and stores. Mr. Kelley conceived the idea that a system of cooperation, or an association having some resemblance to the order of odd fellows or masons, might be formed with advantage among the dissatisfied agriculturists. For this purpose a plan of organization was determined upon by him and Mr. William Saunders, of the department of agriculture. The name chosen for the order was "Patrons of Husbandry," and its branches were to be called granges (Fr. *grange*, a barn). The constitution of the order provides for a national grange and state and subordinate granges. There are ceremonies of initiation, rituals, and injunctions of secrecy, though in some respects the order is not secret. The officers of a grange, whether national, state, or subordinate, are elected by the members, and comprise a master, overseer, lecturer, steward, assistant steward, chaplain, treasurer, secretary, gate keeper, Ceres, Pomona, Flora, and lady assistant steward. Women are admitted to membership upon the same terms and with equal privileges as men, but only those persons interested in agricultural pursuits are eligible. Regular meetings of the national and state granges are held annually, while subordinate granges usually meet monthly or oftener. The constitution was adopted, and on Dec. 4, 1867, the national grange was organized in Washington; its headquarters are now in Georgetown, D. C. In the spring of 1868 Mr. Kelley founded a grange in Harrisburg, Pa., one in Fredonia, N. Y., one in Columbus, O., one in Chicago, Ill., and six in Minnesota. The number of granges soon began

to multiply rapidly, and in 1874 they had been organized in nearly every state and territory of the Union. In 1871, 125 granges were established; in 1872, 1,160; in 1873, 8,667; and in the first two months of 1874, 4,618. At the beginning of 1874, the number of granges in the United States was 10,015, with a membership of 750,125. The total number of members in April, 1874, was estimated at about 1,500,000. The order has its greatest strength in the northwestern and western states, and is well represented in the south. At the annual meeting of the national grange in St. Louis, Mo., in February, 1874, a declaration was adopted setting forth the purposes of the organization as follows: "To develop a better and higher manhood and womanhood among ourselves; to enhance the comforts and attractions of our homes, and strengthen our attachment to our pursuits; to foster mutual understanding and cooperation; to maintain inviolate our laws, and to emulate each other in labor; to hasten the good time coming; to reduce our expenses, both individual and corporate; to buy less and produce more, in order to make our farms self-sustaining; to diversify our crops, and crop no more than we can cultivate; to condense the weight of our exports, selling less in the bushel, and more on hoof and in fleece; to systematize our work, and calculate intelligently on probabilities; to discountenance the credit system, the mortgage system, the fashion system, and every other system tending to prodigality and bankruptcy. We propose meeting together, talking together, working together, buying together, selling together, and in general acting together for our mutual protection and advancement as occasion may require. We shall avoid litigation as much as possible by arbitration in the grange. We shall constantly strive to secure entire harmony, good will, vital brotherhood among ourselves, and to make our order perpetual. We shall earnestly endeavor to suppress personal, local, sectional, and national prejudices, all unhealthy rivalry, all selfish ambition. Faithful adherence to these principles will insure our mental, moral, social, and material advancement." One of the chief aims of the organization is to bring producers and consumers, farmers and manufacturers, into direct and friendly relations; for this purpose cooperation is encouraged among farmers in the purchase of agricultural implements and other necessities direct from the manufacturer. The organization therefore is maintained for social and economic purposes, and no grange can assume any political or sectarian functions.

**HUSBANDS, Herman**, an American revolutionist, born in Pennsylvania, died near Philadelphia about 1794. Removing to Orange co., N. C., he became a member of the legislature and leader of the "regulators," a party which was organized in 1768 for the forcible redress of public grievances. He published in 1770 a full account of the rise of the troubles. A

battle took place in 1771 between Gov. Tryon with 1,100 men and 2,000 of the insurgents on the banks of the Alamance, in which the latter were defeated. Husbands escaped to Pennsylvania, where he was concerned in the whiskey insurrection in 1794, and was associated with Albert Gallatin, Breckenridge, and others, as a committee of safety.

**HUSH**, a town of Roumania, in Moldavia, near the Pruth, 36 m. S. E. of Jassy; pop. about 13,000. It is the seat of a Greek bishop, and has a normal school. Here, on July 25, 1711, the peace was concluded between Russia and Turkey which saved Peter the Great and his army on the Pruth from destruction or captivity.

**HUSKISSON, William**, an English statesman, born at Birch-Moreton, Worcestershire, March 11, 1770, died at Eccles, Lancashire, Sept. 15, 1830. He was originally intended for the medical profession, and in his 14th year went to Paris to pursue his studies. Here he resided for several years, and adopted the revolutionary doctrines of the day; but he afterward abandoned them, and became private secretary to the British ambassador, Lord Gower, with whom he returned to England in 1792, and in 1795 was made under secretary of state for war and the colonies. In 1796 he entered parliament, of which, with the exception of two years, from 1802 to 1804, he remained a member until his death. Following the fortunes of Mr. Pitt, he retired from office with him in 1801, and became secretary of the treasury on the formation of the new Pitt ministry in 1804. He attached himself to Mr. Canning, taking office with him in 1807 and retiring in 1809. In 1814 he was appointed chief commissioner of woods and forests, and in 1823 entered the cabinet as president of the board of trade and treasurer of the navy, which offices he retained until the death of Canning. In the Goderich cabinet and in that of the duke of Wellington he held the office of secretary for the colonies till May, 1829, when the redemption of a pledge formerly given obliged him to vote against his colleagues, and he resigned. As a public man he was chiefly known by his speeches on financial and commercial subjects; and he is regarded as the great pioneer in the free-trade movement. In 1823 he carried through parliament an act for removing various restrictions upon commerce. He was also active in procuring the repeal of the combination laws and the relaxation of the restrictions on the exportation of machinery. He was present at the opening of the Liverpool and Manchester railway, and at Parkside, while conversing with the duke of Wellington, was run over by a locomotive, and died the same evening.

**HUSS, John**, a Bohemian religious reformer, born about 1373, burned at Constance, July 6, 1415. His surname was derived from his place of birth, Hussinetz, near the border of Bavaria. He studied first in his own town,

then in Prachatitz, and finally at the university of Prague, where he graduated in 1393. In 1398 he began to give lectures in philosophy and theology; in 1401 he became president of the university faculty of theology; and in 1403 he was installed preacher in the Bethlehem chapel, which had been established ten years earlier for the purpose of enabling the people to hear preaching and the Scriptures in the Bohemian tongue. He became the confessor of the queen, and the head of a party of priests and scholars who meditated reforms in discipline and in doctrine. His first polemical treatise, *De Sanguine Christi Glorificato*, was occasioned by the pilgrimages to Wilsnack to see and worship the miraculous blood of Christ there shown on the consecrated host. In successive sermons preached before the archbishop, Huss next arraigned the misconduct of the clergy even in high places; demanded the despoiling of the churches of useless ornaments, that the poor might be fed and clothed; and called upon the secular officers to hinder and punish the open vices of ecclesiastics. This excited strong opposition, which was increased when the ordinance of Charles IV., giving special privileges to the native over the foreign students, was revived by Huss, and the Poles and Germans deserted the university, depriving the city of thousands of its population. Soon afterward he became rector of the university. Other circumstances, connected with the papal schism, aided to embroil Huss with the archbishop and his friends. It became a warfare between the university and the cathedral. The pope interfered for the latter; and, fortified by his bull, at the close of the year 1409 the archbishop Sbinko burned 200 volumes of the works of Wycliffa, which had been deposited in his palace. Against this act Huss protested, in a spirited treatise addressed to the new pope, John XXIII., with arguments of such weight that a commission of doctors condemned the archbishop for irregular action. The cry of heresy was now raised against Huss, and he was summoned to Rome to answer this charge. The court, the university, and even the archbishop sent a defence of his orthodoxy, and Huss sent advocates to plead his cause before the cardinals, but they were not heard. He was condemned as a heretic, and ordered to quit Prague; and the city was placed under ban so long as he should remain there. Finding it vain to resist, he left the city; but his retirement only inflamed the zeal of his partisans. The books which he wrote at this period, half apologetic, half polemic, tended more and more to widen the breach and to arouse acts of violence. An outbreak in the city followed; the partisans of Huss were victorious, the archbishop fled, and Huss came back to his chapel, emboldened to preach more and more vehemently against prevalent corruptions. He praised the king for upholding the cause of truth and purity against the mandates of eccle-

siastical power; and in his treatise *Contra Occultum Adversarium*, written at this time, he maintains the doctrine that kings have the right to rule the clergy not less than the laity. Soon more serious trouble arose. The pope had issued bulls of excommunication against King Ladislas of Naples. Political reasons induced the court and university to side with the pope; but Huss immediately published two tracts against the papal bulls. A reaction followed. The partisans of the pope were insulted in the streets, and Huss had great difficulty in restraining the fury of his followers. This was followed by tracts which maintained that the clergy were only stewards of the wealth in their possession, which belonged to the people and not to the church. Huss contended that not the priest's word, but the power of God, wrought the change of transubstantiation; claimed that any one moved by the Spirit had the right to preach; and asserted the right of conscience as against the edicts of popes and councils. He was accused of denouncing the veneration of saints and the worship of the Virgin, but defended himself against these charges. He was again summoned to Rome, but took no heed of the order. Repeated attempts were made by the king to compose the difficulties, but without success. A decree was procured from Rome, putting Huss again under ban as an incorrigible heretic; and at the earnest request of the king, he left Prague for a time, and found shelter in his native town. In a long treatise upon "The Church," he holds that the papacy began to exist at the time of Constantine, and that its usurpations threatened to secularize and so to destroy the gospel. Frequent letters and occasional secret visits confirmed the zeal of his partisans. He continued to preach in the cities to immense crowds; and after a time, to be nearer Prague, he removed his residence to the castle of Cracowitz, which had been offered him as a refuge. In 1414, at the instigation of the emperor Sigismund, Pope John XXIII. summoned a general council at Constance, and Huss was cited to appear. Trusting to the safe-conduct which the emperor granted him, he resolved to obey. On his arrival at Constance he was welcomed by the pope with a fraternal greeting, and was promised that the former interdict should be suspended. For some time Huss was free to come and go, to discuss and preach. Expecting a special trial, he had prepared his defence. But on Nov. 28 he was arrested and imprisoned in the cathedral, and several days later transferred to the Dominican convent, on an island in the lake. An accusation against Huss had been drawn up, and three commissioners were appointed to visit him in prison, question him, take down his answers, and report to a council of doctors. Huss asked, but was not allowed, the assistance of counsel. His private letters were opened, his appeals to the emperor disregarded, and the kind treatment of his prison keepers could hardly compensate for the in-

justice of his enemies. The flight of the pope only aggravated his suffering. He was transferred to the strong castle of Gottleben, heavily chained. A new commission was appointed to examine and decide in his affair, and at the beginning of June, 1415, he was removed to the Franciscan convent in Constance. On June 5 he had his first hearing before the council, which had already at a previous session condemned the heresy of Wycliffe. The attempt of Huss to answer the first article of accusation was met by such a storm of outcries that he was unable to proceed; and the hearing was adjourned until the 7th, when it was renewed in presence of the emperor. He was accused of denying transubstantiation; of treating St. Gregory as a buffoon; of teaching the doctrines of Wycliffe; of encouraging his friends to resist the mandates of the archbishop; of exciting a schism of the state from the church; of appealing from the pope to Christ; of counselling the people to violent and aggressive measures; and of boasting that he could not have been forced either by pope or emperor to come to Constance, unless he had chosen to come. Some of these charges he admitted; some he denied. A third hearing was allowed him on the next day, when 39 articles, extracted from three of his works, were read, touching various points of his teaching concerning the church, its officers and sacraments. Huss was then summoned to retract these heresies, which he declined to do, affirming that he could not retract what he had never said, nor ought he to retract what he had said until its falsity was shown. On June 24 the books of Huss were condemned to be burned as heretical, and on July 6 he was brought before the council to receive sentence. After a discourse by the bishop of Lodi, from the text, "that the body of sin be destroyed," the 39 articles were read, together with the sentence of condemnation of the books of Huss, and finally the sentence of himself, to be degraded from the priesthood as an incorrigible heretic, and given over to the secular arm. He was then conducted out of the city to an open field, in which a stake and a pile of wood had been erected. Here he was again summoned to abjure his heresies, but at the summons he only knelt and prayed, using the words of the psalms of David. As the fire was kindled, he began to sing with a loud voice the *Christe eleison*, and only ceased when he was suffocated by the rising flame. The ashes of the pile were gathered and cast into the Rhine; all traces of the event were carefully obliterated, and to this day the exact spot remains uncertain.—The writings of Huss, not including the minor pieces lately published by Palacky, are of four kinds, dogmatic and controversial, exegetical, sermons, and epistles. Of the first class, there are 27 separate treatises, besides fragments. Of the class of exegetical writings, there are five treatises, on the acts of Christ, the passion of Christ, a commentary on seven

chapters of the first epistle to the Corinthians, notes on other canonical epistles, and an explanation of ten of the Psalms. In the class of sermons there are 38, two of which were written at Constance, but never preached. There are two series of letters, the first of 14, written before, and the second of 56, written after his departure from Prague to Constance. The complete works of Huss were published in quarto at Strasburg in 1525. For his biography, see Neander's "Church History" (vol. v., Torrey's translation), Gillett's "Life and Times of Huss" (2 vols., Boston, 1863), and Palacky's *Documenta Magistri Joannis Vitam, Doctrinam, etc., illustrantia* (Prague, 1869). (See HUSSITES.)

**HUSSARS** (Hung. *húsz*, 20, and *ár*, rate), the national cavalry of Hungary and Croatia. The name is also applied to some bodies of light cavalry in the armies of other countries of Europe. It is derived from the fact that in the 15th century every 20 houses in Hungary were required to furnish a soldier with a horse and furniture. The arms of the hussars are a sabre, a carbine, and pistols. Their regimentals were originally a fur cap with a feather, a doublet, a pair of breeches to which the stockings were attached, and a pair of red or yellow boots. There were five regiments of hussars under Tilly at Leipsic in 1631. The name first became general in the 18th century, when regiments of hussars were organized in the principal European armies.

**HUSSITES**, the name of the followers of John Huss in Bohemia, who, on his death in 1415, organized as a sect, making the offering of the cup to the laity in the sacrament of the eucharist the badge of their covenant. Upon the death of Wenceslas (1419) they refused to recognize the emperor Sigismund as king, whereupon the Hussite civil war broke out. They were divided into two parties, the more moderate Calixtines and the more rigid Taborites. Ziska, the leader of the latter party, assembled them on a mountain which he fortified and called Mt. Tabor, captured Prague, pillaged the monasteries, and in several engagements defeated Sigismund. (See ZISKA.) After the death of Ziska (1424) his place was filled by a monk named Procopius, who defeated the mercenaries sent under the name of crusaders by the emperor and the papal legates in the battles of Mies (1427) and Tachau (1431), and whose troops ravaged Austria, Franconia, Saxony, Catholic Bohemia, Lusatia, and Silesia. A council held at Basel in 1433 made concessions which were accepted by the Calixtines. (See PROCOPIUS.) The Taborites, rejecting the compromise, were vanquished in the battle of Prague (1434), and by the treaty of Iglau (1436) the compromise of Basel was accepted by Bohemia, and Sigismund was recognized as king. On the death of Sigismund (1437) controversies again arose, and civil wars were prosecuted with no decisive results, till at the diet of Kuttenberg (1485) a peace was established

by King Ladislas which secured Catholics and Calixtines in the possessions they then held.— See Schubert, *Geschichte des Hussitenkrieges* (1825); Grünhagen, *Geschichtequellen der Hussitenkriege* (1871); Bezold, *König Sigmund und die Reichskriege gegen die Hussiten* (1872); and Palacky, *Urkundliche Beiträge zur Geschichte des Hussitenkrieges* (1872).

**HUTCHESON**, Francis, a Scottish philosopher, born in Ireland, Aug. 8, 1694, died in Glasgow in 1747. He studied theology at Glasgow, and became pastor of a Presbyterian congregation in Ulster. His "Inquiry into the Original of our Ideas of Beauty and Virtue" (1720) gave him distinction among philosophers. In 1728 he published a treatise on the "Nature and Conduct of the Passions and Affections," and in the following year was appointed professor of moral philosophy in the university of Glasgow. His *Synopsis Metaphysicæ Ontologiæ et Pneumatologiæ complectens*, and his *Philosophiæ Moralæ Institutio*, were written as text books for his classes. His most complete and elaborate work, the "System of Moral Philosophy," appeared after his death (2 vols., Glasgow, 1755), with a biography by Dr. William Leechman. Truth he divides into logical, moral, and metaphysical. Logical truth is the agreement of a proposition with the object it relates to; moral truth is the harmony of the outward act with the inward sentiment; and metaphysical truth is that nature of a thing wherein it is known to God as that which actually it is, or in other words it is its absolute reality. He maintained that besides the five external senses we possess also internal senses, one of which occasions the emotions of beauty and sublimity, and another gives rise to the moral feelings. He introduced the term moral sense, and maintained the existence of certain universal propositions, derived not from experience, but from the connate power of the mind (*menti congenita intelligendi vis*).

**HUTCHINSON**, a S. E. county of Dakota, intersected by the James or Dakota river; area, 432 sq. m.; pop. in 1870, 37. The surface is diversified, the soil good. Capital, Maxwell.

**HUTCHINSON**, Anne, founder of a party of Antinomians in New England, born at Alford, Lincolnshire, England, in 1591, died near New Amsterdam (now New York) in August, 1643. She was the daughter of the Rev. Francis Marbury. Becoming interested in the preaching of John Cotton, and of her brother-in-law John Wheelwright, she followed the former to New England with her husband, arriving in Boston Sept. 18, 1634. She was admitted a member of the Boston church, and rapidly acquired influence. She instituted meetings of the women of the church to discuss sermons and doctrines, in which she gave prominence to peculiar speculations which even on her voyage had attracted the attention and caused the displeasure of her fellow passengers. Such were the tenets that the person of the Holy Spirit dwells in every believer, and that

the inward revelations of the Spirit, the conscientious judgments of the mind, are of paramount authority. Two years after her arrival the strife between her supporters and her opponents broke out into public action. Among her partisans were Vane, Cotton, Wheelwright, and the whole Boston church with the exception of five members, while the country clergy and churches were generally united against her. "The dispute," says Bancroft, "infused its spirit into everything; it interfered with the levy of troops for the Pequot war; it influenced the respect shown to the magistrates, the distribution of town lots, the assessment of rates; and at last the continued existence of the two opposing parties was considered inconsistent with the public peace." The peculiar tenets of Mrs. Hutchinson were among the 82 opinions condemned as erroneous by the ecclesiastical synod at Newtown, Aug. 30, 1637; and in November she was summoned before the general court, and after a trial of two days was sentenced with some of her associates to banishment from the territory of Massachusetts, but was allowed to remain during the winter at a private house in Roxbury. It was her first intention to remove to the banks of the Piscataqua, but changing her plan she joined the larger number of her friends, who, led by John Clarke and William Coddington, had been welcomed by Roger Williams to his vicinity, and had purchased by his recommendation from the chief of the Narragansetts the island of Aquidneck, subsequently called Rhode island. There a body politic was formed on democratic principles, in which no one was to be "accounted a delinquent for doctrine." The church in Boston, from which she had been excommunicated, vainly sent a deputation to the island with the hope of reclaiming her. After the death of her husband in 1642, she removed with her surviving family into the territory of the Dutch. The Indians and the Dutch were then at war, and in an invasion of the settlement by the former her house was attacked and set on fire, and herself and all her family, excepting one child who was carried captive, perished either by the flames or by the weapons of the savages.

**HUTCHINSON, John**, an English Puritan revolutionist, born in Nottinghamshire about 1616, died in Sandown castle, Kent, Sept. 11, 1664. He was a man of family and of good education, and was married at Richmond, July 3, 1638, to Lucy, daughter of Sir Allen Apsley, governor of the tower of London, with whom he subsequently settled on his estate at Owthorpe. After the commencement of the civil war he declared for the parliament and was appointed governor of Nottingham castle, which he held until the close of the war. He afterward represented Nottingham in parliament, and, as a member of the high court of judiciary appointed for the trial of the king, concurred in the sentence pronounced on him. The subsequent course of Cromwell, however, met with

the disapproval of Hutchinson. At the restoration he was comprehended in the general act of amnesty, but was subsequently arrested on a suspicion of treasonable conspiracy, and after a detention of ten months in the tower was removed to Sandown castle, where he died of an aguish fever brought on by confinement in a damp cell. His wife survived him many years, and left a memoir of him, which is valuable as a record of events. It was first published from the original manuscript in 1806 (4to, London), and several other editions have since appeared.

**HUTCHINSON, John**, an English philosopher, born at Spennithorne, Yorkshire, in 1674, died Aug. 28, 1737. After receiving a careful private education, he served as steward in several noble families. As riding purveyor of the duke of Somerset, master of the horse, he made a large collection of fossils. In 1724 appeared the first part of his "Moses's Principia," in which he disputed the Newtonian theory of gravitation. In the second part (1727) he continued his criticisms of Newton, and maintained on Biblical authority the doctrine of a *plenum* in opposition to that of a *vacuum*. From this time one or more of his uncouthly written volumes, containing a sort of cabalistic interpretation of the Hebrew Scriptures, appeared annually. His leading idea is that the Scriptures contain the elements of all rational philosophy as well as of general religion. The Hebrew language has not only its literal but its typical sense, every root of it being significant. His philosophical and theological works were published in London in 18 vols. (1749-'65).

**HUTCHINSON, Thomas**, governor of the province of Massachusetts, born in Boston, Sept. 9, 1711, died at Brompton, near London, in June, 1780. He was the son of a merchant of Boston who was long a member of the council, and graduated at Harvard college in 1727. After engaging without success in commerce, he began the study of law. He represented Boston for ten years in the general court, of which he was for three years speaker. He became judge of probate in 1752, was a councillor from 1749 to 1766, lieutenant governor from 1758 to 1771, and was appointed chief justice in 1760, thus holding four high offices at one time. In the disputes which led to the revolution he sided with the British governor. The mansion of Hutchinson was twice attacked in consequence of a report that he had written letters in favor of the stamp act, and on the second occasion (Aug. 26, 1765) it was sacked, the furniture burned in bonfires in the street, and many manuscripts relating to the history of the province, which he had been 30 years in collecting and which could not be replaced, were lost. He received compensation for his losses, but none of the assailants were punished, although the proceedings were denounced by resolution in a public meeting. In 1767 he took a seat in the council, claiming



it *ex officio* as lieutenant governor; but both the house and council resisted his pretension, and he abandoned it. The legislature was inclined to restore him to the council in 1768, until it was announced by his opponent James Otis that he received an annual pension of £200 from the crown. When in 1769 Gov. Bernard was transferred to Virginia, the government of Massachusetts fell to Hutchinson. The popular excitement had already been increased by the arrival of British troops, and after the Boston massacre a committee of citizens, headed by Samuel Adams, forced him to consent to the removal of the regiments. He received his commission as governor in 1771, and his whole administration was characterized by duplicity and avarice. In 1772 Benjamin Franklin, then in London, procured some of the confidential letters of Hutchinson and his brother-in-law Andrew Oliver; these were forwarded to Massachusetts, and proved that he had been for years opposing every part of the colonial constitution, and urging measures to enforce the supremacy of parliament; and the result was a petition to the king from the assembly and the council praying for his removal from the government. The last of his public difficulties was when the people of Boston and the neighboring towns determined to resist the taxation on teas consigned by the East India company, two of the consignees being sons of Gov. Hutchinson. The popular committees were resolved that the tea should not be landed, but should be reshipped to London. A meeting of several thousand men, held in Boston Dec. 18, 1773, demanded the return of the ships, but the governor refused a pass. On that evening a number of men disguised as Indians repaired to the wharf, and emptied 342 chests of tea, the whole quantity that had been imported, into the bay. In the following February the governor sent a message to the legislature that he had obtained his majesty's leave to return to England, and he sailed on June 1. The privy council investigated his official acts, and decided in favor of "his honor, integrity, and conduct." He was rewarded with a pension. He published the following works: "The History of the Colony of Massachusetts Bay, from the First Settlement thereof in 1628 until the Year 1750" (2 vols., London, 1765-'7); "A Brief State of the Claim of the Colonies" (1764); and a "Collection of Original Papers relative to the History of the Colony of Massachusetts Bay" (1769). From his manuscripts a history of Massachusetts from 1749 to 1774 was prepared by his grandson, the Rev. John H. Hutchinson, of Trentham, England (1828).

**HUTTEN, Ulrich von**, a German scholar and reformer, born in the castle of Steckelberg, near Fulda, April 20 or 22, 1488, died in Switzerland, Aug. 29, 1523. When 11 years old he was placed in the monastery of Fulda, that he might there become a monk; but at 15 he ran away from the cloister to the university of

Erfurt, where he was supported by his friends and relatives. A disease then new to Europe raged in many places, and when it appeared in the summer of 1505 in Erfurt both students and teachers took to flight. Hutten went to Cologne, where he studied the writings of Thomas Aquinas and Duns Scotus. This city was the stronghold of the old system, led by Ortwein, Hoogstraten, Tungern, Pfefferkorn, and all who were then termed *Dunkelmänner* or "Obscurants." Here, in the headquarters of monkish peculiarities, Hutten collected materials for the sketches of the *Epistole Obscurorum Virorum*. Even in Cologne, however, the new spirit of classic study had found a home under the care of Johannes Rhagius, who endeavored to form a taste for the works of classical antiquity and what was then termed poetry, a word limited by the Obscurants to pure and ancient Greek and Latin metrical composition. Hutten became his friend and pupil, and, when he was driven away under the accusation of corrupting youth and theology, followed him to Frankfort-on-the-Oder, where a new university was opened in 1506. At the inauguration Hutten published his first poem, *Carmin in Laudem Marchie*, in praise of the mark of Brandenburg. Here he received the degree of M. A., and remained till 1508. The disease which had driven him from Erfurt again seized on him, and he sought health in travel. In northern Germany he was everywhere warmly received, but was wrecked on the Baltic and reduced to great poverty. In this condition he went to the university of Greifswald, and was kindly provided with clothing and hospitably entertained by the burgomaster Wedeg Lütz, and by his son, a professor in the university. An unexplained change in their treatment of him compelled him to leave the town; and on the way, late in December, he was set upon by their servants, lying in wait for him, beaten, stripped of the garments furnished him, and robbed of all his money and papers. In this condition, diseased and wounded, he came to Rostock, where he wrote a famous satire on Lütz (*Klagen gegen Lütz*), calling on all the scholars of the new school in Germany to avenge him. In Rostock he lectured on the classics, established intimate relations with the professors, and worked for the interests of the classic school. In 1511 he went to Wittenberg, where he published his *Ars Versificatoria*, regarded in its day as a masterpiece. Thence he wandered through Bohemia and Moravia to Vienna, where for a time he appears to have been prosperous and courted. Finally arriving at Pavia in April, 1512, Hutten resolved to study law. But three months later the city was besieged by the emperor Maximilian, and Hutten, who had taken part in the contest, believed himself in danger of death, and wrote his famous epitaph. Plundered of all he possessed, he fled to Bologna. Here his disease broke out again, and, repulsed by every one,

badly treated, and starving, he enlisted as a soldier in the emperor's army. The results of his Italian studies were embodied in the satire of *Oteris* ("Nobody"). He returned to Germany, suffering from his old disease, in 1514. He thought he had succeeded in effecting a cure by the use of gum guaiacum, and wrote a treatise, *De Guaiaci Medicina et Morbo Gallico*. An accident now brought him into note. Duke Ulrich of Würtemberg had fallen in love with the wife of his cousin Johann von Hutten, and murdered the husband. When Hutten heard of this he wrote his "Deplorations," in which he cried for vengeance. He availed himself of this deed to call on German towns to free themselves from ducal tyranny. His denunciations made the tyrant a byword. But a short time elapsed before Hutten found himself in a new quarrel, ardently defending Reuchlin, who as a scholar was protesting against the wholesale destruction of all Hebrew books, for which the Cologne Obscurants were clamoring. With the aid of many friends he published the celebrated *Epistolæ Obscurorum Virorum*, a work which greatly aided the reformation, and previous to this his *Triumphus Capionis* ("The Triumph of Reuchlin"), the publication of which was long delayed by the scruples of Erasmus. In 1515 he again went to Rome, ostensibly to study law; but having become involved in a quarrel, he fled to Bologna, which he was obliged to quit for a like reason. After visiting Ferrara and Venice, he found it necessary to return to Germany. At Augsburg he was presented to the emperor, who gave him in public the spurs of knighthood. He was then sent by the elector of Mentz on a mission to Paris, where he established intimate relations with Le Larnel. Retiring to his family castle of Steckelberg, Hutten, having written by way of introduction several epigrams on Pope Julius II., edited the work of Laurentius Valla entitled *De Falso Credita et Ementita Donazione Constantini Magni* (1517). In 1518 he found a protector in Albert, margrave of Brandenburg, whom he invited in a glowing panegyric to place himself at the head of united Germany. In the same year he accompanied the margrave to the diet of Augsburg, where Luther was to reply to Cajetan. But "Hutten, now the brilliant knight, troubled himself but little as to the poor Augustinian monk;" he was full of a project for uniting the princes of Europe against the Turks, and was fascinated with the idea of becoming an influential statesman. The work in which he preached this made he printed himself at Steckelberg in 1519, entitling it *Ad Principes Germaniæ, ut Erent in Turcis inchant Exhortatoria*. In it he brands the court of Rome and the German nobility. These latter had been previously more severely attacked in his "Dialogue of the Last Enemy," in which Hutten boldly assumes a tone like that of modern republicanism. In 1519 he left the margrave to join

Franz von Sickingen in the Swabian league against his old enemy Ulrich of Würtemberg. Yet during this war he wrote the "Triad," a most vehement diatribe against Rome, and edited two books of Livy hitherto unpublished. The war over, he retired to the castle of Sickingen, whence he sent forth the bitterest attacks on Rome. He discovered in the library of Fulda a manifesto of Henry IV. against Gregory VII., and turned its German sentiment to such account that Leo X. demanded him as a prisoner. Driven from his castle, he took refuge in Ebernburg, and now began to write in German prose and verse; and these tracts are among his most daring productions. For a short time he fought in the army of Charles V. at the siege of Metz; and at this time Francis I. offered him the place of councillor at his court. Hutten next wandered to Switzerland, and Ecolampadius led him to Basel, where he hoped for support from Erasmus, who however turned against him, and even took pains to set the council of Zürich against him. Finally Zwingli obtained for him an asylum on the island of Ufnau in the lake of Zürich, where, worn out by war and suffering, he ended his short and tumultuous life. Among his works not mentioned above are *Dialogi*, *Fortuna*, *Fbris* (including the *Trias*, Mentz, 1520), and his poems (Frankfort, 1538). His collected works were published by Münch (6 vols., Berlin, 1821-'7). An *Index Bibliographicus Huttenianus* was published by Böcking at Leipsic in 1858, and a new edition of his works in 7 vols. in 1859. Many biographies of Hutten have been written; one of the best and most recent is that by Strauss (2 vols., Leipsic, 1857; 2d ed., 1871).

**HUTTON, Charles**, an English mathematician, born in Newcastle-on-Tyne, Aug. 14, 1737, died Jan. 27, 1823. At the age of 18 he became an usher in the village of Jesmond, and some years later the master of the school. In 1760 he removed to Newcastle, where he wrote his "Practical Treatise on Arithmetic and Book-Keeping" (1764). His "Treatise on Mensuration" (1771), and "Principles of Bridges, and the Mathematical Demonstration of the Laws of Arches" (1772), led to his being chosen in 1773 professor of mathematics in the military academy of Woolwich. He was elected fellow of the royal society in 1774, and was foreign secretary of that body from 1779 to 1783, when he resigned. He published a large number of papers in its "Transactions," and made all the mathematical calculations for Maskelyne's experiments for determining the mean density of the earth. About 1795 he undertook, aided by Drs. Pearson and Shaw, the labor of abridging the "Philosophical Transactions." The work was completed in 1809, Hutton receiving £6,000 for his share in it. Being compelled by bad health to resign his professorship at Woolwich, he received a retiring pension of £500. His principal works, in addition to those above mentioned, are: "Tables

of the Product and Powers of Numbers" (London, 1781); "Mathematical Tables" (1785); "Course of Mathematics" (3 vols., 1793); and "Mathematical and Philosophical Dictionary" (2 vols. 4to, 1795). He was also for many years editor of the "Ladies' Diary."

**HUTTON, James**, a British natural philosopher, born in Edinburgh, June 3, 1726, died March 26, 1797. He entered the university of Edinburgh in 1740, and began the study of law, which he subsequently abandoned for medicine, taking the degree of M. D. at Leyden in 1749. He engaged in the manufacture of sal ammoniac from coal soot, inherited from his father a small estate in Berwickshire, betook himself to agriculture, finally removed to his native city in 1768, devoting himself especially to the study of geology, and made several important discoveries. In 1795 he published the results of 30 years' study in his "Theory of the Earth," assuming that heat is the principal agent of nature.

**HUXLEY, Thomas Henry**, an English naturalist, born in Ealing, Middlesex, May 4, 1825. He spent two and a half years at Ealing school, in which his father was one of the masters, but with this exception his education was carried on chiefly at home. In 1842 he entered the medical school of Charing Cross hospital, and in 1845 received the degree of M. B. from the university of London, being placed second in the list of honors for anatomy and physiology. He began his literary career while yet a student by contributing to the "Medical Times and Gazette" a paper on that layer in the root sheath of hair which has since borne his name. In 1846 he joined the medical service of the royal navy, and was stationed at Haslar hospital, whence he was selected the same year to accompany Capt. Stanley, as assistant surgeon on the Rattlesnake, in his expedition to the South Pacific. After a four years' voyage of circumnavigation, during which surveys of the east coasts of Australia and Papua were made, the ship returned to England in November, 1850. While absent Mr. Huxley, who made extensive observations on the natural history of the seas traversed, sent home a number of communications, the first of which, read before the royal society in 1849, is "On the Anatomy and Affinities of the Family of the Medusæ." On his return some of these papers were elaborated by him and published in the "Philosophical Transactions" of the royal society, of which, in June, 1851, he was elected a fellow. In 1853 he resigned his position in the navy, and in the following year he succeeded Prof. Edward Forbes as professor of natural history in the royal school of mines, an office which he still holds (1874). He has since resided in London, where he has devoted himself to constant scientific labor and research. In addition to his annual course of lectures on general natural history, he has delivered many lectures on kindred subjects to mixed audiences, and has done much to popularize sci-

ence. He was Hunterian professor in the royal college of surgeons from 1863 to 1869, and was twice chosen Fullerian professor of physiology in the royal institution. In 1869 and 1870 he was president both of the geological and the ethnological society; in 1870 he was president of the British association for the advancement of science; and in 1872 he became secretary of the royal society. Since 1870 he has been a member of the royal commission on scientific instruction and the advancement of science. From 1870 to 1872 he served on the London school board, where he was chairman of the committee which drew up the scheme of education adopted in the board schools. During this time he took an active part in its deliberations, and became conspicuous by his opposition to denominational teaching, and particularly by his denunciation of the doctrines of the Roman Catholic church. In 1872 he was elected lord rector of the university of Aberdeen.—Prof. Huxley has done as much probably as any living investigator to advance the science of zoölogy, and the world is indebted to him for many important discoveries in each of the larger divisions of the animal kingdom. His earlier labors were devoted chiefly to the lower marine animals, with which he formed a most thorough empirical acquaintance during his Pacific voyage, and he has described many which previously had been either unknown or very imperfectly studied. During the past ten years he has devoted himself assiduously to the comparative anatomy and the classification of the vertebrata, and has embodied the results of his more important researches in numerous monographs. In his first published work, on the medusæ, he called attention to the fact that the body of these animals is formed of two cell layers, which may be compared to the two germinal layers of the higher animals; an idea which has since found its complete expression in the gastræa theory of Haeckel. To him also is due the vertebral theory of the skull, which has since been demonstrated so clearly by Gegenbaur; and he was the first to extend to man Darwin's theory of natural selection. In his three lectures on "Man's Place in Nature," delivered in 1863, he made an elaborate exposition of the doctrine of evolution as applied to man, asserting that the anatomical differences between man and the highest apes are of less value than those between the highest and the lowest apes. Among his many popular lectures, that "On the Physical Basis of Life," delivered in 1868, has attracted much attention. In it he advances the idea that there is some one kind of matter common to all living beings; that this matter, which he designates as protoplasm, depends on the preëxistence of certain compounds, carbonic acid, water, and ammonia, which when brought together under certain conditions give rise to it; that this protoplasm is the formal basis of all life, and therefore all living powers are cognate, and all living forms,

from the lowest plant or animalcule to the highest being, are fundamentally of one character. Prof. Huxley is a corresponding member of the principal foreign scientific societies, and has received honorary degrees from the universities of Breslau and Edinburgh. His works are as follows: "The Oceanic Hydrozoa" (1857); "Evidence as to Man's Place in Nature" (1863); "Lectures on the Elements of Comparative Anatomy" (1864); "Lessons in Elementary Physiology" (1866); "An Introduction to the Classification of Animals" (1869); "Lay Sermons, Addresses, and Reviews" (1870); and "Critiques and Addresses" (1873). He is the author also of a large number of papers published in the journals of the royal, the Linnæan, the geological, and the zoological societies, and in the memoirs of the geological survey of Great Britain.

**HUY**, a town of Belgium, in the province and 16 m. S. W. of the city of Liège, at the entrance of the Hoyoux into the Meuse; pop. in 1866, 11,055. It has a handsome Gothic church, a college, manufactories of paper, leather, and salience, distilleries, and an active trade. The former abbey of Neufmoutier contained the tomb of Peter the Hermit, by whom it had been founded; in 1858 a statue was erected in his honor in the garden of the abbey. In the neighborhood there are mines of iron, zinc, and coal, and several mineral springs.

**HUYGENS** (incorrectly HUYGHENS), **Christian**, a Dutch natural philosopher, born at the Hague, April 14, 1629, died there, July 8, 1695. He was the second son of Constantine Huygens, secretary and counsellor of the stadtholders Frederick Henry, William II., and William III. His father taught him the rudiments of education and the elements of mechanics. At the age of 15 he became the pupil of Stampioen, and at 16 he was sent to Leyden to study law with Vinnius, who dedicated to him his first commentary on the Institutes of Justinian. He there also pursued mathematical studies, and afterward at Breda in the university, which was under the direction of his father. In 1650, after a journey to Denmark with Henry, count of Nassau, he began those mathematical and physical researches which afterward made him famous. In 1651 he published at Leyden his first work, on the quadrature of the hyperbola, the ellipse, and the circle, and in 1654 a paper entitled *De Circuli Magnitudine inventa nova*. In 1655 Huygens went for the first time to France, and received the degree of doctor of laws from the faculty of the academy of Amers. On his return to Holland he turned his attention to the construction of telescopes, in connection with his elder brother Constantine. With one of these instruments, having a focal length of 10 ft., and more powerful than any ever before made, he discovered the first (now called the fourth) satellite of Saturn, and published the discovery at the Hague in 1656. During the next year he wrote a paper on the calculus of probabilities. Pascal and Fermat

had already written upon the subject, but the treatise of Huygens was more profound, and 50 years afterward James Bernoulli employed it as an introduction to his *Ars Conjectandi*. It was also translated into Latin by his former tutor Schooten under the title *De Ratiociniis in Ludo Aleæ*, by which it is also known in 's Gravesande's edition of Huygens's works. Schooten published it in his *Exercitationes Mathematicæ*, to demonstrate, as he says, the utility of algebra. About this time Huygens sent a paper to Wallis on the area of the cissoid, and to Pascal a calculation for hyperbolic conoids, and spheroids in general, and on the quadrature of a portion of a cycloid, in which papers he employed methods having the highest characteristics of original thought. But his attention was not wholly devoted to merely theoretical mathematics, for about this time he introduced one of the most practical and important of all inventions. Galileo had observed the isochronism of small vibrations of the pendulum, and had employed it as a measurer of time, but his method required an assistant to count the oscillations, and was of course far from being exact. To keep the pendulum in motion and cause it to register its successive vibrations was one of the problems which Huygens attempted, and which he succeeded in solving by the invention of the pendulum clock, a description of which, under the title of *Horologium*, he dedicated to the states general of Holland in 1658. (See **CLOCKS AND WATCHES**.) In 1659 he constructed a telescope of 22 ft. focal length, in which he used a combination of two eye pieces, and again examined Saturn, making the discovery of the ring of the planet. The singular appearance which it sometimes presents of being accompanied by two luminous bodies, one on either side, had been observed by Galileo, but his telescope had not sufficient power to permit him to discover its cause. Huygens's instrument enabled him to make out that the phenomenon in question, which at regular times appeared and disappeared, was produced by the oblique position of the ring with regard to the earth and to the sun. From an analysis of the phenomenon he predicted the disappearance of the ring in 1671, and the prediction was verified. He published an account of these observations at the Hague in 1659, in a volume also containing an account of several other discoveries, such as that of the great nebula in the sword of Orion, the bands upon the disks of Jupiter and Mars, and the fact that the fixed stars have no sensible magnitude. It was also accompanied by a description of a method for measuring the diameter of the planets. The micrometer used by him has been superseded by others, but it served the purpose of making correct measurements. In 1660 he visited France and England, and soon after published his celebrated theorems on the laws of the impact of bodies, in which most of the principles of the laws of motion are es-

published. In 1665, at the invitation of Colbert, he went to France and became a member of the academy of sciences, then recently formed. Apartments were assigned to him in the royal library, and he resided in Paris for the greater part of the next 15 years, during which time he presented many papers to the academy, some of which still remain unpublished in its archives. In 1670 he visited Holland to restore his health, which had become impaired by his great labors; and on his return to Paris in the following year he completed his great work *Horologium Oscillatorium* (fol., Paris, 1673). To this book are appended 13 theorems on centrifugal force, which will be noted further on. About this time he invented the spiral spring which is applied to the balance wheel of watches, a description of which was published in the journal of the academy of sciences in 1675. The invention was claimed by Hooke of England and Hautefeuille of France, but the evidence that it is the invention of Huygens is too strong to be any longer questioned. It is said that the first watch provided with a hair spring was made by Thuret under Huygens's direction, and was sent to England. In 1675 he again went to Holland for the benefit of his health, and in 1676 he read before the academy of sciences his famous treatise on light, and also a treatise on the cause of gravity, in which he attempts to account for the force by supposing that ethereal matter revolves about the earth with a velocity greater than that of the planet, and compares it to the force which causes bodies a little heavier than water, and lying lightly upon the smooth bottom of a cylindrical vessel containing water, to move toward the centre when the circular motion of the vessel by which its fluid contents have been caused to revolve is arrested. In 1681 he returned to his native country, and immediately began the construction of an automatic planetarium to represent the true motion of the bodies of the solar system. This invention led to the important discovery of continued fractions, which he found it necessary to employ in order to establish the relation between the number of teeth contained in two wheels which play into one another. After this he resumed for several years, in conjunction with his brother Constantine, the construction of telescopes. He made two objectives, one of 170 and another of 210 ft. focal length, which he presented to the royal society of London. As a telescope of such dimensions would be difficult to manage, Huygens proposed to dispense with the tube and place the object glass in an elevated position so that it could be adjusted to any angle, and then to place the eye piece at the focus. This arrangement continued to be used until the introduction of reflecting telescopes. While Huygens was absorbed in these occupations a great revolution was going on in the mathematical world. Leibnitz had invented the differential calculus, which he published in 1684, and

had proposed as a test to the followers of the old methods the problem of finding the curve of equable approach, or that which a suspended body must follow in order to approach or recede from equal heights in equal times. Huygens accomplished the solution by the old methods, but he was the only one who succeeded. Soon after this Newton published his *Principia*, and Huygens, with a desire of becoming acquainted with the author, visited England for the third time, and on his return published his treatise on light under the title *Traité de la lumière, où sont expliquées les causes de ce qui lui arrive dans la réflexion, dans la réfraction et particulièrement dans l'étrange réfraction du cristal d'Islande* (Leyden, 1690). Soon after this he investigated the properties of the catenary curve, a problem which had just been proposed by James Bernoulli, who had become proficient in the methods of the differential calculus; but Huygens solved the question by the old methods, which was considered a wonderful achievement. He nevertheless found the task so difficult that his opposition to the differential calculus was shaken, and he entered at once into correspondence with Leibnitz. He had previously, whenever meeting with difficulties, attributed them to himself and not to defects in the methods. After examining the differential calculus he admitted its superiority, immediately commenced its use, and soon gave a wider development to the invention than it had yet attained. At his death he left his manuscripts to the library of Leyden, intrusting their publication to two of his pupils, Volder and Fullen.—Huygens was never married, and aside from his scientific pursuits his life was not eventful. He had a fine personal appearance, and his character was eminently noble. Newton spoke of him as the *summus Hugenus*, and considered his style as an author more classic than that of any other mathematician of that time. He was affable and kind, and was easily accessible to young students, whom he was always delighted to assist in their investigations. His labors were immense, and the practical value of their results is inestimable. His discovery of the laws of the double refraction of light in Iceland spar, and of polarization, perhaps as much as any other cause, led to the reëxamination of the undulatory theory, and, with the necessary adaptations, to its employment to account for all the phenomena of radiation of both heat and light. In accordance with this theory the most important researches in modern physics have been made, as those upon the diathermanous properties of bodies, and upon the absorption of radiant heat by gases and vapors, by which great light has been thrown on the science of meteorology. Besides his invention of the pendulum clock and of the balance wheel to the watch, the first chronometers taken aboard ships were made under his direction, and he was far in advance of all others

of his day in astronomical observations. His discovery of the isochronism of the cycloid was one of the most important in mathematics; and not inferior to it is the invention of the involu- tion and evolution of curves, and the estab- lishment of the proposition that the cycloid is its own evolute. He also, in his *Horologium Oscillatorium*, gives a method for finding the centre of oscillation, which was the first suc- cessful solution of a dynamical problem in which connected material points are supposed to act on one another. The difficulty of this subject is shown by the fact that Newton fell into an error in regard to it in attempting to solve the problem of the precession of the equinoxes. The question of the centre of os- cillation had been proposed by Mersenne in 1646, and although some cases had been solved on the principle of the centre of percussion, it was beyond the reach of any methods then known. Huygens was only a boy of 17 when the question was proposed, and could then see no principle by which it could be solved; but when he published his *Horologium Oscillato- rium* in 1673, the principles which he assumed led to correct results in all cases. The two first theorems appended to that work state: 1, that if two equal bodies move in unequal circles in equal times, the centrifugal forces will be proportional to the diameters of the circles; and 2, that if the velocities are equal, the cen- trifugal forces will be in the inverse ratio of the diameters. To arrive at these conclusions required the application of the second law of motion (*i. e.*, that the motion which a force gives to a body is compounded with the motion which it previously had) to the limiting ele- ments of the curve, in the manner in which Newton afterward demonstrated the theorems of Huygens in his *Principia*. Huygens's own demonstrations of these theorems were found after his death among his papers. In his treatise on the impact of bodies (*De Motu Corporum ex Percussione*), Huygens must have assumed the third law of motion, which New- ton afterward expressed by saying that "action and reaction are equal and opposite," by which we understand that the quantity of motion in the impact of bodies remains unchanged, one of the first grand principles in the doctrine of the conservation of force. His works were edited by 's Gravesande under the titles of *Opera varia* (2 vols. 4to in 1, Leyden, 1724) and *Opera Reliqua* (2 vols. 4to, Amsterdam, 1728).

**HYACINTH**, a genus of *liliacea*, containing several species, the most important of which is *hyacinthus orientalis*, a native of the Levant. This has an onion-like bulb, which throws up long, narrow-channelled leaves, from among which arises a scape bearing a raceme of bell-shaped drooping flowers; the parts of the perianth are united to about the middle, and the free portions reflexed; flowers often very fragrant, appearing in early spring. This being one of the florists' flowers, great changes have been produced in it by cultivation; the size of

the flower cluster has been greatly increased, the flowers are semi-double and double, and there is a great variety of colors and tints, from pure white, through various shades of red and blue, to nearly black. The number of named varieties is very large, and includes not only self-colored ones, but double and single kinds, with flowers variously striped and shaded. The bulb growers near Haarlem in Hol- land supply the world with hyacinths, which form a large share of what are imported under the name of "Dutch bulbs." The eminence of the Dutch florists in the culture of this and other bulbs is in part due to a favorable soil and climate, and in part to the patient care given to their cultivation; these, with the low price of labor, have enabled them to hold a monopoly of bulb growing. Near Haarlem over 100 acres of land are annually devoted to hyacinths; the soil is a mixture of sand and alluvium, and permanently supplied with the requisite moisture. New varieties are obtained by sowing seed, and it is necessary to cultivate the seedlings for six years before their real

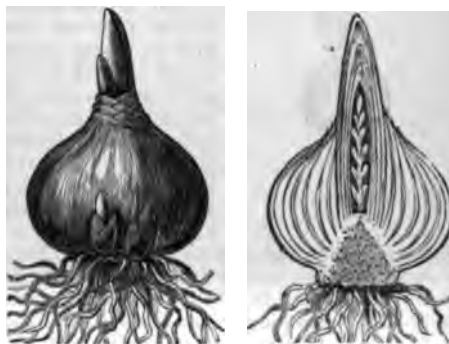

Hyacinth Bulb and Section.

merit can be decided upon. Established vari- eties are multiplied from the small bulbs which form at the base of the larger ones; a bulb will naturally produce several of these, and the cultivators increase the number by wounding and cutting the bulb in various ways. The small bulbs are carefully cultiva- ted until of a proper size for market; in or- der to increase its size as rapidly as possible, the bulb is not allowed to exhaust its strength in producing flowers, but the flower stem is cut away as soon as it appears. Millions of bulbs are annually imported into this country and England, and large quantities go to other countries. The best are imported by the deal- ers direct from the growers; it is only the poorer bulbs, from which the finer ones have been selected, that are usually offered at auc- tion. The different varieties are put up in bags of heavy paper, with an abundance of the hulls of buckwheat, and the bags are packed in cases. The heaviest bulbs, which show no signs of decay by being soft at the top, are

to be preferred. Named sorts cost much more than assorted kinds, which for the general cultivator may be quite as satisfactory as those



Hyacinth (*Hyacinthus orientalis*).

with names. The bulbs for outdoor culture are usually planted in October. A rich light soil is best, and well decomposed cow manure is the best fertilizer; the bulbs should be set 8 in. apart and covered to the depth of 4 in.; when cold weather comes on, the bed is to be covered with litter, which is to be left on until spring; when the plants come into flower each spike will need the support of a small stick or wire, which may be so placed as not to be noticed; when the flowers decay their stalks are cut away, and the bulbs allowed to remain until the fading of the leaves shows that they have finished their growth; they are then taken up, dried in the sun, each wrapped in a paper with its label, and kept in a cool dry place until time to plant in autumn. They do not bloom in subsequent years so well as the first. In some gardens the bulbs are left



English Bluebell.

from year to year; they increase and form large clumps, which produce small spikes of flowers. The hyacinth is an easy plant to force

in the greenhouse or in an ordinary room; the bulbs should be potted in October, and the pots placed in a cool dark cellar, or in a shady corner, and covered with coal ashes; when an inspection of the pots shows that the ball of earth is well filled with roots, they may be brought to a warm and light place, when growth of leaves and flowers will soon commence; frequent failure is due to not first securing a good growth of roots by keeping the bulb cool and from the light. The bulbs are often forced in glasses made for the purpose, filled with water; the base of the bulb should just touch the surface of the water, and the glass should be kept in the dark until the roots are well developed. Bulbs that have been forced are of little value; single varieties are preferred for forcing.—The wild hyacinth, the bluebell of England, *H. nonscriptus* of the older botanists, has been successively placed in several different genera, and is probably nearer a squill (*scilla*) than a hyacinth.

**HYACINTHE, Père.** See LOYSON, CHARLES.

**HYACINTHUS**, in Greek mythology, son of the Spartan king Amyclas and Diomede, or of Pierus and Clio, or of Œbalus and Eurotas. He was a boy of great beauty and the favorite of Apollo, but was also beloved by Zephyrus, who from jealousy caused his death as he was playing with Apollo, by blowing the quoit of the god against his head. From his blood sprang the flower hyacinth, upon whose leaves appears the Greek exclamation of woe AI, AI, or the letter  $\Upsilon$  beginning his name ( $\Upsilon\acute{\alpha}\kappa\iota\nu\theta\omicron\varsigma$ ).

**HYADES**, in Greek mythology, nymphs variously described as being from two to seven in number, and bearing 18 names. According to some authorities, Jupiter placed them among the stars in honor of their care of the infant Bacchus; while others say it was to reward them for their long mourning for their brother Hyas, who had been killed by a wild boar.

**HYÆNA**, a digitigrade carnivorous mammal, most numerous in Africa, but found also in southern and middle Asia, where the genus has probably spread while following the track of armies and caravans. Zoölogists are not agreed as to the position of this animal; the older authors place it in the feline family, with which it agrees in the single true molar on each side of both jaws, and in the single tuberculate tooth on each side of the upper jaw only; Waterhouse regarded it as a small divergent group of *vicerrina* or civet cats; Linnæus ranked it in his genus *canis*; and Hamilton Smith puts it in juxtaposition to the dogs. It seems to be an osculant type, united on the one hand to the dogs by the genus *lycaon*, and on the other to the civets by the genus *proteles* (aard-wolf); its general aspect is decidedly canine, as also are most of its habits. The dental formula, according to Owen, is: incisors  $\frac{3}{1}$ , canines  $\frac{1}{1}$ , preincisors  $\frac{4}{4}$ , and molars  $\frac{1}{1}$ —34 in all. The disposition of the hyæna is fierce and cowardly, and its habits are revolting; it is able to withstand any temperatures and priva-

tions, revels in the foulest air, and gorges on the filthiest substances when living prey fails; of powerful form, thick skin, and strong jaws and teeth, the bands of hyænas fear not the lion and tiger, and will attack even man in the night time. Its appearance is very repulsive; the head is large and truncated, the neck short and stout, the body thick and short, high at the shoulders and declining rapidly toward the tail, a long stiff mane from the nape to the rump, and a short tail; the gait is clumsy, the voice harsh and frightful, the expression of the face malignant, and its body offensive from its carrion food and the strong odor of its anal pouch. The feet are all four-toed, with strong non-retractile claws fitted for digging, the dorsals and the pairs of ribs 15 or 16, and the lumbar vertebræ 4 or 5; the tibia and fibula are much shorter than the radius and ulna; the tongue is covered with horny papillæ, the irides elliptical above and circular below, the erect ears long and pointed, and mammæ four. The prevailing color is an ochrey gray, with dark stripes or spots. The hyæna is among mammals what the vulture is among birds, the scavenger of the wilderness, the woods, and the shore, and useful in this way in disposing of carcases which otherwise would pollute the air; often it attacks cattle and disabled animals, prowls in the rear of the larger carnivora, whose leavings it devours, and digs up when possible the dead bodies of man and beast; from this last undisputed habit, the hyæna has been regarded as a horrible and mysterious creature, and is the subject of many superstitious fears and beliefs among the Semitic races. Its teeth are so powerful that they can crack the bones of an ox with ease, and their grip is tenacious to the last degree; were its speed great and its courage equal to its strength, it would be among the most dangerous of the carnivora; it sometimes burrows in the earth or hides in caverns, but generally

Spotted Hyæna (*Hyæna crocuta*).

passes the day in the desert, insensible to the scorching sun. The spotted hyæna (*H. crocuta*, Erx.) is the most dog-like of the genus; it is about 4½ ft. long from nose to base of tail, the latter measuring about 13 in. and the head about 12; the height at the shoulders is 2½

ft.; the general color is a dingy whitish gray, with small round brown spots, the muzzle as far as the eyes and lower limbs sooty, and the tail dark; the mane is rather short. It is found in South Africa, and on the coasts of Senegal and Guinea, and with the next spe-

Striped Hyæna (*Hyæna striata*).

cies is generally called wolf by the Dutch colonists. It is fierce but cowardly, and will sometimes approach camps and make severe gashes on the limbs and faces of persons asleep; it is said sometimes to drag off children, which from its strength it could easily do; from the resemblance of its voice to a human laugh, it has received the name of the laughing hyæna; it rarely burrows, but occupies the retreats of other animals, prowling about at night. The striped hyæna (*H. vulgaris*, Desm., or *H. striata*, Zimm.), a rather larger animal, is found in Africa, Asia Minor, Arabia, and Persia; the head is wider, the muzzle fuller, and the eyes further from the nose, than in the preceding species; the hair is coarse and thick, of a dirty gray color, with transverse dark stripes on the sides and limbs; there is a stiff mane along the back; the habits are the same as those of the spotted hyæna. There are some varieties of smaller size, and one with a skin almost naked, in the Nubian deserts. The brown hyæna, or strand wolf of the Dutch colonists (*H. brunnea*, Thunb.), is only 4 ft. long to the end of the tail, and a little over 2 ft. high at the shoulders; the hair is long and shaggy, of a dirty yellow color, with tawny tints on the back and irregular stripes on the sides; it is less in size than the other species, and less destructive to cattle. The hyænas act very much the part of the wolf of northern climates, being equally fierce, cowardly except at night and when in packs, and annoying to the herdsman by their destruction of sheep and oxen.—There are in Africa certain dog-like animals, the *wilde honden* of the Dutch, constituting the genus *lycaon* (Brooks), which seem to connect the dogs with the hyænas, and which are believed by Hamilton Smith to be partly the pro-



genitors of the mastiff races. The head is short and truncated, the mouth broad, the teeth strong and dog-like; the ears erect and large; neck long, body short, the limbs slender and highest before; tail short, hanging down, and inflexible; four toes on all the feet; pupils round; mammae eight or ten. They hunt in packs, being swift, active, hardy, with excellent scent and acute sight; they do not burrow. They are found in Africa south of the great desert, and in Arabia, and as far as the Indus in Asia. The hunting hyæna (*Lycæon venaticus*, Burch.) of the Cape is about as tall as a large greyhound, with long legs; the color is ochrey, white on the breast, with spots of the same edged with black on the neck, shoulders, loins, and croup, with wavy black streaks on the sides; the muzzle and cheeks black, the color passing up on the nape and down on the throat. It hunts in packs both by day and night, frequently destroying sheep, and sometimes surprising cattle, biting off their tails; it



Hunting Hyæna (*Lycæon venaticus*).

is considered untamable. The painted hyæna (*L. pictus*, Temm.) is by many thought to be a mere variety of the last; it is about 3 ft. long, the tail 1 ft. more, and 1½ ft. high at the shoulders; the colors are much the same as in the preceding animal; it hunts also in packs, surprising antelopes, and attacking when hard pressed for food cattle and even man; Rüppell says it looks much less like a hyæna and more like a dog than the *L. venaticus*.—In anterior geological epochs the hyænas were not confined to tropical Africa and Asia, nor to the old world. They appeared in Europe toward the end of the tertiary age, but were most numerous during the diluvial period, and were found in England, Belgium, and Germany; there were about half a dozen species, numerous in individuals, and of a size sometimes superior to the living animal. In the Kirkdale and other caverns of Europe three species are found, of which the best known is the *H. spelæa* (Goldf.). In Asia they were numerous in the Himalaya

region, of which the most remarkable is the *H. Siculensis* (Cautl. and Falc.). In the caverns of Brazil Lund has found abundant remains of a hyæna which he calls *H. neogæa*, mixed with the bones of rodents, peccaries, megalonyx, and other American types, seeming to show that the geographical distribution of animals in the modern faunæ is in no way connected with their ancient distribution. The bones of the caverns bear unmistakable marks of the teeth of hyænas, even if the remains of the latter did not prove their existence; and this animal seems to have been the principal consumer of the great proboscideans and ruminants of the diluvial age.

**HYBLA**, the name of several cities of ancient Sicily, the most considerable of which were the following. I. *Hybla Major*, or *Magna*, situated on the southern declivity of Mt. Etna, near the river Symæthus. It was founded by the Siculi, and was one of those which Ducætius, a chief of that people, sought to unite into a confederacy against the Greeks and Carthaginians. In the time of Cicero Hybla Major was an opulent *municipium*, but in that of Pausanias it was a poor decayed place. Its site was probably at Paterno, where an altar has been discovered dedicated to *Venus Victrix Hyblensis*. II. *Hybla Minor*, which stood so near Megara on the E. coast, N. of Syracuse, that the two cities were often confounded, was likewise of Siculic origin. It was chiefly celebrated for the honey produced in its vicinity.

**HYBRID** (Gr. ἕβρις), an animal or plant produced by the sexual union of individuals belonging to two different species. As a rule, in nature sexual union takes place only between individuals of the same species, and the offspring accordingly presents the specific characters common to both its parents. It is in this way that the species is indefinitely maintained, with its distinctive characters, by the constant production of new individuals similar in appearance to the old and endowed with similar powers of reproduction. But union between a male and a female of different species, when fertile, produces an offspring which does not precisely resemble either of its parents, but presents a mixture in nearly equal proportions of their separate characters. Thus a mule, which is the most commonly known example of a hybrid, is neither a horse nor an ass, but something intermediate between the two, and is without the complete distinctive marks of any recognized animal species. One of the most important questions relating to hybridity is that of the possible fertility of sexual union between different species, and that of hybrids of the same or different kinds between themselves. In nature, the occurrence of hybridity is extremely rare. This may be due to the more or less complete inaptitude of the male and female generative products to unite with each other in such a way as to produce a fertile result. Thus the germ and pollen of different flowers, or the

ovum and spermatic fluid of different animals, may be incapable of fertilization, owing to peculiarities of their own internal constitution; and consequently their physical contact would produce no result. But there are other reasons upon which the non-occurrence of hybrids in nature may partly depend. Among animals there is an instinctive preference for sexual union with their own species rather than with others, and a similarity of habits, of locality, and general disposition, corroborates this preference, and alone makes it much more likely that sexual union, as a matter of fact, will take place between animals of the same species. A certain degree of similarity in the physical structure of the parents is essential to the fertility of their sexual union. Thus all the most frequent and most useful forms of hybridity occur between different species belonging to the same genus. The horse, for example, will breed with the ass, the zebra, and the quagga; the dog has been certainly known to breed with the wolf, and probably with the fox; the goat with the sheep, the ram with the roe; and it has been comparatively easy to obtain hybrids from the union of the rabbit and the hare. But a cross union is not necessarily fertile, even between species of the same genus; between those of different genera it is still more exceptional; and it is doubtful whether hybridity, either natural or artificial, has ever occurred beyond these limits. The second question of interest relating to hybridity is that of the fertility of hybrids among themselves. As a rule it may be said that hybrids are not fertile. Thus the mule does not reproduce itself, but is only obtained by a repetition of the union of the ass and the mare. The female mule will sometimes reproduce by union with either the horse or the ass; but in this case the offspring is no longer a mule, but reverts to the type of the original stock in precise proportion to the admixture of blood resulting from the union. Notwithstanding, therefore, that the mule and its mode of production have been known from time immemorial, and notwithstanding the recognized usefulness of its qualities in some respects, we have never been able to obtain an independent and self-reproductive breed of mules; that is, the hybrid has never acquired the physiological characters of a natural species. —The terms hybrid and hybridization are often vaguely used as applied to plants, and many are called hybrids which are only crosses between varieties. The name hybrid should be restricted to plants resulting from the seeds of one species fertilized by the pollen of another species; those forms produced by cross breeding between varieties of the same species should never be called hybrids, but crosses. It is to be regretted that horticulturists generally ignore this distinction and use the terms hybrid and cross as synonymous. Hybrid plants sometimes occur in nature, and are frequently produced artificially. In hybridizing, it is neces-

sary to prevent the flower used as the mother, or seed-bearer, from being fertilized by its own pollen both before and after the artificial application of the strange pollen; the operator is favored by the fact that pollen retains its vitality for some time after it is removed from the flower which produced it. It is probable that with this, as with seeds, the duration of vitality varies in different species; at all events, it is known that some pollen will keep for weeks and even months. The flower selected as the seed-bearer is taken just as it is about to open and before any insects can have visited it; the envelopes are carefully opened or removed, and if a perfect flower its still unopened stamens are cut away with a delicate pair of scissors, the foreign pollen applied to the stigma with a small brush, and the flower or flowers enclosed in a bag of gauze to prevent the access of insects, which would probably bring pollen of the same kind to interfere with the action of the strange pollen. This is a brief outline of the process; there are details which can be learned by practice. It is not possible to know beforehand whether two species will hybridize; two species of a genus that seem to be the most nearly related will sometimes refuse to be hybridized, while other two that seem most unlike will readily form a union. It makes a difference also which plant is chosen as the seed-bearer and which as the pollen-bearer; for instance, the pistil of A will refuse to be fertilized by the pollen of B, while the pistil of B will readily accept the pollen of A. Seeds from the flowers thus fertilized may produce plants quite intermediate between the two parents, or may more strongly resemble the one or the other. Sometimes a hybrid will have the leaves of one parent and the flowers and fruit of the other. By this means horticulturists have produced useful varieties of fruit, notably in grapes and strawberries, and some of the finest flowers are the result of hybridizing. Among hardy flowers, the rhododendrons and azaleas are striking examples of the improvement that may be effected in this manner; the fine rhododendrons are hybrids between the hardy *R. Catawbiense* of the southern Alleghanies and *R. Ponticum*, a greenhouse species from Asia Minor. It is a singular fact that the English hybrids, in which *R. Catawbiense* is the mother plant, are generally hardy, while the Belgian hybrids are very much less hardy for the reason that the Belgian florists use *R. Ponticum* as the seed-bearer. When a desirable form is obtained by hybridizing, it can be continued and multiplied indefinitely by means of layers, cuttings, or grafts. Hybrid plants are sometimes fertile; the progeny from them shows a tendency to revert to the one or the other parent, and in a few generations all trace of the admixture is obliterated; sometimes the progeny is too weak to bear seeds, and thus becomes extinct. More generally hybrid plants are wholly or partly sterile; the degeneration shows itself most prominently in the anthers, which fail to pro-

duce pollen; the pistil in this case will be fertilized, if at all, by pollen from either parent, and thus a reversion of its progeny to a normal form assured; sometimes the pistils are abortive also. It will be seen that while hybrids may be produced among plants in a wild state, and are often produced in cultivation, there is abundant provision against the perpetuation of a race of monsters.—Another kind of hybrid in which fertilization plays no part has recently received the attention of vegetable physiologists. There are a number of well authenticated cases in which a graft or bud has so influenced the stock in which it was inserted that the stock, even below the point of union, put out branches partaking of the characters of both stock and scion. Some of these graft hybrids, as they are called, have been propagated. An account of this kind of hybrids, as well as a very full résumé of the whole subject of hybrids, will be found in Darwin's "Variation of Animals and Plants under Domestication." See also his "Origin of Species," and E. A. Carrière's *Production et fixation des variétés dans les végétaux* (Paris, 1865).

**HYDASPES**, a river of ancient India. See **JYLUM**, and **PUNJAB**.

**HYDATIDS**. See **ENTOZOA**, vol. vi., p. 666.

**HYDE**. I. An E. county of North Carolina, bordering on Pamlico sound, and bounded W. by Pango river; area, about 650 sq. m.; pop. in 1870, 6,445, of whom 2,378 were colored. It has a level surface, a large part of which is occupied by pine, cypress, and cedar swamps. The products of the pine are the staples of export. The chief productions in 1870 were 21,319 bushels of wheat, 163,216 of Indian corn, 11,633 of oats, 235 bales of cotton, and 171,548 lbs. of rice. There were 378 horses, 681 milch cows, 1,484 other cattle, and 3,706 swine. Capital, Swan Quarter. II. A S. E. county of Dakota, recently formed, and not included in the census of 1870; area, about 1,000 sq. m. Its S. W. corner touches the Missouri river.

**HYDE, Edward**. See **CLARENDON**.

**HYDE, Thomas**, an English orientalist, born at Billingsley, Shropshire, June 29, 1636, died in Oxford, Jan. 18, 1703. He studied at Cambridge and Oxford, took orders, became librarian of the Bodleian library, succeeded Pococke in 1691 as Laudian professor of Arabic, and soon after was appointed regius professor of Hebrew. In 1678 he was made archdeacon of Gloucester. He understood Hebrew, Syriac, Arabic, Persian, Armenian, Malay, and Chinese, and was interpreter of oriental languages to the court during the reigns of Charles II., James II., and William III. The most important of his works is *Veterum Perarum et Medorum Religionis Historia* (Oxford, 1700; best ed., 1760). A complete edition of his other writings appeared at Oxford in 1767.

**HYDE DE NEUVILLE, Jean Guillaume**, baron, a French politician of Scottish descent, born at La Charité-sur-Loire, Jan. 24, 1776, died in Paris, May 28, 1857. He was one of the most

active agents of the Bourbons after the death of Louis XVI., and mingled in nearly all the intrigues for the subversion of the revolutionary governments. After the 18th Brumaire, in an interview with Bonaparte, he tried to persuade him to restore the Bourbons. He was charged by Fouché with being an accomplice in the infernal machine plot, but cleared himself from the accusation. He subsequently removed to the United States, settled in the vicinity of New York, became acquainted there with Gen. Moreau, then an exile, and is said to have been instrumental in persuading him to return to Europe. Early in 1814 he returned to France, and was welcomed by the Bourbons, who had just been reinstated on the throne. He was engaged in all the negotiations and transactions which took place during 1814 and 1815, and on the second restoration was elected by his native department a deputy to the *chambre introuvable*, where he was an uncompromising advocate of the most reactionary measures. In 1816 he was appointed minister plenipotentiary to the United States, and held that office till 1821, when, after being created a baron, he was recalled to France. Being ambassador at Lisbon in 1824, he coöperated in restoring to power the old king John VI., whom his son Dom Miguel had imprisoned. Thenceforth he gradually estranged himself from the ultra-royalist party. In 1828 he entered the Martignac cabinet as minister of the navy, made several improvements in the colonial system, enforced measures against the African slave trade, and favored the independence of Greece. On the breaking out of the revolution of 1830, he asserted the claims of the duke of Bordeaux to the throne, in the chamber of deputies, and resigned his seat on Louis Philippe being selected. From that period he devoted himself mainly to agriculture.

**HYDERABAD**. I. A native state of the Deccan, India, called also the Nizam's Dominions, lying between lat. 15° and 21° 30' N., and lon. 74° 40' and 81° 30' E., bounded N. by Berar, N. E. by the Central Provinces, N. W. and W. by the presidency of Bombay, and S. and S. E. by that of Madras; area, 95,337 sq. m.; pop. about 11,000,000. The surface consists chiefly of a high table land 1,800 to 2,000 ft. above the sea, several granite masses rising to an elevation of 2,500 ft. The geological formation of this region is simple. Resting on a base of granite, gneiss, and talc slate are clay, hornblende, feldspar, limestone, and sandstone; and in some parts columnar basalt is conspicuous. The principal rivers are the Godavery, flowing through the middle of the country, the Kistnah, which winds along its southern limits, and the Wurda and Paingunga in the north, all flowing in an easterly direction. The minerals comprise iron (the iron ore in the Nirmal hills being magnetic) and coal, which is found near the junction of the Godavery and Wurda. Near the Godavery are also mines of garnet, and at Partheal near Condapilly are diamond

mines, from which the treasury of Golconda was formerly supplied. The soil of the country is fertile, but not well cultivated. There is a considerable area of waste and forest lands. Wheat and cotton are the principal agricultural products; other productions are barley, rice, oil plants, cucumbers, gourda, hemp, sugar cane, tobacco, sweet potatoes, aromatic seeds, jowary (Indian millet), and bajree, a species of grain which forms the chief sustenance of the laboring classes. The principal manufactures are silks, brocades, and carpets, and in the southeast calico printing by means of wooden blocks is carried on to some extent. The chief exports are steel, cotton, and teak. The climate, owing to the elevated position of the country, is colder than is usual in this latitude. The territory is crossed by several good military roads, and the Great Indian Peninsula railway traverses the eastern and southern parts of the country. Branch lines are projected from this main line to the city of Hy-

derabad, and from Hyderabad to Masulipatam on the Madras coast. The government is Mohammedan, but nearly nine tenths of the people are Hindoos.—Hyderabad was anciently subject to the rajahs of Telingana and Bijanagar. It was erected into a separate kingdom in 1512 by a Turkish adventurer, and in 1687 became a province of the Mogul empire. Azof Jah, an officer of the court of Delhi, who in 1719 governed this and the five other provinces of the Deccan with the title of Nizam ul-Mulk ("regulator of the state"), made himself

independent. On his death in 1748 the succession was disputed by his son Nazir Jung, whose cause was espoused by the English, and his grandson Mirzapha Jung, who was favored by the French. The latter finally triumphed, and governed under the direction of the French commander Dupleix until he was put to death by some Patan chiefs. During a period of anarchy which followed, the French and English supported rival claimants for the sovereignty. Nizam Ali, who came to the throne in 1761, ravaged the Carnatic, but was overpowered by a British force, and induced to sign a treaty in 1766 which gave to the East India company the Northern Circars. The English bound themselves to maintain a military force for the nizam's protection. In the war between the British and Hyder Ali, however, the nizam sided with the sultan of Mysore, but in that with Tippoo Saib he formed

an alliance with the company and the peishwa, and received a share of the spoils of victory. The accession of territory which he then obtained he subsequently ceded to the British in lieu of payment for the support of the British contingent. On the conclusion of the first Mahratta war in 1804 his dominions were again enlarged. The misgovernment of the country under the successors of Nizam Ali plunged Hyderabad deeply in debt. The East India company was at one time creditor to the amount of £500,000 or £600,000, and in liquidation they accepted a cession of the province of Berar, part of the revenues of which were to be devoted to the support of the subsidiary native force known as the nizam's contingent. The nizam remained true to the British during the mutiny of 1857-'8, and his dominions were little disturbed except by marauders. II. A town, capital of the Nizam's Dominions, situated on the river Mussi, about 800 m. N. N. W. of Madras; pop. variously estimated at



British Residency in Hyderabad.

80,000, 120,000, and 200,000, a large majority of whom are Mohammedans. It is a weakly fortified town, crowded with buildings, some of which are large and imposing, having numerous mosques, and surrounded by gardens of remarkable beauty. The British residency is a magnificent edifice on the opposite side of the river, connected with the town by a stone bridge. In the neighborhood there are large water tanks, one of which is 20 m. in circuit. A large British garrison is maintained at Hyderabad, and there is an extensive military cantonment at Secunderabad, a few miles N. E. of the town. The celebrated city of Golconda is 7 m. distant to the northwest.

**HYDER ALI**, sultan of Mysore, born in Dinavelli, Mysore, about 1718, died Dec. 7, 1782. He was of Arabian descent, and son of a petty chief. Entering the service of the rajah of Mysore in 1749, he rose in the course of ten years to be

commander of the forces, and, having thus the power in his own hands, set aside the rajah with a pension of three lacs of rupees, and took possession of the sovereignty. The East India company, becoming alarmed at his increasing power, formed an alliance with the Mahrattas and the nizam of the Deccan against him; but Hyder not only gained over the nizam to his side, but for two years waged vehement war on the British. By a series of skilful manœuvres he managed to draw their force to a distance from Madras, and then at the head of 6,000 horsemen rode 120 m. in three days and appeared before the city. The outlying country being at his mercy, the government of the presidency was compelled to come to terms, and Hyder agreed to a treaty of which the principal feature was that the British should form an alliance with him in his defensive wars. In 1770, the Mahrattas having invaded his dominions, he applied to the British for their promised aid, but could obtain from them nothing more than neutrality. By the year 1778 he had recovered from the disadvantages their defection had caused him. Being once more threatened by the same warlike people, he again invited British assistance, but with a like result. Incensed by this conduct, he formed an alliance with the Mahrattas and the nizam, and in 1780 invaded the British territory of the Carnatic, which he ravaged with fire and sword, capturing many of the strong places, but avoiding battle in the open field. The desolation he brought on the country during the two years' war was such that the British force, and even the city of Madras, were in danger from famine. This war elicited a remarkable display of military talent by the British general Sir Eyre Coote on the one side, and by Hyder and the French officers, of whom he had many in his service, on the other. The Mysore leader had already rejected terms of adjustment offered by Lord Macartney, the governor of Madras, when he died, and was succeeded by his son Tippoo Saib.

**HYDRA.** See HERCULES.

**HYDRA.** I. An island in the Grecian archipelago, off the E. coast of the Morea, belonging to the nomarchy of Argolis and Corinth; greatest length N. E. to S. W. about 12 m., greatest breadth 3 m.; pop. about 20,000. Its surface is rocky, sterile, and mountainous. The inhabitants are esteemed the best sailors of Greece. II. A town, capital of the island, situated on a barren rugged height on the N. W. shore; pop. in 1870, 7,428. The streets are steep and uneven, and the houses substantially built. The manufactures are silk and cotton stuffs, soap, and leather. The harbor is formed by a deep bay, but is neither spacious nor well sheltered. During the war of the revolution Hydra was a place of general refuge for people from all parts of Greece.

**HYDRABAD,** a town of British India, in the province of Sinde, situated on an eminence belonging to the Gunjah hills, 4 m. E. of the

E. bank of the Indus; pop. about 20,000. It is built on an island 15 m. long, is formed by the Indus and an offset stream called the Fulailee. It is defended by a fortress of imposing appearance but no strength, and has manufactures of metal swords, spears, and shields, and of ornate silks and cottons. The town is connected with Kurrachee on the Arabian sea by a road 120 m. long. Hyderabad was formerly the residence of the chief amirs of Sinde, who governed the southern and principal part of the country. A victory was gained over a British force near here by Sir C. Napier, Feb. 24.

**HYDRANGEA** (Gr. *ὕδωρ*, water, and *αἶμα*, vase), a genus of shrubby plants, to which the name was applied for no obvious reason, long to the natural order *saxifragaceae*, natives of Asia and of North America. The most common species known (*H. Hortensia*), the common hydrangea, was introduced into Europe from China in the year 1790 by Sir J.



Garden Hydrangea (*H. Hortensia*).

Banks. Commerson, wishing to honor his friend Mme. Hortense Lapeaute, called the plant *Lapeautia*; but thinking the name not sufficiently pointed, he changed it to *Hortensia*, by which it is still known in France; when it was found to belong to the old genus *hydrangea*, Commerson's name was retained for the species; it is now incorrectly written *hortensia*. It is a small, dwarf, vigorous shrub, with opposite, cleft-toothed, oval leaves, and bears immense clusters of sterile flowers, which are pink, or blue, according to the nature of the soil. Cuttings of the wood or of the stems will root without difficulty. The plant delights in an unlimited supply of water, fading at once on its being withheld. There is a variety with variegated foliage, nearly very white, which is fine in the greenhouse, but does not endure our hot sun. Specimens mentioned in England of 30 ft. circumf.

producing on a single clump more than heads or corymbs of flowers. In the States, even so far north as Boston, it lives the winter if slightly protected by mats being covered. The wild hydrangea (*H. arborescens*, Linn.) is a shrub 4 to 6



Oak-leaved Hydrangea (*H. quercifolia*).

; its flowers, which are borne on flat heads or corymbs, are usually all white or yellowish, and sometimes all purple, and sometimes with a row of sterile flowers around the margin; the species ranges from Pennsylvania southward. The oak-leaved hydrangea (*H. quercifolia*) was first discovered in Georgia; it was carried to England in 1803, and is the finest North American shrub. It has deeply lobed, oak-like leaves, and large corymbs of nearly white flowers, which hang afterward to purple. In the garden of the north is often seen the snowy-leaved hydrangea (*H. nivea*, Mx.), a shrub from 6 to 10 ft. high, with large leaves of a silvery white beneath, and flowers in terminal cymes, with a few showy, white, sterile florets and many small, green, fertile ones; it grows in the upper part of Georgia and the Carolinas. Within a few years several fine hydrangeas have been introduced from Japan, some of which, though they have received specific names, are varieties of *H. Hortensia*, while others are distinct; preëminent among these is *H. nivalis grandiflora* (sometimes called *H. nivalis*), which is one of the finest hardy shrubs in cultivation; it produces an oblong cyme, often a foot long, of sterile flowers, which are at first white, then gradually turn red by the time frost comes they are

white. See Ptarmica.

**WATER** (Gr. *idwup*, water), compounds containing water, or its elements in the proportion of 1 part of water to 1 part of lime (oxide of calcium). Thus lime (oxide of calcium) with water forms a chemical combination of a portion of this, and falls to a white

powder, which is a hydrate of lime. Hydrate of potassa is a combination of potassa and water, and is permanent even when exposed to high temperature. Common oil of vitriol is also a chemical combination of water and sulphuric anhydride.

**HYDRAULIC RAM**, a machine for raising water by employing its own momentum, acquired by a fall, a portion of the water only being raised. The accompanying diagram, fig. 1, will serve to explain its action. An impulse pipe, H, leads from a cistern or reservoir, C, and has a fall depending on the amount of impulse required, and corresponding with the other parts of the machine, and on the height the water is required to be raised. The lower end of this impulse pipe turns up at A, where there is a large valve, usually conical and opening downward. This valve is of such a weight that the simple pressure of the water in the cistern and pipe, or the head, will not raise it, a certain degree of momentum being required for that purpose. When the valve is open the water rushes through it and soon attains this required momentum, and the valve rises and shuts against its seat. The motion of the water in the end at A is arrested, but not entirely so in that portion of the pipe between H and the cistern, for the impulse opens the valve B and forces water into the bell-shaped chamber D, and eventually into the delivery pipe E. When the impulse of the water flowing through the valve B becomes less than the pressure upon it, the valve closes and prevents the water which has passed through from returning. The time of this flow is very short, because the arrest of motion of the water in the end of the impulse pipe so reduces the force exerted against the impulse valve that it falls after a brief interval, when the water again rushes out and relieves the pressure at B. But it soon acquires sufficient momentum to again raise the impulse valve, when the shock is repeated, and the acquired momentum again expends itself principally against the valve B, and the

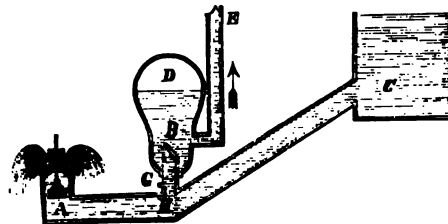

FIG. 1.—Hydraulic Ram.

water ascends into the air chamber and delivery pipe. The use of the air chamber is obviously to produce a constant pressure in the pipe E, as nearly as practicable, and to relieve it from the sudden shock which would otherwise be caused by the shutting of the valve B.

The expenditure of force in this machine is obtained by multiplying the amount of water discharged at A into the head, or height of water in the cistern above the valve A. The economy of force is found by multiplying the amount of water delivered by the pipe E into the height to which it is raised. The proportion in good rams is from 60 to 70 per cent. The head of water should be from 4 to 6 ft. for raising water vertically 30 ft. There is a difference of opinion in regard to the proportional increase of head to increase in height of the delivery pipe, and machines of different modes of construction will require variation in this particular. The height of head is, however, practically restricted in consequence of the wear and strain produced by the shock when the head is great. A practical difficulty in the machine is to preserve the necessary quantity of air in the air chamber. This is constantly being absorbed by the water, so that in time its volume becomes too small to yield sufficient elasticity. The difficulty is obviated to a great degree by the application of what is called a shifting valve, opening inward at G. There is a moment of time after the shutting of the impulse valve when there is in certain parts of the machine a diminution of internal pressure to a degree below that of the pressure of the atmosphere. During this moment a bubble of air will enter at G and ascend into the air chamber, but it is difficult so to regulate the supply that it will not be necessary to remove the air chamber and introduce a fresh supply of air. In large European machines there is often placed at B an inner air chamber with two valves at its base, suspended by hinges and opening laterally. The impulse pipe may be straight, and inclined as shown in the figure, or have a vertical and a horizontal limb; or it may be curved. There are several practical points in regard to its size and length which should be observed in the erection of the ram. In general, it may be stated that if the impulse pipe is very wide and short, it will not maintain a sufficient impulse to lift the water against great pressure in a long delivery

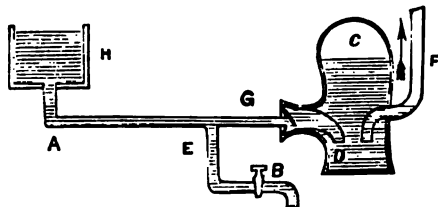

FIG. 2.—Whitehurst's Machine.

pipe, because of the tendency to a reactionary movement of its contents, which is prevented by the resistance offered by a longer and smaller pipe. The invention of the hydraulic ram is ascribed to the elder Montgolfier, and its improvements to his son. The principle,

however, was previously employed by Joseph Whitehurst of Cheapside in a machine constructed by him in 1772, an account of which was published in the "Philosophical Transactions" in 1775. Fig. 2 is a representation of Whitehurst's machine, and it will be seen that the principal difference between it and Montgolfier's ram is that it has a stopcock in place of the automatic impulse valve. Leading from the cistern H is a long pipe, A E, much longer in proportion than is represented in the figure which is the impulse pipe. Its contents receive momentum from the opening of the valve B, which is several feet below E. When a sufficient force has been obtained the cock is shut and the column of water in A B is urged by momentum along the direct branch of the pipe G, through its depressed extremity D, into the bottom of the air chamber C. This part of the pipe contains a valve opening toward the air chamber, corresponding to the one in Montgolfier's machine. F is the lower section of the delivery pipe. The principle of action is precisely the same in the two machines, and the explanation of the ram will answer that of Whitehurst's machine.

**HYDRAULICS.** See HYDROMECHANICS.

**HYDROCEPHALUS.** See BRAIN, DISEASES OF THE, vol. iii., p. 197.

**HYDROCHLORIC ACID,** or *Chlorohydric Acid* a gaseous compound of one equivalent of chlorine and one of hydrogen (HCl), of combination proportion 36.5, long known in its aqueous solution by the names of muriatic acid, marine salt, and spirit of salt, in reference to being prepared from sea salt (*maria*). Priestley first obtained it as a gas in 1772, and G. Lussac, Thénard, and Davy long afterwards showed that it consists of equal volumes chlorine and hydrogen, and occupies the same space as the gases which produce it. Its elements mixed together slowly combine by the action of the light, but instantly with explosion if exposed to the direct rays of the sun or if an electric spark is passed through the mixture, or a lighted taper is brought in contact with it. The gas is obtained by adding concentrated sulphuric acid to common salt placed in a retort, and collecting over mercury. The chlorine of the salt (chloride of sodium) unites with the hydrogen of the sulphuric acid, producing hydrochloric acid and sulphate of soda; or, by symbols,  $\text{Na} + \text{H}_2\text{SO}_4 = \text{HCl} + \text{NaHSO}_4$ . The gas is colorless, but escaping in the air it instantly unites with moisture present, and forms a white cloud. It has a strongly acid taste and a pungent odor. Taken into the lungs it is so irritating as chlorine. It neither supports combustion nor is itself inflammable. At a pressure of 40 atmospheres, at 50° F., it is condensed into a liquid of specific gravity 1.48 which dissolves bitumen. The density of the gas is 1269.5, air being 1000. Its affinity for water is such that it can be kept only in

cury. If a piece of ice be introduced ar containing the gas, the ice is in-liquified, and the gas disappears. If be opened under water, the water p as into a vacuum. Water at 40° F. nearly its own weight, or about 480 s bulk of hydrochloric acid gas, in- in volume about one third, and ac- a density of 1.2109; at this strength it nearly 48 per cent. of acid. The solution is the form in which the acid only known. It is of various degrees ighth, the strongest readily obtained 6 equivalents of water to 1 of acid, r cent. of real acid, and being of spe- vity 1.208. This loses acid by evapo- oming, according to Prof. Graham, to valents of water to 1 of acid, this con- 25.52 of real acid, and being of spe- vity 1.1197. When reduced by dist- ill it changes no more, it contains 16.4 nts of water and 20 per cent. of real l is of specific gravity 1.0947. The fol- able by Mr. E. Davy gives its strength ent densities:

Quantity of acid per cent.	Sp. gr.	Quantity of acid per cent.
42.43	1.10	20.20
40.40	1.09	18.18
38.38	1.08	16.16
36.36	1.07	14.14
34.34	1.06	12.12
32.32	1.05	10.18
30.30	1.04	8.08
28.28	1.03	6.06
26.26	1.02	4.04
24.24	1.01	2.02
22.22		

oximate result is obtained by multiply- decimal of the specific gravity by 200. ure concentrated acid is colorless, and then exposed to the air. It is con- versed for most purposes diluted to a spe- rity of about 1.1, at which it does not hough powerfully acid, it is not so e as sulphuric acid. It is decomposed ances which yield oxygen freely, as ganese dioxide, and is thus made to chlorine gas, its hydrogen combining e oxygen of the metallic oxide. Ni- silver, AgNO<sub>3</sub> (old AgO,NO<sub>3</sub>), detects nce by the formation of a white curdy te of chloride of silver, AgCl, which e in ammonia, but not in nitric acid.— nts used for preparing hydrochloric acid on a large or small scale are common uric acid, and water. Different pro- are adopted, the most usual being ights of concentrated acid and of salt, e large way 6 parts of salt to 5 of acid, e equivalent of each, to which 5 parts e are usually added. The acid mixed ut half water is poured when cool salt contained in a large retort, and nder of the water is placed in the rring as a condenser to receive the at is applied to the retort, and the acid is over; the water in the condenser

allows none of it to escape, so long as it is kept cool and is not saturated. The aqueous solu- tion obtained is of specific gravity about 1.17, and contains 84 per cent. of dry acid. The residuum is common sulphate of soda or Glau- ber's salt. The acid is so cheaply prepared in large chemical works, that it is seldom made in the laboratory. It is an incidental product in the manufacture of carbonate of soda, and was formerly allowed to go to waste. The com- mercial article is often contaminated with iron, which gives it a yellow color, though this is sometimes owing to organic matter, as cork or wood. Sulphuric acid is almost always present in it, and sometimes free chlorine and nitrous acid. Sulphurous acid, H<sub>2</sub>SO<sub>3</sub>, has also been found, to the amount of 7 to nearly 11 per cent. Sulphuric acid is detected by the forma- tion of a white precipitate of sulphate of bary- ta, produced when chloride of barium, BaCl<sub>2</sub>, is added to a diluted portion of acid. Traces of sulphurous acid are detected by a mixture of perchloride of iron and ferrocyanide of potas- sium, Prussian blue being formed by the re- ducing action of the acid on the mixture. Arse- nic and chloride of lead, PbCl<sub>2</sub>, may sometimes be detected by a current of sulphuretted hydro- gen, H<sub>2</sub>S (PbCl<sub>2</sub> + HS<sub>2</sub> = 2HCl + PbS). The common method of purifying is to dilute, add chloride of barium, and distil.—Hydrochloric acid is largely employed in the arts, especially as a solvent for mineral substances. In combi- nation with nitric acid it makes the *aqua regia*, used for dissolving gold and platinum. It is used to furnish chlorine in the preparation of bleach- ing and disinfectant salts, and in the production of sal ammoniac; and is employed to extract gelatine from bones. When neutralized with basic oxides, it does not combine as an acid with these, but gives its hydrogen to their oxy- gen, and its chlorine unites with the metallic base of the oxide.—In medicine hydrochloric acid may be employed with advantage, largely diluted, to assist the process of digestion, which it does by replacing the deficient portion of the normal acid and of the gastric juice. When administered with pepsine it forms a sort of arti- ficial gastric juice. It has also been employed as a tonic in various diseases, and as an in- gredient of gargles, when sufficiently diluted. The strong acid may be used as an escharotic. It is much less corrosive than sulphuric acid. When poisoning has occurred from swallowing the strong acid, it should be neutralized by magnesia or soap, and the case then treated as other kinds of corrosive poisoning are. The principal indications for the therapeutic admin- istration of hydrochloric acid are to be found in calculous affections, in certain forms of dys- pepsia, in typhus and typhoid fevers, and in aphthous affections of the mouth and stomach. It may be given in the dose of from 10 to 30 drops three or four times a day, freely diluted with water. Its local application in cases of ul- cerated, putrid, and diphtheritic sore throat has often been attended with the happiest results.



**HYDROCYANIC ACID**, or **Prussic Acid** ( $\text{HCN} = \text{HCy}$ ; chemical equivalent 27), was first obtained in its aqueous solution by Scheele in 1782, who described it correctly as consisting of hydrogen, carbon, and nitrogen; but the true nature of the compound was determined by Gay-Lussac 30 years later, who first obtained the anhydrous acid. This is a colorless, inflammable liquid, possessing a strong odor, which is recognized in peach blossoms; but when exhaled from the pure acid it is so powerful as to cause immediate headache and giddiness, involving the most serious consequences to life itself. The vapor is so remarkably volatile, that a drop of the acid congeals upon a piece of glass by the rapid evaporation of a portion of the liquid. It boils at  $80^\circ$ , and freezes at  $5^\circ$  into a fibrous mass. At  $45^\circ \text{F}$ . its specific gravity is 0.7058. Its taste (a hazardous test) is acid and bitter like that of bitter almonds. Its acid properties are feeble; the faint red tinge it imparts to litmus paper soon disappears; and it fails to decompose salts of carbonic acid. It exists in parts of many plants, as the kernels of peaches, almonds, plums, &c., and in the leaves of the peach, laurel, &c. It is also generated in the processes contrived for extracting it from various vegetable matters. The chief source of the acid, however, is the blood, hoofs, horns, and tissues of animals, which are made to furnish cyanogen to potassium on being ignited with carbonate of potash, and the cyanide thus obtained and other cyanides of the same derivation are employed to furnish the cyanogen for the acid. Its coloration in Prussian blue gave it the name of Prussic acid. Many methods have been devised for preparing the anhydrous acid. The cyanide of mercury has been decomposed together with hydrochloric acid, thus producing chloride of mercury and hydrocyanic acid; and sulphuretted hydrogen and also diluted sulphuric acid have by suitable processes been substituted for the hydrochloric acid. But the aqueous solution or medicinal acid is commonly prepared direct by some one of the numerous processes of the pharmacopœias. The following, adopted in the United States, is recommended for its simplicity and convenience: Of cyanide of silver  $50\frac{1}{2}$  grains are dissolved in 41 grains of hydrochloric acid diluted with a fluid ounce of distilled water; the mixture is shaken in a well stopped phial, and the clear liquor, poured off from the insoluble matter which subsides, is kept in tight bottles excluded from the light. Single equivalents of the acid and cyanide salt are employed; and by their mutual decomposition hydrocyanic acid is obtained in solution, and chloride of silver falls as a precipitate. By this method the acid may always be prepared as wanted; a matter of no little importance in its medicinal applications, in consideration of its liability to decompose spontaneously, and its consequent uncertain composition and strength. The aqueous solutions prepared by the different processes

adopted are not uniform in their proportions of anhydrous acid; but their strength ought not to exceed 3 per cent. of pure acid. Various methods are given in the chemical books of ascertaining this strength and the degree of purity. Sulphuric and hydrochloric acids are the most common foreign bodies present. The quantity of real acid is usually determined by the weight of cyanide of silver precipitated on adding nitrate of silver. By the United States formula 100 grains of pure acid must accurately saturate 12.7 grains of nitrate of silver dissolved in distilled water, and produce a precipitate of cyanide of silver, which, washed and dried at a temperature not exceeding  $212^\circ$ , shall weigh 10 grains and be wholly soluble in boiling nitric acid. If a residue remain, it is chloride of silver, indicating the presence of hydrochloric acid in the original. Sulphuric acid would be indicated by a precipitate formed on adding chloride of barium to a portion of the acid.—Hydrocyanic acid is well known as one of the most powerful of poisons, destructive to vegetable as well as animal life. Seeds immersed in it lose their germinating power, and the stems of sensitive plants lose their peculiar property by its application. Small doses of hydrocyanic acid give rise to a bitter taste, a tingling in the throat, a feeling of warmth in the stomach, and an increased secretion of saliva. If the dose is increased, there are in addition headache, dizziness, confusion, drowsiness, and sometimes nausea and labored breathing. After the long continued use of small doses the pulse becomes less frequent. As the dose is increased the symptoms above mentioned increase in intensity, especially the dyspnoea, while the pulse becomes frequent and small. Consciousness may be completely lost, the pupil dilated, and convulsions occur, and yet recovery take place. Fatal cases occur with aggravation of these symptoms, except when death takes place so rapidly that no symptoms are developed beyond sudden loss of consciousness, a short period of labored breathing, disappearance of the pulse, and collapse. When continuously applied externally, hydrocyanic acid lessens the irritability of the sensitive nerves. It is used in medicine to diminish pain and irritation; in some affections of the stomach to check vomiting; and in chest affections to allay cough, especially of a spasmodic character. Oil of bitter almonds has been used to produce the effect of hydrocyanic acid, but the amount of acid contained therein is so variable that it is an uncertain preparation. When poisoning takes place, death often approaches so rapidly as to preclude the employment of any efficient treatment. But if the heart is still beating, stimulants, especially ammonia, should be very cautiously applied. Cold affusion may also act as an excitant, and artificial respiration may sustain life long enough for a portion of the poison to be eliminated, and life saved. The subcutaneous injection of atropia has also been

proposed, but has not been proved to be of much value as an antidote. After death and before decomposition has taken place, the presence of hydrocyanic acid is rendered apparent in the blood vessels and also in the brain by its peculiar odor. To obtain the acid, the contents of the stomach should be washed with distilled water and filtered, and the filtrate distilled in a water bath. The product may then be subjected to the various tests given in the chemical works. The therapeutic value of hydrocyanic acid is limited chiefly to a few nervous affections of the stomach, to the vomiting of pregnancy, and to whooping cough and spasmodic derangements of the respiratory organs. Only the dilute form is used medicinally, of which the dose varies from two to five or six drops.

**HYDRODYNAMICS.** See HYDROMECHANICS.

**HYDROFLUORIC ACID.** See FLUORINE.

**HYDROGEN** (Gr. *ὕδωρ*, water, and *γενέσθαι*, to produce), an elementary gaseous body, named from its property of forming water by combining with oxygen. Its symbol is H; chemical equivalent 1; weight compared with air 0.06926; 100 cubic inches weigh under ordinary pressure and temperature 2.14 grains, being 16 times less than an equal volume of oxygen, and 14.4 times less than air. One litre of hydrogen gas at 0° C. and 760 mm. pressure weighs 0.08936 gramme. It was known near the close of the 17th century, and was termed inflammable air from its burning with a flame; it was also called phlogiston, from the supposition of its being the matter of heat. Its real nature was first described by Cavendish in 1766. The gas is not found uncombined, but is readily obtained by decomposing water, of which it constitutes about one ninth by weight, the remainder being oxygen. This process is effected very much as metallic oxides are decomposed, some substance being presented to the compound which has a strong affinity for the oxygen, and combining with it liberates the hydrogen or other element. The vapor of water passed through an iron tube filled with iron shavings and kept at a red heat is thus decomposed, the oxygen uniting with the iron, and the hydrogen escaping. The common method of preparing the gas is to place some bits of zinc in oil of vitriol or sulphuric acid diluted with five or six times its bulk of water. Chemical action immediately takes place, and the zinc is dissolved with effervescence, owing to the bubbles of hydrogen separating from the liquid. The reaction is represented by the formula  $Zn + H_2SO_4 = ZnSO_4 + H_2$ . With an ounce of zinc there may be obtained 615 cubic inches of hydrogen. A common flask answers very well for the apparatus, by inserting a bent tube through the cork for the exit of the gas, and a straight tube, terminating above in a small funnel, and reaching below the cork nearly to the bottom of the flask, at least so as to be covered by the liquid. Through this tube the acid is poured

in as required, the zinc and water being first introduced. The sulphur and carbon which are present in almost all zinc appear in the hydrogen as traces of sulphuretted hydrogen and carbonic acid. They may be separated by agitating the gas with lime water. When pure, hydrogen has neither taste, smell, nor color. It is destructive to animal life when inhaled for a short time, and extinguishes a burning taper plunged into it. Yet it is itself highly combustible, burning with a faint bluish yellow flame at its contact with atmospheric air or oxygen; and when mixed with proper proportions of ether and ignited by flame, an electric spark, or a glass rod heated hardly to redness, its combustion is instantaneous and explosive. A piece of spongy platinum introduced into the mixture also causes combustion to take place. The most violent effects are produced by a mixture of two volumes of hydrogen and one of oxygen. The only product of the combustion of hydrogen is water. The gas is made to enter into combination with the oxygen of the air, producing heat sufficient to cause its ignition, by directing a jet of it upon a piece of spongy platinum, or even upon a perfectly clean surface of sheet platinum. The metal becomes red hot, the gas ignites, and thus a light may be instantaneously obtained. A little apparatus was devised for this purpose by Prof. Döbereiner, which would be an excellent means of obtaining a flame in the absence of the cheap matches in common use. Though the flame of hydrogen is very slightly luminous, a bright light is emitted from the heated platinum; and an apparatus based on this principle has been applied to purposes of illumination in the place of ordinary gas lights. Such lights were at one time in practical use in France and England. The hydrogen was produced by the decomposition of water, effected by passing its vapor over incandescent charcoal contained in a tube; some carbonic oxide and carburetted hydrogen were generated, which burned with the hydrogen, the jet of mixed gases being directed against a basket constructed of fine gauze of platinum, which became intensely hot and highly luminous. Hydrogen produces intense heat by its combustion, taking up more oxygen than is required by the same weight of any other combustible. It is this property that has led to its application in the oxyhydrogen blow-pipe for melting the most refractory substances. (See BLOWPIPE.) The levity of hydrogen early suggested its use for filling balloons. The quantity required to fill one of the capacity of 2,000 cubic feet would weigh only 10.57 lbs., while the same volume of air would weigh 153.26 lbs., giving an ascensional power of 142.69 lbs. Illuminating gas is heavier, but is commonly used instead of hydrogen only on account of its greater cheapness. Hydrogen is so subtle and penetrating a gas that it passes with facility through paper and also through gold and silver leaves. A stream of the gas directed against one side of the leaf may be ignited on the

other. Hydrogen combines with one equivalent of oxygen to form hydrogen monoxide or water; with two equivalents to form the dioxide or oxygenated water, a liquid discovered by Thénard in 1818, and now prepared by chemists for medicinal purposes; also with one equivalent of nitrogen to form ammonia; and with one of chlorine to form hydrochloric acid. From his researches on the occlusion of hydrogen by palladium, Prof. Graham was led to infer the existence of an alloy of palladium and hydrogen gas condensed to a solid form, to which he gave the name of *hydrogenium*. Assuming that the hydrogen enters into the combination with the density which it would exhibit if solidified in the free state, he calculates, from the observed density of this so-called alloy of palladium and hydrogenium, and of similar alloys containing in addition gold, silver, or nickel, that the density of this hypothetically solidified hydrogen varies between the limits 0.711 and 0.7545; mean, 0.733. The presence of hydrogen in the atmosphere of the sun and in the planets has been shown by spectrum analysis. On the sun four lines are attributed to hydrogen.

**HYDROGRAPHY** is the science which, by representation of the figure of the bottom of the ocean and its tributaries by means of soundings, by observations of tides and currents, and by investigations of the winds and their action and of the law of storms, aims to diminish the risk attending the navigation of dangerous waters. The results of these investigations are shown upon charts, which give the outlines of the coasts and harbors, the depths of water in the navigable channels, the rocks and shoals with the soundings upon them, and various tidal and magnetic information. In the course of the investigations specimens of the bottom are also obtained by apparatus attached to the sounding lead; and the temperature of the water is frequently taken as an additional guide to determine the mariner's position. By such sea charts as are now prepared and published by the English and French hydrographic offices and by the coast survey of the United States, the risks attending navigation have been greatly diminished. (See COAST SURVEY.) Hydrography, as it now exists, belongs to modern times, although various rude attempts at hydrographic examinations and the construction of sea charts were made in early times. The invention of charts for mariners is commonly ascribed to Henry the Navigator (1394-1460), although earlier ones exist. Of necessity such were rude and imperfect, the size and even the true shape of the earth being then unknown, the log for measuring nautical miles not in use, the only instrument for determining latitude being the sea astrolabe, and none existing for determining the longitude. Little was accomplished through national instrumentality toward the improvement of our knowledge of the sea and its tributaries until the middle of the 18th cen-

tury; what little was known being the result of the enterprise of individuals, such as Columbus, Cabot, Drake, and other navigators. The researches of Capt. James Cook of the English navy, which were begun at Quebec in 1759, when he was master of the frigate *Mercury*, and were continued for about 20 years, may be considered as the commencement of a new era in hydrography. (See COOK, JAMES, and DES BARRES.) The success of the English captain excited the rivalry of the French; and in 1785 La Pérouse was placed in command of an expedition consisting of two frigates, with a corps of scientists, and sent to continue the work which Cook's untimely fate had left unfinished. They were never heard from after their departure from Botany bay; but La Pérouse had sent home from there duplicates of the journals and charts of his discoveries up to the date of his arrival. D'Entrecasteaux's unsuccessful expedition in search of him in 1791 gave rise to a text book on marine surveying by his navigating officer, Beautemps-Beaupré, published as an appendix to the narrative of D'Entrecasteaux's voyage (1808). This, with the exception of Alexander Dalrymple's "Essay on the most Commodious Method of Marine Surveying" (1771), was the first treatise published in a practical shape. About the time of its publication Beautemps-Beaupré took charge of the survey of the French coast, and trained a corps of hydrographers, who formed the nucleus of a body of scientific engineers to be furnished to future expeditions for surveying and exploration. Spain has also done a great deal for hydrography, although in a more indirect way. The legal provision for the examination of officers of the mercantile marine as to their competency to navigate a vessel, before promoting them, has given a high reputation to its merchant service; and the nautical information obtained from that source has been found exceedingly valuable. Her example has of late years been followed by almost every nation having much commerce. But in our own times, with improved instruments, trained professional hydrographers, and liberal appropriations of money and men, hydrography has become a recognized branch of public works, and the knowledge of it an absolute necessity to the complete seaman. Reconnoissances of large extents of coast have been made by men trained to the practice of the science, with such success as to be scarcely capable of correction by the results of detailed surveys. In the latter the aid of geodesy (by which the positions of points on shore are accurately determined) is called in; and no such examination is considered complete or accurate unless it depends upon triangulation. (See COAST SURVEY, vol. iv., p. 757.) Great Britain, France, Spain, the United States, and other nations have now their hydrographic offices as established branches of government; and under the direction of these departments close and accurate surveys are made of the

home coasts, and their surveying vessels frequent all parts of the globe, and penetrate seas hitherto almost unknown, mapping the limits of harbors, determining with precision the geographical position of headlands and entrances, and of rocks, shoals, and sands, many of them hitherto unknown. In this science England is far in advance of all other nations. Not content with a most complete and admirable survey of her own coasts, she has extended her work to all of her possessions and to the coasts of foreign nations. Many eminent surveyors are numbered among her naval officers; but it is probable that few have done so much or displayed so much zeal and devotion to the science as the late Admiral Beaufort, so long at the head of the hydrographic office of the admiralty. His surveys were sometimes actually carried on at his own expense. Much importance is attached to the results expected from the scientific cruise of the British ship *Challenger*, which at the present time (1874) is engaged in a voyage around the world, probably the most important of its kind ever undertaken. She carries a large number of men familiar with almost all the branches of science and art, whose labors, it is hoped, will be productive of much information in natural science and in marine surveying and deep-sea dredging. Although surpassed by England in the number and completeness of her foreign surveys, the hydrographic work on our own coasts is unequalled for accuracy and rapidity of execution. Under the charge of the coast survey of the United States it has progressed in company with the trigonometrical and topographical work of that service; and it is safe to assert that the completed charts of the coast and the various harbors stand alone in the annals of surveying for beauty of execution, accuracy, and completeness of detail. A large corps of skilled professional hydrographers are constantly employed prosecuting the surveys of the numerous harbors on the Atlantic, Pacific, and gulf coasts; and others are engaged in deep-sea explorations along the course of the Gulf stream, in the gulf of Mexico, and on the coasts of California and Oregon. These deep-sea expeditions have been especially useful in determining the routes suitable for submarine cables, several of which have been laid over lines previously sounded and surveyed by officers belonging to the coast survey. One of the most successful hydrographic expeditions of modern times was that undertaken between 1851 and 1853 under the auspices of the coast survey of the United States, by Lieut. (now Rear Admiral) James Alden of the navy, in the steamer *Ewing* and steamer *Active*. More than 1,000 m. of the Pacific coast was explored, from lat.  $32^{\circ} 30'$  to  $48^{\circ} 20'$  N., and the geographical positions of all the prominent headlands and of the entrances to the harbors were determined by astronomical observations from the southern boundary of the United States to the strait of Fuca; lines of

soundings were carried along the coast throughout its entire length, and hydrographic reconnaissances made of most of the harbors, with accurate views of the different entrances and of prominent points on the coast; and subsequent careful detailed surveys, based upon accurate geodetic determinations, have failed to change the results of this work in any important particular. The immediate result of this reconnaissance was the publication of a chart of the Pacific coast for the use of mariners, and subsequently of a marine directory, which has since been elaborated and published as a "Coast Pilot of the Pacific Coast of the United States."—The method of hydrographic surveying, as now practised both in this country and in Europe, is as follows: 1. *Reconnaissance*, as, for instance, the hydrographic survey of a harbor on a foreign coast, or any place where accurate geodetic information cannot be obtained. The hydrographer, obliged himself to make all the determinations of points on shore and the outlines of the coast, applies the principles of geodesy and topography, but of course in a comparatively rude manner. A base line may be measured, if on land, in the ordinary way; but if the working ground is so far from shore as to render points on shore useless (as is sometimes the case in surveys of shoals off a low and flat coast), or if the coast is occupied by an enemy, a base line is sometimes measured by anchoring a boat at each end of it, and noting the interval between the flash of a gun fired from one boat and the report as heard at the other. But this very rude method is only admissible where no other is possible. Where the surface to be surveyed is small, good results have been obtained from a base line measured by a cord, the two ends being marked either by boats or buoys. Signals are erected at each end of the base line and on prominent points along the shore, the latter being determined by horizontal angles measured from each end of the base line. Not only the angle between each end of the base and each signal is measured, but the angles between the different signals themselves; and the triangles thus formed are either computed by trigonometry or platted by intersections upon the chart. The latitude and longitude of some prominent points are also determined. The outlines of the coast or harbor are drawn between intermediate points determined by horizontal angles, and the chart is then ready for plating the sounding lines. Next, a tide gauge is erected. This is generally a plain staff, graduated to half feet; and by continuous observations of the rise and fall of the tides, and of the times of high and low water, the hydrographer obtains an approximate establishment for the port, and also the means of correcting his soundings for the rise of the tide, which is called "reducing them to the level of low water." The shore line having been rudely determined, and such natural and artificial features mapped as may be considered neces-

sary, a boat is started from any point in the harbor to run the lines of soundings. The boat is steered on a certain course, and soundings are taken at intervals as nearly regular as possible. These soundings, together with the time at which they are taken and the horizontal angles for position, are recorded. The end of the line is also determined by angles; and the boat is then started on a new line. Thus the harbor or bay is crossed and recrossed by lines of soundings intersecting each other in numerous places; and these soundings, reduced to low-water level and laid down upon the chart, show the depth at low water not only in the channel but on the various shoals.

2. *Deep-Sea Soundings.* In this kind of hydrography the position of the vessel is determined from time to time by careful and numerous observations of the sun and stars, and by dead reckoning. The line used has recently been successfully replaced by a wire, and the lead or shot at the end of it is so arranged as to be detached on striking the bottom. An instrument called an indicator is attached to the sounding line, which, by means of revolving disks put in motion by a screw-propeller wheel, registers the depths to which it descends; when relieved of the weight of the lead, it is thrown out of gear and drawn up. The line is drawn in by a reel worked by a small steam engine; and by means of all these appliances soundings are taken at great depths with a rapidity and accuracy utterly unknown until of late years. Specimens of the bottom are obtained by means of specimen cups attached to the sounding line, or by the dredge. The best indicators now in use are those of Trowbridge and Brooke, the latter gentleman's having given thus far the best results.

3. *Hydrographic Surveys.* The process in a detailed survey is similar to that in a reconnoissance, but more elaborate. The hydrographer is furnished with the positions of numerous points on shore and with a map of the shores of the harbor in detail, on a scale to suit his own work. Upon this map are platted the points furnished him from the geodetic survey; and upon it he also constructs his lines of soundings. Usually two, and sometimes three officers are employed in each boat in running the lines, the advantage of this arrangement being that the two angles necessary to determine the position of the boat can be taken at the same moment by two observers without stopping the boat. Sometimes, especially where the work lies at a distance from the shore, two observers are placed on prominent points on shore, each with a theodolite. At stated intervals the surveying boat or vessel hoists a ball or flag, when both observers direct their instruments to her, and upon the instant of its being lowered measure the angle between the boat and some fixed point. The intersection of their two lines of sight when platted upon the chart gives the position of the boat. The lines of soundings are run more closely than in reconnoissance, and as far as possible are

made to cross each other at right angles. Tidal observations are made to tenths of a foot; and the box gauge, and at certain central points the self-registering gauge, are used. (See COAST SURVEY, vol. iv., p. 762.) The surveying parties, from the chief to the leadsmen, are specially trained for the work, and the resulting accuracy of such a survey is correspondingly great.—Physical hydrography investigates the laws of the formation of shoals, the effect upon harbors and channels of the tidal currents, of the extension of wharves, and of the dumping of earth and ballast; and endeavors to provide remedies for the changes which injure a harbor, and to suggest means for improving the channels. This branch of the science has of late years attained to great importance both in Europe and the United States, and the researches of those who have devoted themselves to its study have resulted in incalculable benefits to commerce. (See COAST SURVEY, vol. iv., p. 761.) In regard to currents, and other hydrographic details, see ATLANTIC OCEAN, and DREDGING (DEEP-SEA).

**HYDROIDS**, the lowest order of asclephs or jelly fishes, including, according to Agassiz, two distinct forms, one resembling polyps, the other like the jelly fishes, there being every possible gradation between the two. It is in this order that the phenomena of alternate generation have been specially studied by Sars and others. (See JELLY FISH.) There are many plant-like forms which give a mossy covering to seaweeds and stones, producing buds, developing in some cases into free medusæ, and in others remaining attached to the parent stalk, both discharging ova which swim off by ciliary processes to establish new fixed hydroid communities. In the tubularians the hydroid is pedunculated, and the bell-shaped medusæ are either free as in *coryne* or persistent as in *tubularia*. In the scertularians the hydroid is always pedunculated and attached, protected by a horny sheath, forming a cup around the head, with free medusæ as in *campanularia*, or free generative buds as in *scertularia*; their medusæ are flatter than in tubularians. The *siphonophoræ*, like the Portuguese man-of-war, are also hydroid communities.—The common green hydra of fresh water (*hydra viridis*) is easily seen by the naked eye; the body is a cylindrical tube, with thread cells, and a green coloring matter believed to be the same as the chlorophyl of plants; at the base is a disk-like sucker for its attachment to foreign bodies; it is usually suspended, head downward, from some aquatic plant, changing its position at will. The mouth is at the opposite end, surrounded by 5 to 15 very contractile tentacles, armed with lasso cells, hollow, and communicating with the general and stomachal cavity of the body; by these they obtain their food, which consists of minute aquatic animals. There are no internal organs of any kind, and they are therefore very little higher than the protozoa. They resist without destruc-

tion a very great degree of mutilation, each fragment into which they may be divided being capable, according to Trembley, of becoming a complete individual. Reproduction is either non-sexual, by gemmation in summer, or sexual, by ova and sperm cells in autumn;



Hydra.

the buds develop a mouth and tentacles at the free end, and are soon detached, each in its turn producing similar buds; both ova and sperm cells are produced in the same individual coming in contact in the water; the embryo is at first ciliated and free swimming, afterward becoming fixed, losing the cilia, and developing a mouth and tentacles.

**HYDROMECHANICS**, that branch of natural philosophy which treats of the mechanics of liquids, or of their laws of equilibrium and of motion. It includes the consideration of those molecular properties of liquids which affect their mechanical applications, such as fluidity and slight compressibility. The science which is here termed hydromechanics has been sometimes treated under the title of hydrodynamics, this being made to include hydrostatics and hydraulics, which is the nomenclature adopted by Sir David Brewster; while others treat of hydrodynamics and hydrostatics as two independent subjects, hydraulics being embraced by hydrodynamics; but the title hydromechanics which was adopted in the first edition of this Cyclopædia seems to be the most comprehensive and exact, and will be retained.—Hydromechanics is comparatively a modern science, having received its greatest development in the 16th, 17th, and 18th centuries. The ancient mathematicians and hydraulic engineers, who constructed the aqueducts of Egypt and Assyria, must have been acquainted with many of the more obvious principles of hydraulics and hydrostatics; and at the time of the construction of the Roman aqueducts hydromechanics may be considered as having become entitled to be called a science; but the more purely mathematical principles by which its laws can be well understood were not discovered till centuries after.

Some of the general principles which lie at the foundation of the science, and are susceptible of analytical and experimental demonstration, were first given by Archimedes in the latter part of the 3d century B. C.; and it is to him that we owe the demonstration of the fundamental principle of the equilibrium of liquids, that each particle in a liquid at rest receives equal pressure in every direction, and also that a solid immersed in a liquid loses an amount of weight equal to that of the water displaced, from which he deduced the method of obtaining the specific gravity of bodies. We also owe to him the method of raising water by means of the screw known by his name. Other advances in the construction of hydraulic machinery were made about the same time in the Greek school at Alexandria by Ctesibius and Hero, who invented the syphon and forcing pump, and also the fountain known as Hero's; but their limited knowledge of pneumatics, and the imperfection in the machinery of those times, prevented them from bringing the force pump to anything like its present degree of efficiency. The first attempt at a scientific investigation of the motions of liquids was made by the consul Frontinus, who was inspector of the public fountains at Rome under the reigns of Nerva and Trajan, and whose book *De Aquæductibus Urbis Romæ Commentarius*, describing the nine great aqueducts of Rome, to which he afterward added five, contains all the knowledge of hydromechanics possessed by the ancients. From the statement of Pliny that water will rise to a level with its source, and that it should be elevated in leaden pipes, it appears that this metal was used by the ancient Romans for small conduits. Frontinus was the last of the ancients who paid much attention to the subject, the next investigator of importance being Stevinus, born about 1550, who was engineer of dikes for the government of Holland. He published a work in Dutch in 1586 on the "Principles of Statics and Hydrostatics," in which he restates the principle of Archimedes, and deduces from it the "hydrostatic paradox," that the pressure of a liquid on the bottom of a vessel may be much greater than its weight. By a method approaching the infinitesimal calculus, he found the pressure on the oblique bottom of a vessel; and Whewell remarks that his treatment of the subject embraces most of the elementary science of hydrostatics of the present day. Galileo, in his "Discourse on Floating Bodies" (1612), shows a clear knowledge of the fundamental laws of the science; but it is to his discovery of the uniform acceleration in falling bodies that we owe one of the chief foundations of hydromechanics. This law was afterward more fully applied by Torricelli in his celebrated theorem that the velocities of liquid jets are proportional to the square roots of the depths at which they issue below the surface, which he published at the end of his treatise *De Motu Gratum naturaliter accel-*

rato (1643). Pascal's work, written ten years later and published after his death, *Sur l'équilibre des liqueurs*, in which he treats the subject in a more systematic manner than any previous writer, contains complete and elegant demonstrations of most of the principles of hydrostatics, but does not treat of the motions of liquids. The next great student of hydromechanics was Sir Isaac Newton, who investigated the subject of friction and viscosity in diminishing the velocity of flowing water, and also of the velocity of jets; but upon the latter point he fell into an error by supposing that the velocity with which water issues from an orifice is equal to that which a body would attain by falling through half the vertical distance between the surface of the liquid and the orifice. His subsequent discovery of the *vena contracta* modified his conclusions, but his theory of efflux is open to objections. He, however, investigated the subject of waves, one of the most difficult in the science of hydrodynamics, in a manner worthy of his genius. In 1738 Daniel Bernoulli published *Hydrodynamica, seu de Viribus et Motibus Fluidorum Commentaria*, in which he founds his theory of the velocity of the motion of fluids through orifices upon the supposition that the surface of a fluid which is discharging itself by an orifice preserves a level, and that if the liquid is divided into an infinite number of horizontal strata, all the points in these strata will descend with velocities inversely proportioned to their breadth, or to the horizontal section of the reservoir. To determine the motion of each stratum, he employed the principle of "conservation of living forces;" and from the elegance of his solutions his work is pronounced by the abbé Bossut one of the finest productions of mathematical genius. But the uncertainty of the principle which he employed rendered the results of his work of less value than their mathematical excellence. The science afterward received the attention of D'Alembert and of Euler, who enriched it by the application of special mathematical methods of great acuteness and originality. The abbé Bossut also experimentally investigated the discharge of liquids by orifices, and added much to the stock of knowledge on the subject. To the experiments of Venturi, Eytelwein, and others, the science is indebted for many facts in regard to the flow of water from conically diverging tubes. The flow of water over barrages has been from time to time investigated experimentally by the chevalier Dubuat, D'Aubuisson, Castel, and M. Prony, and also by Smeaton, Brindley, Robinson, Evans, Blackwell, and others.—Before considering the separate branches of the subject, we will notice two important physical properties of liquids, as upon them the action of hydrostatic and hydraulic forces depends. The first important property of a liquid is the perfect mobility of its particles over each other, and one which results from their slight cohe-

sion. That there is a certain degree of cohesion is shown by the fact that liquids will drop. There is no active repulsion between the particles until they have been heated to a certain degree; or the repulsion, if there is any, on the hypothesis that both forces are always in action, is less than the cohesive force. A certain degree of cold, varying with the nature of the liquid, will cause an increase of the cohesive force, so that the liquid will become thicker and then solid; and it is found that the fluidity of a liquid is promoted by heat. That water when cold will not flow through pipes as rapidly as when warm. The most important physical property of liquids is their great resistance to compression, so that for a long time it was doubted whether water was compressible. The experiment of Baccarini, who hammered a leaden vessel filled with water till it was forced through the pores of metal, was cited as a proof of the incompressibility of water; but a remark of Baccarini, that the effect that he estimated the diminished space into which the water was driven indicates that he drew a different conclusion from the experiment of the Florentine academicians, who forced water in a similar manner through the pores of a silver vessel was for some time regarded as indisputably establishing the incompressibility of water; but the apparatus devised by Oersted proves in a conclusive



FIG. 1.—Oersted's Apparatus.

maner that water and other liquids are incompressible. Oersted had previously shown that liquids were compressible, but the effect could not be ascertained with any accuracy on consequence of the facility of determining the amount of experiment which had been reduced in the content vessel. This was ascertained by Oersted by forcing it within an outer vessel so that it would receive equal pressure on equal surfaces out and within, and preserve a uniformity. His apparatus is shown in fig. 1. The liquid to be subjected to pressure is placed in the inner glass vessel from the top of a capillary tube downward, its open extremity dipping below the surface of a layer of mercury contained at the bottom of the outer vessel. Another tube, labeled 'd', graduated and used as a manometer, open at the lower end and dipping in the mercury, is placed along with the vessel in a strong glass cylinder, which is provided

top with a smaller metallic cylinder which admits the compressing screw *c*, and also a funnel, *d*, for introducing the liquid. The vessel *a* with its capillary stem, having been filled with the liquid, is placed in position, together with the manometer; the outer cylinder is filled with water, the stopcock of the funnel closed, and pressure produced by turning the screw with a lever. Mercury will be seen to rise in the capillary tube connected with the vessel *a*, showing that its contents are diminished in volume. The air contained within the manometer, being reduced in bulk in proportion to the force exerted, according to the law of Boyle and Mariotte, will therefore be a measure of that force. Oersted at first assumed that the external and internal pressure on the vessel was precisely the same; but the external pressure is slightly the greater, because the external surface is greater than the internal, so that the capacity of the vessel is diminished, instead of being increased as in all preceding experiments. Colladon and Sturm with the use of this apparatus made very exact experiments, in which they calculated the change of capacity of the vessel *a*, and estimated that an additional atmospheric pressure would reduce the volume of water .00005, mercury .000005, and sulphuric ether .000133. For water and mercury it was found that within certain limits the decrease in volume is proportional to the pressure. I. HYDROSTATICS. In consequence of the mobility of the particles of a liquid over each other, they yield to the force of gravity, and consequently when at rest present a level surface; and for the same reason each particle, and therefore each portion of the liquid, must exert and receive equal pressures in all directions. If this were not true, the particles of a liquid could not come to a state of rest. From this principle it follows that equal surfaces of the sides of a vessel containing a liquid receive equal pressures at equal depths below the surface; and also that if a close vessel is filled with a liquid which we will suppose to have no weight, and if an aperture of the size of one square inch be made in one side of it and fitted with a piston upon which there is exerted a pressure of 10 lbs., there will also be exerted the same pressure of 10 lbs. upon every square inch of the internal surface of the vessel. Consequently, if another aperture of 100 square inches area is made in the side of the vessel, and a cylinder of the same size is fitted to it, a piston fitted to this will receive a pressure of 1,000 lbs. Upon this principle (which has been ascribed to Pascal, but which, as we have seen, was before his time explained by Stevinus) the hydraulic press is constructed, as represented in fig. 2. A suction and force pump, *a*, supplied from the cistern *B*, forces water through the tube *C* into the strong cylinder *V*, which communicates pressure to the piston *A*. The power gained is the proportion which the cross section of the large piston or plunger bears to the small one. It will be ob-

served that the pistons do not fit the cylinders in the usual manner, but only fit tightly at the collar. This mode of construction greatly increases the efficiency of the machine, which, though described by Stevinus and by Pascal, remained practically useless in consequence of

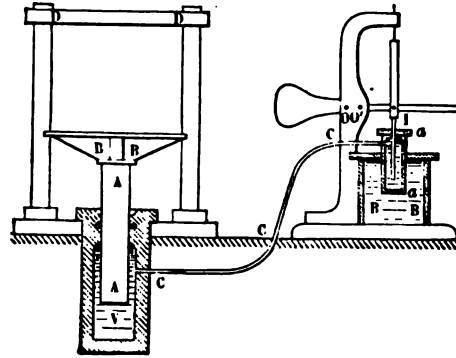

FIG. 2.—Hydraulic Press.

the escape of water between the cylinder and the piston, until Bramah invented the cupped leather collar, which makes the apparatus equally water-tight under all pressures. This engine is a good illustration of the law in mechanics that "what is lost in velocity is gained in power." If the cross section of the large piston is equal to 100 square inches, and that of the small piston to 1 square inch, the latter must be moved through a space of 100 inches to cause the large piston to move through one inch, but it will move with 100 times as much power as the small one. The hydrostatic bellows, shown in fig. 3, acts upon the same principle as the hydrostatic press, the cover of the bellows, upon which the weight is placed, performing the office of the large piston, while the column of water in the tall vertical pipe acts the part of the small piston of the press. The hydrostatic bellows also illustrates the principle of the hydrostatic paradox, for the vertical pipe and the bellows are virtually one vessel, whose base is the bottom of the bellows. Now the pressure exerted by the liquid in the pipe upon the upper plate of the bellows is received by the lower plate, which also has an additional pressure equal to its distance below the upper plate; and if the water in the pipe is ten times as high as that in the bellows, it follows that the pressure on the bottom plate will be ten times as great as that which would be produced by the liquid contained within the bellows itself, for that only is equal to its own weight. If a barrel of water there-

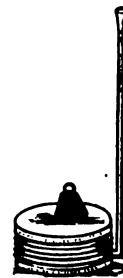

FIG. 3. Hydrostatic Bellows.



and standing vertically, a pressure may be produced on its bottom several thousand times that due to the weight of the water alone. In accordance with this law of hydrostatic pressure, a liquid will rise to the same height in different branches of the same vessel, whether these branches be great or small.



FIG. 4.

Thus, water contained in the U-shaped vessel, fig. 4, will rise to the same height in both branches, which is an illustration of the principle that the pressure of a column of liquid is in proportion to its height and not to its quantity. This principle, however, if it is entitled to such a name, proceeds directly from the principle of Archimedes that each particle in a liquid at the same depth receives an equal pressure in all directions. If however one leg of a U-shaped tube contain mercury and the other water, the column of water will stand  $13\frac{1}{2}$  times as high as that of mercury. It follows from the fact that a liquid presses equally upon equal areas of a containing vessel at the same depth, that if a hole is made in one side of a vessel, less pressure will be exerted in the direction of that side; and therefore if the vessel is floated on water, as in fig. 5, it will be propelled in the direction of the arrow.

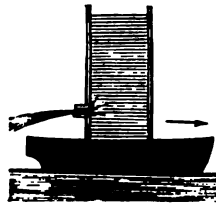

FIG. 5.



FIG. 6.  
Barker's Mill.

Barker's centrifugal mill, a small model of which is shown in fig. 6, acts upon the same principle of inequality of pressure on opposite sides. The propelling force has been ascribed to the action of the escaping liquid pressing against the atmosphere, by which a corresponding reaction is obtained; but if the machine is placed in a vacuum, it will rotate with greater velocity than in the open air, which proves that the propelling force is the preponderance of pressure in one direction. The two following are important laws of hydrostatics: 1. The hydrostatic pressure against equal areas of the lateral surfaces of cylindrical or prismoidal vessels, commencing from the surface of the liquid, varies as the odd num-

bers 1, 3, 5, 7, &c. 2. The hydrostatic pressure against the entire lateral surfaces of cylindrical or prismoidal vessels is proportion to the square of the depth. The first law is demonstrated as follows: Hydrostatic pressure in any direction at any point in a liquid is in proportion to the depth, a result due to the action of gravity; therefore the mean pressure against any rectangular lateral area will be on a horizontal line midway between the upper and lower sides of such area. The pressure of this line, proceeding from the surface of the liquid downward, varies as the odd numbers 1, 3, 5, 7, &c., as will be seen by an inspection of the adjoining diagram, fig. 7. The figures placed upon the dotted lines in the center of the areas indicate the pressures upon the horizontal lines, and also the proportional pressures against those areas.

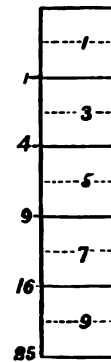

FIG. 7.

The figures on the right side of the diagram indicate the pressures at points of equal vertical distances, while those upon the left indicate the total lateral pressures, which it will be observed are the squares of the number of areas included; by which is demonstrated the second law, that the total lateral pressure against rectangular areas is in proportion to the square of the depth. The weight of a cubic foot of water is 62.5 lbs.; therefore the lateral pressure against a surface of a square foot, whose upper side is in the surface of the liquid, is 31.25 lbs. From it is easy to ascertain the pressure against any square foot, or any area, at any depth below the surface. Simply multiplying the number of feet below the surface by 2 and subtracting 1, multiplying the remainder by 31.25 and the product by the number of horizontal feet will give the pressure of a stratum of water of any length. To ascertain the entire pressure against the sides of a vertical cylindrical or prismoidal vessel, square the depth of the vessel in feet or inches, and multiply this by the lateral pressure against an upper vertical side of a foot or inch, as the case may be, remembering that the weight of a cubic inch of water is .0361792 of an ounce, and therefore that the pressure against an upper lateral side is .2896 ounce. The total pressure exerted against the sides of a cylindrical pipe 60 ft. high and 12 in. in diameter is found as follows:  $60^2 \times 31.25 = 112,500$ . The diameter of the pipe being 12 in., the circumference of the inner surface is  $3.141592 \times 12 = 37.699104$  of a foot. Therefore,  $112,500 \times 37.699104 = 4,241,111.4$  lbs. or 29.95 tons. The lateral pressure on the lower foot would be  $(60 \times 2) - 1 = 119 \times 31.25 = 3,718.75$  lbs.

lbs., or a little less than one ton. In the construction of walls for resisting only the hydrostatic pressure of water, as that pressure is in proportion to the depth, the strength of the wall should be in the same proportion. If strength were not given to the lower layers by superincumbent pressure, the inclination of the slope should be  $45^\circ$ ; but in consequence of this pressure it may be less, varying with the materials and their manner of being put together. In the construction of dams or barrages the varying circumstances of cases allow of the display of a good deal of engineering skill. A barrage suitable for restraining a body of water which is never strongly moved in a lateral direction against it, as at the outlet of a canal or a reservoir fed by an insignificant stream, would not be adapted to a mountain torrent, where the surface of the reservoir can scarcely ever be large enough to prevent, by the inertia offered by a large mass of water, the walls from being subjected to a strong lateral force from the action of the current. Under such circumstances it is usual to give a curved surface to the facings, in a vertical as well as in a horizontal direction; the curves in both directions being calculated from the following elements: 1, the ascertained hydrostatic pressure; 2, the nature of the materials, such as the weight of stone and tenacity of the hydraulic cement used; and 3, an estimate of the maximum force of flowing water which may at any time be brought against the structure during a freshet. This force, it will readily be seen, will have a different direction and a different point of application in different cases, depending upon the depth and extent of the reservoir. The top of the dam is therefore given a greater horizontal section than would be called for if hydrostatic pressure alone had to be opposed. The hydrostatic pressure at any point against the surface of a containing vessel is the resultant of all the forces collected at that point, and is therefore at right angles to that surface. In a cylindrical or spherical vessel these resultants are in the

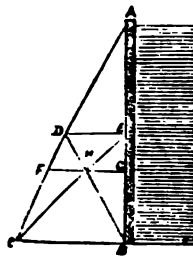

FIG. 5.—Centre of Pressure.

direction of the radii, and in the sphere vary in direction at every point.—*Centre of Pressure.* The centre of pressure is that point in a surface about which all the resultant pressures are balanced. The cases are innumerable, and often require elaborate mathematical investigation. The simplest case and its

general application only will be considered here, viz., that of the centre of pressure against a side of a rectangular vessel. Let any base in the triangle  $A B C$ , fig. 8, represent the pressure at  $B$ ; then will  $D E$  represent the pressure at  $E$ , and all lines parallel to it will represent the pressures at corresponding heights. The finding of the centre of pressure now consists in finding the centre of gravity of the triangle  $A B C$ , which will be at  $H$ , the intersection of the bisecting lines  $E C$  and  $D B$ , and at one third the height of the side  $A B$ ; consequently the centre of hydrostatic pressure against the rectangular side  $A B$  is at  $G$ , one third the distance from the bottom to the surface of the liquid. The average intensity of pressure against  $A B$  being at  $E$ , one half the depth of  $A B$ , therefore the total pressure on the rectangular side  $A B$

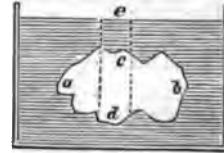

FIG. 9.—Principle of Archimedes.

will be the same as if it formed the bottom of the vessel and was pressed upon by a column of water of half the depth of  $A B$ . In general, the total pressure on any surface, plain or curved, is equal to the weight of a liquid column whose base is equal to that surface, and whose height is the distance of the centre of gravity of the surface from the surface of the liquid.—*Principle of Archimedes.* A solid immersed in liquid loses an amount of weight equal to that of the liquid it displaces. This is called the principle of Archimedes, and is demonstrated as follows: Let  $a b$ , fig. 9, be a solid immersed in a liquid. The vertical section  $c d$  will be pressed downward by a force equal to the weight of the column of water  $e c$ , and it will be pressed upward by a force equal to that exerted by a column of water equal to  $e d$ ; therefore the upward or buoyant pressure exceeds the downward pressure by the weight of a column of water equal to the section  $c d$ . Now, this section also exerts a downward pressure; and if the body is denser than the liquid, the downward pressure will be greater than the excess of the upward pressure of the liquid, and the body will sink if not supported; but if the body is less dense than the liquid, the downward pressure of the column  $e d$  will be less than the upward pressure

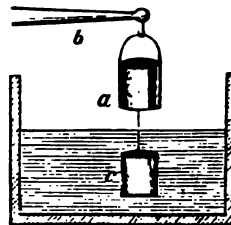

FIG. 10.—Experimental Verification of the Principle of Archimedes.

exerted against it, and the body will float. This principle may be experimentally demonstrated by the hydrostatic balance, fig. 10. From a balance,  $b$ , is suspended a cylindrical vessel,  $a$ , from which again is suspended a solid cylinder,  $c$ , which is of such bulk and dimensions as just to fill the vessel  $a$  when introduced. The whole system is first balanced by weights at the other end of the beam, and then  $c$  is immersed in water. The equilibrium will be destroyed, and that the body  $c$  loses a portion

of its weight equal to that of an equal bulk of water is proved by filling the vessel *a* with water, when the equilibrium of the balance will be restored. It is by means of a similar apparatus that the specific gravities of solids is ascertained (see GRAVITY, SPECIFIC); and upon the principles already laid down hydrometers, or instruments for ascertaining the specific gravity of liquids, are constructed. (See HYDROMETER.) It is thus also shown why it is easier to raise weights in water than in air, and why fat persons sustain themselves in water more easily than those who are lean.



FIG. 11.  
Cartesian Diver.

The air bladder in fishes is for the purpose of enabling them to rise or descend in the element in which they live. This rise and fall by varying the specific gravity is beautifully illustrated by means of the little toy called the bottle imp or Cartesian diver, fig. 11. A bottle is nearly filled with water, and a hollow image of glass or metal and lighter than water, or several little balloons of glass, each of them having an opening below through which water may flow in and out, are introduced into the bottle or jar, which then has its mouth covered with a sheet of caoutchouc, or some elastic membrane. Pressure upon this will compress the air beneath it, and to the same degree the air which is contained in the upper part of the image or the balloons, so that their specific gravity is increased enough to make them sink. Removal of pressure will allow the confined air to resume its former bulk, by which the specific gravity will again become less than that of the water, and they will again ascend. If their surfaces have oblique or spiral directions, and the air is properly distributed, the images may be made to perform various curious evolutions.—*Stability of Floating Bodies.* There are certain points to be observed in determining the stability of floating bodies; these are: 1, the centre of gravity of the floating body; 2, the centre of buoyancy; and 3, the metacentre. When a body floats upon water it is acted on by two forces: 1, its own weight, acting vertically downward through its centre of gravity; 2, the resultant force produced by the upward pressure of the liquid, which acts through the centre of gravity of the fluid that is displaced, which point is called the centre of buoyancy of the body. It follows, therefore, that these two points, the centre of gravity and the centre of buoyancy, must be in the same vertical line for the body to be in a state of equilibrium; for otherwise the two forces, one acting downward and the other upward, would form a couple which would cause the body to turn. When these two centres are in the same vertical line, but the centre of gravity is above, the body, except in some cases to be noted presently, is

in a state of unstable equilibrium; but when the centre of gravity is beneath, the body is in a state of stable equilibrium. If a body is floating in a liquid and is entirely immersed, it will not come to a state of stable equilibrium until the centre of gravity is vertically below

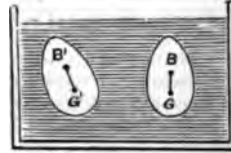

FIG. 12.

the centre of buoyancy. This is shown in fig. 12, in the case of bodies which are less dense at one end than at the other, where B and B' are the centres of buoyancy and G and G' those of gravity.

But in many cases, when a body is only partially immersed, the centre of gravity may be above that of buoyancy, and yet the action of turning cannot take place, so that a condition of stable equilibrium will be attained under these circumstances. If a flat body, such as a light wooden plank, is placed in water, it will float, and a portion will be above the surface, as



FIG. 13.

FIG. 14.

shown in fig. 13; and therefore, if the centre of gravity is not below the centre of volume, it will be above the centre of buoyancy, and yet the body will be in a state of stable equilibrium. For if it be tipped as represented in fig. 14, the centre of buoyancy will be brought to the position B', on the depressed side of the vertical passing through the centre of gravity, and this will cause the body to return to its former position. But if the body has such a shape that when it is displaced the centre of buoyancy is brought to that side of the vertical passing through the centre of gravity, which is elevated as represented in fig. 15, then the body will turn over. When the body is in the new position, a vertical drawn through the changed position of the centre of buoyancy will intersect the line which in the first position passed vertically through the centre of gravity, and this point of intersection is called the metacentre, represented at M in figs. 15 and 16. When the metacentre is above the centre of gravity, as in fig. 16, the body will tend, by the action of the centre of buoyancy, to return to its former position; but when it is below, as in fig. 15, the action of the centre of buoyancy, being upward on the elevated side, will tend to turn the body over. Its proper place therefore, as its name would indicate, is above the centre of gravity, but it cannot be a fixed point. In all well built ships, however, its position is pretty nearly constant for all inclinations. For example, in fig. 16, as long as increase of inclination of the vessel carried

the centre of buoyancy B to the left, the point M might remain at nearly the same distance from G, because it would also move to the left. But if the inclination of the vessel in the same direction carried the centre of buoyancy



FIG. 15.

FIG. 16.

to the right, the height of the metacentre M would diminish until it would be in G, when the equilibrium would be indifferent, and at last below G, when the ship would turn over. It is desirable to have the metacentre as far as possible above the centre of gravity, and this condition is secured by bringing the centre of gravity to the lowest practicable point, by loading the ship with the heaviest part of the cargo nearest to the keel, or by employing ballast. II. HYDRODYNAMICS, although it embraces many of the principles of hydrostatics, treats more particularly of the laws of liquids in motion. One of the most important principles of hydrodynamics is that which determines the velocity of jets which issue from orifices at various depths in the sides of vessels containing liquids, and depends upon the laws of hydrostatic pressure. If an orifice is made in the side of a vessel containing a liquid, the liquid will issue from it with a velocity equal to that which a heavy body would acquire in falling through the vertical distance between the surface of the liquid and the orifice. If the jet is directed upward, it will ascend, theoretically, to a level with the surface of the liquid; but practically it will fall short of this in consequence of friction at the orifice, and of the resistance offered by the air. At first sight it would appear that the velocity of efflux would be proportional to the pressure, but an analysis of the case, aside from the test of experiment, will show that this cannot be, for in no instance can the jet be projected higher than the surface of the liquid. If, in general terms, the velocity of a jet were in proportion to the pressure at the point of issue, a column of mercury would throw a jet with 13½ times the velocity that an equal column of water would; but it must be perceived that a column of mercury can only propel a jet as high (theoretically) as the surface, and therefore to the same height as an equal column of water can. Now, there can be no doubt that the pressure of mercury at the same depth is 13½ times that of water; but mercury, being also 13½ times as heavy as water, has 13½ times as much inertia, and therefore requires so many times as much force to give it the same initial velocity. The velocity with which a liquid escapes from an orifice varies as the

square root of the depth below the surface; so that when the points of escape are 1, 4, 9, and 16 ft. in depth, the initial velocities will be as 1, 2, 3, and 4. This is the celebrated theorem of Torricelli, which he deduced from the laws of falling bodies. As the velocity of a falling body is in proportion to the time of its fall, it will be in proportion to the square root of the height fallen through, and is represented by the formula  $V = \sqrt{2gh}$ , in which  $g$  is the accelerating force of gravity ( $= 32.2$ ), and  $h$  the height. (See MECHANICS.) A jet issuing from the side of a vessel describes, theoretically, a parabola, precisely as in the case of a solid projectile; for the impelling force and the force of gravity act upon the jet in the same manner, and the resultant force gives it the same direction. The range, or distance to which the jet is projected, is greatest when the angle of elevation is 45°, and is the same for elevations which are equally above or below 45°, as 60° and 30°. The resistance of the air however alters the results, and the statement is only true when the jet is projected into a vacuum. If a vessel filled with water have orifices made in its side at equal distances in a vertical line from the top to the bottom, a stream issuing from an orifice midway between the surface and the bottom will be projected further than any of the streams issuing from the orifices above or below. This may be demonstrated by the adjoining diagram, fig. 17. Let a semicircle AFE be described on the side of a vessel of water, its diameter being equal to the height of the liquid. The range of a jet issuing from either of the orifices B, C, or D will be equal to twice the length of the ordinates BF, CI, or DK respectively; and therefore jets issuing from B and D will meet at a point H on a level with the bottom, and twice the length of the ordinates BF and DK. Now, as the ordinate CI is the great-

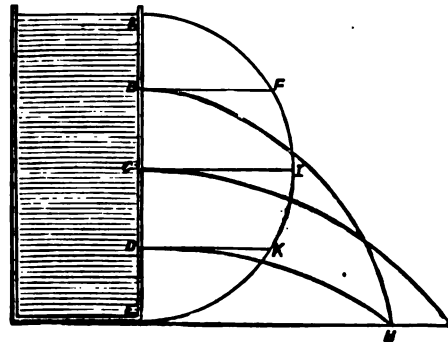

FIG. 17.

est, the range of the jet issuing from C will be greater than that of any other jet. The amount of water escaping in one second from an orifice would, theoretically, be equal to a cylinder having a diameter equal to that of the orifice, and a length equal to the distance

through which a body will move with a uniform velocity after it has fallen through a height equal to the vertical distance between the surface of the liquid and the orifice. If this distance is 16.1 ft., the velocity acquired will be 32.2 ft. per second, and therefore the theoretical quantity discharged from an orifice 4 in. in diameter, whose centre is 16.1 ft. below the surface, would be equal to a cylinder 4 in. in diameter and 32.2 ft. long, and containing 4,828.5 cubic inches, or about 21.83 gallons. The actual discharge from a thin orifice not furnished with an ajutage is however

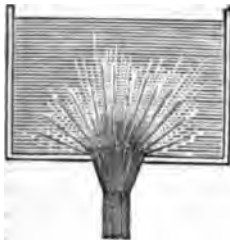

FIG. 18.—Vena Contracta.

much less, being only about two thirds of the theoretical amount. The loss is owing partly to friction, but mainly to the interference of converging currents moving within the vessel toward the orifice. This interference may be shown by employing a glass vessel having a perforation in its bottom, as represented in fig. 18. If particles of some opaque substance having nearly the same specific gravity as water, so that they will remain suspended in it for a space of time, be mingled with the water, they will be seen to move in the direction indicated by the lines in the figure, which are nearly direct. If the jet is carefully observed, it will be seen that it is not cylindrical, and that for a distance from the orifice of about half its diameter it resembles a truncated cone with the base at the orifice. This

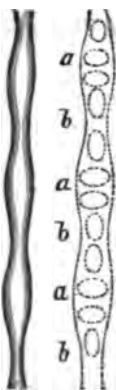

FIG. 19.

contraction of the stream is called the *vena contracta*, and its smallest diameter is stated to be from 0.6 to 0.8 of that of the orifice. When the stream has a direction downward nearly vertical, it continues to diminish beyond the vena contracta, in consequence of the increased velocity caused by the force of gravity, the size being in the inverse proportion to the velocity. The increased velocity at the vena contracta is due to the pressure which forces the particles of water into a narrower channel. As the jet continues to fall, it forms a series of ventral and nodal segments, as shown in fig. 19. The ventral segments are composed of drops elongated horizontally, as shown at *a a*, while the nodal segments are elongated vertically, as seen at *b b*; and as the segments have fixed positions, it follows that the drops in falling are alternately elongated vertically and horizontally. If the orifice is in the side of the

vessel and discharges horizontally, the size of the stream does not diminish in the same manner as when falling vertically, and it is sooner broken. If a cylindrical tube or ajutage whose length is from two to three times its diameter is fitted to the orifice, the rate of efflux may be increased to 80 per cent. of the theoretical amount. The velocity will be somewhat diminished, but the vena contracta will be larger in proportion. If the inner end of the ajutage has a conical shape with the base toward the interior, the efflux may be further increased to 95 per cent.; and it has been found that if the outer end of the tube is also enlarged, the efflux may be still further increased to very nearly the theoretical amount, say 98 per cent. When a cylindrical ajutage is used, there will be a partial vacuum formed between the sides of the tube and the contracted vein, as shown in fig. 20.

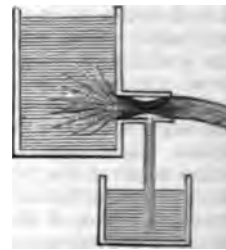

FIG. 20.

If a pipe ascending from a reservoir of water is let into this part of the ajutage, the water will rise in the pipe; and if the height is not too great, the vessel may be emptied.—The resistance offered by conduits is a subject of great importance in practical hydro-mechanics, upon which extended experiments have been made. When the length of the ajutage bears more than a certain proportion to its diameter, the efflux is reduced to about the same amount as when the stream issues through a thin orifice, that is, about 62 per cent. of the theoretical amount. With a pipe of 1½ in. in diameter and 30 ft. long, the efflux will be only about half that from a thin orifice, or 31 per cent. of the theoretical amount. This reduction is caused by friction between the liquid and the tube, as well as between its particles, and is greater with cold than with warm liquids. This resistance to motion, or approach to rigidity, which is conferred by cold, is called *viscosity*, and is a principle which has to be taken into account in nearly all very careful hydraulic calculations.—*Resistance of Liquids to the Motion of Solid Bodies.* This will depend upon the form and size of the body. The following are two important laws: 1. With the same velocity, the resistance is proportional to the extent of surface applied by the solid to the liquid in the direction of motion. 2. With the same extent of surface, the resistance is proportional to the square of the velocity. These laws may be demonstrated experimentally, but their truth will also be apparent from the following considerations. In regard to the first law, it will be easily understood that with the same velocity the amount of water displaced will be the measure of resistance, and that a surface of two square feet will displace twice

as much as one of one square foot. The second law is not so evident, but will be made clear by considering that with a given surface, when the velocity is doubled, twice the quantity of liquid will move through twice the space in the same time, and will therefore, according to the principles of mechanics, have a fourfold momentum. The resistance, therefore, offered to a plane surface moving at right angles against a liquid, is measured by the area of the surface multiplied into the square of the velocity. It has been found that a square foot surface, moved through water with a velocity of 32 ft. per second, meets with a resistance equal to a weight of 1,000 lbs. When the motion of a body in a liquid is very slow, say less than 4 in. per second, depending on the size of the body, the larger body requiring to move more slowly, the above laws are not rigidly followed, but the resistance is divided into two components, one of which is proportional to the simple velocity, and the other to the square of the velocity. The most accurate results in experimenting with slow motions were obtained by Coulomb, who used his torsion balance. One of the most interesting problems in mathematics has been to determine the form of a solid which will meet with the least resistance in moving through water. This form is called the "solid of least resistance," and is approached as near as practicable in the construction of ships.—*Theory of Waves in Liquids.* When a pebble is dropped into still water, a series of circular waves is formed upon its surface, which extend themselves from the centre in all directions. These waves consist of alternate elevations and depressions, which have the appearance of following one another in the direction of the radii of the circle. It is however only an appearance, as may be readily proved by throwing a cork upon the undulating surface, when it will be observed only to rise and fall, and the undulations will appear to glide beneath it. The wave then is an oscillation of the liquid upward and downward, and the force which causes it is gravity. The pebble when it strikes the water displaces a portion, which rises on every side to a certain height, and then, its momentum being lost, and being higher than any portion of liquid around it, it falls; but the momentum it has acquired carries it below the level, and an exterior ring is forced upward, which in descending also produces a successor; and thus a series of circular waves is formed of gradually diminished height but of increased diameter, until, at a very great distance in calm water, the force of the primary impulse is lost. When two waves proceeding from different centres meet one another in such a way that the elevations coincide, a united wave will be produced having a height equal to that of its two components, and a depression equal to that of the other two; but if the elevation of one corresponds to the depression of the other,

the resulting elevation and depression will be equal to the difference of elevation and depression respectively of the original waves. If they are equal, the result will be the obliteration of both. This phenomenon is called the interference of waves. It is susceptible of demonstration that the undulations of waves are performed in the same time as the oscillations of a pendulum whose length is equal to the distance between two eminences, or the technical breadth of the wave.—*Form of Surface of Rotating Liquid.* From the principle of the equilibrium of fluids, that the surface of the liquid at rest must be a level which is perpendicular to the direction of the force of gravity, it follows that when two or more forces act upon a liquid to change the position of its surface, the resultant of these forces will be perpendicular to the surface. Therefore, if a cylindrical or conical vessel, fig. 21, containing a liquid, is rotated on its axis A B, all the particles on the surface will be acted upon by two forces, that of gravity, in a vertical direction represented by A C or C E, and the centrifugal force, represented by C D or E F, which is horizontal, and varies in intensity with the distance of the particles from the axis or centre of motion. The surface of the liquid will therefore be depressed in the middle, and will be at every point perpendicular to the resultants A D, C F, &c., which will therefore be normals; and it may be demonstrated that the subnormals A C, C E, &c., are equal, and therefore that the surface of the liquid is a paraboloid.—*A Level Surface.* Let it be assumed that if the earth were entirely covered with water, and at rest, with no force acting upon the water except gravity, it would have the form of a perfect sphere. But it has been found to have the form of an oblate spheroid, the ratio of its polar to its equatorial diameter being about 299 to 300. Its oblate form is caused by its rotation on its axis. Let *a b c d*, fig. 22, be the section of a liquid sphere, passing through its axis of rotation *a b*, and let *f* be any point on its surface. The revolution of the sphere on its axis will generate a centrifugal force in the direction of *f e*, parallel to the plane of the equator *c d*, and perpendicular to the axis *a b*. Now, if *f h* represent the force of gravity and *f e* the centrifugal force, *f g* will represent the resultant of these two forces, and the surface of the liquid, being free to move, must become perpendicular to this resultant at every point. The surface of a

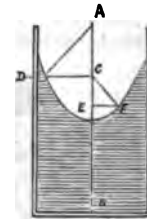

FIG. 21.

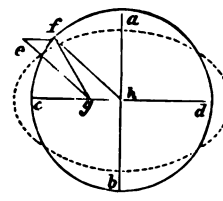

FIG. 22.

revolving body, like the earth, if covered with a liquid, would have a form like that represented in section by the dotted line, and it may be demonstrated that this form is that of a spheroid formed by an ellipse revolving about its minor axis. Its surface, to which that of the earth approaches, is called a level surface.

**HYDROMETER**, or **Aerometer**, an instrument for determining the specific gravity of liquids. It generally consists of some buoyant body, as hollow glass or copper, weighted at the bottom and supporting a graduated stem, or one having a definite mark. There are two kinds, those of constant and those of variable immersion.

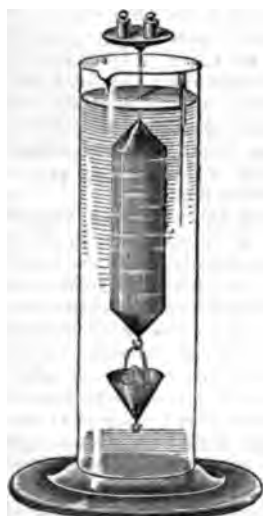

FIG. 1.—Nicholson's Hydrometer.

Those of constant immersion are made to sink in the tested liquid, whether dense or light, to the same depth, by balancing with weights. Those of variable immersion have no movable weights, but rise or fall according to the density of the liquid.

Nicholson's hydrometer, fig. 1, is of the first kind. As usually constructed, when this instrument is immersed in water it requires a weight of 1,000 grains to make it sink to a certain mark on the stem. According to the principle of Archimedes (see HYDROMECHANICS), the weight of the instrument, together with the 1,000 grains which it sustains, is equal to the weight of the volume of water displaced. If the instrument is placed in a liquid lighter or heavier than water, and the weight changed until it sinks to the same depth, the specific gravity of the liquid will be indicated by the formula 
$$g = \frac{W+w}{W+1000},$$
 where  $W$  is the weight of the instrument, and  $w$  that of the weights placed upon the pan. If  $w$  is less than 1,000 grains it will show that the liquid is lighter, and if it is more than 1,000 grains it will show that it is heavier than water. This instrument may also be used to find the specific gravity of solids, or as a delicate balance. For these purposes it has a small cup or wire cage suspended at the bottom to hold the body, which may be either heavier or lighter than water. To find the specific gravity of a solid, let it be first weighed in air, by placing upon the pan a piece of the substance which weighs less than 1,000 grains. Suppose the substance to be sulphur, and that 440 grains are required to be added

to make the instrument sink to the mark of the stem, the weight of the sulphur is, evidently,  $1,000 - 440 = 560$  grains. Now, what it loses if weighed in water will be the weight of an equal bulk of water, and this will be found by placing it in the cup or cage at the bottom, and adding sufficient weights to those in the pan at the top to bring the mark to the level of the water. If it requires the addition of 275.2 grains, that amount will represent the weight of a volume of water equal to the sulphur; consequently the specific gravity of the sulphur will be  $\frac{560}{275.2} = 2.03$ . If the body is lighter than water, it will of course require the addition of more than its weight to the pan, and for immersion it will require to be placed in the wire cage. Fahrenheit's hydrometer differs from Nicholson's in being constructed of glass, and having a constant weight of mercury in a bulb at the lower end. Its use is therefore restricted to the weighing of fluids.—Of hydrometers of variable immersion Baumé's is the one most frequently used, and furnishes a good example of the class. Two instruments, of different forms, are represented in figs. 2 and 3. They are made of glass; their stems are hollow and lighter than the fluid in which they are immersed. Fig. 2 is called a salimeter, and is used for estimating the proportion of a salt or other substance in solution. It is graduated in the following manner: Being immersed in water at a temperature of  $12^{\circ}$  C., the point to which it sinks is marked  $0^{\circ}$ ; it is then placed in a solution containing 15 parts of common salt to 85 of water, the density of which is about 1.114, and the point to which it sinks is marked 15, and the interval divided into 15 equal parts;

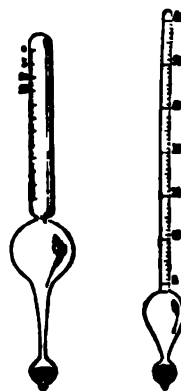

FIG. 2.

Salimeter.



FIG. 3.

Alcohohometer.

Baumé's Hydrometers.

the graduation is then extended downward, generally terminating at  $66^{\circ}$ , which corresponds to the density of sulphuric acid. When the instrument is to be used for liquids lighter than water, the zero is not placed at the point to which it sinks in pure water, but at a point to which it sinks in a solution containing 10 parts of common salt to 90 of water. The point to which it sinks in pure water was marked by Baumé  $10^{\circ}$ , and the graduation was continued upward to the highest point to which the stem might be immersed in the lightest liquid. Fig. 3 represents the instrument for liquids lighter than water. The graduation of these hydrometers is arbitrary, and is an indication of the strength of the liquid only after trial.—Hare's hydrometer, 1

very valuable instrument, but one which has not been much employed, acts upon the principle of the barometer, and yields directly results of definite comparison; it is represented in fig. 4. A  $\Omega$ -shaped tube has its legs, of equal length, placed in shallow vessels, one containing the liquid to be tested, and the other a liquid taken as a standard, as water. A partial vacuum is then produced in the tube by exhausting the air by means of an air pump, the mouth, or otherwise, making use of the stop-cock to facilitate the operation. It is evident that the height of the liquid column will be in the exact inverse proportion to the specific gravity of the liquids.—Hydrometers have various names, according to the purpose for which they are used: as lactometers, for estimating the amount of cream in milk, or the quantity of sugar of milk in the whey; vinometers, for estimating the percentage of alcohol in wine or cider; and there are acidimeters and saccharometers.

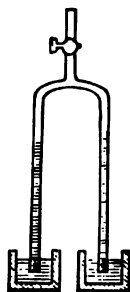

FIG. 4.—Hare's Hydrometer.

**HYDROPATHY** (Gr. *ὕδωρ*, water, and *πάθος*, affection or disease), a system of treatment of diseases mainly or exclusively by the use of water and of the known hygienic agencies. Hygienic management in some form, as a resort to exercise, or, in diseases induced by luxurious living, to abstemiousness, dates from the earliest conception of a healing art; and it has kept pace with the growth of physiological science, until within the present century the laws and claims of hygiene have become appreciated as never before. The physicians of very early times seem also to have employed water as a remedy in certain febrile, inflammatory, and surgical maladies; a usage recommended, among other early medical writers, by Hippocrates, Galen, and Avicenna. In the 17th century Sir John Floyer and Dr. Baynard, in England, resorted to bathing almost exclusively in chronic diseases; as did F. Hoffmann and Hahn on the continent. Dr. James Currie in 1797 published highly favorable reports of the effects of water, chiefly by affusion, in many diseases. But the distinctive "water cure," or hydrophaty, owes its origin to the fertility of invention of a Silesian peasant, Vincenz Priessnitz. Having at the age of 13 sprained his wrist, young Priessnitz intuitively applied it to the pump; and afterward, to continue the relief thus obtained, he bound upon it an *Umschlag*, or wet bandage. Rewetting this as it became dry, he reduced the inflammation, but excited a rash on the surface of the part. Soon after, having crushed his thumb, he again applied the bandage, and the pain once more subsided, but the rash reappeared. He inferred that the rash indicated an impure blood; and this conclusion was

strengthened by the result of experiments which he was induced to try upon injuries and ulcers in the case of some of his neighbors, since the rash in some instances appeared after the treatment, and in others did not. Thus he was led to frame for himself a humoral pathology of all diseases, and a doctrine of the elimination of morbid matters by "crisis." According to this view, the cure of disease is to be effected by favoring the activity of those organs through which the purification of the system is carried on, and, through a regulated and pure dietary and correct regimen, preventing further morbid accumulations. In his 19th year, being run over by a cart, Priessnitz had some ribs broken and received severe bruises; on learning that the physicians pronounced his case hopeless, he tore off their bandages, and recovered under the renewed application of the *Umschlag*, and replaced his ribs by inflating the lungs while pressing the abdomen against a window sill. This incident confirmed the idea and initiated the practice of the water cure. In the new practice, its author discovered in rapid succession the means of securing either cooling, heating, or soothing effects by compresses; then, the sponge bath, the wet-sheet packing, the sitz, foot, arm, and other partial baths, the douche, the stream bath, the dripping sheet, the plunge, the tepid shallow bath, dry-blanket packing, &c. The pail douche of Dr. E. Johnson is one of the very few additions since made to this list of measures. Unquestionably, Priessnitz's earlier treatment, especially after the opening in 1826 of the famous Gräfenberg cure, was too incessant and severe, and often borne only through the vital tenacity, whatever their maladies, of the class of invalids with whom he had to deal. Along with this was introduced a rigorous, but in some respects mistaken hygiene, including the very free use of a plain and peculiar diet, much walking in the open air, and the disuse of flannel undergarments and of soft beds. The water appliances have since been rendered more mild, and in the United States necessarily so. The number of instances, however, of decided restoration to health among the invalids who flocked from all parts of Europe and of the United States to the Gräfenberg cure, sufficiently explains the rapid spread of the new system. This was first distinctly brought to the notice of the English public about the year 1840, by a book put forth by a former patient of Priessnitz, Capt. Claridge, and entitled "Hydrophaty, or the Cold Water Cure." In Germany, under Francke, Weiss, Munde, and others, the enthusiastic treatise of the first of whom did much to spread the system, several new establishments had already sprung up. On March 17, 1842, the hydrophatic society was organized in London, for the purpose, among others, of circulating information in regard to Priessnitz, and the authenticity of the reported cures. Drs. Wilson, Johnson, and Gully were first to em-



brace the practice, the first two early lecturing before the new society, and all soon establishing institutions of their own. The writings of Drs. Gully and Johnson contributed much to spread the system in England, and at a later day they were ably seconded by Bulwer's "Confessions of a Water Patient," detailing incidents of his restoration to health at the Malvern establishment. The earliest popular information concerning water treatment in the United States was through a letter published about 1843, from H. C. Wright, himself at the time a patient under Priessnitz; and this was soon followed by the earnest statements and appeals, through a like channel, of J. H. Gray of Boston and A. J. Colvin of Albany. Drs. Schieferdecker, Wesselhoeft, and Shew seem to have been the first to enter upon the new practice in the United States; while the first establishment appears to have been that opened in 1844 at No. 63 Barclay street, New York. Of this, David Cambell, also the originator of the "Water-Cure Journal," was proprietor, and Joel Shew physician. In May, 1845, an establishment was opened at New Lebanon Springs, N. Y., under the management of Dr. Shew, and another at Brattleboro, Vt., under the management of Dr. Wesselhoeft, who, having explored the country from Florida to Maine, selected Brattleboro on account of the superior purity of the water of a spring there. At the present time there are in this country and Europe several hundred establishments in which the application of water in one form or another is the chief remedial agent relied upon in the treatment of diseases, but medicines in many cases are used to a greater or less extent. The name hydrophobia is not in general use among its practitioners, that of "hygienic medicine" being adopted instead.—Of books upon the subject may be mentioned, besides those above referred to, "Hydrophobic Encyclopædia," by R. T. Trall, M. D. (New York, 1852); "The Bath," by S. R. Wells (New York); and "Water Cure in Chronic Diseases," by J. M. Gully, M. D. (London).

**HYDROPHOBIA** (Gr. *ὕδωρ*, water, and *φόβος*, fear; Lat. *rabies canina*, canine madness), a rare but well marked disease in the human subject, characterized by excessive nervous excitement, the secretion of an unusually viscid saliva, a difficulty and sometimes a dread of swallowing liquids, and a rapidly fatal termination. It is caused by inoculation from the bite of a dog, already in a similar rabid condition. Although hydrophobia in the human subject is so infrequent that many practitioners of considerable experience have never met with a case, it is still of sufficient importance to merit serious attention, and to demand every possible precaution for its prevention; particularly since, when once developed, it is invariably fatal, no single well authenticated case of recovery having yet been recorded, and because the affection itself is so terrible in the distress suffered by the patient, and the horror

which it excites in the minds of the spectators. In France, with a population of 36,000,000, during the six years from 1858 to 1863 inclusive, there were 107 cases of hydrophobia, or one case annually for every 2,000,000 inhabitants. In the department of the Seine, average population of upward of 1,000,000, during the 40 years from 1822 to 1862, there were 94 cases, or a little more than 2½ per cent. The greater proportional frequency of the disease in the metropolis and its vicinity is no doubt due to the greater concentration of the population, both human and canine, which would of course be favorable to communication from one animal to another from animals to man. In the city of New York, with a population of 1,000,000, during the six years from 1866 to 1871 inclusive, there were 22 cases, or an average of 3½ per cent.—When a man is bitten by a rabid dog, the wound does not differ in any visible character from that inflicted by a healthy animal, seldom severe and often slight, the animal frequently making only a single momentary attack. The wound thus made heals with difficulty, and is not especially painful or otherwise troublesome. In a majority of instances no further trouble comes of it. The virus from the bite of a rabid dog consists in the inoculation of the animal's saliva, which contains a subtle but communicable poison. But there are various circumstances which may interfere with the poison's effect. First, the individual may be, either before or at the time, unsusceptible to its action, or may be so in reason to believe that the human system as a whole are decidedly less susceptible to the poison of hydrophobia than dogs; and secondly, according to the experiments of M. Renault at the veterinary school of Alfort, the proposed virus, when bitten by a rabid animal afterward become rabid, is not more than 10 per cent. Secondly, when the bite is upon parts of the body covered with hair, the saliva, which is the only vehicle of the poison, may have been arrested by the hair, and may not have come in contact with the wound at all. Thirdly, the poison may have been extracted from the wound immediately afterward by the free discharge of the wound, or by the instinctive manipulations of the wounded person, or may have been neutralized by surgical appliances. At all events, the statistics seem to show conclusively that the bite of a rabid animal by no means invariably produces hydrophobia. M. Bouley, professor in the veterinary school at Alfort, estimates that in the department of the Seine no fewer than 25 dogs annually become rabid. In 25 years of hydrophobia recorded at Alfort in France, from 1861, 10 of these animals were known to have bitten 15 persons; that is, 15 bites were inflicted by 25 rabid dogs. This would be equivalent for 100 dogs annually affected by hydrophobia, 60 persons bitten during the same time.

there are only from two to three cases of death from this disease annually in the department of the Seine; and, according to these results, not more than 3 in 60, or 5 per cent. of the persons bitten by rabid dogs, afterward become hydrophobic. But even this proportion of cases constitutes a terrible danger, considering the nature of the disease with which the individual is threatened.—For some time after the infliction of the wound no symptom manifests itself. The poison may have found its way into the tissues, but it is quiescent, and it remains so usually for several weeks. The exact period during which it may thus lie dormant, and afterward become fully developed, undoubtedly varies in different cases. Instances have been related in which hydrophobia has declared itself after an interval of several years, but these statements are evidently wanting in authenticity, and are almost universally regarded as extremely doubtful. It seems positive, however, that the period of quiescence may be extended to one year, and possibly to 17 or 18 months. Nevertheless these instances, if they exist, are very rare exceptions; and in the immense majority of cases the disease shows itself, if at all, between the end of the first and the end of the third month; so that after the lapse of three months from the date of the injury, the chances of escape increase rapidly with every succeeding week. By the end of six months the patient may be pronounced practically safe. When, however, the disease is to show itself, usually during the second or third month, its first manifestation is a sense of itching or discomfort at the seat of the wound. The cicatrix may become swollen and reddened, and a red line, following the course of the lymphatic vessels, is said to appear upon the limb, between the cicatrix and the trunk. This is the preliminary period of the disease, and may last for two or three days, rarely more than six, during which the patient is only slightly uncomfortable. Then the unmistakable signs of hydrophobia come on with great rapidity, and are aggravated from hour to hour. There is a feeling of stiffness about the neck, extending to the jaw and the base of the tongue. An insupportable anxiety and agitation of mind takes possession of the patient, often accompanied with paroxysms of momentary delirium and hallucinations. The breathing is hurried and irregular. There is great thirst; but there is also a difficulty of deglutition, apparently consisting in an irresistible spasm of the pharynx or glottis, which is so distressing that the patient sometimes rejects fluids after vainly attempting to swallow them, with violent demonstrations of irritation and despair. This is what has given rise to the idea that the patient dreads the liquid itself, and has unfortunately attached the name hydrophobia to the disease in question. The saliva becomes remarkably viscid and tenacious, and appears to add much to the distress of the patient, who endeavors constantly to detach it and expel it

from his mouth. This condition of nervous irritation rapidly exhausts the strength of the system, and death takes place, usually on the second or third day.—Such are the symptoms and course of hydrophobia in man. The treatment includes only a single measure, but this must be adopted at once on the receipt of the injury, and must be carried out in the most thorough manner. It consists in neutralizing the poison by cauterization of the wound. Some authorities recommend first cutting out the wound by an incision passing all round it through the sound flesh, and subsequently cauterizing the fresh surface. The objection to the procedure is that it requires some time and skill to perform it thoroughly, particularly as the wound is generally narrow and deep; and also that if the knife or the blood happen to penetrate the wound itself, they may become themselves contaminated with the virus and thus bring it in contact with a new and larger surface. It seems desirable to cauterize thoroughly the original wound without delay. Then, if thought proper, the eschar may be cut out, and the caustic again applied to the fresh surface of the new wound. On the whole, the particular caustic which is recommended by the highest authorities for this purpose is a solid stick of nitrate of silver. Its advantages are: 1, that it can almost always be readily procured; 2, that it can easily be cut into a form adapted to penetrate to the bottom of a deep and narrow wound; 3, that it readily dissolves in the animal fluids, and, when held for a few minutes in contact with the tissues, forms a tolerably deep and firm eschar, and coagulates thoroughly all the organic matters which may be present. It has been thought that during the period of quiescence the virus remains localized in the original cicatrix, and does not begin to disseminate itself through the system until the appearance of signs of irritation in the part. If this be so, it would of course be highly proper to cut out the cicatrix and cauterize the wound, in cases where this operation had not already been performed at any time between the receipt of the injury and the first manifestations of the disease.—But for the protection of the community from hydrophobia, the prevention of the bite of a rabid animal is much more important than its treatment. Any well educated surgeon, if within reach and called in time, will apply the proper remedies after the wound is inflicted. But he may not be applied to in season. The animal may not be suspected of rabies at the time of the injury; and even if everything be done for the sufferer which circumstances permit, he must still pass through several weeks or months of anxious uncertainty, until the extreme limit of possible incubation has been reached. The most important thing, in every point of view, is to diminish as far as possible the chance of a bite being inflicted at all; and by far the best means of accomplishing this object is to put the public on their guard by

an accurate knowledge of the symptoms of hydrophobia in the dog. The great danger at present consists in the fact that these symptoms are not usually recognized until after a wound has been inflicted; and animals may thus propagate the disease among their own species and communicate it to man at a time when they are not themselves known to be hydrophobic. There are three capital errors, commonly entertained by the public in this respect, which add very much to the danger spoken of: 1, that the mad dog has a horror of water and will not drink; 2, that he is liable to the disease more especially or exclusively in hot weather; and 3, that he always manifests a ferocious and aggressive disposition. Neither of these things is true; and the consequence is that a dog in cool weather, who is seen to drink freely, and is not especially ferocious, is looked upon without suspicion and treated with familiarity; and yet he may be hydrophobic and capable of inflicting a mortal wound, or of communicating a fatal disease by licking an abraded spot upon the hand of his master. It is evident, therefore, that it is of the greatest consequence that the true signs of canine hydrophobia should be recognized at an early period; for as soon as a dog is known to be rabid, there is but little danger of his being allowed to bite. Rabies in the dog may occur at any season, and is not more likely to show itself in warm than in cool weather. Consequently all police regulations intended to suppress or exterminate hydrophobia, which are enforced in the summer months and suspended at other times, fail of their object, and may even do harm by inducing a fancied security during the cool season. According to the observations made by Prof. Rey at the veterinary school of Lyons, in France, the number of cases in that district was greater during the rainy than during the dry months. Of 190 cases recorded at the veterinary school of Alfort, during the ten years from 1853 to 1863, the following list shows the aggregate numbers in each month of the year, arranged in the order of their frequency: In April, 25; March, 21; January, 20; June, 18; May, 16; August, 16; September, 16; November, 14; July, 12; December, 12; February, 10; October, 10; total, 190. The first symptoms of hydrophobia in the dog, as described by Youatt and Bouley, consist in a gloomy and sombre disposition, together with a nervous agitation and disquietude, which is betrayed by frequent changes of position. The animal, usually cheerful and desirous of companionship, seeks to avoid his master or his playmates. He skulks into his kennel, into a closet, into the corners of the enclosure, underneath pieces of furniture, and endeavors to escape notice. If called out, he obeys, but slowly and unwillingly, and as soon as possible again betakes himself to his retreat. In a few minutes he is dissatisfied with it, and leaves it for another. Then he goes back to his litter, and takes it apart or arranges it in a

variety of ways, without being able to do so himself with any. The expression of his face is suspicious and uneasy; and in a few days he is again wandering from place to place. Now these signs, when taken singly, are not decisive indications of rabies. It is not until the dog, when suffering under almost any temporary illness, to withdraw himself from observation, and seek a retreat in some dark corner; but he generally remains there quiet until he begins to recover. It is this combination of symptoms, avoid observation, combined with an increase of restlessness, which is peculiar to canine hydrophobia; and whenever an animal exhibits these two symptoms together, moving continually from place to place, and searching every corner as if looking for something which he never finds, he should at once be under a deep suspicion, and properly watched until he has either disappeared or becomes decidedly pronounced. The next sign of hydrophobia is that the animal has slight and frequent attacks of hallucination. He thinks he hears a sound or sees an object which does not exist. This condition is fully recognized by many experts, although its signs are often overlooked by others. The dog suddenly starts up his ears and runs to a particular spot where he had heard a noise on the other side of a door or partition. Sometimes he will run into the empty air, as if he were catching something. Sometimes he will stand immovable and attentive for a few moments, as if he were listening or watching for something which is only in his imagination. These signs are exceedingly important and should redouble the vigilance of the person having charge of the animal, who should at this moment be kept in a position to prevent his doing an injury. All this time the dog may show no disposition to bite. A dog's tendency varies in this tendency according to his individual character. The evidence of the best observers shows that a dog, who is usually good-tempered and mild in disposition, sometimes refrains from biting until very late in the disease. Furthermore, the dog will often show no tendency to bite his master, for whom he still retains his natural affection, but may at the same time be easily provoked by a stranger. This circumstance forms one of the most insidious sources of danger in the case of a rabid dog not yet known to be so. Even the master may be misled by finding the animal submissive as usual to his will, even to a slight correction, while a sudden blow or a threatening gesture may be followed by a sudden and ungovernable attack on the part of the animal, and the infliction of a mortal wound. During all this period, further and also during the entire course of the disease, and also during the entire course of the disease, there is no hydrophobia in the dog in the sense of the word. The rabid dog has no horror of water, and he does not refuse to drink. On the contrary, he drinks frequently. When the disease being fully established, the constriction of the fauces renders de

difficult, he no less endeavors to satisfy his thirst, sometimes by plunging his muzzle deeply under the surface of the water. No single error in regard to the disease is more unfortunate than this; for when a dog drinks, the bystanders conclude that he is not hydrophobic, and consequently overlook the other symptoms which might indicate the nature of the malady. The rabid dog does not at first refuse his natural food, but soon ceases to take it with his accustomed relish. An important sign, however, is an unnatural or depraved appetite. The animal gnaws and even swallows all kinds of indigestible substances. Pieces of wood, bits of stone, furniture, clothing, the stuffing of cushions, leather, horse dung, and even his own excrements, are torn, gnawed, and swallowed. This is always a very suspicious circumstance. Some dogs are habitually mischievous in this respect, but even they only injure or destroy these substances; they do not swallow them. And particularly the disposition in question, manifesting itself in an animal to whom it is not habitual, and who is also evidently sick from some cause or other, should always put his owners upon their guard. Another symptom is now to be spoken of which is decisive and pathognomonic, namely, the rabid bark. It is difficult to give an accurate idea of this sound by mere verbal description; but the best authorities all agree that, when once recognized, it is entirely conclusive. The natural voice of the animal is altered. Instead of the usual succession of explosive sounds, equal in intensity and duration, it is hoarse, veiled, lower in tone, and begins with a single open bark, followed immediately by three or four diminishing howls from the bottom of the throat, during which the jaws, instead of closing completely at each bark, are only partly approximated to each other. Prof. Bouley says that both he and his pupils have been able to recognize distinctly the rabid dog by his bark alone, when the animal was not yet in sight, and was still at the other extremity of the courtyard of the Alfort veterinary school. The saliva is at first increased in abundance; but this symptom is of short duration, lasting, according to Youatt, not more than 12 hours, and is never so abundant as in the profuse salivation which attends an attack of epilepsy, a malady very common in dogs, but perfectly harmless. The true salivation of hydrophobia consists in a secretion of saliva which is scanty, but viscid andropy, and which the animal endeavors to clear away from the mouth by the aid of his paws. This often gives the idea that he is annoyed by a bone accidentally lodged in his teeth; and fatal accidents have happened from attempting to aid the animal to get rid of the supposed annoyance. This preliminary period of the disease may last for one or two days. Now, however, comes the second and fully developed stage of the disorder, characterized by sudden paroxysms of fury, the true rabies

or canine madness. A very characteristic and important fact is that an animal in this condition is especially excited by the appearance of one of his own species. The sight of another dog drives him into an excess of sudden and immeasurable fury, followed by an immediate and aggressive attack. This often happens while he is still inoffensive toward other animals, and particularly toward his master. But it is a sign that the full development of his disorder is at hand, and in an hour or two afterward he may snap at every bystander indiscriminately, in the blind insanity of his excitement. At this time, or even at an earlier period, he often disappears from home, probably with the instinct of finding some more solitary place in which to hide. But meeting constantly with new sources of irritation, and his nervous excitability increasing at the same time, he becomes more furious, haggard, and threatening with every hour. He is now at the height of the disease. Wandering along the streets or open highways, with head and tail drooping, his hide disordered and dusty, theropy saliva hanging in strings from his open jaws, every man and animal that he encounters provokes him to a fresh attack. After 24 or 36 hours of this continuous excitement, without food or rest, and incessantly upon his feet, exhaustion begins to come on; his motions are less vigorous, his steps grow vacillating and irregular, and he no longer leaves the direct path, and offers violence only to those whom he unavoidably meets. At last, if not pursued and killed, a general paralysis takes possession of his system, and he dies exhausted by the intensity and continuance of the nervous agitation. The entire duration of the malady in the dog, from the first signs of disordered health until its fatal termination, is from two to six days. No distinct morbid change in any of the internal organs has ever been found after death, either in the dog or in man, which could be regarded as the pathological cause of this singular disease. Finally, the important symptoms of commencing hydrophobia in the dog, which should always be borne in mind, may be summed up as follows: 1, an unaccustomed gloomy and suspicious disposition, with nervous agitation and restlessness; 2, momentary attacks of hallucination both as to sights and sounds; 3, an unnatural and depraved appetite for indigestible or innutritious substances; 4, a peculiar and unnatural bark; 5, a ropy and viscid condition of the saliva, with dryness of the mouth and fauces; and 6, an insane and aggressive irritability of temper, most easily excited by the sight of other dogs, and at first manifested only toward them.—The best accounts of hydrophobia are to be found in the chapter on "Hydrophobia" in Gross's "System of Surgery" (Philadelphia, 1866); the chapter on "Rabies" in Youatt "On the Dog" (London, 1859); and Bouley, *Rapport sur la rage* (Paris, 1863).

**HYDROSTATICS.** See HYDROMECHANICS.

**HYDROSULPHURIC ACID, Sulphydric Acid, or Sulphuretted Hydrogen,** a gaseous compound first examined by Scheele in 1777; symbol,  $H_2S$ ; chemical equivalent, 34. It consists of two volumes of hydrogen and one of sulphur vapor condensed into two volumes, which form its combining measure. Its density is 1191.2, air being 1000. It is a colorless gas, has a slight acid reaction, and a most offensive odor, recognized in rotten eggs, dock mud, cesspools, many mineral waters, and putrefying organic matters containing sulphur. It extinguishes flame, but burns itself in contact with air with a blue flame, depositing sulphur. It is condensed by a pressure of 17 atmospheres at  $50^\circ$  into a colorless liquid, and was solidified by Faraday by cooling to  $-122^\circ$  into a white crystalline translucent substance. Water absorbs  $2\frac{1}{2}$  times its volume of the gas; alcohol 6 volumes. It blackens the salts of lead and of many other metals, forming sulphides of the metals. These being insoluble and made readily visible by their peculiar colors, even in minute quantity, the acid is a convenient test for determining the presence of the metals in solutions, and distinguishing them by the color of the precipitate and its other properties. Its aqueous solution and its solution in ammonia (hydrosulphide of ammonium) are among the useful chemical reagents. The gas is exceedingly noxious to inhale. Thénard found that a small bird would die in air containing  $\frac{1}{375}$  part of it, and a horse in air that contained  $\frac{1}{175}$  of it. The gas is neutralized and decomposed by chlorine and iodine, which unite with its hydrogen; and the former, furnished by chloride of lime wet with strong vinegar, is a convenient antidote and disinfectant of the gas. Nitrate of lead, chloride of zinc, sulphate of iron, and sulphate of manganese are also efficacious in this respect. The presence of the gas is detected by its odor, and by its blackening a paper wet with a solution of acetate of lead. It is the cause of the discoloration of white lead paint in the apartments of houses, also of the blackening of silver spoons when these are used with boiled eggs, the albumen of the white of the egg furnishing the sulphur for the production of the gas.—To prepare hydrosulphuric acid, the ingredients employed are a ferrous sulphide, made by exposing to a low red heat 4 parts of coarse sulphur and 7 of iron filings, and diluted sulphuric acid. By pouring the acid upon broken lumps of the compound in a gas bottle, the gas is evolved, and may be collected in a bell glass over water at  $80^\circ$  or  $90^\circ$ , or over brine. It is absorbed by cold water. It may also be obtained by the action of hydrochloric acid upon antimonious sulphide. The reactions in each case are thus expressed:  $FeS + H_2SO_4 = FeSO_4 + H_2S$ .  $Sb_2S_3 + (HCl)_4 = (SbCl)_3 + (H_2S)_3$ .

**HYDRUNTUM.** See OTRANTO.

**HYÈRES,** a town of France, in the department of Var, on the S. declivity of a hill, 9 m. E. of Toulon, and 3 m. from the Mediterranean;

pop. in 1866, 10,878. The principal are the old church, one of the most structures in France, and an ancient c now used as a town hall. In the p square is a column, surmounted by a marble bust of the celebrated Massillo was a native of the town. Hyères is ered one of the healthiest winter reside the south of France, and is much reso by invalids. Remains of an ancient city exist in its vicinity. In the roadst posite the town, and belonging to it, is of small islands called the isles of Hyè cient *Stachades*), two of which are f During the middle ages the place was Hiedera, and was a favorite port of the p to Jerusalem.

**HYGIEA, or Hygea,** in Greek mytholog goddess of health, a daughter of *Æsc* She was represented by artists as a vi flowing garments feeding a serpent from the poets speak of her as a smiling g with bright glances, and a favorite of . By the Romans she was in time identif the old Sabine goddess Salus.

**HYGIENE** (Gr. *ὑγιεινός*, healthy), the and art of preserving health, by the priate nourishment of the body and the regulation of its surrounding conditions first subject of importance in a hygieni of view is always the location or ra of the individual, family, or community interests are involved. Other conditio be altered or modified with comparative ness, but the place and character of th tation, when once fixed, usually remain a considerable time, and thus exert tinued influence for good or evil. Th tation, when in the country, should be placed upon such an elevation as to a thorough natural drainage. This is t requisite; for there is no other single c disease so hurtful and insidious as the s cumulation and stagnation of the refu ters, in however small quantity, whi daily produced in and about an occupie tation. Even standing pools, or hollow without an outlet, the result of a dep in the surface of the ground, should allowed in the immediate neighborhood house; for although it is only the rair which at first collects in them, yet t always more or less accumulation of matter from vegetable growth and fr aquatic animals and birds which mak places their resort; and as a pool of t is alternately filled and dried up, son several times a year, the effluvia exhale this process will always become more injurious, and may be even dangerous. When a large number of inhabitants s lected within a small space, as in tow cities, the question of drainage beco course still more important. The pro of refuse materials is here exceedingly and corresponding provision should b

for their immediate and complete removal. Besides the necessary provisions for drainage, the house and apartments should also be fully and completely ventilated. Effluvia and organic vapors of various kinds necessarily become developed in every occupied dwelling, from the daily culinary operations and the organic matters of the food and their remains. These effluvia are harmless when fresh; but they are subject to early decomposition, and at once become noxious if allowed to accumulate and stagnate. Every house, accordingly, should be swept throughout each day by a current of fresh air, sufficient to renovate its atmosphere and remove all vestiges of impurity. A free opening of the windows on opposite sides, early in the morning, is the best way of accomplishing this. In addition, each inhabited apartment should be constantly ventilated in such a manner as to remove the carbonic acid and other products of respiration, by open fires or other effectual means.—Proper clothing, adapted to the season and the degree of individual exposure, is also an important element of hygiene. There are few causes of disease more prolific than undue exposure to cold and dampness, and particularly to sudden changes of weather or draughts of cold air upon unprotected parts. The clothing should be so regulated, as a general thing, that the ordinary vicissitudes of the weather shall not be felt by the individual in such a way as to make a permanent impression upon the system. A sufficient suit of woollen underclothing is the best protection in this respect. It is important to remember, however, that for a person in health exposure to cold and dampness is seldom injurious so long as the body is in a state of muscular activity. It is remaining in a cold apartment in an inactive condition, or keeping on the wet or damp clothing after muscular exertion has ceased, that gives rise to dangerous consequences.—The quality and quantity of the food, and the regularity with which it is taken, are of the next importance in a hygienic point of view. The food, as a rule, should be simple in character, but nutritious, and each article of the best possible quality and properly cooked. An imperfect or careless mode of cooking may often injure materially the nutritious and digestible qualities of an article of food, originally of the best kind. Individual peculiarities are to be consulted in regard to the kind of food used by each person; certain articles being sometimes more or less indigestible for one person, which are quite harmless for another. The natural and healthy appetite is the best general criterion in regard to the quantity of food to be used, provided it be simple and nutritious in character. It is of great importance, finally, that the food be taken with regularity at the accustomed time, that it be properly masticated, and that its digestion be not interfered with by hurry, anxiety, or any unusual mental or physical disturbance at and immediately after the time of

meals.—A regular and sufficient bodily exercise should be taken every day to keep all the organs in a healthy state of activity. The exercise should be neither deficient nor excessive in amount; for bodily exertion which is so violent or so prolonged as to produce a sense of exhaustion and fatigue, instead of being beneficial to the system, is positively injurious to it. Neither can a deficiency of muscular exertion during one period be compensated by an excessive amount taken at another. It is the necessary and appropriate quantity of exercise, taken regularly day by day, which preserves the vigor of the system, and keeps it in a condition to resist the attacks of disease. The periods of exertion, furthermore, should alternate daily with periods of repose; and especially the natural amount of sleep should always be taken with regularity, and in apartments which are not too confined and the ventilation of which is properly provided for. It is during sleep that the main process of the nutrition and restoration of the nervous and muscular systems takes place; and if an individual deprive himself of sleep, wholly or even partially, for one or two nights in succession, he will invariably experience its damaging effects in the consequent temporary failure of the vital powers. An imprudence or neglect, like either of those mentioned above, may be counteracted in a strong and healthy person by subsequent care, so that he may recover from its immediate and more perceptible effects; but it is a principle which lies at the basis of hygiene, that causes of disease, however slight, by constant repetition day after day, or even at longer intervals, will certainly at last undermine the health, and produce a permanent and often irremediable injury. The easiest as well as the surest way of avoiding such a result is a constant and regular attention to all the necessary hygienic conditions. (See ALIMENT, BATH, DIETETICS, and GYMNASTICS.)

**HYGROMETRY** (Gr. *ὑγρός*, moist, and *μέτρον*, measure), the method of determining the amount of moisture in bodies, more especially in atmospheric air. A hygrometer is an instrument used for this purpose; and a hygroscopic is any substance that absorbs moisture from the air, and is in consequence changed in form or weight. Various salts absorb moisture and deliquesce, and are consequently called hygroscopic. These serve as hygrometers in chemical analysis; thus chloride of calcium placed in a glass tube absorbs the moisture from the air passed through the tube, and its increase of weight determines the quantity. The property is exhibited in hemp and cotton ropes, and in small fibres, as those of whalebone, and in hairs. Paper by absorption of moisture expands to such a degree that it is an imperfect material for preserving accurate plans. Its variation in length in extremely dry and in moist air sometimes exceeds 1 in 40. If a substance could be found which absorbed moisture in proportion to the quantity

in the air, and its form was proportionally affected thereby, this change could be readily indicated upon a dial, the extreme points of which are determined, the one by the least length produced by the greatest dryness, and the other by the greatest elongation caused by the most humid air that could be produced, the intermediate space being divided into 100 or other convenient number of degrees. Such an instrument would be a perfect hygrometer; but no such substance is known, and the properties of the same body in this respect are not constant at all times. The best instrument of this sort, which is after all only a hygroscopic, was contrived by De Saussure. It is a human hair, cleansed by boiling in alkaline water. The zero point of the scale to which it is attached is fixed by drying the hair in air rendered by chemical absorbents as dry as possible; and then, by exposing it in a receiver to air saturated with moisture, the other extreme of the scale is found. The equal divisions between these are assumed to indicate proportional degrees of moisture or dryness. One end of the hair is fixed, and to the other is suspended a small weight. A grooved wheel or pulley carrying an index is placed so as to be moved by the hair as it contracts or expands. Various other hygrometers of this class have been devised, some on the principle of determining the moisture by the increased weight imparted to bodies by its absorption, and others by the torsion thereby induced in cords and in vegetable fibres; but all these methods have proved very imperfect.—Two other methods are to be noticed by which the humidity of the air is ascertained. The first depends on the determination of the dew point, or the degree of temperature to which the air must be reduced that its moisture shall begin to separate and condense upon cold surfaces. This difference alone is sometimes used to express the dryness of the air, as affording an indication of how near it is to its point of saturation. In temperate regions this sometimes amounts to 30°; but in a dry and hot climate, under the lee of cold mountains which first strip the air of its moisture, it amounts to 60° or more; such is the case upon the hot plains of the Deccan, to which the air is brought from the other side of the Ghauts. Cooled down upon these to a low temperature, its moisture is precipitated in rain and snow, and when immediately after this it is raised to a temperature of 90°, it is found that no deposition of moisture again takes place until the temperature is reduced to 29°. The observation, however, is used to furnish more exact results. Tables have been prepared with the utmost care which give the elastic force of aqueous vapor at different degrees and even tenths of degrees of temperature, expressed in the height of a column of mercury sustained by the vapor. The temperature of the dew point of the air being ascertained, the elastic force corresponding to this temperature in the table represents the absolute humidity

of the air, and may be converted into actual weight of moisture to the cubic foot a given barometric pressure by the table prepared for this purpose, or directly tables constructed to reduce the labor calculation. By comparing the elasticity obtained from the table with that corresponding to the temperature of the air its ratio between the two expresses the humidity of the air. This also is ascertainable at sight by the tables specially constructed for this object. The most highly approved metrical tables are those derived from the experiments of Regnault, made by direction of the French government to determine the expansive force of steam at different temperatures, which is also that of the vapor suspended in the air at the same temperatures. Tables are published in Regnault's *Étude l'hygrométrie*, in the *Annales de chimie physique* (1845); and formulas also are from which other tables, besides that of elastic forces, have been prepared by the most complete series of these is furnished in the volume of "Tables, Meteorological Physical," prepared for the Smithsonian Institution by Arnold Guyot, and published in the "Smithsonian Miscellaneous Collections." In the same series is also presented the tables of elastic forces of vapor deduced from the experiments of Dalton, together with other tables upon it, and in general use in England. There are also found in Glaisher's "Hygrometric Tables" (London, 1847), and in the "Wich Observations."—Various forms of dew-point instrument or hygrometer have been devised. That of Prof. Daniell, which is much used, is of the following construction: A bent tube, blown out at each end to a bulb, is laid across the top of a pillar, which is supported on a stand, the two bulbs hanging down on each side. One arm of the tube is long enough to contain a delicate thermometer, the other which terminates in some other external bulb. By boiling the external bulb and fore closing the tube the air is expelled. When in use the empty bulb is covered with a piece of muslin, which is wet with ether. The evaporation of ether condenses the vapor within, causing the level in the other bulb to evaporate and grow. The bulb becomes at last sufficiently cooled to cause the moisture to condense upon it, and the constant this makes its appearance in the form of a ring of dew encircling the bulb. The level of the surface of the ether, the temperature is to be noted by the thermometer in, while that of the air is observed by another thermometer attached to the external bulb. Another observation of the enclosed ether is made as the dew disappears by the returning to its former temperature; a comparison of the two observations will give an approximation to the dew point.—A better instrument is that of Regnault. Two glass tubes are suspended by a small tubular arm

top of each, both opening into the hollow stand that supports the tubes. A pipe for exhausting the air by means of a sort of bellows or the flow of water connects with the hollow in the stand by an opening near its base. The two tubes are closed, each with a cork through which a thermometer tube is fitted, the bulb in one reaching nearly to the bottom. Over the lower end of this one a very thin and highly polished thimble of silver nearly two inches long is fitted, and a fine tube open at each end is passed through the cork, reaching from the external air nearly to the bottom of the tube. Ether is poured into this bulb, covering the lower end of the thermometer, and rising an inch or two higher than the upper edge of the silver thimble. To determine the dew point, the apparatus for exhausting the air from the hollow stand is set in action. This causes the air to pass through the fine tube, and bubble through the ether, keeping it in motion and taking up its vapor. The liquid, the thermometer bulb, and the silver coating of the tube equally feel the reduced temperature, and the instant this reaches the dew point, the whole surface of the silver is covered with moisture. The temperature of the thermometer placed in the ether is then observed, while the other marks the temperature of the air. By stopping the current of air the temperature rises, and the moisture disappears from the silver. The thermometer is to be noted again, and the mean of the two observations taken for the dew point; or several trials may be made in rapid succession. To avoid affecting the result by the warmth radiated from the body, a small telescope may be used in reading the thermometer. The instrument has been modified by Prof. Conell in substituting for the tube a small flask of highly polished brass or silver, into the neck of which is secured an exhausting syringe.—The second of the two methods above referred to, by which the humidity of the air is ascertained, involves the determination of the temperature of evaporation; and the instrument used is the wet-bulb thermometer or psychrometer invented by Prof. August of Berlin, and described in his work *Ueber die Fortschritte der Hygrometrie* (Berlin, 1830). It consists of two delicate thermometers placed near together. The bulb of one is covered with muslin, which is kept wet by water supplied from a vessel close by through capillary conduction. The instrument is placed in a light draught of air, and as evaporation goes on the mercury in the wet-bulb thermometer sinks to a certain point; the temperature of both is then noticed. If the air was nearly saturated with moisture, the difference will be found to be very slight. The barometric pressure is observed at the same time, and data are thus afforded for calculating the elastic force of aqueous vapor in the air. The formula for this calculation, modified by Regnault, and the psychrometrical tables deduced from it, are given in the volume of tables referred to above, and are equally applicable to

the estimation whether the dew-point instrument or wet-bulb thermometer is used. To render them more convenient, they have been converted by Prof. Guyot into English measures. The series also contains tables of the weight of vapors in a given space at different temperatures. The method by the wet bulb, though regarded as decidedly the most convenient means of determining the elastic forces of the vapor, and thence the humidity of the air, is still rendered somewhat uncertain in its results from the impossibility of keeping the wet bulb uniformly moist, and from other causes also. The uncertainty of its results is indeed in some cases so great that Regnault in 1872 recommended that, for accurate meteorological purposes, resort should be uniformly had to the chemical methods of extracting and weighing the aqueous vapor in a given volume of air. To this end he has devised a simple arrangement by which concentrated sulphuric acid may be exposed to the atmosphere and absorb its aqueous vapor; a method that is especially applicable at very low temperatures.—The ultimate object of these hygrometrical investigations is, by enabling the meteorologist to ascertain at all times, in all localities, and at all accessible elevations, the true condition of the atmosphere as to moisture, to furnish him with accurate data for studying the laws which control its variations. The following table of relative humidity is prepared for every 5° F. from 5° to 95° above zero, and for a difference of temperature between the air and the dew point, technically called the complement of the dew point, ranging from 0° to 18°. (See DEW POINT, in article DEW.)

TABLE OF RELATIVE HUMIDITY OF THE AIR.

TEMP. OF AIR.	DIFFERENCE OF TEMPERATURE OF THE AIR AND OF THE DEW POINT.														
	0°	1°	2°	3°	4°	5°	6°	7°	8°	9°	10°	12°	14°	16°	18°
5°	100	96	91	87	83	80	76	72	69	66	63	57	52	47	43
10	100	96	91	87	83	80	76	73	70	66	63	58	53	47	43
15	100	96	91	87	83	80	76	73	70	66	64	58	53	48	44
20	100	96	91	87	83	80	76	73	70	66	63	58	53	48	44
25	100	96	91	87	84	80	76	73	70	67	64	58	53	48	45
30	100	96	92	88	84	81	77	74	70	67	65	59	54	49	45
35	100	96	92	88	84	82	77	74	71	68	66	60	55	51	46
40	100	96	92	89	85	82	78	75	72	69	67	62	56	52	48
45	100	96	93	89	85	83	79	75	73	70	68	63	57	53	49
50	100	96	93	89	86	83	80	76	74	71	69	64	58	54	50
55	100	96	93	90	86	83	80	77	74	72	69	64	59	55	51
60	100	96	93	90	86	84	81	77	75	72	70	64	60	56	52
65	100	97	93	90	87	84	81	78	75	72	70	65	61	56	52
70	100	97	93	90	87	84	81	78	76	73	71	65	61	57	53
75	100	97	94	91	87	84	82	79	76	73	71	66	62	58	54
80	100	97	94	91	88	85	82	79	77	74	72	67	62	58	54
85	100	97	94	91	88	85	83	80	77	74	72	67	63	59	55
90	100	97	94	91	88	85	83	80	77	75	73	68	63	59	56
95	100	97	94	91	88	85	83	80	78	75	73	68	64	60	56

HYKSOS, or Shepherd Kings. See EGYPT, vol. vi., p. 460.

HYLÆOSAURUS (Gr. *hylaos*, belonging to wood, and *sauros*, lizard), the name given by Dr. Mantell to an extinct dinosaurian reptile, from the Jurassic strata of Tilgate forest, having the usual mammalian characters of its tribe, viz.: long bones with a medullary cavity, pachy-



derm-like feet, and sacrum of five united vertebrae. It attained a size of 20 to 25 ft., and was believed by Mantell and Buckland to have had an enormous dorsal dermal fringe like the



*Hyaosaurus.*

horny spines on the back of the iguana: its skin was covered with circular or elliptical plates.

**HYLAS**, in Greek mythology, son of Theodamas, king of the Dryopes, and the nymph Menodice. Hercules, after slaying Theodamas, adopted Hylas, and took him on the Argonautic expedition. When they arrived at Mysia, Hylas went to a neighboring well for water, but the maids of that fountain became so fascinated with his beauty that they drew him into the water, and he was never seen again. When Hercules shouted for him, the youth's voice was heard from the well like a faint echo; and he was so enraged at his loss that he threatened to ravage the country of the Mysians if they did not produce Hylas dead or alive. They sought him in vain, and ultimately instituted an annual festival, during which they roamed over the mountains calling out the name of Hylas.

**HYMEN**, in Greek mythology, the god of marriage. According to some, he was a son of Apollo and one of the muses; but according to others, he was originally a mortal, who, having rescued some Attic maidens from Pelasgic pirates or other robbers, had his praises celebrated in token of gratitude in their bridal songs, which after him were called hymeneal songs. The practice of singing such songs at the nuptial season became in time universal, and the heroic youth was gradually elevated to the rank of a divinity. Hymen is represented in works of art as a tall handsome youth, carrying in his right hand a bridal torch.

**HYMENOPTERA** (Gr. *ἕμψ*, membrane, and *πτερόν*, wing), a suborder of insects, so named from their four membranous, transparent wings. They have upper horny jaws for biting, and softer and longer lower jaws with the tip adapted for collecting honey; the females and neuters have a sting or piercer. All undergo complete metamorphosis; the larvae of the stingers are soft, without legs, resembling maggots; most of the larval piercers resemble grubs and caterpillars. They are diurnal, swift fliers, and surpass all other insects in the num-

ber and variety of their instincts; of the very numerous species none are aquatic. They include the bees, wasps, ants, ichneumons, gall flies, saw flies, &c., which are described under their respective titles.

**HYMETTUS**, a mountain range of Attica, forming the S. E. boundary of the Athenian plain. It consists of two summits, the northern or greater Hymettus, the apex of which is about 3,500 ft. above the sea, and the southern or lesser Hymettus, denominated Anhydrus, "the waterless," by the ancients. The honey of Hymettus was considered by the ancient Greeks as inferior only to that of Hybla in Sicily; but at present, though still abundant, it is said to be of very poor quality. The excellence of its marble is a favorite theme with classic authors. The greater Hymettus is now called Trelo-Vuno, and the lesser Mavro-Vuno.

**HYOSCYAMUS.** See HENBANE.

**HYPATIA**, a Neo-Platonic philosopher, born in Alexandria about 370, killed in 415. She was the daughter of Theon, a distinguished mathematician and astronomer. She went to Athens near the close of the 4th century, and studied under the Neo-Platonist Plutarch, who expounded to a small circle of disciples the Chaldean oracles and the secrets of theurgy. On her return to Alexandria, her talents, beauty, eloquence, and modesty made her an object of admiration. She revived the school of Plotinus, and became its head. But both as a pagan and as a philosopher she provoked the hostility of Cyril, bishop of Alexandria. Not only was her lecture room thronged, but she was consulted by the most considerable persons of the city, among others by the prefect Orestes, who was at constant feud with the bishop. The city was a prey to the violence of parties, and it was to the influence of Hypatia that Cyril attributed the refusal of Orestes to come to a reconciliation. "Certain persons, therefore," says the ecclesiastical historian Socrates, "of fierce and over-hot minds, who were headed by one Peter, a reader, conspired against the woman, and observed her returning home from some place: and having pulled her out of her chariot, they dragged her to the church named Casareum, where they stripped her and murdered her. And when they had torn her piece meal, they carried all her members to a place called Cinaron, and consumed them with fire." Hypatia was the author of two mathematics treatises, which are lost, and there remain from her only an astronomical table inserted in the manual tables of Theon. She is the heroine of Charles Kingsley's "Hypatia."

**HYPERBOLA** (Gr. *ὑπερβάλλειν*, to transcend) one of the conic sections, produced when the cutting plane makes a smaller angle with the axis of a right cone than is made by the side. The shadow of a globe on a flat wall, where part of the globe is further than the luminous point is from the wall, gives a hyperbola. Hyperboloids are surfaces generated by moving hyperbolas.

**HYPERBOREANS** (from Gr. *ὑπερ*, beyond, and the north wind), a legendary race, by the Greeks in the remote regions of the north. They first appear in Hesiod and in traditions connected with the temples at and Delos. The poets conceived of dwelling in perpetual sunshine, possessing abundant fruits, abstaining from the pleasures of the senses, and living for a thousand years. The supposed location of the Hyperboreans varied with the progress of geographical knowledge. At first placed in the north-west of the Ister (Danube), they were supposed by some to the west when this river was supposed to proceed from the western extremity of Europe; while others transferred the extreme north of Europe, beyond the Gephyri and Arimaspi, who themselves dwelt beyond the Scythians. The latter length prevailed; the character of the Hyperboreans as a sacred nation was lost sight of, and their name became only a geographical designation for the extreme north. Modern geographers designate as Hyperboreans a sub-race of the arctic races, inhabiting N. N. (See ETHNOLOGY.)

**HYPERIDES**, one of the ten famous Attic orators, born probably about 395 B. C., died in 322. He was a pupil of Plato in philosophy, of Isocrates in oratory, began his career as an advocate, and was an associate of Demosthenes as leader of the anti-Macedonian party. In 358 he and his son equipped two ships at their own expense to join the Athenians against Eubœa. He displayed an interest in the patriotic cause on an expedition to Rhodes (346), in the expedition against the Persians (340), as ambassador with Demosthenes to Thebes after the capture of Elateia (338), and after the battle of Chæronea he proposed, by a union of the citizens, aliens, and slaves, to organize a resistance to Philip. For his efforts on this occasion he was prosecuted on an indictment for illegal proposition, but was acquitted.

Of his defence there remain only the fragments: "The Macedonian army darkened my eyes, it was not I that moved the decree, but the will of Chæronea." The affair of Harpalus for the first time broke his friendly relations with Demosthenes, against whom he acted as public prosecutor. On the report of Alexander's death (323), it was chiefly by his influence that the confederacy was formed against the Macedonians about the Lamian war. He died at the battle of Crannon to Ægina, and was buried and put to death by the emissaries of Alexander. The number of orations attributed to him was 77, but the ancient writers consider 25 of them as spurious. They agree in praising his genius, and commend him for the very excellence of style. Until late times important fragments of his orations were known to have been preserved. In 1847 an English resident of Alexandria discovered near the ruins of Thebes some

fragments of papyrus written over with Greek, which were parts of the oration of Hyperides against Demosthenes on the charge of having been bribed by Harpalus. He published a facsimile of them in 1848. They were edited by Churchill Babington, with an introduction and commentary, in 1850. Another Englishman, Joseph Arden, procured at the same place and nearly at the same time other fragments of papyrus, which were found to contain a large part of his speech for Lycophron, prosecuted for adultery, and his complete oration for Euxenippus, charged with making a false report of the oracle of Amphiaraus. These were edited by Mr. Babington in 1858. Another traveller, Mr. Stodart, brought from Egypt in 1856 another collection of papyrus fragments, among which were a large part of the funeral oration on Leosthenes and the Athenian soldiers who perished in the Lamian war. This was published by the same editor in 1858. His orations have been republished in Germany by Böckh, Kayser, and others, and in Paris in Didot's *Bibliotheca Græca*. The funeral oration has been edited by Cobet (Leyden, 1858).

**HYPERTROPHY** (Gr. *ὑπερ*, over, and *τροφή*, nourishment), an excess of growth of a part without degeneration or alteration in the structure; the exact opposite to atrophy. Hypertrophy may depend on the excess of the materials of certain tissues in the blood; when this fluid contains habitually too much fat, there may be an abnormal increase of the adipose tissue; similar hypertrophy may thus be induced in other tissues, but there is no evidence that the muscles or nerves increase in bulk from the mere excess of their formative materials. Though an increased supply of blood is generally rather the consequence than the cause of excessive nutrition in a part, hypertrophy may arise from a mere increased circulation, and when one kidney cannot perform its functions, the other has been known to increase in size, owing to its increased activity as an excreting organ. This must be distinguished from the augmented bulk of long congested parts, in which there is not normal hypertrophy, but an addition of altered and inferior tissue. Hypertrophy is in most cases dependent on a preternatural formative capacity in the part, sometimes congenital (as in the abnormal growths of fingers and toes, and even entire limbs), but generally acquired. The most striking instances of acquired nutritive activity are seen in the muscular system, consequent upon the excessive exercise of its functional powers. Muscular hypertrophy is most often seen in the involuntary muscles, whose action is in some way impeded; thus stricture of the urethra or stone in the bladder, obstructing the exit of the urine and calling for extra exertion to expel it, causes hypertrophy of the muscular coat of the bladder; so it happens with the gall bladder when its ducts are stopped by calculi, and with the intestines when a stricture exists in any portion. Hypers-

trophy of the ventricles of the heart is often dependent on narrowing of the cardiac orifices by disease of the valves, giving the organ double work to do, and increasing its activity, as in other muscles. (See HEART, DISEASES OF THE.) When any of the voluntary muscles are specially exercised, hypertrophy is observed in them, as in the arm of the blacksmith or the legs of a professional dancer; and such hypertrophied muscles generally cause an increased nutrition of the bones to which they are attached, and an enlargement of the points of origin and insertion. There are certain enlargements of glands, in which their proper tissue is increased without structural change, which unite physiological hypertrophy with pathological tumors, as in the case of the mammary, thyroid, and prostate glands. Certain tumors of the uterus contain only an excess of the normal muscular and fibrous tissues of the organ, and yet cannot be regarded as examples of hypertrophy, as they observe no regular growth, subserve no physiological purpose, and constitute a positive deformity and disease; such abnormal growths may exist upon a uterus itself hypertrophied from increased functional activity, and must not be confounded with the latter. Supernumerary parts, as additional fingers and toes and various outgrowths developed during fetal life, must in like manner be referred to local hypertrophy from excess of formative activity. Dr. Carpenter sees in this whole series of abnormal production the operation of a similar power; that which in simple hypertrophy is confined to increasing the size of an organ by the development of new tissue according to the morphological type of the part, in the formation of supernumerary tissues also imparts to them an independent existence; on the other hand, while in ordinary hypertrophy the tissues in excess are incorporated in the affected organ, in the structure of a tumor the perfectly formed and independently growing tissues constitute a mass whose shape is determined more by surrounding conditions than by any tendency of their own—the formative power undirected by the normal morphological *nisus*. In malignant growths, the development of tissues stops short of the limit by which formative power produces the normal tissues, and their vital endowments are not sufficient to resist the tendency to degeneration.

**HYPHASIS**, a river of ancient India. See PUNJAB.

**HYPOCHONDRIASIS** (Gr. *ὑπό*, under, and *χόνδρος*, cartilage), a disease generally classed among neuroses, characterized by derangement of various organic functions, and accompanied by an habitual sadness, often bordering on despair, and a disposition to exaggerate every trifling symptom into a sign of dangerous malady; probably so called because it was formerly attributed to disorder of the spleen, an organ situated in the left hypochondrium. It occurs principally in persons of melancholic

temperament, and in those whose moral and intellectual faculties have received high and unnatural development; it is said to be common in proportion to the elevation of the human mind and to the progress of civilization. Men of letters, overtaken students and men of business, and those whose naturally delicate constitutions and ardent imaginative minds have been abnormally stimulated, are the most frequent subjects of hypochondria; but it may arise at any age and in the strongest persons after profound grief or other moral emotion, whether of love, hope, jealousy, or fear, debilitating excesses of any kind, the suppression of any habitual discharge, a sudden change of habits of life, or unceasing devotion to any philanthropic, political, or intellectual pursuit. The symptoms are as various as its causes and the constitutions of men; there is not a part of the body which may not be the subject of the hypochondriac's complaint; the senses are ordinarily very acute, and the sight, hearing, smell, taste, and touch are preternaturally excitable, and the sources of great real or imaginary suffering from the slightest causes; there is almost always digestive disturbance, which enters largely into the explanation of the causes; without fever or local lesion, the sensibility is exalted, with flatulence, nausea, spasms, palpitations, illusions of the senses, aches and pains simulating most diseases, fear of trifling dangers, exaggeration of all the moral sentiments, extreme instability of conduct, and anxiety in regard to the health. The head is full of painful sensations, as fugitive as passing clouds, agonizing at one moment and forgotten the next; sleep is disturbed and unrefreshing, and the waking hours rendered miserable by imaginary troubles. Expressing complete disgust with life, the sufferers yet run to the physician with an account of every fugitive pain, and consider themselves neglected if not listened to, and insulted if their ailments be called imaginary. Both sexes suffer from hypochondria, and the female specially in the reproductive system. Though in the beginning the disorder may have been wholly in the digestive organs, and that only of a functional and curable character, by constant and morbid attention to these and other fancied ailments real and organic disease may be produced, and a return to health be impossible. It is generally slow in coming on and of long duration, and is not incompatible with long life; if the digestion be tolerably good, the prognosis is favorable, as such persons are apt to observe most rigidly the ordinary rules of hygiene; in some impressionable but resolute natures, it degenerates into a settled melancholy, which a slight cause may convert into temporary insanity and suicidal mania. It cannot be said to have any special organic lesions, though in severe and fatal cases there have been found various alterations of the digestive, circulating, and nervous systems. There are two opinions as to the nature and

hypochondria: one is that it is an of the nervous system which presides digestive organs, with or without gaseous inflammation; and the other that cerebral neurosis, a kind of melancholy, is produced by the constancy of the cerebral action, and the efficacy of moral methods is wanting. Some modify the latter opinion; they refer it to a disturbance of the intellectual functions which acts upon and impedes the functions of the organs by concentrating the nervous energy in turn upon each system, and the lesions following upon the neurosis are chiefly the morbid symptoms peculiar to the system.

As a general rule the disease is of far more duration than the formidable array of symptoms which it presents; and the patient, by the constant suffering which it occasions, and the morbid feelings which it produces, and their feelings misinterpreted by themselves and the physician, irritable, and versatile, hypochondriacs are generally troublesome and unsatisfactory patients.

Children of hypochondriac parents, and those who show any signs of uncommon nervousness, should be educated in a manner calculated to diminish the preponderance of the nervous element, and to increase the physical strength, as by avoiding excess of study and excitement, cultivating the generous feelings, and by gymnastic exercises; in the ranks of hypochondriacs would be lessened. Attention to the causes, and their removal, can be ascertained, and their removal, where possible, the observance of rules adapted to circumstances and the avoidance of excess in eating and drinking, and perhaps an occasional laxative course, are probably all that can be done in the way of treatment. But in order to secure benefit to his patient, the physician must secure his confidence, and accustom him to the belief that his affection is understood, his feelings appreciated, his sufferings attended, and his complaints attentively considered; having inspired this confidence, it is difficult to lead even the most confirmed hypochondriac to change his stereotyped way of thinking, and things, to interest him in new enterprises and modes of thought, and to manage him to put him in the way of returning to health by following the dictates of his own feelings and common sense.

**HYPOPHOSPHITES.** The salts formed by hyposulphuric acid with lime, soda, potash, and strontia were proposed, mainly on theoretical grounds, as remedies for phthisis, by Dr. Bouchardat of Paris. They have been extensively used, and are so still to a much less degree, possibly useful as tonics in some cases, as far as all other drugs from being exhausted by consumption. Their chief therapeutic use is to be found in cases where the nervous system is morbidly deficient, and especially in the debility that usually follows prolonged lactation, in some cases of dyspepsia and anæmia, and now and

then in the disturbance or fever of dentition. The hypophosphites of soda and lime are the most useful agents, medicinally, of this class. They are best given in combination with a bitter or aromatic tincture or infusion. The dose of each of them is from 2 to 12 grains, according to age and other circumstances.

**HYPOSULPHATES,** and **Hyposulphites,** compounds, the one of hyposulphuric and the other of hyposulphurous acid, with bases. Of these salts the only one of much interest is the hyposulphite of soda, which possesses the property of readily dissolving the chloride, bromide, and iodide of silver. It has been of great service in the preparation of daguerreotypes and photographs, being used to dissolve the sensitive salt of silver which remains unchanged after its exposure in the dark chamber of the camera. In chemical analysis also it is employed to distinguish between the earths strontia and baryta, precipitating the latter from its solutions, but not the former. It has moreover been adopted as a medicine, and been found beneficial in cutaneous affections, in visceral obstructions, and in disease of the stomach attended with yeasty vomiting. The salt is prepared as follows: A pound of dry carbonate of soda, finely pulverized, is mixed with five ounces of flowers of sulphur, and the mixture is slowly heated until the sulphur melts. By constant stirring exposed to the air the sulphide of sodium, which first forms, is converted into sulphite of soda. This is dissolved in water and filtered. The hot solution, concentrated by boiling, is then saturated with sulphur and allowed to cool, when it deposits large transparent crystals, which are the hyposulphite of soda, of composition represented by the formula  $\text{Na}_2\text{S}_2\text{O}_3 + 5\text{H}_2\text{O}$ . These are soluble in water, but not in alcohol. The hyposulphite of soda is the anti-chlor employed by paper makers for removing the last traces of chlorine from the bleached pulp. A delicate test for the presence of hyposulphurous acid is the brown red color produced by a few drops of perchloride of iron.—The hyposulphites, and especially the hyposulphite of soda, have been used in medicine for the destruction of animal and vegetable parasites and the arrest of fermentation. The diseases to which they have been applied are not only those which are demonstrably connected with parasitic growth or fermentation, as yeasty vomiting and parasitic affections of the mouth and skin, but also those where similar processes may be supposed to be essential factors; such are intermittent and other forms of malarial fevers, typhoid, purulent infection, glanders, cholera, and the contagious exanthemata. Although favorable reports have been made of their action, general experience does not as yet appear to justify the hopes founded on theory, or the confident expectations of the physician most widely known as the originator of the treatment, Dr. Polli of Milan. No harm, however, has resulted from them, and the presump-

tion in their favor is strong enough to justify their employment in connection with other treatment. The hyposulphite of soda may be given in doses of 10 or 20 grains, or more, three times a day, dissolved in water. The action of the sulphite is identical with or analogous to that of the hyposulphite, and it has been used for the same purposes.

**HYPOTHECATION** (Gr. *ὑπό*, under, and *θήκη*, a chest), a word which, in the Roman civil law, from which it is taken, signifies more nearly what we understand by mortgage than by pledge, for which they had a separate word, *pignus*; but it is not precisely the same as either. It was generally used whenever the title to property was transferred by the owner to his creditor, by way of security for the debt, but without that delivery of actual possession which was necessary to constitute a pledge. In English and American law, the word is most frequently used in the law of shipping.

**HYRAX**, a small pachyderm, coming nearest to the rhinoceros family, but looking much like a diminutive hare, and in some respects seeming to form one of the connecting links with the rodents, constituting the family *lamnungia* of Illiger. The old naturalists had always placed it among the rodents, but Cuvier, from its anatomical structure, ranked it with the pachyderms, of which Swainson calls it the gliriform type. The number of ribs is 21 pairs, greater by 6 than in any rodent, of which 7 are true; the sternum consists of 6 pieces; there are no clavicles; the suborbital foramen is small; the dental formula is: incisors  $\frac{2}{2}$ , canines none, molars  $\frac{4-7}{4}$  or  $\frac{4-4}{4}$ , with distinct roots; the extinct pachyderm *taxodon* has long and curved molars, without roots, and incisors with arched sockets, forming another link in the chain of rodent affinities in this order. The toes are four before and three behind, as in the tapir; the hoofs are small and flat, but the inner toe of the hind foot has a curved claw. The genus *hyrax* (Hermann) is the only one in the family, and contains four or five species. The body is covered with short, thick fur, with a few long bristles scattered among the shorter hair, and others around the nostrils and orbits; a tubercle in the place of the tail. The common name of the species is daman; it seems to bear the same relation to the rhinoceros as the existing sloths to the extinct megatherium; it lives among rocks, and is sometimes called rock rabbit and Cape badger. The Syrian hyrax (*H. Syriaena*, Schreb.) is about 11 in. long and 10 in. high; the upper parts are brownish gray, the sides yellowish, and the lower parts white. Its movements are quick, and its habits much like those of rodents; it delights in heat, in cold weather rolling itself up; it searches for narrow openings in which to hide itself, as its soft feet are not adapted for digging burrows like many rodents; its sense of smell is acute, and by it the food, which is wholly vegetable, is obtained; it is of mild disposition, with little intelligence

and little fear. It is found on the mountains near the Red sea, and in Ethiopia and Abyssinia in caverns in the rocks, dozens being seen at a time warming themselves in the sun. This animal, according to Bruce, is called in Arabia and Syria Israel's sheep, and is the



*Hyrax Capensis.*

*shaphan* of the Hebrews, generally translated rabbit or cony. The Cape hyrax (*H. Capensis*, Pall.) is about the size of the rabbit, but with shorter legs, more clumsy form, thick head, and obtuse muzzle; the color is uniform grayish brown, darkest along the back; it lives in the rocky regions of the south of Africa; its flesh is delicate and savory. Other species are described in the woods of Africa.

**HYRCANIA**, an ancient country of Asia, comprising the western portion of the mountain region between the S. E. shores of the Caspian (sometimes called the Hyrcanian sea) and the river Arius (now Heri-rud). It consisted mainly of the valleys of the Nika, Gurgan, and Atrek. It was a most productive country, capable of sustaining a dense population, and deserving Strabo's description of being "highly favored of heaven." The Hyrcanians seem to have been a people of Turanian race, intermixed with Aryans. After a short resistance they submitted to Cyrus. When the Persian empire was organized by Darius Hytaspis into satrapies, Hyrcania was added to the satrapy of Parthia. After the Macedonian conquest, Hyrcania became a part of the empire of the Seleucids. The Parthian king Arsaces II., or Tiridates, detached it from the Syrian empire and added it to his own territories. Shortly afterward it was invaded and devastated by Scythians. It was also invaded by Antiochus the Great, in his Parthian war, but seems to have remained unsubdued. A subsequent revolt against the Parthian rule was unsuccessful.

**HYRCANUS**. **I. John**, a Jewish high priest, died in 106 (or according to some in 105) B. C. He succeeded his father Simon Maccabaeus in the high priesthood as one of the Asmonean rulers of Judea, 135 B. C. In that year Antiochus Sidetes besieged Jerusalem, and obliged the inhabitants to dismantle its fortifications and pay a tribute; but after the defeat and death of Antiochus in 130, Hyrcanus re-established his independence and extended his dominion. He razed the city of Samaria,

eral other cities from the Syrian king-  
d not only conquered the Idumæans,  
pelled them to submit to the Mosaic  
He also formed an alliance with the  
In the latter part of his reign he  
led the sect of the Pharisees for that  
Sadducees, thereby incurring much  
He was succeeded by his son Aristo-  
ho took the title of king of Judea. **II.**  
**II.**, grandson of the preceding, born  
9 B. C., beheaded in 30. He was the  
son of Alexander Jannæus and his wife  
ra, daughter of John Hyrcanus. On  
her's death (71) he succeeded to the  
i, but the power was soon wrested  
m by his younger brother Aristobulus.  
ompey made himself master of Jeru-  
63, he reinstated Hyrcanus in the gov-  
as a tributary prince. Dissensions  
prived him of power, but when Caesar  
ucted the state he was once more re-  
s high priest, Antipater having civil  
y as procurator. Herod, the younger  
ntipater, succeeded his father as pro-  
and betrothed himself to Mariamne,  
ddaughter of Hyrcanus. In a new  
y Antigonus, the only surviving son of  
lms, who was aided by the Parthians,  
s was taken prisoner; his ears were  
o render him incapable of holding the  
high priest, and he was banished to  
ia, where the Parthian monarch and  
Jews treated him with distinction.  
ome years he returned to Jerusalem,  
erod had now established himself in  
reignty and had married Mariamne.  
g jealous of his claims to the throne,  
used him to be put to death.  
**L. Joseph**, an Austrian anatomist, born  
stadt, Hungary, Dec. 7, 1811. He stud-  
enna, became in 1837 professor of anat-  
Prague, and was recalled to Vienna in  
the same capacity, became rector of  
ersity, and retired March 16, 1874. He  
guished for his labors in comparative  
his investigations on the organ of  
and the invention of many anatomical  
rts. He was the first to introduce  
ledge of topographical anatomy into  
y, and published a manual relating to  
ch of science (2 vols., 1847; 5th ed.,  
*His Lehrbuch der Anatomie des Men-*  
47; 11th ed., 1870) is a text book in  
universities, and has been translated  
foreign languages. Among his other  
works are *Handbuch der praktischen*  
*erzunkunst* (1860), an elaborate de-  
(1865) of the museum of comparative  
, which he had founded, and *Das Nie-*  
*der Sinnesorgane und des Menschen*  
(1870). His preparations, famous for  
ars, demonstrate by colored material  
through some of the principal arteries  
ence of the microscopic arteries and  
companioning the lacteal vessels in the  
intestinal papillæ. By the same means

he demonstrated in 1874 the presence of a  
vascular net in the cornea of the eye, and after  
many ineffectual attempts he succeeded in fill-  
ing the arteries and veins of an infant eight  
days old from the umbilical vein with coloring  
matter so perfectly as to reach and penetrate  
the minute arteries and veins of both corneæ.

**HYSSOP** (*hyssopus officinalis*, Linn.), a per-  
ennial aromatic plant, of the natural order  
*labiatæ*, a native of Europe, and cultivated  
there and in the United States in gardens. Its  
flowers, violet-colored or blue, and its leaves,  
are used in medicine, though but little by reg-  
ular practitioners. It is a warm and gentle  
stimulant, promotes expectoration of the mu-  
cus, and is used in chronic catarrhs, especially  
by old people. The hyssop of Scripture is the  
caper tree, *capparis spinosa* (Linn.), which  
abounds in the south of Europe, in lower  
Egypt, and in Syria.

**HYSTERIA** (Gr. *ἰστέρα*, womb), a disease char-  
acterized by great excitability of the nervous  
system, especially of the sensory ganglia, with-  
out necessary structural lesion, and manifest-  
ed by disordered states of the emotional na-  
ture, with loss of the power of controlling  
the thoughts and feelings, by spasmodic symp-  
toms, and occasionally by perversion or sus-  
pension of the intellectual faculties. It re-  
ceived its name from the idea that it is peculiar  
to the female sex, originating in some disturb-  
ance of the uterine functions; but, though by  
far the most common in females, and generally  
connected with disorder in the generative sys-  
tem, it may also occur in males; a common  
name for it is "the vapors." The nervous  
symptoms predominate, varying in character  
and intensity according to the temperament  
of the individual, the nature of the causes, and  
the persistence of the disease. In the beginning  
it generally manifests itself by an exaggeration  
of the ordinary signs of emotional excitement,  
such as smiles and tears, irrepressible laugh-  
ter and convulsive sobs, brought on by trifling  
causes; the nervous excitability increases, un-  
til violent convulsions of an epileptic or tetanic  
character arise from slight stimuli, with coma,  
opisthotonos, trismus, paralysis, cramps, end-  
ing often in monomania or moral insanity. The  
paroxysms are sometimes of frightful intensity,  
requiring the strength of several persons to  
restrain a delicate female and prevent self-  
injury; after an attack the patient may be ex-  
hausted and almost insensible, and in a state of  
double consciousness, or much agitated, laugh-  
ing or crying at the strangest fancies; at times  
the person falls insensible, breathing at long  
intervals, recovering with a sense of fatigue  
and coldness, or with involuntary emission of  
limpid urine. In cases where the nervous  
symptoms are less prominent, there are pain  
and a sense of heat and fulness in the region  
of the uterus, constriction of the throat with  
difficulty and increased desire of swallowing, a  
feeling as if a ball were rolling from the abdo-  
men up to the epigastrium and throat with a

sensation of pressure and suffocation, flatulence and tympanitic distention, hurried respiration, palpitations, occasional cramps, and great depression or exaltation of spirits. An attack of hysteria may last for several hours, the violent symptoms recurring every few minutes, with intervals of partial rest; or it may consist of but a single paroxysm of 20 minutes or half an hour in duration. After the paroxysm has ceased, tolerable health may be enjoyed for some time, though the nervous excitability persists. In cases of long duration, the intellect and memory become enfeebled, the strength fails, and hypochondriasis and various chronic irritations of the vital organs supervene. Hysteria is very irregular in its march; it is the most protean of diseases, simulating almost every morbid condition; its duration is variable, sometimes terminating in health after a few attacks without medical treatment, and at others lasting a lifetime in spite of the best directed efforts to arrest it; its most dangerous consequences are convulsions, spasmodic contractions, partial paralysis, epilepsy, and tendency to insanity. The predisposing causes of hysteria are the female sex and a hereditary or acquired nervous irritability; the exciting causes are vivid moral emotions, anything which excites the imagination, especially disappointed love, jealousy, and various excesses of body or mind; it is often brought on by the mere force of imitation; some irregular action of the sexual functions is found in nearly if not quite all cases between the ages of 15 and 50. There has been great diversity of opinion on the nature and seat of the disease; its cause has been located in the uterus, in the brain, in the spinal cord, and in the stomach and other abdominal organs. Whatever be its origin, a disordered state of the emotional nature is an essential character of hysteria, and the control of the feelings rather than of muscular action is lessened or lost; it is partly a disease of the mind, from improper education or self-abandonment to the power of the emotions. The habitual indulgence of feelings of a painful character or of sexual tendency affects the nutrition of the nervous and genital systems, giving rise to the peculiar phenomena of this affection. Though hysteria may simulate the phenomena of epilepsy, tetanus, chorea, hydrophobia, and other nervous diseases presented to its imitative disposition, it is dependent on a state of much less abnormal character; there is generally no structural lesion, nor any serious disturbance of the nutritive functions, as is

evident from the long duration of the and the suddenness with which differences pass into each other or disappear entirely. The strangeness of these combinations and changes is sufficient to distinguish from the more grave diseases which it imitates. According to Carpenter, this excitability of the nervous system, which is only an exaggeration of that characteristic of the female sex, is due by some defect of nutrition, the particular phenomena arising either from some morbid condition of the blood acting upon the centre most susceptible to its influence, or from irritation of the peripheral nerves; he attributes a gouty diathesis is one of the most common sources of this imperfect nutrition.—The principles of treatment are threefold: 1, to improve the nutrition of the nervous system by bringing the blood up to its healthy standard, by strengthening diet, hygienic means, and judicious employment of tonics; 2, to regulate all irregularities in the menstrual or other functions, when they are evident exciting the mind; 3, to act upon the mind, by leading the patient to repress the first emotional excitement, to direct the force of the will, and to direct attention to a different class of objects, substituting a pleasant for a disagreeable train of ideas. The attack itself requires that the patient be kept from injuring herself, and the use of all constricting garments, fresh air, and drinking with cold water, inspiration of steam, or other strong or disagreeable odors, in the nostrils with a feather, and other domestic remedies. To prevent a return, the best remedies; any disappointment in love, business, or other affairs should if possible be removed by the cultivation of the hopes; if marriage be unattainable, the tendency to hysterical attacks may be removed by the change of air, so that habits resulting from a distant journey, a similar course is useful to distract attention from other consuming cares and junc-  
**HYTHE**, a town and parliamentary borough of Kent, England, on the British channel, in W. S. W. of Dover; pop. of the municipality in 1871, 3,363. It is one of the most important ports, and was formerly a place of considerable importance; but its harbor has been derelict by accumulations of matter thrown up by waves, and it is now a fashionable resort for sea bathing. It has a military school and theatre. The parliamentary borough includes Folkestone and several smaller places.

## I

**I**, THE 9th letter of the Latin and of most other European alphabets, derived from the 10th Phœnician, Hebrew, &c., where it is named *yod* (Heb. *yad*, hand), and considered

as a consonant. A dot under other vowels denotes its vocalicity in the Hebrew, and marks in the other Semitic languages the 11th letter in Armenian, the 28th

c, and the 32d and last in Persian and  
 The Greek *Ι* is the 9th letter, but  
 aeral sign, and is sometimes subscribed  
 rowels, thus, *α, β, γ, φ*. The sound of this  
 he highest in the vocal scale, the coun-  
 of that of U (*oo*). This sound (not as  
 ced in *mine*, but as in *pique* or *pin*) is  
 , in many words of all languages, of  
 ittle, thin, slim, swift, shrill, light, flit-  
 is property is mentioned by Plato. It  
 l through a broad but very thin inter-  
 ich the tongue leaves between itself  
 hard palate by being closely raised to-  
 and pressed against the molar teeth,  
 e larynx is raised higher than in the  
 n of any other vocal. Hence it is con-  
 s a palatal by John Wallis, and as a  
 y C. Amman. Modern Greeks pro-  
*η, ε, α, υ, and ι* like *i*; whereas the  
 made *αι, ει, οι, and υι* diphthongal, giv-  
 e *υ* a sound like that of the German *ü*,  
 ie *η* that of German *ä*. The Romans  
 th as a vowel and as a consonant;  
 :*υ*, as well as the Egyptians, Hebrews,  
 :*ka*, knew no such sounds as the French  
 lish give to *J* (*sh* and *dsh*). The Ital-  
 age is impaired in its beauty by the  
 y of *I* in its grammatic formations.  
 a it is also used for softening the pro-  
 n of *e, g, and œ*. In Spanish manu-  
 n initial *I* is always written *Y*, for  
 is substituted in printing except where  
 ie consonant sound, as in *yerba*. In  
 the diphthongal sound in *mine* (Ger.  
 taken for the long sound of *I*, and its  
 long sound is transferred to *E*, as in  
 he latter sound, long and short, is  
 in many different ways, some only in  
 ords; as in *be, lee, sea, people, key, œcul,*  
*ize, mien, marine; pin, siere, forfeit,*  
*nz, women, busy, tortoise*. Its English  
 nd is written in 10 ways, as in *mile,*  
*height, guide, my, ay, eye, buy, rye.*  
 words, like *bird, stir*, *I* has the sound  
*fur*. The consonantal sound of *I* is  
 ted by *J* in Italian and in German and  
 utonic languages, and by *Y* in French,  
 Portuguese, English, &c. (See *J*, and  
 as formerly the practice to class words  
*J* together in dictionaries and other al-  
 al works; but this is now nearly aban-  
 all languages.—In Latin abbreviations,  
 for *incertus, in, inferi, Iulius, Iunius,*  
*I* for *iuris consultus, &c.* During the  
 of literature *I* was used to denote 100;  
 ie Roman numeration it stands for 1.  
 aced before another numeral it is sub-  
 and when following is added; as *IV,*  
*6*. On French coins it denotes Li-  
 s the place of coinage.—In music, *I*  
 me of the 9th tie on the neck of the  
 of various old musical instruments.  
 zer, Fasch, and other organists deno-  
 a by-tone between *a* sharp and *b* flat.  
**ICHŒS**, a Neo-Platonic philosopher,  
 Chalcis, Cœle-Syria, flourished in the

first half of the 4th century A. D. He was a  
 pupil of Anatolius and Porphyry, and after the  
 death of the latter became the head of the  
 school in Syria. His pupils and contempora-  
 ries styled him the "most divine teacher," and  
 declared him the equal of Plato. Little is  
 known of his life, except that he made an ex-  
 cursion annually to the hot springs of Gadara,  
 and that miraculous acts were ascribed to him,  
 which reveal the tendency of the Neo-Platonic  
 school at this time to combine the thaumaturge  
 with the philosopher. He had thoroughly  
 studied the systems of Plato and Pythagoras,  
 and the theology and philosophy of the Chal-  
 deans and Egyptians, and his speculations pre-  
 sent a confusion of Hellenic and oriental ideas.  
 The extant books of his work on the Pytha-  
 gorean philosophy have been published under  
 different titles; the last edition of the 1st  
 (which contains the life of Pythagoras) and  
 2d is by Kiessling (Leipsic, 1818-'15), of the  
 3d by Fries (Copenhagen, 1790), of the 4th  
 by Tennilius, &c. (Arnhem, 1666), and of the  
 7th by Ast (Leipsic, 1817). His work on  
 Egyptian mysteries was published by Thomas  
 Gale (Oxford, 1678). It was translated into  
 English by Taylor the Platonist (Chiswick,  
 1821), who also translated the "Life of Py-  
 thagoras" (London, 1818).

**ISARRA**, an inland town of Ecuador, capital  
 of the province of Imbabura, 55 m. N. by E.  
 of Quito; pop. about 14,000. It is delightfully  
 situated in the fertile plain of Imbabura, a short  
 distance N. of the volcano of that name. The  
 streets are wide and regular, and many of the  
 houses well built, generally of adobes. The  
 chief buildings are the governor's residence,  
 the parish church in the public square, the hos-  
 pital, and a beautiful pantheon. There are a  
 college or Latin school and a number of pri-  
 mary and grammar schools in buildings for-  
 merly used as convents. Sugar of excellent  
 quality is manufactured; also cotton and wool-  
 len stuffs, very fine laces, hats, brandy, cordials  
 or liqueurs, and sweetmeats; and there are  
 extensive salt works. The city was almost  
 totally destroyed by an earthquake in 1868.

**IBERIA**. **I**. The ancient Greek name of Spain.  
 The aboriginal Iberi, from whom the name was  
 derived, seem to have occupied the entire pen-  
 insula from the strait of Gibraltar to the Py-  
 renees, until the date of the Carthaginian in-  
 vasion. They are also said to have occupied  
 southern Gaul as far as the Rhône, where they  
 bordered upon the Ligurians. Ticknor in his  
 "History of Spanish Literature" says: "The  
 Iberians are the oldest of the occupants of the  
 Spanish soil, and the people who, since we can  
 go back no further, must be by us regarded as  
 the original inhabitants of the peninsula. They  
 appear, at the remotest period of which tradi-  
 tion affords us any notice, to have been spread  
 over the whole territory, and to have given to  
 its mountains, rivers, and cities most of the  
 names they still bear; a fierce race, whose  
 power has never been entirely broken by any



of the long line of invaders who at different times have occupied the rest of the country." The Iberians maintained an active commercial intercourse with the Carthaginians, and displayed great activity in mining and much artistic skill in the use of the precious metals. P. A. Boudard has published a work on the Iberian alphabet and language and Iberian coins (4to. with 40 plates, Béziers, 1859). (See **CELTIBERI**, and **BASQUES**.) II. The ancient name of the Caucasian country now known as Georgia. This country was bounded by the Caucasus, Albania, Armenia, and Colchis. The Asiatic Iberians were divided into four castes.

**IBERIA**, a S. parish of Louisiana, intersected by Bayou Teche, and partly occupied by Lake Chetimaches and Vermillion bay; area, about 600 sq. m.; pop. in 1870, 9,042, of whom 4,510 were colored. Part of the parish consists of an island lying between Vermillion and Côte Blanche bays and the gulf of Mexico. The surface is level, and the soil alluvial and fertile. Salt is manufactured. The chief productions in 1870 were 115,843 bushels of Indian corn, 12,414 of sweet potatoes, 1,297 bales of cotton, 12,500 lbs. of rice, 1,854 hogsheads of sugar, and 102,495 gallons of molasses. There were 1,271 horses, 834 mules and asses, 6,543 cattle, 3,511 sheep, and 1,569 swine. Capital, New Iberia.

**IBERUS**. See **EBRO**.

**IBERVILLE**, a S. parish of Louisiana, bounded W. by Atchafalaya bayou and S. E. by the Mississippi; area, 450 sq. m.; pop. in 1870, 12,347, of whom 8,675 were colored. It has a flat surface, and is frequently inundated. The lands lying near the rivers are fertile; the rest of the parish is mostly uncultivated. The chief productions in 1870 were 168,645 bushels of Indian corn, 1,178 bales of cotton, 4,907 hogsheads of sugar, and 323,600 gallons of molasses. There were 377 horses, 1,938 mules and asses, 1,602 cattle, 1,483 sheep, and 656 swine. Capital, Plaquemines.

**IBERVILLE**, a S. W. county of Quebec, Canada, bounded W. by Richelieu river; area, 189 sq. m.; pop. in 1871, 15,413, of whom 13,971 were of French descent. It is traversed by the Vermont Central and the Stanstead, Shefford, and Chambly railroads. Capital, St. Athanase.

**IBERVILLE**, *Pierre le Moyne*, sieur d', a Canadian naval and military commander, founder of Louisiana, born in Montreal, July 16, 1661, died in Havana, July 9, 1706. He was one of eleven brothers, most of whom were distinguished in French colonial affairs, three being killed in the service. (See **LE MOYNE**.) Iberville entered the French navy as a midshipman at 14, became captain of a frigate in 1692, and captain of a line-of-battle ship in 1702. In 1686 he served under De Troye in the overland expedition from Canada against the English forts in Hudson bay, was at the taking of Fort Monsipi, and, having with his brother captured two vessels, reduced Fort Quitchechon-

en. He was there again in 1688-'9, capturing two English vessels. In 1690 he was one of the leaders in the retaliatory expedition against Schenectady, where he saved the life of John Sanders Glen. In October, 1694, he took Fort Nelson on Hudson bay, losing his brother Châteauguay in the assault. In May, 1696, he was operating on the bay of Fundy with three vessels; he defeated three English ships, capturing the Newport near the mouth of the St. John's, then besieged, took, and demolished Fort Pemaquid, and ravaged Newfoundland, taking almost all the English posts. Proceeding to Hudson bay in 1697, with the Pelican he engaged three English vessels, defeated them, and reduced Fort Bourbon. He was then selected to occupy the mouth of the Mississippi, a point which France had neglected after the death of La Salle. Iberville sailed from Brest with two frigates, Oct. 24, 1698, stopped at Santo Domingo and at Pensacola, which he found occupied by the Spaniards, and on Jan. 31, 1699, anchored at the mouth of the Mobile near Massacre island. He then, with his brother Bienville, Père Anastase Douay, who had been with La Salle on his last voyage, and about 50 men, went in two barges to seek the Mississippi, and on March 2 reached its mouth. He ascended to the Bayagoulas and Oumas, and became assured that he was really on the Mississippi by receiving from the Indians a letter left by Tonty in 1686 for La Salle. Returning to his ships, Iberville built old Fort Biloxi, the first post on the Mississippi, placed Sauvolle in command, and made his brother Bienville king's lieutenant. Early in May, 1699, he sailed for France, but again appeared off Biloxi in the *Renommée*, Jan. 5, 1700. He then began a new fort on the Mississippi, over which he placed Bienville. He also sent Lesueur with a party to establish a post at the copper mines on the Mankato. He was again in Louisiana in December, 1701, and finding the colony reduced by disease he transferred the settlement to Mobile, beginning the colonization of Alabama. He also occupied Dauphin or Massacre island. His health was seriously undermined by fevers, and he was called away from his Louisiana projects by government. In 1706, with three vessels, he reduced the island of Nevis, and was about to operate on the coast of Carolina, when he was seized with a fatal malady and died in Havana.

**IBEX**, a species of wild goat, inhabiting the mountainous regions of Switzerland, the Pyrenees, the Caucasus, and Abyssinia. The generic characters are given in the article **GOAT**. The common ibex or steinbock (*capra ibex*, Linn.), the *bouquetin* of the Swiss hunters, is about 5 ft. long and 2½ ft. high at the shoulders; the horns are large, flat, with two longitudinal ridges at the sides and numerous transverse knobs; at first nearly vertical, they curve backward and outward to a length of about 30 in.; they are dark colored and very stout. The color of the adult is brownish, with a gray tinge

and reddish in summer; the hair is thick; the under parts are whitish, nasal stripe blackish brown. The gestation is about 160 days, and the usually born in April. They prefer and most inaccessible mountains,



Ibex (*Capra ibex*).

of perpetual snow, and are acclimated with great difficulty and danbyssinian ibex (*C. jaela*, H. Smith), the Greek and Hebrew writers, is more than the preceding species, with a more circular and less divergent front and marked with numerous ridges; the color of the hair is brown, with a dark dorsal line; under and neck the hair is lengthened. The ibex (*C. caucasica*, Guld.) is broader than the European species; the triangular with distant ridges, very brown, and about 28 in. long. The head brown above, head grayish, breast line blackish, and throat whitish hair is coarse, having at the roots a l. All these animals are remarkable for their strength and agility, making immense leaps over the most dangerous precipices; and to fall from considerable heights unharmed, when pressed by the hunter, they receive no injury from the fall. They are all probably more or less the common wild goat (*C. agagrus*) and have contributed largely to the formation of the numerous varieties of the goat. (See GOAT.)

The river of Brazil which rises in the state of Anna, province of Rio Grande at lat. 31° 20' S. and lon. 54° 30' W., west due N., under the name of Sanen N. W. and joins the Uruguay at Cruz and Restoracion, lat. 29° S., at a distance of some 400 m. It receives on the waters of numerous tributaries,

VOL. IX.—10

and is navigable for 300 m. by barges and canoes. The upper branch is called Ituzaingo.

**IBIS**, a wading bird of the family *tantalidae*, including the genera *ibis* (Moehr.) and *geronticus* (Wagl.); the genus *tantalus* (Linn.) will be noticed under Wood Ibis. The genus *ibis* is characterized by a lengthened, slender bill, curved for its whole length, with the sides compressed and tip obtuse; the nostrils are in a groove which extends to the tip of the upper mandible; forehead and base of bill, to behind the eyes and on the chin, in most species bare; wings long and pointed, the first and second quills equal and longest; tail rather short and nearly even; tibia bare for half its length, covered with hexagonal scales; tarsi slender, longer than the middle toe, with broad transverse scales in front; toes long and slender, the lateral ones united to the middle by a small web; hind toe long and slender, claws curved and rather weak. There are about half a dozen species, of which three are found in the United States. The red or scarlet ibis (*I. rubra*, Linn.) is about 28 in. long, the extent of wings a little over 3 ft., and the bill 6½ in. The color is a uniform bright scarlet, with the tips of the outer primaries black; in the young the color is ashy, darkest above, with the under parts and rump white. Its natural habitat is South America and the West Indies, but it has been seen in the southern states by Audubon; it is sometimes called, from the length and shape of the



Scarlet Ibis (*Ibis rubra*).

bill, the pink curlew. The white ibis, Spanish or white curlew (*I. alba*, Linn.), is 25 in. long, with an extent of wings of 40 in., and the bill 7 in. The color of the plumage is pure white, with the tips of the outer five primaries shining greenish black; the bill is red, entirely so in the young birds, but with the terminal half black in the adult; the head in front of the eye is bare; the young birds are of a dull brown color, with the under parts and rump white. This species is very common in the southern Atlantic and gulf states, occasionally straggling as

far north as New Jersey. They breed in large companies on the Florida keys on trees; the nest is about 15 in. in diameter, formed of twigs and roots, flat on the inside; the eggs are three, and are laid only once a year,  $2\frac{1}{2}$  by  $1\frac{1}{2}$  in., dull white, with pale yellow blotches and reddish brown spots; incubation generally takes place between the 10th of April and the 10th of May; the eggs afford excellent eating, though the yolk is of a reddish orange color when boiled, and the white a liver-colored jelly. When breeding, they fly in flocks of several hundreds to the mud flats, sometimes to great distances, where they feed on crabs, crawfish, and other crustaceans, mollusks, and aquatic animals, until the tide begins to come in, whether by day or night. The flight is rapid and well sustained, effected by alternate flappings and sailings; they often rise very high, performing beautiful evolutions. They are fond of resorting to ponds or lakes in the woods, and often breed in such localities more than 300 m. from the sea; though not taking naturally to the water, they can swim tolerably well when forced to it; the walk is light and graceful. The flesh has a very fishy taste, and is rarely eaten except by the Indians. The glossy ibis (*I. Ordi*, Bonap.) is a smaller species, being about 21 in. long, with a bill of  $4\frac{1}{2}$  in.; the general color is chestnut brown, with the back and top of head metallic green glossed with purple; the feathers continue almost to the bill, which is of a dusky black color. It exists in great numbers in Mexico, and it has been procured as far north as Massachusetts. The green ibis (*I. fulcinellus*, Linn.) is a native of southern Europe and northern Africa; it much resembles the glossy ibis, being purplish brown, with a deep green mantle; in the young birds the head and neck are pointed with whitish. These ibises all live in warm climates, performing their annual migrations, and are generally seen on lands recently inundated, and on river banks, seeking for worms, snails, crustaceans, insects, and the roots of bulbous plants, or on the sea coast as above mentioned.—The genus *geronticus* has a stronger bill, a longer and broader tail (the third and fourth quills the longest), the tarsi and toes stouter, and the head and neck more denuded of feathers than in the preceding genus; in some of the species the scapulars are long, and consist of decomposed plumes. There are about 20 species, found in the warmer parts of Africa, Asia, and South America, of which only one will be mentioned here, the sacred ibis of the ancient Egyptians (*G. Æthiopica*, Lath.). It is about as large as a domestic fowl; the plumage is white, with the ends of the quills, the elongated barbs of some of the wing coverts extending over the wings and tail, bill, feet, and naked part of the head and neck, black; it is found throughout northern Africa. This bird was reared in the temples of ancient Egypt with the greatest care, and was embalmed; it was forbidden to kill one on pain of death. This superstitious people revered

the ibis, not because they supposed that it destroyed noxious reptiles, or that there was any relation between the changes of its plumage and the phases of the moon, but because they associated its annual appearance with the period of the inundation of the Nile, the source



Sacred Ibis (*Geronticus Æthiopica*).

of the fertility and healthfulness of the land; the crafty priests led the people to believe that the increase of the river, which brought the birds there in search of food, was the consequence instead of the cause of their visit; the educated class regarded the ibis as the harbinger of the fruitful epoch of their year, as we look upon the coming of the bluebird and the swallow as the signs of spring. A black ibis was also honored and embalmed. The flight of these birds is powerful and high, with the neck and feet extended horizontally, and accompanied by occasional harsh cries. They probe the mud with their bills in search of insects, worms, mollusks, &c., advancing by slow steps; they arrive in Egypt when the Nile begins to increase, and migrate about the end of June, not nesting in that country; they are caught in great numbers by the modern Egyptians in nets, and their bodies are frequently exposed for sale in the markets. Both species usually go in small flocks. All the species have the same habits, frequenting both overflowed lands and dry open plains; they sometimes devour frogs and small aquatic lizards, but do not destroy serpents as Herodotus and many writers since have maintained; when satiated with food they perch on high trees, and are very watchful; the nest is either on a decayed tree or on the ground, and the eggs are two or three in number. For full details on the sacred ibis, see Savigny's *Histoire naturelle de l'ibis* (8vo, Paris, 1805).

IBN BATUTA. See BATUTA.

IBRAHIM PASHA, an Egyptian viceroy, the son, or according to some the adopted son, of

met Ali, born at Kavala, a village of Roumelia, in 1789, died in Cairo, Nov. 9, 1848. His youth, from his 16th year, was spent in command of the troops in Upper Egypt, and fighting the wild tribes of that region. In 1811 he reduced by famine the fortress of Ibrahimia, the refuge of the last remnants of the Mamelukes. In September, 1816, he invaded Arabia at the head of the third army to reduce the Wahabees, and displayed his skill, courage, perseverance, and cruelty in driving his heterogeneous forces, and in driving victory out of defeat. After taking the strongholds, he laid siege to the Wahabee town of Dera, which he compelled to surrender. He returned to Cairo in 1819, and, under the guidance of a French officer, created an army disciplined and equipped after the European manner. In August, 1824, he set sail with a formidable fleet and 17,000 troops for Greece, and in suppressing the insurrection there, his army gained many successes, and devastated the Peloponnesus with great cruelty. The European powers intervened, and his fleet was destroyed at Navarino, Oct. 20, 1827, by the united squadrons of Russia, France, and England; and in 1828 he was recalled to Egypt on the peremptory order of Mehemet Ali. He again he busied himself in organizing an army, and in creating, with the aid of French engineers, a fleet superior to that which he had at Navarino. Both were ready in 1831, when the disobedience of the pasha of Acre afforded Mehemet Ali the desired opportunity of invading Syria. Ibrahim, to whom the expedition was intrusted, lost 5,000 men by cholera before he could leave Egypt. On Nov. 29 he laid siege to Acre, having terrified into surrender Gaza, Jaffa, and Kaiffa. A Turkish fleet came to the relief of Acre, and was surprised and routed by Ibrahim near Tripoli, and on May 27, 1832, he carried Acre by storm. He rushed on immediately for Aleppo. Damascus opened its gates to him. The Turks again defeated at Homs, and afterward at Hama, and finally the fall of Aleppo left him master of Syria. Pursuing the Turks, he overtook and routed them at Adana. Meanwhile Mehemet had driven that of the Turks to seek refuge beneath the forts of Constantinople. Ibrahim obtained another brilliant victory at Kislak, he marched to Konieh, where on Oct. 20 he found himself confronting 60,000 Turks commanded by Reshid Pasha. Though the Egyptians were not half as numerous, they defeated the Turks completely, and the grand vizier himself was taken prisoner with immense booty. His father's commands obliged Mehemet to wait for reinforcements, instead of marching on Constantinople. This delay enabled the sultan to invoke the aid of the czar; and on Feb. 20, 1833, a Russian fleet cast anchor in the Bosphorus. The western powers intervened, and a peace was concluded, leaving Mehemet Ali the government of Syria and the pashalik of Adana. Ibrahim governed these

provinces with firmness, repressed disorders, and encouraged agriculture, industry, and commerce. The resentment of the sultan led in 1839 to a renewal of hostilities, which resulted in another crushing defeat by Ibrahim of the Turkish forces, at Nizib, on June 24. Here again, obedient to his father's order, and in compliance with the request of the French government, he stopped short in his course of victory. A treaty concluded July 15, 1840, between the Porte and the western powers (without the knowledge of France), stipulated that Mehemet Ali should either consent to limit his authority to Palestine, or be compelled to do so by the united forces of England and Austria. An insurrection broke out among the mountain tribes of the Lebanon and spread rapidly on every side. Beyrout, after a bombardment of nine days, was evacuated by the Egyptian garrison, Sidon yielded without resistance, St. Jean d'Acre surrendered after three hours' fire; the whole coast of Syria was in possession of the English, and Commodore Napier, anchoring in the bay of Alexandria, sent an ultimatum which Mehemet Ali accepted. Ibrahim, who had fallen back to Damascus, and found his position extremely difficult, was now commanded to evacuate Syria. This retreat, conducted with consummate ability, but with great losses, closed his military career. Thereafter he devoted his whole time to the culture of his immense estates on the plain of Heliopolis, until he was placed in charge of the government on the retirement of his father in 1844. His own infirmities, however, compelled him to seek a more temperate climate and the medical skill of western Europe. Returning to Egypt, he began several reforms suggested by what he had observed during his travels; but a violent attack of dysentery again forced him to a change of climate, and he spent the winter of 1847-'8 in Italy. He went to Constantinople in July, 1848, where he was confirmed in his rank of viceroys.

**IBRAHILA.** See BRAILA.

**IBYCUS,** a Greek lyric poet who lived in the middle of the 6th century B. C. He was a native of Rhegium in Italy, and lived at the court of Polycrates, tyrant of Samos. It is narrated that while travelling near Corinth he was mortally wounded by robbers, and invoked a flock of cranes, then passing overhead, to avenge his death. The cranes directed their flight to Corinth, and hovered over the people in the theatre. The murderers were present, and one of them on seeing the cranes exclaimed involuntarily, "Behold the avengers of Ibycus." This led to an inquiry, and to the punishment of the assassins. The poetry of Ibycus was mostly erotic, but sometimes mythical and heroic. But a few fragments of his works are in existence, the best edition of which is that of Schneidewin (Göttingen, 1835).

**IOA,** an inland town of Peru, capital of a district of the same name, in the department and 170 m. S. S. E. of the city of Lima; pop. about

7,000. It is situated in a sandy plain, and the heat is excessive; nevertheless, Ica exports immense quantities of wheat and other grains, exquisite olive oil, and superior wines and brandies, through its port, Pisco, 48 m. N. N.W., to which place a railway has been in operation since 1872. The cost of the line was \$1,364,062 50. An extensive trade is also carried on in fish taken on the Pacific coast. There are several schools, which are well attended. In the adjacent district are found species of stones called *dentritis*, which when polished present curious views of trees, plants, edifices, &c.

**ICARUS.** See DÆDALUS.

**ICE,** water or other fluid solidified by freezing. Various liquids become partially solid at low temperatures, but this is commonly owing to the water of which they are in part composed; and none of them produce a clear uniform solid like that of frozen water. At 32° F. under ordinary circumstances water begins to crystallize. Slender prisms, usually of six sides, and terminated by six-sided pyramids, form in it, and arrange themselves in lines crossing each other at angles of 60° and 120°. The presence of salts in solution impedes this process, and when at last it takes place at a temperature below 32°, the greater portion of the foreign matter is excluded from the ice, which consequently is nearer the composition of pure water. Advantage is taken of this in some operations designed to concentrate the strength of liquors, as of vinegar, the portion that first crystallizes by cold being removed, and leaving the residue less diluted. Pure water contained in a polished vessel and kept perfectly quiet may be reduced to several degrees below the freezing point without freezing; but agitation or the introduction of foreign bodies will cause congelation to take place suddenly, and as the ice is formed latent heat is liberated, and the temperature rises to 32°. Saline solutions sometimes exhibit a similar reluctance to deposit their salts in crystalline form even when reduced by evaporation below their point of saturation; and in these cases crystallization is often suddenly induced by the same methods that cause the water to congeal. From about 39° water expands as its temperature is reduced, with the exertion of prodigious force. A hollow globe of brass with a cavity only an inch in diameter, filled with water, has been burst by the freezing of this, exerting a force, as estimated, of 27,720 lbs. The effect of this property is seen in the tendency of ice to plough up the banks of ponds, to split off masses of rock from mountain cliffs, and to loosen and pulverize the soil through which it is diffused. The effect last named is not perceived till the thaws of spring, when the frost is said to come out of the ground. This force has been artificially applied to splitting rocks and trunks of trees by allowing water to freeze in their fissures. This expansion, estimated by Boyle at one ninth the original volume, gives to ice less density than that

of water, so that it floats. Its specific gravity by this estimate should be 0.9; M. Brunner in his series of experiments found it to vary from 0.918 at 0° C. to 0.92025 at -20° C. But for this exception, which is however not a singular one, to the usual law of increase of density by reduction of temperature, ice as it forms would sink to the bottom, and there accumulate beyond the reach of atmospheric heat; great collections of water would be chilled throughout, and their fitness for sustaining life in cold regions be entirely destroyed. But as the ice, a bad conductor of heat, covers the water, it serves as a protecting sheet to retain the warmth below, and preserve the water from the extreme temperature that prevails above. As the cold increases, the solid ice is found to be subject to the usual law, contracting as found by Brunner more than other solids; and upon ponds in excessively cold weather it contracts, and in shrinking parts asunder in the weakest places with loud reports. A form of ice called anchor ice is often seen in cold weather attached to objects at the bottom of streams. Its character is explained by Prof. Dewey on the supposition that the whole body of water is cooled below the freezing point, but under conditions of quietness opposed to the formation of ice. The substances at the bottom serve as points of congelation, like those introduced into saline solutions to cause crystallization to take place, and ice forms upon them. It is observed to gather in a clear cold night, when the surface of the water is not frozen, and its temperature is at the freezing point, that of the air being still lower. The layers of ice are sometimes 3 in. thick; and as soon as they are detached from the bodies which hold them down they rise to the surface. In some of the crevasses of the Alpine glaciers immense icicles from 20 to 30 ft. long were found by Tyndall, hanging from the coping of snow which lines the edges of the chasms. Near the poles, and on mountains at a certain height in all latitudes, there are immense masses of what may be considered permanent ice; and there are said to be places in Siberia, even where there is a limited culture of the ground, where ice is always found at a certain depth below the surface. In a well which was sunk at Yakutsk the earth was found firmly frozen to the depth of 363 ft., some of the strata being entirely of ice. From the exposed polar ice fields and glaciers great masses become detached and form icebergs. (See ICEBERGS.)—The regelation of ice, a phenomenon first distinctly observed by Faraday, has recently attracted much attention, especially in regard to a controversy on the subject of glaciers. Regelation takes place between blocks of ice where they are strongly pressed together, even in warm water, and in cold water it will take place when the masses only touch each other. When fragments of ice are subjected to pressure in a mould, they may be formed into a solid block. When but little

re is used, it is necessary that the ice be but little below the freezing point. The explanation of snow-ball making, the freezing point of water is lowered by re, it is easy to understand how this formation of solid blocks from fragments may take place. A certain degree of viscosity, upon liquefaction, is produced, by which particles are reunited, and are firmly held on as the pressure is removed or lessened. Motions of glaciers, attended as they are by strations in the form of immense masses is explained by this property that ice liquefying under enormous pressure. Strains of ice squeezed into crevasses must be a force which we probably cannot produce by any artificial means, and as a consequence the ice may be made viscous when at a temperature considerably below the freezing point.

For other properties of ice, see GLACIERS, SNOW, and FREEZING, ARTIFICIAL.—ICE. Ice was little known as an article of commerce until the early part of the present century. In the 17th century its use was so common in France that many dealt in it and in gathering these in winter and packing closely in pits surrounded with straw or non-conducting substances and protected by air. The Italian peasants also have found a profitable business in collecting snow upon the Apennines and storing it in caves of these mountains to supply the demand at Naples. The bodies of ice in the recesses of Mount Etna, and extend sometimes from beneath beds of lava have flowed over them, are noticed in Sicily. In the last century the practice of storing ice for summer use is to have been practised in some of the states of the American Union, the rules for preserving it being deep cellars, so as to be readily drained, or from the water was pumped out as it collected though most wanted in countries it is not naturally produced, no attempts were made to transport it by sea. This was first done by Mr. Frederick Tudor of Boston who sailed with a cargo of 130 tons in a brig to Martinique in 1805. He persevered in the business, though making little or no profit till after the close of the war of 1812. In 1817 he obtained the monopoly of the Havana and important privileges from the government. In 1817 he introduced ice into Charleston, S. C., the next year into Savannah, and in 1820 into New Orleans. Several disasters attended his enterprises, and his entire shipments amounted to only 200 tons, the whole of which came from Cambridge. In May, 1833, he shipped his first cargo of ice to the East Indies, which was delivered at Calcutta in the autumn of that year. Of 180 tons, one third was wasted on the voyage, and 20 tons more in going to the Ganges. It was packed in large blocks fitted together between a double plank

case filled in with dry tan. The ice was sold immediately at half the cost of that prepared by the natives. At the present time a waste of about one half is generally expected on this voyage. In 1834 the first cargo was shipped by Mr. Tudor to Brazil. Until 1836 he conducted the whole trade; but as it became profitable others began to enter into it, and from other ports besides Boston. That port, however, still has the great bulk of the trade, the shipments having been as follows, according to the incomplete returns that have been preserved:

In 1805.....	180 tons.	In 1866.....	124,751 tons.
" 1816.....	1,200 "	" 1868.....	105,618 "
" 1826.....	4,000 "	" 1870.....	78,808 "
" 1836.....	12,000 "	" 1871.....	109,296 "
" 1846.....	65,000 "	" 1872.....	98,859 "
" 1856.....	144,000 "	" 1873.....	61,266 "

Of the amount shipped in 1873, 80,833 tons went to coastwise and 50,938 tons to foreign ports. The total exports from the United States to foreign ports for the year ending June 30, 1873, were 53,553 tons, valued at \$188,095, of which 48,890 tons, valued at \$175,848, were from Boston; 14,449 tons were shipped to Cuba, 13,842 to the East Indies, 10,186 to the British West Indies and British Honduras, 4,892 to British Guiana, and the rest to other portions of the West Indies, South America, &c. Into the interior ice has been carried by railroad in considerable quantity as far as Knoxville, Tenn. Some ice was formerly shipped to England, but the British market is now entirely supplied from Norway, the Norwegian ice being cheaper than the American, though of inferior quality. The imports into the United Kingdom in 1872 amounted to 139,421 tons, valued at £128,251. The chief difficulty in establishing the ice business in warm countries has been the necessity of constructing houses especially adapted for preserving the ice; and these to be profitable must be upon a large scale. One of these erected in 1845 at Calcutta, by Mr. Wyeth of Cambridge, covered more than three fourths of an acre, and was capable of holding 80,000 tons of ice. Its walls of brick were triple, with flues or air spaces between; their length was 198 by 178 ft., and their height 40 ft. The building was covered by five roofs, and between every two contiguous ones were air spaces.—New York city is supplied with ice chiefly from small lakes near the Hudson river, or from the river itself above Newburgh. The whole amount gathered when the season is favorable is about 1,160,000 tons, of which 200,000 tons are from the lakes (Rockland lake in Orange co. supplying 80,000 tons), and the rest from the river. Deducting one third for wastage, we have 774,000 tons, the amount required to supply the present demand of New York and Brooklyn. The demand increases at the rate of about 70,000 tons a year. With the growth of the business upon the coast it has also spread in the interior, where, especially near the large towns, the gathering of ice is now an important business. The great

lakes furnish supplies which are carried by railroad to the cities lying south, and through the Illinois river ice is sent down the Mississippi. In the autumn the ice boats come up to the vicinity of Peru, Ill., where they are allowed to be frozen in. In the winter they are filled, and in the spring when the ice breaks up they float down with their freight. The ice produced in deep ponds by the severe cold weather of New England is particularly adapted by its hardness and compactness to keep well, while the purity of the water gives it clearness and renders it especially agreeable. The ice obtained from the Kennebec river is most celebrated. That formed upon the shallow waters of Great Britain is found to be porous and very inferior in durability to that from the United States of the same thickness. —The methods of gathering and storing ice are entirely American. When the ice is 9 in. to a foot thick, or if for exportation 20 in. thick, the snow, if there be any, is cleared off the surface with wooden scrapers, each drawn by one horse. Another scraper armed with a steel blade planes off the porous upper layer to the depth of 3 in. or more if necessary. The surface is then marked off in large squares by a sort of plough drawn by a horse, which cuts a groove about 3 in. deep. A machine somewhat like a harrow, with three or more parallel rows of teeth, which may be 22 in. apart, is next drawn along the lines already made, one row of teeth running in the grooves as a guide; and as many more cuts are made as there are more rows of teeth. This is repeated upon the cross lines, and the whole area is thus cut into small squares. If necessary, a deeper plough is afterward run through all the grooves to increase their depth. A row of blocks is then sawn out by hand, and being taken out or thrust under the others, room is made for splitting off the adjoining squares, which is done by an ice spade dropped into the grooves. In very cold weather the ice yields readily to a slight wedging force. The blocks are sometimes floated through the canals opened in the ice to the shore, where they are hoisted out; and they are also sometimes jerked with a hook at the end of a pole up a slide upon a platform placed at the edge of the opening, and from this platform they are slid along on the sleds which convey them away. At the ice houses the blocks are raised often by steam power up an inclined plane to the top of the building, and thence let down another plane to any part within where it is required for packing. The storehouses, huge wooden buildings without windows standing around the edges of the ponds or along the banks of the rivers, present a very singular appearance. They are from 100 to 200 ft. long and very broad, with a capacity sometimes exceeding 20,000 tons. One at Athens on the Hudson holds 58,000 tons, and two at Rockland lake in Orange co., N. Y., hold 40,000 tons each. Around Fresh pond at Cambridge, Mass., there is a

large number of these buildings. Between their walls they are filled in with saw dust. As the season of the ice harvest is short and uncertain, the gathering of the crop is conducted with the greatest activity at favorable times.

**ICEBERGS, and Ice Islands,** floating masses of ice gathered on the coast of polar regions, and set adrift by force of winds and currents. Many icebergs are produced from glaciers, which, thrust down from the elevated snowy lands in the interior, are moved onward into the deep waters, where the fragments broken off from the advance border are floated away. The edges of glaciers extending many-miles along a precipitous coast have been seen to fall with terrific violence into the sea beneath, and at once be transformed into floating islands of ice. These carry with them the masses of rock gathered up by the ice in its progress as a glacier, and transport them to new localities in warmer latitudes. (See *DILUVIUM, and GLACIER.*) Ice islands of vast extent are also produced by the breaking up of the great fields of sea-made ice which accumulate along the shores of the frigid waters. In 1617 the ice covering several thousand square miles of the sea N. of Iceland, and chiefly on the E. coast of Greenland, most of which, it is believed, had not been moved for nearly 400 years, was suddenly broken up and dispersed over the waters of the North Atlantic. Portions of it were carried far to the eastward of the usual range of icebergs from the north, and approached within 800 m. of Ireland, or to lon. 32° W. The breaking up of this ice led to the expedition of Capt. Ross, the second of the present century in search of a northwest passage, the opinion prevailing that the climate had essentially changed, and that the northern seas would continue open. The drift of the northern icebergs is with the great polar currents, one of which sets in a S. S. W. direction between Iceland and Greenland, and another along the W. side of Baffin bay, meeting the former near the coast of Labrador. They are brought against the American continent and the W. shores of its bays in consequence of not catching at once the more rapid rotating motion of the earth as they pass upon larger parallels, and so allowing this to slip from under them. The greatest numbers are produced on the W. side of Greenland; and, as observed by Dr. Kane, "perhaps the most remarkable place for the genesis of icebergs on the face of the globe" is at Jacob's bight, an inlet a little N. of Disco island, in about lat. 71° and lon. 56°. From Labrador the ice is floated with the current past Newfoundland, and meeting near the Great Bank the warming influences of the Gulf stream, it usually disappears about lat. 42°. The extreme limit is in lat. 40°. Sometimes the ice is carried as far to the eastward as the Azores. In the southern hemisphere icebergs drift still nearer to the equator, being occasionally seen off the cape of Good Hope. As they reach their southern limit in the north-

ern hemisphere their influence is felt in sensibly cooling the waters of the Gulf stream for 40 to 50 m. around, and on approaching them the thermometer has been known to fall 17° or 18°. When driven, as they sometimes are, in large numbers into Hudson bay, they diffuse intense cold over the northern portion of the continent. The floating masses assume a variety of forms. Some spread out into sheets, which cover hundreds of square miles and rise only a few feet above the water. These are called fields, or, when their whole area can be defined from the mast head, floes. A number of sheets succeeding each other in one direction constitute a stream, or lying together in great collections, a pack. The surface of the sheets is often diversified by projections above the general level, which are called hummocks; they are forced up by the floes pressing against each other, and are sometimes in the form of great slabs supported by one edge. Dr. Kane noticed that these become bent by their own weight, even when the thermometer continues far below the freezing point. The most solid clear ice exhibits this yielding property of its particles. The surface of the ice fields is usually covered with snow, and when the ice is no more than 2 ft. thick it gives no trace of salt on the surface. The thicker ice contains open pools of fresh water. The bergs are real floating mountains of ice, rugged and picturesque, with peaks jutting high into the air, and strange forms in the glittering hard blue ice, which one easily converts into imaginary castles and grotesque architectural designs. They are occasionally seen in great numbers moving on together. Dr. Kane in his first cruise counted 280 in sight at one time, most of which exceeded 250 ft. in height, and some even exceeded 800 ft. The dimensions of the largest are measured by miles. Lieut. Parry in the first expedition of Ross encountered one in Baffin bay, 7 leagues from land, the length of which was 4,169 yards, its breadth 3,889, and its height 51 ft. It was aground in 61 fathoms. Its cliffs recalled those of the chalk on the coast of England W. of Dover. Dr. Kane saw one aground in soundings of 520 ft. which with every change of tide swung round upon its axis; and Capt. Ross describes several he saw aground together in Baffin bay in water 1,500 ft. deep. The officers of the French exploring expedition in the Southern ocean measured several bergs from 2 to 5 m. each in length, and from 100 to 225 ft. high. Capt. Dumont d'Urville reports one in the Southern ocean 13 m. long, with vertical walls 100 ft. high. The portion of these masses of ice seen above the water is only about an eighth part of their entire bulk. Such bodies, weighing hundreds of millions of tons, moved on by a broad current of water, exert a power against obstacles of which we can form little idea. In their action upon the bottom of the sea, as explained in the article *DILUVIUM*, many geologists recognize a repetition of the phenomena

accompanying the distribution of the drift formation, and the production of its sands and gravel and rounded bowlders. Dr. Kane remarks of the display of power exhibited by the movements of these huge bodies as follows: "Nothing can be more imposing than the rotation of a berg. I have often watched one, rocking its earth-stained sides in steadily deepening curves, as if to gather energy for some desperate gymnastic feat; and then turning itself slowly over in a monster somerset, and vibrating as its head rose into the new element, like a leviathan shaking the water from its crest. It was impossible not to have suggestions thrust upon me of their agency in modifying the geological disposition of the earth's surface."—Icebergs occur in great numbers in the North Atlantic in the latter part of the summer, and form the chief danger which then besets the navigation between Europe and North America. These mountains and fields of ice, however, have sometimes served as a means of safety to persons who have taken refuge on them, or floated off with them accidentally. Several members of Hall's exploring expedition were in 1872 rescued from a floe on which they had drifted 196 days and a distance of 2,000 miles. (See *ARCTIC DISCOVERY*.)

**ICELAND**, a large island in the North Atlantic ocean, subject to the Danish crown, geographically belonging to the western hemisphere, about 160 m. E. of Greenland, 600 m. W. of Norway, 500 m. N. W. of the Shetlands, and 250 m. N. W. of the Faroe islands. It is situated between lat. 63° 24' and 66° 38' N., and lon. 13° 31' and 24° 17' W.; greatest length 825 m., greatest breadth 200 m.; area, including adjacent islands, 89,758 sq. m., of which 16,248 are habitable. The population of Iceland in its most flourishing period exceeded 100,000; recent censuses give it as follows: 1864, 68,084; 1869, 69,506; 1870, 69,768. Reykiavik, the capital, has a population of about 1,400. In shape Iceland somewhat resembles a heart with its apex to the south. The coast line on the south is but little broken, several of its openings having been filled up during eruptions of the neighboring volcanoes; but in all other directions it is deeply indented with bays, fiords, and jutting promontories. The fiords extend far inland between lofty mountains, whose sides are carved into gigantic terraces. The principal of these is Isafjord in the N. W. peninsula. The western fiords are studded with rocky islets, and open, like those of the north and northeast, to enormous ice drifts. The chief islands on the coast are the Vestmanna isles in the south, which form a county by themselves. The best harbors are those of Reykiavik, in a bight of Faxafjord, in the southwest, Hafnarfjord in the west, Akureyri on the Eyjafjord in the north, and Vopnafjord in the east.—Iceland is apparently of volcanic origin; its surface in the interior is composed of an elevated band of palagonite tufa pierced by trachyte, and having basalt on either



side. This basalt, the oldest formation, underlies the other two, the palagonite, which is next in age, and the lava, comprising all the strata due to recent volcanic action. Although the N. W. peninsula is composed of lofty ridges with here and there an extinct volcano, the chief mountain system is in the south. It forms a triangular mass, with its apex at Thrandar Jökull in the east, and its base extending from Ok in the west to Eyjafjalla in the south. Toward the apex the great Vatna Jökull group covers an area of 3,500 sq. m. with its gigantic glaciers and snow fields. The mountains are distinguished into fells, which are generally free from snow in summer, and jökulls or ice mountains, which are shrouded in perpetual snow. The name of *skul* is given to perfectly symmetrical mountains. The principal jökulls are the Orafa, 6,405 ft., the eastern Snæfell, 5,958 ft., and the western Snæfell, 4,639 ft. The volcanoes belong to all three classes. Beyond the mountain masses lies the great central table land, from 1,500 to 2,000 ft. above the sea, and forming a wilderness covered with vast lava beds, barren heights or rolling rocky uplands, tracts of black volcanic sand, hillsides and valleys dotted with hot springs and sulfataras, and bottom lands filled with bog and mud. Over this desert three main roads, or rather tracks, connect the settlements near the fiords and the rare low plains and valleys extending inland along the water-courses. The most remarkable and fertile valleys are those clustering around Eyjafjörð in the north, that of Lagarfjöt in the east, and those of the Hvita and Thjorsa in the south. Volcanic action has manifested itself over a broad belt of country, extending from Cape Reykjanes in the southwest to Krafla in the north. Within this belt are the principal volcanoes, including Hecla. (See HECLA.) From 27 different spots, counting volcanic craters in the sea off Cape Reykjanes, 86 eruptions have occurred since 874, the last being those of Skapta in 1861 and of Trölladyn-gjá in 1862. The lava has been thrown out from grassy plains in the north as well as from the enormous double chasm of Katla in the southern uplands. Of the lava beds, the Odatha Hraun covers 1,160 sq. m., a second extends 73 m. from Skjaldbreith and Klöthufell to Reykjanes, and a third, around Hecla, is 25 m. long and 10 m. broad. Another peculiarity is what is called the *gjá* or rifts in the deep lava beds, which are zigzag rents running from northeast to southwest. The most remarkable are the Almanna-gjá and Hrafn-gjá at Thingvellir, and the rift into which pours the Jökulsa at Dettifoss.—The principal lakes in Iceland are the Myvatn (Midge lake) in the north, much diminished in depth and extent by the lava streams from Krafla in 1724-'30, and Thingvallavatn in the southwest, 10 m. long by 4 wide. There are besides two principal groups of lakes, those of the Arnarvatn (Eagle tarns) dotting a large district N. and W. of Eyriks Jökull, and Fiskivatn (Fish tarns) at the foot of Skapta, which are the remains of a large lake that existed previous to the eruption of 1783. The larger rivers take their rise in the southern mountains. The Jökulsa, reputed the largest, rises at the foot of Vatna, and flows N. to the Axafjörð. About 30 m. from the sea it falls over a perpendicular wall in its lava bed, forming a magnificent waterfall. The Skjal-fandafjöt has its source between Vatna and Arnasfell, and flows N. into Skjalfandi bay. The Jökuldalsa and the Lagarfjöt flow N. E. from the snow fields of Vatna. The most important rivers in the west and south are the Hvita (or, as it is called near its mouth, the Olfusa), Thjorsa, and Kudarfjöt. The most celebrated feature of Iceland scenery is the great number of intermittent hot springs, chiefly in the S. W. division, which have given the name of *geysers* to similar springs elsewhere. (See GEYSERS.)—The climate of Iceland seems to have changed greatly since its first settlement. The ice drifts from Greenland, which formerly visited its shores only every other year, have of late come for 15 years in succession, surrounding two thirds of the island with a compact mass, and remaining from three to five months. When it comes in January or February, it goes away in March or April; then it affects the ensuing vegetation but little, while it brings a welcome supply of whales. If it comes in April or May, it remains until the end of July, stopping vegetation and destroying all the crops. The average winter temperature at Reykjavik, 29° 8' F., is higher than at Aberdeen, 26° F.; the average summer temperature is 53° 6', and that of the whole year 39° 4', being about the same as that of Moscow the whole year round. At Akureyri, in the north, the average summer heat is 45° 5', that of winter 20° 7', and the mean for the year is 32°. The difference of climate between the north and south of the island is attributed to the Gulf stream, which sweeps round the S. and S. W. coasts. In the south great quantities of rain fall in winter and summer, and sharp winds are frequent; thunder, except in winter, is very seldom heard. The climate of the north is much more dry and regular.—The lowlands and protected valleys afford excellent pasturage, where the soil contains all the elements of fertility. "The mountains," says Baring-Gould, "are generally destitute of herbage, and the valleys are filled with cold morasses. Grass springs on the slight elevations above the swamps, in the dells, and around the lakes. By drainage a large percentage of marsh might be reclaimed; but some must always remain hopeless bog. The extraordinary amount of swamp is due to the fact that the ground is frozen at the depth of 6 or 8 ft., so that when there is a thaw the valleys are flooded, and the water, unable to drain through, rots the soil." Many bottoms are filled with an amazing depth of rich soil, yet the prevalent ignorance of agricultural methods prevents their being turned to any ad-

The luxuriant herbage on the sloping fields consists of several kinds of mingled with the leaves of stunted which is greedily devoured by the dwarf mountain birch. On the fields grow several kinds of sedge, and the some field is overstrewn with the yellow-cup. Iceland is almost a treeless

in certain spots are low coppices of trees being mere shrubs 10 or 12 ft. tall in one or two protected places only. Mountain ashes about 80 ft. high excite the admiration of the natives. Hay raised in Iceland is the chief crop; a few patches are occasionally seen in sheltered situations even these do not always ripen. No grain is raised; but a species of rye (*elymus arenarius*) growing on the coast by the sea affords a much prized harvest. Straw is used for thatching and fodder. The meal, flavored with cinnamon, is made into very palatable thin cakes. Potatoes, cabbage, lettuce, spinach, parsley, and radishes are cultivated in small

The only other valuable vegetable grown is the Iceland moss of commerce. The fur has greatly improved of late years. Among the wild animals are several kinds of which are hunted for their skins, the most especially. Bears are frequent visitors to the island on the ice drifts from the north. Reindeer were imported from the continent about 1770, and now roam in large numbers in the solitudes of the interior; though they are of little use for locomotion, their utility is almost overlooked. The seal breeds everywhere on the coast and its numerous islands; it is also seen, sometimes in flocks, in the fjords and bays, as well as a shark in these waters (*scymnus microcephalus*). Cod, herring, haddock, halibut, salmon, and eels abound in the fiords, fresh-water lakes and rivers. Shell mussels especially, are present in enormous quantities. There are in Iceland 7 families

34 species of mammals, of which 24 live on the water, and 13 varieties of cetacea. Birds are everywhere; among the indigenous are the Iceland falcon, ptarmigan, golden plover, harlequin duck, and northern wren. The golden plover is jealously protected by the natives. There are 6 families and about 90 species of birds, of which 54 are water fowl. Fishes have ever been discovered. Of which are as yet but little known, Faber discovered 49 varieties, of which 7 are fresh-water. Domestic animals constitute the wealth of the Icelanders; these are cows, sheep, and goats in the north. In 1849 there were in the island 352,443 sheep, 108,000 horses, and 18,189 cattle. The early settlers introduced geese and swine; but these are now all wild, and the hog has disappeared. The dog is of the Esquimaux type, and is used by the farmer.—Mineral

showing the presence of copper, iron,

lead, and silver, are found in many places; but, from their poorness and the absence of fuel, no attempt has been made to work them. Plumbago was discovered near Krafia by Baring-Gould, and magnetic iron abounds among the volcanic rocks. The chief sulphur deposits are at the vapor springs of Hengill near Thingvalla lake, at Krisuvik, and in the neighborhood of Myvatn. In the latter region is "Obsidian mountain," a ridge in many places composed of pure obsidian, which might be a source of public wealth. There are feldspar, chalcidones, zeolites, amethysts, topaz, opal, porphyry, and malachite. One of the most singular formations of Iceland is a kind of brown coal called *surturbrandr*, which lies in beds between clinkstone and trap; it consists partly of carbonized stems of trees, partly of a more coherent layer of coal mixed with schist, and is of no importance as a source of national wealth.—The modern Icelanders are the descendants of the Norwegians who settled in that country in 874 and the following years; a few colonists from Ireland and Scotland had also settled in the country previous to the Norwegian discovery, or came thither afterward. The language spoken by all is the purest Norse. The men are tall, fair-complexioned, and blue-eyed, with frames hardened by constant exposure to the weather. Recent travellers complain of their tendency to idleness and intemperance; but they are strictly upright, truthful, generous, and hospitable. The women are industrious and chaste. Religious faith and the domestic virtues are traditional in every household. Education is universal; it is almost impossible to find an adult unable to read and write. The settlements are chiefly scattered along the coast, and in certain sheltered valleys and lowlands, the most populous district being in the neighborhood of Skagafjord in the north. Social as well as commercial intercourse is extremely limited. There is nothing in the whole island that can be called a road; no vehicle of any kind is used on land; locomotion both for man and merchandise is only practicable on horseback and at certain seasons. A very few houses are of stone, a few of wood, but the greater number are partly of turf and partly of lava blocks pointed with moss and thatched with sod. Coal is only to be had in the towns; elsewhere the only fuel consists of sheep dung mixed with fish bones. No fire is made save in the small kitchen even in winter, and that only to prepare food, the other rooms in the farm house remaining damp and foul. In the Vestmanna islands and in many places on the mainland, portions of the sea parrot and petrel are dried, mixed with manure, and used for fuel. The main staple of food is stock fish, which is eaten with sour butter. The only meat is mutton, which is boiled, then pressed dry, cut into lumps, and laid by without salt; sometimes it is also stewed in milk. The first necessities of life are imported. The least mortality (128)

is in February, the coldest month, and the highest (205) in July, the warmest. Cutaneous diseases, occasioned by want of cleanliness and proper nourishment, are most prevalent; diarrhoea is frequent in spring; typhus and small-pox have often swept away multitudes; leprosy is not uncommon, especially on the islands, where it takes the form of elephantiasis. Consumption is unknown, owing probably to the purity of the air and its being charged with ozone.—There are no manufactures of any kind, only the simplest articles of consumption being woven in the homestead. Several of these, such as guernseys and mittens, are exported. The commerce of Iceland had been quite flourishing during the period of its independence; active commercial relations were kept up with Norway, England, and Germany till the union of Norway with Denmark in 1387, when the Danish crown began usurping a complete monopoly, and finally (in 1602) farmed out the trade with Iceland to a Copenhagen company. This monopoly was abolished in 1853, and at present the only restriction to free intercourse is the taking out a trade license amounting to about 50 cents per ton of the ship's burden. Foreigners enjoy the same rights of residence, holding property, and trading, which belong to the natives. The fisheries of Iceland, if carried on with a proper degree of intelligence, would prove an exhaustless source of wealth; but only 10 per cent. of the population are fishermen, and the methods used are inefficient. Along the coast are 34 authorized trading posts, of which only 27 are used; of these, 6 are in the south, 11 in the west, and 10 in the north-east; 62 merchants reside in these, 26 being Icelanders, the others Danes or representatives of Danish houses. There are no banks. The trade is by barter; the Icelanders are entirely in the merchant's power and must accept his prices. Attempts to break up this monopoly have recently been made by a Norwegian company of Bergen, which has an establishment at Reykiavik, and branches in Hafnarfiord and other places. There is but one native ship in the foreign trade. In 1869 the number of foreign vessels which visited the trading stations was 99 from Denmark, with a tonnage of 9,358, and 50 from other countries, with a tonnage of 4,555. The principal imports are cereals, wheaten bread, coffee, sugar, spirits, snuff, and tobacco. A decrease is perceptible of late in the quantity of brandy imported, although even now it amounts to 24 quarts annually for every adult male, besides rum, punch extracts, and other spirituous drinks. The principal exports are fish, both salted and dried, salt roe, liver oil, salt meat, tallow, sheepskins, wool, guernseys, stockings, mittens, coarse woollen stuff called *valmel*, eider down, feathers, and horses; the whole valued for 1869 at about \$700,000. Formerly considerable quantities of sulphur were exported; but owing to the absence of fuel and the inaccessibility of the mines, as well as the want of remunerative demand,

they have not been worked for many years. An Englishman has lately obtained a 50 year lease of the sulphur mines near Myvatn, which will acquire commercial importance when the mines of Sicily are exhausted.—There are but few primary schools in the island, but parents, teaching their children all they know themselves, are careful to send them for further instruction to better informed neighbors. The books and manuscripts in the house, as those to be found within a radius of 50 miles, are read aloud over and over again to the children and discussed by them. Moreover, the law enabling the pastor or overseer of a parish to remove the children of careworn parents, and board them with others who will teach them. This is done at the expense of the parish when the parents are too poor. At Reykiavik there is a college with six professors, embracing a complete classical, literary, and scientific course; there is also a school of theology with three professors, and a school of medicine with two. Students in the school of philology go to Copenhagen. Recently a library has been formed in Reykiavik, which comprises 10,000 volumes in 1866. Two periodicals were published in Reykiavik in 1866, the *Thjotholfr* or "National," weekly, and the *Islandingur*, fortnightly. The *Northman*, a weekly, was published at Akureyri. The royal charter granted on Jan. 5, 1874, went into operation on Aug. 1 of that year, and gives to Iceland a minister residing in Copenhagen and responsible to the *althing* for the acts of the administration in Iceland. The executive government of the island is vested in the *stiftamtmand* or governor general, residing at Reykiavik, and having under him two deputy governors, residing respectively in the northern, western, and eastern parts of the island, the *stiftamtmand* himself has immediate jurisdiction of the southern. The *amts* are divided into counties or *sýsla*, each having its own officer or *sýslumaður*. All these officials are appointed by the crown. In each county is a court presided over by the *sýslumaður* and two assessors; and from its decisions there is an appeal to the supreme court and the justice at Reykiavik. For the revenue is a *landfógeti*, who is both collector general of the whole country and town collector of the capital. Akureyri, recently created a municipal town, has also its local collector or *landfógeti*. The legislative authority, in everything that does not relate to the general interests of the monarchy, is vested in the *althing*, composed of 36 members, 30 of whom are elected by popular suffrage and 6 nominated by the crown. The ecclesiastical establishment, which is exclusively of the Lutheran faith, consists of a bishop of Reykiavik, who with the general forms the spiritual court, and 20 deaneries, subdivided into 196 livings. Attached to this is the pastoral seminary at Reykiavik. The clergy are appointed by the crown, subject to the consent of the bishop.

or the most part embrace very large and their revenues being utterly inferior for their support, they have recourse to the smiths; they have the reputation of being blacksmiths in Iceland. There are four districts, with medical officers stationed at Reykiavik, Vatnsdalr, and Akureyri, the west, a fifth in the south, and a sixth in the Vestmanna islands. Quite recently missionary stations have been established in the Roman Catholic church. Christianity was made the national religion in 1000 by the king. The island was afterward divided into four bishoprics of Holar and Skalholt. "The laws," says Baring-Gould, "were elected at the *athing*, and even the saints were chosen by popular acclamation." With the union of the church came the knowledge of Latin letters. In the year 1057, Bishop of Skalholt, introduced the art of writing with the Latin alphabet. Monasteries, hospitals, and schools were established. The monks, especially the Benedictines of the monastery, contributed largely to the culture of Iceland's golden era. In 1551 the reformed form of worship was introduced by King Christian III., and after much bloodshed the only established religion; but much of the ceremonial still remains. There is no divine service, and the morning service is known as "the mass;" the minister wears the old chasuble and cope, and over his shoulders can be seen triptychs, crucifixes, and pictures of saints.—Iceland was discovered in 874 by Leif Eiriksson, a Norwegian viking, who named the island Snjaland (Snowland). In 874 it was discovered by Garthar Svafarsson, a Swede, who landed around it and wintered on the east coast of Skjalafandi bay, and called his discovery Askolmr. Enticed by the description given of it, Floki, another viking, landed at Vatnsfiord in the west, and took possession of a portion of land. But the loss of a portion of the land during the winter compelled him to give up his settlement. After spending the winter at Hafnarfjörður, he returned to Iceland in the summer. The island received its name from him; and the glowing report of it by some of his companions led two Norwegian chieftains, Hflorleifr and Hflorleifr, to visit it. They formed the first permanent settlement in 874 at Reykiavik, where they lived with their retainers and thralls until they were driven away by the Danes. The monument of Icelandic literature, says the first colonists, who were all pagans, but they had been preceded by Culdees and Irish settlers, who abandoned the island on the arrival of the pagan Norsemen. The report of an Irish monk had first led some of his brethren to sail for the north, at the Faroe islands, and reaching Iceland in 725, where they settled on the islet of Hflorleifr on the E. coast, and at Papyle in the north. They were called Papar by the Danes, and left behind them bells, crosiers,

and Irish books. The oppression of Harold Harfagr drove a large number of Norwegian chiefs and their families to Iceland, and this was further increased under the reign of St. Olaf. About 928 Iceland became a republic, and so remained for 300 years. In 930 a code of laws was adopted, and an annual meeting of the *bonder* was fixed for midsummer on the plains of Thingvalla; this gathering was called *athing*. In 1262 the majority of the people took an oath of allegiance to Haco, king of Norway, Iceland remaining independent, with her own laws and constitution, and the *athing* continuing to be the supreme legislative authority. After the union of the Danish and Norwegian monarchies in 1387 the king of Denmark was acknowledged sovereign of Iceland. A provision in the act of union of 1262 stipulated that the king should annually supply the inhabitants with six ship loads of goods. This gradually made the commerce of Iceland a royal monopoly, and in 1602 it was farmed out to a Copenhagen company, in whose hands it remained till 1787. As Iceland only raises cattle and chiefly exports dried fish and wool, its people were thus placed at the mercy of the traders for the bare necessaries of life. The price of goods rose four fold during the next three years, while the price of fish fell, the domestic industries dwindled away, poverty increased, and the population decreased in the same ratio. During these three years 800 persons died of starvation in one district, and 9,000 perished in the whole island. Notwithstanding these facts, the Danish government continued to enforce its own trade laws, and in 1684 a royal proclamation enacted that all traffic must pass through the Copenhagen company, and that on no conditions should the Icelanders trade with others, "neither on land, nor on sea, nor in the harbors or fiords, or in any other place whatsoever." In the 18th century volcanic eruptions repeatedly desolated the land, converting some of the most fertile and populous districts into hideous wastes, and followed by famine and disease. In 1762 an epidemic broke out among the sheep, and 280,000 died or had to be slaughtered. In 1783, the year of the most fearful eruption, 11,000 cows, 27,000 horses, and 186,000 sheep died. The population, which had steadily decreased since 1602, had sunk in 1785 to 39,000, and was further diminished by 9,000 deaths from starvation. In 1786 the project was seriously entertained of removing the remnant of the population from the country, but the royal commissioners demanded instead a relaxation of the trade laws. Commercial freedom came by slow degrees, prosperity returned, and the population increased. In the 16th and 17th centuries, when absolute monarchy was introduced, it was expressly stipulated by the Icelanders that, while acknowledging the sovereignty of the Danish crown, they should retain their own national laws, rights, and freedom. By degrees, however, the legislative powers of

the Icelandic althing were allowed to fall into desuetude. It was formally abolished in 1800, but restored in 1843. Subsequent attempts to supersede it by giving Iceland representatives in the Danish rigsdag, and to make Icelandic taxes flow directly into the Danish exchequer, met with unconquerable resistance. At present, under the royal charter of Jan. 5, 1874, the constitution of Iceland is closely modelled on that of Denmark, and its national independence under the Danish crown is acknowledged. It enjoys an independent judicial as well as legislative system, individual and religious freedom, municipal self-government, and equality of all citizens before the law. Interesting events in the history of Iceland were the discovery of Greenland by Eric the Red, and the establishment there of flourishing but short-lived colonies, and that of America by Leif and others, without any practical results. The one thousandth anniversary of the first permanent settlement of Iceland was celebrated in August, 1874.—The *Landnámabók* records the colonization of Iceland from 870 to 930; the *Sturlunga saga* contains its history from 1100 to 1264; its church history is found in the *Kristin saga* and in the *Biakupa sigur*, or lives of the bishops of Iceland. See "An Historical and Descriptive Account of Iceland" (Edinburgh "Cabinet Library"); S. Baring-Gould's "Iceland, its Scenes and Sagas" (London, 1863); and C. W. Pajkull's "A Summer in Iceland" (London, 1869).

**ICELAND, Language and Literature of.** *Islenska*, or *Islensk tunga*, the Icelandic tongue, is the language of the Scandinavians who settled in Iceland in the 9th century. The earliest name given to it in the old writings of the north, in the 11th and 12th centuries, was either the "Danish tongue" (*Dönsk tunga*) or "Northern language" (*Norrœna*, or *Norrœnt mál*). While the language became much altered in Denmark and Scandinavia, it remained essentially the same in Iceland, and the names of Danish, Norwegian, and Northern being no longer applicable to it, the term Icelandic came into use. By Norwegian philologists it is called old Norse or old Norwegian (*gammel Norsk*), while the Danish and German philologists frequently style it old Northern (*old nordisk*, *alt-nordisch*). Icelandic is a daughter of the old Norse proper, the dialect spoken as late as the 11th century in Denmark, Norway, Sweden, and the adjacent islands, and a sister of the old Norse dialect which is the parent of modern Swedish and Danish. It still preserves, with very slight inflectional and orthographical changes, its earliest known form, and is the oldest living language of the Teutonic family. (See GERMANIC RACES AND LANGUAGES.) Although its literary monuments, in their existing shape, do not date quite as far back as the Gothic version of the Bible, it has yet kept many old Teutonic forms which the Gothic had lost even in the days of Ulphilas. Hence its importance in Teutonic philology. In conse-

quence of the invasions of the Northmen, it influenced to a considerable extent the development of the English, and has furnished to the English vocabulary such words as *axe*, *take*, *call*, *law*, *till*, to the exclusion of Anglo-Saxon forms. The stationary character of the language is partly explained by its secluded position in an island, and partly by the zealous study by the Icelanders of the ancient songs and sagas. The first characters in which Icelandic was written were the runes (*rúnir*), which are supposed to be adaptations from the Phœnician alphabet. Each letter consisted of an upright stroke, to which various cross strokes were added. The letters were at first only 16 in number. It cannot be ascertained when these characters were introduced. They were chiefly used for inscriptions on stones, wooden sticks, weapons, and household utensils, and hardly for literary purposes proper. At the time of the introduction of Christianity they were superseded by the Roman alphabet, in the form then used by the Anglo-Saxons and Germans. The alphabet, including accented vowels, consists of 36 letters, and differs from the English in not using *c*, *g*, and *x*, and in having the letters *þ* and *ð*, the former with the sound of *th* in *this*, the latter with that of *th* in *thin*; the double letter *œ*, sounded like English *i* in *pine*; and lastly the letter *ð*. Until recently also *c* and *g* formed part of the Icelandic alphabet, but they were dropped, as their sounds are fully represented by *s* and *k*. Vowels are either accented or unaccented, and are accordingly either long or short. Masculine and feminine nouns have four declensions each, of which the first two have three variations and the last two only two. The neuter has three declensions, with four variations for the first and two for the second and third. There are two numbers and four cases, nominative, accusative, dative, and genitive. Adjectives have a definite and an indefinite declension, which resemble the old and new declensions of the substantives. Icelandic has only a definite article, which is suffixed to nouns and precedes adjectives, and is inflected in all cases and genders. The first and second personal pronouns have also a dual form. Verbs have active and passive forms; the indicative, infinitive, subjunctive, and imperative moods; an active and a passive participle; and a supine. They have only two simple tenses, past and present; the other tenses are formed with auxiliary verbs. The language has a great facility for forming new words. It does not adopt the common foreign names of science and new inventions, but a telegraph is called either *fréttaflyggir*, bearer of news, or *rafsegulþráðr*, electric thread, and a telegram *hráðfrétt*, quick news. The foreign words formerly introduced into Icelandic, chiefly by the clergy, are now so transformed that their origin can hardly be recognized. The dialect of the old Norse spoken in the Faroes, which has been illustrated in collections of ballads

ore made by Hammershaimb and fers from the Icelandic chiefly in or- and in the admixture of Danish he best Icelandic grammar is the dition of Wimmer's *Altnordische &* (Halle, 1871); the best lexicons y and Vigfússon's "Icelandic-Eng- nary" (Oxford, 1868-'74), to which it grammar is prefixed, and for the dic and eddic poetry Sveinbjörn *Lexicon Poeticum antiqua Lingua nalis* (Copenhagen, 1860); the best hy is Dietrich's *Altnordisches Les- sic*, 1864).—The Icelandic literature, h the exception of a few unimpor- egian productions, was written whol- id or by Icelanders, may be divided ery marked periods, the ancient and n. The first terminated a century all of the republic; the other com- period intervening between that date resent time. Soon after the settle- e island the genial influence of free it caused a marked development of al spirit, which was early exhibited of letters. The climate, as well as d position of the island, had also o with it. In the long evenings of ter, an intelligent people would nat- : recourse to literature; and as soon uction of Christianity brought e knowledge and use of the Latin he earliest employment of the new writing out the pagan songs which rally transmitted from one gener- ther. In such a manner the priest rífússon, called "the learned" (1056 some other early scholar, compiled r poetic Edda. (See EDDA.) Be- the poetry that has come down to e days of the republic consists gen- ongs of victory or of praise, elegies, ms, in which latter the old skalds xcelled. The most noted skalds of atury are Bersi Torfússon, Egill Skal- (904-990), Eyvind Finsson, Glúm Kormak Oegmundarson (died 967), Hromundarson (983-1012), Hallfred lied 1014), Thord Sigvaldaskald, and skonarskald. The 11th century was ic of poets; we have Arnor Thor- nar Helgason, Eirik, Gísli Illuga- ottar, Sighvat, Skúli Thorsteinsson, li, Hallar-Steinn, Stein Skaptason, adi, Thjóðólf Arnórsson, Thorarin, l Kolbeinsson. The 12th century e names of Bödvar, Einar Skúlason, jörn, Ivar Ingimundarson, and a host

In the 13th century we find scarce- es but those of Einar Gilsson, Gud- sson, Ingjald Geirmundarson, and arson, showing that the loss of lib- begun to affect the labors of the e 14th century has little of value to pt the singular poem *Lilja* ("The ung in honor of the Virgin by Ey-

steinn Asgrímsson. Nor were the historians and romancers less numerous. The sagas properly fall into two classes, fictitious and historical. Among the former are the *Völ- sunga saga*, *Nornargests saga*, the *Vilkina saga* (narrating the exploits of Diederich of Bern, and thus belonging to the same heroic cycle as the *Heldenbuch* and *Nibelungenlied*), *Hálfs saga*, "Saga of King Hrólfr Krúka and his Champions," "Saga of King Ragnar Ló- brók" (which contains the celebrated *Ló- brókarkvída*, or "Death Song of Lódrók"), *Frithiofs saga*, *Hercular saga*, *Oeruar Odds saga*, the sagas connected with the Arthurian and Carolingian cycles of romance, and Snorri Sturlason's "Younger or Prose Edda." Some of these are in part historical, but it is difficult to distinguish the true from the false. Far more valuable as well as more numerous are the sagas of the historical class. They consist of histories in the largest sense of the word, of local and family histories, and of biographies. Of those which relate to Iceland, the most noted are the *Isendingabók*, by Ari Thorgilsson (1068-1148); the *Landnámabók*, a detailed account of the settlement of the island; the *Kristin saga*, a narrative of the introduction of Christianity into Iceland; *Njáls saga*, a classic composition; *Gunnlaug Ormatunga saga*; *Viga Glúms saga*; *Egils saga*, the biography of a renowned poet and chieftain; *Kormaks saga*; *Eyrbyggja saga*, an abstract of which has been published by Sir Walter Scott; *Laxdala saga*; *Sturlunga saga*, a history of the race of the Sturlungar, so important in Icelandic history, by one of its members, Sturla Thórdarson; and *Grettis saga*. The chief sagas relating to other countries are: the *Orkneyinga saga*, a history of the Orkneian jarls; the *Færeyinga saga*, relating to the Faroes; the *Jomsækinga saga*, an account of the sea rovers, whose seat was at Jomsburg near the mouth of the Oder; the *Knyttlinga saga*, a history of the Danish kings from Har- ald Blaatand to Canute VI.; the sagas of Olaf Tryggvason, one by Odd (died 1200), and the other by Gunnlaug; the saga of St. Olaf; the *Heimskringla*, or "Chronicle of the Norwegian Kings," by the celebrated statesman and histo- rian Snorri Sturlason; and various minor sagas relating to Scandinavia, Russia, Great Britain, and Greenland. The most elaborate codes of law were the *Grágás*, *Járnáida*, *Jónabók*, and *Kris- tinréttur*. Many of the works enumerated in this list are masterpieces of style, and are still read with delight by modern Icelanders. This list (and it contains but a few of the published sagas) shows the attention paid to the culture of letters in a remote corner of the world, at a time when the whole continent of Europe was sunk in barbarism and ignorance.—The second or modern period of Icelandic literature by no means commences with the termination of the old literature; a long time of utter mental inactivity followed, and the 15th and 16th cen- turies produced scarcely anything but a few

unimportant religious books. In the 17th century the knowledge of the ancient literature and glory of the island began to revive. Foremost in the movement were Arngrím Jónsson (Jonas, 1568-1648), Gudmund André (died 1654), Rúnólf Jónsson (died 1654), Arni Magnússon (Magnæus, died 1730), and Thormóð Torfason (1636-1719). The last named, better known under his Latinized name of Torfæus, was especially zealous in his efforts to disseminate a knowledge of the early history of Iceland. In theology, Gudbrand Thorláksson (died 1627), under whose direction the first complete edition of the Icelandic Bible was issued, Bishop Thorlák Skulason, and Jón Víðalín (1666-1720), the author of a popular collection of homilies, were the eminent names; while jurisprudence was represented by Pál Víðalín (1667-1727). But the true revival of letters dates from the middle of the 18th century, and was coincident with the commencement of an increase in population. During the last hundred years no other nation can show so large a proportion of literary men. Finn Jónsson (1704-'89), author of an elaborate ecclesiastical history of the island, which has been continued by Pétur Pétursson (born 1808), Hannes Finsson (1739-'96), Jón Jónsson (1759-1846), and Arni Helgason (born 1777), were eminent theologians. Antiquities, philology, and the old literature have been largely illustrated by Hálfðan Einarson (died 1785), the author of an Icelandic literary history, Björn Haldórsson (died 1794), the compiler of a large Icelandic-Latin lexicon, which was edited by Rask, Jón Ólafsson (1731-1811), S. T. Thorlacius (1741-1815), G. J. Thorkekin (1752-1829), Hallgrím Schéving (1781-1861), Finn Magnusson (1781-1847), Konrad Gislason (born 1808), H. K. Fridriksson (born 1819), Jón Thorkelsson (born 1822), Gunnlaug Thórdarson (died 1861), and by Gudbrand Vigfússon, now (1874) the foremost Icelandic philologist. An elaborate history of the island, in continuation of the *Sturlunga saga*, has been written by Jón Espólin (1769-1836), while an extensive collection of folk lore has been made by Jón Arnason. The poetical literature of the period has been rendered remarkable by the names of Hallgrím Petursson (1614-'74), the author of the popular passion hymns, Jón Thorláksson (1744-1819), translator of "Paradise Lost," Bjarni Thorarensen (1786-1841), Jónas Hallgrímsson (1807-'45), Sveinbjörn Egilsson (1791-1852), translator of the *Odyssey*, Benedikt Gröndal (born 1826), translator of the *Iliad*, and many others. But the attention of the Icelanders has been largely given to political economy, and the result has been a rapid and marked improvement in the economical condition of the country. Particularly active in this respect have been Jón Eyriksson (1728-'87), Stephán Thórarinnsson (1754-1823), Magnus Stephensen (1762-1833), Bjarni Thorsteinsson, Thord Sveinbjarnarson, Baldvín Einarsson (1801-'33), Jón Jónsson

(born 1806), Pál Melsted (1791-1861), and Jón Sigurdsson (born 1811), equally noteworthy as an archaeologist and statesman. In natural history we find recorded the names of Eggert Ólafsson (1726-'68), whose tour through Iceland in company with Bjarni Pálsson is still one of the most interesting works on the subject, O. J. Hjaltalín (1782-1840), Jón Thorsteinsson (1794-1855), and J. J. Hjaltalín (born 1807). Among the younger writers, most of whose political opinions are liberal, are Gísli Brynjúlfsson (born 1827), Jón Thórlarson (born 1819), Magnus Grimsson, Steingrím Thorsteinsson, Sveinn Skúilason, and E. Magnússon, who has published English translations of several old Icelandic works. The series of transactions published by the *Lærdoms-lista Félag* in the latter part of the 18th century, and the numerous volumes issued within the past 25 years by the *Íslenska Bókmenntafélag*, or society of literature, are of great value.—The best sources of information in regard to the old literature are Petersen's *Bidrag til den oldnordiske litteraturhistorie* (Copenhagen, 1866); Gudbrand Vigfússon's *Um tímatil í Íslendinga sögum* ("On the Chronology of the Sagas of Icelanders," *Kaupmannahöfn*, 1855); the introductions to Keyser's "Religion of the Northmen," translated by Pennock (New York, 1854), to Laing's version of Snorri Sturlason's *Heimskringla* (London, 1844), and in Dasent's translation of "The Story of Burnt Njal" (London, 1861). The best saga texts are those edited by Munch, Keyser, Unger, and Bugge in Christiania, and by the Arni-Magnæan commission in Copenhagen. A few valuable texts have been published by Möbius and Maurer in Germany, and by the professors in the college at Reykjavík.

**ICELAND MOSS** (*Cetraria Islandica*, Acharius), a lichen common in the north of Europe and America. It consists of a tuft of deeply divided and dentate-ciliate margined, leaf-like, cartilaginous fronds, flattened out and of a lighter color at their base, but above incurved at their edges, so as to render them channelled; in general color they are of a dark olive brown. The fruit (*apothecia*) is borne upon the extremities and sides of the broadest branches, and is very broad and flat with elevated borders. This fruitful condition is only to be met with in the alpine regions of our northern mountains; when the plants occur upon the lower hills, and more especially in dry exposed pastures, they are uniformly infertile. It is possible that these last mentioned forms may yet prove to be distinct species; to settle this point, the occurrence of the apothecia is very desirable. A very bitter principle is resident in the alpine forms as well as in the Iceland moss of the shops; but this is almost wanting in the campestral sorts. As an alleviative to pulmonary complaints the Iceland moss is well known; the principal part of the stock used in medicine is brought from Iceland and Norway. After the intense bitterness, which readily

ids to cold water, has been extracted, boiled; water is to be poured upon the mass, then, by keeping up a considerable heat and several hours' steeping, an abundant and stringy mucilage is given out, and can be used with freedom, the drink being made pala-



Iceland Moss (*Cetraria Islandica*).

is with a little sugar. Hooker says that after being purged of its bitterness the lichen is dried, reduced to powder, and made into a porridge or boiled and eaten with milk, and eaten with thankfulness too, by the poor natives of those countries where it grows abundantly, so consider that the very stones yield them food." The mucilaginous character is owing to the great abundance of lichen starch. Even the bitter principle is tonic and useful in the treatment of disease. Similar alimentary substances are found in other lichens, resulting from the presence of this kind of starch.

**ICE PLANT** (*mesembryanthemum crystallinum*, Linn.), the common name of a plant originally brought from the Canary islands and now raised in the West Indies. In the Canaries it is used to be largely cultivated in order to procure alkali for making soap. Each plant spreads over the ground by a small annual root, and has numerous succulent branches covered with large heart-shaped or ovate, tender, and succulent leaves, the cuticle of both being elevated into many tall, narrow vesicles which contain a gummy principle insoluble in water; they give the plant the appearance of being covered with hoar frost, and suggested the specific and common name. The Spaniards call it the "spangled bean." The flowers are about half an inch across, and consist of numerous linear, white or purplish petals, and are of little beauty, and only produced in the middle of bright days. It is raised from seeds which should be started in a pot or hotbed, and the young plants set out in a dry place. It was formerly much more cultivated than at present. In southern California the ice plant is naturalized, and grows in great quantities; the Spanish inhabitants burn the stems for the sake of the ashes to use in

soap making. Under the name of *glaciale* the ice plant is cultivated in the French kitchen gardens, and is used as an ingredient of soups, as a garnishing for salads, and as a substitute for spinach. (See *MESEMBRYANTHEMUM*.)

**ICHNEUMON** (Gr. *ιχνημων*, to track), a viverrine carnivorous animal, of the genus *herpestes* (Illiger). The cheek teeth are  $\frac{3}{2}$ ; the body is long and the legs short; head small and pointed; ears short and rounded; feet five-toed, with sharp semi-retractile claws; a large anal pouch, in which the vent opens. Of the several species described, the best known is the ichneumon of Egypt (*H. ichneumon*, Linn.), known also as Pharaoh's rat. It is a little larger than a cat, with a gait more like a marten, and the long tail ending in a divergent tuft; the muzzle and paws are black, and the fur of the body has each hair alternately ringed with brown and dirty yellow. It is an inhabitant of N. E. Africa, especially Egypt. It was adored by the ancient Egyptians for its antipathy to the crocodile, whose eggs it destroys in great numbers; they saw in it the



Egyptian Ichneumon (*Herpestes ichneumon*).

representative of a benign power engaged in the destruction of one of their most troublesome enemies. Its natural food consists of rats, reptiles, birds, and eggs, but it has no special antipathy to the crocodile. It is itself destroyed by foxes and jackals. The ichneumon is frequently domesticated in Egypt, where it is used like the cat in ridding houses of rats and smaller pests; it forms attachments to persons and places, and recognizes with signs of pleasure the caresses of its master. The mongous of India (*H. mungos*, Linn.) is a little smaller than the ichneumon, paler and more grayish, and with a pointed tail; it has a singular antipathy to serpents, which it destroys whenever it can, not hesitating to attack even the deadly cobra de capello; against the bite of the latter it is said to find an antidote in the *ophiorrhiza mungos*, a root which is considered in Ceylon as a specific against the cobra's bite in man. It is as mischievous, and in the same way, as the polecat and weasels. The garangan of Java (*H. javanicus*, Geoffr.) is chestnut brown, with yellowish



white spots; its habits are the same as in the other species, and it is expert in burrowing; it is easily domesticated, and is used for destroying rats.

**ICHNEUMON FLY**, an extensive tribe of the pupivorous family of hymenopterous insects, of great importance in the economy of nature on account of their destruction of insects injurious to vegetation, and very interesting from the peculiar manner in which this purpose is effected. They are perfect parasites, depositing their eggs within the body of living insects, which are devoured by the larvæ hatched within them. Their forms are various, but they generally have an elongated body, with a terminal, long, divided, bristle-like appendage, and filiform antennæ which have a constant vibratory motion; the prevailing colors are black, rufous, and yellow, with lines and spots of white. The head is prominent; the mandibles corneous; the wings four, of thin membrane and horny ribs or nervures, the anterior longest, narrow at the base and dilated at the ex-



Ichneumon Fly.

trinity; the abdomen begins between the two posterior legs; the feet are long and slender. It is difficult to detect the sexes except by the ovipositor; this instrument is short or long according as the eggs are to be deposited in the bodies of caterpillars on the surface of the ground or to be thrust down into their living nidus through a nest or deep crevice; in the former it is retractile and lodged in a groove on the under side of the body, in the latter often longer than the body, consisting of a central oviduct and two lateral protecting appendages coming from the last abdominal segment. The eggs are hatched in the body of the larva, and the young consume the fatty matters in the interior of the victim, without injuring the vital organs; many eggs are often deposited within the same larva; the young undergo transformation within the living insect, or eat their way through the skin and spin their pupa cases on the outside, from which after a time they come out perfect insects. The larvæ selected for this deposition are so enfeebled by the parasites that they perish without going

into the pupa state. A common example is met with in the large green caterpillar, with a horn on the last segment, generally called the potato worm; this is a favorite nidus for the eggs of a minute black ichneumon fly; the young, hatched within its body and devouring its substance, eat through the skin, and spin their pupa cases so thick upon the outside as almost to cover the back and sides of this four-inch caterpillar; each case is attached to the skin by a short delicate filament, and the place of exit of each larva is indicated by a black dot; this caterpillar is often seen crawling about and eating, almost covered with a colony of these tiny silvery white pupa cases, from which in about a week the shining ichneumon flies appear; the caterpillar does not enter the pupa state, but dies exhausted. These flies are generally rapid in their movements, and are taken with difficulty except when depositing their eggs; they occur in flowers, on trees and walls, in houses, and wherever the desired larvæ are found. The perfect insects live upon the pollen and honey of flowers, and do not attack other insects except to make a deposit of eggs; they are of all sizes, from a fraction of a line to more than an inch long; the species are exceedingly numerous, there being about 1,500 in Europe alone. The larvæ are without feet, parasitical and carnivorous. The chalcidians, allied to the ichneumon flies, are extremely small; they puncture the eggs of other insects and deposit their own tiny ones in them. We can hardly estimate the benefits conferred upon man by these apparently insignificant insects; their instincts lead them to do for man's advantage what all his contrivances could not effect; the best known destructive insects kept in check by them are the pine weevils, the lackey caterpillars, the grubs of many wood eaters of their own order, the gall insects, the Hessian fly, and hosts of others which would overrun the forests and fields were it not for these diminutive creatures.

**ICHOLOGY** (Gr *ἰχνος*, a footprint, and *λόγος*, discourse), the name applied to the modern science of fossil footprints, or ichnolites. See FOSSIL FOOTPRINTS, and HITCHCOCK, EDWARD.

**ICHTHYOLOGY** (Gr. *ἰχθύς*, a fish, and *λόγος*, discourse), the branch of zoology which treats of fishes, the lowest of the great divisions of the vertebrate animals. The class of fishes cannot be said to have been arranged in a strictly natural manner by any systematist, and such an arrangement is impossible until their external and internal structure and embryonic development are better understood; and until zoologists are better agreed as to what constitutes family, ordinal, generic, and specific characters, little harmony of arrangement can be expected. Most classifications of fishes up to the time of Cuvier (including his) were based on the organs of locomotion and the external integument; after him appeared the anatomical arrangement by J. Müller. The older systems were very imperfect from the ignorance of fos-

sil forms, which supply many links otherwise wanting in the chain of ichthyological characters. Aristotle, in the 4th century B. C., first reduced ichthyology, as he did the other branches of zoology, to scientific form; he was well acquainted with the structure and external characters of fishes, which he distinguishes from cetaceans, laying special stress upon the organs of respiration and locomotion and the scaly covering; he gives the names of 117 species, entering into interesting details on their habits. The system of compilation without observation prevailed until the middle of the 16th century, when Belon, Rondelet, and Salviani laid the foundations of modern ichthyology. Belon gives rude figures of 110 species, Salviani excellent engravings on copper of 99, and Rondelet woodcuts of 234 species, in all three mostly fishes of the Mediterranean. Gesner in the same century borrowed the descriptions of the last mentioned authors, and added some of his own, in his *Historia Animalium* (1551-'6), all arranged in alphabetical order without any attempt at method, embracing however many foreign fishes. Ray and his pupil Willughby, English naturalists of the 17th century, in their *Historia Piscium* (1686), gave the first attempt at a natural classification of fishes, founded upon the consistence of the skeleton, the form, the teeth, presence or absence of ventral fins, number of dorsals, and character of the fin rays. They divided fishes into cartilaginous and osseous; though their genera are not well defined, the species are so well described that it is generally easy to refer them to their proper place in subsequent systems; the whole number of species is 420. The second volume consists of well executed, tolerably accurate plates. This work forms an epoch in the history of ichthyology, which from this time began to assume a methodical arrangement. Passing over Plumier, Ruysch, Kämpfer, Sloane, Catesby, and many scientific voyagers of this period, we come to Artedi in the first third of the 18th century. This Swedish naturalist completed the scientific classification of fishes commenced by Willughby and Ray, defining genera and giving them appropriate names. In his *Philosophia* he divides the class into four orders, founded on the consistence of the skeleton, the branchial coverings, and the nature of the fin rays, as follows: 1, malacopterygians; 2, scanthopterygians; 3, branchiostegous fishes; and 4, chondropterygians (sharks, rays, and sargassos). He made a fifth, including cetaceans, which is inadmissible, and the third is badly characterized; the three others are to a certain degree natural. In his *Genera Piscium* he gives names and distinctive characters of 45 genera, founded on the number of branchiostegous rays, of which he was the first to see the value, on the position and number of the fins, on the parts supplied with teeth, on the form of the scales, and on the shape of the stomach and great appendages; most of these genera stand at the present day. In his *Synonymia Pis-*

*cium* he gives the synonymy of 274 species; his works were published after his death by Linnæus, his early friend, at Leyden, in 1738.—Linnæus, in the first edition of the *Systema Naturæ* (1735), followed Artedi; but in the next (1740) he began to give the number of the fin rays, a method of distinguishing since found of great value. In his 10th edition (1758) he trusted to his own knowledge, creating a new system, defining genera more clearly, and using a scientific nomenclature; the most important change was in removing cetaceans from the class of fishes, in which since the time of Aristotle they had been placed, and in uniting them with viviparous quadrupeds in the class *mammalia*. Brisson, in 1756, had already separated them from fishes. Linnæus, however, committed the error of placing the chondropterygians among reptiles, under the title of *amphibia nantes*, to which in the 12th edition (1766) he added the *branchiostegi* of Artedi (*ostracion*, *lophius*, *tetrodous*, &c.). He also suppressed the division of fishes according to the nature of the fin rays, and substituted one founded on the presence or absence of the ventral fins and their position in reference to the pectorals, a method which violates many of the true relations of these animals. Though Linnæus neglected some of the genera of his contemporaries, and distributed his orders in an unnatural manner, describing only 480 species, his precision of definition and the excellence of his binary nomenclature were of great advantage to the progress of ichthyology, and his division into *apodes*, *jugulares*, *thoracici*, and *abdominales* for a long time held its place in the science. Linnæus gave an impetus to the study of natural history, which resulted in making it interesting to all classes, and in inspiring princes with a desire to extend its domain; national expeditions were fitted out by England, France, Denmark, and Russia, which came back laden with treasures of the deep for naturalists; among the workers in this great field we can only mention the names of Commerson, Sonnerat, Pennant, Banks, Solander, the Forsters, Forskal, Steller, Otho Fabricius, O. F. Muller, and Thunberg; the scientific journals teemed with descriptions of new species of fishes from all parts of the globe.—The next great contributor to ichthyology was the German naturalist Bloch, whose celebrated work on the "Natural History of Fishes" consists of two parts essentially distinct; the first, the "Economic History of the Fishes of Germany," appeared at Berlin in 1782-'4, in 3 vols. 4to, with 108 folio plates; the second, the "History of Foreign Fishes," in 1785-'95, in 9 vols. 4to, with 324 folio plates; both were translated into French in a few years after each volume appeared. Of German fishes he describes 115 species, mostly observed by himself. As he was little conversant with the anatomy of fishes, some of his genera are based on purely artificial characters, while others are remarkably correct. He follows the method of Lin-

now bringing back the *amphibia nates*. However, into the class of fishes, and dividing them, with Artedi, into *branchiostegi* and *chondropterygii*.—Comparative anatomy had made considerable progress toward the end of the 18th century, when Lacépède began his researches (1788-1806). He divides the class into cartilaginous and osseous fishes, in each of which sub-classes he makes four divisions: 1. with neither opercula nor branchial membrane; 2. without opercula and with a branchial membrane; 3. with opercula and without branchial membrane; and 4. with both opercula and branchial membrane. In each of the eight divisions he adopts the orders of *apodes*, *jugulares*, *thoracici*, and *abdominales*, according to the absence of ventrals, or their position on the throat, thorax, or abdomen. The natural history of fishes in Sonnini's Buffon (1803-4) is essentially a copy of Lacépède without acknowledgment. These works of Bloch and Lacépède supplied the principal foundation for most subsequent systems. The classification of M. Duméril, in his *Zoologie analytique* (1806), resembles that of Lacépède, inasmuch as it lays stress upon the supposed absence of opercula and branchial rays and the position of the ventrals. Pallas, in the third volume of the *Zoographia Russo-Asiatica* (1811), gives a list of 249 species, distributed into 38 genera, with the exception of three taken from Linnaeus; he makes two orders, *spiraculata* or chondropterygians, and *branchiata*, forming with reptiles (*pulmonata*) the class *monocardia* (single-hearted or cold-blooded animals). In 1815 Rafinesque published a second ichthyological system in his "Analysis of Nature, or Tableau of the Universe" (1 vol. 8vo, Palermo); though containing many errors, this system is valuable for several true affinities between fishes before and since regarded as widely separated, as for instance that of the *polypterus* with the sturgeon family.—De Blainville in 1816 (*Journal de Physique*, vol. lxxxiii.) published a classification in which fishes are divided into *gnathodontes* or osseous and *dermodontes* or cartilaginous, the latter distinguished by having teeth adherent only to the skin; the former include the *heterodermes* or *branchiostegi*, and the *squammodermes* or common fishes; in the subdivisions the Linnæan character of the position of the ventrals is adopted, and the families are established principally on the form of the body; it does not employ the Lacépèdean characters taken from the opercula and branchial rays.—Cuvier in 1817, in his *Règne animal*, divides fishes into chondropterygian and osseous. The former contain the families of suckers (lampreys), selachians (sharks and rays), with fixed branchie, and the sturionians (sturgeons), with free branchie. In the osseous fishes he suppresses the *branchiostegi*, forming of a portion of them the order *plectognathi*, from a peculiar mode of articulation of the jaws, including the families gymnodonts, scleroderms, and lophobranchs. The remaining

osseous fishes he separates into the orders malacopterygians and acanthopterygians, after Artedi, according as the rays of the dorsal fin are soft or spiny. The soft-rayed order he distributes into families according to the Linnæan method of the position of the ventrals, disregarding entirely characters drawn from the opercula and branchial rays. The spiny-rayed fishes form a single order, with the families tanioids (ribbon fishes), gobioids (blennies and gobies), labroids (bass), percoids (perches, a very extensive family), scomberoids (mackerel-like, also numerous), *squamipennis* (chardons, &c.), and the flute-mouths (*istularis*, &c.). He thus makes in all 23 families, founded on direct observation and comparison, and not simply compiled from previous authorities. Goldfuss ("Manual of Zoology"), in 1820, adopted the four orders of Gmelin, giving to them Greek names, and subdividing them into four families, each according to the shape of the head, mouth, or body, or other external character.—Thus far the systems have been little more than repetitions of the combinations of Artedi, Linnæus, and Lacépède. Comparative and philosophical anatomy began to be studied with zeal from the beginning of the 19th century. Oken, Carus, Geoffroy Saint-Hilaire, Spix, Weber, Van der Hoeven, Meckel, Everard Home, Hunter, Tiedemann, and others, wrote upon different portions of the structure of fishes, and the results of their studies began to modify ichthyological classifications. Before mentioning the anatomical and embryological systems, the classification adopted in the *Histoire naturelle des poissons*, by Cuvier and Valenciennes, beginning in 1828 and coming down to 1868, may be alluded to. In this, fishes are divided into osseous and cartilaginous, the latter (or chondropterygians) including the families sturionians, plagiostomes, and cyclostomes. The osseous fishes have the branchie pectinated or laminated, with the exception of the lophobranchs, which have them in the form of tufts; all the acanthopterygians have the upper jaw free, including 19 families, and all the malacopterygians except the scleroderms, gymnodonts, and lophobranchs; the malacopterygians are divided into abdominal, subbrachians, and apodes. Cuvier had very abundant materials at his command, embracing the collections of Péron, and those of the expeditions under Baudin, Freycinet, Deperrey, Dumont d'Urville, and other French naval officers.—Oken, in his "Physiologie" (Ray society edition), calls the class *pleurozoa*, as those animals in which a true tongue makes its appearance for the first time, and *osteozoa*, because in them also the bony system first appears. He makes four divisions, the cartilaginous and apodal *jugulares*, *thoracici*, and *abdominales*, the first two having an irregular and the last two a regular body. Among the systems based upon that of Cuvier are those of Bonaparte, Swainson, Straus-Dorckheim, and Rymer Jones. The classification of

Bonaparte (Rome, 1831) comprised the order I., *acanthopterygii*, with 17 families; II., *opterygii*, with 13 families; III., *plectognathii*, with 3 families; and IV., *cartilaginei*, 5 families; including in all nearly 3,600 species. The principal improvement on the system of Cuvier is in the series in which the orders are placed. Swainson ("Monocardian Fishes," in Lardner's "Cyclopædia," 1838-'9), in his quinary system, divides fishes into five orders *acanthopterygæ*, *malacopterygæ*, *ipinæ*, *plectognathes*, and *apodes*. Strausheim (*Traité d'anatomie comparative*, 1843) adopts the eight orders of Cuvier, but divides the chondropterygians with fixed jaws into three orders, and separates the rays as the order *silaciens*, the rays as the order *batoides*, and the cyclostomes as the order *lampræ* (from Gr. *γαλαός*, lamprey), the term *lema* having been used for a gasteropod fish; he thus makes ten orders. Rymér (in the article "Pisces" in the "Cyclopaedia of Anatomy and Physiology," 1847) makes a modification of Cuvier's system. He divides fishes into three divisions: I., *chondropterygii* or cartilaginous fishes; II., *osteoptyerygii* or bony fishes; III., *dermapterygii*, with skeleton cartilaginous or membranous, and with orders *elasmobranchii* (lampreys) and *branchiostomata*. In 1830 Prof. Agassiz, principally from study of fossil fishes, established a classification based on the characters of the scales, as follows: order 1, placoids, corresponding to cartilaginous fishes of authors, but excluding the sturgeons; 2, ganoids, including lampreys, and especially the fossil genera *ammonites*; 3, ctenoids, comprising fishes with scales pectinated on the posterior border, and corresponding generally to the chondropterygians of Artedi, exclusive of the lampreys, labroids, and pleuronectes; 4, teleostei, including the malacopterygians with some exceptions, and exclusive of the lampreys and lophioids. This system, soon adopted as an exclusive one by its author, was placing too much stress on external characters, was valuable as connecting in a continuous series living and fossil fishes, and the discovery of many important relations between the scales and the internal organs. The system of Johannes Müller, as in the Berlin "Transactions" for 1844, is based on its characters from anatomical structure, leading often to combinations without regard to zoological differences. He makes six orders: I., *dipnoi*; II., *teleostei*; III., *ganoides*; IV., *elasmobranchii* or *selachii*; V., *lophobranchii* or *cyclostomi*; VI., *lepto-* Siebold and Stannius adopt this classification in their "Comparative Anatomy;" a slight modification of it may be found in the third volume of the "Organic Nature" by Owen's "Circle of Sciences," 1855. Owen's classification, mentioned below, and adopted by John Richardson in the article "Ichthyology" of the "Encyclopædia Britannica,"

is based partly on that of Müller.—Vogt, in his *Zoologische Briefe* (1851), divides fishes into the orders *leptocardia*, *cyclostomata*, *selachia*, *ganoides*, and *teleostia*. Van Beneden's embryological system (1855) is nearly the same; his orders are *plagiostomi*, *ganoides*, *teleostei*, *cyclostomi*, and *leptocardii*. Van der Hoeven's classification (as given in the English translation of his "Handbook of Zoology," 1858) makes fishes the 14th class of the animal kingdom, and divides them into 5 sections, with 11 orders and 46 families. The sections are *dermopterygii*, *chondropterygii*, *ganolepidoti*, *osteopterygii*, and *protopteri*. Milne-Edwards, in his *Cours élémentaire d'histoire naturelle* (1855), divides fishes into osseous and cartilaginous; the former includes the orders *acanthopterygii*, *abdominales*, *subbranchii*, *apodes*, *lophobranchii*, and *plectognathii*; and the latter, the orders *sturiones*, *selachii*, and *cyclostomi*.—Owen's classification in his "Lectures on Comparative Anatomy" (1856) made the orders *dermopteri*, *malacopteri*, *pharyngognathi*, *anaacanthini*, *acanthopteri*, *plectognathi*, *lophobranchii*, *ganoides*, *protopteri*, *holocephali*, and *plagiostomi* (sharks and rays). His classification of 1866 is somewhat different, as follows: In the division *hamatocrya*, or cold-blooded animals, including fishes, batrachians, and reptiles, in the fishes he makes subclasses: 1, *dermopteri*, with orders *cirrostomi* (lancelet) and *cyclostomi* (lampreys); 2, *teleostomi*, with orders *malacopteri* (soft-rayed fishes), *anaacanthini* (cod), *acanthopteri* (spiny-rayed fishes), *plectognathi* (ostracans), *lophobranchii* (pipe fish), and *ganoides*; 3, *plagiostomi*, with orders *holocephali* (chimæra), *plagiostomi* (sharks and rays), and *protopteri* (lepidosiren).—Prof. Huxley places fishes in the lowest of his three great divisions of vertebrates, the *ichthyopsida*, including also the batrachians, from the possession of gills, either permanent or temporary; hence he calls them also branchiate vertebrates. He divides the class *pisces* into six orders: 1, *pharyngobranchii* (amphioxus); 2, *marsipobranchii* (lampreys and hags); 3, *teleostei*, ordinary fishes; 4, *ganoides*; 5, *elasmobranchii*, sharks and rays; 6, *dipnoi* (lepidosiren).—A new classification was published by Prof. Agassiz in his "Essay on Classification," p. 187 (1857), the result of the systems of Cuvier and Müller and of his own scale method, with additional light from his extensive anatomical and embryological researches. He divides the old class of fishes into four; his 1st and lowest class is myzonts, with two orders, myxinoids and cyclostomes; 2d, fishes proper, with two orders, ctenoids and cycloids; 3d, ganoids, with three orders, cœlacantha, acipenseroids, and sarpoids, and doubtful, the siluroids, plectognaths, and lophobranchs; he was then doubtful whether this class should be separated from ordinary fishes; and 4th, selachians, with three orders, *chimæra*, *galeodes*, and *batoides*. These classes he regards as equivalent to amphibians, reptiles, birds, and mam-

næus, bringing back the *amphibia nantes*, however, into the class of fishes, and dividing them, with Artedi, into *branchiostegi* and *chondropterygii*.—Comparative anatomy had made considerable progress toward the end of the 18th century, when Lacépède began his researches (1798–1803). He divides the class into cartilaginous and osseous fishes, in each of which subclasses he makes four divisions: 1, with neither opercula nor branchial membrane; 2, without opercula, and with a branchial membrane; 3, with opercula and without branchial membrane; and 4, with both opercula and branchial membrane. In each of the eight divisions he adopts the orders of *apodes*, *jugulares*, *thoracici*, and *abdominales*, according to the absence of ventrals, or their position on the throat, thorax, or abdomen. The natural history of fishes in Sonnini's Buffon (1803–'4) is essentially a copy of Lacépède without acknowledgment. These works of Bloch and Lacépède supplied the principal foundation for most subsequent systems. The classification of M. Duméril, in his *Zoologie analytique* (1806), resembles that of Lacépède, inasmuch as it lays stress upon the supposed absence of opercula and branchial rays and the position of the ventrals. Pallas, in the third volume of the *Zoographia Russo-Asiatica* (1811), gives a list of 240 species, distributed into 38 genera, with the exception of three taken from Linnæus; he makes two orders, *spiraculata* or chondropterygians, and *branchiata*, forming with reptiles (*pulmonata*) the class *monocardia* (single-hearted or cold-blooded animals). In 1815 Rafinesque published a second ichthyological system in his "Analysis of Nature, or Tableau of the Universe" (1 vol. 8vo, Palermo); though containing many errors, this system is valuable for several true affinities between fishes before and since regarded as widely separated, as for instance that of the *polypterus* with the sturgeon family.—De Blainville in 1816 (*Journal de Physique*, vol. lxxxiii.) published a classification in which fishes are divided into *gnathodontes* or osseous and *dermodontes* or cartilaginous, the latter distinguished by having teeth adherent only to the skin; the former include the *heterodermes* or *branchiostegi*, and the *squammodermes* or common fishes; in the subdivisions the Linnæan character of the position of the ventrals is adopted, and the families are established principally on the form of the body; it does not employ the Lacépédean characters taken from the opercula and branchial rays.—Cuvier in 1817, in his *Règne animal*, divides fishes into chondropterygian and osseous. The former contain the families of suckers (lampreys), selachians (sharks and rays), with fixed branchiæ, and the sturionians (sturgeons), with free branchiæ. In the osseous fishes he suppresses the *branchiostegi*, forming of a portion of them the order *plectognathi*, from a peculiar mode of articulation of the jaws, including the families gymnodonts, scleroderms, and lophobranchs. The remaining

osseous fishes he separates into the orders malacopterygians and acanthopterygians, after Artedi, according as the rays of the dorsal fin are soft or spiny. The soft-rayed order he distributes into families according to the Linnæan method of the position of the ventrals, disregarding entirely characters drawn from the opercula and branchial rays. The spiny-rayed fishes form a single order, with the families tænioids (ribbon fishes), gobioids (blennies and gobies), labroids (bass), percoids (perches, a very extensive family), scomberoids (mackerel-like, also numerous), *squamipennes* (chætodons, &c.), and the flute-mouths (*fistularis*, &c.). He thus makes in all 22 families, founded on direct observation and comparison, and not simply compiled from previous authorities. Goldfuss ("Manual of Zoology", in 1820, adopted the four orders of Gmelin, giving to them Greek names, and subdividing them into four families, each according to the shape of the head, mouth, or body, or other external character.—Thus far the systems have been little more than repetitions of the combinations of Artedi, Linnæus, and Lacépède. Comparative and philosophical anatomy began to be studied with zeal from the beginning of the 19th century. Oken, Carus, Geoffroy Saint-Hilaire, Spix, Weber, Van der Hoeven, Meckel, Everard Home, Hunter, Tiedemann, and others, wrote upon different portions of the structure of fishes, and the results of their studies began to modify ichthyological classifications. Before mentioning the anatomical and embryological systems, the classification adopted in the *Histoire naturelle des poissons*, by Cuvier and Valenciennes, beginning in 1828 and coming down to 1868, may be alluded to. In this, fishes are divided into osseous and cartilaginous, the latter (or chondropterygians) including the families sturionians, plagiostomes, and cyclostomes. The osseous fishes have the branchiæ pectinated or laminated, with the exception of the lophobranchs, which have them in the form of tufts; all the acanthopterygians have the upper jaw free, including 18 families, and all the malacopterygians except the scleroderms, gymnodonts, and lophobranchs; the malacopterygians are divided into abdominals, subbrachians, and apodes. Cuvier had very abundant materials at his command, embracing the collections of Péron, and those of the expeditions under Baudin, Freycinet, Deperrey, Dumont d'Urville, and other French naval officers.—Oken, in his "Physiophilosophy" (Ray society edition), calls the class *pleurozoa*, as those animals in which a true tongue makes its appearance for the first time, and *osteozoa*, because in them also the bony system first appears. He makes four divisions, the cartilaginous and apodal *jugulares*, *thoracici*, and *abdominales*, the first two having an irregular and the last two a regular body. Among the systems based upon that of Cuvier are those of Bonaparte, Swainson, Straus-Durckheim, and Rymer Jones. The classification of

C. L. Bonaparte (Rome, 1831) comprised the orders: I., *acanthopterygii*, with 17 families; II., *malacopterygii*, with 12 families; III., *plectognathi*, with 2 families; and IV., *cartilaginei*, with 5 families; including in all nearly 3,600 species. The principal improvement on the system of Cuvier is in the series in which the genera are placed. Swainson ("Monocardian Animals," in Lardner's "Cyclopædia," 1838-'9), true to his quinary system, divides fishes into five orders *acanthopteryges*, *malacopteryges*, *artilaginei*, *plectognathes*, and *apodes*. Straus-Dürckheim (*Traité d'anatomie comparative*, Paris, 1843) adopts the eight orders of Cuvier, but subdivides the chondropterygians with fixed branchiæ into three orders, and separates the sharks as the order *selaciens*, the rays as the order *batoides*, and the cyclostomes as the order *alexiens* (from Gr. *αλεξίς*, lamprey), the term *yclostoma* having been used for a gasteropod mollusk; he thus makes ten orders. Rymer Jones (in the article "Pisces" in the "Cyclopædia of Anatomy and Physiology," 1847) adopts a modification of Cuvier's system. He makes three divisions: I., *chondropterygii* or cartilaginous fishes; II., *osteopterygii* or bony fishes; III., *dermapterygii*, with skeleton cartilaginous or membranous, and with orders *yclostomata* (lampreys) and *branchiostomata*.—About 1830 Prof. Agassiz, principally from the study of fossil fishes, established a classification based on the characters of the scales, as follows: order 1, placoids, corresponding to the cartilaginous fishes of authors, but excluding the sturgeons; 2, ganoids, including the sturgeons, and especially the fossil genera with enamelled scales; 3, ctenoids, comprising only fishes with scales pectinated on the posterior border, and corresponding generally to the acanthopterygians of Ardeï, exclusive of the squaleroids, labroids, and pleuronectes; 4, teleosts, including the malacopterygians with the above exceptions, and exclusive of the ganoids and lophioids. This system, soon abandoned as an exclusive one by its author from its placing too much stress on external characters, was valuable as connecting in a continuous series living and fossil fishes, and led to the discovery of many important relations between the scales and the internal organs.—The system of Johannes Müller, as set forth in the Berlin "Transactions" for 1844, derives its characters from anatomical structure, leading often to combinations without regard to zoological differences. He makes six classes: I., *dipnoi*; II., *teleostei*; III., *ganoidi*; IV., *elasmobranchii* or *selachii*; V., *branchiobranchii* or *cyclostomi*; VI., *leptocephali*. Siebold and Stannius adopt this classification in their "Comparative Anatomy," and a slight modification of it may be found in the third volume of the "Organic Nature" of Owen's "Circle of Sciences," 1855. Owen's classification, mentioned below, and adopted by S. J. Richardson in the article "Ichthyology" of the "Encyclopedia Britannica,"

is based partly on that of Müller.—Vogt, in his *Zoologische Briefe* (1851), divides fishes into the orders *leptocardia*, *cyclostomata*, *selachia*, *ganoidea*, and *teleostia*. Van Beneden's embryological system (1855) is nearly the same; his orders are *plagiostomi*, *ganoidei*, *teleostei*, *cyclostomi*, and *leptocardii*. Van der Hoeven's classification (as given in the English translation of his "Handbook of Zoology," 1858) makes fishes the 14th class of the animal kingdom, and divides them into 5 sections, with 11 orders and 46 families. The sections are *dermapterygii*, *chondropterygii*, *ganolepidoti*, *osteopterygii*, and *protopteri*. Milne-Edwards, in his *Cours élémentaire d'histoire naturelle* (1855), divides fishes into osseous and cartilaginous; the former includes the orders *acanthopterygii*, *abdominales*, *subbranchii*, *apodes*, *lophobranchii*, and *plectognathi*; and the latter, the orders *sturiones*, *selachii*, and *cyclostomi*.—Owen's classification in his "Lectures on Comparative Anatomy" (1855) made the orders *dermopteri*, *malacopteri*, *pharyngognathi*, *anacanthini*, *acanthopteri*, *plectognathi*, *lophobranchii*, *ganoidei*, *protopteri*, *holocephali*, and *plagiostomi* (sharks and rays). His classification of 1866 is somewhat different, as follows: In the division *hamatocrya*, or cold-blooded animals, including fishes, batrachians, and reptiles, in the fishes he makes subclasses: 1, *dermopteri*, with orders *cirroptomi* (lancelet) and *cyclostomi* (lampreys); 2, *teleostomi*, with orders *malacopteri* (soft-rayed fishes), *anacanthini* (cod), *acanthopteri* (spiny-rayed fishes), *plectognathi* (ostraceans), *lophobranchii* (pipe fish), and *ganoidei*; 3, *plagiostomi*, with orders *holocephali* (chimæra), *plagiostomi* (sharks and rays), and *protopteri* (lepidosiren).—Prof. Huxley places fishes in the lowest of his three great divisions of vertebrates, the *ichthyoptida*, including also the batrachians, from the possession of gills, either permanent or temporary; hence he calls them also branchiate vertebrates. He divides the class *pisces* into six orders: 1, *pharyngobranchii* (amphioxus); 2, *marsipobranchii* (lampreys and hags); 3, *teleostei*, ordinary fishes; 4, *ganoidei*; 5, *elasmobranchii*, sharks and rays; 6, *dipnoi* (lepidosiren).—A new classification was published by Prof. Agassiz in his "Essay on Classification," p. 187 (1857), the result of the systems of Cuvier and Müller and of his own scale method, with additional light from his extensive anatomical and embryological researches. He divides the old class of fishes into four; his 1st and lowest class is myzonts, with two orders, myxinoids and cyclostomes; 2d, fishes proper, with two orders, ctenoids and cycloids; 3d, ganoids, with three orders, coelacanth, acipenseroids, and squaloids, and doubtful, the siluroids, plectognaths, and lophobranchs; he was then doubtful whether this class should be separated from ordinary fishes; and 4th, selachians, with three orders, *chimæra*, *galcodea*, and *batidea*. These classes he regards as equivalent to amphibians, reptiles, birds, and mam-

mals.—The following have been the principal cultivators of this science in America: Dr. Samuel L. Mitchill published in vol. i. of the "Transactions of the Literary and Philosophical Society of New York" (1815) a history of 149 species of New York fishes, with many illustrations; he adopts the Linnæan system; other descriptions of his species are in the "Proceedings of the Philadelphia Academy" and in the "Annals of the Lyceum of Natural History of New York." Lesueur has described and exactly figured many species in the Philadelphia academy's "Proceedings." Rafinesque published in the same work, and in his *Ichthyologia Ohienais* (1820), descriptions of many species which had escaped his predecessors. Dr. Kirtland (1838) described the fishes of the Ohio river, and Dr. Holbrook several years later those of South Carolina. Dr. De Kay in 1842, in his "Zoology of New York," divides fishes into bony and cartilaginous, the former having the sections: 1, *pectinibranchii*, with spiny-rayed and soft-rayed abdominal, subbranchial, and apodal orders; 2, *lophobranchii*, and 3, *plectognathi*; the latter include the sections *eleutheropomi*, *plagiostomi*, and *cyclostomi*. Dr. D. H. Storer, in his "Report on the Fishes of Massachusetts" (1839), and in the illustrated edition of the same in the "Memoirs of the American Academy" (1855-'60), and also in his "Synopsis of the Fishes of North America" ("Memoirs of the American Academy," vol. ii., 1846), follows the arrangement of Cuvier. These works are of great value to the student of North American ichthyology. The Wilkes, North Pacific, and Japan expeditions sent out by the United States government, and the various explorations by land for the survey of the Mexican boundary, the Pacific railroad route, and military and civil roads, have added largely to the materials, both foreign and native, at the disposition of American ichthyologists; these have been worked up principally by Messrs. Baird and Girard of the Smithsonian institution, where the collections are deposited. The results are published in the government reports on the naval expeditions, in vol. x. of the "Pacific Railroad Reports," in vol. ii. of the "Mexican Boundary Survey," and in the publications of the Philadelphia academy.—The disposition to make new genera and subdivide old ones is carried to a puzzling extreme in ichthyology as well as in other departments of zoology; and the prevalent system of placing the name of the genus maker after the species, by whomsoever and whenever described, offers a premium for naturalists to make the greatest number possible of new genera. In getting rid of the too great condensation of Linnæus, naturalists have fallen into the worse extreme of too extensive subdivision. For details on the structure and physiology of fishes, see FISHES.—FOSSIL ICHTHYOLOGY. Fishes are by far the most numerous of the vertebrates found in the strata of the earth, extending

from the Silurian epoch to the tertiary; their number, excellent state of preservation, and remarkable forms, render fossil fishes of great interest in explaining the changes of our planet's surface, and in completing the chain of ichthyic relations. The classic work on fossil fishes is the *Recherches sur les poissons fossiles*, by Prof. Agassiz (1833-'43); in this magnificent work about 1,000 species are described with accurate and elegant illustrations, the result of his examinations of more than 20,000 specimens in the cabinets of Europe. He divides fossil fishes into the four orders of ganoids, placoids, ctenoids, and cycloids, according to the structure and form of the scales, these portions of the external skeleton being generally well preserved; the orders he divides into families according to the structure and position of the fins, the form of the bones of the head and of the teeth, and the structure of the gill covers and of the spinous fin rays. His classification is as follows: order I., *ganoides*, characterized by osseous plates covered with enamel (see GANOIDS); order II., *placoides*, with tabular scales, like sharks and rays; order III., *ctenoides*, having many living representatives, with scales serrated on their posterior margins; order IV., *cycloides*, with elliptical or circular scales without serrations. The first order is most abundant from the old red sandstone to the chalk formation; the second extends from the Silurian through the tertiary epochs; the last two are not found anterior to the chalk, from which they extend through the tertiary strata. For details on fossil fishes, see the geological works of Hugh Miller.

**ICHTHYOSAUREUS** (Gr. *ἰχθύς*, fish, and *σαῦρος*, lizard), a gigantic fossil marine reptile, belonging to the order enaliosaurians of Conybeare. The body was fish-like in form, with a large head, neck of equal width with occiput and thorax; the vertebræ had biconcave articular surfaces, as in fishes and the perennibranchiate reptiles; the paddles, four in number, were comparatively small, resembling in form those of cetaceans, but in the number of digits and of their constituent bones and appended bifurcated rays they came near the structure of the fins of fishes; the tail was long, the vertebræ gradually becoming smaller and flatter toward the end, and probably margined with a tegumentary fin expanded or in a vertical direction; the tail was doubtless the principal organ of locomotion, and presented the saurian character of length and gradual diminution, being cetacean in its partially tegumentary nature, and fish-like in its vertical position. According to Dr. Buckland, the skin was scaleless and finely wrinkled, as in cetaceans. The skull is like that of the dolphin, with a smaller cerebral cavity and an unanchylosed condition of the cranial bones; the intermaxillaries are greatly developed, and the orbits immense, surrounded by numerous large sclerotic plates; in the convex articulating surface of the occiput, the solid structure of the back part of the skull,

and the massive proportions of the jaws and the bones with which they are articulated, we see crocodilian affinities. The nostrils are a short distance in front of the orbits; the teeth are situated in an alveolar groove with their bases free, and separated by partial ridges, the roots being implanted much as in the crocodile; hence this reptile is placed by Prof. Agassiz in the order of rhizodonts. The structure of the hyoid apparatus indicates that it was an air breather, with a slightly developed tongue, and that it obtained its food in the water, having an apparatus, as in the crocodile, to shut off the cavity of the mouth from the larynx. The ribs are well developed, extending from near the head to the tail, and attached to a large sternum; the clavicles and shoulder blades are strong; the resulting pectoral arch resembles much that of the mammalian *ornithorhynchus*, and is very different from that of the cetaceans, indicating that the anterior limbs were used not only in swimming but in crawling up the shores of the ocean for the purpose of depositing their eggs, &c. The arm and forearm are very short and broad; after these come the bones of the wrist and fingers, arranged as flattened ossicles in series of from three to six, so dovetailed together at the sides

violence; the vertebræ are about 120; the most remarkable character is the equality in size of the fore and hind paddles, and the comparative simplicity of their structure. The *I. tenuirostris* (Conyb.) is characterized by the length and slenderness of the jaws, as in the gavia; this, with the flat head and large orbits, gives to the skull, as Owen says, the appearance of that of a gigantic snipe with its bill armed with teeth; the teeth are slender and very numerous, about  $\frac{1}{8}$ — $\frac{1}{16}$ , and directed obliquely backward; it attained a length of about 15 ft., and was rather slender in its proportions. Six other species, and details on all, will be found in Prof. Owen's "Report on British Fossil Reptiles to the British Association," in 1839. Their remains extend through the whole of the oolitic period, including the lias and oolite proper to the Wealden and chalk formations, in Great Britain and central Europe. For fuller details the reader is referred to the writings of Conybeare, Cuvier, and Buckland. These reptiles, of gigantic size and marine habits, must have been very active and destructive; their food, as indicated by the bones and scales found with their remains, consisted principally of fishes. From the great size of the eyes, they could probably see well

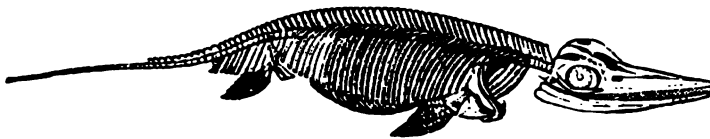

Skeleton of Ichthyosaurus.

as to form one powerful framework. The pelvic arch is not articulated to the spine, but was merely suspended in the muscles, as in fishes; the posterior limbs or paddles are generally considerably smaller than the anterior, and would seem to have been more serviceable in terrestrial progression than in swimming. The best known species, *I. communis* (Conybeare), grew to a length of 20 ft.; the large central, longitudinally furrowed teeth are from 40 to 50 above on each side, and 25 to 30 below; the jaws are prolonged and compressed, the vertebræ about 140, with the anterior paddles three times as large as the posterior; like all the species, this is found in the secondary formations, principally in the lias and oolite of England. The *I. intermedius* (Conyb.), the most common and generally distributed of the species, does not much exceed 7 ft. in length; the teeth are more acutely conical, and about  $\frac{1}{3}$ — $\frac{1}{4}$ ; the vertebræ are about 130, and the fore paddles are much the larger. The *I. platyodon* (Conyb.), so called from the greater smoothness and flatness of the crowns of the teeth, must have attained a length of more than 20 ft.; the head is longer than in the preceding species, and the jaws broader and more powerful; the teeth are about  $\frac{1}{5}$ — $\frac{1}{4}$ , and are frequently found broken as if from its own

by night; being air breathers, like the crocodiles, they no doubt seized their prey near the surface; the immense cuttle fishes of the secondary epoch probably furnished a portion of their food. These strange creatures formed the connecting link between reptiles and fishes, as do the perennibranchiate amphibia in the actual creation; and by some they have been considered, like the latter, as possessors of both gills and lungs, at least in some stage of their existence, and therefore to a certain extent amphibious. This reptile, with the muzzle of a dolphin, the teeth of a crocodile, the head of a lizard, the paddles of a whale, and the vertebræ of a fish, buried for myriads of years, was introduced to the scientific world by Sir Everard Home, in the "Philosophical Transactions" for 1814.

**ICOLMILL.** See IONA.

**ICONIUM.** See KONIEN.

**ICONOCLASTS** (Gr. *εικονοκλάστης*, from *εἰκών*, an image, and *κλάω*, to break), in ecclesiastical history, the violent opponents of the veneration of images in the 8th and 9th centuries. The use of images which led to the iconoclastic troubles dates from very remote antiquity. The paintings which adorn the Roman catacombs are now attributed by such archaeologists as Lenormant and Marchi to the first three centuries of the Christian era; and those recently discovered in the cemetery of St. Callistus are thought by De Rossi to belong to the 1st century. But it is still a matter of dispute



when images were first introduced by Christians into public worship. The prevailing opinion is that they passed from the family into the temple at the end of the 3d century, and that their public use became general at the close of the 4th. The visible representation of the cross found its way earlier both into ecclesiastical and domestic life. This custom and the feeling out of which it grew varied widely among different nations. In Egypt and throughout Africa the use of images met with but little favor. Tertullian, Clement of Alexandria, and Augustine dis-countenanced it. Both the Greeks and Romans favored the fine arts, but there always existed among Christians an aversion toward anything which resembled the old pagan union of art and religion. The first note of the iconoclastic warfare came from Marseilles, where the bishop, Serenus, caused all images to be demolished and cast out of churches. For this he was twice censured by Pope Gregory the Great, who, while blaming the superstitious use of images, advised their employment as a means of instruction for the unlettered who could not read the Holy Scriptures. In the East, Constantine had embellished the public monuments and churches erected by himself in his new imperial city with representations of religious objects taken from the circle of the Old and New Testaments. Very soon this use became interwoven with the whole domestic and public life of the Greek and Asiatic Christians. Churches, together with their books, furniture, and vestments, private houses and public edifices, household utensils and wearing apparel, were profusely ornamented with images of Christ, the martyrs, and Biblical personages. Statues of costly materials adorned the public squares and the approaches to the imperial palaces. The people were not slow in going to extravagant lengths. Reports of miraculous effects produced by some images attracted crowds of pilgrims. In the course of the 6th century it became a custom in the Greek church to make prostrations before images as a token of reverence to the persons whom they represented. The Manichæans had already characterized these practices as idolatry, and the Jews denounced them as an apostasy from the divine law. About the year 600 Leontius, a Cyprian bishop, wrote a treatise against the Jews and in vindication of the lawfulness of the custom. In the next century the Mohammedans wherever they prevailed forbade the worship of images.—Moved by these circumstances, the Byzantine emperor Leo the Isaurian issued a first ordinance in 726, directed not against the images themselves, but against such signs of an idolatrous homage as prostration and kneeling down before them. This measure, counselled by Constantine, bishop of Nacolia in Phrygia, and countenanced by a large number of other eastern prelates, met with resistance from Germanus, patriarch of Constantinople, and from the mass of the people. Besides se-

rious disturbances in many places, the inhabitants of the Cyclades rebelled against the emperor and equipped a fleet. This was destroyed by means of Greek fire, and a new imperial edict was issued in 730, forbidding the use of all images for religious purposes. Germanus now resigned his office and retired into solitude. Leo caused the statues in churches to be burned and the paintings on the walls to be effaced, and fearful riots and massacres occurred in consequence. Pope Gregory II. remonstrated in vain with the emperor, and the Romans refused to comply with the imperial edict. In 732 a council assembled in Rome by Gregory III., condemned Leo and his abettors, and decreed the validity of the relative honor paid to images. The emperor pursued his purpose with relentless severity until his death in 741, when it was taken up with no less zeal by his son Constantine Copronymus. He was opposed by his brother-in-law Artavasdes, who possessed himself of the throne and restored the worship of images. His death in November, 743, restored Constantine to power, which he used to exterminate images and finish the work begun by his father. He assembled at Constantinople in 754 a council of 338 bishops, who after a deliberation of six months pronounced all visible symbols of Christ, except in the eucharist, to be either blasphemous or heretical, and the use of images in churches to be a revival of paganism. This decision was carried out by Constantine, one of whose last acts was to compel every inhabitant of Constantinople to take an oath never again to worship an image. Leo IV., who succeeded him in 775, was no less energetic in putting down image worship; but at his death in 780 the empress regent Irene concerted measures with Pope Adrian I. for the restoration of images. In 787 the second œcumenical council of Nice decreed that "bowing to an image, which is simply the token of love and reverence, ought by no means to be confounded with the adoration which is due to God alone." The same was also true of the cross, the books of the evangelists, and other sacred objects. The contest was prolonged in the East under successive emperors till Theodora assembled a council at Constantinople (842), which confirmed the decisions of the Nicene council, and established the veneration of images among the Greeks, though subsequently the Greek church took the position which it holds to this day that no carved, sculptured, or molten images of holy persons or things are allowable, but only pictures, which are held to be not images but representations. Rome and Italy had already accepted the decree of the Nicene council, which the Latin church accounts the seventh of the general councils.—The term iconoclasts is also applied in history to those Protestants of the Netherlands who at the commencement of the troubles in the reign of Philip II. tumultuously assembled and destroyed the images in many Roman Catholic churches. These tumults be-

Aug. 14, 1566, at St. Omer in Flanders, several churches were desecrated, the altars overturned and broken, and the pictures destroyed. The insurgents next attacked the cathedral at Ypres, which they also stripped. The excitement speedily spread all over Flanders, Hainaut, and Brabant, and the churches, cloisters, and convents of Valenciennes, Tournai, Comines, and many other cities and towns were sacked. At Antwerp shortly afterward a mob ravaged the cathedral, destroyed the statues, cut into pieces the paintings, the pride of Flemish art, demolished the organ, the most perfect in the world, and threw the 70 altars, and carried off the vessels and sacred vessels. The devastation of the cathedral occupied them till midnight, when they sallied forth to deal in the same manner with the other churches of the city and its suburbs. For three days these scenes continued at Antwerp, when they were stopped by a party of knights of the golden fleece, who with their retainers attacked and dispersed the rioters. From Antwerp the excitement against the Catholics spread over the northern provinces, throughout Holland, Utrecht, and Friesland, the churches were ravaged. At Rotterdam, Dort, Haarlem, and some other places, the magistrates averted the storm by quietly removing the images from the buildings. "The extent of injury inflicted during this dismal day," says Prescott, "it is not possible to estimate. Four hundred churches were sacked and the insurgents in Flanders alone. The damage to the cathedral of Antwerp, including its contents, was said to amount to not less than 400,000 ducats. The loss occasioned by the plunder of gold and silver plate might not be estimated; the structures so cruelly defaced could not be repaired by the skill of the architect; who can estimate the irreparable loss occasioned by the destruction of manuscripts, statuary, and paintings?" Motley, in his "History of the Rise of the Dutch Republic," maintains that the iconoclasts committed no act of violence nor of outrage on persons. He says: "Catholic and Protestant writers agree that no act of violence were committed against man or woman. It would be also very easy to accumulate a vast weight of testimony as to their force from robbery. They destroyed for the nation's sake, not for purposes of plunder. Much of the property belonging to the lowest classes of society they left heaped of jewelry, of gold and silks, of costly embroidery, lying unheeded on the ground. They felt instinctively that their passion would be contaminated by admiring with paltry motives. In Flanders many of the rioters hanged one of their own number for stealing articles to the value of five shillings. In Valenciennes the iconoclasts were deterred from large sums if they would refrain from ravaging the churches of that city, but they rejected the proposal with disdain. The honorable burgher who recorded the fact, observed that he did so because of the many mis-

representations on the subject, not because he wished to flatter heresy and rebellion." The whole time occupied by this remarkable outbreak was less than a fortnight. It was warmly disapproved of at the time by William of Orange, Egmont, and the other statesmen of the patriotic party in the Netherlands. Its immediate effect was to detach the Catholics from the national cause, and it was probably the principal means of preventing the southern provinces of the Netherlands from becoming independent of Spain in concert with the seven northern provinces.

**ICTINUS**, a Greek architect, contemporary with Pericles. He was chief architect of the Parthenon, and built the temple of Apollo Epicurius near Phigalia in Arcadia. The former was completed in 488 B. C., and the latter probably about 481. He also built the fane at Eleusis in which the mysteries were celebrated. All these edifices were in the Doric style. No details of his life remain.

**IDA**, a W. county of Iowa, drained by branches of Little Sioux river; area, 482 sq. m.; pop. in 1870, 226. Grain, potatoes, and sorghum are the principal crops; cattle raising is carried on to a considerable extent. The productions in 1870 were 9,389 bushels of wheat, 8,510 of Indian corn, 6,058 of oats, 2,511 of potatoes, and 1,887 tons of hay. The value of live stock was \$84,867. Capital, New Ida.

**IDA**. I. A mountain range (now Kas Dagh) of Mysia, forming the S. boundary of the Troad. Its highest peak was Mt. Gargarus, about 5,750 ft. above the sea. The principal rivers flowing from Mt. Ida were the Simois, Scamander, and Granicus. From Mt. Ida Ganymede was stolen; here Paris pronounced judgment on the beauty of the rival goddesses; and here the celestials stationed themselves to behold the battles for Troy on the plain below. II. A mountain (now Psiloriti) of Crete, the loftiest of the range which traverses that island, of which it occupies the centre, terminating in three peaks crowned with snow for eight months of the year. Its highest summit is said to be about 8,000 ft. Of the legends with which its name is connected, those relating to the infancy of Zeus are the most celebrated.

**IDAHO**, a territory of the United States, situated between lat. 42° and 49° N., and lon. 111° and 117° 10' W., bounded N. by British Columbia, E. by Montana and Wyoming, S. by Utah and Nevada, and W. by Oregon and Washington. The extreme length N. and S. on the W. boundary is 485 m. and along the Wyoming border 140 m., and the breadth varies from less than 50 m. on the north to nearly 300 m. on the south; area, 86,294 sq. m. The eastern boundary line is irregular. Commencing at the north, it runs S. along the 116th meridian to the crest of the Bitter Root mountains (about lat. 47° 45'); thence it follows S. E. and E. the crest of those and of the Rocky mountains to the 111th meridian on the Wyoming border, and thence runs S.

to the Utah border. The territory is divided into nine counties: Ada, Alturas, Boise, Idaho, Lemhi, Nez Percé, Oneida, Owyhee, and Shoshone. The principal towns are Boise City (the capital), Idaho City, Malade City, and Silver City in the S. part, each having in 1870 less than 1,000 inhabitants, and Lewiston at the junction of the Snake and Clearwater rivers. The population of the territory in 1870, exclusive of tribal Indians, was 14,999, including 4,274 Chinese, 60 colored, and 47 Indians; 12,184 were male and 2,815 female; 7,114 native and 7,885 foreign born; 897 males and 798 females were between 5 and 18 years of age, 9,431 males (3,288 native and 6,143 foreign) from 18 to 45, and 10,813 (3,680 native and 6,633 foreign) 21 years old and upward. Of the natives, 946 were born in the territory, 804 in New York, 550 in Ohio, 536 in Missouri, 479 in Utah, 416 in Pennsylvania, 400 in Illinois, 348 in Oregon, and 312 in Iowa. Of the foreigners, 1,984 were natives of Great Britain, of whom 986 were Irish, 599 of Germany, and 334 of British America. There were 553 persons born in Idaho living in other parts of the Union; 5,557 male citizens of the United States, 21 years old and over, in the territory; 3,293 persons, 10 years old and upward, unable to read, and 3,388 unable to write, including 2,872 Chinese; 4,104 families and 4,622 dwellings; 10,879 persons, 10 years old and over, engaged in occupations, of whom 1,462 were employed in agriculture, 1,423 in professional and personal services, 721 in trade and transportation, and 7,273 in manufactures and mechanical and mining industries. The tribal Indians in 1872 numbered about 5,800. The Nez Percés, 2,807 in number, occupy a reservation of 1,344,000 acres in the N. part of the territory; they are well advanced in civilization, extensively engaged in agriculture, and had two schools in operation, attended by 124 pupils. The Boise and Bruneau Shoshones, numbering 516, and the Bannacks, 521, have a reservation of 1,568,000 acres in the S. E. part of the territory, near the Snake river. These reservations receive limited annuities from the United States, and are in charge of the Presbyterians. The Cœur d'Alènes, Spokanes, Kootenays, and Pend d'Oreilles, about 2,000 in the aggregate, occupy a reservation of 256,000 acres, 30 or 40 m. N. of the Nez Percés. They receive no annuities, and are largely under the influence of the Catholic missionaries of the Cœur d'Alène mission.—The general surface of the territory is a table land, with an elevation of from 2,000 to 5,000 ft. above the sea, but containing numerous depressed valleys, each watered by a considerable stream, and crossed by mountain ranges or spurs, with peaks rising above the line of perpetual snow. These spurs, branching from the Bitter Root and main chain of the Rocky mountains, and traversing the whole width of the territory, are mostly named from the streams that rise in them or flow along the valleys at their base. In the north, near the

international boundary, are the Kootenay mountains; S. of these is the Cœur d'Alène range, and further S. and along the Clearwater river and its tributaries are the Clearwater mountains. Along the upper Salmon river and at its head waters is the lofty and rugged Salmon River range, and further up the Snake from the mouth of Salmon river are successively found the Weiser, Payette, Boise, Owyhee (in the S. W. portion of the territory), and Saw Tooth mountains. The Bear River mountains are in the S. E. corner, and along the N. portion of the Wyoming border is the Teton range. The Three Buttes are isolated peaks in the S. part, N. and W. of the Snake. The Snake river or Lewis fork of the Columbia and its branches drain the entire territory, except a portion about 120 m. long in the extreme north, which is watered by Clarke's fork, the Spokane, and the Kootenay, and a small tract in the S. E. corner, which is intersected by Bear river. The Snake river, rising in the W. part of Wyoming, after entering Idaho, flows N. W., then bends S. W., and again N. W., making an immense curve through the S. part of the territory, and strikes the Oregon boundary in about lat. 43° 40', after which it flows N. forming the W. boundary of Idaho to about lat. 46° 30', where it turns W. and enters Washington territory. Steamers ascend to Lewiston in Nez Percé co., just above the point where it assumes a W. course. For more than 100 m. above Lewiston the river is shallow and rapid, and navigation is difficult and dangerous; but above the mouth of Powder river it is again navigable for 150 or 200 m. The principal tributaries are the Bruneau from the south, the Malade from the north, and from the east the Boise, the Payette, the Weiser, the Salmon, the Clearwater, and the Palouse. The Boise enters the Snake just below the point where it assumes a N. course; the Payette and Weiser lie between it and the Salmon. The Salmon river rises in the Salmon River mountains near the centre of the S. portion of the territory, and flows N. along the base of the Rocky mountains, turns abruptly W., and after traversing the entire width of the territory joins the Snake near the middle of the W. boundary. The Clearwater rises by several forks in the Bitter Root mountains, and flows W., joining the Snake at Lewiston. The Palouse rises N. of the Clearwater, and empties into the Snake in Washington territory. The Spokane, flowing W. and joining the Columbia in Washington territory, forms the outlet of Cœur d'Alène lake, a navigable body of water of irregular shape, about 24 m. long by 2 or 3 m. wide, which receives the Cœur d'Alène and St. Joseph's rivers from the Bitter Root mountains. Further N. Clarke's fork crosses the territory from E. to W., expanding into a lake about 30 m. long and 5 m. wide near the E. boundary, called Pend d'Oreille. The river and lake are navigable by steamers through Idaho. The N. E. corner is crossed by the Kootenay, a trib-

he Columbia. Lake Kanisku, about 6 m. wide, which occupies the corner of the territory, empties into the Snake. Bear river enters the S. E. corner of Utah, flows N., and bending sharply S. W. enters the Great Salt Lake. The S. W. corner is watered by Jordan and other affluents of the Owyhee, an tributary of the Snake. Three falls in Idaho deserve mention. The American Falls, about lon. 112° 45', and have a perpendicular descent of 60 or 70 ft. The Shoshone falls, further down the stream, and just above Malade, are surpassed only by those of the Yosemite. The river, here 100 yards wide, is divided about 400 yards into the main fall into six nearly equal falls, and in the passage between the falls is precipitated 25 or 30 ft. Under the falls, the water passes in an sheet over the great fall, a descent of 60 ft. The Salmon falls, about 45 m. from Shoshone, are 20 ft. high.—Idaho is rich in precious metals. The principal mines are in the S. W. part, in Owyhee, Blaine, and Alturas counties. In the Snake and chiefly on Jordan creek, silver dominates. The other mines, the productive of which are in Boise basin, and in a depression in Boise co., 25 m. N. to S. and 18 m. from E. to W., are gold. Placer diggings occur in various parts of the territory; the most important are those of Boise basin and along the waters of the Salmon and Clearwater rivers. Gold was first discovered in paying in Idaho on Oro Fino creek, a N. tributary of the Clearwater, in 1860. The Boise mines were discovered in 1862, and the Clearwater mines in 1863. The product of the mines prior to 1868 is stated in J. Ross "Resources of the Pacific Slope" at \$1,000,000. The subsequent yield, according to Raymond, United States commissioning statistics, has been as follows: 1868, \$7,000,000; 1869, \$7,000,000; 1870, \$7,000,000; 1871, \$5,000,000; 1872, \$2,500,000; 1873, \$2,500,000; making the total more than \$75,000,000. Of the total, in 1872, \$2,272,261 was gold and \$423,739 silver; in 1873, \$1,571,733 gold and \$928,267 silver. The gold from Idaho deposited at the United States mint, branches, and assay offices, from June 30, 1873, amounted to \$18,389,401.74. The census of 1874 shows 254 mines, having 5 steam engines, 52 water power and 2 water wheels of 52 horsepower; hands employed, 1,692; capital, \$1,088,640; wages paid, \$503,266; materials, \$231,763; of products, \$1,088,640. Of these mines 244 were for the production of gold, of which 7 were hydraulic, and 5 quartz; 10 were quartz mines, producing gold and silver. The returns, however, admitted to be imperfect. A United

States assay office was established at Boise City in 1872. There are extensive deposits of salt, coal, and iron ore.—In spring, summer, and autumn the climate is delightful; the days are never sultry and the nights are cool. The winters on the high mountains are accompanied with extreme cold and heavy snow; on the plains and lower mountains they are generally less severe than in N. Iowa, Wisconsin, or central Minnesota. The valleys are mild, visited with little snow, and cattle winter in them without shelter. The average temperature in the W. part of the territory is about the same as in central Illinois, Indiana, and Ohio, and S. Pennsylvania, while in the east it is more nearly that of N. Massachusetts and S. Vermont and New Hampshire. About the sources of the rivers in the Bitter Root and Rocky mountains the fall of rain and snow is considerable, but in the lower valleys in the west it is much less, and agriculture is not generally successful without irrigation. In the extreme north the climate, though less dry, is colder and not well adapted to agriculture; but the temperature does not vary in proportion to the difference of latitude. The lower slopes of the mountains are furrowed with numerous streams, and alternately covered with forests (mostly pine, fir, and cedar) and nutritious grasses. The plains generally produce good pasturage, and the valleys contain broad stretches of meadow land, extending on both sides of the streams by which they are watered to the first rise of table land or mountain, and with irrigation producing good crops of wheat, oats, barley, and the common fruits and vegetables. The climate is not well adapted to Indian corn. The valleys of the Clearwater, Salmon, Payette, and Boise rivers are large, and generally have good facilities for irrigation; and there are well sheltered and fertile bottom lands on the Weiser, St. Joseph, and Cœur d'Alène, and fertile tracts on the shores of Lakes Cœur d'Alène and Pend d'Oreille. Other important valleys are those of the Bruneau in the southwest, of Wood river in the south, and of Bear river, which contains thriving Mormon settlements. The extreme north is well timbered and has much fertile land. The basin of the Snake is of volcanic origin, and through it the river has cut a vast cañon, varying in depth from 100 to 1,000 ft. The streams that empty into the Snake for some distance below the Shoshone falls sink, and, passing under the strata of lava, fall from the sides of the cañon into the main stream. The greater portion of the basin, though much of it might be rendered productive by irrigation, is a barren waste, producing only sage brush, but along the streams are valleys containing arable land, and the surrounding foot hills are generally covered with bunch grass, affording excellent pasturage. Of the total area of 55,228,160 acres, 16,925,000, according to the estimate of the commissioner of the United States general land office, are

suited to agriculture; 5,000,000 to grazing; 14,324,180 are sterile, producing only wild sage and occasional tufts of buffalo grass, but mostly reclaimable into pasture and agricultural land by irrigation; 18,400,000 mountains, including 7,500,000 acres of timber land and 8,000,000 of mineral land; and 375,000 acres are covered by lakes. In 1870 there were 77,169 acres in farms, of which 26,603 were improved. The cash value of farms was \$42,660; of farming implements and machinery, \$59,295; amount of wages paid during the year, including the value of board, \$153,097; estimated value of all farm productions, including betterments and additions to stock, \$637,797; value of orchard products, \$725; of produce of market gardens, \$24,577; of home manufactures, \$34,739; of animals slaughtered or sold for slaughter, \$57,932; of live stock, \$520,580. There were 2,151 horses, 371 mules and asses, 4,171 milch cows, 522 working oxen, 5,763 other cattle, 1,021 sheep, and 2,316 swine, besides 624 horses and 49,540 cattle not on farms. The productions were 73,725 bushels of winter and 1,925 of spring wheat, 1,756 of rye, 5,750 of Indian corn, 100,119 of oats, 72,316 of barley, 64,534 of Irish potatoes, 610 of peas and beans, 14 of grass seed, 3,415 lbs. of wool, 111,480 of butter, 4,464 of cheese, 21 of hops, 11,250 gallons of milk sold, and 6,985 tons of hay. The number of manufacturing establishments was 101, having 11 steam engines of 311 horse power and 16 water wheels of 295 horse power; number of hands employed, 265; capital invested, \$742,300; wages paid during the year, \$112,372; value of materials used, \$691,785; of products, \$1,047,624. The only important establishments were 8 quartz mills (value of products, \$523,100), 3 flouring and grist mills, 10 saw mills, 7 breweries, and 2 distilleries. The United States commissioner of mining statistics in 1871 states the number of quartz mills, including those not in operation, at 30, having 344 stamps and 4 arrastras, and mostly run by steam; 9 were for the production of gold alone, and 21 for the production of gold and silver. There is a national bank at Boise City, with a capital of \$100,000. No railroads are in operation in the territory, but the Northern Pacific is to cross the N. part.—The government is similar to that of other territories. The executive officers are a governor and a secretary, appointed by the president, with the advice and consent of the senate, for four years; also a treasurer, comptroller, prison commissioner, and superintendent of public instruction created by local law. Legislative authority is vested in a council of 13 members and a house of representatives of 26, elected biennially by the people. The judicial power is vested in a supreme court, district courts, probate courts, and justices of the peace. The supreme court consists of three judges appointed by the president with the consent of the senate for four years, and has appellate jurisdiction. A dis-

trict court, with general original jurisdiction, is held in each of the three judicial districts into which the territory is divided, by a judge of the supreme court. There is a probate court for each county, with the ordinary powers of such courts. Justices of the peace have jurisdiction of inferior cases. The assessed value of real estate in 1870 was \$1,926,543; of personal property, \$3,365,640; total assessed value, \$5,292,205; true value of real and personal, \$6,552,681; taxation not national, \$174,711, of which \$40,594 was territorial, \$132,171 county, and \$1,946 town, city, &c.; public debt, \$222,621, of which \$218,522 (\$33,739 bonded) was county and \$4,099 (\$2,543 bonded) town, city, &c. The receipts into the territorial treasury for the two years ending Nov. 30, 1872, according to the treasurer's report, were \$101,102, including \$16,607 94 on hand at the beginning of the period; expenditures, \$89,817 18; balance, \$11,284 82. The receipts are derived from taxes on property and polls and from licenses. The floating debt at the above date, less cash in the treasury, was \$58,239 73; bonded debt in coin, \$63,058 51, payable Dec. 1, 1875 and 1876, upon which interest to the amount of \$4,471 31 was unpaid. In 1870 there were 25 schools, of which 21 were public, with 33 teachers, 1,208 pupils, and an annual income of \$19,938. In 1872 the number of school districts was 37; public schools, 32; school houses, 26; teachers, 60, of whom 26 were males and 34 females; children of school age, 1,898; number enrolled, 1,416; total expenditures, \$17,219 56. The census of 1870 returns 43 libraries, containing 10,625 volumes, of which 11 with 2,860 volumes were not private; 6 newspapers (1 tri-weekly, 1 semi-weekly, and 4 weekly), issuing 200-200 copies annually and having an average circulation of 2,750; and 15 church organizations (2 Baptist, 6 Episcopal, 2 Mormon, 1 Presbyterian, and 4 Roman Catholic), having 12 edifices with 2,150 sittings, and property to the value of \$18,200.—Idaho was created a territory by the act of congress of March 3, 1863, from portions of Dakota, Nebraska, and Washington territories, comprising an area of 326,373 sq. m., and embracing the present territory of Montana and nearly all of Wyoming. The region within its present limits is a portion of the Louisiana purchase of 1803, and was included first in Oregon and subsequently in Washington territory. The Cœur d'Alène mission was established in 1842, and is situated about 15 m. E. of the lake of the same name. The permanent settlement of the territory did not begin until the discovery of gold.

**IDAHO**, a W. central county of Idaho territory, bounded N. by Salmon river, W. by Oregon, and watered by the Little Salmon and other streams; area, 8,500 sq. m.; pop. in 1870, 848, of whom 425 were Chinese. A large portion of the surface is covered with forests of pine. There are several fertile valleys containing good land. On the tributaries of the Salmon

placer mines of gold. The production in 1870 were 1,111 bushels of wheat, 1,675 of Indian corn, 6,810 of oats, and 63 tons of hay. There were 285 and 668 cattle. Capital, Washington.

**EE**, **Christian Ludwig**, a German mathematician, born at Gross-Brese, in Brandenburg, 1766, died Aug. 10, 1846. His earliest work was the editing in 1794 of an astronomical almanac for the Prussian government. He was professor of mathematics and mechanics in the school of arts and forests, and also in the military academy, and in 1821 became professor in the University of Berlin. His works include *His-*

*Untersuchungen über die astronomischen Beobachtungen der Alten* (Leipzig, 1806); *Lehrbuch der mathematischen und technischen Logik* (Berlin, 1825-'6); and *Die Zeitrechnung der Chinesen* (Berlin, 1839).

In the Roman calendar, the 15th day of the month, May, July, and October, and the 13th of the other months. The eight days of the *idus* were named from it, and the 1st, 2d, 3d, &c., day before the *idus*. In the empire the senate sat regularly on the 15th, and on the *calends*, with the exception of the 15th of March, the anniversary of Caesar's death, which was regarded as a *dies ater*.

**I**, or **Idioty**, a term now used to designate a condition of mental imbecility, though it was not originally contained in the word from which it is derived. The idiot among the Greeks was primarily the individual, in distinction from the man who participated in public affairs; next, as the lowest class, especially in Sparta, where it is believed to have originated, alone lived in public life, *ιδίωτος* came to mean a stupid or unlettered man; and finally, as it tended to mental degradation, it was applied to one who did not possess the capacity to learn. Numerous attempts have been made to define idiocy, but none of them have been perfectly satisfactory. Dr. H. P. Ayres defines it as "that state of human existence in which the individual continuously manifests no signs of intelligence nor instinct." "The type of an idiot," says Dr. Seguin, "is one who knows nothing, can do nothing, wishes for nothing; an idiot approaches in a greater or less degree this standard of idiocy." In a later work he writes more definitely: "Idiocy is a deficiency of the cranio-spinal axis, producing a deficiency of nutrition *in utero* and *in vita*. It incapacitates mostly the functions which give rise to the reflex, instinctive, and conscious phenomena of life; consequently the idiot moves, feels, understands, wills, and acts imperfectly; does nothing, thinks of nothing, and wishes for nothing (extreme cases)." This is a theory of nutrition, occurring before birth, which arrests the normal progress, and gives permanent to the transitory type through which the child is passing; a similar arrest of development takes place after birth. The whole system may be affected, or more commonly one

set of organs, as those of speech, &c. In this aspect idiocy may be considered as a prolonged infancy, in which, the infantile grace and intelligence having passed away, the feeble muscular development and mental weakness of that earliest stage of growth alone remain. Dr. Säger of Berlin, a high authority on the subject, on the other hand, regards it as depending upon a faulty organization of the brain; and Dr. S. G. Howe considers "the pure type of idiocy to be a person whose lack of understanding arises from the smallness of his brain," though acknowledging that for one person in whom idiocy is caused by this circumstance there are many in whom it is occasioned by other causes. It occurs in various degrees, separated by no definite line of demarcation, from the typical condition to a state scarcely distinguishable from normal humanity. Idiocy has been variously classified, according to the point of view or object aimed at. Dr. Seguin recognizes, in different aspects, eight classes, viz.: endemic, when connected with some form of cretinism (see **CRETINISM**); hereditary, when ancestors or collateral relatives have been affected by idiocy or insanity; parental, when referred to certain conditions of the father or mother; accidental, when occasioned by various post-natal causes; profound, when the ganglia are altered; superficial, when only the peripheral termini of contractility and sensation appear to be affected; organic, when the organs are sensibly altered; and functional, when no organic lesion is observable. The terms "profound" and "superficial" are by others used simply to indicate the degree of idiocy. No particular physical trait is a criterion of this infirmity. It is accompanied by no special shape of the body, though a certain want of proportion is generally observable. The size of the head, except in extreme cases of hydrocephaly or microcephaly, is commonly quite normal, though appearing in infancy too large and later in life too small; nor is its shape a test, though generally somewhat deformed. But any deviation in the relative development of the segments of the brain from the type of a race, or any imperfection in the mode of union of the segments of the skull, indicates *a priori* some anomaly or imperfection of the faculties. Idiocy in infancy is difficult to detect, and can generally be determined only by comparison with a healthy child in the advance toward certain powers that mark the progress of ordinary infancy, as the ability to hold up the head, to sit erect, to use the hands, to take notice, &c.; the lapse of time leaving the idiot further and further behind in the race. In many cases premature senility is exhibited, which is believed to be peculiar to idiots. The symptoms of this condition are various. The body is generally feeble, the circulation particularly in the extremities imperfect, the respiration not deep, and the appetite sometimes abnormal. The gait is accompanied by a sidewise swinging or by forward plunges,

or there is an inability to walk at all. The power of prehension is wanting or imperfect, while spasmodic, mechanical, or automatic motions are common. The touch is dull, less frequently over-sensitive. The taste and smell are oftener indifferent than abnormal. The hearing is passive and limited, sometimes only certain sounds or classes of sounds being heeded, while at others, though the organs are perfect, no sounds are attended to, and the patient becomes practically deaf and consequently mute, from inattention of the will or absence of any desire to hear. The sight is sometimes fixed and vacant, sometimes wandering, and the child may be practically blind from inability of the will to control the vision or from indifference of the mind to the image on the retina. Speech is sometimes wholly wanting; otherwise, more or less imperfect. Idiocy is most frequently complicated with epilepsy and chorea, less frequently with paralysis and contractures, and less frequently still with deafness and blindness; the degree of mental infirmity diminishing in the same order. Perhaps the great feature of idiocy is the inaction or absence of the will, though there is a *vis inertiae*, by some called a negative will, which opposes itself to every attempt to draw the idiot from his indifference and isolation, or from the external trifles upon which he expends the little energy he has. When the disease is not complicated with epilepsy, &c., the idiot is harmless and mild; he has no hallucinations or delusions; he does not perceive wrongly, but only imperfectly or not at all. In some cases, even when the general condition is very low, an extraordinary power in a particular direction, as in music or calculation, is manifested. Idiocy, which is congenital or has its origin in the earlier years, is to be distinguished from dementia, or the loss of the mental powers resulting from disease or the disorganization of the brain in adults. The latter, though resembling idiocy in its apparent results, is incapable of amelioration. The term imbecility is commonly employed to denote a mild form of idiocy, but by Dr. Seguin it is used to designate an arrest of the mental development in youth (which may result in dementia), when vices, habits, and tendencies have been formed to complicate the disease. The causes assigned for idiocy are numerous, and not all of them well ascertained. Inter-marriage of near relatives, intemperance in eating or drinking, and especially sexual congress leading to conception while one or both parties are intoxicated, excess of sexual indulgence or solitary vice, grief, fright, or sudden and alarming sickness on the part of the mother during gestation, the habitual use of water impregnated with magnesian salts, bad and insufficient food, impure air, hereditary insanity, and scrofulous or syphilitic taint, are the most commonly alleged causes of congenital idiocy. The effect on women of the excitements and anxieties of modern life, and of a

false system of education, is stated as the cause of a progressive increase of idiocy noticed by most persons engaged in the treatment of idiots. Convulsions, epileptic fits, hydrocephalus, and other diseases of the brain, smallpox, scarlatina, and measles, blows on the head, or the translation of scrofulous or other eruptive diseases to the brain, are the usual influences which arrest mental development in children. The condition of the mother during lactation likewise has an important bearing on this question.— While among some nations idiots have been regarded with a certain awe as under the special protection of the Deity, until a comparatively recent period they were not deemed capable of improvement, and their condition was generally forlorn. They were suffered to grow up in neglect at home, or were thrown into the almshouses, insane asylums, or houses of correction, and often treated with cruelty. No attempt is known to have been made to improve their condition till the 17th century. When St. Vincent de Paul took charge of the priory of St. Lazarus, he gathered a few idiots, and, fitting up a room in the priory for their accommodation, took charge of them in person, and attempted to instruct them. His labors, though continued for many years, seem not to have been very successful. The next effort was made by the eminent philosopher and surgeon Itard, the friend and disciple of Condillac. In 1799 a wild boy ("the savage of Aveyron"), found in the forests of Aveyron, was brought to Itard, who hoped to find in his instruction the means of solving "the metaphysical problem of determining what might be the degree of intelligence and the nature of the ideas in a lad who, deprived from birth of all education, should have lived entirely separated from the individuals of his kind." For more than a year he followed a psychological method, but subsequently adopted a system founded on physiology, and labored to develop the intellectual faculties of his subject by means of sensations. The young savage proved to be an idiot of low grade, and hence unfit for the philosophical experiment; but the attempt to instruct him had satisfied Itard that it was possible to elevate the mental condition of idiots. His immense practice, and the severe suffering induced by the malady which finally caused his death, prevented him from devoting much time to the subject; but he had gathered many facts, and these he committed to his pupil, Dr. Seguin, who entered upon the work as a labor of love, and devoted several years to a thorough research into the causes and philosophy of idiocy, and the best methods of treating it. Meantime others had become interested in the subject. In 1818, and for several years subsequently, the effort was made to instruct idiot children at the American asylum for the deaf and dumb in Hartford, Conn.; the measure of success was not large, but their physical condition was improved, and some of them were taught to converse in the sign lan-

1819 Dr. Richard Pool of Edinburgh, in an essay on education, advocated the establishment of an institution for imbeciles. 1824 Dr. Belhomme of Paris published an essay on the possibility of improving the condition of idiots; and in 1828 a few were instructed for a short time at the Bicêtre, one of the large insane hospitals of Paris. In 1831 Falret attempted the same work at the pitié, another hospital for the insane in the same city. Neither of these efforts met with sufficient success to be continued. In 1838 Dr. Voisin, a French physiologist and anatomist, organized a school for idiots in Paris, but it was not of long duration. In 1840 Dr. Seguin opened a school in the hospital for incurables of the rue du Faubourg St. Martin, and was soon so successful that the idiots in the Bicêtre were placed under his charge; and within three years he received from the French academy, whose committee carefully tested his system of instruction, a testimonial of their approval. The previous attempts for the instruction of idiots had been made upon no definite plan, or with a view of illustrating some philosophical theory of the nature and origin of the mind or the original constitution of man. Seguin, starting with the postulate that idiocy is only a prolonged infancy, consulted himself as to the mode by which the physical organs are cultivated and the mind educated the infant, and ended by adopting the physiological system of education. This system, considering all the manifestations of life as expressions of functions, and all functions as resultant from a certain organism, assumes that if we could take hold of an organ we should be able to make it perform its function; teaches that as the organs of sensation are within our reach and those of thought beyond it, the physiological education of the senses must precede the psychical education of the mind. Applying this method to the varying degrees of idiocy, each function is to be trained with especial reference to the peculiarities and deficiencies of the individual, and also in its relation to all other functions, with a view to an harmonious whole. Important agencies are clean air and good food, to strengthen and invigorate the system; gymnastic appliances, to exercise the various functions and correct abnormal manifestations; music, imitation, analogy, contrast; the play ground, the workshop, the farm, which furnish a definite object to lend reality to the exercises, while they induct the pupil into the actual operations of life. The legs, if they do not bend, may be made to yield by placing the child in a baby-carriage; if the feet refuse to step, they may be taught by making them encounter, with the clarity of a walk, a spring board which automatically receives and throws them back; the gait is regulated by the use of dumb-bells, by conducting the child between the rails of a horizontal ladder or over planes at various inclinations and conditions of sur-

face, representing the principal difficulties likely to be encountered in nature. The hands are taught to grasp by clasping them about the rounds of an inclined ladder and requiring them to support the weight of the body, or by the use of the balancing pole, which is thrown back and forth between the child and the teacher. The sense of hearing, when wanting, is aroused by music, by surprise sounds, or by sounds connected with some natural desire, as the dripping of water when the pupil is thirsty; the vacant or wandering sight is fixed and awakened by the steadfast gaze of the teacher, by the admission of light at intervals into a dark room, or by the use of the kaleidoscope; the touch, the taste, the smell are trained by appropriate exercises, and the refractory organs of speech are moulded and manipulated until they can utter the desired sounds. The operations are at first passive and in obedience to the will of the teacher; an active performance of the functions is gained by the presentation of motives within the understanding of the pupil. As each sense or organ is carried progressively toward the normal performance of its function, new avenues from without are opened by which ideas, at first concrete, but afterward more abstract, are instilled into the mind. Finding in idiots the infantile fondness for bright colors, teachers avail themselves of it to teach them the distinctions of color and form; noticing their liking for playthings, they furnish them with builders' blocks, cups and balls, and other toys, by which they are instructed in number, form, and size; words, not letters (these, except as a training for the eye, come later), and the meaning of words are taught by pictures and objects. Throughout these processes individual training is alternated with instruction in groups. Simultaneously with the physical and mental training, the idiots are instructed as far as practicable in the social and moral relations and duties by practice and example. The system thus briefly summarized is the one now followed or aimed at in the principal institutions both in the United States and Europe. The enthusiasm of philanthropists has perhaps in some cases led to the expectation of higher results than have been or are likely to be realized. A considerable proportion of those under instruction will make little or no intellectual progress; the mind is too thickly shrouded for the light to reach it. The condition of those suffering from epilepsy is still more hopeless. The training school may slightly improve their physical condition, but that is all. There is however a large number, and those often apparently the worst cases when admitted, who will attain to a considerable degree of intelligence under judicious instruction, and will develop sufficient ability to be capable, under the direction of others, of acquiring a livelihood. A considerable number learn to add, subtract, multiply, and divide, in numbers below 100; but in most cases they grasp the idea of numbers



with great difficulty. In geography they make more progress. In penmanship and drawing many of them are very expert, and most of the girls and some of the boys exhibit considerable skill in needle work. In moral training they have generally exhibited a remarkable susceptibility for improvement. It is estimated that of idiots not affected by epilepsy, who are brought under instruction in childhood, from one third to one fourth may be made capable of performing the ordinary duties of life with tolerable ability. They may learn to read and write, to understand the elementary facts of geography, history, and arithmetic, to labor in the mechanic arts under proper supervision, and to attain sufficient knowledge of government and morals to fulfil many of the duties of a citizen. A larger class, probably one half of the whole, will become cleanly, quiet, able perhaps to read and write imperfectly, and to perform under the direction of others many kinds of work requiring little thought. This class, if neglected after leaving school, will be likely to relapse into many of their early habits. A small number, perhaps the most promising at entering, will make little or no progress. Nor can the result in any particular case be predicted beforehand, and no methods of instruction yet adopted will invariably develop the slumbering intellect, and confirm and correct the enfeebled or depraved will. According to Dr. Seguin, "not one in a thousand has been entirely refractory to treatment; not one in a hundred who has not been made more happy and healthy; more than 80 per cent. have been taught to conform to social and moral law, and rendered capable of order, of good feeling, and of working like the third of a man; more than 40 per cent. have become capable of the ordinary transactions of life under friendly control, of understanding moral and social abstractions, of working like two thirds of a man; and 25 to 80 per cent. come nearer and nearer to the standard of manhood, till some of them will defy the scrutiny of good judges when compared with ordinary young women and men." The institutions generally, under the pressure of applications, do not receive those afflicted with epilepsy, congenital insanity, paralysis, &c., and retain only those that promise improvement. The age of admission in most instances is from 6 to 14, and the term of instruction from 5 to 7 years.—Dr. Seguin continued the instruction of idiots in Paris till 1848, a part of the time in a private establishment. In 1839 he published with Esquirol his first pamphlet, and in 1846 his treatise on the treatment of idiocy, which placed him at once in the front rank of living psychologists. In 1848 he visited the United States, and assisted in the organization and improvement of several institutions for idiot instruction; and he now resides in New York. (See SEGGIN.) In 1839 Dr. Guggenbühl began the study of cretinism in Switzerland, and in 1842 opened his school on

the Abendberg. In the latter year Sägert, a teacher of deaf mutes at Berlin (now imperial councillor and general inspector of the department of instruction of unfortunates in Prussia), began to receive idiotic pupils, and devoted himself to the study of medicine in order the better to understand their physiological condition. The school of Dr. Guggenbühl was discontinued at his death in 1863. It is generally considered that his system was a failure. At present (1874) there are three schools in France: that at the Bicêtre, under the supervision of M. De Laporte, with about 20 inmates; that in the Salpêtrière, under Dr. Delasiauve and Mlle. Nichol, with 50 inmates; and that in the insane asylum at Clermont in the department of Oise, superintended by Dr. Labitte, and having 15 inmates. In Belgium there are separate departments for idiots in the insane asylums at Gheel and at Ghent; the former, under the superintendence of Dr. Bulckens, having 15 idiotic youth, and the latter, under Dr. Inghels, about 40. In Switzerland there are two private training schools for idiots: one in the canton of Bern, under the superintendence of Dr. Appenzeller, opened in 1868, and having 12 pupils in 1874; the other near Basel, under the charge of Dr. Iselin, opened in 1850, and having 15 pupils. In 1868 there were 15 institutions in Germany, mostly private, viz.: at Bendorf, Berlin (two), Hasseroode, Neinstedt, and Schreiberhaas, in Prussia; Ecksberg and Neudettelsan, in Bavaria; Buschbad, Hubertsburg (two), and Mäckern, in Saxony; Marienberg and Winterbach, in Würtemberg; and Langenhagen, in Hanover. At present there are 10 schools for idiots in Prussia, some of which are maintained by the state and others by the provinces. The only asylum for idiots in the Netherlands is the medical asylum for idiotic youth at the Hague, opened in 1858, which took its origin from the day school for idiots, opened in 1855. The number of inmates March 23, 1874, was 48 (25 boys and 23 girls), while the day school, which is continued in connection with the asylum, and only receives children residing at the Hague, has 25 pupils. These institutions are supported by subsidies, by contributions, and by fees of pupils. They are under the charge of A. S. Moersveld as director or superintendent, who with his wife has 12 assistants, and of Dr. C. W. Eikenhof as physician. The number of teachers is 12, including one instructor in gymnastics and two in handicraft. In Sweden there are three schools for idiots in operation, viz.: at Sköde in the province of West Gothland, under the superintendence of Miss E. Carlbeck, opened in 1868, and in 1874 having 32 pupils; at Stockholm, under the superintendence of Miss W. Lundell, opened in 1870, and having 20 pupils; at Strömsholm, in the province of Westmanland, under the superintendence of Mr. R. Bruce, opened in 1871, and having 10 pupils. These schools receive only congenital idiots

who give hope of improvement. Two others are about to be opened, at Strengnäs and Gefle. There is a training school in St. Petersburg, and also one at Newcastle, New South Wales, which in 1872 had 132 pupils. The first schools in England were small, and were sustained by some benevolent ladies, in the towns of Lancaster, Bath, Ipswich, and Brighton. In 1847 an effort was made to establish an institution in some degree commensurate with the wants of the class for whom it was intended. In this movement Dr. John Conolly, the Rev. Dr. Andrew Reed, the Rev. Edwin Sidney, and Sir S. Morton Peto distinguished themselves by their zeal and liberality. They first rented a nobleman's residence, called Park house, at Highbury, near London, in 1848, and two years subsequently Essex hall at Colchester. In 1853 the foundation stone of the present capacious and admirably appointed institution at Earlswood, near Redhill, Surrey, was laid, and it was opened in 1855. It now has about 700 inmates, and is under the superintendence of Dr. G. W. Grabham. With it is connected a farm of about 100 acres, and many of the pupils are instructed in farming and gardening, while others are taught mat making, basket making, tailoring, carpentering, and similar employments. Upon its opening the inmates of Park house were removed to it, and ultimately those of Essex hall, which was closed in 1858. The latter was reopened in 1859 as the eastern counties asylum for idiots and imbeciles, and now has about 70 inmates. The western counties asylum was established in 1864 at Starcross, near Exeter; and the Dorridge Grove idiot asylum at Knowle, now known as the midland counties asylum, was opened in 1866. More recently the Royal Albert asylum (northern counties) has been established near Lancaster, occupying a fine building surrounded with ample grounds, and capable of accommodating 500 inmates; it is under the superintendence of Dr. Shuttleworth. These institutions are supported chiefly by subscriptions and donations; pupils are admitted upon payment, and may enjoy the benefits of instruction gratuitously by the nomination of the boards of directors or the election of the subscribers. The private institution of Dr. Langdon Down, formerly superintendent of Earlswood, at Normansfield, near London, has about 50 inmates, and is designed only for the healthy. Besides these training schools, there are two large asylums near London maintained by the poor-law boards for keeping and feeding idiots and demented. In Scotland, besides the institution established in 1853 on the estate of Sir John and Lady Ogilvie at Baldovan, near Dundee, there is the "Scottish national institution for the education of imbecile children," founded by a society organized for that purpose, and opened in 1862 at Larbert, Stirlingshire, under the superintendence of Dr. David Laing, who for several years previously had been in charge of a school for idiots in Edin-

burgh. The present superintendent is Dr. W. W. Ireland, and the number of pupils is about 90. In Ireland an establishment has recently been endowed by Dr. Stewart, to which it was intended to remove the inmates of the asylum for lunatics and idiots at Lucan, near Dublin. The only idiot asylum in Canada was opened in July, 1872, at London, Ontario. It occupies a separate building, accommodating 40 patients, in the grounds of the asylum for the insane, and is under the charge of Dr. Henry Landon, the superintendent of that institution. It is as yet merely a house of refuge, but the present building is to be enlarged, and another provided elsewhere for a training school. In the United States, where there are now 10 institutions, the movement for the instruction of idiots commenced almost simultaneously in New York and Massachusetts. Efforts had been made, in isolated cases (apart from the attempts at the American asylum already referred to), to instruct idiot children in the Perkins institution for the blind in Boston, and in the New York deaf and dumb institution, as early as 1838 or 1839; but the feasibility of organizing an institution for their treatment and training does not seem to have been thought of till the attention of philanthropists was drawn to it by the eloquent letters of Mr. George Sumner, describing his visits to the schools in Paris. These letters were published in 1845, and Dr. S. B. Woodward, long known as the superintendent of the hospital for the insane at Worcester, Mass., and Dr. Frederick F. Backus of Rochester, N. Y., soon after corresponded upon the subject. Dr. Backus was elected a member of the New York state senate in the autumn of 1845, and in January, 1846, read a report which he had drawn up on the subject of idiot instruction, and the necessity of an institution for the purpose. A few weeks later he reported a bill for such an institution. During the same month a bill passed the Massachusetts legislature, appointing a commission to investigate the condition of the idiots of Massachusetts, and report on the necessity of measures for their instruction. The result was the establishment of an experimental school in October, 1848, in a wing of the institution for the blind at South Boston. Dr. Hervey B. Wilbur, a young physician of Barre, Mass., opened a school for idiot children there in July, 1848. The school at South Boston was incorporated in 1850 as the "Massachusetts school for idiotic and feeble-minded youth," and has remained under the supervision of Dr. S. G. Howe. The state makes an annual appropriation of \$16,500, and poor children are admitted without charge upon the recommendation of the governor, besides which there are some paying pupils and a few supported by the states of Maine, New Hampshire, Vermont, and Rhode Island. Facilities are afforded here for employing the inmates in the simpler branches of manufacture. The number under instruction in 1873 was 122; number remaining at the close of the

year, 119; expenditures, \$17,560 38. In 1851 the institution whose organization Dr. Backus had sought in 1846 was finally established, first as an experimental school at Albany, and subsequently as a permanent state institution, the "New York asylum for idiots," at Syracuse. The state in 1855 erected a fine edifice for it in the latter city, at a cost of between \$80,000 and \$90,000, with accommodations for 150 pupils. It has been from the first under the charge of Dr. Hervey B. Wilbur, who was called from Barre to organize the experimental school. It has an extensive farm, and has been enlarged to accommodate 225 inmates. The number of pupils in 1871 was 155, of whom 90 were males and 65 females. The number under instruction in 1872 was 164, of whom 132 were wholly supported by the state, the rest paying wholly or in part for their maintenance; number remaining at the close of the year, 163; number of teachers, 5; other officers, &c., 6; expenditures, \$34,049 59. In 1852 a private school was established at Germantown, Pa., by Mr. J. B. Richards, which resulted in the incorporation in the following year of the "Pennsylvania training school for feeble-minded children." In 1857, having received a grant from the state, and liberal subscriptions from individuals, its trustees purchased a tract of land about a mile from Media, Delaware co., and 12 m. from Philadelphia, and commenced the erection of the building which is now occupied. This institution has a farm of more than 100 acres, and was at first under the supervision of Dr. J. Parish, who was succeeded by Dr. Isaac N. Kerlin, the present superintendent. The number under instruction in 1873 was 249; remaining at the close of the year, 222, of whom 123 were males and 99 females; 84 were supported wholly and 24 partly by the state, 27 by New Jersey, 3 by Delaware, 12 by the city of Philadelphia, 58 by parents or guardians, and 14 by the institution; expenditures, \$53,985 40. There are four departments. The asylum embraces a distinct portion of the building and grounds, accommodating about 25 male inmates, who are only susceptible of habit-training, and only a small proportion of whom can be advantageously employed at work of any kind. A fund has been started to erect a separate building for an asylum. The nursery, also distinct from the other departments, accommodates 32 children of helpless condition, who are attended by experienced nurses. The school department is divided into five classes, and at the close of 1873 included 117 children, who receive from three to five hours' instruction daily. The exercises, while having especial reference to training in articulation, movements, and ideas, differ little from those in schools of the primary and secondary grade for intelligent children. The industrial department embraced 29 boys and 20 girls, who either were only capable of being taught manual labor, or had been through the school

training and could with advantage to themselves be instructed and kept in usefulness. Of the whole number (701) admitted to the close of 1873, there were mutes, 138; semi-mutes, 176; defective in articulation, 204; defective in sight, 142; defective in hearing, 139; unable to walk, 19; of imperfect gait, 344; unable to feed themselves, 74; unable to dress themselves, 158; uncleanly in habits, 269; of destructive habits, 374; epileptic, 157; malformed, 90; scrofulous, 575. Up to July 1, 1872, the improvement had been as follows: taught to speak, 53; articulation improved, 253; taught to read, 254; to write, 146; to feed themselves, 61; to dress themselves, 94; to walk, 5; gait improved, 266; reformed from bad habits, 164; from destructive habits, 302; accustomed to some employment, 241; epilepsy cured, 23; epilepsy improved, 78. From the report for 1870 it appears that of 500 who had enjoyed the benefits of the institution, 81 became capable of earning their own support in domestic service, farming, or certain shop employments, under the guidance of friends; 140 were able to earn a half support; 118 could perform small services of no great value; while 161 were wholly dependent, earning nothing, and evincing an improvement only in their personal habits in delicacy, language, or movement; 267 proved to be adapted to schools, and 233 were not susceptible of scholastic improvement. In 1867 the "Ohio state asylum for the education of idiotic and imbecile youth" was organized at Columbus as an experimental school, under the superintendence of Dr. R. J. Patterson, who was succeeded in 1860 by Dr. G. A. Dora, the present superintendent. It was permanently established in 1864, when a farm of 130 acres, about 2 m. W. of the city, was purchased, and the erection of a building to accommodate 250 inmates (since somewhat enlarged) commenced, which was occupied in 1868. The number under instruction in 1873 was 312; remaining at the close of the year, 288; teachers, 11; other officers, &c., 4; expenditures, \$84,425 58. This institution is entirely supported by the state, and all pupils are maintained and educated free of charge, except for clothing. The "Connecticut school for imbeciles" was established at Lakeville in 1853, and incorporated by the legislature in 1861; it is under the supervision of Dr. H. M. Knight. The number under instruction during the year ending May 1, 1872, was 55; remaining on that date, 48, of whom 20 were beneficiaries of the state to the amount of \$3 a week. The state has also appropriated money for the erection and enlargement of buildings. The "Kentucky institution for the education of feeble-minded children and idiots" was established at Frankfort in 1860, and is under the superintendence of Dr. E. H. Black. The number of inmates in 1874 was 104. The "Illinois institution for the education of feeble-minded children" was established at Jack-

in 1865 as an experimental school, in the charge of the board of directors of the institution for the deaf and dumb, and was rated under its own board of trustees. It has been from the first under the superintendence of Dr. Charles T. Wilbur, who was at the time superintendent of the New Institution. The number under instruction in 1873 was 126; remaining at the close of the year, 100, of whom 66 were males and 34 females; teachers, 4; other officers, &c., 10; expenditures, \$25,777 49. The pupils are divided into seven classes. The expenses of the institution, except for clothing of pupils, are defrayed by the state. The idiot asylum on Nantucket island, supported by the city of New York, is under the charge of Mrs. Heron, and in 1874 had 167 inmates, of whom 101 were males and 66 females; 44 were imbecile cases; the remaining 123 were under instruction in a school opened in October, 1867, and conducted by Miss Mary C. Heron (who has been principal from the first), with three assistant teachers. The private institution at Westford, Mass., has since 1851 been carried on by Dr. George Brown. It embraces ample accommodations, handsomely laid out, with several wards, in which the patients are classified according to their condition and the pecuniary means of the parents. The number of inmates is about 60, of whom part are imbeciles, &c., are received for medical treatment, part for custody, and part for instruction. A private school was opened in 1865 at Fayville, Worcester co., Mass., by Dr. H. Knight and Mrs. M. A. F. Green, with five teachers at South Boston. The number of pupils is limited to 12.—The number of idiots in the United States, according to the census of 1870, was 24,527, of whom 12,263 were males and 12,264 females; 3,188 colored, and 1,645 foreign-born; 140 deaf and dumb, 105 blind, and 11 deaf and dumb and blind. There were 1,616 from 5 to 10, 3,706 from 10 to 15, 6,476 from 15 to 20, 2,571 from 20 to 30, 3,938 from 30 to 40, 2,571 from 40 to 50, 2,676 of 50 and upward, and 19 of 60 and upward. The number in each state is given in the following table:

721	New Hampshire	825
250	New Jersey	496
67	New York	2,486
841	North Carolina	976
69	Ohio	2,893
100	Oregon	55
671	Pennsylvania	2,250
1,244	Rhode Island	128
1,260	South Carolina	465
583	Tennessee	1,091
109	Texas	451
1,141	Vermont	825
2-6	Virginia	1,180
628	West Virginia	427
3-2	Wisconsin	560
778	District of Columbia	50
618	New Mexico	46
134	Utah	23
4-5	Other territories and	
779	Nevada	15
25		

The number of idiots and their proportion to the population cannot, however, be ascertained with any satisfactory degree of accuracy. The census statistics are untrustworthy, both from the different standards adopted by enumerators, and from the difficulty of persuading parents, from whom the returns are usually obtained, that their children are idiots. Some of the worst cases in idiot asylums were brought there by their friends, not as idiots, but as being a little peculiar in their habits. The effort has been made in several states to obtain returns from physicians, clergymen, and town officers, but with very moderate success. So far as these returns go, however, they show a much greater prevalence of idiocy than has been commonly supposed; and it is now generally conceded by competent judges that the number of idiots is greater than that of the deaf and dumb or of the blind, and as great as that of the insane, the proportion being not less than 1 in 1,000 of the population. Assuming this ratio, the number of idiots in the United States would be more than 38,000. According to the census of 1871, the number of idiots and imbeciles in England and Wales in that year was 29,452, of whom 14,728 were males and 14,724 females; but the actual number in those two countries has been estimated as high as 50,000. The number in Scotland is stated at 3,000; in Ireland as high as 7,000. The number of idiots in the Netherlands, according to Dutch authorities, is between 3,000 and 4,000; the census of Norway in 1865 enumerated 2,039. The number of idiots and cretins in Switzerland was estimated in 1868 at 3,800.—Under the common law, "an idiot or natural fool," according to Blackstone, "is one that hath had no understanding from his nativity, and therefore is by law presumed never likely to attain any." "A man is not an idiot if he hath any glimmering of reason, so that he can tell his parents, his age, or the like common matters." His custody and the care of his lands were at first vested in the lord of the fee, but subsequently in the crown, and exercised through the lord chancellor. The sovereign took the profits, supplied the idiot with necessaries, and upon his death restored the estate to his heirs. There was a writ *de idiota inquirendo*, to inquire whether a man was an idiot. The jury, however, rarely found a person an idiot from nativity, but in most cases only *non compos mentis*, in which case a different rule applied. For the present legal status of idiots see LUNACY.—See "Essay on Education," by Dr. Richard Poole (first published in the "Edinburgh Encyclopædia," 1819, afterward in a separate volume, 1825); *Traitement moral, hygiène et éducation des idiots*, by Dr. E. Seguin (Paris, 1846); "Reports of Commissioners on Idiocy in Massachusetts" (Boston, 1848-'9); "Statistical Studies on Idiocy," by M. Hubertz (Copenhagen, 1851); "Mental Alienation and Idiocy in England, Scotland, and Ireland," by Dr. Stark

(vol. xiv. of statistical society's "Journal," 1851); *Traité du goître et du crétinisme*, by Dr. Niepce (2 vols., Grenoble, 1852); "Essay on Idiocy," by Dr. Coldstream (Edinburgh, 1852); *Die Heilung und Verhütung des Crétinismus und ihre neuesten Fortschritte*, by Dr. Guggenbühl (Bern and St. Gall, 1853); "Report of Commissioners on Idiocy in Connecticut" (New Haven, 1856); "Essay on Idiot Instruction," by Dr. Ferd. Kern (*Allgemeine Zeitschrift für Psychiatrie*, 1857); *Die gegenwärtige Lage der Crétinen, Blödsinnigen und Idioten in den christlichen Ländern*, by Julius Desselhoff (Bonn, 1857); "Report on the Education of Imbecile and Idiotic Children," by Dr. H. P. Ayres (vol. xiii. of the "Transactions" of the American medical association, 1862); *Uebersicht der öffentlichen und privaten Irren und Idioten-Anstalten aller europäischen Staaten*, by Dr. Albrecht Erlenmeyer (Neuwied, 1863); "Lunacy and Law, together with Hints on the Treatment of Idiots," by F. E. D. Byrne (London, 1864); "The Training of Idiotic and Feeble-minded Children," by Dr. Cheyne Brady (Dublin, 1864); "Idiocy and its Treatment by the Physiological Method," with bibliography, by Dr. Seguin (New York, 1866); "New Facts and Remarks concerning Idiocy," by the same (New York, 1870); "On Idiocy, especially in its Physical Aspects," by Dr. W. W. Ireland (Edinburgh, reprinted from the "Edinburgh Medical Journal" for January and February, 1874); and the annual reports of the various institutions.

**IDOCRASE** (Gr. *eidēv*, to resemble, and *κρᾶσις*, a mixture), a mineral species of the garnet section of the silicates, resembling other species in its crystalline forms. It occurs variously colored, as brown, sulphur yellow, green, and blue; and of vitreous, frequently somewhat resinous lustre. Its hardness is 6.5; specific gravity, 3.35-3.45. It was first observed in the lavas of Vesuvius, and was called Vesuvian. Numerous localities of it are known in gneiss rocks, serpentine, and granular limestone. It is particularly abundant at Parsonsfield and Phippsburg, Me., occurring in massive forms as well as in crystals.

**IDRIA**, a mining town of Austria, in the duchy of Carniola, 28 m. N. N. E. of Trieste; pop. in 1869, 3,960. The town is in a deep, narrow Alpine valley, on a small river of the same name. Its quick-silver mines are the second in importance in Europe, and in 1871 produced 6,700 cwt., besides about 1,100 cwt. of artificial cinnabar. The rich hepatic mercurial ore is found in a formation of clay slate forming a bed in compact limestone. The excavations are horizontal galleries diverging from a shaft which has been sunk to a depth of more than 1,000 ft. The entrance is from the *Schlöss*, a building within the town. Descent is accomplished partly by about 800 steps cut in the rock, and partly by ladders. The miners are a uniformed corps, 500 in number, and the service is eagerly sought for, the high-

er rate of wages and contingent advantages being balanced against the unhealthiness of the occupation. The mines were discovered in 1497, and are the property of the crown.

**IDUMÆA**. See EDOM.

**IESI**. See JESI.

**IFFLAND**, August Wilhelm, a German dramatist, born in Hanover, April 19, 1759, died in Berlin, Sept. 22, 1814. At the age of 18 he made his début upon the stage at Gotha, in one of Engel's comedies, in which he took the part of an old Jew. In 1779 he joined the theatrical company at Mannheim, and was the leading actor there when in the latter part of 1781 Schiller put into his hands the manuscript of the "Robbers." The play was produced in the succeeding January, with Iffland in the part of Franz Moor, and the success which attended the representation at once brought Schiller into notice, and confirmed the reputation of Iffland. The latter remained in Mannheim till 1796, when he assumed the direction of the national theatre of Berlin. In 1811 he was appointed general director of all the royal plays, and about the same time made an extended professional tour through Germany. His plays, chiefly of the class known as the domestic drama, were very successful in their day, and are still occasionally performed. Among the best of his works are *Die Jäger*, *Der Spüler*, and *Die Hagedolzen*. A collection of 47 of them was published in 16 vols. in Leipzig in 1798-1802, including a memoir of his theatrical career. Volumes containing other pieces were published in 1807-'9 and in 1827; and in 1844 his select works appeared.

**IGLAW**, a town of Austria, in Moravia, on the Iglawa, 46 m. W. N. W. of Brünn; pop. in 1869, 20,112. It consists of the town proper, which is walled, and three suburbs, and contains a military school, a gymnasium, and several charitable institutions. It has manufactories of woollen goods, tobacco, glass, and paper, and spinning and dyeing works. On July 5, 1436, the convention was concluded here, by which the emperor Sigismund was acknowledged king of Bohemia.

**IGLESIAS**, a town of Sardinia, in the province and 32 m. W. N. W. of the city of Cagliari; pop. about 6,500. It derives its name from its great number of churches. So many gardens adjoin it that the Sardinians call it *flori di mundu* (flower of the world). The finest of these gardens is at the Dominican convent. The richest lead mine of the island is on Monte Pone, 1,100 ft. high, 1 m. S. W. of the town.

**IGLESIAS DE LA CASA**, Josef, a Spanish poet, born in Salamanca in 1758, died in 1791. He early published ballads and satirical effusions which made him famous, but his didactic poems subsequent to his joining the priesthood were less popular. The best editions of his works are those of Barcelona (1820) and Paris (1821), and among the later editions there is one in 4 small vols. (1840), which includes a number of poems by other authors.

**IGNATIUS, Saint,** of Antioch, surnamed Theophanes, one of the primitive fathers of the church, died Dec. 20, 107 or 115, at Rome according to some, but most probably at Antioch, others have it. He is reckoned one of the apostolic fathers. Eusebius says that he was appointed bishop of Antioch in 69. Baronius and Natalis Alexander make him bishop of the city of the Christians residing in that city, Evagrius being at the same time bishop of the Jews converts. The *Martyrium Ignatii*, which is supposed to have been written by an eye-witness of his martyrdom, affirms that he was a disciple of St. John, and ordained by the apostles themselves. After having watched over the conduct of his flock during the persecution of Domitian, he was condemned by Nero to be thrown to the wild beasts in the Amphitheatre, where, according to the tradition, he suffered. The Greeks celebrate his feast on Dec. 20, and the Latins on Feb. 1. During his journey to Rome Ignatius wrote several epistles enumerated by Eusebius and Jerome.

They are addressed to the Romans, to the Smyrnaeans, and to various Asiatic churches. At present there are fifteen letters extant ascribed to Ignatius. The seven mentioned by Eusebius, and the shorter Greek recension, are generally accepted as genuine by Roman Catholic theologians; the others are considered spurious. But a warm controversy has long existed between the learned of various Protestant denominations regarding the genuineness of some of the first seven. A Syriac version of the epistles to the Ephesians, Roman and Polycarp was brought from a cavern in the Nitrian desert to the British museum in 1843, and edited in 1845 by Cureton. He maintained by the editor that these are really genuine epistles of Ignatius; and this opinion was adopted by Dr. R. A. Lipsius, and some eminent Presbyterian authors. Episcopal writers for the most part hold that all of the seven epistles are genuine. The best editions of the Ignatian writings are Cantelieri's *Patres Aevi Apostolici* (2 Paris, 1672; 2d and more complete ed., London, 1724), those by Jacobson (Oxford, 1849), and Petermann (Leipsic, 1849), and Cureton's *Corpus Ignatianum* (London, 1849).

**IGNATIUS, Saint,** patriarch of Constantinople, about 798, died Oct. 23, 878. He was the youngest son of the emperor Michael I., and his original name was Nicetas; but on the death of his father by Leo the Armenian, he became a eunuch by Leo and entered a monastery, assuming the name of Ignatius. He succeeded to the patriarchate in 846. He was the enemy of the iconoclasts, and would not consecrate Gregory Asbestos, bishop of Syracuse, present at his consecration, because of heresy. In 857 he refused to admit the emperor, brother of the empress Theodora, as a heretic, on account of his reported immorality, whereupon the offender caused him to be deposed, and Photius to be elected patri-

arch in his place. After his deposition he was treated with the greatest cruelty, and banished to Mitylene; but when Basil the Macedonian ascended the throne in 867, he was recalled.

**IGNATIUS BEAN.** See STRYCHNIA.

**IGNIS FATUUS,** a flickering light seen at night over the surface of marshy grounds or graveyards. Sometimes it moves quietly along, resembling the light of a lantern carried in the hand; and again it appears not alone, but two or three together dancing merrily together up and down. In the night mists it seems like the light from some neighboring house; and many a traveller has been led by it into dangerous bogs, from which he found no escape till the appearance of the morning light. It is not strange that a character of mystery should have attached to this luminous appearance, and that the ignorant should have ascribed it to some evil spirit. They called it "Will o' the wisp" and "Jack with a lantern," and this imaginary person is often alluded to by the old English poets. It is commonly believed that the light retires before one who pursues it; this notion is confirmed by the statements of some observers, and disproved by those of others. In Milner's "Gallery of Nature," p. 544, is recorded a statement of Mr. Blesson, who carefully investigated the phenomena in the forest of Gorbitz, in Brandenburg. On a marshy spot he observed bluish purple flames at night, where bubbles of air issued during the day. These flames retired as he approached, in consequence, he supposed, of the air being agitated by his movement. When he stood perfectly still they soon appeared within reach; and then, carefully guarding against disturbing the air by his breath, he succeeded in singeing a piece of paper, which became covered with a viscous moisture. At last a narrow slip of paper took fire. By disturbing the air over the spot he caused the flames to disappear entirely, but in a few minutes after quiet was restored they appeared again over the air bubbles, apparently without having communication with any known source of flame. On suddenly introducing a torch after extinguishing the flame, a kind of explosion was heard, and a red light was seen over 8 or 9 sq. ft. of the marsh, which diminished to a small blue flame from 2½ to 3 ft. high. He concluded that the cause of the ignis fatuus was the evolution of inflammable gas from the marsh, and that the flames existed by day as well as at night, though not then visible. The lights seen occasionally over churchyards are of similar appearance to those described. These meteors are supposed to be the result of the spontaneous combustion of inflammable gases generated by the decomposition of vegetable or animal bodies. Phosphuretted hydrogen, it is well known, bursts into flame as it is allowed to escape into the air from the vessels in which it is prepared. It is produced by the decay of animal matters, and, if thinly diffused here and there over the surface of a marsh, may present the changing,

flickering light of the ignis fatuus, as difficult to locate as the illumination of the fireflies, for which it has been mistaken by several eminent naturalists. What is known as marsh gas is a highly inflammable carburetted hydrogen, which bubbles up through the water that covers boggy places, and may be inflamed on the surface. This may be ignited by phosphuretted hydrogen, and add to the extent and permanence of the flames. The small quantity of these combustible matters present in the air will account for the feebleness of the flames, which have rarely been known to set fire to other substances; and the varying quantity and purity of that exhaled would explain the constantly shifting brightness of the light. According to the account in the "Gallery of Nature" referred to, in the middle of the last century the snow on the summit of the Apennines appeared enveloped in flame; and in the winter of 1693 hay ricks in Wales were set on fire by burning gaseous exhalations.

**IGUALADA**, a town of Spain, in the province and 33 m. N. W. of the city of Barcelona; pop. about 11,500. It stands on high ground, on the left bank of the river Noya. The streets are narrow, and the buildings packed closely together, with little regard to elegance, comfort, or cleanliness. Woollen and cotton goods, paper, and firearms are manufactured, and there are fairs in January and August.

**IGUANA**, a lizard constituting the type of the family *iguonidae*. The family characters are: a body covered with horny scales, without bony plates or tubercles, not disposed in circular imbricated series, and without large square plates on the abdomen; there is generally a crest along the back or the tail; no large polygonal scutes on the head; the teeth sometimes in a common alveolus, and sometimes united to the free edge of the jaws; tongue thick, free only at the point, and without sheath; eyes with movable lids; toes distinct, free, and all unguiculated. The very numerous genera of this family have been conveniently divided into two subfamilies by Duméril and Bibron, according to the manner in which the teeth are implanted. In the pleurodonts, all but one American, the teeth are arranged in a groove of the jaws, are attached to their inner surface, and are often curiously flattened and serrated on the free edge; in the acrodonts, all of the eastern hemisphere, there is no such groove, and the teeth grow upon the edge of the jaws. For the characters of the second subfamily, having 15 genera and about 60 species, see DRAGON, STELLIO, and the genus *aguma*, below. The pleurodonts comprise 31 genera and more than 100 species; *anolis* and *basiliaeus* have been already noticed under those titles, and the only genus here described will be *iguana* (Laurenti). The characters of this genus are: a very large thin dewlap under the throat; cephalic plates flat, unequal, and irregular; a double row of small palate teeth; a crest on the back and tail; fingers and toes five, long,

of unequal lengths, the fourth of the hind foot very long; a single row of femoral pores; tail very long, slender, compressed, and covered with small, regular, imbricated, ridged scales. The common iguana (*I. tuberculata*, Laur.) attains a length of 4 or 5 ft., of which the tail is about two thirds; it is found in tropical South America and the West Indies. The nasal openings are at the end of the obtuse muzzle; the teeth are about 50 in each jaw, with card-like ones on the palate in two series; the dewlap is about as deep as the head, triangular, having about a dozen serrations on its anterior border; along the neck and back is a comb-like crest of about 55 scales, highest in this species, extending on to the tail, where it becomes a simple serrated ridge; the femoral pores are 14 or 15, widest and opening in a single scale in the males. The color above is greenish, with bluish and slaty tints, and greenish yellow below; on the sides are generally brown zigzag bands



*Iguana tuberculata.*

with a yellow border, with a yellowish band on the front of the shoulder; some are dotted with brown, with yellow spots on the limbs; the tail is ringed broadly with alternate brown and yellowish green. The flesh of the iguana is considered a great delicacy, though it is not peculiarly wholesome. It passes most of its time in trees, in which it is caught by slip nooses; it is said to be a good swimmer, and some of the subfamily, as *amblyrhynchus*, pass most of their time in the water, and even in the sea.—The iguanas of the eastern hemisphere, of the acrodont subfamily, are often called agamas, from one of the principal genera. The genus *aguma* (Daudin) has a flat triangular head, neck, and sometimes the ears spinny, body covered with small imbricated scales, no dorsal crest, tail long, slender, and rounded, anal but no femoral pores, a longitudinal fold along the throat, and sometimes a transverse one; the teeth are united to the edge of the jaw, and may be distinguished into posterior or molars

and anterior or canines and incisors; no teeth on the palate. None of this subfamily are found in America. The common agama (*A. colonorum*, Daudin) is the largest of the genus, being from 12 to 16 in. long, of which the tail is more than half; it is found on the Guinea and



*Agama colonorum.*

Several coats. The spiny agama (*A. spinosa*, Seba) is short and thick, with short tail and spiny scales; it is about 7 in. long, and inhabits the Cape of Good Hope. Some of the acrodonts in Asia and Australia are of very strange forms; the habits and general appearance are like those of the American iguanas.

**IGUANODON**, a gigantic fossil saurian reptile, discovered by Dr. Mantell in the Wealden formation of Great Britain in 1822, and so named from the teeth resembling in shape those of the iguana. The teeth of the iguanodon resemble those of the iguana also in the elongation and contraction of the base, the expansion



*Iguanodon.*

of the crown, the serration of the edges, and the thin coating of enamel; but the crown is relatively thicker, with a more complicated external and internal structure, and the roots are placed in separate sockets as in the crocodile. The vertebræ have slightly concave articular

surfaces on the body, with nearly flat sides; the neural arch of the dorsals is high and expanded, as in other dinosaurians; the antero-posterior diameter is from 4 to 4½ in.; the spinal canal is completely enclosed by the neural arches; the sacral region is of considerable extent, and widely embraced by the iliac bones; in the tail the spinous processes increase for some distance below the sacrum and then diminish, and this organ was probably relatively shorter than in the iguana; the ribs are largely developed in the thoracic and abdominal regions, and connected both with the body and the transverse process of each vertebra, as in other dinosaurians and in crocodiles, and unlike the iguana and other lizards; the scapular arch is intermediate between the crocodilian and lizard type, the clavicle being more than 3 ft. long; the pelvic arch has rather a lacertian character; the thigh bones are stout, and about 3 ft. long, with the head rounded and produced, as in mammals, over the inner side of the shaft, and a singularly flattened trochanter, and must have supported the heavy body in a manner like that of the large pachyderms; the bones of the leg are robust and about 2½ ft. long, and the whole extremity bears little resemblance to that of the iguana; the feet resemble those of saurians. This reptile has been estimated by Owen as about 28 ft. in length, of which the head was 3 and the tail 13 ft.; it stood higher on the legs than any existing saurian, and was terrestrial in its habits; the worn condition of the teeth indicates that it was a herbivorous animal. It belongs to the family of dinosaurians with *megalosaurus*, *hylæosaurus*, and *pelorosaurus*, and is found in the Wealden and cretaceous formations. The *I. Mantelli* (Cuv.), from the characters of the worn dental surfaces, must have performed a true process of mastication, and the glenoid cavity must have permitted a lateral movement of the lower jaw; the large facial foramina indicate more fleshy cheeks and lips than in any existing saurians. Dr. Mantell was of opinion that it had a nasal integumental horn.

**ILIRE, Johan**, a Swedish philologist, born in Lund, March 3, 1707, died Dec. 1, 1780. His father, of Scotch descent, was for a time professor of theology at Upsal. He graduated at the university in 1730, and in 1738 became professor of belles-lettres and political science. His *Glossarium Sueco-Gothicum* (2 vols., Upsal, 1769) was prepared under the patronage of the government, which allowed him in 1756 a grant of 10,000 Swedish dollars. His dissertations on the Eddas and on Ulfilas are important.

**ILI**, or **Eelee**, a river of central Asia, which rises on the northern slope of the mountains of Thian-shan-nan-lu, traverses a part of eastern Turkistan, and flows into Lake Tengiz or Balkash, near the borders of Siberia. Its length is about 450 m.

**ILIAD.** See HOMER.

**ILINIZA, Ilinisa**, or **Ilinisa**, Pyramids of, certain peaks of the Cordilleras of Quito, in South



America, about 10 m. S. of Quito. They are about 17,380 ft. high, and seem originally to have constituted a single mountain, which has been rent apart by volcanic forces. They are visible not only from all parts of the country intervening between the Cordilleras of Quito and the Pacific, but from great distances at sea.

**ILION**, a village in the town of German Flats, Herkimer co., New York, on the right bank of the Mohawk river, and on the New York Central railroad and Erie canal, 70 m. W. N. W. of Albany; pop. in 1870, 2,876. It contains two hotels, a national bank, a brewery, a weekly newspaper, and several schools and churches. It is chiefly noted as the seat of E. Remington and sons' firearms manufactory, of the Remington empire sewing-machine company, and the Remington agricultural works, which employ a large number of men. It was incorporated in 1865.

**ILISSUS**, a river of Attica, rising near the N. extremity of Mt. Hymettus, and flowing through the S. part of Athens toward the Phaleric bay, which it rarely reaches even in the rainy season, while in summer it always dries up in the vicinity of the city. The spreading plane trees and verdant banks of the Ilissus, which Plato immortalized in his "Phaedrus," have given place to pigmy bushes and sunburnt rocks.

**ILIUM**. See **TROY**.

**ILİYATS**, or **Eclants**, a nomadic tribe of Persia, Kkiva, and Turkistan. The name Iliyat is the plural of *iel* (*eel*), a tribe, equivalent to the Arabic *kabilah*. The Iliyats are mostly of Turkish, Arabic, and Kurdish descent, and form an important portion of the population of Persia and adjacent countries; their actual numbers are not known, but it is said that the Iliyat tribes tributary to Khiva numbered 195,000. They live in tents and have no settled habitations, changing their places of encampment with the season or climate. Some tribes live solely by rapine and plunder; others resort only occasionally to such means. They have large flocks and herds, which they often augment by taking those of their neighbors; they are therefore much dreaded by the settled and civilized population. The distances that some of the Iliyat tribes travel in their annual migrations are wonderful. From the southern shores of Fars, the Kashkai tribe of Iliyats arrive in spring on the grazing grounds of Ispahan, where they are met by the Bakhtiars from the northern shores of the Persian gulf. At the approach of winter both tribes return. The Iliyats are Mohammedans of the Sunni sect, but are not very strict in their religious observances, and are not ruled like the townsmen by the mollah. In each province of Persia there are two chiefs acknowledged by all the tribes. The chief of the Kashkai tribe, which numbers more than 25,000 tents, is obliged by the government to reside at Shiraz, as a hostage for the good behavior of his clan, though otherwise free to live as he pleases.

The Iliyat women are said to be chaste, and many of the best families in Persia are of Iliyat origin. The present royal family is of the Kajar tribe, a Turkish *iel*, which came into Persia with Tamerlane.—See Mounsey's "Journey through the Caucasus and the Interior of Persia" (London, 1872), and Markham's "History of Persia" (London, 1874).

**ILKESTON**, a town of Derbyshire, England, 9 m. N. E. of Derby, on the Erwash Valley railway; pop. in 1871, 9,662. It is rapidly increasing in population, and contains a fine old parish church and a mechanics' institute and library. Hosiery and silk fabrics are manufactured, and coal is mined.

**ILLE-ET-VILAINE**, a N. W. department of France, in Brittany, bounded N. by the English channel, and bordering on the departments of Manche, Mayenne, Loire-Inférieure, Morbihan, and Côtes-du-Nord; area, 2,596 sq. m.; pop. in 1872, 589,532. It is named after its principal rivers, the Ille and Vilaine, the latter flowing W. and S. W. through this department and Morbihan to the Atlantic, and partly navigable, and the former joining it from the north at Rennes. It is traversed from W. to E. by the Armoric hills or Menez mountains. The surface is irregular, and the soil generally poor. Flax and hemp are extensively cultivated; tobacco is grown to some extent, as are grapes and other fruit. The fisheries are important, and excellent oysters are found in the bay of Cancale. Several iron mines are worked; slate, quartz, limestone, and granite are quarried; lead and copper ore are found; mineral springs are numerous. The manufactures consist chiefly of coarse linen and sail cloth. The coasting trade is active. It is one of the poorest French departments. It is divided into the arrondissements of Rennes, Fougères, Montfort, St. Malo, Vitré, and Redon. The principal seaport is St. Malo. Capital, Rennes.

**ILLINOIS**, a tribe of North American Indians, of the Algonquin family, comprising the Peorias, Moingwenas, Kaskaskias, Tamaroas, and Cahokias. At an early period, aided perhaps by the Delawares on the east, they drove the Quapaws, a Dakota tribe whom they styled Arkansas, from the Ohio to the southern Mississippi. About 1640 they nearly exterminated the Winnebagoes. They were at war with the Iroquois from about 1656, and with the Sioux soon after. The French, by their missionaries, first met the Illinois at Chegoimegon on Lake Superior in 1667; in 1672 Marquette found the Peorias and Moingwenas in three towns west of the Mississippi, near the Des Moines, as well as Peorias and Kaskaskias on the Illinois. The Tamaroas were on the Mississippi, and a tribe called the Michigameas, who seem to have been really Quapaws, also belonged to the confederacy. The Illinois at this time were numerous and brave, expert bowmen, but not canoe men. They moved off to the plains beyond the Mississippi in villages for a short summer hunt, and for a winter hunt of

for five months. Then they would gather round a large town, of arbor-like cabins covered with double water-proof mats, with generally two families to a cabin, and two families to a fire. The French, Membré, and other missionaries found the Illinois town consisting of 300 to 400 and 8,000 people. They were badly defeated by the Iroquois in 1679, shortly after they reached there, and in the war lost 300 killed and 900 prisoners; but they repulsed and aided the French in their operations against the Iroquois, sending their contingents to the expeditions of De la Barre and DuRoi. Although constantly at war and addicted to vices, they listened to the missionaries Marquette, Allouez, Grand and others, who finally converted them and greatly improved their condition. In 1681, their great chief, visited France, as highly esteemed. His son of the same name retained the great influence of his father till his death in 1754. In 1700 the Illinois removed from the upper waters of the Illinois to the spot that bears their name, led by their chief Roinnac, who wished to emigrate to Louisiana. In 1712 they marched to the aid of the French to relieve that post, then besieged by the Iroquois. In the war with that tribe they were defeated severely, and the Illinois of the Rock River and Pimiteou were driven from their villages.

In 1719 the whole nation was reduced to 100 souls. They remained faithful to the French in the Natchez troubles, and sent a messenger to D'Artagnette's fatal expedition against the Chickasaws. Although they lost constantly in their war with the Foxes, their head chief, Changuonias led a force with Villiers to some of the frontier posts in Virginia in April, 1756, and captured a small fort. They took no part in Pontiac's war; but when the British were killed in one of their towns, the French renewed the war. They joined the British in their war against the United States, and made peace at Greenville, Aug. 3, 1795.

On March 3, 1791, 350 acres were set apart to the Kaskaskias, and the right of local government was recited, an annuity of \$1,000 and provision made for building a house for the chief and a Catholic church, as well as for the maintenance of a priest. The Peorias, who were not parties to this treaty, joined in it at Edwardsville, Sept. 25, 1818, by which the Illinois ceded all their lands in the state to the United States, and a 12 years' annuity of \$100,000 in goods and a 12 years' annuity of \$100,000. The Peorias, to the number of 100, on the Blackwater river, Missouri, and 36 Kaskaskias remained in Illinois. By the treaty of 1832, they again ceded lands, receiving a large tract further west, with some money and an outlay for erecting dwellings and improving agricultural implements. They were within the limits of the present state of Illinois, where they remained till 1867. They sought to improve, but lost in numbers, so

that in 1854 they confederated with the Weas and Piankeshaws. In 1867 they were again removed, and placed southwest of the Quapaws, on a reservation of 72,000 acres. Here they remain, but the whole Illinois nation had dwindled in 1872 to some 40 souls; the combined tribe of Weas, Piankeshaws, Peorias, and Kaskaskias numbering only 160 in all. The United States government in 1873 held stocks for their benefit amounting to \$124,747 94, and a balance at interest of \$64,164 69. The language of the Illinois was reduced to grammatical rules by Père Gravier, and Père le Boulanger drew up a very full grammar and dictionary.

ILLINOIS, one of the interior states of the American Union, the eighth admitted under the federal constitution, and now the fourth in population. It is situated between lat. 36° 59' and 42° 30' N., and lon. 87° 35' and 91° 40' W.; extreme length N. and S. 385 m., extreme breadth E. and W. 218 m.; area, 55,410 sq. m. It is bounded N. by Wisconsin, N. E. by Lake



State Seal of Illinois.

Michigan, E. by Indiana, from which it is separated in part by the Wabash river, S. E. and S. by Kentucky, from which it is separated by the Ohio, and S. W. and W. by Missouri and Iowa, from which it is separated by the Mississippi. The state is divided into 102 counties, viz.: Adams, Alexander, Bond, Boone, Brown, Bureau, Calhoun, Carroll, Cass, Champaign, Christian, Clark, Clay, Clinton, Coles, Cook, Crawford, Cumberland, De Kalb, De Witt, Douglas, Du Page, Edgar, Edwards, Effingham, Fayette, Ford, Franklin, Fulton, Gallatin, Greene, Grundy, Hamilton, Hancock, Hardin, Henderson, Henry, Iroquois, Jackson, Jasper, Jefferson, Jersey, Jo Daviess, Johnson, Kane, Kankakee, Kendall, Knox, Lake, La Salle, Lawrence, Lee, Livingston, Logan, McDonough, McHenry, McLean, Macon, Macoupin, Madison, Marion, Marshall, Mason, Massac, Menard, Mercer, Monroe, Montgomery, Morgan, Moultrie, Ogle, Peoria, Perry, Piatt, Pike, Pope, Pulaski, Putnam, Randolph, Richland, Rock Island, St. Clair, Saline, Sangamon, Schuyler, Scott, Shelby, Stark, Stephenson, Tazewell, Union, Vermilion, Wabash, War-

ren, Washington, Wayne, White, Whitesides, Will, Williamson, Winnebago, and Woodford. Springfield, near the geographical centre of the state, lat. 39° 48' N., lon. 89° 45' W., is the seat of government; it is situated in the midst of a fine agricultural district, and has an active trade, being well supplied with railroad transportation. Chicago is the commercial metropolis, and the largest city on the northern lakes. Kaskaskia and Cahokia are the oldest towns in Illinois, having been founded by the French some time between 1680 and 1690. Kaskaskia was the first capital, and so remained till 1818, when the government was removed to Vandalia, and thence to Springfield in 1836. According to the census of 1870, the cities of Illinois were: Alton, pop. 8,665; Amboy, 2,825; Anna, 1,269; Aurora, 11,162; Belleville, 8,146; Bloomington, 14,590; Bushnell, 2,003; Cairo, 6,267; Centralia, 3,190; Champaign, 4,625; Chicago, 298,977; Danville, 4,751; Decatur, 7,161; Dixon, 4,055; Elgin, 5,441; El Paso, 1,564; Freeport, 7,889; Galena, 7,019; Galesburg, 10,158; Jacksonville, 9,203; Joliet, 7,263; La Salle, 5,200; Litchfield, 3,852; Macomb, 2,748; Mendota, 3,546; Monmouth, 4,662; Morris, 3,138; Mount Carmel, 1,640; Olney, 2,860; Ottawa, 7,736; Pekin, 5,696; Peoria, 22,849; Peru, 3,650; Quincy, 24,052; Rockford, 11,049; Rock Island, 7,890; Shelbyville, 2,051; Springfield, 17,364; Sterling, 3,998; Watseka, 1,551; and Waukegan, 4,507. The population of Illinois has been as follows:

CENSUS YEARS.	White.	Free colored.	Slaves.	Total.	Rank.
1810.....	11,501	618	168	12,287	26
1820.....	53,783	457	917	55,211	24
1830.....	153,061	1,637	747	155,445	20
1840.....	472,254	3,538	831	476,623	14
1850.....	846,094	5,436	.....	851,530	11
1860.....	1,704,291	7,628	.....	1,711,919	4
1870.....	2,511,096	28,762	.....	2,539,858	4

Of the total population in 1870, 1,316,537 were males and 1,223,354 females; 2,024,693 were of native and 515,198 of foreign birth. Of the former, 1,189,503 were born in the state; of the foreigners, 32,550 were born in British America, 3,711 in Denmark, 10,911 in France, 203,758 in Germany, 53,871 in England, 120,162 in Ireland, 15,737 in Scotland, 3,146 in Wales, 4,180 in Holland, 11,880 in Norway, 29,979 in Sweden, and 8,980 in Switzerland. The density of population was 45.84 to the square mile. There were 474,533 families, with an average of 5.35 persons to each, and 464,155 dwellings, with an average of 5.47 persons to each. The increase of population from 1860 to 1870 was 48.36 per cent. The number of male citizens 21 years old and upward was 542,833. There were in the state 818,766 persons from 5 to 18 years of age; the number that attended school was 548,225; 86,368, 10 years of age and over, could not read, and 133,584 could not write. Of the latter, 90,595 were of native and 42,989 of foreign birth;

54,671 were white males, and 69,053 white females; 4,924 were colored males, and 5,024 colored females; 12,525 were from 10 to 15 years old, 15,340 from 15 to 21, and 103,709 21 and over, of whom 40,081 were white males, 56,857 white females, 3,969 colored males, and 4,082 colored females. The proportion of illiterates 10 years of age and upward to the total population of the same age was 7.38 per cent, being 6.29 for males and 8.59 for females. The proportion of illiteracy among adults was 7.16 per cent. for males and 11.16 for females. The number of persons supported by public charity during the year ending June 1, 1870, was 6,054, at a cost of \$556,061; there were receiving support June 1, 1870, 2,363, of whom 1,254 were native and 1,109 foreign born. The number of persons convicted of crime during the year was 1,552. Of the total number (1,795) in prison June 1, 1870, 1,372 were native born and 423 foreigners. There were 1,042 blind, 833 deaf and dumb, 1,625 insane, and 1,244 idiotic. Of the total population 10 years old and over (1,809,606), there were engaged in all occupations 742,015; in agriculture, 376,441, including 133,649 agricultural laborers, 240,256 farmers and planters, and 2,162 gardeners and nurserymen; in professional and personal services, 151,931, of whom 3,192 were clergymen, 44,903 domestic servants, 431 journalists, 63,130 laborers not specified, 2,683 lawyers, 4,861 physicians and surgeons, 8,869 teachers not specified; in trade and transportation, 80,422; and in manufactures and mechanical and mining industries, 133,221, of whom 9,412 were blacksmiths, 6,279 boot and shoe makers, and 23,040 carpenters and joiners. The total number of deaths from all causes, as reported by the census of 1870, was 33,672, the percentage of the deaths to the population being 1.33; from consumption, 3,641, there being 93 deaths from all causes to 1 from consumption. There were 2,882 deaths from pneumonia, 2,163 from scarlet fever, 888 from intermittent and remittent fevers, and 2,551 from diarrhoea, dysentery, and enteritis.—Illinois occupies the lower part of that inclined plane of which Lake Michigan and both its shores are the higher sections. Down this plane in a very nearly S. W. direction the principal rivers have their courses to the Mississippi. The lowest section of this plane is also the extreme S. angle of the state, and is only 340 ft. above the gulf of Mexico. The greatest elevation of the country is 1,150 ft., and the mean elevation about 550 ft., above tide water. Next to Louisiana and Delaware, indeed, Illinois is the most level state of the Union. A small tract in the N. W. corner of the state around Galena, which includes the lead mines, is hilly and somewhat broken, and there are bluffs on the Mississippi and Illinois rivers; but by far the greater portion of the surface consists of vast level or gently undulating prairies. A low mountain ridge extends across the S. end of the state, from Grand Tower on the Mississippi to Shawneetown

in the Ohio, constituting the fruit region of southern Illinois. The chief rivers within the state are the Rock, Illinois, and Kaskaskia, affluents of the Mississippi; the Embarras and Little Wabash, tributaries of the Wabash; and the Saline and Cash, which fall into the Ohio. The Illinois is much the largest of these; its constituents are the Kankakee from Indiana and the Des Plaines from Wisconsin, and in its entire course of nearly 500 m. (245 navigable) to the Mississippi it receives the Fox and Spoon rivers and Crooked creek from the right, and the Vermilion, Mackinaw, Sangamon, &c., from the left. It has a wide deep bed, and in some parts opens into broad and lake-like expanses. Rock river also rises in Wisconsin, and has a course of 100 m. to the Mississippi; it is imperfectly navigable for 75 m., and its upper course is impeded by rapids. The Kaskaskia has its sources in Champaign co. (in which also rise the Sangamon, Embarras, and the southern constituents of the Vermilion), and pursues a direction nearly parallel with the Illinois; it has a length of 250 m. The Big Muddy, an affluent of the Mississippi, between the Ohio and the Kaskaskia, is also a considerable stream. The rivers flowing into the Ohio and Wabash are generally of less volume than the smaller class of streams flowing into the Mississippi, but several are navigable. Chicago river falls into Lake Michigan; it is formed by the union of its N. and S. branches about 1 m. from the lake. Both branches are deep 12 to 15 ft.), and in connection with the main river form a spacious harbor, which has been much improved by the extension of piers far into the lake. The S. branch is connected with the navigable Illinois at Peru by the Illinois and Michigan canal, 96 m. long.—Notwithstanding the general uniformity of the surface, Illinois is not destitute of interesting scenery. The river bluffs contrast strikingly with the smooth prairies. The most remarkable of these elevations are on the Mississippi, and are from 100 to 400 ft. high. Fountain bluff in Jackson co. is oval, 6 m. in circuit and 300 ft. high; the top is full of sink holes. Starved Rock and Lover's Leap are eminences on the Illinois; the first named is a perpendicular mass of limestone and sandstone, 8 m. below Ottawa, rising 156 ft. above the river, and the latter a ledge of precipitous rocks some distance above Starved Rock. Nearly opposite Lover's Leap is Buffalo Rock, 60 ft. high, precipitous toward the river, but sloping inland. The Cave in the Rock, in Hardin co., on the Ohio, presents on approach a vast mass of rocks, some resembling castellated ruins, and others jutting out in a variety of forms. The entrance to the cave, which is little above high water, is a semicircular hole 80 ft. wide and 25 ft. high, and the cave so far as explored consists of a chamber 80 ft. long, at the end of which is a small opening which probably leads into a second chamber. In the earlier days of

settlement it was the abode of bands of robbers and river pirates.—The unbroken surface of Illinois affords a drainage extending from the borders of Lake Michigan toward the west and southwest across the entire state. The post-tertiary clay and sands containing freshwater shells of living species, found a few feet above the level of the lake, and forming its banks, indicate that at no remote geological period the land was somewhat less elevated than at present; and the valley of the Illinois with its strongly marked terraced walls of limestone, so disproportioned to the small river that flows between them, would seem to owe its origin to mightier currents, and to point to a time when the great lakes found an outlet by this way to the Mississippi and the gulf of Mexico. The state has been described and mapped as one great coal field; but as the arrangement of the strata has been more carefully studied, this statement is to be received with some modifications. Still, the prevailing rocks throughout the state are those of the coal measures. They occupy most of the country lying S. of a line traced from the mouth of Rock river E. to La Salle co., and thence S. E., crossing the line of Indiana. The formation covers a large portion of the W. part of Indiana, and stretches S. into Kentucky. Its W. margin is near the Mississippi river, along which a belt of the underlying carboniferous limestone comes up, and cuts off the coal formation on that side. The included area, reckoned as one coal field, covers about 40,400 sq. m., of which 30,000 are in Illinois. The most important veins are from 6 to 8 ft. thick. (See COAL, vol. iv., p. 738.) The importance of the coal beds in Illinois is greatly enhanced by their position, conveniently near the Mississippi or the Ohio, and to the railroads, which traverse the state from N. to S. and from E. to W.; and more than 2,000,000 tons per annum are now mined in the state. The iron ores found in the coal measures are of little value. The N. W. corner of Illinois includes a portion of the great western lead-bearing belt. Though in Illinois but a small district, comprising part of Jo Daviess co., contains the lower Silurian limestones in which the lead ores are found, the mines have proved so productive that the metal ranks as one of the important products of the state. Salt is chiefly a product of the southern section, and is found in springs about the head waters of Big Muddy river, Saline creek, and the Little Wabash. Sulphurous and chalybeate springs exist in several localities.—The soils of Illinois are of diluvial origin, and it is probable that in the early geological ages the whole state was a portion of the bed of a great lake. The prairie soils are deep, fertile, and rockless, and produce a luxuriant growth of native grasses and vegetation, which formerly sustained countless herds of buffaloes. The largest of the prairies is that between the streams flowing into the Wabash and those which enter the Mississippi. This

is called the Grand Prairie, but is properly a combination of small prairies partially separated by tracts or groves of timber. The barrens, or oak openings, as they are here called, have frequently a thin soil. In the bottoms or alluvial borders of the rivers the soil is chiefly formed from the deposits of the waters during floods. In some cases the mould so formed is more than 25 ft. deep, and of inexhaustible fertility. One fifth of the alluvial land, however, is unfit for present cultivation, but is productive of timber. A tract called the American bottom, extending along the Mississippi for 90 m., and about 5 m. in average breadth, is of this formation. About the French towns it has been cultivated and produced Indian corn every year without being manured for nearly two centuries. In every part of the state the plough may pass over thousands of acres without meeting even so much as a pebble to impede its course.—The native animals are now almost extinct, but Illinois still has abundance of game, and its northern rivers abound in trout and other fish. The kinds of timber most abundant are oak, black walnut, ash, elm, sugar maple, locust, linden, hickory, pecan, and persimmon. In the south and east yellow poplar and beech are the peculiar growths, and near the Ohio are clumps of a yellow pine and cedar. The bottoms produce cottonwood, sycamore, &c. Illinois indeed is abundantly supplied with timber, but it is unequally distributed, and immense tracts are entirely bare. The fruit trees embrace the apple, peach, cherry, plum, &c., and the grape is largely cultivated. The prevailing winds are N. and N. W. and S. and S. W., the former in the winter months, and the latter during the remainder of the year. The evenness of the surface allows of their free passage, and the atmosphere is in constant motion. Hence the winters are excessively cold, and the summers more than usually hot. The summer heat, however, is greatly modified and refreshed by the ever present breezes; and on the whole the climate is favorable for outdoor occupations, the proportion of clear and cloudy days being about 245 of the former to 120 of the latter. The mean annual temperature on the 40th parallel is about 54°, that of summer 77° and that of winter 33½° F. These figures, however, will vary considerably N. and S. of the parallel indicated; at Beloit on the N. line the mean temperature is 47½°, and at Cairo, the S. angle of the state, 58½°. Vegetation begins with April, and the first killing frosts occur near the end of September. The general salubrity of the climate is well attested; but fevers and fluxes are frequently prevalent in the river bottoms and in the swamps which cover a large part of the southern section. The upland prairies are almost free from endemic disorders.—Illinois is in the front rank of agricultural states. According to the census of 1870, it contained more acres of improved land, and produced more wheat, Indian corn,

and oats, than any other state. In the production of barley it ranked next to California and New York; of flax, next to Ohio and New York; of rye, next to Pennsylvania and New York; and of wool, next to Ohio, California, New York, Michigan, and Pennsylvania. In the value of all live stock on farms it was surpassed only by New York, and contained more swine and horses than any other state, more milch cows than any other except New York, Pennsylvania, and Ohio, and more sheep than any other except Ohio, California, New York, Michigan, Pennsylvania, and Indiana. The state contained 10,329,953 acres of improved land, 5,061,578 of woodland, and 1,491,331 of other unimproved land. The total number of farms was 202,803, including 53,240 having from 20 to 50 acres, 68,130 from 50 to 100, 65,940 from 100 to 500, 1,367 from 500 to 1,000, and 302 containing 1,000 acres and over. The cash value of farms was \$920,506,346; of farming implements and machinery, \$35,576,587; total amount of wages paid during the year, including value of board, \$22,333,707; total estimated value of all farm productions, including betterments and additions to stock, \$210,860,585; orchard products, \$3,571,739; produce of market gardens, \$765,993; forest products, \$1,087,144; home manufactures, \$1,408,015; animals slaughtered or sold for slaughter, \$56,718,944; value of all live stock, \$149,756,698. There were 853,738 horses, 85,075 mules and asses, 640,321 milch cows, 18,766 working oxen, 1,055,499 other cattle, 1,568,286 sheep, and 2,703,348 swine. The chief productions were: 10,133,207 bushels of spring and 19,995,198 of winter wheat, 2,454,578 of rye, 129,921,395 of Indian corn, 42,790,851 of oats, 2,480,400 of barley, 168,863 of buckwheat, 115,854 of peas and beans, 10,944,790 of Irish and 323,641 of sweet potatoes, 10,486 lbs. of clover seed, 153,464 of grass seed, 280,043 of flax seed, 2,747,339 tons of hay, 465 bales of cotton, 5,249,374 lbs. of tobacco, 5,739,249 of wool, 86,083,405 of butter, 1,161,103 of cheese, 104,033 of hops, 2,204,406 of flax, 136,873 of maple sugar, 1,547,178 of honey, 146,262 of wax, 1,960,473 gallons of sorghum molasses, 10,378 of maple molasses, 111,882 of wine, and 9,258,545 of milk sold. In 1872 there were 2,093,308 acres of wheat under cultivation; Indian corn, 7,067,040; oats, 1,817,463; meadows, 2,178,237; other field products, 886,166; in enclosed pastures, 3,807,082; in orchard, 320,703; and in woodland, 6,289,236. There were 930,947 horses, assessed at \$48,790,933; 2,014,901 cattle, \$35,742,563; 98,316 mules and asses, \$5,803,494; 1,092,080 sheep, \$2,140,474; hogs, 3,560,063, \$11,285,464.—In manufacturing industry, Illinois is also classed among the first states of the Union. According to the census of 1870 it ranked sixth both in the amount of capital invested in manufactures and in the value of products. In the total amount of capital it was surpassed by Pennsylvania, New York, Massa-

Ohio, and Connecticut; in the value of products by New York, Pennsylvania, Massachusetts, Ohio, and Missouri. In the value of products of butchering, distilled liquors, lumber, and pork packed, Illinois ranked first in relation of the state to the United States; these industries is shown in the following statement of the total value of products:

INDUSTRIES.	United States.	Illinois.
Butchered.....	\$13,864,061	\$4,251,713
Distilled.....	34,191,183	7,688,751
Lumber.....	42,179,702	7,290,465
Pork.....	56,429,981	19,818,851

Production of grease and tallow Illinois next to New York; in agricultural implements, next to Ohio and New York; in iron and wagons, next to New York and Pennsylvania; in oil, next to Missouri and Ohio; in saddlery and harness, next to Massachusetts, New York, and Pennsylvania; in sash, blinds, next to New York, Pennsylvania, and Missouri; in men's clothing, New York, Pennsylvania, Massachusetts, Ohio. From the above table it appears that more than one third in value of pork packed in the United States is contributed by Illinois. Formerly the pre-eminence in this respect was held by Pennsylvania in consequence of the magnitude of this industry in Cincinnati; but since 1862-'3 that position has been held by Chicago. According to a careful report prepared for the Cincinnati Chamber of Commerce by Sidney D. Maxson, the number of hogs packed in the southwestern states from Nov. 1, 1873, to

March 1, 1874, was 5,888,810, the aggregate gross weight of which was 1,444,811,804 lbs.; of these, 1,870,855, weighing in the aggregate 511,867,475 lbs., were packed in Illinois. The aggregate cost of the hogs was \$22,694,899, and the total product of lard 69,808,168 lbs. The chief centres of this industry for two years are shown in the following statement:

PLACES WHERE PACKED.	NUMBER OF HOGS PACKED.	
	1872-'3.	1873-'4.
Barry.....	9,607	11,000
Charleston.....	10,200	11,868
Chicago.....	1,425,079	1,520,024
Galena.....	29,000	26,000
Lacon.....	17,091	10,827
Mattoon.....	4,988	16,451
Pekin.....	6,000	12,000
Peoria.....	102,500	68,150
Quincy.....	51,988	54,298
Total.....	1,884,218	1,870,855

The growth of this industry in Illinois has been very rapid; thus the number of hogs packed was 805,843 in 1868-'9, 862,413 in 1869-'70, 1,240,959 in 1870-'71, and 1,681,026 in 1871-'2. The total number of manufacturing establishments reported by the census of 1870 was 12,597, using 2,330 steam engines of 73,091 horse power, and 528 water wheels of 12,598 horse power, and employing 82,979 hands, of whom 78,045 were males above 16, 6,717 females above 15, and 8,217 youth. The capital invested amounted to \$94,868,067; wages paid during the year, \$31,100,244; value of materials, \$127,600,077; of products, \$205,620,872. The chief industries are exhibited in the following table:

INDUSTRIES.	No. of establishments.	Steam engine, horse power.	Water wheels, horse power.	Hands employed.	Capital invested.	Wages paid.	Value of materials.	Value of products.
Implement.....	294	2,575	91	3,385	\$5,850,978	\$1,818,885	\$3,598,897	\$3,690,890
Machinery.....	1,210	.....	.....	4,660	2,190,615	1,084,164	2,079,647	4,448,794
Shed.....	25	60	.....	888	578,800	150,008	3,375,079	4,251,713
Foundry and building.....	1,089	227	.....	3,555	1,097,085	1,867,752	3,369,082	6,783,264
Wagon.....	1,165	606	100	4,847	3,429,426	1,770,946	2,218,297	6,019,291
Passenger.....	5	205	.....	849	950,000	501,978	492,285	1,010,007
Men's clothing.....	873	.....	.....	5,989	2,556,810	1,706,310	4,564,196	7,489,868
Men's clothing.....	65	.....	.....	718	229,945	181,845	671,088	977,643
Grain mill products.....	941	28,877	8,968	4,457	14,828,562	1,681,473	35,480,716	43,876,775
Wool specified.....	350	1,087	76	2,059	1,653,156	651,140	888,956	2,614,141
Wool.....	19	126	.....	450	4,561,560	441,787	596,887	2,007,188
Wool.....	5	20	.....	180	284,500	42,480	1,270,480	1,412,800
Wool.....	8	8,721	.....	1,749	2,890,000	1,068,062	1,917,422	3,480,746
Wool.....	4	115	9	192	158,200	110,785	534,760	804,644
Wool.....	109	1,540	217	1,798	2,167,885	957,927	2,094,020	3,788,968
Wool.....	58	629	5	418	594,760	208,815	1,492,078	2,018,774
Wool.....	44	89	.....	394	898,560	169,129	1,748,299	2,184,859
Wool.....	45	2,804	.....	955	2,518,000	550,116	4,878,011	7,568,751
Wool.....	143	1,261	.....	897	4,834,900	481,028	2,028,866	4,164,224
Wool.....	69	2,669	68	1,920	2,298,200	651,021	5,412,912	7,290,465
Wool.....	511	12,882	506	3,100	2,542,580	817,212	2,168,665	4,566,769
Wool.....	80	785	.....	1,097	2,449,600	1,062,378	1,338,668	2,318,797
Wool.....	15	519	20	2,169	3,068,500	1,228,506	921,687	2,168,018
Wool.....	86	78	.....	837	957,800	468,491	615,651	1,896,964
Wool.....	88	664	.....	2,236	6,921,000	448,560	16,836,541	19,818,851
Wool.....	8	80	.....	121	269,500	62,830	1,801,800	1,438,700
Wool.....	9	384	40	153	645,500	64,630	924,292	1,154,088
Wool.....	67	.....	.....	1,982	1,066,815	515,460	1,341,062	2,081,416
Wool.....	94	1,002	298	1,407	1,140,850	666,765	990,895	2,816,620
Wool.....	24	417	.....	205	740,500	83,366	987,998	1,250,890
Wool.....	37	240	.....	1,639	917,550	496,475	1,517,945	3,005,769
Wool.....	297	.....	.....	1,025	1,047,070	343,209	528,977	1,818,947
Wool.....	85	2,182	475	1,680	2,928,198	661,154	1,610,692	2,725,690

—Illinois possesses remarkable commercial facilities in the Mississippi and Ohio rivers on its borders, besides numerous internal streams of importance. Bordering for about 70 m. on Lake Michigan, it is favorably situated for the immense lake commerce which centres at Chicago. This comprises not only the vast domestic trade for which this city is noted, but also a considerable foreign trade carried on with Canada and European ports. Provision was made for direct commercial relations between Chicago and foreign ports by the act of July 14, 1870, which authorizes the transshipment in bond of exports and imports to and from the ports of first arrival, without appraisal and payment of duties at such ports. The value of foreign imports received at Chicago under this system during the year ending June 30, 1873, was \$3,160,756. The total value of foreign imports subject to duty during the year was \$3,699,852, on which the duties collected amounted to \$1,535,631. The value of domestic produce exported from Chicago to Canada by lake was \$7,107,468; the most important items were wheat, \$5,737,022, and Indian corn, \$1,069,586. The leading article of import from Canada is lumber, of which 7,516,000 ft. was imported in 1873. The total number of vessels belonging to the customs district of Chicago in 1873 was 743, having an aggregate tonnage of 148,595; of these, 101 were sailing, 131 steam, and 511 unrigged vessels. The aggregate number of vessels that arrived was 11,858, having a tonnage of 3,225,911; of these, 22 were American vessels from foreign ports, 189 foreign vessels from foreign ports, and 11,647 were in the coasting trade. The number of clearances was 11,876, of which 483 were for foreign and 11,393 for domestic ports. Illinois has four ports of delivery, which, with the number and tonnage of vessels registered, enrolled, and licensed in 1873, were: Galena, 60 vessels, 7,781 tons; Quincy, 23 vessels, 2,443 tons; Alton, 5 vessels, 893 tons; Cairo, 36 vessels, 8,221 tons.

Ship building is carried on at Chicago, Cairo, and Quincy. In 1873, 21 vessels of 5,499 tons, including 10 sailing and 8 steam vessels, were built at Chicago, 4 at Cairo, and 1 at Quincy. —Illinois contains more miles of railroad than any other state in the Union. In 1850 the number of miles was 111. In the following year the construction of the Illinois Central, from the southern terminus of the Illinois and Michigan canal to Cairo, was begun, thus opening a channel of communication between Lake Michigan and the Mississippi river. The subsequent growth of the railroad system of the state was rapid. In 1855 there were 887 m.; in 1860, 2,790; in 1865, 3,157; in 1870, 4,823; in 1871, 5,904; and in 1872, 6,361. In 1873 the total mileage of main track completed and in operation, exclusive of double, side, and turnout tracks, was 6,496; in addition to which numerous lines were projected and in progress. The aggregate cost of the roads and equipments was reported by the railroad commissioners at \$238,584,541 in 1872, and \$278,386,784 in 1873. In 1872 the capital stock paid in was \$140,126,064; funded debts, \$111,456,325; floating debts, 330,173; amount of paid-up stock and debts, \$254,912,563. In August, 1873, the length of main track was returned by the state board of equalization at 5,064 m.; assessed at \$36,271,184; side, second, or turnout track, 863 m., valued at \$4,008,818; value of rolling stock, \$15,892,015; total value of property denominated railroad track and rolling stock, \$59,317,409; right of way and improvement, 64,733 acres, valued at \$3,145,172. This statement does not include the Illinois Central railroad, 705 m. The following table exhibits the names of the lines lying wholly or partly within the state, together with the termini, the number of miles completed and in operation within the state limits in 1873, the capital stock as reported by the commissioners, and the assessed value of the track and rolling stock as returned by the state board of equalization in August, 1873:

NAME OF CORPORATION.	TERMINI.	Length completed in state, miles.	Total length when different from preceding.	Total assessed value of railroad track and rolling stock.	Capital stock paid in, 1873.
Cairo and St. Louis .....	Cairo and East St. Louis .....	45	151	\$949,940	\$3,000
Cairo and Vincennes .....	Cairo and Vincennes, Ind. ....	135	...	1,134,751	...
Carbondale and Shawneetown .....	.....	17	...	183,000	353,000
Chester and Tamaroa .....	Chester and Tamaroa .....	40	...	255,007	1,000,000
Chicago and Alton (main line) .....	Joliet and East St. Louis .....	242	...	4,000,754	11,000,000
Branches .....	Dwight to Washington and Lacon .....	60	...	.....	.....
.....	Roodhouse to Louisiana, Mo. ....	37	...	.....	.....
.....	Joliet and Chicago .....	39	...	563,452	.....
.....	Bloomington and Godfrey .....	151	...	1,561,987	.....
.....	Chicago to Burlington, Ia. ....	207	...	10,148,147	19,000,000
.....	Chicago, Burlington, and Quincy (main line) .....	99	...	.....	.....
.....	Galesburg to Peoria .....	58	...	.....	.....
.....	Aurora to Galena Junction .....	18	...	.....	.....
.....	Geneva to Streator .....	67	...	.....	.....
.....	Mendota to Clinton .....	64	...	.....	.....
.....	Buda to Rushville .....	110	...	.....	.....
.....	Galva to Keithsburg .....	56	...	.....	.....
.....	Burlington, Ia., to Quincy .....	73	...	.....	.....
.....	Shabbona to Rock Falls .....	47	...	.....	.....

NAME OF CORPORATION.	TERMINI.	Length completed in state, miles.	Total length when different from preceding.	Total assessed value of railroad track and rolling stock.	Capital stock paid in, 1872.
Evansville and Vincennes	Dalton and Danville	108	...	\$1,045,817	.....
Iowa	Aurora and Foreston	80	...	781,207	.....
Northwestern	Chicago and Fort Howard, Wis.	75	242	5,723,641	\$6,103,962
St. Louis and Chicago	Rockford and Kenosha, Wis.	45	72	.....	.....
St. Louis and Chicago	Chicago and Clinton, Ia.	187	.....	.....	.....
St. Louis and Chicago	Chicago and Freeport	121	.....	.....	.....
St. Louis and Chicago	Elgin and Geneva Lake, Wis.	35	43	.....	.....
St. Louis and Chicago	Belvidere and Elroy, Wis.	26	141	.....	.....
St. Louis and Chicago	Chicago and Milwaukee, Wis.	48	85	.....	.....
Rock Island and Pacific	Chicago and Council Bluffs, Ia.	182	493	3,145,800	7,877,332
Rock Island and Pacific	Bureau to Peoria	46	.....	.....	.....
Rock Island and Pacific	Chicago to Mississippi river	85	135	142,058	146,020
Rock Island and Pacific	Streator and Louisville	125	200	511,330	1,350,000
Rock Island and Pacific	Streator and Pekin	68	.....	357,350	240,000
Rock Island and Pacific	Lafayette, Ind., and Kankakee	83	75	359,218	.....
Rock Island and Pacific	Columbus, O., and Chicago	92	314	260,629	531,310
Rock Island and Pacific	Terre Haute, Ind., and Danville	6	55	62,572	.....
Rock Island and Pacific	Elmwood and Springfield	110	.....	913,661	2,000,000
Rock Island and Pacific	Grand Tower and Carbondale	24	.....	269,523	.....
Rock Island and Pacific	Carro and Dunleith	455	.....	.....	25,447,140
Rock Island and Pacific	Centralia and Chicago	249	.....	.....	.....
St. Louis	East St. Louis and Belleville	14	.....	213,610	618,000
St. Louis	Indianapolis, Ind., and Pekin	133	202	1,016,764	3,032,381
St. Louis	Champaign to Keokuk, Ia.	102	185	.....	.....
St. Louis	White Heath to Decatur	.....	82	.....	.....
St. Louis	Indianapolis, Ind., and St. Louis, Mo.	188	261	1,881,947	.....
St. Louis	Indianapolis, Ind., and Decatur	80	152	558,850	976,973
St. Louis	Jacksonville and Mt. Vernon	30	123	245,330	.....
St. Louis	Buffalo, N. Y., and Chicago	14	589	818,434	478,000
St. Louis	New Albany, Ind., and Mt. Vernon	29	150	170,208	.....
St. Louis	Detroit, Mich., and Chicago	6	24	153,986	.....
St. Louis	Lake Station, Ind., to Joliet	28	44	168,509	.....
St. Louis	Cincinnati, O., and St. Louis, Mo.	146	340	1,802,448	3,018,891
St. Louis	Paris and Danville	34	.....	262,575	.....
St. Louis	Paris and Decatur	76	.....	746,659	1,600,000
St. Louis	Hervey City to Mattoon	38	.....	.....	.....
St. Louis	Peoria and Jacksonville	58	.....	775,332	1,239,700
St. Louis	Pittsburgh, Pa., and Chicago	14	468	250,417	1,015,405
St. Louis	Sterling and East St. Louis	262	281	2,146,982	6,490,579
St. Louis	Sagetown to Keithsburg	18	.....	.....	.....
St. Louis	East St. Louis and Du Quoin	71	.....	823,174	4,768,400
St. Louis	East St. Louis and Nashville, Tenn.	132	316	2,020,533	3,458,500
St. Louis	McLeansboro to Shawneetown	42	.....	.....	.....
St. Louis	St. Louis, Mo., and Indianapolis, Ind.	159	239	1,916,274	2,377,450
St. Louis	Shawneetown and Beardstown	223	.....	1,350,997	3,776,500
St. Louis	Springfield and Rock Island	29	150	151,550	.....
St. Louis	Warsaw to Indiana state line	237	.....	2,629,367	5,700,000
St. Louis	La Harpe to Burlington	10	.....	.....	.....
St. Louis	Toledo, O., and Camp Point	209	454	3,703,131	9,540,000
St. Louis	Decatur to East St. Louis	108	.....	.....	.....
St. Louis	Clayton to Hamilton	42	.....	.....	.....
St. Louis	Pekin and Decatur	61	.....	771,555	1,500,000
St. Louis	Bluffs and Hannibal	50	.....	472,404	487,000
St. Louis	Bloomington and Lafayette, Ind.	77	118	676,670	1,000,000
St. Louis	Rock Island and Racine, Wis.	126	197	1,114,905	4,000,000

exercises a general supervision over railroad companies within its limits. In the constitutional convention of 1870 the sub-railroad corporations was thoroughly defined, and a provision was incorporated in the constitution requiring the legislature to pass laws establishing reasonable maximums of charges for the transportation of passengers and freight. In the following year a railroad law was passed, which, having been pronounced in part unconstitutional by the supreme court, was repealed, and a new law was passed in 1873. To secure the enforcement of such laws the legislature provided for the appointment by the governor of railroad and warehouse commissioners, and it is to examine into and report concerning the railroad and ware-

house interests of the state. By the act of 1873 every railroad company in the state is prohibited, under penalty of fines reaching as high as \$25,000 for the fourth offence, from charging more than a reasonable rate for the transportation of passengers or freight, and from making unjust discriminations in freight schedules. The companies are required to report in writing and under oath to the commissioners, and to comply with the schedules of reasonable maximum rates for transporting passengers and freight prepared by the commissioners. The latter are required to see that the law is obeyed, and to bring actions against the companies in case of violation. The navigation of Lake Michigan is connected with that of the Illinois river by the Illinois and Michigan canal, completed in 1848, which extends



from Chicago to La Salle, 96 m. The immense commerce which passes through this channel is indicated by the statement that in 1875 not less than 4,000,000 bushels of grain and 50,000,000 ft. of lumber, besides 20,000,000 shingles and bales, passed over the canal. Illinois in 1873 contained 9,545 m. of telegraph lines. The number of national banks in operation was 137, having a paid-in capital of \$20,846,000 and a circulation outstanding of \$16,324,059. The circulation per capita was \$7.02; ratio of circulation to wealth, 0.9 per cent.; to banking capital, 77.4 per cent.—By the constitution of 1870, the legislative power is vested in a general assembly composed of a senate and house of representatives. The senate consists of 51 members elected for four years, and the house of representatives of 153 chosen for two years. A decennial apportionment, beginning with 1871, is held. Senators must have attained the age of 25 years, and representatives 21 years. Elections for members of the general assembly are held biennially, in even years, on the Tuesday next after the first Monday of November. The sessions are biennial, commencing on the Wednesday next after the first Monday of January next following the election. Members receive \$5 a day and 10 cents for each mile necessarily travelled in going to and from the seat of government, and \$50 a session for stationery, &c. Special legislation, which was a source of much mischief under the old constitution, is prohibited in many enumerated cases, and "in all other cases where a general law can be made applicable." The executive department consists of a governor, lieutenant governor, secretary of state, auditor of public accounts, treasurer, superintendent of public instruction, and attorney general, all of whom are elected for four years, except the treasurer, whose term of office is two years, and who is ineligible to the same office for two years next after the expiration of his term. A two-thirds vote of each house is necessary to pass a bill over the veto of the governor. The judicial powers are vested in a supreme, circuit, and county courts, justices of the peace, police magistrates, and certain special courts. The supreme court consists of seven judges, who are elected by the people for nine years, and receive a salary of \$4,000 a year. The chief justice is chosen by his associates. There are three grand divisions of the state, southern, central, and northern, in each of which one or more sessions of the supreme court are held annually. The judges of the circuit courts are elected by the people for six years, and receive an annual salary of \$3,500. The constitution further provides for the establishment of inferior appellate courts to be held by judges of the circuit courts. To these courts appeals and writs of error in certain cases may be taken from the circuit courts, and from them to the supreme court. Each county has a county court, the judge of which is elected for a term of four years. These courts have original

jurisdiction in all matters of probate, but probate courts may be established in any county having a population of over 50,000. There are special courts in Cook county, of which Chicago is the county seat. Imprisonment for debt is prohibited except upon the refusal of the debtor to deliver up his estate for the benefit of his creditors, or in cases where there is strong presumption of fraud. In trials for libel, the truth may be pleaded as a defence in justification. The legal rate of interest, in absence of agreement, is 6 per cent., but 10 per cent. may be agreed upon and collected. The penalty of usury is forfeiture of all the interest. Illinois is represented in congress by two senators and 19 representatives, and is entitled to 21 votes in the electoral college. The receipts into the state treasury for the two years ending Dec. 1, 1872, were \$9,899,603, and the expenditures \$12,351,746. The chief purposes for which the public money was used during this period were: legislative, \$693,062; executive, \$180,158; judicial, \$394,252; educational, \$2,208,264; educational and charitable, \$308,316; charitable, \$918,784; penal and reformatory, \$369,338; agriculture, \$39,007; commerce, \$238,661; state indebtedness, \$4,963,379; new state house, \$793,641. In 1873 the general assembly provided that the amount of revenue to be raised on the assessment of that and subsequent years should be \$1,500,000 for general purposes, to be designated the revenue fund, and \$200,000 for payment of interest on the state debt. The governor and auditor are required annually to compute such rates as will produce these amounts. The rates computed on the equalized valuation for 1872 were 3.33 mills for revenue purposes and 0.47 mill for interest on the state debt. Besides these, provision was made for an annual levy of 2 mills for the support of common schools and 1.5 mill for "canal redemption fund;" making the total levy for state purposes 7.5 mills on the assessment of 1872. The total levy for 1873 was 3.6 mills, being 2.7 mills for general revenue purposes and 0.9 mill for school fund. The state debt in 1863 was \$12,280,000; in 1870, \$4,890,937; and in 1874, \$1,706,750. The valuation of property for the purposes of taxation, for a series of years, has been:

YEARS.	Real estate.	Personal property.	Railroad property.	Total valuation.
1840	.....	.....	.....	\$56,730,100
1850	\$4,582,227	\$38,335,799	.....	119,402,325
1860	266,258,135	58,684,115	.....	327,377,750
1861	284,858,889	80,730,913	11,560,722	377,150,524
1862	278,087,996	78,509,758	11,696,705	368,294,459
1863	282,913,619	67,660,697	11,625,555	362,199,871
1864	242,584,892	102,037,465	12,255,649	356,877,906
1865	262,114,808	116,302,295	15,011,398	393,428,501
1866	278,122,106	122,966,672	14,707,097	415,795,875
1867	331,607,084	136,021,679	16,524,646	484,153,409
1868	317,381,762	122,234,718	14,814,297	454,430,777
1869	346,587,734	126,134,081	14,290,961	486,992,776
1870	347,476,690	118,044,227	19,242,141	484,763,058
1871	366,244,704	118,918,561	25,236,048	510,399,313
1872	371,619,940	118,007,350	25,658,734	515,286,024
1873	399,484,748	306,119,271	188,997,828	1,394,591,847

in the valuations of personal property is \$20,826,462 assessed as valuation other than railroads. It will be seen that the valuations for 1878 are in excess of any previous year; these, however, do not represent a corresponding increase in the value of property, but are due in a large measure to the operation of a new revenue law. The valuations are believed to be about 0.65 per cent. of the value of real and personal property, or nearer the entire value of railroad property.—The charitable and correctional institutions are under the general supervision of the state commissioners of public charities, consisting of five members appointed by the governor with the consent of the senate; it is annually to inspect the institutions under their charge, to report upon their condition. The showing the extent and condition of the correctional, charitable, and educational institutions of the state are generally for 1872, in the most recent biennial report of the penitentiary, which has been at Joliet since 1827, and at the close of 1878 contained 1,255 convicts, the number for the year being 1,288. It is self-sustaining under the leasing the labor of the convicts; earnings in 1872 were \$214,593, while expenses were \$36,218 less. Instruction is afforded to the inmates, and there is a library of about 4,000 volumes. The reform school at Pontiac, opened in 1871, has accommodations for about 150 inmates, which are adapted to the needs of the state. About 150 have been admitted to the institution for the education of the deaf and dumb since its opening in 1845, and 150 were receiving instruction from teachers at the beginning of 1874. The instruction occupies eight years. Children in the state are admitted to the institution of charge, and are supplied with clothing except clothing. A prominent feature of the institution is its industrial department. The annual cost to the state for the support of the institution is about \$250. Its accommodations are generally inadequate. The building used for the education of the blind, also at Jacksonville, destroyed by fire in 1869; new buildings for the education of instruction and workshops are now under construction, with grounds comprising 3 acres. In 1874 about 70 pupils were receiving instruction from four teachers; the expense of instruction is five years. The eye and ear infirmary, created in 1867, is an efficient institution, affording gradual treatment to all applicants who are afflicted with the disease. The foundations for a substantial edifice for this institution were laid in the West Division of Chicago. The hospital for the insane by the hospital at Jacksonville, the northern asylum at

Elgin opened in 1872, and the southern asylum at Anna opened in 1873; the two latter are in process of construction. At the close of 1872 the northern asylum had 188 inmates and the southern 75. The hospital at Jacksonville is constructed on the corridor plan, is five stories high, and comprises a central building with two wings. The accommodations were intended for about 400 patients, though the average number for two years has been 450. The grounds comprise 160 acres. The whole number of patients admitted since the opening of the hospital in 1851 has been 4,527, of whom 1,685 were discharged recovered, 606 improved, and 400 unimproved; 328 improved and unimproved were discharged by order of the trustees, and 467 died. The superintendent of this institution estimates the number of insane in the state at 2,529, or 1 in every 1,000 inhabitants. The hospital accommodations of the state are greatly inadequate to this number. Those under treatment cost the state about \$250 a year each. The manner of committing insane persons to the hospital is by jury trial in the county courts. According to the state board of public charities, the proportion of idiots in the state is at least as large as that of the insane. The institution for the education of feeble-minded children at Jacksonville was created in 1866, and has accommodations for about 100. Only those whose condition can be improved are admitted. The success of the institution and the importance of providing this kind of instruction have recently led to efforts which will result in largely increased facilities for improving this class of unfortunates. The home for the children of deceased soldiers, at Normal, opened in 1867, comprises three main buildings and 80 acres of land. Here support and instruction are afforded to children of this class under 16 years of age. The average attendance during 1873 was 306, while the number of inmates at the close of the year was 326. The current expenses for the year amounted to \$58,389. Besides supporting this institution, the state has aided the soldiers' college at Fulton and the soldiers' home in Chicago, both of which are private institutions.—An efficient system of free schools is provided for all the children of the state, but the constitution prohibits appropriations of public money for sectarian schools. The educational interests of the state are under the general supervision of the superintendent of public instruction. The tax that may be levied in any district for all current school expenses is limited to 2 per cent. for educational and 3 per cent. for building purposes upon the assessed value of the taxable property of the district. Every district is required to maintain a free school at least five months in the year as a condition of receiving a share of the state school funds. Examinations of teachers are held and certificates issued by the county superintendents, and only teachers having such certificates are em-

ployed in the public schools. A marked feature recently introduced into the educational system of this state is the requirement making the elements of natural science a part of the common-school course. The permanent school funds of the state comprise: 1, the school fund proper, being 3 per cent. upon the net proceeds of the sales of the public lands in the state, one sixth part excepted; 2, surplus revenue, derived from the distribution in 1836 of the surplus revenue of the United States; 3, the college fund, being one sixth of the 3 per cent. fund originally required by congress to be devoted to the establishment and maintenance of a state college or university; 4, the seminary fund, derived from sales of lands granted to the state by the general government for the establishment of a state seminary; 5, county funds, created by the legislature in 1835; 6, township funds, arising from the sales of public lands granted by congress for common-school purposes. The aggregate amount of these funds on Sept. 30, 1872, was \$6,382,248, as follows: school fund proper, \$613,363; surplus revenue, \$335,592; college fund, \$156,613; seminary fund, \$59,839; county funds, \$348,285; township funds, \$1,868,555. The total income for school purposes in 1872 from these funds and the current school funds was \$7,500,122; the chief items of the income from current funds being \$900,000 from the two-mill tax, and \$5,292,942 raised by *ad valorem* tax in the districts for general purposes. The condition of the common schools in 1872, according to the latest biennial report of the superintendent of public instruction, was as follows:

Number of school districts	11,291
"    "    "    "    "    "    "    "    "    "    "	11,299
"    "    public schools (high 88, graded 611, ungraded 10,697)	11,976
Average duration of schools	6 months, 27 days
Persons between 6 and 21 years of age	882,608
Number enrolled in schools	662,049
Average daily attendance	829,799
Number of teachers (male 3,084, female 11,880)	80,224
Average monthly salaries of male teachers	\$51 00
"    "    "    "    "    "    "    "    "    "    "    "	\$89 00
Total annual cost per pupil on school census	\$5 61
"    "    "    "    "    "    "    "    "    "    "    "    "	\$7 45
"    "    "    "    "    "    "    "    "    "    "    "    "    "	
"    "    "    "    "    "    "    "    "    "    "    "    "    "	
"    "    "    "    "    "    "    "    "    "    "    "    "    "	
"    "    "    "    "    "    "    "    "    "    "    "    "    "	\$15 02
Total income for school purposes	\$7,500,122
Total expenditures	\$7,480,859
Total approximate value of school property, including houses, land, furniture, libraries, &c.	\$19,576,704
Number of private schools	486
"    "    "    "    "    "    "    "    "    "    "    "    "    "	34,784
"    "    "    "    "    "    "    "    "    "    "    "    "    "	84,256
"    "    "    "    "    "    "    "    "    "    "    "    "    "	
"    "    "    "    "    "    "    "    "    "    "    "    "    "	
"    "    "    "    "    "    "    "    "    "    "    "    "    "	
"    "    "    "    "    "    "    "    "    "    "    "    "    "	
"    "    "    "    "    "    "    "    "    "    "    "    "    "	6,753

The state normal university, for the training of teachers, at Normal, was organized in 1857, and comprises, besides the usual departments, a model school. The course of instruction is three years, upon the completion of which a diploma is conferred. In 1873 there were 13 instructors, besides a large number of pupils acting as teachers, and 730 pupils, of whom 437 were in the normal and 293 in the model school. The southern Illinois normal university, at Carbondale, was completed in 1874. In addition

to these state institutions, there are county normal schools in Cook and Peoria counties, a German-English normal school at Galena, and normal departments connected with several other institutions. For the further instruction of teachers, numerous county institutes are held, besides occasional sessions of the state teachers' institute. The Illinois industrial university, opened in 1868, is both state and national, having been organized by the legislature, and having received the national grant of lands intended for the establishment of colleges of agriculture and the mechanic arts. This institution is situated at Urbana, where it has one of the finest buildings of the kind in the country, being four stories high and 214 ft. long, with a depth on the wings of 122 ft. The grounds comprise 623 acres, including stock farm, experimental farm, orchards, gardens, nurseries, forest plantations, arboretum, botanic garden, ornamental grounds, and military parade ground. The property and funds of the university amount to nearly \$800,000. Students of both sexes are admitted. The university embraces a college of agriculture, comprising a school of agriculture proper and a school of horticulture and fruit growing; a college of engineering, with schools of mechanical science, civil and mining engineering, and architecture; a college of natural science, with schools of chemistry and natural history; and a college of literature and science, with a school of English and modern languages and one of ancient languages and literature. There are also schools of commerce, military science, and domestic science and arts. Entire freedom in the choice of studies is allowed to each student; but the completion of one of these courses or the prescribed equivalents is necessary to graduation. The number of pupils in 1873 was 402, of whom 74 were females. The Illinois agricultural college, at Irvington, organized in 1866, had 226 students and 6 instructors in 1873. The course of instruction is four years. Besides the buildings in use, the institution has 550 acres of land. According to the census of 1870, Illinois had 26 colleges, with 223 instructors and 4,657 pupils; 32 academies, with 201 instructors and 4,690 pupils; 2 law schools, with 3 instructors and 61 students; 2 medical schools, with 19 instructors and 358 pupils; 9 theological schools, with 28 instructors and 575 pupils; besides 2 schools of agriculture, 2 of commerce, and 2 of art and music. Six of these institutions were classified as universities. Besides the above named, there were 531 private day and boarding schools, with 1,526 teachers, of whom 1,035 were females, and 41,456 pupils, of whom 21,044 were females. The total number of schools, public and private, was 11,835, having 24,056 teachers, of whom 13,645 were females, and 767,775 pupils, including 377,820 females. The total income of all the educational institutions was \$9,970,009, of which \$252,569 was derived from endowments,

0 from taxation and public funds, \$9,930 from other sources, including The most important facts concerning colleges and universities of Illinois are the article COLLEGE. The following

statement shows the extent and condition of the institution for the advanced instruction of females and professional schools, as reported by the United States bureau of education in 1878:

NAME OF INSTITUTION.	Where situated.	Denomination.	Date of organization.	Number of teachers.	Number of pupils.
<b>FOR INSTRUCTION OF FEMALES:</b>					
of the Sacred Heart.....	Chicago.....	Roman Catholic.....	1858	27	120
's college, Northwestern university.....	Evanston.....	Methodist Episcopal.....	1878	11	119
college.....	Greenville.....	Baptist.....	1890	9	108
female college.....	Jacksonville.....	Methodist Episcopal.....	1847	13	98
ville female academy.....	".....	Presbyterian.....	1890	14	144
west university.....	Lake Forest.....	Presbyterian.....	1869	15	75
ngela's academy.....	Morris.....	Roman Catholic.....	1857	10	190
Carroll seminary.....	Mount Carroll.....	Non-sectarian.....	1858	12	200
d female seminary.....	Rockford.....	Cong. and Presb.....	1850	16	89
ical department of Shurtleff college.....	Alton.....	Baptist.....	1908	4	12
ical department of Blackburn university.....	Carlinville.....	Presbyterian.....	1867	4	18
ological seminary.....	Chicago.....	Congregational.....	1855	6	42
union theological seminary.....	".....	Baptist.....	1867	5	49
ical seminary of the northwest.....	".....	Presbyterian.....	1858	5	29
Biblical institute.....	Evanston.....	Methodist Episcopal.....	1855	16	63
department of Eureka college.....	Eureka.....	Christian.....	1864	2	22
ical seminary of the northwest.....	Monmouth.....	United Presbyterian.....	1889	2	12
ms seminary.....	Paxton.....	Lutheran.....	1840	2	18
college.....	Robin's Nest.....	Protestant Episcopal.....	1841		
ool of university of Chicago.....	Chicago.....		1859	4	22
partment of McKendree college.....	Lebanon.....		1859	1	7
medical college (Northwestern university).....	Chicago.....		1859	19	120
ical college.....	".....		1842	22	194
's hospital medical college.....	".....		1870	16	22
college of eclectic medicine and surgery.....	".....		1866	12	120
college of pharmacy.....	".....		1859	4	50
man medical college (homoeopathic).....	".....		1859	16	65

ling to the census of 1870, the number es was 13,570, containing 3,323,914 Of these, 9,865 with 2,399,369 volre private, and 3,705 with 924,545 other than private, including 79 cir- libraries containing 75,352 volumes. st libraries in the state were destroyed reat Chicago fire in 1871. The chief reported by the United States bureau tion in 1872 were that of the North- university at Evanston, containing olumes; the state library in Spring- 000; that of the Baptist union theo- eminary in Chicago, 15,000; the iberger library (university of Chicago), hat of the Illinois industrial university pain, 10,000; Illinois college, Jack- 8,000; McKendree college, Lebanon, ugustana college, Paxton, 7,000; and cantile library, Peoria, 7,000. The library in Springfield contains 3,000 and the Chicago public library (1874) .000. The total number of newspa- periodicals reported by the census of : 505, with an aggregate circulation ,541, and issuing 113,140,492 copies There were 89 daily, circulation 10 tri-weekly, 40,570; 4 semi-weekly, 64 weekly, 890,913; 11 semi-month- 0; 72 monthly, 490,808; 2 bi-month-

ly, 11,000; and 3 quarterly, 12,000. In the same year the state contained 4,298 religious organizations, having 3,459 edifices with 1,201,-403 sittings, and property valued at \$22,664,-288. The leading denominations were:

DENOMINATIONS.	Organi- zations.	Edi- fices.	Sittings.	Property.
Baptist.....	722	571	181,454	\$2,601,612
Catholic Apostolic.....	1	1	350	2,000
Christian.....	850	251	85,175	621,450
Congregational.....	212	188	66,187	1,867,500
Episcopal (Protestant).....	105	87	30,395	1,426,300
Evangelical Association.....	5	55	20,176	322,650
Friends.....	5	4	1,000	18,400
Jewish.....	10	9	8,950	271,500
Lutheran.....	230	207	74,301	1,043,478
Methodist.....	1,426	1,124	357,078	5,205,620
Moravian (United Breth- ren).....	4	4	1,600	11,000
Mormon.....	5	2	688	8,500
New Jerusalem (Sweden- borgian).....	18	7	1,855	160,500
Presbyterian, regular.....	439	386	140,147	3,196,391
Presbyterian, other.....	156	187	44,702	441,234
Reformed Church in Amer- ica (late Dutch Reform'd).....	14	14	4,880	150,200
Reformed Church in the United States (late Ger- man Reformed).....	22	20	7,170	93,600
Roman Catholic.....	290	249	126,900	4,010,650
Second Advent.....	5	5	1,300	7,100
Spiritualist.....	7	1	500	700
Unitarian.....	28	17	5,960	492,900
United Brethren in Christ.....	125	53	17,995	126,500
Universalist.....	52	44	15,225	543,300
Unknown (union).....	10	7	1,770	8,600

—Illinois takes its name from its principal river. According to Albert Gallatin, the term is derived from the Delaware word *leno*, *leni*, or *illini*, meaning real or superior men, the termination being of French origin. The first settlements were made by the French, and were the consequence of the enterprises of Marquette (1673) and La Salle. The latter traveller set out from Canada in 1679, and passing across the lakes descended the Illinois river. After examining the country, with which he was highly pleased, he returned to Canada, leaving the chevalier de Tonti in command of a small fort he had built at the foot of Lake Peoria and named Crève-cœur. In 1682 he returned to Illinois with a colony of Canadians, and founded Kaskaskia, Cahokia, and other towns. At the beginning of the 18th century the settlements in Illinois are represented to have been in a flourishing condition, and the country was described by French writers as a new paradise. As the colonies of France and England extended, disputes arose respecting boundaries, and these ultimately led to the war which virtually ended with the capture of Quebec, and which in 1763 terminated the French dominion over any part of the country E. of the Mississippi. During the continuance of Illinois as a British dependency nothing of importance appears to have occurred, nor were the French settlements molested. After the peace of 1763, which closed the American revolution, the Illinois country was ceded to the United States; and by the ordinance of July 13, 1787, the whole of the public domain N. of the Ohio river was erected into the Northwest territory under a single government. In 1800 the territory contained a population of 50,240, and in the same year Ohio was erected into a separate territory. A further severance was made in 1805, when the territory of Michigan was formed, and again in 1809 Indiana was divided off. The Illinois territory at this time included what are now the states of Illinois and Wisconsin and a part of Minnesota, and by the census of 1810 was found to contain 12,282 inhabitants. Hitherto the settlement of these territories had been greatly impeded by Indian hostilities, and indeed the early history of Illinois is one continued narrative of contests with the savages. Among the prominent events of this period is the massacre near Fort Chicago, Aug. 15, 1812. When hostilities finally ceased, population began to flow in from the eastern states. On Dec. 3, 1818, Illinois with its present limits was admitted as a state into the Union. The census of 1820 returned 55,211 inhabitants. During the succeeding decade immigration increased rapidly, and in 1830 the population was ascertained to be 157,445, or an increase of 185.2 per cent. over that of 1820. In 1831 the Sac and other Indian tribes began to be troublesome, and in 1832 the Black Hawk war broke out. The alarm caused by these hostilities was great, but the result was ultimately beneficial

to the state; not only was a permanent settlement established, but the officers of the army on their return reported so favorably of the character and resources of the country, that government attention was directed to the state. Shortly thereafter congress granted an appropriation for the improvement of Chicago harbor, and at this time the Illinois and Michigan canal was projected, and the state bank brought into successful operation. On July 4, 1836, the commencement of the construction of the canal was effected, and the succeeding year brought the greatest financial revulsion in our history, and in this respect was more seriously involved than 1837. Every interest was prostrated, and all projects of internal improvement abandoned. The next congress of the state, however, had been re-elected by the census of 1840 the population numbered 476,183, being an increase of 203.4 per cent. over that of 1830. In this year the Mormons established themselves at Nauvoo, and from the first disliked by their neighbors, mutual hatred ended in open hostilities, at length the brothers Joseph and Hyrum (the first named the founder of Mormonism) were arrested, and while confined in Carthage jail were murdered by a mob, June 27, 1844. This was soon followed by a general exodus of the Mormons, who now numbered about 10,000, toward Utah. In 1847 a new constitution was framed, which went into operation the following year. The census of 1850 returned a population of 851,470, an increase of 168.5 per cent. in the decade. This was a lower rate of increase than had hitherto been maintained, but was still a rapid growth, the mean while emigration had been directed to Iowa and Wisconsin. But a new era of prosperity was now opening for Illinois, the same year congress made a large grant of land in aid of the construction of the Central railroad, which was completed in 1854. The country along both sides of its route had been rapidly settled, cities and towns had risen with remarkable rapidity, and the prosperity of the state through the influence of the railroad and other great works simultaneously effected has become so general that the last government land in Illinois has been disposed of. In December, 1869, a constitutional convention assembled, and in May following agreed upon the present constitution, which was ratified July 2. In this instrument the term of "minority representation" in the election of members of the house of representatives was incorporated, it being provided that in all elections of representatives aforesaid every qualified voter may cast as many votes for one candidate as there are representatives to be elected, or may distribute the same, or parts thereof, among the candidates, as he may see fit; and the candidates highest in votes shall be declared elected."—A "History of Illinois, 1673-1873," by Alexander Davidson and Bernard Stuvé, was published in 1874, and contains authority for some of the statements here

**ILLINOIS**, a river of the United States, and the largest in the state to which it gives its name. It is formed in Grundy co., in the N. E. part of the state, about 45 m. S. W. of Lake Michigan, by the union of Kankakee and Des Plaines rivers, the former of which rises in the N. part of Indiana and the latter in the S. E. part of Wisconsin. The Kankakee receives the Iroquois, and from that point to its junction with the Des Plaines is sometimes known as the Iroquois. The Illinois flows nearly W. to Hennepin, in Putnam co., and thence S. W. and finally S. until it unites with the Mississippi between Calhoun and Jersey counties, 20 m. above the mouth of the Missouri. It is about 500 m. long, and is navigable at high water for 245 m. It is deep and broad, in several places expanding into basins which might almost be called lakes. Peoria, the most important city on its banks, is built on the shore of one of these basins. Its principal affluents are the Fox, Spoon, Crooked creek, the Mackinaw, Sangamon, and Vermilion. Above the mouth of the Vermilion, in La Salle co., it is obstructed by rapids, and a canal has been built from this point to Chicago, a distance of 96 m. Uninterrupted water communication is thus secured between the lakes and the Mississippi. The Illinois was ascended by Marquette in 1673, and explored in 1679-'80 by La Salle and Hennepin, who entered it by the Kankakee, which they reached from Lake Michigan by means of the St. Joseph river and a short portage, and sailed in canoes, La Salle as far as the present site of Peoria, and Hennepin to the Mississippi. In 1682 La Salle navigated the whole course of the river.

**ILLUMINATI** (Lat., the enlightened), a name supposed to have been given to the newly baptized in the early Christian church, because a lighted taper was put into their hands as a symbol of enlightenment; subsequently a name assumed at different periods by sects of mystics or enthusiasts who claimed a greater degree of illumination or perfection than other men. The most famous of these sects were the Alombrados or Alumbados (the enlightened) in Spain at the end of the 16th century; the Guérinets, named after their founder Pierre Guérin, in France in the 17th century; and an association of mystics in Belgium in the 18th. The most celebrated society of the name was that founded in 1776 by Adam Weishaupt, a German professor of canon law at Ingolstadt, and a man of great originality and depth of thought, with the ostensible object of perfecting human nature, of binding in one brotherhood men of all countries, ranks, and religions, and of surrounding the persons of princes with trustworthy advisers. Apostles, styled areopagites, were sent to various parts of Europe to make converts, and before the existence of the society became generally known branches had been established in various parts of Germany, in Holland, and in Milan. Young men from 18 to 30 years of age, and Lutherans rather than

Roman Catholics, were preferred as members. The illuminati gained much influence by the accession to their ranks of Knigge the author, and by the sympathy of many freemasons. At the height of its prosperity the society had 2,000 members. The order was divided into three classes and several subdivisions. The first, or preparatory class, was divided into novices, minervals, and *illuminati minores*. The second class was that of the freemasons, who were ranked as apprentices, assistants, and masters; it included two higher grades, that of the *illuminatus major*, or of the Scottish novice, and that of the *illuminatus dirigens*, also called the Scottish knight. The class of mysteries was divided into major and minor mysteries, of which the latter included the two grades of priests and regents. The major mysteries comprised the grades of *magus* and *rex*. The mysteries related to religion, which was transformed into naturalism and free thought, and to politics, which inclined to socialism and republicanism. The order corresponded in cipher, and used a peculiar phraseology; January was called Dimeh; February, Beumeh; Germany, the Orient; Bavaria, Achaya; and Munich, Athens. Every illuminatus received a new name; Weishaupt was Spartacus, and Knigge was Philo. But Knigge and Weishaupt could not agree, and this, as well as the opposition of the Roman Catholic clergy, proved fatal. The society was prohibited by the Bavarian government in 1784, and its papers were seized and published under the title *Einige Originalschriften des Illuminatenordens, auf höchsten Befehl gedruckt* (Munich, 1787). Works on the subject were published by Weishaupt, Knigge, Nicolai, and Voss (1786-'99).

**ILLYRIA** (anc. *Illyricum* and *Illyris*; Ger. *Illyrien*), a name anciently applied to all the countries on the east coast of the Adriatic, the adjacent islands, and western Macedonia, inhabited by the Illyrians, a tribe believed to have had a common origin with the Thracians. Philip of Macedon subdued the Illyrians east of the river Drilo (now Drin), 359 B. C. Illyricum was subsequently divided into Illyris Græca and Illyris Barbara. The latter soon became a Roman province, designated as Illyris Romana, and included a part of the modern Croatia, the whole of Dalmatia, almost the whole of Bosnia, and a part of Albania. The principal tribes after whom the districts were called were the Japydes, Liburni, and Dalmatians. The Liburni were the first subdued by the Romans; and after the conquest of the Dalmatians, in the reign of Augustus, the entire country became a Roman province. After that time the Illyrians, and particularly the Dalmatians, formed an important part of the Roman legions, and were esteemed the most warlike of the empire. Illyris Græca, or Illyria proper, embraced the greater part of the modern Albania. The territory of this division consisted principally of mountain pastures, with some fertile valleys. The various tribes of the Grecian Illyrians

were generally poor, rapacious, and fierce; in earlier times the tribe of the Autariatæ held the first rank as warriors. They had the customs of tattooing and of offering human sacrifices, and were always ready to sell their military services to the highest bidder, like the modern Albanian Shkipetars, in whom probably their blood yet flows. The Illyrians supplied the Greeks with cattle and slaves, often in exchange for salt. Grecian exiles found their way into Illyria, and Grecian myths became localized there. After the death of Alexander the Great most of the tribes recovered their independence, but their piracies gave umbrage to the Romans. The Roman ambassadors who protested against their depredations were murdered by the Illyrian queen Teuta. The first Illyrian war was commenced in 230 B. C., and the queen was obliged in 229 to make peace by the surrender of part of her dominions. The second war, commenced by Demetrius of Pharos, the guardian of the Illyrian prince Pineus, was successfully terminated by the consul L. Æmilius Paulus in 219. Pleuratus, the successor of Pineus, cultivated the friendship of the Romans, but his son Gentius formed an alliance with Perseus, king of Macedon. He was conquered in the same year as Perseus, and Illyria as well as Macedon became subject to Rome (168). In the new organization under Constantine, Illyricum was one of the great divisions of the empire, and was divided into Occidentale, including Illyricum proper, Pannonia, and Noricum, and Orientale, comprising Dacia, Mœsia, Macedonia, and Thrace. On the fall of the western empire (A. D. 476) it remained a part of the eastern. About two centuries later the Slavic settlers from northern Europe separated themselves from the Byzantine government, and laid the foundation of the governments of Croatia and Dalmatia. At the end of the 11th century some portions of the Illyrian territory were taken by Venice and Hungary. About a century later the kingdom of Rascia was created, out of which Servia and Bosnia were subsequently formed. Dalmatia passed successively through the hands of the Venetians, Hungarians, and Turks. Venice retained only a small portion of Dalmatia, while Hungary kept Slavonia and part of Croatia. Austria obtained Dalmatia and adjacent islands by the treaty of Campo Formio in 1797.—The name Illyria, which had gradually disappeared, was revived in 1809 by the organization of the Illyrian provinces by Napoleon, comprising the territories of Carniola, Carinthia, Istria, part of Croatia, Dalmatia, Ragusa, and a military district, with a population of 1,275,000. After the fall of Napoleon they were reunited to the Austrian government, which in 1816 raised Illyria to the nominal dignity of a kingdom. It embraced the duchies of Carniola, Carinthia, Friuli, and Istria, the Hungarian Coastland, part of Croatia, and the islands in the gulf of Quarnero, having an area of about 11,000 sq. m. The Coastland and

Croatia were separated from it in 1822, and reunited with Hungary, where they have formed since 1849 part of Croatia and Slavonia. The kingdom was dissolved in the same year into the crownlands of Carinthia, Carniola, and the Littorale. The Illyrian language is one of the southern branches of the Slavic family of languages. (See SERBIAN LANGUAGE AND LITERATURE.)

**ILOPANGO**, a lake of Central America, in the republic and 6 m. S. E. of the city of San Salvador. It is about 14 m. long by 6 broad, and is clearly of volcanic origin. On all sides it is surrounded by high, abrupt hills, composed of scoriae and volcanic stones. It receives no tributary streams, although it has a small outlet, flowing through a dark narrow ravine into the Rio Jiboa, near the base of the volcano of San Vicente. The surface of the water is not less than 1,200 ft. below the level of the surrounding country. When the surface is ruffled by a breeze, it takes a brilliant green color, and exhales a disagreeable sulphurous odor.

**IMAGE WORSHIP.** See ICONOCLASTA.

**IMBERT, Barthélemy**, a French poet, born in Nîmes in 1747, died in Paris, Aug. 23, 1790. His poem entitled *Jugement de Paris* (1772) passed through many editions, and he also published fables, plays, and novels, the best of the latter being *Les égarements de l'amour* (1776). His *Œuvres poétiques* appeared in 3 vols., 1777; his *Œuvres diverses* in 1782; and his *Œuvres choisies en vers* in 4 vols., 1797.

**IMMACULATE CONCEPTION**, a doctrine of the Roman Catholic church which teaches that the Virgin Mary was in her conception exempt from all stain of original sin. Though this belief had been held in the eastern and western churches from a remote antiquity, it was not defined as an article of faith until Dec. 8, 1854. It is formally stated in the constitution of Pius IX., *Ineffabilis Deus*, in the following words: "We define the doctrine which holds the most blessed Virgin Mary in the first instant of her conception to have been preserved free from all stain of original sin, by the singular grace and privilege of Almighty God and through the merits of Jesus Christ the Saviour of the human race, to be a doctrine revealed by God, and therefore to be firmly and constantly held by all the faithful." The decree itself is further explained by the annexed passage from the constitution *Sollicitudo omnium Ecclesiarum* of Alexander VII.: "It is an ancient belief of Christ's faithful with regard to his virgin mother, that her soul in the first instant of its creation and union with the body was, by a special grace and privilege of God, . . . preserved free from the stain of original sin; and it is in this belief that they honor and celebrate the feast of her conception." The defined doctrine therefore refers not to the active but to the passive conception, that is, to the soul and body of the Virgin in the first instant of their creation and union; at that instant, in view of the merits of the Son,

r, in body and soul, was exempt from common law of fallen humanity. Every within the Roman Catholic the immaculate conception was more on the terms of the doctrine and the time of the immaculateness than to its freedom from the effects of original sin, which for the most part was not the establishment of the feast of the Immaculate Conception, which witnesses to the fact; as the church celebrates a festival in honor of a Virgin free from original sin. This festival was celebrated annually on the 8th day of the month of December in the East, and it is almost universally observed in the West; it was probably during the 13th and 14th centuries. In the East there have been no discussion in regard to the date of this festival. In the West it is observed by the devotion of participants before the sanction of the apostolic See made it universal. St. Bernard observed the canons of Lyons because they had established this feast without waiting for the sanction of the supreme pontiff. The agitation occasioned led to long disputes among theologians, and especially among the Franciscans and Dominicans; the latter have been long the pronounced opponents of the doctrine. The disagreement was, however, more a matter of fact rather than of doctrine. Thus St. Bernard, who is most eminent among medieval theologians, expressly declares in his treatise on the Virgin Mary from original sin: "*Talis fuit puritas B. Virginis, quas originali et actuali immunis fuit.*" (*Liber. Sent., Dist. 44, § 3.*) The words of St. Bernard also are against the doctrine of the immaculate conception "actively" considered, a part of the Roman Catholic dogma. The discussion of the subject in the schools led to declarations in its favor. Duns Scotus, in 1307, in a disputation before the university of Paris, maintained the doctrine of the Virgin's immaculateness in its highest sense; the whole Franciscan order then zealously defended it. The university of Paris in 1387 condemned certain propositions of St. Thomas Montesano, a Dominican, in which the doctrine was denied, and in 1497 passed a decree that no one should be admitted to any office or honor who did not bind himself by oath to defend it. In 1439 the council of Florence, during its schismatic period, declared in favor of the immaculate conception of the Virgin to be conformable to the doctrine of the church, to the Catholic tradition, to the Holy Scriptures, and to the Holy Scriptures, held by all Catholics." The council in its decree concerning original sin, declared that it did not intend to immaculate the Virgin, and ordered the feast of the Immaculate Conception to be observed. During the controversy the holy see interfered only occasionally, but these interferences were successful toward the formal definition of the doctrine. Sixtus IV., in the apostolic let-

ter entitled *Graves nimis*, published in 1480, imposes excommunication upon any one who accuses of heresy either the advocates or the opponents of the immaculate conception, while at the same time he condemns all who affirm as the truth the opinion that the Blessed Virgin was conceived in sin. He also granted indulgence to those who should assist at mass or office on the feast of her conception. Pius V., in the bull 114, *Super Speculam*, in 1570, prohibited the public discussion of the question, renewing also the decree of his predecessor. Paul V. in 1616 forbade any one to affirm by any public act whatever that the Virgin was conceived in sin, while he also prohibited the open condemnation of this opinion. Gregory XV. in 1622 prohibited either the public or private denial of the immaculate conception, allowing no discussion whatever on the subject except to the Dominicans, to whom an especial privilege was reserved. The office and mass of the conception were however made binding upon them as upon all Catholics. In 1661 Alexander VII., in the constitution *Sollicitudo omnium Ecclesiarum*, declares the opinion that the Virgin was conceived without original sin to be almost universal in the church; therefore he renews the decrees of his predecessors, commanding that they be observed in favor of the feast and cultus of the conception, and moreover deprives of the faculty of teaching or preaching any one who should call into doubt or misinterpret the favor shown to this opinion by asserting anything against it, or even by bringing forward arguments against it. After that time the congregation of rites repeatedly interposed its mandate in favor of the doctrine. The word immaculate was added in the office and mass of the conception, and its use made binding upon all priests, even those of the Dominican order. Pius IX. in the early part of his reign sent letters to all patriarchs and bishops, requesting their opinion upon the propriety of defining the doctrine. Answers were given by 620 bishops and archbishops, of whom only four were opposed to the definition on dogmatic grounds, and even these gave testimony that their clergy and people were united in the belief of the doctrine. When replies were received from nearly the whole Catholic episcopate, as many of the bishops as possible were invited to be present in Rome to assist at the solemn definition of the doctrine. This ceremony took place with great pomp in the basilica of St. Peter, in the presence of more than 300 archbishops, bishops, and prelates, on the feast of the immaculate conception, Dec. 8, 1854. In September, 1857, a monument was inaugurated by the pope at Rome in commemoration of the decree. On this occasion he also established the "Archconfraternity of the Immaculate Conception," which now has branches in all Catholic countries.—In 1618 a military order of the Conception was established in Italy by Duke Ferdinand I. of



Mantua, for promoting peace among Christian princes; this order was confirmed in 1625 by Urban VIII., who gave to the members the rule of the third order of St. Francis. It was composed of noblemen, and rapidly acquired great importance; but political events caused its dissolution. In Portugal John VI. founded, Feb. 6, 1818, the military order of "Our Lady of the Conception of Villaviciosa."

**IMMERMANN, Karl Lorecht**, a German author, born in Magdeburg, April 24, 1796, died in Düsseldorf, Aug. 25, 1840. He qualified himself at Jena for the Prussian judiciary service, in which he found employment, and became at the same time known as a dramatist and poet. He received a judicial appointment at Düsseldorf in 1827, and resumed his professional duties after having incurred heavy losses in a disinterested attempt to manage the Düsseldorf theatre in conformity with high conceptions of art. He published admirable tragedies, such as *Alexis* and *Merlin*, and fine comedies, but they were not adapted for the stage. His other productions comprise an entertaining fairy tale, *Tulifantchen*, several volumes of poetry and miscellaneous writings, and a novel in imitation of Goethe's *Wilhelm Meister* entitled *Die Epigonen* (2 vols., 1836); but his great fame chiefly rests upon his *Münchhausen* (4 vols., 1838-'9), which passed through several editions. His complete works were published in 14 volumes (Düsseldorf, 1834-'43). See his *Memorabilien* (Hamburg, 1840, unfinished); Freiligrath's *Karl Immermann, Blätter der Erinnerung an ihn* (Stuttgart, 1842); and his biography by Putlitz (2 vols., Berlin, 1870).

**IMMORTELLES**, a name given by the French to those flowers which from their papery nature



*Helichrysum orientale*.

do not wither on drying, known in this country as "everlasting flowers," and are furnished by plants in widely different families. The immortelle so largely used by the French, made

up into wreaths, crosses, and other designs, is *helichrysum orientale*, a perennial composite from the island of Crete (and formerly called *gnaphalium*), which, upon stems about a foot high, bears dense clusters of bright yellow globular flower heads, about the size of a large pea; as far north as Paris this is a tender plant, but in the south of France large quantities are raised to supply the demand. The usual French immortelle wreath consists of these in their natural color, made into a heavy circle with a motto worked in of the same flowers dyed black. There are several annual species and varieties of *helichrysum*, with much larger flowers and of various colors, that are common in our gardens, where they are cultivated for making winter bouquets. These and all other everlasting flowers should be gathered before they have fully expanded, tied in small bunches, and hung up to dry. Other plants of the *composita* used for the same purpose are



*Ammobium alatum*.

*acroclinium roseum*, with a white variety; *ammobium alatum*, small white; *helipterum Sanfordii* and *H. corymbosum*, yellow and white; *rhodanthe Manglesii* and its varieties, from white to dark purple, the most beautiful and delicate of all, whether fresh or dry; *Waitzia aurea* and *seranthemum annuum*, with white, blue, and purple varieties. Besides these, the globe amaranths (*gompheana*), several species of *statice*, and *gypsophila* are cultivated for drying. Quite as pretty as any of these exotics is our pearly everlasting, *antennaria margaritacea*, which is common all over the northern states on dry knolls and in woods; this if gathered sufficiently early makes a fine immortelle, and being white, may be colored according to fancy. Considerable quantities of immortelles are imported by American seedsmen, both in bunches and made up in bouquets, baskets, and designs. One establishment in Prussia has 100 acres devoted entirely to their cultivation.

are sent out in their natural colors, or frequently dyed; most of them have to be washed before dyeing, which is done by ur fumes, chlorine, or acids, according to



Rhodanthe Manglieti.

ind, and afterward colored, usually with the dyes. Of late years there have appeared among the immortelles larkspurs, roses, and other flowers not ordinarily so classed; these are preserved by exposing them thoroughly to sulphur fumes and afterward drying them, when most flowers regain the color that they have temporarily removed.

**IMOLA**, a town of Italy, in the province and diocese of S. E. of the city of Bologna, on a small hill of the Santerno, on the road from Bologna to Ferrara; pop. in 1872, 28,898. It is the seat of a bishop, and has an ancient castle, a cathedral, a gymnasium, a technical school, noted factories of tartar, and an active trade in flax, hemp, rice, and corn. Imola is believed to be the ancient Forum Cornelia, which was founded by Sulla. Pius VII. and Pius IX. were bishops of Imola before becoming popes.

**M.A. IANNEZZIO DA**, a Bolognese painter, whose real name was Francucci, born at Imola in the latter part of the 15th century, died in 1550. He was a pupil of Francia, and worked chiefly in Bologna, where his painting of the archangel Michael subduing Satan is preserved. In the latter part of his life he imitated Raphael, and some of his works have been mistaken for his.

**IMPEACHMENT** (Fr. *empêchement*, hindrance, obstruction), the accusation and prosecution, by a legislative body, of a person for treason or other high crimes. By the law of England, any member of the house of commons may impeach any other member of the house, or any officer of parliament, or indeed any other person of the realm. Upon such impeachment being made, the house of commons, if they see fit, submit articles of impeachment before the

house of lords, and appoint managers to sustain the charge and conduct the trial; and upon the trial, the same rules of evidence, in general, are in force as in trials in the ordinary courts of justice. This is a very solemn procedure, it being a prosecution before the supreme court of criminal jurisdiction for the whole realm, by the grand inquest thereof. It has been most frequently used against the king's ministers; and in order to take the trial from the power of the king, it is provided by law that the impeachment is not abated either by the prorogation or dissolution of parliament. The latest and best known cases are those of Warren Hastings (1788) and of Lord Melville (1806). In the United States, impeachment is a written charge and accusation by the house of representatives of the United States, made to the senate of the United States, against an officer thereof; or, in a state, it is such an accusation of an officer, by the representatives of the state, before the senate. The proceedings, rules, and practice in cases of impeachment in this country are borrowed from the common law of England, excepting so far as they are affected by the constitution or statutes of the United States, or of the several states. The constitution of the United States declares (art. i., sec. 2) that the house of representatives shall have the sole power of impeachment, and (art. i., sec. 3) that the senate shall have the sole power to try all impeachments. By art. ii., sec. 4, the persons made liable to impeachment are the president, the vice president, and all civil officers of the United States. The offences for which a person may be impeached are (art. ii., sec. 4) "treason, bribery, and other high crimes and misdemeanors." The constitution defines treason, but what acts are impeachable offences under the other words employed must be determined by the judgment of the two houses. They would probably be guided, but not governed, by the rules of the common law and the practice of parliament.—The method of procedure is substantially as follows: A resolution is offered by some member of the house, charging the party to be impeached with his supposed offence, and either demanding at once his impeachment, or, what is more common, providing for a committee of inquiry. If the resolution is passed, and if a committee of inquiry reports in favor of an impeachment, and their report is adopted, a committee (the same or another) is instructed to impeach the accused before the senate, and demand that that body make due provision for the trial, and inform the senate that articles of impeachment will be prepared by the house and exhibited before the senate. The same or another committee is intrusted to prepare articles of impeachment, which, being approved by the house, are transmitted to the senate by a committee appointed to conduct the trial on the part of the house, who are usually styled the managers of the impeachment. Due process

summoning the accused then issues from the senate, and is served by its sergeant-at-arms; and on the day therein appointed, the senate resolves itself into a court of impeachment, all the senators being sworn to do justice according to the constitution and the laws. The person thus impeached is then called upon to appear and answer. If he makes default, the senate proceeds *ex parte*. If he appears and denies the charges, and puts himself on trial (and he may appear by attorney), an issue is formed, and a time is appointed for the trial, which thereafter proceeds according to law and usage, and much in the same way as in common judicial trials. If any questions arise among the senators, who now act as judges, they are considered with closed doors, and are decided by yeas and nays, and only the decision is made public. Art. i., sec. 2, of the constitution of the United States, provides that no person shall be convicted without the concurrence of two thirds of the members. The most noted cases of impeachment in the United States are those of Judge Samuel Chase, of the federal supreme court (1804), and President Andrew Johnson (1868).

**IMPHEE.** See **SORGRM.**

**INACHUS**, a mythical king, represented as the first ruler and priest of Argos, which, as well as the river Inachus, was often called after him. When Neptune and Juno contended for the possession of that country, he decided in favor of the latter, and thus incurred the anger of Neptune, who caused a dearth of water in his dominions. Several attempts have been made, even by the ancients, to explain the stories about Inachus; and it is considered probable that he was the leader of an Egyptian or Libyan colony which came across the sea and united with the Pelasgians.

**INCAS.** See **PERT**, and **QUEICUA.**

**INCENSE.** See **FRANKINCENSE.**

**INCEST**, carnal commerce between a man and woman who are related to each other in any of the degrees within which marriage is prohibited by law. It rests with positive law to determine these degrees; for although marriages between those nearly related are clearly opposed to the law of nature, yet it is difficult to fix the point at which they cease to be so. With rare exceptions all civilized communities have agreed in regarding marriage between brother and sister and between those lineally related as unnatural and offensive; but beyond this point the invalidity must depend upon positive statutes. The fact that one of the parties is illegitimate is immaterial, as it is the nearness in blood that is regarded, and the repulsive nature of the relation is not diminished by the circumstance that the relationship comes through unlawful intercourse. Incest is a criminal offence in all civilized countries, and in England and the United States is punished as a felony.

**INCHBALD**, **Elizabeth**, an English dramatist, born at Standingfield, near Bury St. Edmund's,

Suffolk, Oct. 15, 1753, died in Kensington, Aug. 1, 1821. She was the daughter of a farmer named Simpson, who died when she was in her 18th year. She then sought an engagement at the London theatres, but without success. Recounting her troubles to Mr. Inchbald, a comedian of Drury Lane, much her senior, he married her, instructed her in the art, and performed with her for several seasons at London, Edinburgh, Glasgow, and elsewhere. He died in 1779, and she played successfully at Covent Garden from 1780 to 1789, when she retired from the boards and devoted herself to literature. In this new pursuit she was equally successful. She wrote 19 plays, and edited the "British Theatre," a collection of plays (47 vols., London, 1808-'15). A few of her own pieces, as "The Wedding Day" and "Wives as They Are," still hold their place on the English stage. Her novels, "A Simple Story" and "Nature and Art," once enjoyed even a higher popularity than her dramatic writings, and are still admired. She wrote an autobiography, which she caused to be destroyed. The "Memoirs of Mrs. Inchbald," by Boaden (3 vols. 8vo, London, 1833), was compiled from her journal, covering a period of 50 years.

**INCLEDON**, **Benjamin Charles**, an English singer, born at St. Keverne, Cornwall, in 1764, died in Worcester, Feb. 11, 1826. He acquired his earliest musical education in the choir of Exeter cathedral, and made his debut in London in 1790 in "The Poor Gentleman," with great success, and for 25 years remained unrivalled as a ballad singer. His voice was a fine tenor, and his favorite part upon the stage was Macheath. In 1817 he made a musical tour in the United States, but his voice was beginning to yield to age and irregular living, and the enterprise was not very successful.

**INCUNABULA** (Lat., cradle), in bibliography, books printed prior to about 1500, of which there are estimated to be about 15,000. The fullest account of them is found in Ludwig Hain's *Repertorium Bibliographicum, in quo Libri omnes ab Arte Typographica inventi usque ad Annum MD Typis expressi Ordine Alphabetico recensentur* (2 vols., Stuttgart, 1826-'38). For French incunabula see G. Brunet's *La France littéraire au XV<sup>e</sup> siècle* (Paris, 1865).

**INDEPENDENCE**, a N. county of Arkansas, bounded E. by Black river, and traversed from N. W. to S. E. by White river; area, 1,050 sq. m.; pop. in 1870, 14,566, of whom 906 were colored. It has a very uneven surface, well wooded with pine and other timber. The soil is fertile. Black marble is found here. The chief productions in 1870 were 38,653 bushels of wheat, 508,005 of Indian corn, 30,830 of oats, 17,574 of Irish potatoes, 21,483 of sweet potatoes, 21,336 lbs. of tobacco, 139,225 of butter, and 5,613 bales of cotton. There were 3,370 horses, 4,059 milch cows, 1,496 working oxen, 5,677 other cattle, 5,387 sheep, 22,787 swine, and 8 flour mills. Capital, Batesville.

**INDEPENDENCE.** I. A town of Washington co., 80 m. E. of Austin, 18 m. from on the Houston and Texas Central and 12 m. from Brenham on the W. of that line; pop. about 1,000. It is situated in the midst of diversified and contains several public schools, st. Episcopal, and Methodist churches. seat of Baylor university, chartered and Baylor female college, under the of the Baptists. The university had collegiate and a law department (at suspended); in 1866 a theological department was added. In 1873-'4 it had 5 professors, 80 students (11 theological) library of 2,700 volumes. II. A city capital of Buchanan co., Iowa, on the icon river, and at the intersection of division of the Illinois Central railroad, the Milwaukee division of the Burlington Rapida, and Minnesota line, 107 of Des Moines; pop. in 1870, 2,945. is a national bank, 10 public schools, two high schools, two weekly newspapers and eight churches. It is the seat of a state insane hospital, recently established which in November, 1878, had 118 The building, when completed, will cost late 500. III. A city and the capital of Jackson co., Missouri, on the Missouri railroad, 10 m. from Kansas City, 4 the Missouri river, and 130 m. W. of Jefferson City; pop. in 1870, 3,184. is a national bank, three hotels, three schools, including a high school, two and two weekly newspapers. It was founded in 1827, and formerly derived great benefit from its position as an entrepot between New Mexico and Utah and the east, and a place of outfit for emigrant trains to Oregon and California. The Mormons settled there in 1837, but were expelled, and a refuge in Illinois and afterward in Indiana. Remains of one branch of the church are to be seen on the grounds designed by John as the site of the grand temple, and a new edifice at an early day. assembling here quite rapidly.

**INDEPENDENTS,** a Protestant sect which arose in the 16th century. The Puritanism which began to appear within the Anglican church so early as the reign of Henry VIII. gave rise in Mary's reign to secret dissenting congregations, essentially independent in church organization and doctrine. Although in one or two instances earlier traces of separate congregations are to be seen, the first open movement toward local independence distinct from the established church was the leadership of Robert Brown, 1606. At first they were called Brownists, their discipline having been modified by Robinson and Henry Jacob, who had been ejected with him, they took the name Independents, and rapidly spread over England. Holland a body of them carried

their tenets to America in 1620. They flourished in England during the commonwealth, Cromwell himself being in their communion; but on the restoration the act of uniformity, passed in 1662, excluded 1,900 of their ministers from office. The act of toleration, 1689, freed dissenters from the pains and penalties imposed on the exercise of their worship, and in 1691 a temporary union was effected between the English Presbyterians and Independents. It was not, however, till the repeal of the test and corporation acts in 1828 that the English Independents, with other dissenters, were freed from all civil disabilities. Robinson, under whom they were called Independents, is generally esteemed the father of modern Congregationalism. In their subsequent history the Independents in England and the Congregationalists in America have held practically the same ecclesiastical views. Thus the Independent churches of England formed a Congregational union in 1831, and an article of their constitution formally recognizes the fellowship of the churches. Less use of councils is made, however, than by the Congregationalists in America. The name Independent is sometimes used in ecclesiastical discussion to designate those Congregationalists who incline toward the principles of independency.—In Scotland there is a body called New Independents. It originated in a separation from the church of Scotland about the end of the last century, under the lead of Robert and James Haldane, from whom its members were called Haldanites. Large places of public worship were erected at Robert Haldane's expense in several towns, and academies for the education of preachers were established in Edinburgh, Dundee, and Glasgow. The New Independents increased rapidly, and in the beginning of the present century had 86 churches; they have at present about 120. They utterly reject any connection of church and state, and make little distinction between the laity and clergy, considering it not irregular that a layman, in the absence of a clergyman, should administer the Lord's supper, which they celebrate weekly. In other respects they differ little in doctrine or worship from other Independents. (See CONGREGATIONALISM.)

**INDEX LIBRORUM,** a catalogue of books censured by the supreme authority in the Roman Catholic church as prejudicial to faith and good morals. This catalogue is twofold: that of books absolutely forbidden to be read, *Index Librorum Prohibitorum*; and that of books forbidden only until they are expurgated or corrected by their author, *Index Librorum Expurgandorum*. It is published by the "Congregation of the Index," composed of cardinals designated by the pope, with a secretary, who is by right a Dominican monk, and a body of examining theologians, usually belonging to the other religious orders, and called the *consultum*. To the *consultum* are submitted the suspected books, and they report back to the cardinals,

who hold their deliberations either in presence of the pope, or in the house of the senior cardinal of their number. All books that treat *ex professo* of faith or morals, of ecclesiastical discipline, or of civil society, fall within their jurisdiction; and the judgment of the congregation either suppresses the book altogether, or commands it to be corrected, or permits it to be read under certain conditions, or by a certain class of persons only. The first official index or catalogue was prepared by the inquisition at Rome, and published in 1557 by order of Pope Paul IV. This, enlarged and reduced to a regular form by a committee of the council of Trent, was published anew in 1564, with the sanction of Pius IV., and enlarged by Clement VIII. in 1595. The latest official edition is that of 1819. The index is continually enlarged by the supplementary lists of each year. The congregation of the index originated with the council of Trent under Pius IV., and its official establishment is due to Pius V.

**INDIA**, or **Hindustan** (*Hindu*, and *stan* or *sthan*, settled habitation), a country of Asia, consisting in the widest sense of the great southern peninsula of that continent, and the adjacent territories S. of the Himalaya mountains and W. of Burmah and Siam, and forming the richest and most populous foreign dependency of Great Britain. It is situated between lat. 8° and 35° N. (or 36° 30' if Cashmere is included), and lon. 66° 30' and 99° E., and is bounded N. by Chinese Turkistan and Thibet, from which it is separated by the Himalaya range, E. by Burmah and Siam, and W. by Beloochistan and Afghanistan. The entire coast of the country E. of Cape Comorin, the southern extremity of the peninsula, is washed by the bay of Bengal, while the S. W. coast extends along the Indian ocean and the Arabian sea. The extent of coast line is upward of 4,000 m. in all, of which more than half is on the bay of Bengal. The extreme length of India from N. to S. is about 1,900 m., and its extreme breadth from E. to W., exclusive of British Burmah, about 1,700 m. According to Dr. W. W. Hunter, director general of statistics to the government of India, the empire and its feudatory states embrace a territory of 1,556,836 sq. m., with a population of not less than 200,000,000. The country is naturally divided into several great regions. In the north are the extensive depressed river basins of the Indus and the Ganges. The central portion is occupied by a diamond-shaped table land having its greatest length from N. to S. An elevated wedge-like district forms the termination of the peninsula, sloping from its centre to the E. and W. coasts, and southward to Cape Comorin. The Vindhya mountains stretch across the central plateau from near the W. coast, in lat. 22° 10', to the Ganges valley near lat. 25°. N. of this range is the northern portion of the diamond-shaped table land. Its apex is in the vicinity of Delhi; the Aravulli mountains, an offshoot of the Vindhya, bound it on the west, and its N. E. margin is

parallel with the Ganges. The Vindhya range and its continuations to the Rajmahal hills where the Ganges turns southward toward delta, form the northern boundary of the southern part of the central table land. It is fringed on the west by the Western Ghauts and on the east by the lower Eastern Ghauts, the two ranges converging at the south in the Neilgherry hills, long supposed to be the highest mountain mass S. of the Himalaya. A peak in the Animalley hills, further S., is not known to be 8,837 ft. above the level of the sea higher than Mt. Dodabetta, the loftiest summit of the Neilgherries. The Western Ghauts rise from 3,000 to upward of 5,000 ft. (in some parts to 7,000 ft.), but the Eastern Ghauts rarely exceed 3,000 ft. A more detailed examination of the physical configuration of India presents the following clearly defined geographic divisions: 1. The Himalaya mountains, full treated under their own title. 2. The plain of the Indus, which comprises the Punjaub, or fan-shaped "country of the five rivers," Indus, Jhelum, Chenaub, Ravee, and Sutlej; the great Indian desert; and the valley of Sindh. The Sulman and Hala mountains separate this region from Afghanistan and Beloochistan. The general surface of the Punjaub slopes southward from the Himalaya range. In the north is a narrow but well watered agricultural belt of great fertility; to this succeeds a region where rainfall is less plentiful, and where cultivation is confined to the valleys, from 4 to 10 m. in width, while the rivers have worn down below the level of the adjacent sterile country, to depths of from 10 to 50 ft. The alluvial plain of Sindh is arid, rainless, and absolutely unproductive without artificial irrigation. It is bordered on the east by the great desert, frequently termed the Thurr, a formation of hard clay overspread with shifting sand, which extends to the basin of the Ganges, being itself bounded S. E. by the Aravulli mountains. The principal countries of the plain of the Indus are: the province of the Punjaub, which includes the former kingdom of Lahore; the native state of Bhawalpoor; the western portion of Rajpootana; and the commissionership of Sindh, under the Bombay government. 3. The plain of the Ganges, which, together with all central India nearly as far S. as the Nerbudda river, constitute Hindostan proper, the name not having been applied originally to the whole country. This region is densely populated, teems with fertility, and is especially rich in historical interest. On the east the basin of the Ganges unites with that of the Brahmapootra, beyond which rise the Cossyah and Garrow hills and the Burmes mountains. The slope of the Gangetic plain from the base of the Himalayas to the bay of Bengal is very gentle, not greatly exceeding 1,000 ft. of descent. The British administrative divisions of this part of India are: the Northwest Provinces, in which is the territory known as Rohileund; Oude; and Bengal, of which the garden-like state of Behar forms



117° Longitude East 157° from Washington 162° 167° 172°

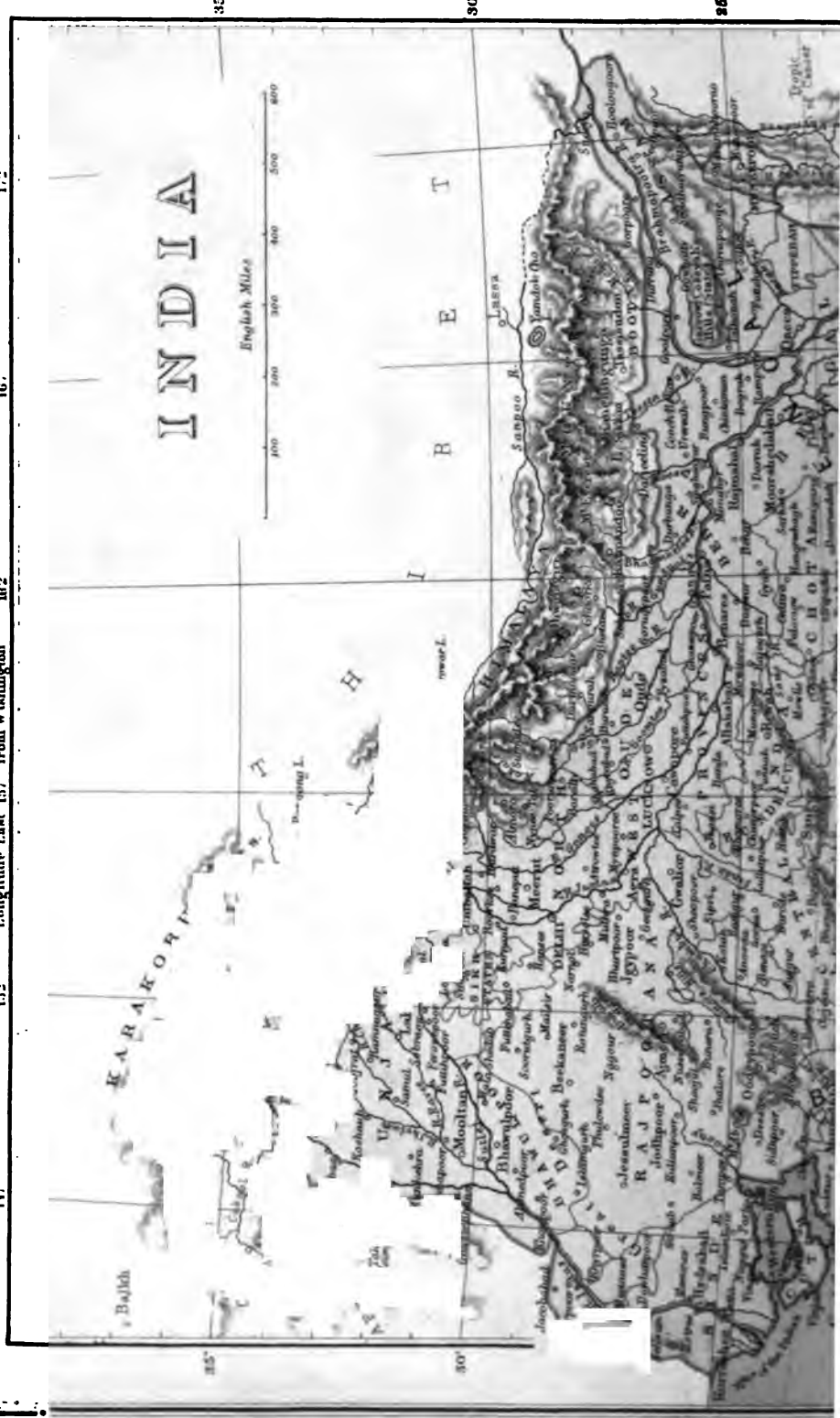

# INDIA

English Miles  
0 100 200 300 400 500 600

KARAKORAM

BRITISH INDIA

**B A Y OF  
B E N G A L**

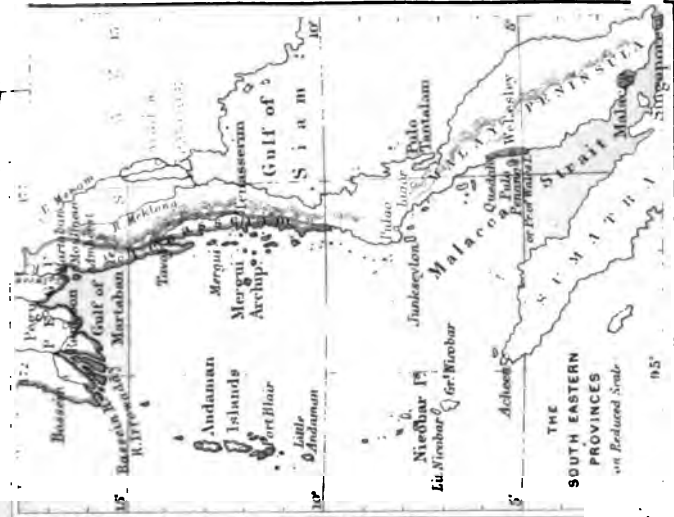
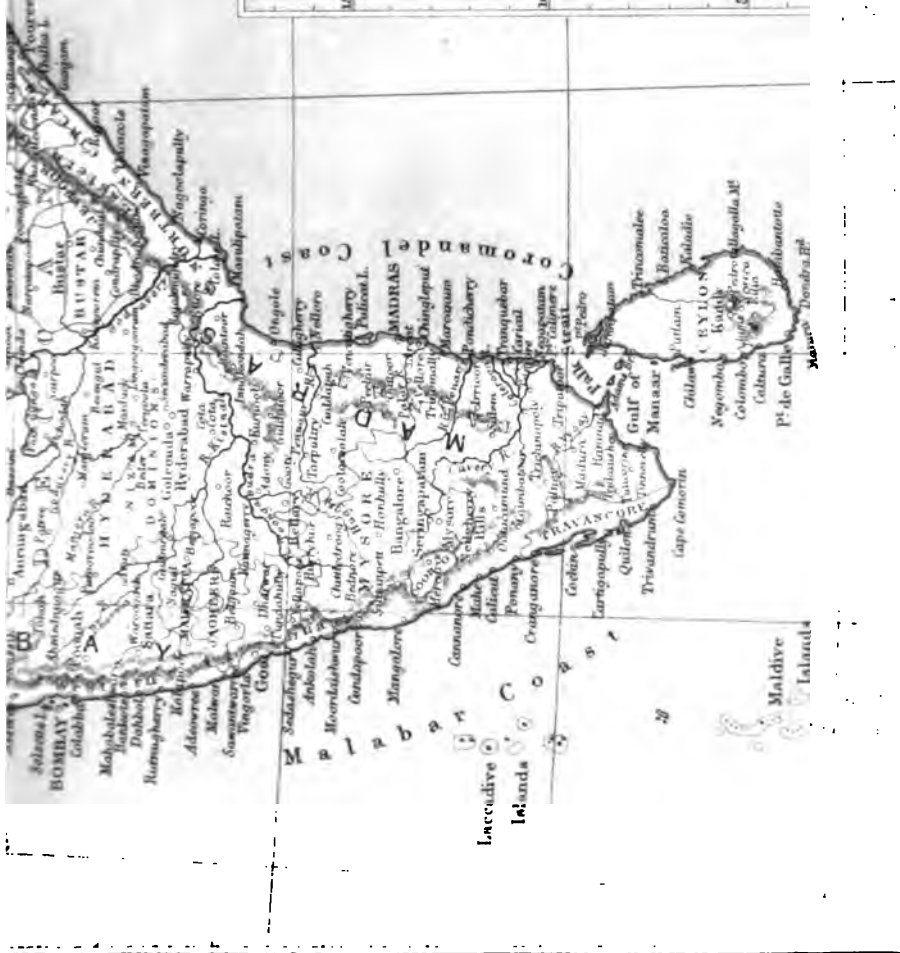



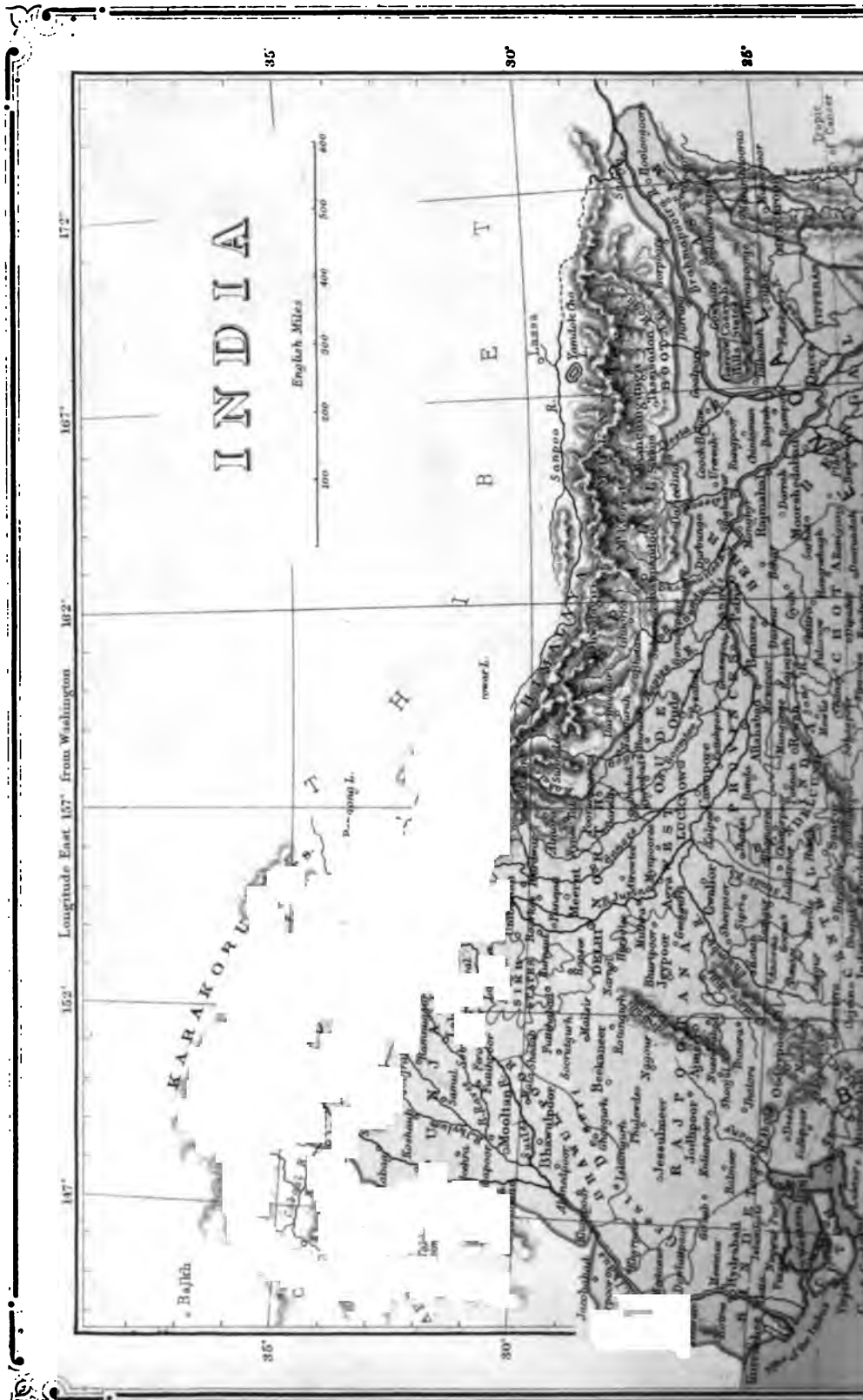

147° 152° 167° 172°

Longitude East 157° from Washington

# INDIA

English Miles

0 100 200 300 400 500 600

KARAKORUM

B E N G A L

35°

30°

30°

35°





the western portion. 4. The highlands of central India. In the most extensive sense these comprehend the whole of the interior plateau not included in the Deccan. On the northern slope is the table land of Malwa, with an elevation of from 1,800 to 2,000 ft. above the sea. It is occupied by a number of principalities ruled by native chiefs, under the supervision of the British government. On the W. side are Guzerat and Cutch. A part of Rajpootana falls within this geographical division. The territory, which owes its name to the former rule of Rajpoot princes over most of it, consists of 18 separate subject-allied states of various dimensions, with a collective area estimated at 80,000 sq. m., and about 8,500,000 inhabitants. Strictly speaking, the Nerbudda valley is the northern limit of the Deccan; but the region comprising the Satpoora hills, S. of the river, and lying between lon. 76° and 82° E. along the 22d parallel, is generally regarded as belonging to the highlands of central India. Here culminates the elevated ridge which has been referred to as crossing the peninsula, in peaks nearly 5,000 ft. high, rising above numerous lower plateaus and flat-topped hills, below which lies the general surface of the plain, which has an elevation of about 1,000 ft. above the sea. In this section are the head waters of the Sone, which flows into the Ganges, of the Mahanuddy, running directly into the bay of Bengal, and of the parallel westward-flowing Nerbudda and Taptee. There is also a southern drainage into the Godavery. The country was anciently called Gondwana, from the Gonds, its aboriginal inhabitants. It is now incorporated politically within 11 of the 19 administrative districts of the Central Provinces. 5. The Deccan, a term originally applied to the whole peninsula of India S. of the Nerbudda river, but now restricted to the country extending from the Nerbudda on the north to the Kistnah on the south, or from near lat. 23° to 16° N. It consists chiefly of an elevated table land, enclosed by low plains extending to the seashore, the E. and W. Ghauts forming its buttresses. This table land extends beyond the Kistnah to the Neilgherries, and gradually increases in height, as it trends southward, from 1,500 to 2,000 ft. in Hyderabad to 4,000 ft. in Mysore. Its principal rivers are the Godavery, draining an area of 92,800 sq. m., the Kistnah, with a drainage basin of 81,000 sq. m., and the Mahanuddy. These, as well as the Cavery, which waters Mysore, flow to the S. E. coast. The centre of the N. portion of the Deccan is occupied by the territories of the nizam or rajah of Hyderabad, a Mohammedan prince whose dominions were formerly called the kingdom of Golconda, from the city of that name, famous for its traffic in diamonds. The rest of the Deccan, with inconsiderable exceptions, is subject directly to British rule, under the governments of Madras and Bombay; while Mysore is now administered as a British province. The narrow strip of land which

lies between the Western Ghauts and the Indian ocean is called the Malabar coast, but the name properly belongs only to the portion S. of Canara. The opposite coast of the peninsula, on the bay of Bengal, is called Coromandel. All the eastern part of the peninsula between the Kistnah and the southern boundary of Mysore is called the Carnatic. 6. The triangular block in which India terminates at the south. Here the Palnai hills confront the Neilgherries, and like them overlook the gap of Coimbatore, which separates the two ranges. Extensions of the Eastern and Western Ghauts stretch southward nearly to Cape Comorin. Cochin and Travancore are subject-allied territories in the west; the rest of the region is a part of the Madras presidency. The entire tract is fertile, well wooded, and abundantly supplied with water. 7. British Burmah, described under its own title, is a province geographically distinct from the rest of India.—For purposes of political administration under British rule, India was long divided into the three presidencies of Fort William in Bengal, Madras, and Bombay; but this mode of division has been abandoned. The following table shows the existing arrangement of provinces, and the area and population of each, according to the official statement furnished to parliament by the secretary of state for India in 1873. In the case of Bengal, the area is exclusive of waste and forest lands and great rivers; and the Bannu district is not included in the area of the Punjab:

DIVISIONS.	Date of census.	Area in sq. miles.	Population.
Bengal.....	1872	280,582	66,556,559
N'hwest Provinces..	1872	80,901	80,769,066
Oude.....	1869	23,978	11,220,747
Punjab.....	1872	101,728	17,611,498
Central Provinces...	1872	84,163	9,066,098
Behar.....	1867	16,960	2,281,565
British Burmah.....	1871-'2	93,664	2,562,328
Madras.....	1872	141,746	81,311,142
Mysore.....	1872	27,977	5,053,412
Coorg.....	1872	2,000	168,312
Bombay.....	1872	127,532	14,042,596
Total British India.....		980,599	190,895,543
Native states.....		646,147	46,245,585
Total.....		1,576,746	237,141,436

The statistics as to British Burmah are merely estimates from the administration report of that province for 1871-'2. A census was taken there in 1872, but its results have not yet been published. Bengal proper, Behar, Orissa, Assam, and Chota Nagpore make up the present province of Bengal, and together with the Northwest Provinces formerly constituted the presidency of Fort William in Bengal. Mysore and Coorg are under one provincial administration. The chief executive authority of the Indian government is the governor general, or viceroy, who is appointed by the crown, and receives a salary of £25,000 per annum, besides allowances. He acts under the direction of the secretary of state for India, a member of the

British ministry, who is assisted by a council of 15 persons, 9 of whom must have had at least 10 years' experience in India. Originally 7 of these councillors were appointed by the East India company, but the secretary of state for India has the power to fill future vacancies. Their term of office is 10 years. The law-making power is vested in the governor general in council. The seat of government is at Calcutta. The governors of Madras and Bombay are appointed directly by the crown, but the lieutenant governors and commissioners of the other provinces are appointed by the viceroy subject to the approval of the crown. The governor general's council consists of five ordinary members, and the commander-in-chief of the army as an extraordinary member. The military force maintained by the British government in India in 1872 numbered 190,264 men, of whom, exclusive of officers, 60,682 were English, stationed chiefly in the Punjab and along the valley of the Ganges. All appointments to the civil service are made upon competitive examination. The district is the unit of the general civil administration of the British in India. The districts vary greatly in area and population, as, for example, from 1,200 to 12,000 sq. m., and from 500,000 to 1,000,000 inhabitants. The chief government official in each district is the collector and magistrate. He receives the revenue, is intrusted with magisterial powers and certain judicial functions, and is generally responsible for the public welfare. He is usually aided by several deputies and assistants. The highest judicial authority in the district is vested in the district judge, who exercises original jurisdiction in criminal cases, reviews the judicial determinations of the collector and magistrate, and hears appeals from the numerous civil courts held by native judges. There are high courts at Calcutta, Bombay, and Madras, with general appellate jurisdiction, special powers concerning cases affecting Europeans, and original local jurisdiction. A code of criminal procedure regulates the administration of the laws relating to offences.—With the exception of Nepal and Bootan in the north, the native states of India are all more or less subject to British control or interference. Estimates of the area and population of these states appear in the following table:

NATIVE STATES UNDER	Area in sq. m.	Population.
Government of India.....	885,296	27,716,252
" Bengal.....	79,156	2,189,565
" N'hwest Provinces.....	5,890	1,284,691
" Punjab.....	48,577	5,066,502
" Central Provinces.....	25,899	1,095,275
" Madras.....	81,958	2,371,888
" Bombay.....	72,076	6,552,170
Total native states.....	646,147	46,245,683

In the north, British supremacy is acknowledged in Cashmere, although that country is not included in the above estimates. Bhawalpoor is

the next in importance of the states supported by the Punjab government, which also intends the Sikh districts lying between Sutlej and the Jumna. Further S. is Ferozshah, the agent for which resides at Ajmer, the small British district of that name being the centre of the country. The native states of central India form what is called the Deccan agency. Among them are Gwalior, Bundelkhand, and the Mahratta country. Guzerat, Mysore, and Cutch are under the British administration. In the Deccan, the chief dependency is Hyderabad. The Madras governor presides over Cochin and Travancore to the extreme south. The French possess Pondicherry and Carical on the Coromandel coast, and Mahé on the Malabar coast, as well as the town of Chandernagore, 17 m. N. of Calcutta, but the aggregate area of the French possessions in India is estimated at 1,000 sq. m., and the population at about 1,000,000. The territory of Goa, on the Bombay coast, and Damaun, a seaport of North Concan, are islands off the southern coast of Cattyay, the colonies of Portugal. Goa has an area of 1,000 sq. m. and contains about 418,000 inhabitants.—The principal mountains and rivers of India have been referred to in the description of the country. The lengths of the chief rivers are: the Indus, 1,800 m.; the Ganges and Brahmapootra, 1,500 m., if the latter be regarded as in one stream; the Sampo; Jumna, a tributary of the Ganges, 800; Sutlej, a branch of the Indus, 900; Godavari, a tributary of the Indus, 750; Godavari, a branch of the Ganges, 400; Godavari, 300; Kistnah, 800; Nerbudda, 800; Mahanadi, 550; Cavery, 470; and Taptee, 450. There are, considering its great extent, insufficiently numerous lakes. In the province of Orissa, the Chilka lake, 44 m. long and from 10 to 15 m. broad; and on the Coromandel coast, the Pulicat lake, 38 m. long and 11 m. wide. These, however, are salt lakes, and are in fact more than lagoons formed by the sea overflowing the low sandy shore. There are many other lakes, but none of much size.—The climate of India varies from that of the temperate zone in the Himalaya to the tropical in the lowlands. On the central and southern parts of the lowlands the climate is comparatively temperate, the thermometer falling as low as 40° in winter; but on the great plain the climate is more than temperate, the thermometer containing the principal cities and the population the heat during the greater part of the year is excessive, the thermometer frequently rising to 100° and 110° F. A strong influence is exercised on the climate of Hindostan by the winds called the monsoons, which blow half the year from the W. and the other half from the N. E. The W. monsoon begins in the south of Hindostan early in June, and in the north somewhat later. It brings with it from the Indian ocean a large amount of rain, which continues to fall at intervals until the end of September. During the

season the fall of rain is in Bengal from 50 to 80 in. The N. E. monsoon begins about the middle of October, and brings rain from the bay of Bengal, which falls in torrents on the Coromandel coast until the middle or end of December, during which period the opposite coast of the peninsula enjoys fair weather and northerly breezes. From December to June is the dry season, during which little rain falls.—The great plain of the Ganges is a rich, black, alluvial mould. In some parts of Bengal extensive tracts of clayey soil are found. In the Punjab a black fertile soil prevails, which to the southwest in Sinde and Guzerat becomes sandy. On the table land of Malwa the soil is a deep, rich, black mould. On the great northern table land it is generally a fertile loam on a substratum of rock. On the Malabar coast a red clay soil is found. On the Coromandel coast the soil is mostly sandy from the sea to the foot of the Ghats. A complete geological survey of India was commenced 22 years ago, and is still in progress. Coal, iron, and salt are the most important and abundant mineral products. The principal coal fields are in the valley of the river Dammoda, N. W. of Calcutta, where they occupy an area of 1,500 sq. m. Of 497,000 tons of coal mined in India in 1868, 498,000 tons were obtained from the Raniganj bed in this district. Other coal-bearing localities are Chota Nagpore, South Rohah, and the upper Sone valley, where seams are known to exist, although they have never been thoroughly explored; the Nerbudda valley and the Satpoora hills in central India; and the sandstone region which forms the basin of the Godavery and its affluents the Pranhita and Wardah. Coal of good quality is also found at the Cosyah hills, and in the wild and densely timbered tracts of eastern Assam. The average proportion of fixed carbon in Indian coal is 52 per cent., and there is from 10 to 30 per cent. of ash. Iron is widely distributed throughout the country, the sources of supply being red hematite, magnetic, specular, and lay ores, and surface deposits. It has been manufactured in India for centuries. Salt is secured, in immense quantities and of remarkable purity, from the salt range of the Punjab. In India the amount of salt consumed is a greater proportion to other articles of food than in any other country in the world. Salt is found in the gravel of streams, but only in small quantities. It occurs in the north-western Himalaya districts, where silver associated with lead is also found, and in Chota Nagpore, Assam, the valley of the Godavery, and many other parts. Lead is obtained from the same portion of the Himalaya, and here is a considerable yield of copper in Berwahal, Nepal, and Sikkim, and near Singboon in Bengal. Antimony occurs abundantly in northern India, and cobalt in small quantities near Jeypoor in Rajpootana. There are valuable tin mines in British Burmah, and strontium has been discovered in the Pegu dis-

trict of that province, as well as in some parts of the Punjab. Among the gems found in India are the diamond, ruby, topaz, beryl, carnelian, and garnet. The yield of Indian diamonds has largely diminished, but some are still obtained in the Central Provinces and in southern India. Beautiful agates are exported from Guzerat.—The characteristics of Indian vegetation vary with the zones of elevation. The flora of the mountain region of the north corresponds closely with that of Europe. This section is the home of the pine and other conifers. No species of pine is native to the peninsula, but on the mountains of British Burmah grow forests of the *pinus Khasiana*. Along the foot of the Himalaya range from Sikkim to Assam is found the *ficus elastica*, which yields caoutchouc. Below the coniferous forests are tracts of bamboo, whence millions of bamboos are annually exported down the Ganges. Here also grows the saul (*shorea robusta*), second in value only to the teak among the timber trees of India. There are extensive teak forests on the trap formations of the highlands of central India. In Sinde and the Punjab, the babul (*acacia Arabica*) and a leafless caper shrub (*capparis aphylla*) cover broad belts of country. A large proportion of the timber growth of the Northwest Provinces consists of the deodar tree, from which railway sleepers are made. The sissu is another important Indian timber tree. There are plantations of sandalwood in Mysore, and the valuable ironwood tree occurs in the Burmese commissionership of Aracan. The Indian government maintains a thorough system of forest conservancy. Among the characteristic forms of vegetation are the celebrated banian tree and the sacred peepul (*ficus religiosa*). The palm family is represented by the cocoanut and betelnut. Rice is the staple cereal production of the plains, which also yield cotton, sugar cane, indigo, jute, and opium. Maize, millet, peas, beans, and many varieties of grain peculiar to the country are also raised. Wheat and barley are cultivated on the higher grounds. There are extensive tea gardens in Assam and the mountainous districts of the north, and the cultivation of coffee is carried on among the hills of southern India. The cinchona plant was introduced into India from South America in 1860, and has been grown with great success among the Neilgherries, and in other sections. Pepper is produced in Malabar. The fruits of the temperate zone are found in the elevated regions, while those of the tropics, prominent among which is the mango, grow in the lower and warmer parts of the country.—In the geographical distribution of animals, the fauna of India belongs to the zoological province including southern Asia and the western portion of the Indian archipelago. Ten species of *felidæ* are found S. of the Himalaya, including the lion, tiger, leopard, cheetah, and the true cats (*F. catua*). The Indian lion is characterized by a very short mane. Of all

and the country is a large tract of low land, the soil is fertile, and the climate is warm. The country is divided into several provinces, and the people are of various castes. The most remarkable feature in the social life of India is the Hindoo institution of caste, for an account of which see INDIA, RELIGIOUS AND RELIGIOUS LITERATURE OR. The condition of the people is as various

as the different regions they inhabit. The most remarkable feature in the social life of India is the Hindoo institution of caste, for an account of which see INDIA, RELIGIOUS AND RELIGIOUS LITERATURE OR. The condition of the people is as various

Delhi, and Lucknow are especially re-  
 ce for their delicacy, beauty, and taste.  
 st wonderful structures in the country  
 aps the great rock temples in the west-  
 ; of the Deccan, and those near Bom-  
 ee ELEPHANTA, and ELLORA.)—Among  
 t important cities of India are Calcutta,  
 tal, on the Hoogly, in Bengal; Bom-  
 ; chief seaport on the W. coast; Ma-  
 the Coromandel coast; Benares, the  
 y of the Hindoos, in the North-west  
 es, on the banks of the Ganges; Patna,  
 rtant centre of the opium trade in Be-  
 lahabad, at the confluence of the Gan-  
 the Jumna; Lucknow, the capital of  
 Delhi, the metropolis of the Moham-  
 mpire in India; Lahore and Amritsir,  
 unjaub; Baroda, in Guzerat; Poonah,  
 eritory of Bombay; Nagpore, in the  
 t central India; and Hyderabad, the  
 of the Nizam's Dominions. Almost  
 ese cities contain upward of 100,000  
 nts, as do also Agra, Ahmedabad,  
 re, and several others.—A vast net-  
 f railways, constructed by the Brit-  
 apidly overspreading the entire land-  
 re already completed running up the  
 e valley from Calcutta to Allahabad  
 hi, with a continuation to Lahore, and  
 to Lucknow; from Bombay to Allah-  
 connecting the former city with  
 ; also from Bombay northward to  
 and southward across the peninsula to  
 Many other lines are in progress of  
 tion. In 1873, 5,478½ m. of railway  
 operation. Telegraph lines, with an  
 e length of 15,102 m. in 1871, connect  
 mportant places in India. There are  
 ites of telegraphic communication with  
 : one consisting of land lines from Con-  
 ple to Bagdad, and thence to Fão at the  
 the Persian gulf, whence a submarine  
 ds to the port of Kurrachee near the  
 of the Indus; a second, by means of the  
 le to Bushire, which is one of its res-  
 tations, and thence to the European  
 y way of Teheran, Tiflis, and Kertch;  
 third being the submarine cable be-  
 nez and Bombay. A submarine cable  
 ends from Madras to Singapore, and  
 er port is similarly connected with  
 ong. The chief public works of na-  
 struction are reservoirs or tanks for  
 of irrigation, which exist in immense  
 and frequently of great size and cost,  
 en magnificently built of stone. There  
 a number of canals constructed by the  
 rinces in former ages, but these have  
 fallen into neglect and disuse. The  
 government has conducted an extensive  
 smatic course of internal improvement.  
 e canals, inferior to none in the world,  
 en constructed, the chief of which are  
 the Jumna and the Ganges, to facili-  
 only irrigation but the navigation of  
 vers. These great systems of irriga-

tion comprehend not only the upper portion  
 of the Ganges basin, but the valley of the In-  
 dus, and districts in Orissa, Madras, Bombay,  
 and other parts of the country.—Silk, cotton,  
 and woollen goods are the leading manufac-  
 tures of India. Sericulture is extensively car-  
 ried on in Bengal and Mysore, and both these  
 provinces are the seats of silk manufacture.  
 Delhi is celebrated for its silk embroideries,  
 and Benares and Ahmedabad for their gold  
 brocades. The manufactures of the Punjab  
 comprise silks, woollens, and white and colored  
 cotton goods, the estimated value of the annual  
 production being £4,850,000. Cotton is also  
 manufactured in Oude, the Central Provinces,  
 and Mysore. In the latter country there are  
 cutlery works and manufactories of gold and  
 silver lace. As the great bulk of the products  
 is consumed in the country itself, the internal  
 trade is very large, but there are only meagre  
 statistics concerning it. Silver is the standard  
 of value, and the monetary unit is the rupee,  
 which is worth about two shillings sterling.  
 The foreign trade of India has for centuries  
 been famous for its lucrative nature. There  
 were said to be 1,230 square-rigged vessels, 948  
 steamers, and over 50,000 native craft engaged  
 in its carriage in 1871-'2. In that year the val-  
 ues of some of the principal exports were as  
 follows: coffee, £1,380,409; cotton, £21,272,-  
 480; grains, including rice, £4,865,748; indi-  
 go, £3,705,475; jute, £4,117,308; opium, £18,-  
 865,228; seeds, £2,728,127; tea, £1,482,185;  
 and wool, £906,699. The chief articles import-  
 ed in the same year were: cotton twist and  
 yarn, £2,473,353; cotton piece goods, £15,009,-  
 981; machinery, £405,835; manufactured met-  
 als, £925,839; raw metals, £1,464,936; railway  
 materials and stores, £516,996; salt, £918,-  
 915; raw silk, £651,595; silk goods, £480,948;  
 wines and liquors, £1,381,961. Of gold and  
 silver £11,573,813 were imported in 1871-'2,  
 and £1,476,093 exported, leaving a balance of  
 £10,097,720 remaining in India. This flow of  
 the precious metals into India has for ages  
 been a remarkable feature of the commerce of  
 that country. A considerable foreign traffic,  
 amounting to more than £1,000,000 in value  
 annually, is carried on over the Himalayan  
 passes, with Afghanistan, Turkistan, and Thi-  
 bet.—The main sources of government revenue  
 are the land tax, opium sales, salt duties, cus-  
 toms, and excise and stamp tax. More than  
 two fifths of the receipts are derived from the  
 land settlements. The terms of these vary in  
 different provinces, but the principle generally  
 sought to be applied is that the government is  
 entitled to receive a certain proportion of the  
 net produce of the land. Three modes of set-  
 tlement are in vogue: the zemindary, in which  
 proprietors known as zemindars are responsi-  
 ble for the assessments of given districts, thus  
 standing in the position of landlords them-  
 selves; the village system, in which the vil-  
 lagers hold the land collectively as toward  
 the government; and the ryotwar system, in



which the individual cultivators, known as ryots, pay assessments directly to the government. Bengal is for the most part subject to a permanent settlement made on a fixed basis for ever with the zemindars in 1793; so that the land revenue of Bengal proper, Behar, and Orissa yields but little more now than it did then. Generally throughout the rest of the country, however, the government demand is a certain percentage of an assumed rental, which rental is fixed for a term of years, quite commonly 30. In northern India the tenure by village communities prevails, but Madras and Bombay are subject to the ryotwar system. The government has a monopoly of the opium grown in Bengal, which it buys of the cultivator at a fixed price, and sells in the following year. A heavy duty is levied on Malwa opium, which can be legally exported only through the port of Bombay. There is a duty on imported salt in Bengal, a government salt monopoly in Madras, and an excise on the salt works in Bombay. In the year ending March 31, 1872, the revenue included £20,520,337 from land, £9,253,859 from opium, £5,966,595 from salt, £2,575,990 from customs, £2,369,109 from excise on spirits and drugs, and £2,476,383 from stamps. The total ordinary revenue of the Indian government for that year was £50,110,215, and the total ordinary expenditure £46,986,088. For 1872-'3 the revenue was £50,220,360, and the total expenditure was £50,641,052, of which £2,184,570 was extraordinary expenditure for public works. Excluding the latter item, there was a surplus of £1,763,878; including it, the deficit for the year amounted to £420,692. The regular estimates for 1873-'4 were as follows: Revenue, £49,476,000; ordinary expenditure, £51,577,300, which included £3,920,000 for the relief of the famine in Bengal; extraordinary expenditure upon public works, £3,541,000; total expenditure, £55,118,300; surplus, excluding expenditures on account of the famine and for public works, £1,818,700; deficit, excluding expenditure for public works, £2,101,300; deficit, including it, £5,642,300. The preliminary estimates of the governor general for the fiscal year 1874-'5 show a revenue of £48,984,000 and a total expenditure of £54,935,000, thus leaving a deficit of £5,951,000. The expenditure comprises £2,580,000 for famine relief, and £4,563,000 for public works; if these items were excluded, there would be a surplus of £1,192,000. The deficit would be reduced to £1,388,000 if the amount laid out on public works were excluded from the total expenditure.—A well graded system of education, providing instruction for all classes, has been in process of organization and development in India since 1854. There are three universities, at Calcutta, Madras, and Bombay respectively. With each of these is affiliated a certain number of colleges, which fit the university undergraduates for the higher examinations; and next below in the scale are the

high schools where students are prepared to enter the university. These institutions complete the scheme for the education of the wealthier classes. After them come the middle schools, where the course of instruction is intermediate between that of the primary and the high schools. Elementary education is afforded by the primary or village schools of which the several provinces contain 37,344, there being 9,701 in receipt of government aid. Of colleges there are 28 in Bengal, 7 in the Northwest Provinces, 1 in Oude, 3 in the Punjab, 13 in Madras, and 8 in Bombay. The total number of high schools is 349, of middle schools 3,096, of female schools 2,011, and of normal schools 132. The professional schools comprise civil engineering colleges at Roorkee, Calcutta, Madras, and Poonah; medical colleges at Bombay, Madras, Lahore, and Calcutta (the attendance of students at the last in 1871-'2 numbering 1,046 persons); and schools of design and decorative art at Calcutta and Madras. There are museums in many of the principal cities. From the outset it has been the object of the Indian educational system, while encouraging the cultivation of the English language, to diffuse a knowledge of European science, art, and philosophy by means of the native languages. There is an influential native press, and several hundreds of books in various tongues are published annually. Scientific and literary societies, including both Europeans and natives in their membership, flourish in many of the cities. Prominent among them is the Bengal Asiatic society at Calcutta, founded in 1784 by Sir William Jones.—Of the earliest period of the history of India little is known with certainty. The sacred writings of the Hindoos give to their ancient history an incredible chronology, extending over millions of years, and treat of heroes, kings, and dynasties, in most instances probably merely mythical or fabulous. It is the general opinion of the best authorities, that the Hindoos were not the first inhabitants of the country, but were an invading race who subdued and enslaved the aborigines, who are still represented by rude tribes in the central and southern parts of India, such as the Bheels, the Kolecas, the Gonds, and the Shanars. The distinction of castes did not exist among these people, and their religion seems to have consisted of the worship of a variety of spiritual deities. The Aryan Hindoos are supposed to have entered the country from the northwest, probably from regions between the Hindoo Koosh and the Caspian sea. They brought with them the Brahmanical religion, and formed the institution of caste by dividing themselves into the three higher castes of Brahmans, Kshatriyas, and Vaisyas, while the conquered people constituted the Sudras or servile caste. It is not known at what period this invasion took place, but it was undoubtedly prior to the 14th century B. C. The language of the conquerors was probably the

it, in which their sacred books were written. The Vedas, supposed to have been composed about the 14th century B. C., are esteemed the holiest. Two great dynasties, the Kuru and the race of the sun, who reigned in the north, the modern Oude, and the race of the Yadu, who reigned in Pruyag, the modern Benares, figure in the legends of their early history, and their contests are recorded in the Mahabharata. The most celebrated of these sovereigns was Rama or Ramana, who is supposed to have lived about the 12th or 13th century B. C. His deeds are the subject of the great epic poem the Ramayana. Subsequently long civil wars among the princes of the lunar race, culminated in a great battle where the armies of 56 kings fought for 18 days. But the most important event in the history of India of which we have an authentic account was the invasion of the Persians under King Darius, about 518 B. C. The Persian monarch conquered and annexed to his empire provinces on the north so rich and extensive that, according to the accounts of ancient historians, their tribute furnished the principal part of the revenues of the Persian crown. About 334 B. C. Alexander the Great, having overthrown the Persian empire, invaded India, defeated Porus, one of the kings of the country north of the Punjab, and penetrated with his army as far as the Hyphasis (the Sutlej or Sattledj, a branch, the Beas). The historians of that age describe the manners, customs, and condition of the Hindoos in a way that shows they have since been changed but little. In the year 335 B. C. of the Macedonian empire after the death of Alexander, Seleucus, one of his generals, obtained the eastern part, and founded the Seleucid kingdom, which included the provinces north of the Indus. He attempted conquests in the north, but was repulsed at that river, and was involved in war with Chandragupta, king of Maghada, whom he defeated and called Sandracottus. With this king Seleucus made a treaty by which he relinquished all claim to any possessions north of the Indus. The kingdom of Macedonia comprised the greater part of northern India, and lasted till about 185 B. C. Its capital, Palibothra, was on the Ganges, the precise site is unknown. After its fall all India was divided into a number of kingdoms, of whose history little is known, and which have since been gathered principally from inscriptions and coins. India's relations with the external world were again renewed about 630 B. C. when the Mohammedan governor of Persia sent by sea an army not exceeding 12,000 in number, commanded by Mohammed bin Qasim, to obtain restitution of an Arab vessel which had been taken near the mouths of the Indus not long previously. Kasim landed at the mouth of the Indus, and succeeded in conquering Sindh and the southern part of the Punjab, where the Mohammedans held power for about forty years, when they were expelled by the Rajpoots. India re-

mained unmolested from that time till 977, when Subooktgeen, the Afghan sultan of Ghuzni, invaded a portion of the Punjab and took possession of Peshawur, but did not long retain his conquests. His son Mahmud made his first expedition into India in 1001, at the head of an army of 42,000 men, and conquered a portion of the north. In the course of his reign of 33 years, which ended in 1030, he made 10 expeditions into India for conquest and plunder. He left extensive possessions in western India to his successors, one of whom, Massoud III., greatly extended the Mohammedan rule. He carried his conquests beyond the Ganges, and transferred his court from Ghuzni to Lahore. He was the first Mohammedan sovereign whose capital was within the limits of Hindostan. In the early part of the 12th century a civil war among the Mohammedan conquerors resulted in placing the house of Ghore on the throne of Lahore. One of the monarchs of this dynasty, Shahab ud-Din, better known as Mohammed Ghore, overthrew the kings of Delhi and Ajmeer, conquered Benares, Gwalior, Guzerat, and many other cities and provinces, and at the time of his death in 1205 was master of nearly all the country north of the Nerbudda, including Bengal, Sindh, and Guzerat. Under his successor, Kuttub ud-Din, a Turkish slave who had been educated by Shahab ud-Din, the Mohammedan dominions in India were separated from the Afghan empire and formed an independent kingdom, the capital of which was Delhi. Kuttub ud-Din was the founder of a dynasty known as the slave kings, ten in number, five of whom were violently deposed, and the last, Kei Kobad, was murdered in 1288. The most eminent of these sovereigns, Altmish, extended his dominions by conquests southward, and at the end of his reign all India north of a line running from Surat to the mouth of the Ganges acknowledged the authority of the court of Delhi. Kei Kobad was succeeded by Jelal ud-Din, the founder of the dynasty known as the house of Khilji. During his reign, his nephew Alla ud-Din, an able and ambitious general, invaded and conquered a large part of the Deccan, and on his return from this expedition caused his uncle the emperor to be assassinated, and usurped the throne in 1296. He was one of the most eminent of the Mohammedan rulers of Hindostan, and in his reign of 20 years considerably enlarged the empire, maintained a brilliant court, patronized learning and the arts, and successfully repelled several great invasions of the Moguls or Tartars who had established themselves in the countries west of the Indus. He died in 1316, poisoned, it was generally thought, by his vizier. His three successors died by violence, and in 1321 the house of Khilji became extinct. Five emperors of that dynasty had reigned 33 years, and all had perished by poison or the sword. Togluk Shah, the founder of the house of Togluk, ascended

the vacant throne in 1321. He was one of the best of the Mohammedan sovereigns, but his reign lasted only four years, when he was killed by the fall of a pavilion which is supposed to have been intentionally caused by his son, who succeeded him under the name of Mohammed Togluk, and after a reign of about 27 years died in 1351, leaving, says a historian, "the reputation of one of the most accomplished princes and most furious tyrants that ever adorned or disgraced human nature." During this disorderly reign Bengal and several of the provinces of southern India became independent. Mohammed Togluk was succeeded after a short civil war by his cousin Feroze Togluk, the founder of Ferozabad, near Delhi, who reigned for 36 years, and was distinguished for humanity and for the vast number of public works which he constructed and endowed with revenues. In the reign of his grandson Mahmoud Togluk, in 1398, India was invaded by the famous Tartar conqueror Tamerlane, who captured Delhi, plundered and slaughtered the inhabitants with frightful barbarity, and caused himself to be proclaimed emperor of India. At the end of 15 days, however, he abruptly quitted Delhi and returned to his own country, "marking his way with fire and sword, and leaving anarchy, famine, and pestilence behind him." The governors of the various provinces of the empire proclaimed their independence of Delhi, and assumed royal titles, so that only a small district remained subject to the authority of the imperial capital. Half a century of anarchy succeeded, during which there were five titular emperors in Delhi, who however had no real authority beyond the walls of the city. The Togluk dynasty ceased with the death of Mohammed Togluk in 1414. At length in 1450 Beylol Lodi, an Afghan military chief of talent and energy, made himself the actual sovereign, though nominally acting as vizier to one of the titular monarchs, whom he finally succeeded in 1478. Before his death in 1488, he succeeded in recovering many of the provinces which had formerly belonged to the empire. His son Sikunder still further enlarged his dominions in a reign of 29 years, during the latter part of which he made Agra his capital. Sikunder was succeeded by his son Ibrahim, in whose reign India was again invaded by the Moguls, led by a descendant of Tamerlane, the celebrated Baber, sultan of Cabool. Ibrahim was defeated and slain, in a battle on the plains of Paniput in 1526, and Baber ascended the throne with little further opposition, the imperial cities of Delhi and Agra surrendering without resistance. In the course of his reign of five years, Baber, who had remained in India, made himself master of all the provinces which had belonged to his predecessor. He died in December, 1530, and was succeeded by his son Humayun, who allowed one of his brothers to hold Cabool and the rest of Af-

ghanistan as an independent king; he contented himself with his Indian dominions. These he was deprived of at the end of 15 years by Shere Khan, the governor of a man of great military talents, who defeated the emperor in several battles, and finally compelled him to fly for refuge to Persia. Shere Khan was then proclaimed emperor of Delhi, with the title of Shere Khan, and reigned with wisdom and success for 15 years, when he was killed by the explosion of a magazine while directing the siege of a rebellious fortress. He was succeeded by his son Selim Shah Soor, and by his nephew Feroze Khan, the latter of whom after 10 days' reign was murdered by his uncle, who usurped the throne and took the name of Mohammed Shah. In the mean time Humayun, by the aid of the king of Persia, had made himself master of Cabool, and resolved on attempting the recovery of the throne of Delhi. This he accomplished by the aid of his heroic son Akbar, who reentered the city of Delhi, when he had been driven 15 years before, in July, 1556. He did not survive his restoration more than a few months, being killed by an accidental fall from the terrace of his palace at Delhi. Akbar, who succeeded him in 1556, reigned for 51 years. He is considered the ablest, most liberal, and most powerful of the Mogul emperors of India. He restored the empire to its former bounds, reorganized the army and the finances in a statesmanlike manner, so that his revenues were increased while the burdens of the people were diminished, and treated all religions with respect and impartiality, freely admitting the Hindoos to a share in the administration of public affairs, from which they had been jealously excluded by their Mohammedan masters. Akbar was succeeded in 1605 by his son Selim, who took the title of Jehanghir, "conqueror of the world." In the course of his reign he was intemperate, cruel, and cruel; but his habits and conduct improved after his marriage with the celebrated Nourmahal, "the light of the world," one of the most extraordinary and accomplished women known to history, whose influence over the emperor was so great that he took no step without consulting her, and that in every affair in which she was interested her will was law. The last years of Jehanghir were embittered by the quarrels of his four sons, each of whom aimed at the throne, and who were at times in open rebellion against their father. He died in the 22d year of his reign. He was succeeded by his favorite son Shah Jehan, in whose reign the Deccan was completely subdued, and rendered tributary, and a long and even successful war was waged with the Persians and the Afghans. In 1657 he fell very ill, and, thought to be dying, his son Dara, then a prince of the blood, assumed the reins of govern-

ns, Shuja, Murad, and Aurungzebe, each been appointed viceroys over the provinces, immediately revolted and by force of arms to assert their pretensions to the succession. Shuja was defeated, Aurungzebe by stratagem obtained possession of his father's person, and kept him in prison till he died, seven years afterward. Aurungzebe, as also soon seized and imprisoned by Aurungzebe, who caused himself to be proclaimed emperor. Dara continued the contest some time longer, but was finally captured and died. Shuja was driven with his family to exile, where they all perished. The reign of Aurungzebe, though it began with civil confusion, was more peaceful and orderly than that of any of his successors. The empire in India attained under him its greatest extent, including nearly all that is now called Hindostan. He died in 1707 in the 59th year of his age, after a reign of 49 years. He was an ambitious and unscrupulous monarch, possessed of great talents, and eminent as a statesman and a soldier. The most eminent historians regard him as the greatest of the Mogul emperors. During his reign the foundation of the Mahratta empire in the Deccan by an adventurer named Shivaji. (See MAHRATTAS.) Aurungzebe's son, who succeeded him under the title of Bahadour Shah, was involved at the beginning of his reign in civil war with two of his sons, both of whom were killed in battle toward the end in a contest with the British, who were just beginning to acquire influence in the northwest of India. He died in 1707 and was succeeded by his eldest son, Bahadour Shah, a weak and profligate ruler, whose second year of his reign was devoted to a battle and afterward strangled to death by his rebellious nephew Ferokhsere. The reign of the latter lasted six years, and was marked only for conspiracies, insurrections, and civil disorders in the capital and the provinces. He was at length put to death by his son and commander-in-chief, who in the next eight months successively ascended the throne three infant descendants of Aurungzebe, the last of whom, Mohammed Shah, in the youth of 17, soon became impatient of the control, of which he got rid by causing himself to be assassinated and the other deprived of life. The emperor, however, was feeble and indolent, and his dominions were invaded and divided by the Mahrattas, now rapidly becoming formidable, and on the other by the British, whose warlike monarch, Nadir Shah, invaded the Indus with a great army, and, overrunning the imperial forces, took possession of Delhi in 1739. He remained several years in the Mogul capital, which he stripped of treasure amounting, according to the estimate, to \$100,000,000, after massacring a great part of the inhabitants. He then returned to his own country, leaving Mohammed Shah in possession of his throne, and

depriving him only of the provinces west of the Indus. Mohammed Shah died in 1748, and was succeeded by his son Ahmed Shah, who after a reign of six years was deposed, and Alomghir raised to the throne, in the third year of whose reign Hindostan was invaded by the Afghans and again plundered. The Mahrattas, who were now at the height of their power, took advantage of the distress of the empire, and carried their arms into the northern provinces. The Afghans, under their sovereign Ahmed Shah Abdalli, met them at Paniput in January, 1761, and a great battle was fought, the forces on both sides amounting to 400,000 men. The Mahrattas were defeated with great slaughter, and it is said that 200,000 of them perished in the battle and the pursuit. The Afghans returned to their own country after this great victory, and left the government of Delhi to take care of itself. From this time, however, the Mogul empire was practically at an end. The English had now become the most important power in India. (See EAST INDIA COMPANIES.)—The first of the nations of modern Europe who obtained territorial possessions in Hindostan were the Portuguese, who early in the 16th century seized some ports on the western coast, and in the course of the century made themselves masters of Diu, Damann, Bassein, Salsette, Bombay, Choul, Dabul, Goa, Mangalore, Cananora, Cranganore, Calicut, Cochin, and Quilon. Their capital was Goa, where they maintained a viceroy and an archbishop. During the union of Portugal with Spain, from 1580 to 1640, these distant possessions were neglected, and many of them were taken by the Dutch or regained by the native powers. Goa and a few small places of no political or commercial importance are all that now remain of the Portuguese empire in India. The English East India company, which was chartered at London in 1600, obtained permission of the Mogul emperor Jehangir in 1613 to erect a factory at Surat. In 1628 they established a trading post at Armegoor, 70 m. north of Madras, and erected the first English fortifications in India there. They were allowed to build a factory at the mouth of the Hoogly, by a firman from the emperor Shah Jehan granted in 1634. In 1669 the island of Bombay was ceded to them by Charles II., who had acquired it as part of the dowry of his wife, the infanta of Portugal. It was in Bengal, however, that the company first began to acquire military and political power. They moved the factories on the Hoogly to Calcutta in 1698. They took into their pay bodies of native soldiers who were called sepoy, and were armed and trained in the European manner, and with the aid of these mercenaries they soon acquired a considerable degree of influence in the country. In 1744, France and England being at war in Europe, hostilities broke out between the English and French in India. The capital of the French possessions was Pondicherry, which

had dependent on it three factories, one at Mahé on the Malabar coast, one at Karikal on the Coromandel coast, and one at Chandernagore in Bengal. The contest in India, though conducted with great energy and ability by Dupleix and Bussy on the part of the French, and by Laurence and Clive on the part of the English, led at that time to no important results, but was renewed in 1756. In that year Surajah Dowlah became subahdar or viceroy of Bengal, and, having always disliked the English, soon found a pretext for making war upon them. Commencing hostilities suddenly, while the English were yet unprepared, he captured Calcutta; and the English portion of the garrison of Fort William, amounting to 146 persons, of whom Mr. Holwell was the chief, were shut up in the "Black Hole," where all but 23 of them perished in a single night by suffocation. (See BLACK HOLE.) Clive soon retook Calcutta with a force from Madras, captured Chandernagore and its French garrison, and after various other successes defeated the subahdar's army in the decisive battle of Plassey, June 23, 1757. In the Carnatic the French were completely defeated by the English on Jan. 22, 1760, in the battle of Wandiwash. After Plassey Surajah Dowlah was dethroned and put to death, and his vizier Meer Jaffier raised to the vacant throne. The new sovereign granted to the English, as the price of their support, an immense sum of money, a large accession of territory, and permission to keep such of the French posts and factories as they could conquer. These transactions involved the English in a war with the emperor of Delhi, and with his vassal the nawaub of Oude. Both the emperor and the nawaub succumbed after a brief contest, and by the treaty of peace the emperor ceded to the British the provinces of Bengal, Behar, and Orissa, together with the maritime districts known as the Northern Circars. The real sovereign of the Northern Circars was a potentate called the nizam of the Deccan, who gave to the emperor of Delhi only a nominal allegiance. At first the nizam declined to acquiesce in the cession, but subsequently he consented to it on condition that the English should aid him with troops against Hyder Ali, the warlike and politic sovereign of Mysore. In the war that ensued the English, notwithstanding some successes, were so hard pressed that they sought to stop the progress of Hyder by negotiation, and at last concluded, in April, 1769, a treaty with him which resulted in a mutual restitution of conquests. In 1772 Warren Hastings assumed the administration of the East India company's affairs in Bengal, and in 1774 received the title of governor general, being the first officer so designated. In return for the cession of Benares, he furnished troops to aid the nawaub of Oude in the subjugation of Rohilcund. The first war with the Mahrattas soon broke out, and considerable conquests were made, which were nearly all given up by a

peace hastily concluded with them. In consequence of the breaking out in 1780 with Hyder Ali, who died Dec. 7, 1782, the war yet raged, leaving his kingdom to his son Tippoo Sahib, who in 1784 agreed to a treaty of peace. In 1781 Hastings aided the nawaub vizier of Oude, then deeply in debt to the Bengal government, in exacting from the rajas or princesses of that state at least £100,000 of the apanages which had been granted to them for their maintenance on the occasion of the vizier's accession in 1756. Having succeeded as governor general in 1785, J. McPherson in 1785; but before he returned for England he caused the nawaub to surrender most of the amount extorted from him. In December, 1789, Tippoo again became involved in war with the English by invading the kingdom of Travancore, which was under their protection. Lord Cornwallis, so conspicuous in the history of the American Revolution, became governor general in 1786, and conducted the contest with energy, that in 1792 Tippoo was compelled to agree to a treaty by which he ceded to the English about half of his dominions, worth them £3,300,000 in money. Sir John Dalrymple, afterward Lord Teignmouth, became governor general in 1793, and in 1798 was succeeded by the earl of Mornington. In the reign of Tippoo was incited by emissaries of the French republic, then engaged in hostilities with Britain, again to make war on the British. This resulted in the storming of his capital, Seringapatam, and his own death in the city on May 4, 1799. His dominions were divided between the English and their ally the nizam of the Deccan. The earl of Mornington was created Marquis Cornwallis in recognition of his successful administration. In 1803 a war broke out between the English and the Mahrattas, which proved to be the most serious ever waged by them. It was conducted by Gen. Lake and then by Gen. Wellesley, afterward the duke of Wellington, and by the brilliant success of these commanders was terminated in December, 1817, by the destruction of the Mahratta power and the vast acquisition of territory by the British East India company. In consequence of border outrages, war was declared against the state of Nepal in 1814, which resulted in the further augmentation of British territory. The same result followed the war of 1817 with Holkar, the peishwa, and other powers in which the Mahratta power was finally subdued. Much trouble at this period was experienced in central and southern India from a formidable force of mounted marauders called Pindarries, who acted as allies of the Mahratta chiefs, and were defeated by the British. A war with the Burmese in 1824-'5 led to the acquisition of territory on the eastern coast comprising Assam, Aracan, and Tenasserim. The Afghan war, which began in 1839, proved a great disaster to the English arms, but was deemed by subsequent successes, terminated by the

withdrawal of the British from Afghanistan. The annexation of Sind in 1843 was owed by the wars with the Sikhs, who had organized into a powerful military state their great sovereign Runjeet Singh. Hostilities began in 1845, six years after his death, and finally resulted in the annexation of the Punjab by the English in 1849. A second war with the Burmese terminated after a short contest, in December, 1852, with the acquisition of the extensive province of Pegu. In 1856 the kingdom of Oude, which had for many years been in a state of confusion, was added to the British dominions on account of its extreme and scandalous misgovernment. From 1805 to 1855 the governors general of India, with the respective dates of their accessions, were as follows: Marquis Cornwallis, 1805; Sir G. Barlow, 1805; earl of Minto, 1807; Earl Moira (marquis of Hastings), 1813; Lord Amherst, 1823; Lord W. Bentinck, 1828; Lord Auckland, 1835; Lord Ellenborough, 1841; Sir H. (Lord) Hardinge, 1844; Earl of Dalhousie, 1848; and Lord Canning, 1856. The next important event was which attracted the attention of mankind in all quarters of the globe, and forms unquestionably the most impressive incident in the history of British India. This was the great Sepoy revolt. The year 1857-58 was the Hindu year Sambat 1914, in which fell the centenary of the battle of Plassey; and Hindoo astrologers had long predicted that in this year the rule of the East India company would terminate for ever. In the early part of 1857 it became apparent that a mutinous spirit had taken into the Bengal army. The military authorities had resolved to arm the sepoys with field rifles, and a new kind of cartridge, used in order to adapt it to the rifle bore, was introduced into many of the schools of military instruction. A report spread among the native troops that, as the cartridges in load were to be torn with the teeth, the government was about to compel them to bite the fat of pigs and of cows, the former of which would be an offence to a Mussulman, and the latter would be sacrilege in the eyes of a Hindoo. The excitement prevailed for a time, but the intervention of the old for the new cartridges finally prevented an outbreak. Meanwhile, though the greased cartridges had not been used elsewhere, the cry of danger to caste was raised in many other stations. Disturbances occurred on Feb. 19 at Barrambuck, and on March 29 at Barrackpore, where the first act of the revolt was shed, the leader in the latter being a private sepoy in the 34th native regiment, named Mungul Pandey; and April 24 at Meerut. On May 10 a formidable rising took place at the latter station. The Europeans were massacred, and the mutineers marched to Delhi, where the garrison fraternized with them, and a second butchery was committed. The rebels proclaimed the restoration of the Mogul dynasty, and thenceforth acted in the name of

the king of Delhi, though without much deference to his orders. The king thenceforward took an active part in the revolt, and Delhi became a rallying point for the mutineers from other quarters. In the Northwest Provinces risings took place almost simultaneously at Allypore, Boolundshahur, Minpore, Shahjehanpore, Etawah, and Bareilly. The sacred city of Benares on the Ganges was in revolt on June 4, and on the next day at the military station of Cawnpore several thousand sepoys revolted and placed themselves under the command of the Nana Sahib, rajah of Bithoor, and on June 27 the terrible massacre at Cawnpore took place. (See BITHOOR, and CAWNPORE.) About the same time the ferocious ranees (princesses) of Jhansi in Bundelcund took the field at the head of two regiments which mutinied at Jhansi June 4. In the course of June and July Jounpore, Allahabad, Futtehpore, Nowgong, Bandah, Mozuffernugger, Agra, Jhylum, Saugor, Sealkote, Segowlie, Dinapore, and Ramgurbh became the theatres of commotion, and in many instances of massacre. In the recently annexed kingdom of Oude, from which a large proportion of the sepoys in the Bengal army had been recruited, the rising, which elsewhere was purely military, partook of the character of a popular insurrection, the people generally favoring and assisting the rebels. The native troops at Lucknow, the capital, mutinied May 30 and 31, and nearly every sepoy regiment in Oude soon followed their example. The troops proclaimed allegiance to the ex-king of Oude, and gradually closed around Lucknow, where they began to besiege the Europeans about July 1. The Punjab was saved by the administrative capacity of Sir John Lawrence; a few risings took place, but the rebels were nearly all cut to pieces, and the suspected regiments seasonably disarmed. The presidency of Bombay was but little disturbed, and that of Madras was tranquil with scarcely an exception. Lower Bengal was also comparatively quiet, the insurrection assuming the most serious aspect in Behar, Rohilcund, Bundelcund, the Doab, Malwa, Rajpootana, and Oude. The two principal Mahratta chiefs, Sindia at Gwalior and Holkar at Indore, remained faithful, but the revolt of their respective contingents was one of the most serious disasters to the British during the war. In May, 1857, the Bengal army comprised 22,698 Europeans (including the officers of native regiments) and 118,663 natives. The native force was disposed in 167 regiments and irregular corps, of which by the end of December 76 had mutinied and 27 had been disarmed or disbanded. As soon as the revolt broke out the British made strong efforts to suppress it; but the resources of treachery, the paucity of European troops, and the absence of means of transport gave the rebels an immense advantage. In a number of instances, mutineers detected or captured by the British garrisons were executed by being blown away from the mouths of cannon. Gen. the Hon. George

Anson, the commander-in-chief, died May 27, 1857, soon after taking the field, and was succeeded provisionally by Sir Henry Barnard. The first movements were against Delhi, which was stormed Sept. 14, after a siege of three months, which was conducted successively by Gens. Barnard, Reed, and Wilson. The troops entered the city, and occupied a part of it on the first day, but did not subdue the last stronghold until Sept. 20. The king was captured and ultimately sentenced to perpetual exile, but most of the rebels escaped. Two sons and a grandson of the king were made prisoners a short distance outside the city by Capt. Hodson, who shot them all with his own hand. Meanwhile Gen. Havelock, having collected a small force at Allahabad, moved toward Cawnpore, where more than 200 women and children, who had escaped the previous massacre, were cruelly put to death, July 16, shortly before he entered the city. He followed the Nana Sahib to Bithoor, defeated him, and, having been joined by Gens. Outram and Neill, crossed into Oude to relieve Lucknow, where Sir Henry Lawrence, the chief commissioner of Oude, had died of a wound on July 4, and the garrison under Col. Inglis was now reduced to extremities. He fought his way into the city Sept. 25, Gen. Neill being killed in the action; but beyond an accession of numbers his arrival did not benefit the besieged. Sir James Outram assumed command, and their condition remained unchanged until Sir Colin Campbell, who had arrived in India Aug. 14, with the rank of commander-in-chief, relieved them, Nov. 14-19, and enabled them to withdraw to Cawnpore. Gen. Havelock died Nov. 24. On Dec. 6 Sir Colin Campbell defeated the Nana Sahib with 25,000 rebels at Cawnpore, and, making that city a centre of operations, proceeded to attack the rebels of the Northwest Provinces in several quarters at once, with a view of driving them into Oude, where a combined movement could subsequently crush them all together. The brigades of Lugard, Hope Grant, Sir Hugh Rose, Roberts, Steuart, Showers, Stuart, and others, did good service in the disturbed districts, and Gen. Outram continued to hold the Alumbagh fort near Lucknow, which had not been evacuated with the city. By Jan. 1, 1858, 23 European regiments had arrived at Calcutta, besides those which landed at Madras and Bombay; the Nepaulese chieftain Jung Bahadoor furnished a valuable subsidiary force of Gorkhas, the Sikhs were enlisted, and Lawrence was able to supply troops from the Punjab. Lucknow was gradually retaken by Campbell and Jung Bahadoor (March 2-21), and the army which had been concentrated for this purpose was then broken up into detachments for service in Rohilkund and other districts. Sir Hugh Rose, with a detachment from the Bombay army, stormed Jhansi, April 2, and pursued the ranees or chieftainesses and the noted rebel leader Tantia Topee to Cal-

pee, where he defeated them, and Gwalior, which had now become hold of the mutiny, as Delhi had been before it. Gwalior was taken after the ranees had been killed. The last great battle of the campaign, rebels, headed by the Nana Sahib of Oude, Tantia Topee, Maun Sirroze Shah, a prince of the house, maintained an obstinate resistance 1858-'59. Though repeatedly taken in the field, they always escaped destruction in another quarter. Oude was finally pacified, however, in the month of Feb. 1, 1859, Sir Colin Campbell's services had been recognized by the grant upon him of a peerage, under the title of Lord Clyde, declared the campaign to be successful. The whole population was decimated in the course of the spring and summer, being destroyed and 1,367,406 persons of all kinds surrendered. Tantia Topee was tried by court martial, and a large number of Europeans massacred in the battle during this mutiny no army can be formed. Hundreds of Europeans and children were put to death in various outrages, many stories of which are fictions or exaggerations, though there is a substantial truth of the accounts of the cities cannot be doubted. The result of the English in punishing the rebels in many cases almost equally shocking, an important result of the mutiny was the transfer of the government of India from the India company to the direct authority of the British crown. This was accomplished by an act of parliament, providing for the re-organization of the system of administration which had been continued by Lord Canning, who had continued the whole mutiny, resigned, and Lord Elgin succeeded him; the viceroy died in the following year, (subsequently Lord) Lawrence was appointed. A badly conducted war with Boor was the result of territorial disputes, was the most important event of 1864 and 1865; its result was very satisfactory to the British. The deficient rainfall of the previous year had caused a famine in Orissa which was believed to have caused the death of many persons. Sir John Lawrence was appointed in 1868 by the earl of Mayo, who was then a prisoner at Port Blair, in the islands, while on a visit to the islands there, Feb. 8, 1872. No political party appeared to attach to the crime. Lord Northbrook, is the present viceroy (1874). The resources of the country have been severely taxed by the famine with which Bengal was the consequence of the lack of rain in 1876. The annual "Statement exhibiting the Material Progress and Condition of the Empire" which has been furnished to the authority of the secretary of

1864-'5, and the various official publications of the Indian government itself, are principal sources of recent statistics concerning the country. A complete general account of a single province, such as the statistics designed to obtain of every part, is contained in "Orissa," by Dr. W. Hunter (2 vols. 8vo, London, 1872). The following are noteworthy among the numerous historical and political works relating to India: "History of British India," by James Mill, continuation by Wilson (9 vols. 8vo, London, 1817-18); "History of India," by Mountstuart Elphinstone (5th ed., 1866); "History of British Empire in India," by Edward Gibbon (6 vols., 1842-'5); Wilkes's "History of the Mahrattas," by James Grant Duff (3 vols. 4to, 1810-'17); "History of the Mahrattas," by James Grant Duff (8vo, 1826); "Memoir of Central India," by Sir John Malcolm (2 vols., 1832); "History of Lord Clive," by the same (3 vols., 1832); "History of the British Empire in India from the Appointment of Lord Hardinge to the Death of Lord Canning," by Lionel J. Lincoln (2 vols., 1866); "The Administration of the East India Company," by J. W. Kaye (2 vols., 1869-'70); "Lives of Indian Rulers," by the same (2 vols., 1867); "India," by Major George Chesney (1868); "History of Rural Bengal," by W. W. Hunter (2 vols., 1872); "Life of Sir Henry Lawrence," by Sir Herbert Edwardes and Herman Merivale (2 vols., 1872); "The Administration of India from 1859 to 1868," by J. T. Prichard (2 vols., 1869); and "History of the Addition of Lord Ellenborough," by Lord Ellenborough (1874). A concise account of the history is contained in "A Student's History of the History of India," by Meadows Taylor (12mo, London, 1870). In Alexander Cunningham's work on the ancient geography of India (vol. i., London, 1870) is an elaborate description of the earlier divisions of the country. For an account of the botany of India see the "First Book of Indian Botany," by Prof. Daniel Oliver (16mo, London, 1870), where it is stated that there is no good general botany of India. A list of the mammalia of India S. of the Himalaya is found in Blyth's "Catalogue of Mammals in the Museum of the Asiatic Society," extracted into Andrew Murray's "Geographical Distribution of Mammals" (4to, London, 1866). As to Indian natural history, see "Wanderings of a Naturalist in India," by Leith Adams (Edinburgh, 1867), and "History of the Highlands of Central India," by Capt. G. H. G. (London, 1871).

**4. Races and Languages of India.** The population of India, without special reference to the invaders who have preserved their original characteristics and imposed their own institutions, may be divided into Aryans and Dravidians. The testimony of history and the evidence of Sanskrit literature seem

to establish that the Aryans invaded the land earlier than 1500 B. C. from a N. W. direction, being the kin of the Iranian or Persian races. They first became possessed of the Punjab, and through long ages of warfare advanced ultimately to the lower course of the Ganges. There is no doubt that the original population was in a great measure Dravidian, though, as Huxley says, whether it was already mixed with a Mongoloid element from the north-east or not does not appear. Thus, ethnologically considered, the Aryan races of India form the most eastern branch of the Aryan or Indo-European family of mankind, and the Dravidians or aboriginal races are a group either entirely distinct, or more or less remotely related to the Mongolians or Turanians. Comparing the former with the latter, it is found that constant commingling has rendered them almost undistinguishable; and judging from physical characteristics alone, disregarding the totally distinct forms of speech, both divisions are to all appearance nearly the same. They are rather small, lithe, delicate, and mostly of a yellowish complexion. The aristocracy among them, however, are almost white, and the Deccanese nearly brown. The hair is long, straight, and black; the eyes are black and shaded by long eyelashes; the ears are well formed; the mouth is not very large; the lips are thin; and the hands and feet are small. The various classes of the Aryan population are enumerated as follows by Sherring and Campbell: *a*, Brahmans, originally priests, now of diverse avocations; *b*, Jats, agriculturists; *c*, Rajpoots, originally the conquerors of western India, now agriculturists; *d*, Koorbees or Koonbees, likewise agriculturists; *e*, Goojars, mostly shepherds; *f*, Aheers, shepherds; *g*, Gwalas, shepherds; *h*, Khatrees, tradesmen; *i*, Banyans or Baniyas, merchants; *j*, Kayasth, secular scribes; *k*, Parblu, clerks; *l*, artisans; *n*, helots, in part rendering menial services, and in part leading a nomadic life.—The Cashmerians are probably the best representatives of the early Hindoos; the bulk of them are now Mohammedans, but all who have adhered to their own faith are Brahmans. In the western hill country are the Mahratta Brahmans, who are mentally and physically very similar to the Cashmerians. Further south, along the slopes of the Ghauts, are Brahmans who follow agricultural pursuits. They are not as numerous on the upper Ganges as in the lower Doab; they are numerically strong in their famous seat Kashee or Benares. Beyond Benares is a race of bastard Brahmans called Bamuns or Bhabuns. Brahmans are the dominant people in Behar and the adjacent countries, and also in the furthest east of Bengal. The Cingalese or inhabitants of Ceylon are in many respects like the Bengalese. They are supposed to be a mixed race, descendants of the aboriginal inhabitants and of an ancient Brahmanical emigration from Bengal. The Khatrees of the Punjab are supposed to be descendants of the ancient Kshatriyas; they are



few in number, but they are intellectually and physically fine men; and it has been said, "Name a distinguished Hindoo, and there is a very great probability that he will turn out to be a Khatree." They are now principally engaged in mercantile pursuits in the Punjab. Although the Rajpoots are now quite Hindooized, it is not generally supposed that they are of a pure Hindoo origin; they have no tribal or caste name, Rajpoots being a title, signifying "sons of rajahs," and their other appellation of Thakoors signifies "chiefs." They were probably in former times in possession of the Punjab, but they have been submerged there by the advancing Jats. A Rajpoot tribe called Dogras still possess the lower hills to the north, and their chief is now lord of Cashmere. The Gangetic basin is the great Rajpoot country of history, and they are still very numerous there. They have never actually conquered the aboriginal people, but Rajpoot families have by mere force of character established themselves as chiefs over many of the hill tribes, and, adopting a feudal system similar to that which once prevailed in Europe, they now rule all the races of Rajpootana. The Jats probably arrived in the country later than the Rajpoots; they seem to have entered by the Bolan pass in the north, where some of their people settled among the hills, and have thence gradually overspread the whole country. They are extremely robust and warlike, excellent subjects, admirable agriculturists, and good revenue payers. Physically there is no finer race in India; they are tall and strong, with fine features, fine teeth, and very fine beards. In their institutions they are democratic, and every village is a complete little republic. Most of the remaining modern divisions may be described as mixed, though Aryan features and institutions prevail among them. The Koorbees or Koonbees are a great agricultural race, occupying large parts of Guzerat, and scattered to some extent over the whole Mahratta country. It is difficult to understand how the quiet and unwarlike Mahratta cultivators could ever have been the warlike people so famous in recent history. It seems, however, that the hardy military Mahrattas came exclusively from the S. W. parts of the country, where they had largely mixed with the aboriginal tribes of the Western Ghauts. The ruling Mahrattas of Nagpore come from the Sattara country. The remainder of the Mahratta armies were made up of adventurers of every caste and creed. In this they differed from the Sikhs, whose forces were mainly their own free people, the Jats. Other Aryan races are probably represented by the more pastoral or cowherd tribes; they are the Goojars of the north, the Aheers of Hindostan proper, the Gwalas of Bengal, and the Goordes of central India. The last three are of a type less alloyed than that of most tribes. Local tradition and general consent attribute to them the old ruins and remains of former greatness so common in this part of the

country, and the curious cairns and stone circles are also supposed to have been erected by them. In every part of India, and forming an essential part in the social structure, are found helot races among the free; they are not slaves, but politically and socially they are the lowest class of subjects. In the Punjab they are the Chooras; in Hindostan, the Choomars; in the Mahratta country, the Mhars. The Chooras are of a fair Aryan type; the Choomars generally have round faces, small features, and dark complexions, and possess only a very slight infusion of aboriginal blood; in the Mhars, and in some of the lower castes of Bengal, the aboriginal features are more decidedly represented. A very remarkable race are the traders known as Banyans, Banees, Wancees, Baniyas, Bunneahs, or Bunijugas; they form an important class of the population of the western countries of India. The Northwestern Provinces are in respect of commerce entirely in their hands; Guzerat, Malwa, and the Bombay district are full of them, and they are numerous also in the Canarese country. They are famous for their trading acuteness. It is supposed that the Jains also belong to the Banees caste; they are a mercantile body, and conduct almost exclusively the entire banking business of India.—The name of the Dravidians or Dravidas, who are considered to be the aborigines of India, is derived from *Dravida*, the Sanskrit name of the southern portion of the peninsula. The native Sanskrit lexicons define a *Dravida* as "a man of an outcast tribe, descended from a degraded Kshatriya." The term *Dravidian*, therefore, seems to have been applied by the Aryan invaders to the inhabitants of southern India at a very early period, probably about the 6th century B. C. They may also be divided into Kols or Mundas, inhabiting the northern districts, Dravidians proper or those of the south, and Cingalese or inhabitants of Ceylon. The Brahmoes of Beloochistan are a Dravidian race. Hodgson designates the Dravidians proper as Tamulians. Campbell has given to the northern Dravidians the name of Kolarians, from the name Kolar by which India was known in ancient times. The term *Kol* is specially applied to the non-Aryan inhabitants of the hill country of Chota Nagpore, Mirzapoor, and Rewah. Mundas is used instead of *Kol* by other authorities, as the Mundas were the prior occupants of this region. To the Kols or Mundas belong the Santals, Singhbhoos, Kols, Ramoosees, Bheels or Bhillas, Kolees, and other tribes. To the Dravidians proper belong the Tamils, Telugus or Telingas, Canarese, Malayalas, Gonds, Kollis of the Rajmahal hills, and many others. The Santal or Sonthal tribe appears to be very widely spread; it is found in Chota Nagpore and in the skirts and valleys of the Rajmahal hills; according to Capt. Shawell, its range is from Cuttack through Chota Nagpore to Rewah. The Kols in the Singhbhoom district are termed *Lurka Kols*. The tradition among the people is that they

originally from Chota Nagpore, and are descendants of the old Mundas of that district; they have also the same cast of countenance as the Mundas, though perhaps with a wilder and fiercer expression. The Ramooses tribes are spread over the central and western parts of the peninsula, and are partly predatory. The Bheels, as a distinct tribe, are found chiefly on the hills surrounding the fortress of Asirgurh in the Central Provinces. The Bheels of Berar occupy the eastern slopes of the Gawilgur range to its western extremity and reaching far into Candeish. The same people are also in possession of the eastern part of the Western Ghauts, and all the branches that run out from it toward the east as far south as Poonah; they have even spread over the plains to the east, especially north of the Godavery, and the neighborhood of the Wurda. Latham says that the Bheels seem to have been the aborigines of the hills near Mount Aboo, but at some time or other they mixed with marauding Rajpoots from the plains, and with the workmen who were so long engaged in building the Dilwarra temples. The Kolees are a numerous race on the western side of India, being the laborers and low cultivators in Guzerat; they are also in large numbers in the western part of the Nizam's Dominions. Kolee is also the name given to the lower class of cultivators in the Simla hills. The same race is scattered over a great portion of the Bombay presidency, from the Thur and the neighborhood of Sinda southward to Goa and eastward along the banks of the Beema, the Kistnah, and Tumbuddra, into the centre of the peninsula as far as Kurnool, where they act as ferrymen. The Kolees and Bheels seem to have a similar if not a common origin. In some portions of India they are mixed, and Kolees frequently marry Bheel wives. The most important race of the Dravidians proper are the Tamils or Tamula, and the name of Tamulian is sometimes used for the whole Dravidian group. Their number is estimated at 10,000,000; they inhabit principally the extreme southeast of the peninsula and S. and E. Ceylon. They are dark brown, very small, lithe, active, social, and more given to seafaring and emigration than any other Indian race. They wander along the coast and to remote islands for employment, and have given the name cooly (Tamil, *kuli*, hire) to the whole class of Indian laborers. The Telugu or Telinga people are estimated at about 14,000,000; they inhabit the eastern borders of the peninsula. They are a taller and fairer race than the Tamil, and equally energetic, though less industrious. They are the Andhra of Sanskrit writers, a name mentioned by ancient Greek geographers as that of a nation dwelling on or near the Ganges. They are good farmers, and many of them were formerly seafaring men, undertaking long voyages. They held at one time large islands in the eastern archipelago, where the people of India are still called *ling* from the former Kalinga dynasty. The

people called Canarese are about 5,000,000 in number, and are found chiefly in the centre of the peninsula. They are a tall and singularly graceful race. Their avocations are mostly those of civil life, cultivators and shopkeepers. People speaking Canarese are spread over the plateau of Mysore and the western districts of the Nizam's Dominions, extending as far north as the neighborhood of Beder. The Kotar, who speak a dialect of Canarese have seven villages in the vicinity of Kotalgherry, and are supposed to number a little more than 1,000. Dead cattle and carrion of every kind find acceptance among them as food. They are, however, the most industrious of the hill tribes, giving much attention to agriculture, and finding employment as carpenters, smiths, basket makers, and menders of ploughs. They are well built, of a tolerable height, rather good-featured, copper-colored, and may be considered among the fairest tribes of this portion of the country. In the low country and along the Western Ghauts, from Cape Comorin to the Chandagiri river, live a people speaking the Malayalam or Malealam language. These inhabitants of Malabar, who probably number about 2,500,000, have from their situation in the extreme southwest been little exposed to external influences. They are of an exclusive disposition, avoid contact with foreigners, and live isolated with their families in their high-walled *parambu*, even where the enterprising Tamil people have opened lines of communication. The race speaking the Tulu or Tuluva tongue live in a small tract of country in the vicinity of Mangalore, and probably number no more than 150,000. Malayalam and Tulu are considered to be in a gradual course of extinction. The Toda, properly Tuda or Tudavera, are a primitive tribe hardly 500 in number, occupying the Neilgherry mountains in the southern part of the Indian peninsula, and commonly believed to be the aboriginal inhabitants of these hills. Logan styles their physical appearance Indo-Semitic. The Kotar tribe ranks next to the Toda in priority of occupation of the hills, but the Badakar, also called Budugur, Budaga, and Vadakar, are the most numerous. The other tribes on these hills live in isolated communities, but the Badakar dwell in villages with streets running in parallel lines, and in thatched houses built of stone and mud, and divided into separate compartments, but strangely enough with no other opening than a doorway about 40 inches high and 25 broad. The Badakar is smaller in stature and lighter in complexion than the Toda. The district of Coorg is inhabited by about 40,000 natives called Koodaga. They are a tall, muscular, somewhat civilized and intelligent race. The Coorgs divide themselves into Coorgs and Amma Coorgs. They have a fair complexion, and wear whiskers and mustaches, but never a full beard. A very important aboriginal tribe is that of the Gonds. (See Gonds.) Mr. J.

Murphy estimates the aboriginal tribes of the northeast at about 300,000, those of central India at about 7,000,000, and the hill tribes of northern India at about 700,000.—Altogether the population of India comprises more than 50 different races, and is characterized by the greatest diversity of appearance, manners, language, and religion. In 1871 the British-born inhabitants, exclusive of soldiers, numbered 64,061. The main division of the native people as to religion is into Hindoos, who form the bulk of the population, and Mohammedans, of whom the estimated number in the entire country is 40,000,000. There are also several millions of Buddhists and about 20,000 Parsees. The Mohammedans are chiefly found in the plain of the Ganges, where for several centuries they held dominion as conquerors and masters of the country, until their power was overthrown by the English. They entered Hindostan in the beginning of the 11th century from Afghanistan, and their numbers were swelled by successive invasions for several centuries afterward. In character the Mohammedans are distinguished from the Hindoos, and especially from the Hindoos of Bengal, by greater energy and frankness, by pride and arrogance, and by their luxurious and dissolute habits. They are of a hasty, revengeful, and fanatical disposition, and do not submit with patience to the domination of their English conquerors. The Parsees are but little darker in complexion than the inhabitants of the south of Europe. They are descendants of the ancient fire worshippers, who fled from Persia several centuries ago in consequence of persecution by the Mohammedans, and are now numerous in Bombay and in some other cities in western India. They form an intelligent, enterprising, and prosperous portion of the native population. The Sikhs, a peculiar religious sect, are numerous in the northwest, and have acted an important part in the history of India. After an existence of 400 years, their numbers are only estimated at from half a million to a million. (See SIKHS.) The estimated number of Jews in India is 10,000; some of those who inhabit Malabar have perfectly black complexions. There is also a large body of native Christians in Malabar, who are believed to be descended from converts made at a very early period of our era. (See CHRISTIANS OF ST. THOMAS.) The native Protestant converts to Christianity in India probably exceed 250,000; and according to a statement prepared for the council of the Vatican in 1870, there are 1,076,102 Roman Catholics in India. The number of Christians in the provinces directly subject to British control is 197,880, according to the latest enumerations, which were made from 1867 to 1872 inclusive. For special accounts of some other classes of the people of India, see FAKIRS, PARIAS, and THUGS. For an account of the division of the people into castes, see INDIA, RELIGIONS AND RELIGIOUS LITERATURE OF.—

LANGUAGES. The early Aryan invaders spoke a language which has been preserved in the Vedas, and which bears the name of Sanskrit (*sanskṛta*, perfect), as it is considered to be the most cultivated and perfected. (See SANSKRIT.) When this language came to be specially used for literary purposes, colloquial speech soon departed from the standard which was set up for it. It is probable that even in the most remote historical age of the Aryan people different tribes were characterized by dialectical differences of speech. These uncultivated forms of the language received from the Hindoos the name of Prākṛit (*prakṛti*, nature), in distinction from Sanskrit. Prākṛit is therefore the general term for the various dialects which arose during the centuries immediately preceding our era. The rock inscriptions of King Asoka, which record names of Greek princes of about 200 B. C., and the legends on the bilingual coins of Bactria, are written in this language. It also plays an important part in ancient Hindoo dramas; for while the heroes speak Sanskrit, the women and attendants use various forms of the popular dialects, which again appear more or less regular, or like the literary language, according to the rank of the speaker. In course of time it became customary to put the same dialectical variation always into the mouths of certain classes of the population. Whether these dialects were used on the stage in imitation of the real speech of the people, and whether they were strongly intermixed with Sanskrit in order to make them more easily understood by the public, cannot be decided. The rise of Buddhism, which was mainly a religion of the people, rendered one of the popular dialects spoken by Buddha himself of special importance. This Prākṛit language is called Pāli, but the precise meaning of this word is not known. Pāli has long ceased to be spoken, but is still used in the Buddhist scriptures of Ceylon, Burmah, and Siam. "Prākṛit," says E. B. Cowell, "almost always uses the Sanskrit roots; its influence being chiefly restricted to alterations and elisions of certain letters in the original word. It everywhere substitutes a slurred and indistinct pronunciation for the clear and definite utterance of the older tongue." All the modern Sanskrit idioms of India are related to the Prākṛit dialects, and they differ from the ancient mother tongue rather in grammatical forms than in roots and themes. Fr. Müller classifies them into groups. The eastern group comprises Bangal or Bengalee, the language of the province Bengal, Assami or Assamese, and Oriya. To the northern group belong the Nipālī or Nepālī, the language of Nepāl, Kaçmirī or Cashmirī, and Panjābī or Punjaabee, the language of Punjaub. The western group embraces the Dhi, which is spoken in the valley of the Indus, the Multanī, and several minor idioms. The central group includes the Hindi, the language of the native Hindoo population of

al portion of northern India; Urdu, also Hindústáni, an offshoot of Hindi, the language of the Mohammedan population of the whole of India, and spoken by all the cultivated classes of the peninsula; and Dakhaní, a language of the southern peninsula, also a Hindi dialect. The southern group comprises Guzaráti or Gujarati, the language of Guzerat and the dialects related to it.

The last and southern group is formed by Maráthí.—All these languages with one exception make use of graphic systems different from each other, but in common derived from the old Indic Dévanágarí alphabet, which is an adaptation of the Semitic characters, and especially of the Himyaritic. Urdu Hindústáni, and often also Sindhí, is written in the Arabic-Persian Taliq characters. All these languages possess the same five classes of consonants, corresponding with those of Sanskrit: gutturals, palatals, cerebrals, dentals, and labials. They have also in common the peculiar vowels *e*, *y*, *r*, and *l*, as well as the aspirated. The vowels are *a*, *i*, and *u*, with the diphthongs *á*, *í*, and *ú*; the closed diphthongs *ai* and *au*, and the open diphthongs *ai* and *au*. The following are the four principal alphabetic systems, arranged according to the method of transcription employed at given in Lepsius's "Standard Alphabet" for which see Writing:

*Dévanágarí.*

Sib. and asp.	क k,	ख kh,	ग g,	घ gh,	ङ ṅ.
	च c,	छ ch,	ज j,	झ zh,	ञ ñ.
	ट t,	ठ th,	ड d,	ढ dh,	ण ṇ.
	त t,	थ th,	द d,	ध dh,	न n.
	प p,	फ ph,	ब b,	भ bh,	म m.
Semi-vow-els.....	{	य y,	र r,	ल l,	व v.
	{	उ r,	ह rh,	ळ l.	
Sib. and asp.	स s,	श sh,	ष sh,	ह h.	
Vowels...	{	अ a,	आ á,	इ i,	ई í,
	{	उ u,	ऊ ú,	ए é,	ऐ éi,
	{	ऐ ai,	औ au.		

*Bangálí.*

Sib. and asp.	ক k,	খ kh,	গ g,	ঘ gh,	ঙ ṅ.
	চ c,	ছ ch,	জ j,	ঝ zh,	ঞ ñ.
	ট t,	ঠ th,	ড d,	ঢ dh,	ণ ṇ.
	ত t,	থ th,	দ d,	ধ dh,	ন n.
	প p,	ফ ph,	ব b,	ভ bh,	ম m.
Semi-vow-els.....	{	য় y,	র r,	ল l,	ব v.
	{	উ r,	হ rh.		

Sib. and asp.	म s,	श sh,	ष sh,	ह h.	
Vowels...	{	अ a,	आ á,	इ i,	ई í,
	{	उ u,	ऊ ú,	ए é,	ऐ éi,
	{	ऐ ai,	औ au.		

*Guzaráti.*

Gutt.	ક k,	ખ kh,	ગ g,	ઘ gh.	
Pal.	ચ c,	છ ch,	જ j,	ઝ zh.	
Cer.	ટ t,	ઠ th,	ડ d,	ઢ dh,	
Dent.	ત t,	થ th,	દ d,	ધ dh,	
Lab.	પ p,	ફ ph,	બ b,	ભ bh,	
Semi-vowels.	ય y,	ર r,	લ l,	વ v.	
Sib. and asp.	સ s,	શ sh,	ષ sh.		
Vowels...	{	અ a,	આ á,	ઇ i,	ૈ éi,
	{	ઉ u,	ઊ ú.		

*Arabic of the Urdu.*

Gutt.	ك k,	خ kh,	گ g,	غ gh,	ن n.
Pal.	چ c,	ح ch,	ج j,	جھ gh,	ن ñ.
Cer.	ٹ t,	ث th,	ڈ d,	ڈھ dh,	ن ṇ.
Dent.	ت t,	ث th,	د d,	دھ dh,	ن n.
Lab.	پ p,	ف ph,	ب b,	بھ bh,	م m.
Semi-vow-els.....	{	ی y,	ر r,	ل l,	و v.
	{	ڑ r,	ڑھ rh.		
Sib. and asp.	س s,	ش sh.			
Vowels...	{	ا a,	آ á,	إ i,	آی í,
	{	ا u,	أ ú,	أی ái,	أو ó,
	{	ای ai,	أو au.		

—Bangálí or Bengalee distinguishes the masculine, feminine, and neuter genders, and the singular and plural number. Nouns possess nominative, genitive, dative, accusative, vocative, ablative, instrumental, and locative cases. The mode of declension is as follows: singular—nom. *balad* (বলদ), an ox, gen. *baladér* (বলদের), dat. and acc. *baladké*, voc. *balad*, abl. *baladhaité*, instr. *baladété*, loc. *baladété*; plural—nom. *baladérá* (বলদেরা), gen. *baladérdigér* (বলদেরদিগের), dat. and acc. *baladérdigké*, voc. *baladérá*, abl. *baladérdigété*, instr. *baladérdigété*, loc. *baladérdigété*. Adjectives agree with their nouns only in gender, but not in number and case. The sign of the feminine is *a*, and sometimes *i*. Bangálí is the only modern language of India which

has special forms for the comparative and superlative, and they have been borrowed from Sanskrit. The pronoun of the first person singular is *ami*, plural *amrā*; second person singular, *tumi*, plural *tómra*; third person singular, *sēi*, plural *tāhārd*. The relative pronoun is *yini* in the singular and *yēnārd* in the plural. The first ten cardinal numbers are *ēk*, *dui*, *tin*, *čāri*, *pāc*, *chay*, *sāt*, *āt*, *nay*, and *daç*. No distinction is made between transitive and intransitive verbs. The present participle ends in *-it*, which receives in the present tense an *ē*, making it *-itē*, for euphony. The participle of the aorist ends in *-la*, that of the past in *-ya*. The termination for the future is *-iba*. The different persons are indicated by suffixes. The languages of Assam and Orissa, Assami and Oriya, are closely related to Bangālī. The former, however, has incorporated many elements pertaining to the speech of the neighboring population of Burmah and Thibet, while the latter has a strong admixture of Arabic.—Nipālī or Nepalese, the language of Nepal, also possesses many Thibetan elements. The neuter gender has disappeared; the plural is formed by adding *hēru*, collection, assembly, and the genitive of nouns is considered an adjective, and has an inflection of its own. The general character of the declension may be seen from the following

example: singular, nom. *mānis* (मानिस),

a man, gen. *mānisakō* (मानिसको), dat. *mānisāti*, acc. *mānisakan*, voc. *hē mānis*, abl. *mānisācēvātō*, instr. *mānisācē*, loc. *mānisācēsmā*;

plural—nom. *mānishēru* (मानिसहरू), gen.

*mānishērukō* (मानिसहरूको), dat. *mānishērulāi*, acc. *mānishērukan*, voc. *hē mānishēru*, abl. *mānishērudēvātō*, instr. *mānishērulē*, loc. *mānishērurēsmā*. The pronoun of the first person

singular is *mā*, plural *hāmihēru*; second person singular, *tā*, plural *timihēru*; third person singular, *tun*, plural *tinihēru*. The relative pronoun is *gun* in the singular and *gunhēru* in the plural.—Kāçmirī and Panjābī (Cashmerian and Panjaabee) has embodied many Arabic and Persian elements. Only the masculine and feminine genders are distinguished. Feminines generally end in *nī* or *ānī*. Nouns are declined like the following example: singular—

nom. *ghōrā* (घोड़ा), a horse, gen. *ghōrādā*

(घोड़ेरा), *ghōrādī*, *ghōrādē*, dat. *ghōrādātī*, acc.

*ghōrānū*, abl. *ghōrādē*, instr. *ghōrādē*, loc. *ghōrādē*;

plural—nom. *ghōrē* (घोड़े), gen. *ghōrē*

*rīdā* (घोड़ियाँ), *ghōrīdī*, *ghōrīdē*, dat.

*ghōrīdātī*, acc. *ghōrīdānū*, abl. *ghōrīdē*, instr.

*ghōrīdē*, loc. *ghōrīdē*. The pronoun of the first person singular is *mat*, plural *ast*; second

person singular, *tā*, plural *tast*; third person singular and plural, *si*. The relative pronoun is *gō* both in the singular and plural. Verbs form the present participle by adding *-ant*, and the past participle by *-ta*.—Sindhī has been maintained in a comparatively close relation to ancient Sanskrit, and is of great importance for the investigation of modern Indian forms of speech. This language also has lost the neuter gender. The plural case is not formed in it as in the other languages by adding some word signifying collection or assembly, but by a genuine case ending *ū*, or sometimes *ā*. The genitive case of nouns is also used here as a sort of adjective admitting of special inflection. Declension is generally according to the following example: singular—nom. *maçharu*

(मकर), a goat, gen. *maçharagō* (मकर गो),

*maçharagī*, *maçharagā*, *maçharagū*, dat. and acc. *maçharakhē*, voc. *ē maçhara*, abl. *maçharakhē*, instr. *maçhara*, loc. *maçharāmē*;

plural—nom. *maçhara* (मकर), gen. *maçha-*

*ranigō* (मकरनि गो), *maçharanigī*, *maçha-*

*ranigī*, *maçharanigū*, dat. and acc. *maçha-*

*ranikhē*, voc. *ē maçharō*, abl. *maçharanikhē*, instr. *maçharani*, loc. *maçharanimē*. Adjectives

are put in perfect agreement with their nouns in number, gender, and case. The

pronoun of the first person singular is *āā*, *ā*, or *mā*, plural *ast*; second person singular, *tā*,

plural *tachī* or *tahī*; third person singular, *sā*,

feminine *sā*, plural *sā*. The relative pronoun

is *gō* in the singular masculine, *gō* feminine,

and *gē* in the plural. There are pronominal

suffixes which are probably due to the influence

of the Persian. When added to a noun they

have the force of a genitive. They are: *mā*,

first person singular; *i*, second; *si* or *āi*, third;

*sū*, *sī*, or *ū*, first person plural; *ra*, second; *si*

or *āi*, third. The first ten cardinal numbers

are *hiku*, *ba*, *tē*, *čāri*, *pāga*, *cha* or *chaha*, *sata*,

*aṭha*, *nārā*, and *raha*. The corresponding ordi-

nals are *pērhyō*, *biō*, *tiō*, *čūthō*, *pāgō*, *chahō*,

*satō*, *aṭhō*, *nārō*, and *rahō*. The present participle

of intransitive verbs ends in *ādō*, of transitive

verbs in *ūō*. The past participle is

formed by adding *-yō*. Urdu or Hindustānī is

a dialect of Hindi, whose origin dates back to

the 11th century A. D. It is strongly mixed

with Persian and Arabic, and also to some

degree with Tartaric Mongolian elements. It

is the current administrative language of India,

and spoken by all connected with official

circles. It was called Urdu from its having been

developed in the camps (*urdu*) of the Moslem

conquerors of the country. The best authorities

believe that it did not take form as a specific

variety of Indian speech before the 16th century.

It distinguishes a masculine and feminine

gender, and the latter is generally indicated

by *i*, as *bētd*, son, *bētī*, daughter; *larhā*,

boy, *larhī*, girl; or by *ānī*, *nī*, and *nī*, as *bāgā*,

tiger, *bāghā*, tigress. The plural of nouns in oblique cases is formed by adding *ḥ*; the nominative of masculine nouns remains unchanged if it ends in a consonant or in *ḥ*, but if in *ā* or *āḥ* it receives an *ḥ*. Feminines in *ī* take *ḥ*, others *ḥ*. The sign for the genitive is *ka* masculine, *ki* feminine. This case has also the force of an adjective, and its own oblique cases end in *ke*; as *rājāka bēḥa*, the son of the king; *rājāka bēḥi*, to the son of the king. The form of the other cases will appear from the following paradigm: singular—nom. *ādhi*

(اندها), a blind man, gen. *ādhi* (اندهی), *ādhi*, *ādhi*, dat. and acc. *ādhi*, voc. *ādhi*, abl. *ādhi*, instr. *ādhi*, loc. *ādhi*; plural—nom. *ādhi* (اندهی), gen. *ādhi*

(اندهونکی), *ādhi*, *ādhi*, dat. and acc. *ādhi*, voc. *ādhi*, abl. *ādhi*, instr. *ādhi*, loc. *ādhi*. Adjectives always agree with their nouns in gender and case, but not always in number; as *ādhi* *larkā*, the good girl; *ādhi* *larkā*, the good boys; *ādhi* *larkā*, the good girls. The pronoun of the first person singular is *ma*, plural *ham*; second person singular, *tū*, plural *tum*; third person singular and plural, *so*. The relative pronoun is *jo* in both singular and plural. The first ten cardinal numbers are *ek*, *dō*, *ṭn*, *ḥr*, *pāc*, *ḥah*, *ṣṭ*, *ṭh*, *nav*, *das*. The corresponding ordinals are *pāhā*, *dārā*, *ṭārā*, *ḥauthā*, *pācā*, *ḥathvā*, *ṭhā*, *dēhā*, *navā*, *dasā*. The present participle of verbs ends in *ant*, the past participle in *ā*.—Guzarāṭī or Gujarati distinguishes all three genders. Nouns are declined as follows:

singular—nom. *dēv* (देव), a god, gen. masc. sing. *dēvō* (देवो), gen. fem. sing. *dēvī*, gen. neut. sing. *dēvā*, gen. masc. pl. *dēvā*, gen. fem. pl. *dēvī*, gen. neut. pl. *dēvā*, dat. and acc. *dēvā*, voc. *arō dēv*, abl. *dēvī*, *dēvī*, instr. *dēvī*, *dēvī*, *dēvī*, loc. *dēv*, *dēvā*; plural—nom. *dēvō* (देवो), gen. masc. sing. *dēvō* (देवो), gen. fem. sing. *dēvī*, gen. neut. sing. *dēvā*, gen. masc. pl. *dēvā*, gen. fem. pl. *dēvī*, gen. neut. pl. *dēvā*, dat. and acc. *dēvā*, voc. *arō dēv*, abl. *dēvī*, instr. *dēvī*, *dēvī*, *dēvī*, loc. *dēv*, *dēvā*. The genitive of nouns can thus be employed as an adjective and made to agree in gender and number with the substantive. Adjectives agree with their nouns in gender, number, and case. The nominative singular masculine ends in *ā*, feminine in *ī*, neuter in *ā*; the nominative plural masculine in *ā*, feminine in *ī*, neuter in *ā*. The pronoun of the first person singular is *ah*, plural *amē*; second person singular, *tū*, plural *tamē*; third person singular, *tē*, plural *tō*. The relative pronoun singular is *jo*, plural *jō*. The first ten cardinal numbers are

*ek*, *bā*, *tan*, *ḥr*, *pāc*, *ḥa*, *ṣṭ*, *ṭh*, *nav*, and *das*. The corresponding ordinals are *pāhā*, *bā*, *ṭhā*, *ḥā*, *pācā*, *ḥā*, *ṭhā*, *ṭhā*, *navā*, and *dasā*. The present participle ends in *tō*, *tī*, *tā*. The past participle is formed by *yō*, *tī*, *yā*.—Marāṭhī also distinguishes three genders. Nouns are declined as follows: singular—nom. *dēv* (देव), a god, gen. *dēvō* (देवो), *dēvā*, *dēvā*, dat. and acc. *dēvā*, *dēvā*, abl. *dēvā*, instr. *dēvā*, *dēvā*, loc. *dēvā*; plural—nom. *dēvō* (देवो), gen. *dēvō* (देवो), *dēvā*, *dēvā*, dat. and acc. *dēvā*, *dēvā*, abl. *dēvā*, instr. *dēvā*, *dēvā*, loc. *dēvā*. Adjectives end when masculine in *ā*, feminine in *ī*, and neuter in *ā*, and are connected with their nouns as if they formed a compound word with them. Number and case are indicated only when adjectives are used as nouns. The pronoun of the first person singular is *mī*, plural *amī*; second person singular, *tū*, plural *tumī*; third person singular, masculine *tō*, feminine *tī*, neuter *tē*; plural for the three genders, *tō*. The relative pronoun singular masculine is *jo*, feminine *jī*, neuter *jē*; plural for the three genders, *jō*, but the feminine appears sometimes as *jyā*. The present participle of transitive verbs ends in *it*, of intransitive verbs in *at*. There is another form ending in *tā*. The past participle of transitives ends in *ild*, of intransitives in *ald*.—DRAVIDIAN LANGUAGES. Excepting Cingalese, or Singalese, the language spoken on the island of Ceylon (which, though possessing some points of similarity with the Dravidian languages, is nevertheless treated by several eminent scholars as a language entirely distinct by itself), the Dravidian group must be divided into five sections or languages, to which may be added a sixth, comprising the idioms still imperfectly known and spoken by the races which occupy the innermost parts of the mountainous regions. The Tamil language is the Sanskrit of the whole group. It is spoken mainly in the so-called Carnatic, or the eastern coastland below the Ghauts of Pulicat as far as Cape Comorin, and from the Ghauts to the bay of Bengal. It is heard also in the Western Ghauts and in the northern portion of Ceylon. There are two dialectical variations of it. One is the so-called classic or Sen-Tamil, and the other the colloquial or Kodun-Tamil. The next highest rank must be assigned to Telugu, formerly called Gentoo. It was once spoken as far N. as the Ganges, but now reaches only from Cicacole on the E. coast to Pulicat, and thence as far as Mysore. The next in order, and nearest related to the two preceding, is Canarese, whose territory extends over Mysore and the eastern districts of the Nizam as far as Beder; it is spoken also in the district of Canara, on the Malabar coast. The fourth language is Malayālam or Malayāma, spoken on the coast of Malabar, on the

western side of the Ghats, between Mangalore and Trivandrum. The fifth and least represented language is Tulu or Tuluva, formerly spoken in Canara, now only in the vicinity of Mangalore, and rapidly dying out. The speech of the Todavars, Kotars, Gonds, Koods, and other races occupying the mountains, is expected to show on further acquaintance an intimate relation with these languages. Max Müller considers the Dravidian languages as a branch of the Uralo-Altaic, Mongolian, or Turanian; but Fr. Müller and other great authorities consider them a totally distinct and primitive division of human speech. These languages are written in peculiar graphic systems, which are derived like those of the Aryan languages of India from the Devanagari alphabet, but less directly, coming through the Kistnah and Nerbudda characters. The sounds may be grouped in Tamil as follows:

Tamil.			
	Surd.	Sonant.	Nasal.
Gutturals . . . .	க க,	க ட,	க ற்.
Palatals . . . . .	ச ச,	ச ட,	ச ற்.
Cerebrals, I. . . .	ட ட,	ட ட,	ட ற்.
Cerebrals, II. . . .	த த,	த ட,	த ற்.
Dentals . . . . .	க க,	க ட,	க ற்.
Labials . . . . .	ப ப,	ப ப,	ப ம.
Liquids . . . . .	ய ய,	வ வ,	ர ர,
	ல ல,	ள ள,	ழ ழ.
Sibilant . . . . .	ச ச.		
Vowels . . . . .	அ a,	ஆ a,	இ i,
	ஈ i,	உ u,	ஊ u,
	எ e,	ஏ e,	ஐ o,
	ஓ o,	ஔ au,	ஔ் i.

The cerebrals are pronounced with a decided palatalization. The Tamil characters probably represent the oldest of the south Indian graphic systems. In all the Dravidian languages, but especially in Tamil and Malayalam, there is the peculiar law of beginning with surd sounds every word and syllable following one that is closed; and of beginning with sonants every syllable which succeeds another that is open, or that is closed with a nasal or a liquid sound. Tamil adds to this the difficulty of employing the same sign either as a surd or a sonant, leaving it to the reader to decide how it is to be pronounced. Another difficulty arises from the fact that the Dravidian languages absorbed many Aryan words belonging to different periods of the ancient and modern Indian languages. Some of these words were appropriated without alteration, called *tatsami* by native grammarians, and others have been assimilated with Dravidian forms, called *tadbhava*. As the Dravidian alphabets do not represent

all the Indian sounds, it was found necessary either to invent others, which was done in Telugu, Kannadi, and Malayalam, or to change the words so that the alphabet would suffice, which is done in Tamil. Originally, therefore, the Dravidian languages made use only of the number of characters still employed in Tamil; but at present Telugu, Kannadi, and Malayalam have a system of signs which represent also the sounds of the Aryan languages, and which may be grouped in a similar manner. Canarese characters are similar to the Telugu; hence we subjoin only the latter and the Malayalam:

Telugu.	
Gutt.	క క, ఖ kh, గ g, ఘ gh, ఙ n.
Pal.	చ చ, ఛ ch, జ జ, ఝ zh, ఞ n.
Cer.	ట ట, ఠ ఠ, డ డ, ఢ ఢ, ణ n.
Dent.	త త, థ థ, ద ద, ధ ధ, న n.
Lab.	ప ప, ఫ ఫ, బ బ, భ భ, మ m.
Liq.	య y, వ v, ర r, ల l.
Sib. and asp.	శ శ, ష ష, ష ష, హ h.
Vowels . . .	అ a, ఆ a, ఇ i, ఈ e
	ఊ u, ఊ u, ఏ e, ఓ o
	ఐ o, ఔ o, ఔ au, ఔ i

Malayalam.	
Gutt.	ക ക, ഖ kh, ഗ g, ഘ gh, ങ n.
Pal.	ച ച, ഛ ch, ജ ജ, ഝ zh, ഞ n.
Cer.	ട ട, ഠ ఠ, డ డ, ఢ ఢ, ణ n.
Dent.	ത ത, ఠ ఠ, ద ద, ధ ధ, న n.
Lab.	പ പ, ఫ ఫ, బ బ, భ భ, మ m.
Liq.	യ y, വ v, ര r, ല l.
Sib. and asp.	ശ శ, ష ష, ష ష, హ h.
Vowels . . .	അ a, ആ a, ഇ i, ഊ u
	ഉ u, ഊ u, ഏ e, ഓ o
	ഐ o, ഔ o, ഔ au, ഔ i

These systems enable the Telugu, Kannadi, and Malayalam to give Indian words in their own orthography, while Tamil must transform them according to the necessities of its insufficient alphabet. A sentence is in all the Dravidian languages an absolute whole. The words are closely connected, and the junction of vowels or consonants, vowel and consonant, or consonant and vowel, at the end and beginning of two words, produces various euphonic changes. The accent, however, remains always on the root syllable, which is in all cases the first syllable of a word. The parts of speech may be reduced to only two groups of nouns and verbs. There is hardly what is called a gram-

matical gender, excepting in the pronoun of the third person, which belongs mostly to the verb. Nouns are distinguished, however, as belonging either to the higher or to the lower caste, the one comprising rational and the other irrational beings; men, gods, demigods, spirits, and the like, forming one group, and animals, inanimate objects, and subjective ideas, the other. Singular and plural numbers are distinguished, the latter by means of high- or low-caste suffixes. The former was originally called *mā*, and is now chiefly employed as an honorific plural; otherwise it is reduced to *ar*, *ir*, *ir*, appearing in Telugu and Kannadi as *aru*, *uru*, *ru*, *ri*, *aru*, and *aru*. The latter was originally called *ka* and *ga*, as still clearly seen in Tamil and Malayalam. In Canarese it is *ga*. The cases are indicated by means of suffixes. The declension of nouns is shown in the following examples: 1. *Tamil*. Singular—nom. *rāyā* (ராயா), a king, acc. *rāyāy*, gen. *rāyāyudiya* (ராயையுடைய), dat. *rāyāyukku* (ராயையுக்கு), abl. *rāyānilirundu*, instr. *rāyāṅḍi*, loc. *rāyāṅḍi*, *rāyāṅḍattil*; plural—nom. *rāyar* (ராயர்), acc. *rāyar*, gen. *rāyarudiya* (ராயருடைய), dat. *rāyarukku*, abl. *rāyarilirundu*, instr. *rāyarḍi*, loc. *rāyaril*, *rāyaridattil*. 2. *Telugu*. Singular—nom. *gurramu* (గర్రము), a horse, acc. *gurramunu*, gen. *gurramuyokka* (గర్రమువొక్క), dat. *gurramuku*, *gurramunaku*, instr. *gurramucēta*, loc. *gurramulū*; plural—nom. *gurramulu*, acc. *gurramulanu*, gen. *gurramulu*, dat. *gurramulaku*, instr. *gurramulacēta*, loc. *gurramulū*. 3. *Malayalam*. Singular—nom. *mala*, a mountain, acc. *malay*, gen. *malayut*, dat. *malekka*, abl. *malayilninna*, instr. *malayḍi*, loc. *malayil*; plural—nom. *malakal*, acc. *malakal*, gen. *malakalut*, dat. *malakalukka*, abl. *malakalinninna*, instr. *malakalḍi*, loc. *malakalil*. 4. *Kannadi or Canarese*. Singular—nom. *marata*, a tree, acc. *marata*, gen. *marada*, dat. *maratte*, abl. *maradadesinda*, instr. *maradinda*, loc. *maradalli*; plural—nom. *maragalū*, acc. *maragalū*, gen. *maragala*, dat. *maragalige*, abl. *maragaladesinda*, instr. *maragalinda*, loc. *maragalalli*. 5. *Tulu*. Singular—nom. *mara*, a tree, acc. *marana*, gen. *marada*, dat. *maraka*, instr. *maradda*, loc. *marada*; plural—nom. *marakulu*, acc. *marakuluna*, gen. *marakula*, dat. *marakuluka*, instr. *marakuludda*, loc. *marakuluda*. Adjectives remain always unchanged in the Dravidian languages, and always precede their nouns. Personal pronouns, however, are capable of inflection. The pronoun of the first person singular, nominative, is in Tamil *nāy*, Telugu *nēnu*, Kannadi *nānu*, Malayalam *nān*, Tulu *yān*; plural, Tamil *nām*, Telugu *mēnu*, Kannadi *nām*, *ām*, and *nāru*, Malayalam *nān*, Tulu *namma*. In Sen-Tamil the suffix *gn* is added to produce a pure plural form; hence *nāngal* instead of *nām*. The first ten cardinal numbers in Tamil are *oḡḡu*, *irandū*, *mūḡḡu*, *nālu*, *indu*, *āḡḡu*, *ēlu*, *eḡḡu*, *ḡḡai*, and *pattu*. In Telugu there is no

word for one; the others are *rendu*, *mādu*, *nāluḡḡu*, *āḡḡu*, *aru*, *yēdu*, *yenimidi*, *tommidi*, and *padi*; in Kannadi the ten are *ondu*, *eradu*, *māru*, *nālu*, *āḡḡu*, *aru*, *ēlu*, *eḡḡu*, *om bhaittu*, and *hattu*; and in Malayalam, *onna*, *raṅṅa*, *mānna*, *nāla*, *aṅṅa*, *āra*, *ēla*, *eḡḡa*, *onpata*, and *patta*. The most peculiar constituent of the Dravidian languages is the verb, which is a mere compound of a form of the noun with a personal pronoun. Caldwell says of it: "When case signs are attached to a root, or when, without the addition of case signs, it is used as the nominative of a verb, it is regarded as a noun; the same root becomes a verb without any internal change or formative addition, when the signs of tense and the pronouns or their terminal fragments are suffixed to it." Further on he says: "The structure of the Dravidian verb is strictly agglutinative. The particles which express the ideas of mood and tense, transition, intransition, causation, and negation, together with the pronominal fragments by which person, number, and gender are denoted, are annexed or agglutinated to the root in so regular a series and by so quiet a process, that generally no change whatever, or at most only a slight euphonic change, is effected either in the root or in any of the suffixed particles. As the Dravidian noun has but one declension, so the Dravidian verb has only one conjugation and but very few irregular forms."—Cingalese or Singalese, the language of the Elu, the original inhabitants of Ceylon, incorporated a large number of Pālī and Sanskrit words, while the modern modifications of it are tinged with Malay. (See CINGALESE LANGUAGE.) The Elu alphabet has 34 consonants and 12 vowels. This alphabet may be classified as follows:

Gutt.	ක k, ඛ kh, ග g, ඝ gh, ඛ ñ.
Pal.	ච c, ජ ch, ජ ජ, ඞ gh, ඞ ñ.
Cer.	ච t, ච th, ච d, ච dh, ච n.
Dent.	ච t, ච th, ච d, ච dh, ච n.
Lab.	ච p, ච ph, ච b, ච bh, ච m.
Semi-vow-els.....	{ ච y, ච r, ච l, ච l, ච v.
Sib. and asp.	ච s, ච sh, ච s, ච h.
Vowels...	{ ච a, ච i, ච u, ච e, ච ai, ච o, ච au, ච á, ච í, ච ú, ච é, ච ó.

There is no grammatical gender, though grammarians distinguish between male and female, restricted however to animate beings, and even this is very vaguely applied. Feminines are indicated by the Sanscritic termination *i*, *innī*, or *inna*. The plural is formed either by substituting *o* for the final *a*, or by dropping the final vowel, and further by one of the four affixes



*varu, lā, hu, and cal.* There are eight cases, and nouns are inflected as follows: singular—nom. *purusayā* (പുരുടയ), a man, acc. *purusayā*, voc. *purusayō*, gen. *purusayāgé*, dat. *purusayāta*, abl. *purusayāgen*, instr. *purusayāvisin*, loc. *purusahukerehi* (പുരുടയക്കരേഴി);

plural—nom. *purusayō* (പുരുടയ), acc.

*purusayan*, voc. *purusayeni*, gen. *purusayangē*, dat. *purusayanā*, abl. *purusayangen*, instr.

*purusayanvisin* (പുരുടയൻവിടിൻ), loc.

*purusayankerehi.* This inflection of nouns varies according to the final vowel. Adjectives precede the substantive, and remain unchanged. The comparative is formed by *vaddā, vēdiya, or vēliyen*, and the superlative by *ati* or *itā*, which particles are always prefixed to adjectives. In comparing two objects, the object compared with another is put in the dative. The pronoun of the first person singular is *mama*, plural *api*; second person masculine singular *tū*, plural *topi*; feminine singular *tī*, plural *tīlā*. But there are several other forms of this pronoun in use, which are employed according to the rank of the person addressed. The pronoun of the third person singular is *ohu* or *ū*, plural *ūlā*; the abbreviation *ū* being mainly used in formal discourse. The first ten cardinal numbers are *ēka, deka, tuna, hutara, paha, haya, hata, ata, neyaya* or *namaya, and dahaya*. Ordinals are formed by suffixing *reni*. Verbs are divided into transitives and intransitives, and are distinguished as active and passive. The tenses, of which there are eight, viz., two of the present, an imperfect, perfect, past perfect, and future, are formed by means of participial formatives and auxiliaries. Number and person are indicated merely by the personal pronouns used in conjunction with the verbs.—See *Reise der Norara; Linguistischer Theil*, by Friedrich Müller (Vienna, 1867), and *Ethnographischer Theil*, by Müller and Scherzer (1868); Beames, "Comparative Grammar of the Modern Aryan Languages of India" (London, 1872 *et seq.*); and the journals of the royal Asiatic society of Great Britain and Ireland, and of the royal Asiatic society of Bengal.

**INDIA, Religions and Religious Literature of.** In the present state of uncertainty in regard to their chronological order, it seems advisable to treat the comparatively few monuments of the literature of India with which we have become acquainted in connection with the various periods of the religious history of the country for which they form the sources of our information. The character of the first two periods is depicted in several writings which may be classified as monuments of Vedic and of Sanskrit literature. The first embraces the hymns of the Veda, the Brāhmanas, and

the Sūtras. The Veda-Sanhitās or Veda texts exist in four collections: Rig-Veda, Sāma-Veda, Yajur-Veda, and Atharva-Veda. The Rig-Veda is the largest and most valuable collection. The hymns are grouped in it chiefly according to their asserted authors. They comprise 1,028 *śūkta*, hymns, and 10,580 *rik*, verses, which are divided into 10 *mandala*, circles or books. The Sāma-Veda-Sanhitā is a body of verses culled from the hymns of the Rig-Veda, along with a few others, arranged into forms suitable for chanting. It is supposed to be older than the compilation of the Rig-Veda, as it does not contain any of the verses in the latter which appear to be of a late date. The Yajur-Veda gives the verses and formulas of words to be recited during the progress of the ceremonies attending sacrifice. There are two editions of it, which however differ only in arrangement. The black Yajur-Veda or Taittirīya-Sanhitā gives also dogmatic explanations, while the white Yajur-Veda or Vājasaneyi-Sanhitā contains only the verses of the ritual. The Atharva-Veda seems to be a continuation of the tenth *mandala* of the Rig-Veda; it is a collection of hymns of various date and character, but predominantly superstitious. The Brāhmanas furnish descriptions of the ceremonies prescribed in the Sanhitās, and numerous legends bearing on them; but they are full of repetitions. They have an addendum of philosophical speculations, called *Āraṇyaka*, forest portion, probably from the fact that philosophers generally lived as hermits in the woods. A portion of the *Āraṇyaka* is called Upanishad, session, and contains speculations depicting the Brahmanical system of pantheism. The Sūtras are collections of practical rules respecting matters of ceremony and worship. Such are especially the *Ṣrauta-Sūtras*, or the revealed, while the *Grihya-Sūtras*, or the domestic, seem to be oral traditions giving rules of conduct and general behavior. Sūtras which explain the language, mythology, or astrology of the Vedas are called *Vedāngas*, or members of the Vedas. Those which attempt to analyze the philosophy of the Vedas bear the name of *Vedānta*, or purpose of the Vedas. Linguistically considered, these last belong to the next, or Sanskrit period, distinguished by a later character of the language. Prof. Max Müller divides the interval in which the books enumerated appeared into four periods. The first of these, the Chhandas period, or the period of spontaneous poetic productiveness, he computes to have lasted from 1200 to 1000 B. C., and during that time the most ancient of the Vedic hymns were composed. The second, the Mantra or "sacred formula" period, comprises the next two centuries, and its hymns bear traces of the growth of a sacerdotal spirit and system. The third or Brāhmana period closes at 600 B. C., and the fourth or Sūtra period is assigned to the time subsequent to it, and ending 200 B. C. Prof. W. D. Whitney, however, holds that this chronology

mere conjectural hypothesis, which is hardly entitled even to temporary and provisional acceptance." Among the works going to the Sūtra division are some reckoned the Prāticākhya, which are used explaining the phonetic peculiarities of text of the hymns, and the Anukramanī, which are indices to the texts, and state the metre, theme, length, and metres of each. During the period that Sanskrit graduated to be the national tongue, there must have appeared also a number of works of considerable importance for the history of the country as well as for its religion. These are the Dharmasāstras or books of laws, a number, of which the famous laws of Manu, which the Hindoos still regard as the basis of their public and social law, are probably the oldest. In its present form, from the internal evidence of its opposition to Buddhism, this work is supposed to date from about the 4th century B. C. It lays down the rules which are to guide persons of the various castes in their behavior toward each other, and contains a multitude of cosmogonic speculations. The chief monuments of this age, however, are two long epics or Itihāsas. One is the Mahābhārata, which describes the feuds between the Pāndavas and Kauravas, royal descendants of the Bhāratas. In its present form it consists of more than 100,000 verses or ślokas, of which the best known ones are the Nala and the Bhagavad-Gītā. It places the redaction of this epic between the 5th and 350 B. C., Benfey in the 3d century, Weber in the last two centuries before our era. The other epic is the Rāmāyana, which comprises about 24,000 double verses the deeds of Rāma, a prince of Ayōdhya or Ayōdhya, resulting in the extension of Aryan dominion over the Deccan and Ceylon. Rāma is represented as an incarnation of Vishnu, and his asceticism and hierarchy are dominant features in it. As the Rāmāyana contains allusions to Buddhism, Lassen considers it older of the two epics; but Duncker ascribes it to a later date, as it does not describe an clearly well defined priesthood. It is generally believed that both epics were originally oral traditions; but they are ascribed to special authors. The Rāmāyana is said to have been composed by Kuça and Lava, the sons of its hero, and learned it from the Brahman Vālmīki. Its names were subsequently contracted into Rāmāyana, which came to be applied to any bard or poet. The Mahābhārata is ascribed to Vyāsa, who is said to have been an eye-witness of the events. Vaiçampāyana, his pupil, recited it the first time at the great serpent sacrifice of the king Janamējaya. Sūta Ugraçravas recited it a second time at the sacrifice of Çaudamanyu. The narratives of the Mahābhārata and Rāmāyana are continued by the Purānas, which date of a much later date, and which are written with the interest of religious sects subsequently formed; they must therefore be spoken of

after an account of the earliest forms of the religion of India.—The Rig-Veda states in several passages that the gods are 33 in number, though according to its own showing this number is far too small. There are three classes of gods: of the heavens, the air, and the earth. The separation of the heavens and the air or atmosphere is based on a distinction between light and air. The home of the gods of light is beyond those of the air. Light is not considered as dependent on the solar body, but as an independent and eternal force. The domain of the gods of the air lies therefore between the earth and the source of light, and their main office is to provide a free passage for the light and rain which the gods furthest off wish to pour upon the earth. The Hindoo idea of what is divine seems to attach itself to that of light. The word for god is *dēva*, which comes from the root *dī*, meaning to shine or glitter. Sūrya is the principal godhead in heaven, Vāyu or Indra of the air, and Agni of the earth. The gods of heaven never appear as sensual and mythological as those of the other two spheres. There are some whose symbol of divinity is not limited to a single object of nature; such is Aditi, who is either a god or a goddess, and whose sons are the Adityas. This divinity is rarely mentioned in the older Vedas as a personification, but generally as the abstract idea of the eternal and infinite. The sons of Aditi are Mitra, Varuna, Aryaman, Bhaga, Dakṣha, and Anṣa; but in some instances as many as seven, eight, and even twelve Adityas are mentioned. Without the distinction being always clearly maintained, it seems that Mitra is the heavenly light of the day, and Varuna of the night. The latter sometimes appears as the lord of all three regions. The sun has several names. Sūrya is the usual designation, though Savitri also occurs frequently in the Vedas, but he is generally coupled only with the golden and glorious attributes of the sun. Gods of heaven often represent only special phenomena of light. The Aśvin are a problematical pair, gods of the earliest daylight. Very circumstantial stories are told of the wonders they have done in healing and saving. Ushas, the dawn, is the beautiful virgin who opens the gate of heaven, chases away the night, and invigorates man and beast. The beneficent effects of solar light are represented by Pūshan. He protects and multiplies all that man owns, guides him on his journeys, protects him against robbers and thieves, and directs departed souls. His chariot is drawn by goats, and he carries a goad. He is sometimes invoked in conjunction with Indra, but has little in common with the gods of the sphere of the air. Vishnu must also be reckoned as a sun god. His name is seldom mentioned in the Vedas. He has passed through the whole universe with only three steps, and has taken his domicile near Indra. He has given the earth to man, the descendant of Manu, as his inheritance. The unbroken order

of the world is principally due to him. In the Vedas he is the friend of Indra, whose place in the worship of the Indian people he afterward usurped.—In the sphere of air there are demons, dark beings, Rakshasas and Asuras. The other gods of this region have to battle with them in order to chase them away. They receive new vigor for these contests from the sacrifices which man offers up to them. In course of time they became more popular than the Adityas, but they grew also more human-like than they. Their chief was Indra, the god of thunder storms. Though the Maruts and Vishnu were at his side, it was he alone who conquered the demons, and therefore it is he who shields man in battle. His principal antagonist among the demons is Vritra, or he who covers up or hides. This Vritra disposes the clouds so that the waters of heaven cannot descend upon the earth. Pani imprisons the waters like cows in the caverns of the rocks, but Indra liberates them and makes them flow upon man over the corpse of Vritra. Indra moves about in a golden chariot, drawn by reddish horses with golden manes and hair like the plumes of a peacock. Prayer harnesses Indra's horses; Tvashtri, the artist of heaven, fashioned a thunderbolt for him; and heaven and earth, and even Tvashtri himself, tremble when his thunder rolls. The gods of wind and rain compose Indra's suite; they are Vāyu, the Maruts or Rudras, and Rudra himself. Vāyu is the wind, but little else is known of him. He was succeeded in the veneration of the people by Vāta, who is the soul of the gods and the source of the world. There are 27 or three times 60 Maruts or Rudras, sons of Rudra and Pricni, the kind gods of the rain; they form Indra's armed body guard, have iron teeth and roar like lions, and they sometimes darken the sun, but always remove their curtains after a while. Rudra, the strongest of them all, roars the loudest; he is the god of storms, whom man must fear, and whose sacrifices must not be neglected. He is besought to spare the lives of the members of the family, and also of the cattle. In course of time he came to be regarded as the forerunner of Siva (Śiva).—The third division, that of the gods of the earth, is the pantheism of the Hindoo religion. Light is the revelation of the divine, and as far as man can produce light, so far can he attain toward the divine. Agni, the god of fire, was let down from heaven by Mātariçvan, the messenger of Vivasvat. The Rishi (pious) Atharvan found him concealed in wood, and by friction induced him to come out. Indra probably begat him between two stones, or perhaps the aurora gave birth to him, or he may be a child of Indra and Vishnu. His origin is threefold: of heaven, of earth, and of air. He has a twofold activity. He is a messenger between the gods and man, not as a low subordinate, but as a viceroy and guardian of the heavenly light on earth; he pierces the

demons with his arrows, and he keeps from evil; in a word, he is the protector of human beings. His other office is to be messenger between man and the gods; ever a fire is lit, the gods must come, he calls them; what the gods do for man is to his intercession. The consequence is soon the merits of Indra came to be transferred to Agni; he became the Vritra-killer. Sôma a god. It is a beverage prepared from *asclepias acida* or from *sarcostemma tinctoria*; the juice of these plants was fermented with milk and flour, and offered to the gods. It was the hidden fire, its intoxicating power which man adored. Sôma lends immortality as well to man as to the gods. His work is as great as those of Agni, for even Indra must first be intoxicated to gain strength to liberate the waters. The gods were thus considered to be in need of the offerings of man to carry out their purpose. In fact, without prayer and sacrifice the gods cannot rule the world. The necessity of their fulfilling man's wishes necessitates their fulfilling man's wishes. Concentrated devotion and penance are more powerful than all the gods, and hence the priest, the hermit, the devotee, and the wise are more powerful than the gods themselves. This is the key of Brahmanism. The Vedas speak also of minor gods of the earth, like Trita and Sarasvatî, the goddess of the river of that name. The Sindhu, or Indus, is the most impetuous of them all. The Asuras are female spirits of the air, much to be feared; but like the nymphs of the Greeks they often bring joy and happiness. The great gods must have wives, and according to the names Indrâni, Agnâyi, Varunâni, Açvins, and Rodasi occur in the hymns. Lakshmi is a goddess of fortune. The Ribhus, who have been raised to the nature of gods on account of their great piety. The Rig-Veda mentions a few names which to represent similarly deified personifications. Every object used in sacrificing was considered in some degree divine, and hence the Brahma came to be looked upon as the real god of earth. Brahmanaspati or Brihaspati, the god of prayer, was subsequently turned into the great god Brahmâ. His works are ascribed to Indra, and also to Agni and Vishnu, but he is quite as often said to be the father of the gods. Prayer and sacrifice have a creative power, and thus Brahmanaspati, the perfect lord of prayer, is considered to be the father of the gods, or the pantheistic principle of the world. Vâch, the goddess of the word and speech, plays a similar part. The word spoken by man or by the gods, has also a creative power. Similarly Prâna, life or breath, Kâma, love and desire, Kâla, time and measure, the inducer of heaven and earth, and Puruṣa, the ideal man or the spirit of the world, mentioned in the Vedas as creative principles. Hiraṇyagarbha, the golden-womb, and Prajâpati, the lord of creatures, represent the creat-

personified god. The two names were originally, it seems, epithets of Savitri, the god of the sun, and they reappear subsequently as epithets of the god Brahmā.—The Vedas adhere to no one settled account of the creation. Its existence is generally attributed to the power of sacrifice brought by the gods. It is Purusha, man as a representative of humanity, the ideal man or the spirit of the world, who takes the place of the sacrificial animal, and Indra and Agni arise from him. This is the account given in the Purushasūkta of the Rig-Veda. Another hymn of the Rig-Veda gives a more philosophical reason for the existence of the world. Here it is religious meditation which produces it. First was formed the desire, or *kāma*, love, which was the first seed. Fire is the creative element as well as the soul of the world as in the soul of man, and it is love, *kāma*, that calls it forth and causes it to create. Two names, Yama and Manu, appear as those of the first man. Yama is the first man who died, and he shows the lead the way into the other world, where he rules. Manu is the first ancestor of mankind; he is Father Manu, and the Aryans are his people; it is he who introduced the rite of sacrifice. The gods nourish and protect him, and Vishnu has assigned to him the earth as his dwelling place. In later times his name is coupled with the legend of the flood, but there are no indications of such revolutions of the earth in the Veda-Saṁhitā. Yama and Manu are sons of Vivasvat, one of the Adityas, and of Saranyu, the immortal daughter of Tvashtri. Yama takes the deceased into a world which is as sensual as the Mohammedan paradise, and where they feast with the gods and drink Sōma. It is Agni, the god of fire, who in consuming the body recreates it into a celestial form, and it is Sōma who gives it immortality. The people must worship their ancestors, for they are not dead, but live with the gods, who share their power with them. There is little in the Vedas to show that the dead were ever supposed to be punished, unless they were hostile races or personal enemies.—The worship of the gods was at first entirely in the hands of each family. There were no temples. Sacrifices were offered under the open sky or at the family hearth. Agni could call the gods wherever his fire was burning; this was fed with clarified butter, of which he was fond. Sōma was carefully prepared according to numerous prescriptions. Colebrooke denies that the ancient Aryans offered also human sacrifices; but German scholars, as Weber and others, think that it admits of no doubt. Sacrifice was neither a thank offering nor a sin offering; it was a contract between man and the gods, and the latter were obliged to fulfil the wishes of the former whenever a sacrifice was offered. If any fault had been committed in the ceremony of sacrificing, so that the gods would not accept it, it was simply repeated. The light thrown by the Vedas on the re-

ligious constitution of the ancient Aryans reveals that the poets of the hymns were not all of a priestly caste; but subsequently they were all Brahmans, and the king Viçvāmitra, who had composed a number of hymns, including the celebrated Gāyatri, was specially raised to the dignity of a Brahman by a later legend, in order to account for the fact of his having been able to write poems. The Rishi, the pious, Kavi, the wise, and Muni, hermits of old, were therefore not all priests. But the Brahmans very soon formed a special caste. Each sacrifice needed a *hōtri*, or caller, who recited portions of the Rig-Veda; an *adhvaryu*, or sacrificer, who performed all the work connected with it; and a Brahman, who watched that all was done properly and in order, and who understood how to right every mistake committed. The Brahman was therefore the high priest, who had the power and wisdom to compel the gods to fulfil all requests. The Brahmans were his successors, who came to be regarded as gods upon earth. The personal gods Indra, Rudra, Savitri, and others, were too poetical to be very real in the hearts of the ancient Hindoos. A need was felt for a more substantial authority, and the priests usurped it, and formed the Brahmanical system of castes, which made them like gods themselves. This opens the second period in the history of the Indian religions.—It is noteworthy that in spite of the complete penetration of Aryan culture over the whole of the Indian peninsula and even Ceylon, the Hindoos failed to establish a vast and powerful empire. It seems that the conquests told in the Rāmāyana and the Mahābhārata were rather religious than political. When the Aryans mingled with the native population of the peninsula, they held a superior position among them from mere distinction of color. The Sanskrit for caste is *varṇa*, which originally signified color. The Sudras (Çūdras) therefore form only what Max Müller has called an ethnological caste. They are the dark prior occupants of the land of the Ganges, whom the light-complexioned race considered inferior to themselves. The Vedic books divide the entire Indian population into four castes, but this number is really in comparison as much below the mark as the 33 gods have been found to be. Manu's book of laws states that there were 16 mixed castes, besides the four principal ones. These were, besides the Sudras already mentioned, the Brahmans, Kshatriyas, and Vaisyas (Vaiçyas). The Brahmans were to read and teach the Veda, offer sacrifice, conduct the ceremonies of the sacrifices made by the people, and to receive and make gifts. The Kshatriyas were to protect the people, do charity, offer sacrifice, read the holy scriptures, but without teaching them, and control their desires. The Vaisyas were to raise cattle, cultivate the land, carry on trade, give alms, sacrifice, and learn to say prayers. The Sudras had but one duty, that of doing service to the other castes. The majority of the minor or

mixed castes are names of professions and trades, of which some were indicated by the names of the cities or districts in which they were most largely represented and famous. Thus the caste of singers, who descended, as *Manu* states, from a *Vaisya* and a *Kshatriya* woman, are called *Māgadhas*, evidently because *Māgadha* was at one time the home of the most famous singers. These trades and professions stood in various degrees of esteem, and their origin was accordingly stated to be from various unions between higher and lower castes. The aboriginal population was also gradually classified according to the *Aryan* system, which gave rise to the other division of unclean castes, whom Europeans call *pariahs*, from the name of a small *Tamil* caste of this grade with whom they came most in contact. It is not to be supposed that the castes were established without struggle on the part of those who were reduced to inferiority. For a time kings, nobility, and priests must have worked hand in hand to subjugate the people. The legend of the *Paraçu-Rāma* shows that the *Brahmans* did not gain superiority over the *Kshatriyas* without bloodshed.—Turning to the changes produced in the religious ideas of the *Hindoos* during this period, it is seen that the *Vedic* pantheism was gradually absorbed by the one *Brahma*, and that the character of *Hindoo* worship is decidedly a-sectic. Speculation is no longer intent on solving the mystery of the origin of the world, but on devising a process by which the world is to return to the *Brahma* from which it emanated. This is the point of contact between *Brahmanism* and *Buddhism*. *Brahma*, in the neuter gender, is an impersonality, the sum of all nature, the germ of all that is, the one that embraces everything. The *Kēna* or *Talavakāra Upanishad* says of it: "Eye, tongue, mind, cannot reach it; we comprehend it not; we cannot teach it to any one; it is other than all that is known and all that is unknown." Unmeaning words are therefore applied to it. One of them is the mysterious syllable *ōm*, the wonderful trinity of sounds. A *Sanskrit* *ō* is a diphthong, and by giving it a nasal utterance it sounds like *ōm*; hence it has three letters, but only one sound. The *Māndukya-Upanishad* is entirely filled with explanations of this little word. Among others it says: "Om is immortal. Its unfolding is this universe, is all that was, is, and shall be. Indeed, all is the word *ōm*; and if there is anything outside of these three manifestations, it is also *ōm*. . . . For this all is *Brahma*; this soul is *Brahma*. This soul has four existences." A is its waking condition, U its dreaming, M its sleep, and the whole is its entire existence. *Brahma* as the abstract principle of the world reappears in a concrete mythological form as the god *Brahmā*, the *Vedic* *Brahmanaspati*. He is pictured with four heads, probably as lord of the four regions of the world. He is *Prajāpati*, the lord of all creatures, and *Hiranyagarbha*,

the golden-wombed, the lord of the sun. Below him are the *Lōkapālas*, stationed at the eight corners of the world to ward off the evil spirits, the *Asuras*; they are *Indra*, *Agni*, *Varuna*, *Sūrya*, *Chandra* or *Sōma* as god of the moon, *Vāyu*, *Yama*, and *Kuvēra*. The *Vedas* do not mention the last, who was originally a man, but who is now a god of wealth, as a reward for his great humility to the *Brahmans*. *Brahmā*'s wife is *Sarasvatī*, who has ceased to be the goddess of the river, and is now goddess of order, harmony, poetry, oratory, language, and all intelligence. She has absorbed the attributes of *Vātch*, and is invoked for the instruction of children. She is depicted with a book or a musical instrument in her hand. It is still believed that prayer and sacrifice called the world into existence, but that existence has no special purpose; indeed, it is of evil, for evil came into the world with the world. As it is impossible that there ever can be a sinless world, so every pious person desires to be taken out of it, and to be relieved of his personal existence. The bright and happy *Veda* religion has thus been transformed into a gloomy meditation on the wretchedness of human life. Fatalism has come upon the *Hindoo* people, and they say, "Man's destiny is written on his skull." This laid the basis for astrology, and even *Manu*'s exclusion of astrologists from the sacrifices failed to root out the belief in predestination. A natural consequence was a further development of the doctrine of the transmigrations of the soul. *Man* was oppressed by the numerous distinctions of caste, and he was taught to consider them as part of the system of the world. Every creature descended from *Brahmā* had to pass again through all the previous stages of his present existence in order to reach *Brahmā* again. *Manu* says: "Man is born according to his deeds, ignorant, dumb, blind, deaf, deformed; whoever has not done penance for his deeds will receive his punishment at his birth." Thus one who stole fruit would be a monkey; one who stole a horse, a tiger; one who stole balm, a rat. When transformation into beasts or plants is not an adequate punishment, the evil doers are sent into one of the eight hells, each of which is more tormenting than the other. Hell is not an eternal punishment, but thousands of years of pain hardly suffice for a complete absolution. When this is attained, then begins the ascending scale of transmigrations, which reach to *Brahma*; but it is possible that in the renewed existence as a human being man's sins are again so great that he must be thrown back to hell. *Man* ranks worms, insects, fishes, serpents, tortoises, dogs, and asses as the lowest order. Elephants, horses, lions, boars, *Sudras*, and people not speaking *Sanskrit* are a step higher. The third class comprises thieves, actors, *Rakshasas*, and *Picāchas*; the fourth athletes, dancers, armorers, drunkards, and *Vaisyas*; the fifth, *Kshatriyas*, kings, eminent soldiers and orators, the *Gandharvas* and

Asparas; the sixth Brahmans, pious penitents, gods, and the great Rishis; and finally above them all is Brahmā. There is no redeemer in ancient Brahmanism; everybody must redeem himself. But sacrifice, asceticism, and philosophy sometimes succeed in reducing the number of transmigrations by leading to higher stages of existence. Most transgressions are of the nature of pollutions. Each caste is within itself a holy, distinct, and pure people, but contact with a person of a lower caste than one's own is unclean. The dead, every excretion of the body, birth, and everything connected with sexual life, are pollutions. Fortunately the cow is so holy that what from all other beings would be the most unclean of all serves the Hindoos as a purifying agent. Water and cowdung purify everything. Penitence consists in fasting for three days, or even for a month, in conjunction with various mortifications of the body or numerous recitations of prayers and portions of the Veda. In Manu's code the penalty for intoxication is dreadful; the drunkard is condemned to drink boiling rice water or boiling juice of cowdung or urine till he dies. The killing of a cow is more criminal than the murder of a person belonging to a lower caste. When a Kshatriya or Vaisya unintentionally slays a Brahman, he shall, without waiting for the sentence of the king, walk 100 *yajana*, reciting one of the three Vedas, or build a hut in the woods, live on alms for 12 years, and carry in his girdle the skull of the slain. But if the slaying of a Brahman was intentional, then the Kshatriya shall himself demand to be shot, or hold his head three times in a fire and die. Sacrifice was still greatly practised during this period, though modern Brahmanism has for the most part abandoned all but the household sacrifices. Ancient Brahmanism distinguished four kinds of sacrifice: *havis*, *harir-yajna* or *istī*, oblation; *paṇu*, or *paṇu-bandha*, animal offering; *śama* or *saumya-adhvara*, drink offering; and *pāka-yajna*, minor offerings, subsequently called *grihya-karma*, house offerings, consisting partly of food and partly of animals. The sacrifice of animals soon fell into disuse, and the Sūtras name the two classes of meat and animal offerings as one. These sacrifices were faithfully performed by the people, but the higher castes began to philosophize on their religion, and added to the Brāhmana scriptures the Āraṇyakas and Upanishads, as containing the essence or the orthodox interpretation of the entire Hindoo religion. Manu's book of laws sanctioned them. They are mainly expositions of the doctrine of the transmigration of souls. They teach that greater than all gifts to the fire of Agni is internal self-combustion, the *tapas*, glow or fire of asceticism. This is the new basis. Man is, through asceticism, meditation or philosophy, and penitence, mightier than all gods; and if he fulfils the laws prescribed for these exercises, he is immediately released from any further transmigration of

his soul, and he enters at once into Brahma. This asceticism is permitted only to the three highest castes, the twice born, *devīja*, or Aryans. A Sudra can at best, and with the highest possible degree of self-denial, attain only to a rebirth into these fortunate castes. Legends like those of Viçvāmītra and Vasiṣṭha, which portrayed the wonderful power which the ascetic possessed over the gods, filled the masses also with enthusiasm for the doctrine of asceticism. The great aim of the Aryan race was no longer to conquer the earth, but to subdue every natural impulse, and to be swallowed up by Brahma, as a drop is by the ocean. Though this asceticism caused an enormous waste of human life, it also gave birth to some of the greatest intellectual achievements of which man is capable.—This leads us to a new period in the history of the religion and literature of India, which is eminently one of philosophy. Ancient Hindoo philosophy, the precursor of that of Greece and Rome, was an outgrowth of that meditation which was enjoined as a means of securing a quick passage into the great Brahma. This philosophy is in its aims much loftier and in its processes much more ingenious than that of the Greeks. Indeed, in spite of the wonderful abstruseness in which it is sometimes buried, it might bear favorable comparison with the philosophies of the 18th and 19th centuries. There are especially six philosophical systems which are still considered to be orthodox, as they recognize the authority of the Vedas. They may be reduced also to three, Vedānta, Sāṅkhya, and Nyāya, each of which is represented by two forms. Vedānta signifies the aim or end of the Veda. Its legendary author is Bādarāyana or Veda-Vyāsa, who is said to be the author also of the divine Vedas themselves and of the Mahābhārata. The development of Vedantism, however, reaches into the time of modern Brahmanism. The Vedānta-Sāra, a small book which draws the ultimate conclusions of the system, is probably of a date later than the 8th century A. D. The Pūrva-Mīmāṃsā philosophy is less an independent system than a collection of addenda for the Vedas, showing how they ought to be used. There is a theistic Sāṅkhya or Yoga system by Patanjali, and an atheistic Sāṅkhya system by Kapila. The Nyāya system, by Gautama, is principally occupied with the principles of logic. Gautama lays down a syllogism of five members: Proposition, *pratijñā*, the forest is burning; reason, *hētu*, for it is smoking; example, *uddharaṇa*, whatever smokes is burning; application, *upanaya*, the forest is smoking; inference, *nigamana*, (hence) the forest is burning. The Vaiçeshika system, by Kanāda, is an independent branch of the Nyāya philosophy. It teaches the eternity of matter in the form of atoms, and also the atomistic eternity of the soul. There is a curious dilemma in the Vedānta, which however is more clearly expressed in the Vedānta-Sāra, viz.: either Brahma

exists, and the world does not exist; or the world exists, and Brahma does not exist. Inasmuch as Brahma exists, and is in fact the only *tantu* or real existence, while all objects, especially individual souls, are only *avastu*, or unreal, it follows that the world does in reality not exist. Other philosophers preferred rather to sacrifice the unity of Brahma than abandon the idea of the reality of the world and of individual souls. Kapila's Sāṅkhya system fell into atheism, but did not therefore lose its orthodoxy with the Hindoos, as with them meditation and penitence are mightier than and superior to the gods. It says that if there were a god, he would be either limited or free, and in neither case could he be a creator. For if he were free from commotions and emotions, nothing could move him to create; and if he were limited, he himself would be subject to illusions. The Sāṅkhya explains the world as a mingling of matter and spirit, and bears in many places a strong resemblance to Aristotle's metaphysics. Its ultimate conclusion is that there is no necessity for a new birth or for transmigrations. It seems, however, that Kapila did not relinquish the presumption of a personal immortality. He argues that in order to satisfy the longings of the human heart, there must needs be a continuing soul; and if such a soul be denied, there cannot be a highest and final destiny in store for man. The end of all Hindoo philosophy of this period is always, however, that the ascetic, whose mind is above the things of this world and fathoms the reason of the existence of all things, need not wander through other bodies, but is immediately after death absorbed by the one great soul of the world. The masses were not in a condition to find consolation in this doctrine, but had to invent some new method of salvation. The Vedic sacrifices were on the point of falling into disuse, as it had been taught that they were only effectual in proportion to their cost.—Buddha had in the mean time made his appearance, and rejected every kind of sacrifice. This had some effect also on the Hindoos who remained faithful to Brahmanism. Buddhism has a human redeemer in the person of Buddha. Brahmanism, unwilling to reject the ancient gods, but believing in the efficacy of human merits derived from prayer and meditation, seized upon the idea of having human mediators, embodiments of the gods, and ushered in a series of avatars or incarnations. Thus Krishna was worshipped in the 3d century B. C. as an Avatāra of Vishnu. The belief that the gods were bound to fulfil the will of man if expressed in sacrifice and prayer, was naturally succeeded by the belief of this age that the gods could not execute anything upon earth unless they came either in human or animal form. Vishnu, of whom the Vedas had little to say, was probably for this reason singled out of the ancient pantheon to be the divinity specially concerned in the welfare of man. He is described as having four hands,

of which one is free, while the others hold a shell, a discus, and a club. His wife is Lakshmi or Śrī, the goddess of love, grace, marriage, progeny, and wealth; the cow is her holy representative upon earth, and the lotus her symbol. About this time Siva, the Mahādēva or great god of the Dravidians, was introduced into the Brahmanical cycle of gods, by identifying him with Rudra, the god of storms. He holds a trident as the symbol of his power, a lasso or sling, an antelope, and sometimes a flame of fire in his hand. He has a third eye in the middle of his forehead, and around his neck is sometimes wound a necklace of human skulls. His wife Kālī, the black or devouring, also called Umā, Durgā, and Pārvatī, has like him three eyes, a wreath of skulls on her neck, and a club in her hand. Her face is sometimes terrific in appearance, especially on account of the long protruding teeth. Her worship is as important and general as that of Siva himself. His sons Ganēṣa and Kārttikeya are also objects of veneration. Sivaism as phallus worship became in time widely diffused among the Aryan as well as aboriginal races of India, and will be further discussed below, in the account of the modern forms of the Dravidian religions. Buddhism, though after 1,000 years' struggle overcome by Brahmanism, gave new directions to its doctrines. (See BUDDHISM.) Mohammedanism was less successful in leaving its mark upon it. The doctrine of the incarnation of the gods in human beings and animals now became a prominent feature of the Hindoo religion. It seems that the incarnation of Vishnu as Krishna was taught in opposition to Buddha. An attempt was even made to represent Buddha himself as an incarnation of the same god. Through the endeavor to unite and reconcile all the religious elements inimical to Buddhism, a Trimūrti was invented, or a trinity composed of the great gods Brahmā, Vishnu, and Siva. A new religious literature sprang up in the Purānas, which were not like the Vedas removed from the people as too holy, but were written specially for them. Their contents are mythological, but they served as polemics against Buddhism, and even of one Brahmanical sect against another. There is thus no unity in modern Brahmanism. It has no hierarchy that embraces the entire Hindoo population. In the holy city Benares, for example, worship side by side a number of sects whose doctrines are more or less at variance with each other. Denominations is perhaps a better name than sects for these divisions, as they are not mere deviations from the main Brahman religion, but distinct separations from it. The main divisions are Vishnuites and Sivaites, the former exalting Vishnu, the latter Siva, above Brahmā. Each division has again several divisions within itself, probably caused by influential expounders of the doctrines. These various distinctions of denominations or sects produced a number of subdivisions in the caste of

na. The other castes were also multi-Sects which reject the system of castes, Lingaites of Mahratta, constitute each a their own. The gods also have enor- increased in numbers, and they are be as many as 380 millions, since it but just that the heavens should be as peopled as the earth. The Vedānta phi- attained the most influential position he Hindoo systems, and effected a union vaism, while the Vishnuites embraced tic Sāṅkhya. The most renowned phi- was Çankarāchārya, who lived in the tury. He was a Brahman of the Nam- be, then dominant in Travancore. He zed, instead of the original four, 72 and founded numerous convents, dis- siderably with the Jains and Vishnu- is said to have died in the Himalaya at of 32. He revived the Vedānta philo- pplied it against Buddhism, and wrote thers the Bhāshyas, which are commen- a the Vedas, but more directly on the

The Vishnuites number among their ed philosophers Rāmānuja of the 12th, dhvāchārya of the 14th century; but ne is not equal to that of Çankarāchārya. hnuite Vallabhāchārya founded in the tury the voluptuous Krishna-shepherd , which places Krishna over Vishnu . Another enthusiastic Krishna worship tituted about the same time by Chai- Bengal. In the 12th century arose in ratta country a new form of Sivaism. its founder, formed monkish brother- a imitation of Buddhism, but he was a emy to the Buddhists, as represented by s. This sect is the Jangama Lingaism, ses the Canarese language as its sacred

The Çākta denomination gives ado- ot to any of the three great gods them- out only to their wives, and especially ouse of Siva, and is very sensual in . Remnants of the ancient Sudra re- re still to be found in Bengal, and ar a strong resemblance to the magic of savage tribes. Islamism made con- e progress in the mean time, and in hird of the population of Bengal were nedans. A mixture of Hindooism and a is represented by the religion of the and another of Buddhism and Brah- by that of the Jains.—The most im- modern religious works known to Eu- are the following. After the Purānas d 18 Upapurānas of similar contents. mple of importance has its own local narrating the story of the god and ifestations in that place, and often con- items of valuable historic information. stras are productions in which Siva is ted as conversing with Durgā; they magic books of the Çaktas. The most at work written in Tamil is Tiruvallu- ural, a collection of sayings of a purely character. The Basava Purānas of the

sect of Lingaites are valuable works for the history of Hindoo sects.—Prominent among the recent developments of the Brahman religion stands the idea of the trinity. It was formerly supposed by European scholars that the Trimūrti, or trinity of Brahmā, Vishnu, and Siva, was a primitive doctrine and the basis of the Indian religion; but it is evident- ly quite a modern conception. This trinity is represented by an image of a body with three heads cut out of a single block of stone. Theoretically, Brahmā is the creator, Vishnu the preserver, and Siva the destroyer; but no cult assigns either temple or feast to the Trimūrti, and it would be greatly unlike the popular conception of Siva to consider him a god of destruction. It would be better, how- ever, to examine first the place which Vishnu occupies in the popular mind. Vishnu pushed Indra back into oblivion. Ten avatars are commonly assigned to him, and they follow each other in an increasing scale of perfection. The first three are incarnations of animals: fish, tortoise, and boar. The fourth is the Manu lion. The human avatars begin with the fifth: first a dwarf, then a hero, and then the still more exalted persons of a Rāmachandra and a Krishna. It is usual to name also an incarnation of Buddha as a concession to Budd- ism, but several writings name other forms in which Vishnu appeared, and expect the god finally to come himself. The revelation of the future advent of Vishnu predicts that at a time when the highest age of man will be only 23 years, a portion of the eternal godhead will be born in the village Sambhala to the Brahman family of Vishnuyāça. He shall be called Kalki, and possess eight superhuman powers. He shall destroy all Mlêchas, Dasyus, and unjust persons, and shall restore righteousness upon earth. The spirits of those who are still alive at the end of the Kali-yuga life shall be changed into forms transparent as crystal, and shall produce a race willing to obey the laws of Krita-yuga, who shall be the fathers of a new humanity. Krita-yuga shall come again when sun and moon have disappeared in the moon house Tishya, near the planet Brihaspati or Jupiter. This will occur at the end of 860,000 human years or 1,200 years of the gods, count- ing from the death of Krishna. The person of Siva was too lofty and powerful to be satisfied like Vishnu to appear as a being of this world. As Vishnu could not, however, be allowed to be considered the only one capable of avatars, it was taught that Siva also occasionally dwelt among men, but only as the incorporation of some attribute of himself. When Nārade, the messenger of the gods, reported to Siva that his worship was falling off upon earth, Siva sent only Nandikêçvara, the bull upon which he rides. The Lingaites also have in their Purānas legends of such descents of divine at- tributes and symbols among them. One of them gives a most wondrous origin to their teacher Basava. The Yôgins or Gosain, cum-



monly known as Fakirs, are worshippers of Siva. Modern Brahmanism has also a female trinity, composed of the wives of Brahmā, Vishnu, and Siva. Sarasvati, Brahmā's wife, is the only goddess of arts, of which language is one, and she is said to punish liars, but not very heavily. Lakshmi, the wife of Vishnu, is the giver of temporal happiness; it is through her that mortals obtain wives, children, dwellings, friends, harvests, wealth, health, and strength. Pārvati, the wife of Siva, who is the most generally worshipped of the three, has the same attributes as Lakshmi in the Sivaic Purānas; but in Bengal and in southern India she is, under the name of Kālī, a bloodthirsty goddess, and her images depict her as truly horrid. She is the goddess of cholera and all other epidemics. She can be appeased only with bloody sacrifice, and even human beings are offered up to her wherever the English authorities do not interfere. In the south Brahman mythology represents the aboriginal *grāma-dēvatās* to be a ninefold development of Pārvati, or rather of the universal productive energy of the deity. The Śakti worship is, like Lingaism, based on sexual relations. The former has chosen the female principle, the lap of the mother of nature, instead of the male, which receives the veneration of the latter. The various sects belonging to it rival each other in obscenity and voluptuousness.—Among the other gods of modern Brahmanism, Ganēṣa and Kārttikēya, the sons of Siva, are also prominent. The former is the god of wisdom and cunning, on whom it is well to call before undertaking anything. He has the head of an elephant, and his image is found everywhere, even in temples not dedicated to him, by the wayside, and in many private houses. The Gānapatya are a sect who make him an object of special worship. Kārttikēya or Skanda, called Subrahmanya and Shanmukha in the Deccan, is the six-headed god of war, whose office is to subdue the demon Śāra or Tāraka, and who by doing penance for 2,000 years obtained the power of governing the whole world without being put to death either by Siva or by any other god. Six nymphs quarrelled for the privilege of nursing him when he was born on the river Ganges, and in order not to vex any of these Krittikās he took six heads and fed on them all. His feast in the month of Kārttika or October is principally attended by music, and fires are lit upon the hills as a token of the return of the victorious warriors. Dakṣa also is important. He is one of the ancient Adityas, and the Vishnu Purāna tells a wondrous story of how he came to be in the train of the Mahādēva Siva. Gangā, the celebrated goddess of the river, is a lovely person with a lotus flower in her hand. Bathing in the Ganges cleanses from all sins, and whoever dies in the river is at once dissolved in the great Brahma. Near the source, at the junction of the Jumna near Allahabad, near Benares, and at the mouth of the river,

her powers are especially effective on account of certain legends connected with these places. Among the eight Lōkapālas or guardians of the world enumerated above, Yama now employs messengers, Yamadūtas, whose duty it is to pull the souls out of corpses and lead them to him bound with ropes. But when people have been very pious Yama himself calls for their souls. The messengers are depicted as deformed, clad in skins of wild animals, and as having eyes of fire and long hair and teeth. When they have brought a soul before the judge of the dead, the first clerk Chandragupta is commanded to read the list of the good and evil deeds of the deceased which is contained in the book Ugrasandhāni. Then sentence is passed whether the soul shall be placed in hell, or reinhabit an earthly form, or rise to a higher sphere. Kuvēra is lord of the treasures hid in the earth, and he resides in the mines of Kailāsa, where his dwarfish, ugly servants keep watch, and can be induced by magic charms to reveal where treasures are concealed. Kuvēra himself is a frightful human form, with three heads, three legs, eight teeth, a single ring through the ears, green eyes, and white sores on his body. Kāma or Mamatha rides on a parrot, and wounds with his arrow those who love. He belongs to the family of Vishnu. The fire of Siva's eye reduced him to ashes, and he will not be born again before Siva marries Pārvati, and then he will be a son of Krishna. His companion is the beautiful Rati, whom he captured from the house of the giant Sambara. In comparison with the dissolute worship of Śakti, the worship of the elevated and poetic side of human love as represented by Kāma is quite insignificant.—The distinctions of caste are rapidly disappearing. The Kshatriyas and Vaiśyas long since lost their separate existence, and many of the occupations originally exclusively theirs are now followed also by the Brahmans. Though the superior castes may engage in the pursuits properly belonging to the lower, the latter are not permitted to usurp the functions of the former. Brahmans now hold government offices, act as soldiers, and enter the service of Europeans and Mohammedans, and even of the Sudras. But whatever their position, they try not to transgress the rules and observances anciently prescribed for them. They avoid, for example, trafficking with certain commodities, such as leather, contact with which is considered polluting; they do not eat or touch certain kinds of food, nor eat with or in the immediate presence of one of an inferior caste. There are classes so degraded that their mere shadow falling on a man of higher caste causes pollution. In Malabar when under native rule it was not uncommon for a man of high caste to strike dead on the spot a man of low caste for having touched him, even if accidentally; the act was regarded as justifiable homicide, and was not punished by the authorities. The condition of the lowest castes is

der native rule was one of the most abject subjection, and so debased were they considered, both socially and spiritually, that it was a crime for a Brahman to read the sacred writings in their presence, or to give them any religious counsel or instruction whatever. Beneath the Sudras there was a numerous class of outcasts and their descendants, who, by forfeiting their standing in their respective castes and becoming polluted, had sunk to the lowest pitch of social degradation, and were regarded as utterly vile. A loss of caste involved a forfeiture of all civil rights and of all property. The British government, however, has prohibited the enforcement of any forfeiture or disinheritance by reason of the renunciation or deprivation of caste; the law has been steadily enforced, and has had an important and salutary effect upon the social state of India.—The Brahmans are now undergoing a religious crisis. The sect of Kālajnānis, whose sacred book is the Kālajnāna, "Knowledge of the Age," written about 1780, believe that the god of gods himself will descend to earth and raise the dead. The Nudis in South Mahratta entertain a similar belief, but both sects seem to be dying out. There is one sect, however, the Brahmō-Sāmāj, which is steadily increasing in number, and which has attracted considerable attention. Its doctrines are not properly a mixture of Brahmanism and Christianity, but rather a rationalistic development of both. The sect is said to have been founded in 1830 by Ram Mohun Roy. The first converts were pupils of Christian educational institutions. They were joined by Mohammedans and by other Brahmans, and formed together a church whose principal doctrines are the adoration of one God, the loving father of all, and brotherly love toward all men. Their great purpose is to do away with distinctions of caste and religion. The head of the sect is now Babu Keshab Chander Sen, and under his energetic guidance it has been established in all the larger cities of India. It was hoped that they would eventually adopt the fundamental doctrines of Christianity, but at a meeting held in 1866 in Calcutta, Jesus was declared to be a divine incarnation in no higher degree than every distinguished person might be said to be such. Excepting the wonderful mystical word *om*, only such portions of the Vedas and the Bible as are merely theistic and not miraculous are admitted into their canon.—The principal recent authorities on the religion and literature of India are: Max Müller, "History of Ancient Sanskrit Literature" (London, 1859); Muir, "Original Sanskrit Texts on the Origin and History of the People of India" (vols. i.-v., London, 1863-70); Lassen, *Indische Alterthumskunde* (2d ed., 2 vols., Leipsic, 1867-73); Whitney, "Oriental and Linguistic Studies" (New York, 1872); Duncker, *Geschichte des Alterthums* (vol. i., 4th ed., Leipsic, 1874); and Wurm, *Geschichte der indischen Religion* (Bonn, 1874).

**INDIANA**, one of the interior states of the American Union, and the sixth admitted under the federal constitution, situated between lat. 37° 47' and 41° 40' N., and lon. 84° 49' and 88° 2' W.; extreme length N. and S. 276 m., average breadth 140 m.; area, 33,809 sq. m., or



State Seal of Indiana.

21,637,760 acres. It is bounded N. by Lake Michigan and the state of Michigan, E. by Ohio, S. by Kentucky, from which it is separated by the Ohio river, and W. by Illinois, from which it is partly separated by the Wabash. It is divided into 92 counties, viz.: Adams, Allen, Bartholomew, Benton, Blackford, Boone, Brown, Carroll, Cass, Clark, Clay, Clinton, Crawford, Daviess, Dearborn, Decatur, De Kalb, Delaware, Dubois, Elkhart, Fayette, Floyd, Fountain, Franklin, Fulton, Grant, Greene, Hamilton, Hancock, Harrison, Hendricks, Henry, Howard, Huntington, Jackson, Jasper, Jay, Jefferson, Jennings, Johnson, Knox, Kosciusko, La Grange, Lake, La Porte, Lawrence, Madison, Marion, Marshall, Martin, Miami, Monroe, Montgomery, Morgan, Newton, Noble, Ohio, Orange, Owen, Parke, Perry, Pike, Porter, Posey, Pulaski, Putnam, Randolph, Ripley, Rush, St. Joseph, Scott, Shelby, Spencer, Starke, Steuben, Sullivan, Switzerland, Tippecanoe, Tipton, Union, Vanderburgh, Vermilion, Vigo, Wabash, Warren, Warrick, Washington, Wayne, Wells, White, Whitely. Indianapolis, the capital, is near the centre of the state. In 1874 there were 27 cities in Indiana: Columbia, with 1,663 inhabitants in 1870; Connersville, 2,496; Evansville, 21,830; Fort Wayne, 17,718; Franklin City, 2,707; Goshen, 3,133; Greencastle, 3,227; Kendallville, 2,164; Indianapolis, 48,244; Jeffersonville, 7,254; Lafayette, 13,506; La Porte, 6,581; Lawrenceburg, 3,159; Logansport, 8,950; Madison, 10,709; Mount Vernon, 2,880; New Albany, 15,396; Peru, 3,617; Richmond, 9,445; Rising Sun, 1,760; Seymour, 2,372; Shelbyville, 2,731; South Bend, 7,206; Terre Haute, 16,103; Valparaiso, 2,765; Vincennes, 5,440; and Wabash City, 2,881. Michigan City is the only lake port of the state. The

population in 1800 and at subsequent decennial periods was as follows:

CENSUS YEARS.	White.	Free Colored.	Slaves.	Total.	Rank.
1800.....	5,848	168	135	6,641	20
1810.....	24,590	398	287	24,520	21
1820.....	145,758	1,290	190	147,178	15
1830.....	399,399	3,629	8	398,081	13
1840.....	675,698	7,165	8	685,566	10
1850.....	977,154	11,262	..	985,416	7
1860.....	1,998,710	11,423	..	1,870,423	6
1870.....	1,655,587	24,500	..	1,680,687	6

Of the total population in 1870, 857,994 were males and 822,643 females; 1,539,163 were of native and 141,474 of foreign birth; and there were 240 Indians. Of the native-born, 1,048,575 were born in the state, 16,598 in Illinois, 3,483 in Iowa, 76,524 in Kentucky, 3,490 in Massachusetts, 5,693 in Michigan, 6,682 in New Jersey, 29,518 in New York, 24,799 in North Carolina, 189,359 in Ohio, 57,291 in Pennsylvania, 12,276 in Tennessee, and 32,489 in Virginia and West Virginia. Of the foreigners, 4,765 were born in British America, 8,363 in France, 78,060 in Germany, 9,945 in England, 28,698 in Ireland, 2,507 in Scotland, 556 in Wales, 873 in Holland, 2,180 in Sweden, and 4,287 in Switzerland. The density of population was 49.71 persons to a square mile. The state contained 320,160 families, with an average of 5.25 persons each, and 318,469 dwellings, with an average of 5.28 persons each. The increase of population from 1860 to 1870 was 24.45 per cent. The number of male citizens 21 years old and upward was 376,780. There were in the state 567,175 persons from 5 to 18 years of age; the total number of persons attending school was 395,263; 76,634 persons 10 years of age and over were unable to read, and 127,124 could not write. Of the latter, 113,185 were of native and 13,939 of foreign birth; 53,359 were males and 73,765 females; 118,761 were white and 8,258 colored; 11,072 were from 10 to 15 years old, 15,630 from 15 to 21, and 100,422 were 21 and over, of whom 36,331 were white males, 57,651 white females, 3,182 colored males, 3,181 colored females, and 77 Indians. The percentage of illiterates 10 years of age and over to the total population of the same age was 10.61, being 8.71 for males and 12.61 for females. The percentage of illiteracy among male adults was 10.09; females, 16.77. The number of paupers supported during the year ending June 1, 1870, was 4,657, at a cost of \$403,521. On June 1, 1870, 3,652 were receiving support, of whom 2,790 were natives, including 2,583 white and 207 colored, and 862 foreigners. There were 1,374 criminals committed during the year. Of the total number (907) in prison June 1, 1870, 755 were of native and 152 of foreign birth; of the natives, 691 were white and 64 colored. The state contained 991 blind, 872 deaf and dumb, 1,504 insane, and 1,360 idiotic. Of the total population 10

years of age and over (1,197,986), there were engaged in all occupations 459,369 persons; in agriculture, 266,777, including 83,949 laborers, and 181,895 farmers and planters; in professional and personal services, 80,016, of whom 1,787 were clergymen, 22,542 domestic servants, 34,954 laborers not specified, 1,683 lawyers, 3,613 physicians and surgeons, and 5,018 teachers not specified; in trade and transportation, 36,517; and in manufactures and mechanical and mining industries, 76,057. The number of deaths from all causes was 17,661; from consumption, 2,807, being 1 death from consumption to 6.8 from all causes; from pneumonia, 1,514, being 1 from that disease to 11.7 from all causes; from diphtheria and scarlet fever, 594; from intermittent and remittent fevers, 521; from enteric fever, 1,029; from diarrhoea, dysentery, and enteritis, 1,241.—Indiana is entirely wanting in mountains, and at least two thirds of the surface is level or undulating. It has consequently no watershed, but there are continuous slopes of great extent, and the difference of elevation between the highest land and the Ohio river at the falls is nearly 600 ft., and a considerable difference (about 70 ft.) is observed between the level of the Ohio at the falls and at the mouth of the Wabash. The river hills extend at various distances from and parallel to the course of the Ohio and other streams, and enclose bottom lands which are chiefly rich alluvions and thickly wooded. These hills along the Ohio are generally as high as the highest levels of the interior, often of a rugged and broken aspect, and where cut through by tributaries of the Ohio present much imposing scenery. Behind these a table land spreads out and forms the interior, and here every feature is changed; instead of the bottom, with their forests, the most varied landscape appears—here groves of oak, ash, and other trees, there vast level prairies; and again the surface is undulating, and occasionally rises into hills from 100 to 300 ft. high. For topographical description, however, the state may be divided into the valleys of its rivers. The Ohio valley, including that of the Whitewater, contains about 5,500 sq. m.; this is a limestone region, and was originally clothed with heavy forests. The hills are abrupt and broken, and numerous tributaries of the Ohio break through them. Of this division of the state about two thirds is good farming land, and the residue either too hilly or too sterile for profitable cultivation. White River valley extends from the Wabash centrally through the state to the Ohio line, and covers about 9,000 sq. m. It is almost uniformly level, and heavily timbered, except in the W. parts, where there are large prairies and barrens and ranges of low rugged hills. Limestone beds exist on White river and between its two forks, and are abundant and excellent along the lower part of the river. The soils are of the richest description. Most of the streams are clear and never-failing,

er power is abundant. The Wabash the largest division, and embraces of 12,000 sq. m. It interlocks with White river, and the E. portion resem-

It is equally fertile, but less broken. The part of the valley has extensive power. From the river hills of the the Wabash the surface is an inclined The valley of the Maumee occupies 100 sq. m. in the N. E., and carries it to Lake Erie. The N. and N. W. part state, drained by the St. Joseph's, flows into Lake Michigan, and the e., a constituent of the Illinois, in all character is level, mostly prairie; it is sandy, and along the Kankakee

Near Lake Michigan the country is a low sand hills, which are covered only with scattered and shrivelled pines and burr oak a few miles back from the lake shore agricultural country is found.—The Ohio, the recipient of the principal streams, borrows on the south from the Miami to the west, a distance by the river's course

Laughery, Indian Kentucky, Silver, Blue, Anderson, Big Pigeon, Little Pigeon are its principal tributaries from the north, none of them are navigable. The river joins the Miami 6 m. above its mouth into the Ohio. The Wabash has its mouth in Ohio; at first its course is N. W. in the middle of Huntington co., thence W.

Williamsport in Warren co., and the remainder of its course S. to the Ohio. Its length is about 550 m., and it has been navigable for 300 m. by steamboats. Its principal sources are, from the south and east, the Saginaw, Wildcat, Sugar or Rock, and Patoka rivers; and from the west, Little Wabash and Embarras rivers, the Vermilion in both states, and in Tippecanoe, Eel, and Little rivers. The most important of these, falls 100 m. above its mouth; the largest, its longest branch, rises near the mouth, not far from the S. sources of the north and W. constituents of the Miami, and flows in S. W. direction, receiving in its course Fall creek, &c.; and the East fork, principal feeders of which are Salt, Muscatine, Clifty, Flat Rock, Sugar, and others, rises in the S. E. part of the state and has a W. course to its union with the West fork, the two forming White river 40 m. above its entrance into the Wabash. The St. Joseph's and St. Mary's form the Maumee, which passes into Ohio and to the west. Another St. Joseph's, with its mouth at Elkhart, &c., passes into Lake Michigan.

The Kankakee, a principal constituent of the Illinois, runs sluggishly through the W. counties for 100 m.; extensive swamps everywhere bound its course. The Kankakee or Pickamink rises S. of the Kankakee, nearly parallel to it for 50 m., and flows into Illinois. Deep and Calumet rivers

lie near to and S. of Lake Michigan, and in some places are only separated from it by banks of sand. Numerous lakes and ponds are found, principally N. of the Wabash. Several of them have no outlets; they are generally clear, and have sandy shores and bottoms. They seldom exceed a few acres in extent, though several at the head of Tippecanoe river and Turtle creek, and near the city of La Porte, cover a considerable area. The largest, Beaver lake, near the Illinois line in Jasper co., had a surface of 10,000 acres, and on the south was bordered by an extensive marsh; but most of the land has been reclaimed, and the lake itself nearly drained.—The geological survey of Indiana has been several years in progress under the direction of the state geologist, Prof. E. T. Cox, assisted by Professors John Collett, B. C. Hobbs, R. B. Warder, and Dr. G. M. Levette. The third and fourth annual reports, for the years 1871 and 1872, were published in one volume in 1872. The most valuable mineral found in Indiana is coal, which exists here in great abundance, and forms part of the great coal field which extends through Illinois, Indiana, and Kentucky. The following statement by Prof. Cox shows the extent and character of this important source of wealth: "The measures covered by an area of about 6,500 sq. m., in the S. W. part of the state, and extend from Warren co. on the north to the Ohio river on the south, a distance of about 150 m. The following counties lie within its area: Warren, Fountain, Parke, Vermilion, Vigo, Clay, Sullivan, Greene, Knox, Daviess, Martin, Gibson, Pike, Dubois, Vanderburg, Warrick, Spencer, Perry, and a small part of Crawford, Monroe, Putnam, and Montgomery. The coal is all bituminous, but is divisible into three well marked varieties: caking coal, non-caking or block coal, and cannel coal. The total depth of the measures is from 600 to 800 ft., with 12 to 14 distinct seams of coal, though they are not all present throughout the entire area of the field. The seams range from 1 ft. to 11 ft. in thickness, and the field may, from the character of the coal, be divided from north to south into two zones; the western contains the seams of caking coal, and the eastern the non-caking or block coal. There are from three to four workable seams of caking coal, ranging from 3½ to 11 ft. in thickness. At most of the localities where these are being worked, the coal is mined by adits driven in on the face of the ridges, and the deepest shafts in the state are less than 300 ft., the average depth to win the coal being not over 75 ft. The eastern zone of the coal measures has an area of more than 450 sq. m. It is here that we find the celebrated block coal, a fossil fuel which is used in the raw state for making pig iron. In fact this coal, from its physical structure and freedom from impurities, is peculiarly suited to metallurgical purposes. It is likewise valuable for generating steam and for household uses.

There are as many as eight distinct seams of block coal in this zone, three of which are workable, having an average thickness of 4 ft. In some places this coal is mined by adits, but generally from shafts, 40 to 80 ft. deep. The seams are crossed by cleavage lines, and the coal is usually mined without powder, and may be taken out in blocks weighing a ton or more." In 1871 there were 24 block coal mines in operation, and about 1,500 tons were mined daily; in 1873 the number of mines had increased to upward of 50, and the daily production to about 5,000 tons. In 1873 eight blast furnaces in Indiana were using the block coal for smelting ores. The quality of the coal, its vicinity to available iron ore beds, together with convenient railroad facilities, give to Indiana marked advantages for the manufacture of iron and steel. (For an analysis of the coal of Indiana, see COAL.) A seam of superior cannel coal is worked in Daviess co.; the vein is 5 ft. thick, the upper 3½ ft. being cannel coal and the remainder a beautiful jet-black caking coal. Peat or turf exists in considerable quantities in the northern part of the state, but, owing to the abundance of wood, is not much used. There are numerous deposits of bog iron ore in the northern part of the state, and clay ironstones and impure carbonates and brown oxides are scattered over the counties embraced in the coal measures. In some places the beds are quite thick, and, though inferior to the rich pure ores of Missouri, will prove valuable for mixing with the latter and aid in making special grades of iron. Indiana possesses some of the finest quarries of building stone in the west; they include both limestone and sandstone. Ganister rock, used for furnace hearths and for lining Bessemer converters, and fire clays, are also found in great abundance. Salt springs exist on the eastern border of the coal formation. Perhaps the most remarkable natural curiosity in Indiana is the Wyandotte cave, 4 m. from Leavenworth, Crawford co., in the southern part of the state, which in many respects rivals the famous Mammoth cave of Kentucky. (See WYANDOTTE CAVE.)—The climate, like that of all the states W. of the Ohio, is liable to frequent and sudden changes. The prevailing winds in winter are from the north and northwest, and in other seasons from the south and southwest, and from the general evenness of the country have a free passage and are in constant motion. The heats of summer are thus modified; but in winter the cold is extreme, though less so than in Illinois. The mean temperature of the year is 52°; that of winter 31°, of spring 51°, of summer 76°, and of autumn 55°. This is nearly the climate of Bordeaux, France, 5° further N. than Indianapolis and on the seaboard. The rainfall is about 38 in. in the year, viz.: 4.97 in winter, 7.79 in spring, 16.92 in summer, and 7.87 in autumn. The earlier fruits blossom in March.—The soil is good, and much of it remarkably fer-

tile. The richest lands are found along Wabash, White, and Whitewater rivers. The states have so little unavailable land; even wet and marshy lands are brought under successful cultivation. About one eighth of the state is prairie land, and about one fifth is covered with a fine forest. The forest contains all the trees natural to the climate of the middle zone of the Union, but oak and maple preponderate; next in order are the hickory, ash, black walnut, elm, sycamore, &c.; and the principal growths are dogwood, pawpaw, plum, persimmon, and crabapple. In most places oak and beech mast is found in such quantities as to contribute largely to feeding and fattening hogs.—Indiana ranks high as a cultural state; in the production of wheat in 1870 it ranked next to Illinois and Ohio, and in Indian corn next to Illinois, Ohio, and Missouri. The chief farm productions and live stock, as reported at the federal census in 1870 and the state statistics in 1873, were as follows:

PRODUCTIONS.	1870.	
Wheat, bushels	27,747,222	22
Indian corn	51,004,785	51
Rye	457,465	
Oats	8,597,409	11
Barley	256,202	
Buckwheat	61,271	
Peas and beans	23,226	
Potatoes	5,549,749	3
Grass and clover seed	73,545	
Fruit		3
Flaxseed	402,991	
Flax, pounds	87,771	
Hemp, tons	22	
Hay	1,076,768	
Tobacco, pounds	9,223,872	15
Wool	5,022,028	1
Hops	63,224	
Beef		3
Bacon		46
Pork in bulk		3
Lard		11
Butter	29,915,245	
Cheese	29,915,245	
Milk, gallons sold	396,943	
Maple sugar, pounds	1,312,222	
Maple molasses, gallons	217,220	
Sorghum molasses	2,022,212	
Honey, pounds	3,327	
Wax	12,049	
Wine, gallons	19,479	
Cider		1
Vinegar		
Horses, number	497,495	
Mules and asses	42,220	
Milk cows	202,224	
Working oxen	14,222	
Other cattle	61,220	
Sheep	1,612,600	1
Swine	1,572,220	2
Cattle		1

The returns of live stock for 1870 include animals on farms, while in 1873 the entire number in the state is returned. According to the census of 1870, there were in the state 10,100 acres of improved land, 7,189,334 of woods and 826,035 of other unimproved land. The total number of farms was 161,229, in 1870, 55,614 containing 20 and under 50 acres, 614, 50 and under 100; 29,433, 100 and

1,004, 500 and under 1,000; and 76, and over. The cash value of farms was 04,189; of farming implements and machinery, \$17,676,591; wages paid during the preceding year, \$9,675,348; total estimated value of all farm productions, including betterments and additions to stock, 14,302; value of orchard products, \$2,646; of produce of market gardens, \$486,679; of forest products, \$2,645,679; of home manufactures, \$605,639; of animals slaughtered for slaughter, \$30,246,962; of all live stock, \$93,776,762. In 1873 there were 6,162,999 acres in cultivation, of which 1,902,599 were devoted to wheat, 2,627,980 to Indian corn, 924,795 to oats, 985,529 to meadow, and 775 to pasture and woodland. The value of animals slaughtered was \$3,938,754. There were 570,382 tons of coal mined, and 1,167,000 bushels of lime made.—Indiana has no

direct foreign commerce, but it has a vast domestic and inter-state trade by means of its navigable waters and magnificent systems of railroads and canals. Its geographical position is such that the whole land commerce between the manufacturing states of the east and the country west of the Mississippi must pass through its territory. Evansville is a United States port of delivery. In 1873 there were enrolled here 75 vessels with an aggregate tonnage of 11,474. In 1845 there were 80 m. of railroad in Indiana; in 1855, 1,406; in 1865, 2,217; in 1870, 3,177; and in 1873, 8,544. Of the 92 counties of the state, all but five were in the last mentioned year traversed by railroads. The following table exhibits the railroads of the state in 1873, with their termini; also the assessed value, including main and side track and rolling stock, as reported by the state board of equalization:

CORPORATIONS.	TERMINI.	Miles completed in the state in 1873.	Miles between termini when different from preceding.	Total assessed.
St. Hamilton, and Indianapolis.....	Hamilton, O., and Indianapolis.....	77	98	\$551,226
St. Lafayette, and Chicago.....	Lafayette and Kankakee, Ill.....	21	75	160,665
St. and Martinsville.....	Fairland and Martinsville.....	39	...	147,975
St. Richmond, and Chicago.....	Cincinnati, O., and Richmond.....	5	49	82,575
St. Richmond, and Fort Wayne.....	Richmond and Fort Wayne.....	92	...	429,607 (88 m.)
St. and Terre Haute.....	Cincinnati, O., and Terre Haute.....	26	186	107,718
St. Wabash, and Michigan.....	Anderson to Michigan state line.....	61	129	262,866 (67 m.)
St. Columbus, Cincinnati, and Indianapolis (division).....	Gallion, O., and Indianapolis.....	84	906	1,525,680
St. El River, and Illinois.....	Butler and Logansport.....	63	99	428,900
St. Ho, and Crawfordsville.....	Evansville and Terre Haute.....	109	...	562,540
St. Terre Haute, and Chicago.....	Terre Haute and Danville.....	65	...	292,847 (43 m.)
St. Jackson, and Saginaw.....	Jackson, Mich., and Fort Wayne.....	68	100	428,740
St. Muncie, and Cincinnati.....	Fort Wayne and Connersville.....	108	...	598,661 (104 m.)
St. and Indiana.....	Fort Wayne and Traverse City, Mich.....	61	269	518,606
St. North and South.....	Oxford and Newburg.....	18	190	77,250
St. and Illinois Central.....	Indianapolis and Decatur, Ill.....	9	152	48,757
St. with, Bloomington, and Western.....	Indianapolis and Pekin, Ill.....	78	208	971,736
St. with, Cincinnati, and Lafayette.....	Cincinnati, O., and Lafayette.....	158	176	1,651,200
St. with, Peru, and Chicago.....	Indianapolis and Michigan City.....	161	...	1,077,513 (144 m.)
St. with, and St. Louis.....	Indianapolis and St. Louis, Mo.....	73	261	1,512,284
St. with, and Vincennes.....	Indianapolis and Vincennes.....	116	...	442,354
St. with, Madison, and Indianapolis.....	Louisville, Ky., and Indianapolis.....	110	...	1,441,728
St. with, .....	Columbus to Madison.....	45	...	334,519
St. with, .....	Columbus to Cambridge City.....	65	...	448,098
St. with, .....	Muncie to Illinois state line.....	86	115	314,768
St. with, .....	Evansville and Bellefontaine, O.....	17	300	...
St. with, .....	Buffalo, N. Y., and Chicago, Ill.....	167	539	4,112,664
St. with, .....	Logansport and Terre Haute.....	115	...	618,500 (110 m.)
St. with, .....	New Albany and Michigan City.....	288	...	1,045,168
St. with, .....	New Albany and Mt. Vernon, Ill.....	18	150	67,641
St. with, .....	Detroit, Mich., and Chicago, Ill.....	42	245	1,096,316
St. with, .....	Lake Station to Joliet, Ill.....	15	44	...
St. with, .....	Cincinnati, O., and St. Louis, Mo.....	225	840	3,806,090
St. with, .....	...	...	...	4,909,155
St. with, .....	Columbus, O., to Indianapolis.....	78	188	...
St. with, .....	Columbus, O., to Chicago, Ill.....	196	314	...
St. with, .....	Union to Logansport.....	91	...	...
St. with, .....	Logansport to Illinois line.....	50	...	...
St. with, .....	Pittsburgh, Pa., and Chicago, Ill.....	156	468	...
St. with, .....	St. Louis, Mo., and Nashville, Tenn.....	28	316	204,496
St. with, .....	Indianapolis to Illinois line.....	79	...	1,786,665
St. with, .....	Toledo, O., and Camp Point, Ill.....	166	404	3,046,823
St. with, .....	Harrison, O., and Hagerstown.....	63	...	365,466

Wabash and Erie canal, the longest in the United States, connecting the Maumee river at Toledo with Evansville on the Ohio, 467 m. of its course in Indiana, and passes through Fort Wayne, Huntington, Wabash, Peru, Logansport, Delphi, Lafayette, Attica, Covington, Montezuma, Terre Haute, Bloomfield,

and Petersburg. The Whitewater canal extends from Lawrenceburg on the Ohio to Hagerstown, 75 m., and takes in its course Brooksville, Connersville, and Cambridge. These canals are little used now. In 1873 the state contained 6,943 miles of telegraph, the assessed value of which was \$807,874. There

were 125 foreign insurance companies doing business in the state; their gross receipts for the six months ending July 1, 1873, amounted to \$1,169,413; losses paid, \$608,950; tax paid, \$17,498. There were 92 national banks, with an aggregate paid-in capital of \$17,611,800, and an outstanding circulation of \$14,536,015. The bank circulation of the state was \$14,706,415, being \$8 75 per capita and 1·2 per cent. of the wealth of the state; ratio of circulation to capital, 81·9. The total number of manufacturing establishments in 1870 was 11,847, using 2,881 steam engines of 76,851 horse power and 1,090 water wheels of 23,518 horse power, and employing 58,852 hands, of whom 54,412 were males above 16 years of age, 2,272 females above 15, and 2,168 youths. The capital invested amounted to \$52,052,425; wages paid during the year, \$18,366,700; value of materials consumed, \$63,135,492; of products, \$108,617,278. The chief industries are exhibited in the following table:

INDUSTRIES.	No. of establishments.	Steam engines, horse power.	Water wheels, horse power.	Hands employed.	Cap. Ital.	Wages.	Materials.	Products.
Agricultural implements.....	124	860	165	1,268	\$1,622,769	\$484,526	\$901,714	\$2,125,794
Boots and shoes.....	985			2,762	842,407	651,730	1,094,977	2,009,114
Carpentering and building.....	995	216		2,893	541,720	738,847	1,501,829	3,444,930
Carriages and wagons.....	770	830	235	3,925	2,166,485	1,094,146	1,276,298	3,614,089
Cars, freight and passenger.....	10	876		1,408	625,898	884,124	1,069,840	2,577,736
Clothing, men's.....	221			1,531	700,800	498,570	1,380,752	2,261,874
Cooperage.....	357	258		1,868	611,087	884,241	950,748	1,221,875
Flouring and grist-mill products.....	962	16,676	18,667	8,214	6,515,627	595,717	30,802,591	23,871,822
Furniture, not specified.....	819	1,500	513	2,780	2,946,373	1,110,620	1,267,081	3,468,270
Iron, forged and rolled.....	9	3,250		169	1,255,080	625,209	1,264,603	2,643,066
" pigs.....	4	1,725		193	425,000	150,400	585,685	1,191,584
" castings, not specified.....	66	966	233	949	1,281,552	470,788	1,619,851	2,592,596
Leather, tanned.....	197	575	5	514	875,740	142,468	803,247	1,216,242
" curried.....	151	147		819	303,819	54,081	609,773	1,151,267
Liquors, distilled.....	36	793	30	280	638,338	124,150	1,235,193	2,098,699
" malt.....	99	358	35	448	1,117,400	178,790	677,576	1,213,116
Lumber, planed.....	85	1,789	123	688	796,677	242,579	703,031	1,274,104
" sawed.....	1,861	84,626	5333	9,416	6,975,744	1,601,612	5,363,935	12,334,755
Machinery, not specified.....	62	761	127	1,134	1,947,376	628,774	654,029	1,400,094
" in engines and boilers.....	83	682		1,003	1,352,716	675,638	1,259,104	2,287,290
Pork packed.....	11	179		452	1,268,080	69,863	2,262,787	2,799,021
Saddlery and harness.....	436			1,233	625,080	321,212	564,908	1,034,641
Sash, doors, and blinds.....	59	1,212	165	641	638,650	291,836	664,004	1,298,094
Tin, copper, and sheet-iron ware.....	322			296	751,005	275,017	620,560	1,238,298
Woolen goods.....	145	2,713	1,183	2,305	8,770,513	717,176	2,595,604	4,272,737

—The constitution of Indiana is dated Feb. 10, 1851, and superseded that of June 29, 1816. Every male citizen 21 years of age, and who has resided in the state six months, possesses the right of voting. The general assembly consists of a senate of 50 members elected for four years, one half every second year, and a house of representatives of 100 members elected for two years. The legislative sessions are biennial, beginning on the Thursday after the first Monday of January in odd years. Members of the legislature receive \$3 a day during the session. The governor and lieutenant governor are elected for four years; the former has a salary of \$8,000 a year. The other chief state officers are the secretary of state, salary \$2,000; auditor, \$2,500; treasurer, \$3,000; attorney general, \$3,000; and superintendent of public instruction, \$2,000. These officials are elected for a term of two years. A majority vote of each house is sufficient to pass a bill over the veto of the executive. The state election is held on the second Tuesday of October in even years. The judicial power is vested in a supreme, a circuit, and a superior court. The supreme court consists of five judges, who are elected by the people for a term of six years, and receive an annual salary of \$4,000 each. The state is divided into five supreme judicial districts and 38 circuit districts. Each of the 38 circuit judges receives

an annual salary of \$2,500; they are elected by the people for a term of six years. A superior court of three judges elected for four years may be established in any county containing a city of 40,000 inhabitants; the only one yet established is in Marion co., of which Indianapolis is the chief city. Special criminal circuit courts are provided for seven counties of the state: Allen, Floyd, Clark, Marion, Tippecanoe, Vanderburgh, and Vigo. The officers elected by the people in each county are, a clerk of circuit court, auditor, recorder, treasurer, sheriff, coroner, and surveyor—the first three for four years, and the others for two years. Justices of the peace are elected in each township for four years. Indiana is represented in congress by two senators and 13 representatives, and has therefore 15 votes in the electoral college. The system of granting divorces in Indiana, which had attracted wide attention on account of its elasticity, was amended in 1873 and made somewhat more stringent. The causes of divorce under the new law are: 1, adultery, except in certain specified cases; 2, impotency existing at the time of the marriage; 3, abandonment for two years; 4, cruel and inhuman treatment of either party by the other; 5, habitual drunkenness of either party, or the failure of the husband to make reasonable provision for the family; 6, the failure of the husband to make reasonable provision for his fam-

ily for a period of two years; 7, the conviction of either party subsequent to the marriage, in any country, of an infamous crime. Divorces may be decreed by the circuit or superior court on petition of a person who is and has been a *bona fide* resident of the state for the preceding two years, and of the county for at least six months; such residence to be proved by the oath of the petitioner and the testimony of at least two witnesses who are resident freeholders and householders of the state. Murder, treason, and killing in a duel are capital offences, punishable with death. Marriage between negroes and white persons is declared a misdemeanor, the penalty of which is imprisonment from one to ten years. By act of 1873 women are declared eligible to any office the election or appointment to which is vested in the general assembly or the governor. The state debt on Nov. 1, 1873, was \$4,898,657, including \$3,904,733 domestic and \$994,030 foreign debt. The receipts into the state treasury during the preceding year were \$2,875,449, and the disbursements, including several extraordinary items, \$3,445,298. Of the receipts, \$438,191 were from state revenue, \$1,372,993 from the common school fund, \$190,603 from public institutions, and \$1,524,545 from miscellaneous sources. The most important items of expenditure were \$1,361,341 for common schools, \$1,193,442 on account of public debt, \$352,576 for benevolent institutions, \$296,180 for reformatory institutions, \$289,934 for ordinary expenses, and \$278,373 for legislative expenses. The state tax was 15 cents on the \$100 for general purposes, and 16 cents for schools. The total valuation of real and personal property was \$279,032,209 in 1856, \$578,484,109 in 1866, \$662,283,178 in 1870, and \$950,467,854 in 1873, the last including personal property to the extent of \$247,146,331.—The public institutions supported entirely or in part by the state are the hospital for the insane, the institution for the deaf and dumb, and the institution for the blind in Indianapolis, house of refuge at Plainfield, soldiers' home at Knightstown, northern state prison at Michigan City, southern state prison at Jeffersonville, reformatory institution for women and girls in Indianapolis, normal school in Terre Haute, state university at Bloomington, and agricultural college at Lafayette. The state hospital for the insane, which was opened in 1848, had 474 inmates at the close of 1873; during the year 320 were admitted and 314 discharged. The current expenditures for the year amounted to \$155,470. The institution for educating the deaf and dumb is open to all persons of that class in the state between the ages of 10 and 21 years, free of charge for board and tuition. It is not an asylum, but an educational institution, and comprises a manual labor department. In 1873 there were 14 instructors and 331 pupils; the total disbursements on account of the institution amounted to \$73,632. The institute for the education of

the blind is also strictly educational, and is designed for the benefit of those between 9 and 21 years of age. At the close of 1873, 106 pupils were receiving instruction from 11 teachers; the resources of the institute during the year amounted to \$42,174, and the expenditures to \$39,798. The house of refuge, open to boys not exceeding 16 years of age, comprises a farm of 225 acres, a chair factory, and a tailor shop. The number of inmates at the beginning of 1874 was 216; the total expenditures for the preceding year amounted to \$56,244, including \$10,497 for buildings and improvements. This institution is conducted on the "family system," the inmates being divided into families of about 50 each. The plan of the soldiers' orphans' home comprises educational and industrial features. At the close of 1873 the number of inmates was 285; the cost of the institution for the year was \$33,448. In the two state prisons of Indiana the convicts are employed in different branches of industry, prominent among which is the manufacture of agricultural implements and railroad cars. The convicts receive regular instruction in the ordinary English branches, and also have the use of a library. The number of convicts in the northern prison at the close of 1873 was 368; the total receipts of the prison for the year were \$57,465, of which \$50,069 was for labor; the expenditures amounted to \$49,743. The average number of convicts in the southern state prison was 395. The ordinary expenses of the prison for the year amounted to \$66,806, and the total receipts from convict labor and all other sources to \$67,088. Of the 751 convicts in both institutions at the beginning of 1874, 86 had been committed for murder, 18 for manslaughter, 413 for grand larceny, and 21 for forgery; 57 were under sentence for life, and 14 for 21 years. The Indiana reformatory institution for women and girls, which has penal and reformatory departments, was opened in September, 1873. Of the 21 females in the penal department at the beginning of 1874, 5 were under sentence for murder, 1 for manslaughter, 1 for forgery, and the remainder for larceny.—The educational interests of the state are under the general supervision of the state board of education, which comprises the governor, the superintendent of public instruction, the presidents of the state university and the normal school, and the school superintendents of the three largest cities in the state. The more immediate management of the common schools is vested in a state superintendent of public instruction, in county superintendents, and in trustees who have the general charge of educational affairs in cities and towns. The opportunity for obtaining a common school education without charge for tuition is afforded to all persons between the ages of 6 and 21 years; separate schools, however, are provided for negroes, who are not allowed to attend schools designed for white persons. Teachers must be



examined and receive certificates. The permanent common school fund of Indiana in 1874 was greater than that of any other state in the Union; it amounted to \$8,616,931, which yielded an annual interest of \$189,455. This fund consists of a productive portion comprising the congressional township, the saline, the surplus revenue, the bank tax, and the sinking funds; a contingent portion embracing the proceeds of fines, forfeitures, escheats, swamp lands, and taxes on corporations; and a non-productive portion comprising the sixteenth sections (17,882 acres) of the public lands remaining unsold. Besides these sources of revenue, a property tax of 16 cents on the \$100 and a poll tax are levied for school purposes. The income from state taxes in 1873 was \$1,190,626, besides \$530,667 from local taxation. The income from all sources amounted to \$2,276,569, being an increase of \$165,581 over that of the preceding year. The entire school population in 1873 was 640,332; the total enrollment 465,154, of whom 13,895 were in high schools; and the average attendance 298,851. Schools were open in 9,008 districts, the average length throughout the state being 5½ months. There were employed 12,056 teachers, of whom a majority were males. The total valuation of school property in 1872 was \$9,199,480. The normal school was organized in 1867, and in 1873 had 12 instructors and 356 pupils, of whom 224 were in the normal and 128 in the model school. The full course occupies three years. The state university was opened as a college in 1824, and became a university in 1839. It comprises a collegiate, a medical, and a law department, in each of which tuition is free. A department of military science and civil engineering is connected with the collegiate department. Women are admitted to the collegiate course. In 1874 the university had 28 instructors, of whom 12 were in the medical and 2 in the law department, and 371 pupils, including 108 in the medical and 41 in the law department. The 390,000 acres of land granted by congress to Indiana for the establishment of a college of agriculture and the mechanic arts have been sold for \$212,238, which is to be devoted to the support of Purdue university. This institution was founded at Lafayette by Mr. John Purdue, a resident of that city, who gave \$150,000 for the purpose. There are more than 200 acres of land connected with the institution. Among the largest of the institutions of learning not connected with the state are the university of Notre Dame (Roman Catholic) at Notre Dame, St. Joseph co., and the Northwestern Christian university (Disciples') in Indianapolis. The former has a classical and a scientific course of four years each, and a commercial course of two years. It was organized in 1842, and in 1874 had 15 professors, 16 other instructors, and 441 pupils. The Northwestern Christian university, organized in 1854, comprises an academic department which affords a classical

and a scientific course, a business, and a law department. In 1873 there were 13 instructors and 265 students. The Indiana Asbury university (Methodist), at Greencastle, has preparatory, collegiate and law courses. (See GREENCASTLE.) Earlham college (Friends') was founded at Richmond in 1859, and in 1873 had in its collegiate and preparatory departments 11 instructors and 229 students, with 3,500 volumes in the library. Other prominent colleges of the state are represented in the following table:

NAME.	Location.	Date of organization.	Instructors.	Pupils.	Volumes in library.
Salem college.....	Bourbon.....	1870	9	...	...
Wabash college.....	Crawfordsville.....	1854	11	381	12000
Concordia college.....	Fort Wayne.....	1850	6	109	8000
Fort Wayne college.....	".....	1846	7	173	...
Franklin college.....	Franklin.....	1872	4	94	1000
Hanover college.....	Hanover.....	1838	10	184	7000
Hartsville university.....	Hartsville.....	1854	9	117	500
Howard college.....	Kokomo.....	1869	4	69	...
Union Christian college.....	Morvin.....	1859	8	162	600
Moore's Hill college.....	Moore's Hill.....	1854	5	142	800
St. Meinrad's college.....	St. Meinrad.....	1850	9	58	4000
Sullivan college.....	Logansport.....	1871	...	...	...

Special instruction in science is afforded at Purdue university and St. Meinrad's college; in theology at Hartsville university (United Brethren); in law at the Indiana university, the Northwestern Christian college, and the university of Notre Dame; and in medicine by the medical department, in Indianapolis, of the state university. Prominent among institutions for the superior instruction of females are St. Mary's academy at Notre Dame, Logansport female college at Logansport, Moravian seminary for young ladies at Logansport, De Pauw college at New Albany, and the Indianapolis female institute in Indianapolis. According to the census of 1870, the total number of educational institutions in Indiana was 9,073, with 11,652 teachers, of whom 4,974 were females, and 464,477 pupils. The income from all sources for educational purposes amounted to \$2,499,511, of which \$50,629 was from endowment, \$2,126,502 from taxation and public funds, and \$322,389 from tuition and other sources. Included in the above were 8,871 public schools, with 11,042 teachers and 446,076 pupils, 16 colleges with 143 teachers and 3,102 pupils, 16 academies with 125 teachers and 3,580 pupils, and 124 private schools with 201 teachers and 6,296 pupils. The total number of libraries was 5,301, containing 1,123,558 volumes; of these, 2,968 with 497,659 volumes were private, and 2,333 with 627,894 other than private, including 20 circulating libraries containing 8,248. The most important libraries are the state library in Indianapolis, which has 15,000 volumes; that of Wabash college, 12,000; university of Notre Dame, 12,000; Whitcomb and college circulating library at Greencastle, 9,000; Hanover college, at Hanover, 7,000; state university at Bloomington, 6,000;

Northwestern Christian university in Indiana, 5,000. The census of 1870 reports newspapers and periodicals, having an aggregate circulation of 363,543 and issuing 164 copies annually. There were 20 papers with a circulation of 42,300; 8 tri-weekly, with 2,200; 1 semi-weekly, with 350; 288 with 289,342; 6 semi-monthly, with 28 monthly, with 64,150; and 2 bi-monthly, with 6,000. The statistics of churches as follows:

DOMINATIONS.	Organizations.	Elders.	Sittings.	Value of property.
Regular.....	522	476	185,575	\$1,047,625
Irregular.....	68	45	16,800	89,700
Total.....	455	521	202,375	1,137,325
Methodist.....	15	12	4,800	119,900
Protestant Episcopal.....	49	38	10,300	492,500
Methodist Association.....	47	40	10,925	124,600
Presbyterian.....	51	76	29,500	203,800
Evangelical.....	5	4	1,900	118,000
Other.....	196	180	62,285	619,600
Episcopal (United Fraternity).....	1,468	1,121	346,125	3,291,427
Swedenborgian.....	2	3	650	5,000
Other.....	1	1	100	4,000
Methodist, regular.....	333	315	116,500	2,006,550
Methodist, other.....	42	42	12,400	71,550
Methodist church in America (Sch. Reformed).....	2	2	500	8,200
Methodist church in the United States (late German).....	84	33	8,850	97,300
Methodist, other.....	204	201	86,830	2,511,700
Other.....	1	1	100	1,000
Methodist in Christ.....	184	121	33,975	188,000
Methodist, other.....	15	15	6,800	73,400
Methodist (Union).....	4	5	1,200	3,500
Total.....	3,098	3,106	1,008,880	\$11,942,227

as originally constituted a part of New York and subsequently of the Northwest Territory. The exact period of its first settlement is not ascertained. In 1702 a party of French Canadians descended the Wabash, established several posts on its banks, and others Vincennes. The Indians made opposition to the new comers. Until 1763 when the country was ceded to the British, nothing is known of the early settlers. After the treaty of cession, however, they were admitted in their possessions. The treaty of 1763 included Indiana in the United States. In 1771 an Indian war broke out, which caused distress at Vincennes. In 1791 the Indians were attacked at the mouth of the Tippecanoe by Gen. Wilkinson, and by the subsequent victories of Gen. Wayne a dangerous Indian confederacy was broken up and the tribes were forced to submit. The whole district now enjoys that repose of which it had been many years deprived. By the treaty of 1795 the United States observed several eligible parcels of land, and settlement began to make considerable progress. In 1800, Ohio was erected into a separate territory, while all the country W. and N. of it was added to the new government of Indiana. The territorial government was organized July 4, 1800, and William Henry Harrison as governor. In

1805 Michigan was also set off, and in 1809 Illinois, leaving Indiana with its present limits. In all this period, however, the Indians had been troublesome, and greatly impeded settlement. Nevertheless the census of 1810 showed a fair increase, the population in that year amounting to 24,520 souls. In 1811 the general government determined to exert its power against the savages, who, excited and exasperated by the eloquence of Tecumseh, a leader of the Shawnees, and the most extraordinary man that had ever appeared among them, had committed grievous depredations. A force of regulars and militia was assembled at Vincennes and placed under the command of William Henry Harrison, then governor. On Nov. 6 of the same year the governor appeared before Prophetstown or Tippecanoe on the Wabash, and demanded restitution of the property which the Indians had carried off. After a conference it was agreed that hostilities should not commence until next morning, that an amicable arrangement might be made; but in violation of this armistice the Americans were attacked before daybreak by a large body of savages. Gov. Harrison, however, knowing the character of the enemy, had so disposed his troops as not to be taken by surprise. The combat that ensued, though short, was unusually severe; the Indians fought with desperate courage, but could not withstand the superiority of the forces arrayed against them, and the fate of the battle was soon decided. After burning the town and laying waste the surrounding country, the victorious army returned to Vincennes, and not long afterward the tribes sued for peace. The war with England now broke out, and gave a fresh impetus to Indian hostility; but again the savages were overwhelmed, and after the close of the war in 1815 finally ceased to molest or trouble the settlers. In December, 1815, the territorial legislature petitioned congress for admission into the Union, and the privilege of forming a state constitution. A bill for these purposes passed congress in April, 1816; and soon after a convention was called, which on June 29 ensuing adopted the first constitution of Indiana. On Dec. 11, 1816, the state was admitted into the Union. A more rapid immigration ensued, and continued without interruption; and though numbers passed westward into Illinois, the new state retained its share. In 1827 the Erie canal opened an outlet for the produce of the west, and the national road was commenced. Both these circumstances naturally stimulated settlement; and the sales of land so rapidly increased that in the ten years ending in 1830 they amounted to 3,558,221 acres. The population in the same year was 343,031, being an increase of 133.1 per cent. over that of 1820. Now commenced that speculation mania which terminated in the financial revulsion of 1837. In 1832 the legislature incorporated eight stock companies for constructing railroads; in 1833 the middle section of the Wabash and Erie

canal was commenced, and in 1834 the state bank with ten branches was incorporated, to which were subsequently added three other branches. The result of these undertakings, and others into which the state entered, was a debt amounting to \$14,057,000 and a general bankruptcy. But in the ten years ending in 1840 the population had doubled, and 9,122,688 acres of public land had been disposed of to individuals; but none of the great works had yet been completed. For the next six or seven years little progress was made, and in no one of these years was 100,000 acres of land disposed of. In 1846 the state debt, on which no interest had been paid since 1839, was consolidated and arranged into two classes, the state debt proper and the canal debt; and means were devised for paying interest on the former. Under the influence of this scheme prosperity returned. In 1851 a new constitution was adopted, and in 1853 the legislature passed a free banking law. The question of holding another constitutional convention was submitted to the people in 1859, when the proposition was rejected.

**INDIANA**, a W. county of Pennsylvania, bounded S. E. by Conemaugh river and drained by numerous small streams; area, 770 sq. m.; pop. in 1870, 86,138. It has a hilly surface, well timbered, chiefly with white pine, and abounds in iron ore and bituminous coal. The soil is moderately fertile. The Pennsylvania canal passes along the S. boundary, and a branch of the Central railroad

extends to the county seat. The chief productions in 1870 were 308,183 bushels of wheat, 97,550 of rye, 652,263 of Indian corn, 906,255 of oats, 71,477 of buckwheat, 77,367 of potatoes, 125,891 lbs. of wool, 1,100,925 of butter, and 38,749 tons of hay. There were 11,586 horses, 12,061 milch cows, 13,844 other cattle, 44,054 sheep, and 17,412 swine; 10 manufactories of agricultural implements, 9 of brick, 14 of carriages, 3 of clothing, 15 of furniture, 10 of iron castings, 1 of machinery, 4 of marble and stone work, 2 of paper, 13 of saddlery and harness, 2 of salt, 4 of sash, doors, and blinds, 11 of tin, copper, and sheet-iron ware, 8 of woollen goods, 8 flour mills, 28 tanneries, 19 currying establishments, 4 planing mills, and 26 saw mills. Capital, Indiana.

**INDIANAPOLIS**, the capital and largest city of Indiana, seat of justice of Marion co., situated near the centre of the state, on the W. fork of

White river, 100 m. N. W. of Cincinnati and 165 m. S. S. E. of Chicago, in lat. 39° 47' N., lon. 86° 6' W.; pop. in 1840, 2,692; in 1850, 8,091; in 1860, 18,611; in 1870, 48,244, of whom 10,657 were foreigners (5,286 Germans and 3,321 Irish) and 2,981 colored. The number of families was 9,200; of dwellings, 7,820. The population in 1874 was estimated by local authorities at 80,000. The city is built in the midst of a fertile plain, chiefly on the E. bank of the stream. The surrounding country abounds in black walnut, and in the vicinity is an extensive coal field. The streets are 90 ft. wide, except Washington street, which has a width of 120 ft., and cross each other at right angles; but there are four long avenues radiating from a central square and traversing the city diagonally. There are 200 m. of improved streets, most of them being gravelled, but many paved with stone or wood, and all lighted with gas. A system of sewerage is in progress. The river is crossed by nine bridges (three



State House in Indianapolis.

for railroad purposes), of which all except the old "national road" bridge are of iron. Two others are to be constructed. Street cars accommodate local travel. There are seven parks, viz.: the Circle, in the centre, containing 4 acres and ornamented with shade trees; the state house park, 10 acres; military park, 18 acres; university park, 4 acres; the trotting or southern park, with a course of one mile, 86 acres; a park in the N. portion of the city, embracing 100 acres; and the state fair grounds, with exposition building, containing 40 acres. Greenbaum cemetery is within the city limits, and is coeval with the city itself; 2 m. N. of the city is Crown Hill, which is handsomely laid out and tastefully adorned; and the Catholic cemetery is just S. of the city limits. The state house, in the Doric style, erected in 1835, is 180 ft. long by 80 ft. wide, with a colonnade and dome. The state institute for the

blind was erected in 1847 at a cost of \$300,000; the grounds contain eight acres. The main building has a front of 150 ft. and is five stories high, consisting of a centre and two wings, each surmounted by a Corinthian cupola, the centre also having an Ionic portico. The state lunatic asylum, 1 1/4 m. W. of the city limits, was erected in 1848, and has since been twice enlarged, at an aggregate cost of \$350,000. The principal building has accommodations for 525 patients; the grounds embrace 160 acres, a portion of which is handsomely laid out and adorned. The state institute for the deaf and dumb, just E. of the city limits, was also erected in 1848, and cost \$220,000. The grounds comprise 105 acres, and immediately around the buildings are handsomely laid out, and adorned with trees and shrubbery. The United States arsenal, 1 m. E. of the city, is a handsome building, and is surrounded by grounds containing 75 acres. The union passenger depot, at which all the railroads converge, is 420 ft. long, and is one of the most spacious and convenient structures of the kind in the country. Other prominent public buildings are the post office, governor's residence (occupied by public offices), court house, county jail, city hall, city prison, academy of music, odd fellows' hall, masonic hall, and several of the churches. A new court house, costing about \$900,000, is nearly completed, and the erection of a new state house, to cost about \$4,000,000, has been authorized by the legislature. The city has railroad connection with all parts of the state and with the principal cities of the west. The lines centring here are 10 in number, viz.: the Cincinnati, Hamilton, and Indianapolis; Cleveland, Columbus, Cincinnati, and Indianapolis; Indianapolis, Bloomington, and Western; Indianapolis, Cincinnati, and Lafayette; Indianapolis, Peru, and Chicago; Indianapolis and St. Louis; Indianapolis and Vincennes; Pittsburgh, Cincinnati, and St. Louis; St. Louis, Vandalia, Terre Haute, and Indianapolis; and Jeffersonville, Madison, and Indianapolis. The Indiana and Illinois Central railroad is rapidly approaching completion, and a belt line, encircling the city and connecting all the other lines, is in progress. The number of passenger trains daily leaving and arriving is 75. The number of freight cars forwarded in 1873 was 296,314; received, 286,820. The first impulse to the growth of Indianapolis was the completion of the Madison railroad in 1847. The civil war concentrated a vast temporary business here, the effects of which were largely permanent. The trade is extensive, the aggregate sales of merchandise in 1873 amounting to \$70,830,000. The sales in 1870 were \$36,969,162; in 1871, \$41,851,657; in 1872, \$49,774,789. There is a large grain elevator on the W. side of the river, erected in 1873; several smaller ones have been in operation for some years. The sales of real estate in 1871 amounted to \$7,995,513; in 1872, to \$16,326,491; and in 1873, to \$32,579,253. More than

half of the purchases have been for occupancy. The total cost of buildings erected in 1873 was about \$5,000,000. The manufactures are varied and important. The amount of capital invested in 1873 was \$11,006,000; number of hands employed, 8,176; value of products, \$28,012,740. The statistics of the principal branches are contained in the following table:

MANUFACTURES.	Capital.	Hands.	Products.
Agricultural implements .....	\$400,000	135	\$155,000
Bakery products .....	44,700	90	302,700
Brewery products .....	125,100	45	317,000
Carriages .....	265,100	810	697,000
Cars .....	27,000	170	125,000
Clothing .....	160,000	801	757,000
Confectionery .....	108,000	78	317,000
Cotton goods .....	100,000	68	300,000
Flouring mill products .....	685,000	66	1,926,000
Furniture, &c. ....	482,000	424	1,500,000
Glass .....	185,000	45	250,000
Hog products .....	2,000,000	600	7,614,000
Iron foundries & machine shops ..	878,000	628	1,421,000
Iron, malleable .....	115,000	70	1,175,000
Iron, rolling mills .....	900,000	475	1,560,600
Oil, lard, and lubricating .....	156,100	86	554,100
Flouring mill products .....	462,000	827	679,000
Printing and binding .....	600,000	900	1,250,000
Pumps .....	125,000	129	292,000
Saws .....	100,000	75	100,000
Starch .....	25,000	67	100,000
Sewing machines .....	110,000	200	400,000
Staves .....	117,000	235	627,000
Stoves .....	168,000	175	368,000
Tannery products .....	75,000	22	260,000
Wheels .....	270,000	800	500,000
Woolens .....	295,000	118	620,000

The number of hogs slaughtered was 555,766. The value of manufactures in 1872 was \$19,671,832. There are six national banks, with an aggregate capital of \$3,000,000; two state banks, with \$800,000 capital; two savings banks, and three insurance companies.—The city is divided into 13 wards, and is governed by a mayor and a council of 26 members. There is a well organized fire department and an efficient police force, and the city is well supplied with water. The taxable value of property in 1860 was \$10,000,000; in 1865, \$20,144,447; in 1870, \$27,000,000; in 1871, \$27,999,170; in 1872, \$34,760,871; in 1873, \$65,000,000, the large increase being partly due to a change in the system of valuation. The city debt is about \$1,600,000, and the rate of taxation \$1 10 on \$100. The principal charitable institutions are an asylum for white orphans, supported partly by a city appropriation, and partly by donations; an asylum for colored orphans and a "home for friendless women," supported in the same way; a German orphan asylum, with capacity for 300 inmates; a Catholic female reformatory and asylum, a Catholic infirmary for gratuitous relief of the suffering poor, two societies for the general care of the poor, a large, well conducted city hospital, and a pest house. The reformatory for women and girls and prison for female offenders occupies a commodious structure just E. of the city. The Northwestern Christian university, chartered in 1850, occupies a handsome Gothic building in the N. E. portion of

the city; it admits both sexes, and in 1872-'3 had 13 professors (3 in the law school), 265 students (law department, 10; business department, 50), and a library of 5,000 volumes. The medical department of Indiana university (with which is connected a free dispensary), situated here, was organized in 1869, and in 1872-'3 had 12 professors and 101 students. The city possesses an excellent and well organized system of public schools, embracing the various grades from primary to high school, and including a training or normal school. There are 20 school buildings, of which 10 will accommodate 750 pupils each. The high school will accommodate 550. The value of school property in 1864 was \$38,500; number of children of school age, 6,863, of whom 1,050 attended public schools. In 1874 the value of school property was \$691,256; children of school age, 19,125, of whom 9,868 attended the public schools. There are also a Catholic theological seminary, a Catholic boys' school, and a female seminary conducted by the "Sisters of Providence," recently opened and occupying a splendid building. The state library contains 15,000 volumes. A free city library was opened in April, 1873, in the high school building; it now contains over 14,500 volumes, and a separate building is to be erected for its accommodation. There are 6 daily (1 German) and 13 weekly (5 German) newspapers, and 13 monthly periodicals, one of which, the "National Crop Reporter," has recently been removed from Jacksonville, Ill. The churches, 64 in number, are as follows: 8 Baptist, 5 Christian, 2 Congregational, 5 Episcopal, 1 Friends', 16 Methodist, 10 Presbyterian, 4 Roman Catholic, 1 Swedenborgian, 2 Unitarian, 2 Universalist, and the rest miscellaneous, some of which have no church edifice.—Indianapolis was first settled by John Pogue in March, 1819, and in about a year from that time it numbered 15 families. It was chosen as the seat of the state government in January, 1821 (though the capital was not actually removed from Corydon till 1825), and at the same time the legislature gave it its present name and appointed commissioners to lay it off as a town. It was incorporated in 1836, and received a city charter in 1847.

**INDIAN ARCHIPELAGO, or Malay Archipelago.** a vast aggregation of insular groups S. E. of the continent of Asia, lying between the China sea, the Indian ocean, and the Pacific. In the widest sense it includes the Philippine islands and Papua, and extends from about lon. 95° to 151° 20' E., and from lat. 19° 40' N. to about 11° S., being about 2,100 m. wide and upward of 4,000 m. long, and bisected by the equator. With the exception of Australia, the Indian archipelago contains the largest islands of the world, namely, Borneo and Papua. These, together with Gilolo, Celebes, and Sumatra, form a range extending along the equator, and all except Papua crossed by it; a similar but shorter range, further S., is made up mainly of Java,

Sumbawa, Flores, and Timor; and in the north the principal islands are Mindanao and Luzon, of the Philippine group. The seas which separate the islands are variously designated. These are: the Java sea, between Java and Borneo; the Sooloo sea, between Borneo and the Philippines; the Celebes sea, between the Philippines and Celebes; the Flores sea, between Celebes and the Timor group; and the Banda sea, between Celebes and Papua. The depth of water between the Asiatic mainland and Sumatra, Java, and Borneo, respectively, nowhere exceeds 100 fathoms, nor is the sea between Papua and Australia deeper than this; but these shallow seas are divided by a line of deep water in which lie Celebes, the Moluccas, Flores, and the adjacent islands. Wallace regards the archipelago as naturally comprehending the Malay peninsula, S. of Tenasserim, the Nicobar islands, and the Philippines. Exclusive of the latter, he classifies its islands into five groups, as follows: 1, the Indo-Malay islands, comprising the Malay peninsula and Singapore, Borneo, Java, and Sumatra; 2, the Timor group, comprising the islands of Timor, Flores, Sumbawa, and Lombok, with several smaller ones; 3, Celebes, comprising also the Sula islands and Booton; 4, the Molucca group, comprising Booro, Ceram, Batchian, Gilolo, and Morty, with the smaller islands Ternate and Tidore, Makian, Kaioa, Amboyna, Banda, Goram, and Matabello; and 5, the Irian group, comprising Papua, with the Iroo islands, Mysol, Salawaty, Waigioo, and several others. The area in English square miles of some of the principal islands is approximately as follows:

Amboyna .....	300	Ceram .....	
Bali .....	2,200	Flores .....	
Banca .....	5,000	Gilolo .....	
Banda .....	130	Java and Madura ..	
Batchian .....	500	Lombok .....	
Booro .....	2,000	Sumatra .....	
Borneo .....	300,000	Sumbawa .....	
Celebes .....	70,000	Timor .....	

It will be seen that neither Papua nor the Philippines are embraced in this table. The latter islands are chiefly under the domain of Spain, but in the other parts of the archipelago the government of the Netherlands is the predominant power. According to the latest returns, principally of 1871-'72, the colonial possessions of the Dutch in the archipelago have an aggregate area of about 24,000 sq. m. and a total population of 24,000,000. They comprise the whole of the island of Sumatra, extensive territories in Borneo, Sumatra, the Moluccas, and about 29,000 sq. m. in Papua.—Physically, the most striking and characteristic division of the archipelago is into volcanic and non-volcanic regions. A long line of active and extinct volcanoes, constituting one of the most remarkable volcanic systems in the world, extends from Sumatra eastward through Java, Bali, Lombok, Sumbawa, Flores, and beyond which it trends northward to Banda, Amboyna, and

of Celebes, and thence to the Philippines. The islands traversed by this subject to frequent earthquakes. The volcanic regions lie on both sides of it. There are no volcanoes in Papua or Borneo, and inter island earthquakes are unknown. The highest mountains in the archipelago are in Borneo, and Sumatra, where numerous rise to a height of 10,000 ft. and some higher. The climate is one of almost uniform warmth and moisture, giving rise to a luxuriant forest growth, which exists on all the islands except Timor and immediately around it; in these there is a deficiency of rain, which is attributed to the influence of the arid regions of Australia. The line of separation between the two great provinces, known as the Indian and the Australian, divides the archipelago, passing between Celebes and Borneo, and through the Strait of Lombok. This is but 15 m. according to Lyell, the contrast between the animals on the two sides of this line is as great as between those of the old world. West of it the fauna is strictly Australian in character; and it is conjectured that the great regions thus distinguished once respectively of the Asiatic and Australian continents. The geographical division of the two typical races of men in the archipelago corresponds closely to the animals; the Indo-Malays being the western islands, while the Papuans are the principal islands of the Indian Ocean will be found under their respective names.

For their general history, see "The Archipelago, its History and Present Condition," by Horace St. John (2 vols. 12mo, 1853). The natural history of the islands is ably treated in "The Malay Archipelago," by Alfred Russel Wallace (London, 1869). See also "Travels in the East Indian Archipelago," by Albert S. Bickmore (8vo, 1869).

**BEAN.** See CATALPA.

**CORN.** See MAIZE.

**CRESS.** See NASTURTIUM.

**CUCUMBER,** a name given to *Medeola* *virginica*, a common and striking plant of the woods, which is found in May and June in the swamp woods from Canada to Florida. Its remarkably white tuberous root stock is 1/2 in. long and 1/4 in. thick, and has the appearance of a cucumber; it is said to have been eaten by the Indians, whence the common name. The slender stem, 1 to 3 ft. high, is clothed with a whitish wool which renders it inedible; near the middle it bears a whorl of three obovate, lanceolate pointed leaves; the summit are three flowers, the lower which is and the smaller leaves. The three petals are a bluish yellow.

stamens six, pistil one with three long thread-like brownish styles diverging from the top of the globose ovary, which in ripening forms a dark purple berry of the size of a pea. The



Indian Cucumber (*Medeola virginica*).

botanical name is the diminutive of *Medea*, the sorceress, probably given to the plant on account of reputed medicinal powers; it really possesses very little activity, though the elder Barton thought it serviceable in dropsy.

**INDIAN DYE.** See PROCOON.

**INDIAN FIG** (*Opuntia vulgaris*). See CACTUS.

**INDIAN HEMP.** L A variety of hemp produced in India, formerly supposed to be a distinct species, and called *cannabis Indica*. (See



3 ft. high, with opposite, mucronate leaves, which are smooth or downy, and numerous, many-flowered cymes. The flowers are small, bell-shaped, greenish white, the corolla with five triangular appendages in the throat; stamens five, inserted on the base of the corolla, and slightly adhering to the stigma by their filaments; fruit of two long slender follicles with silky tufted seeds. It has a milky juice, and the bark has an exceedingly tough fibre, the use of which by the aborigines for making cordage, fishing nets, &c., no doubt gave it the common name. We know of no extensive experiments in utilizing this fibre, which is whiter and stronger than that of hemp. The root of this plant is sometimes used in medicine, it being powerfully emetic and cathartic in doses of 15 to 80 grains of the powdered dry root, or a similar amount in the form of a decoction; it has been found efficacious in dropsy. It grows in most of the states, and has other local names; in South Carolina it is known as Gen. Marion's weed, as that leader is said to have used it in the diseases of his camp. Another species, *A. androsæmifolium*, equally common, is a more spreading plant, with much larger pale rose-colored flowers, and used as a prompt emetic; it is known as dogbane and bitter-root.

**INDIAN LANGUAGES, American.** See AMERICAN INDIANS, LANGUAGES OF THE.

**INDIAN OCEAN**, the third in size of the oceans of the world. It is bounded N. by Asia, N. E. by the Malay peninsula and the Sunda islands, E. by Australia and the meridian of Cape Leeuwen on the S. W. coast of that continent, S. by the Antarctic circle, and W. by Africa and the meridian of the cape of Good Hope. The south China sea and all the waters south and west of the Philippine isles and New Guinea are sometimes included in the limits of the Indian ocean; but they are much more properly apportioned to the Pacific basin, the Sunda islands and Malay peninsula representing the isthmus connecting the northern and southern halves of the continent of Asia-Australia. The southern limit, and the eastern and western S. of the continents of Australia and Africa, are of course entirely artificial. The northern shore of the Indian ocean is deeply indented by the peninsula of India, forming two large bays, the Arabian sea and the bay of Bengal. Two considerable gulfs, or more properly inland seas, are in communication with this ocean, the Red sea and the gulf of Persia. It is not rich in islands, of which only two, Madagascar and Ceylon, are of considerable size. The smaller ones constitute mostly archipelagoes, such as the Comoro, Mascarene, Amirante, Seychelles, Maldivæ, Laccadive, Andaman, Nicobar, Chagos, and Keeling islands, in the tropics, and the Kerguelen, Crozet, and Macdonald islands, in the colder southern part. There are also a few isolated volcanic islands, such as New Amsterdam and St. Paul. Most of the tropical islands are of coral formation; a few

are volcanic with fringing or barrier reefs, such as the Mascarene and Andaman islands. The Asiatic coast is mostly free of coral, but there are some fringing reefs on the coasts of Ceylon and Madagascar, Africa, and the Red sea. The only important African river falling into this ocean is the Zambesi. Asia contributes the united stream of the Euphrates and Tigris, the Indus, Ganges, Brahmapootra, and Irrawaddy; Australia almost nothing. The system of currents is rather complicated, but in its main features resolves itself into a revolving current moving from right to left, as in all the ocean basins of the southern hemisphere. The equatorial part of it, the S. E. trade current moving from E. to W., is very broad, its middle being about lat. 15° S., but it does not really reach the equator. It strikes the coast of Madagascar, dividing into two branches. The one passing N. of that island bends S. through the Mozambique channel, forming the powerful and warm current of the same name; it is joined again by the S. branch near the coast of Africa, forming the Agulhas current off the cape of Good Hope, which after barely passing that cape turns back sharply to the south and east, and forms with the antarctic drift the retrograde current in lat. 37° to 42° S. Before reaching Australia it divides into the S. and E. Australian currents, the latter completing the circuit by re-entering the S. E. trade current after giving off branches running into the Java and Flores seas and Torres straits. The N. equatorial current is overcome by the monsoons, and, under the name of Malabar current, flows westward from October to April, and eastward from April to October. It extends from the coast of Africa around Ceylon into the bay of Bengal. A narrow retrograde current has been observed flowing E. across this ocean, nearly under the equator or a little S. of it. The monsoons prevail from its northern limit to lat. 8° S. North of the equator the N. E. monsoon blows from October to April, the S. W. prevails in the other half of the year; while S. of it the N. W. monsoon blows while the N. E. is blowing on the N. side, and *vice versa*. Between the limits of lat. 10° and 28° S., the S. E. trade wind blows from April to October. South of these are the constant N. W. winds, which prevail almost in the same latitudes as in the Atlantic and Pacific oceans. The periods at which these winds change are marked by violent tempests, and the region between lat. 5° and 40° S. is greatly subject to hurricanes. They range usually between lat. 9° and 35° S., extending from Madagascar to the island of Timor; they come generally from the N. E. near Java, and travel S. W. and S., returning again E. The depth of the sea is greatest near the S. coasts of Asia; the Arabian sea is from 2,000 to 2,500 fathoms deep; the bay of Bengal averages nearly 2,300 fathoms. Opposite the Hoogly river, in the bay of Bengal, is a shallow and deep depression in the ocean bed, called

"the bottomless pit." Near the S. E. coast of Africa the depth varies from 1,300 to 1,900 fathoms.—The northern part of the Indian ocean is the theatre of an immense navigation, nearly the whole commerce of Europe and America with China and India and the great Malay archipelago passing over its waters; while between Arabia and Persia on the west and India on the east an extensive trade is carried on in native vessels, the origin of which dates from the remotest antiquity. The great Pacific railroad, opened in 1869, has deprived the Indian ocean of some of its navigation; but the Suez canal, which was opened a few months later, is expected to increase it. The European-Indian commercial navigation amounted in 1872 to nearly 12,000,000 tons. The southern part of this ocean is comparatively little frequented, being almost destitute of islands. It is traversed chiefly by vessels going to Anstralia and New Zealand by way of the cape of Good Hope. The chief ports of the Indian ocean and its tributary gulfs and rivers are Mozambique and Zanzibar in Africa, Aden and Mocha in Arabia, Bassorah in Turkey, Bushire in Persia, Bombay, Surat, Madras, and Calcutta in India, and Trincomalee and Pointe de Galle in Ceylon.

**INDIANOLA**, a town and the capital of Calhoun co., Texas, port of entry of the district of Saluria, on the W. shore of Matagorda bay, 140 m. S. by E. of Austin, and 120 m. S. W. of Galveston; pop. in 1870, 2,106, of whom 492 were colored. It is the terminus of the Gulf, Western Texas, and Pacific railroad (completed in 1873 to Cuero, De Witt co., 66 m.), which is to connect it with Austin and San Antonio. Steamers run regularly to Galveston and Corpus Christi. The commerce is important. For the year ending Aug. 31, 1872, there were entered in the coasting trade 242 vessels of 188,453 tons, of which 149 of 174,270 tons were steamers; cleared, 250 vessels of 194,896 tons, of which 146 of 170,052 tons were steamers. The receipts were 5,808,000 feet of lumber and 2,750,000 shingles; shipments, 27,461 head of animals, 11,549 bales of cotton, 330,875 hides, and 3,234 bags of wool. The value of imports from foreign ports was \$42,463; of exports to foreign countries, \$58,658. A weekly newspaper is published.

**INDIAN POKE.** See HELLEBORE.

**INDIANS.** See AMERICAN INDIANS.

**INDIAN SHOT**, a popular name for species of *canna*, especially *C. Indica*, which was for a long time the only one generally cultivated. *Canna* (from the Celtic *cann*, a cane) was formerly placed in the same family with the ginger and the banana, but botanists now make an order, the *cannaceae*, which includes this, the arrowroot, and some other less known plants. The cannas have large, fleshy root stocks, tall stems clothed with large showy leaves, and bearing at the summit a spike of often handsome flowers of various shades of yellow, scarlet, and crimson; the flowers are irregular in structure; they have three outer colored di-

visions or calyx, within which are three parts corresponding to a corolla with a single stamen which has a petal-like filament and bears an anther on its margin; pistil with a petal-like style and a three-celled ovary, which in ripening becomes a several-seeded very rough pod; the seeds are round, hard, and black, and sufficiently shot-like in appearance to warrant the common name. One species, *C. flaccida*, is found in swamps along the coast from South Carolina southward; it grows 4 ft. high and has yellow flowers 3 or 4 in. long. The tubers of some species are edible and used as a table vegetable, while others have slight medicinal properties; the kind of arrowroot called *tous les mois*, chiefly used by the French, is made in the island of St. Christopher from the rhizomes of a canna, supposed to be *C. edulis*. The great interest possessed by the cannas is due to their effectiveness as decorative plants. Since beauty of form and stateliness of habit



Indian Shot (*Canna Indica*).

have come to be properly appreciated in gardening, great improvement has been made in cannas, and cultivators, especially those in the south of France, have by hybridizing and crossing obtained splendid results. In the now valued kinds the original species is lost, and they are known by garden rather than botanical names. There are now varieties from 2 ft. to 8 and 12 ft. high, with a remarkable diversity of foliage; in some the leaves are narrow, stiff, and erect, in others broad, very long, and graceful, while their shades of color vary from light glaucous green to blackish purple. While some are valued for their fine foliage only, others produce an abundance of handsome flowers, which have also been improved, and there can be nothing more effective than a well arranged group of the finer varieties of canna. The choice varieties are multiplied by division, and plants are readily raised from seed, which may or may not be like the parent; the seeds should



be scalded, and sown in a hotbed; they will germinate in the open ground, but the plants will not acquire much size the first year. The roots should be taken up at the first frost and kept in a dry place where they will not freeze; the next spring they are to be divided and set out when the soil has become warm.

**INDIAN TERRITORY**, an unorganized portion of the United States, situated between lat. 33° 35' and 37° N., and lon. 94° 20' and 103° W.; length E. and W. along the N. border 470 m., and S. of lat. 36° 30' about 310 m.; breadth W. of the 100th meridian 35 m., and E. of that line about 210 m.; area, 68,991 sq. m. It is bounded N. by Colorado and Kansas, E. by Missouri and Arkansas, S. by Texas, from which E. of the 100th meridian it is separated by the Red river, and W. by Texas and New Mexico. The inhabitants are not regularly enumerated in the census of 1870, but the superintendent, from inquiries made through the agents of the Indian office, states the population at 68,152, of whom 2,407 were whites, 6,378 colored, and 59,367 Indians. Of the Indians, 24,967 were on reservations or at agencies, and 34,400 were nomadic. Besides a considerable portion still unassigned, the territory contains 17 Indian reservations. The Cherokees occupy an area of 5,960 sq. m. in the northeast, E. of the 96th meridian, and bordering on Kansas and Arkansas; they also own a strip about 50 m. wide along the Kansas border from the Arkansas river W. to the 100th meridian, about 8,500 sq. m. The Choctaw reservation, 10,450 sq. m., is in the southeast, bordering on Arkansas and Texas. Joining this on the west, and separated from Texas by the Red river, is the Chickasaw reservation, 6,840 sq. m. The Creeks occupy 5,024 sq. m. in the E. central part of the territory, bordering on the Cherokees and Choctaws. S. W. of the Creeks is the Seminole reservation, 312½ sq. m., and N. of this the reservation of the Sacs and Foxes, 756 sq. m. W. of the Seminole reservation is a tract of 900 sq. m. upon which are settled the citizen Pottawattamies and the Absentee Shawnees. The Osage reservation, 2,345 sq. m., is W. of that of the Cherokees, and is bounded N. by Kansas and S. W. by the Arkansas river. N. W. of the Osages, and bounded N. by Kansas and W. by the Arkansas, is the reservation of the Kaws, 156 sq. m., to which they were removed from Kansas in the summer of 1873. In the S. W. part of the territory, and bounded E. by the Chickasaws, are the Kiowas, Comanches, and Apaches, occupying 5,546 sq. m.; and N. of these are the Arapahoes and Cheyennes, with 6,205 sq. m. The Quapaws, the confederated Peorias, Kaskaskias, Weas, Piankeshaws, and Miamies, the Ottawas, the Shawnees, the Wyandots, and the Senecas severally have reservations, with an aggregate area of 297 sq. m., in the N. E. corner of the territory, E. of the Neosho river. The affiliated bands of Wichitas, Keechies, Wacoos, Tawacanies, Caddoes, Ionies, Dela-

wares, and Penetethka Comanches are gathered at an agency on the Washita river W. of the Creek country, but they have no reservation. The Modocs (remnant of Captain Jack's band) and about 400 Kickapoos and Pottawattamies (from the border of Texas and Mexico) were removed to the Indian territory in the latter part of 1873. The former were placed temporarily on the Shawnee reservation, and the latter were settled on a tract on the Kansas border W. of the Arkansas river.—The surface has a general declination toward the east, but the only considerable elevations are the Wichita mountains in the southwest, and a continuation of the Ozark and Washita mountains from Arkansas in the east. Otherwise the E. portion of the territory and that S. of the Canadian river spreads out into undulatory plains, while the N. W. portion consists of elevated prairie. It is watered by innumerable streams, tributaries of the Arkansas and Red rivers. The former flows from Kansas in a S. E. direction through the N. E. corner of the territory into Arkansas, and is navigable in high stages of water to Fort Gibson in the Cherokee country. On the east its principal tributaries are the Verdigris, the Neosho, and the Illinois, which have a S. course. On the west the two principal branches are the Canadian and the Red fork. The Canadian river rises by two forks in New Mexico, which flow E., the S. fork first through the N. W. projection of Texas, traverse nearly the whole length of the territory, and uniting join the Arkansas near the E. border. The Red fork enters the territory from Kansas under the name of the Cimarron, and flowing S. E. joins the main stream N. of the Canadian. N. of the Red fork and having the same general direction is the Salt fork or Little Arkansas. The chief tributary of Red river is the Washita, which rises in N. W. Texas, and flowing S. E. joins the main stream near the S. E. angle of the Chickasaw country. Other affluents of Red river, commencing at the east, are the Kimishi, Boggy creek, Blue river, Mud creek, Beaver creek, Cache creek, and the North fork. Red river is navigable by small steamers in ordinary stages of water along nearly the whole S. border. In the west and northwest are extensive deposits of gypsum, and in the Cherokee country are found coal, iron, good brick clay, marble in places, and yellow sandstone suitable for building purposes. The climate is mild and salubrious, but generally dry. The mean annual temperature in the S. E. is 60°; in the N. W. 55°. The annual rainfall, which in the S. E. extremity of the territory is 52 in., decreases to 35 in. in the central region, and is less than 20 in. in the N. W. corner. The Wichita range is intersected by many fertile valleys abounding in wood, water, and grass, and generally the country S. of the Canadian is interspersed with prairie and timbered land, possessing a fertile soil overgrown with nutritious grasses. The N. E. portion of the territory is well wooded, and while there is consid-

arable and productive land, much of it is and only fit for timber or pasture; three of the Cherokee country is of this character. Between lon. 97° and 98° a narrow strip, called the "Cross Timbers," stretches on the Red fork of the Arkansas S. and S. of Texas. W. of this and N. of the Canadian a sterile region, scantily overgrown with producing only a few stunted shrubs, cacti, &c., and covered in places with saline deposits.

The most common trees and shrubs are cottonwood, oak, sycamore, elm, walnut, yellow pine, pecan, Osage orange, hawthorn and the grape vine. Indian corn is the crop. Wheat is also raised, as well as peas, beans, pumpkins, potatoes, and other cereals, and upland rice. Cotton was formerly

largely cultivated S. of the Canadian and on the Arkansas and Red rivers, and is still grown there to some extent. Apples do well N. of the Canadian and Arkansas, and peaches, pears, plums, cherries, and small fruits flourish. Among wild animals may be mentioned the prairie dog, the deer, and vast herds of buffalo and wild horses that roam over the W. plains. Wild turkeys are abundant. Large herds of horses and cattle were formerly owned by the Cherokees and other civilized tribes, but they were dispersed and driven off during the civil war, which prostrated the industries of the Indians, and from the effects of which they have not yet recovered. The following table is compiled from the report of the commissioner of Indian affairs for 1873:

TRIBES.	Acres of land cultivated.	Wheat, bushels.	Indian corn, bushels.	Oats, bushels.	Potatoes, bushels.	Hay, tons.	Lumber saved, feet.
Cherokees	59,250	66,650	629,600	85,000	10,000	50,000	480,000
Chickasaws	20,000	10,000	75,000	10,000	25,000	25,000	50,000
Choctaws	50,000	10,000	100,000	10,000	20,000	50,000	3,000,000
Creeks	81,000	600	500,000	1,000	75,000	10,000	.....
Kaw	4,871	2,184	64,748	8,250	4,110	1,875	.....
Neosho	7,600	.....	150,000	.....	4,000	400	50,000
Quapaw	5,869	190	81,210	1,500	10,800	1,470	250,468
Indian Territory	217,790	92,574	1,599,858	60,750	198,470	182,745	3,920,468

were also raised 5,000 bushels of barley, of beans, 1,584 of peas, 6,500 of turnips, rice, 4,000 lbs. of sugar, and 5,000 bales ton (2,000 by the Chickasaws and 3,000 Choctaws). The value of furs sold was \$60. The productions in 1872 were 100,000 bushels of wheat, 6,562,540 of Indian corn, 9 of oats, 281,000 of potatoes, 700 of 1,000 of rice, 27,624 tons of hay, 1,200 tobacco, 86,000 gallons of sorghum molasses and 570 bales of cotton. The total value of productions was \$4,168,982, viz.: Cherokees, \$1,155; Chickasaws, \$219,000; Choctaws, \$797; Creeks, \$537,325; Quapaw, &c., \$1; Seminoles, \$159,500; other tribes, \$74. There were 2,350,000 feet of lumber (2,000,000 by the Cherokees). The value of furs sold was \$102,020, chiefly by the Cherokees and Arapahoes, Osages, Kiowas, &c. The number and value of live stock in 1872 were as follows:

TRIBES.	Horses.	Cattle.	Sheep.	Swine.	Value.
Cherokees	15,000	108,902	3,050	65,568	\$1,561,069
Chickasaws	85,000	50,000	2,000	75,000	1,354,000
Choctaws	100,000	100,000	8,000	150,000	3,816,000
Creeks	15,000	25,000	.....	100,000	1,170,000
Kaw	891	997	.....	3,621	67,906
Neosho	2,500	10,500	50	25,000	217,850
Quapaw	43,764	22,555	.....	7,956	1,441,694
Indian Territory	312,155	322,854	18,100	430,445	\$9,408,178

Roads in the territory are the Missouri, Kansas, and Texas (from Sedalia, Mo., on the Missouri Pacific line, to a junction with the Missouri and Texas Central, at Denison, Tex.),

which crosses the E. part, and the Atlantic and Pacific, from Pacific, Mo., on the Missouri Pacific, to a junction with the Missouri, Kansas, and Texas, at Vinita in the Cherokee country. The total mileage in the territory is 269.—Indian territory forms the greater part of the central Indian superintendency, and contains 11 agencies, viz.: the Cherokee, Choctaw (including also the Chickasaws), Creek, Kaw, Kiowa, Neosho (Osages), Quapaw, Sac and Fox (including also the Absentee Shawnees), Seminole, Upper Arkansas (Cheyennes and Arapahoes), and Wichita; for each of which an agent is appointed by the president with the consent of the senate, to represent the United States; but each tribe has its own internal government. The jurisdiction of the United States courts for the W. district of Arkansas extends over the territory in civil actions where a white man is a party, in case of crimes committed by or upon a white man, and in proceedings for violation of the laws regulating trade and intercourse with the Indians. The subject of a territorial government has been much discussed both among the Indians, who in a general council in 1870 framed a constitution, and in congress; but difference of views between congress and the tribes has hitherto prevented its organization. The United States have adopted the policy of settling the various Indian tribes in this region as far as practicable upon separate reservations, where they may be free from the encroachment of the whites, and under the general superintendence and protection of the government. The greater part of the inhabi-

tants have thus at various periods been removed from different parts of the Union, but some are indigenous to the territory. Some tribes, as the Kiowas and Comanches, are still in a wild state, while others, as the Cherokees, Choctaws, and Creeks, are well advanced in civilization. The capital of the Cherokee nation is Tahlequah; of the Chickasaws, Tishomingo; of the Choctaws, Armstrong Academy; of the Creeks, Okmulkee; of the Seminoles, We-wo-ka. The following table from the report of the commissioner of Indian affairs gives the population, value of property, number of schools, &c., for 1873:

TRIBES.	Population.	Value of individual property.	No. of schools.	Teachers.	Scholars.
Cherokees.....	17,217	\$5,000,000	68	65	1,584
Chickasaws.....	6,000	2,000,000	18	14	480
Choctaws.....	16,000	4,746,000*	50	52	1,129
Creeks.....	13,000	3,118,200*	34	43	700
Quapaws, &c.....	1,219	219,241	4	4	208
Seminoles.....	2,438	400,500	4	4	157
Other tribes.....	16,594	1,543,503	9	30	266
Entire territory..	72,468	\$17,022,583	176	216	4,769

The second column does not include the value of land, which is held in common, nor of stocks and funds held in trust by the United States under treaties with various tribes, the interest on which is annually paid to such tribes for the support of schools or for general purposes. Most of the schools are supported by the tribal funds, but some are carried on by the missionaries. In 1872 (no returns from the Chickasaws and Choctaws) there were 598 frame and 8,823 log houses, viz.: Cherokees, 500 frame and 3,500 log; Creeks, 35 frame and 4,200 log; Seminoles, 500 log houses; other tribes, the rest. The Cherokees have an orphan asylum with 90 inmates. Three weekly newspapers are published in the territory, one (English and Cherokee) at Tahlequah, the other two in the Choctaw country, one (English and Choctaw) at New Boggy, and one (English) at Caddo. On March 1, 1873, there were 28 post offices, viz.: Cherokee country, 6; Chickasaw, 4; Choctaw, 12; Creek, 4; Seminole, 1; Kiowa, &c., 1. Under the existing regulations of the Indian bureau, the agents of the Cherokees and Creeks are nominated by the Baptists; of the Choctaws and Chickasaws, and the Seminoles, by the Presbyterians; of the other tribes, by the Orthodox Friends. The Methodists, Presbyterians, and Baptists have each several missions, and one or more are maintained by the Friends, Moravians, and Roman Catholics. According to the report of the board of Indian commissioners for 1872, there were 7,170 church members, viz.: Cherokees, 2,450; Choctaws and Chickasaws, 2,500; Creeks, 2,050; Seminoles, 90; other tribes, 80.—The act of June 30, 1834, regulating trade and intercourse with

\* Report of the board of Indian commissioners for 1872.

the Indians, declares that "all that part of the United States W. of the Mississippi, and not within the states of Missouri and Louisiana, or the territory of Arkansas," shall for the purposes of that act be considered the Indian country. The vast region thus defined, identical with the then territory of Missouri, formed part of the Louisiana purchase from France in 1803. Reduced by the successive formation of states and territories, the remainder now constitutes the whole of the district described at the beginning of this article except the narrow strip W. of the 100th meridian, which was ceded by Texas to the United States, and is classed geographically with the Indian territory for convenience. (For further information, see the articles on the different tribes.)

**INDIAN TOBACCO.** See LOBELIA.

**INDIA RUBBER.** See CAOUTCHOUC.

**INDICTMENT** (said to be derived, through the French *enditement*, *enditer*, from the Latin *indicare*, to point out, or, as some suppose, from *indicare* and *indictus*), a written accusation of an offence, preferred to, and presented upon oath as true by, a grand jury. Indictments are to be preferred in criminal matters only, and they lie for all treasons and felonies, for all misprisions (that is, concealments) of treasons and felonies, and for all misdemeanors of a public nature. The course of procedure is this: Upon information by parties who are cognizant of the criminal acts alleged, an indictment is framed by the proper prosecuting officers, and laid before the grand jury. If the jurors, after hearing the evidence, do not find "a true bill," the party, if in custody, is entitled to be discharged without further answer. If the bill, on the contrary, be found to be a true bill, it is returned into court, and the party stands indicted and may be required to answer to the charges made against him. (See JURY.) In respect to its form, the indictment is intended to be a plain and certain narrative of the offence charged, and of the necessary circumstances that concur to ascertain and define the fact and its nature. It can perhaps be no longer made a reproach to the law that it demands, in the words of Chief Justice Hale, "unseemly niceties" in the framing of indictments, and yet the reason for and requirement of singular exactness still remain. In the first place, it is the plain right of the accused to know that he has been legally indicted. To this intent, the bill must show with reasonable certainty that it was presented to and proceeds from a court of competent jurisdiction in the case; that the place where it was found was within its jurisdiction; and lastly, that it was found upon the oaths of at least 12 jurors, who must further appear to have been of the county or other limits of the court's jurisdiction. The insertion of the jurors' names is not necessary. The indictment must be certain as to the name of the accused, and should repeat it with every

allegation. In general a mistake in is fatal, though a mere misspelling of sound be rendered aright, may not be indictment. If several joined in commission of the offence, as in assault or all may be joined in the bill, or each indicted separately. Yet when the offence in its nature distinct and individual, or the utterance of blasphemous words, there can be no joinder, though the offenders were guilty of the same offence. The place of every material fact must be averred. Generally, however, it is necessary to prove the commission of the offence at the precise place and time laid. It is material if it appear to have been committed within the jurisdiction of the court, and on a date previous to the finding of the bill, if within the period during which the offence may be prosecuted. But if the time is an essential element of the crime, the relation in either respect between the charge and the proof is fatal. If it be necessary to aver the facts in legal instruments, their dates must be stated. The date is also material when the offence is preferred for preferring indictments is prescribed by law, or when statutes of limitations are applicable. In the statement of the offence, the indictment must recite explicitly the facts which constitute the alleged crime, and not merely their supposed legal bearing. It is the office of the bill to exhibit the facts, and not to aver their legal consequence. A particular offence must be alleged. To charge a defendant with one of two offences distinct, as "forged or caused to be forged," is insufficient; and so it is to describe him as a "common thief" or a "common offender," as "common thief" or a "slanderer." Yet one may be indicted as a "common barretor," or as a "keeper of a common bawdy house," for in these cases the habitual character makes the particular offence.—In the description of some crimes technical words and terms must be employed, as "traitorously" in indictments for treason, and "feloniously" in all charges of felony; "kill and murder" in charging murder, and "took and carried away" in a charge of simple larceny. In indictments under a statute it is sufficient to describe the offence in the words of the statute. The indictment must be in the prescribed form, where given by the state constitution. It is sufficient in the words, "against the peace and of the state or commonwealth."

**East.** See EAST INDIES, and INDIA.  
**West.** See ANTILLES, and WEST IN-

INDIA, a vegetable dyestuff, known to the ancients by the name of *indicum*, from its being brought into Europe from India. The name now appears to have been applied to it from the East; also, but in this case usually qualified by the epithet *nigrum*. So little was

known of the real nature of this substance, which for centuries had been employed in painting and dyeing, that as late as the year 1705 it was spoken of as a mineral in letters patent issued in Halberstadt, Germany. The use of indigo in dyeing was probably introduced into Italy as early as the 11th century. With the establishment of direct trade with India by sea, supplies of it were more easily obtained, and after the discovery of America a similar product was brought from the new world. Francisco Hernandez speaks of it as in use by the Mexicans, the pigment being called *mohuilli* and *tleuohuilli*, signifying the same as the Latin name for it, *caruleum*. In the beginning of the 17th century the importations of indigo from the East Indies into Holland assumed no little importance. In 1631 there was brought by seven vessels 333,545 lbs., estimated to be worth \$500,000. Its introduction caused great complaint by the Germans on account of its superseding the indigenous



*Indigofera tinctoria.*

woad. Its use was prohibited by the diet in 1577, and it was denounced under the name of the devil's dye as a pernicious, deceitful, corrosive substance. The people of Nuremberg, who cultivated woad, enacted a law compelling the dyers to take an oath annually not to use indigo, and this they were still obliged to do long after the dye was in universal use. By the French government the use of indigo was forbidden in the province of Languedoc in 1598, and the law was long enforced. A similar outcry was raised against it in England in the reign of Elizabeth, and in 1581 it was condemned by act of parliament, and persons were authorized to search for and destroy it and logwood also in any dye house. This law remained in force nearly a century.—Indigo is a product of numerous plants belonging to the order *leguminosae*, and indigenous to the tropical regions of Asia, Africa, and America. The genus *indigofera* contains about 220 spe-

cies, several of which yield the indigo of commerce. *I. tinctoria* is the one most cultivated in the East, and *I. nil* is the most employed in America; these two species are found naturalized in the southern states as remains of former cultivation. *I. Caroliniana* and *I. leptosepala* are indigenous species from North Carolina southward, and are said to be useful in domestic dyeing. Indigo is also yielded by a few other genera of *leguminosa*. These plants contain the coloring principle in their leaves, in the form of a colorless substance which is brought out and rendered apparent by its oxidation as the leaves dry, or is developed by submitting green leaves to a process of fermentation and oxidation. The *I. tinctoria* is cultivated both in the East and West Indies. It is a shrub, though sometimes cultivated as an annual, 4 to 6 ft. high, with pinnate leaves and rose-colored papilionaceous flowers. The seeds are sown in March and April in a light soil, and harrowed in. Weeds are removed, but after a few showers the plants cover the ground, keeping out all other vegetation. Before they have reached their full height the plants should be cut, always early in the morning, and carried the same day to the factory. Here they are laid at once in a stone cistern 20 ft. square and 3 ft. deep. Hurdles are placed upon them, and heavy beams are laid across these and secured to the sides of the vat, the object being to keep the plants down when they swell. Water is then admitted so as to cover the plants. Fermentation soon commences, and may be allowed to go on for 10 to 14 hours, according to the condition of the plants, the temperature, and the weather. The liquor is in commotion as if boiling; frothy bubbles rise to the surface, and their color, first white, becomes grayish blue and then deep purple, and finally a copper-colored scum covers the surface. When the agitation subsides the liquor is drawn off into a lower vat; and the beams and hurdles being removed from the upper one, the steeped plants are taken out to be dried for fuel, and the vat is prepared for another charge. Several men enter the lower cistern and beat up the liquid with their hands or with paddles till the coloring matter begins to appear in small atoms. This may require an hour and a half. The appearance of a precipitate as fine as small sand, leaving the water clear, indicates favorable progress; the beating is then discontinued, and the vat is left a few hours for the indigo to subside. The liquor is then run off from an upper vent, and after this the indigo from a lower one; or the latter is sometimes left in part as the water is drained away, and is then gathered up by a person entering the vat. Lime and gum have been employed to hasten the precipitation, but their use is considered objectionable from their supposed injurious effect upon the quality of the indigo. The pulpy precipitate is next freed by standing in another cistern from more of the water mixed

with it, and is then passed through a strainer into a boiler, in which it is heated to ebullition, and by some kept boiling for five or six hours. Being freed from scum, it is drawn off into a vat, from which, after subsiding, more water is taken off the top, and the rest is removed to the dripping vat, a wooden case having its floor perforated with holes and covered with a woollen cloth. The liquor passes through this filter, and the operation is completed by subjecting the residue to the action of a press, forming it into a cake, which is cut by a wire into 64 square blocks. These are laid out upon hurdles to dry in the shade, and left for several days or weeks in the drying house before packing. By the other method the leaves separated from the stems are dried in the sun, and then stored. When a large quantity is collected they are infused with six times their bulk of water, and stirred for two hours till the leaves all sink. The liquor is then drawn off, beaten, and further treated as in the process already described.—The Asiatic commercial indigo is brought from the several parts of India, and from Java and Manila. It differs much in quality and in shades of color. The best Bengal indigo shipped from Calcutta is the superfine or light blue, in cubical cakes, so light as to float upon water, friable, soft, of clean fracture, and of beautiful copper color when rubbed with the nail. Other qualities are of shades of violet, red, and copper color. The African indigoes from Egypt and Senegal are fine blues, but generally contaminated with earthy matters. The best American qualities, as some of those from Guatemala and Caribon, are equal to the best Bengal. These countries furnish a considerable portion of the indigo of commerce. The southern portion of the United States exported annually in the early part of the present century about 184,000 lbs. of indigo, worth 62 cts. per lb. Up to the time of the civil war it was cultivated in Florida and South Carolina, where the yield was about 60 lbs. to the acre, and the crop required attention from July to October. In 1871 the United States imported 1,994,752 lbs., about equal portions coming from Bengal and from Central and South America. A very superior quality is now produced at Bogotá.—The coloring matter of indigo, called pure indigo or indigo blue, usually constitutes nearly 50 per cent. of the commercial article, which may be obtained by dissolving out what is soluble in boiling water, then that which alcohol will remove, and finally what hydrochloric acid will take up. The residue is pure indigo and any silica that may be present. Various methods are adopted by different chemists for determining more exactly the proportions of indigo blue in samples of indigo. Some reduce the coloring matter by deoxidizing agents to indigo white, which is supposed to have been its original condition in the plants, and then precipitating and collecting this. Thus Dr. Dana dissolves the indigo by boiling in caustic soda with ces-

addition of protochloride of tin; the impure portion being then separated, bichromate of potash recovers and throws down the blue, which when washed with hydrochloric acid is collected and weighed. Others follow the plan of first taking up impurities by effusion of appropriate solvents; these impurities are chiefly resinous and gummy matters. The pure indigo has also been obtained by another process dependent on its facility of volatilizing at the temperature of 550° F., and condensing in needle-shaped prismatic crystals. The operation is hastened by mixing the indigo with water and its weight of plaster of Paris to a paste, which is spread on an iron plate. Heated over a spirit lamp, the steam and vapor of indigo unite together, and the latter collects in beautiful velvety crystals, upon the surface of glass. The pure substance melts nearly at the temperature at which it sublimes, and is charred and decomposed at about the same. It ignites and burns with a bright flame, and gives off much smoke. The crystals have a beautiful and intense copper color, and when in plates they present by transmitted light a splendid blue. Their composition is expressed by the formula  $C_{16}H_{10}N_2O_2$ . The substance resists in a remarkable degree the action of the ordinary solvents (sulphuric acid included), unless it be first deoxidized, when it readily dissolves in alkalis. The conversion of colorless indigo, though called oxidation, is to be rather an accession of two atoms of hydrogen, which, according to Liebig, unite with one of the oxygen present, giving to the substance the composition of a hydrate, having the formula  $C_{16}H_{12}N_2O + H_2O$  or  $C_{16}H_{14}N_2O_2$ ; the blue in this case being an oxide of iron, the compound body,  $C_{16}H_{14}N_2O$ . The facility with which the change is effected, and the readiness with which the indigo regains its blue color on insolubility by exposure to the air, admit of adapting the substance for use as a dye. It is dissolved in the solvent state to the fabric in the liquid; and when the cloth is exposed to the air, the insoluble substance is deposited with its characteristic color and in the fibres.—Sulphuric acid dissolves indigo blue without changing its color to red, the usual action of acids upon vegetable blues; when the substance is digested for three days with 15 parts of concentrated sulphuric acid a deep blue pasty mass is obtained, which dissolves completely in water, and under the action of sulphindrylic acid, or more properly alphanthindrogic acid, is often used in dyeing, and also in the manufacture of the blue.

Many other beautiful and highly intercolorable bodies result from this chemical change, still more from the oxidation of indigo and still another series from its treatment with the alkalis. These have received the attention of eminent chemists, and are particularly treated in Dumas's *Traité de chimie appliquée aux arts*, vol. viii., in Brande's

"Manual of Chemistry," and in Muspratt's "Chemistry."—Indigo has been somewhat used in medicine, but is not at present recognized as a remedy of value. It sometimes produces nausea and vomiting. It colors the stools bluish black, and also passes into the urine. Indican has occasionally been found in the urine when no indigo has been taken. The dose is from 30 to 120 grains.

**INDIGO BIRD** (*Cyanospiza cyanea*, Baird), a North American finch, of a blue color, tinged with ultramarine on the head, throat, and middle of breast, and elsewhere with verdigris green; lores and angle of chin velvet black, and wing feathers brown edged with bluish brown. The length is about 5½ in., and the extent of wings 7½; the female is smaller, and yellowish brown with the wings darker. It is found in the eastern United States, as far west as the Missouri, and south to Guatemala; it ar-



Indigo Bird (*Cyanospiza cyanea*).—1. Male. 2. Female.

It migrates in the southern states from Mexico and Central America about the middle of April with the painted finch (*C. ciris*), and like this is caught in traps for sale. It prefers open places on the edges of woods; perched on the top of a high tree, it delights to sing its clear and sweetly modulated strain, consisting of eight or ten notes. Though less handsome than the painted finch, its shape is elegant and compact, and its manners very lively, so that it is in request as a cage bird. The nest is made among the rankest grass, and the eggs, four to six, are blue, with one or two purple spots on the larger end. They migrate southward in the autumn. The food is small seeds and insects.

**INDIUM**, a rare metal discovered in 1868 by Professors Reich and Richter of Freiberg, Saxony, by means of spectrum analysis, and so named from two indigo-colored lines in the more refrangible part of the spectrum. It was originally detected in the zinc blende of Freiberg, and has since been found by Böttger in the blue dust of the zinc furnaces at Goslar, by

Winkler in the black blende (christophite) of Saxony, by Hoppe-Seyler in the wolfram of Zinnwald, by Köchler in the blende of Schönfeld, and by Cornwall in the blende of Maine. Indium is more easily prepared from crude metallic zinc than from any of the original ores. The metallic sponge remaining after treatment of the impure zinc with dilute sulphuric acid, or obtained as a residue in the cells of galvanic batteries, is acted upon by strong nitric acid, the excess of which is evaporated and the oxide of tin and sulphate of lead filtered off; the filtrate is treated with ammonia, which precipitates the oxide of indium, and after drying this oxide can be reduced to the metallic state by cyanide of potassium or by hydrogen gas. Indium is a brilliant, silver-white metal, destitute of crystalline structure, very soft and delicate, and easily scratched by the finger nail. It is permanent in the air, and retains its metallic lustre even in moist air and carbonic acid. The specific gravity depends upon the method of its preparation, and varies from 7.11 to 7.42. The melting point is 176° C. Although more easily fused, it is less easily volatilized than zinc or cadmium. At a bright red heat the metal burns with a violet flame and brown smoke. It is slowly dissolved by dilute sulphuric and hydrochloric acid, with evolution of hydrogen; quickly by strong hydrochloric acid. The atomic weight is given by Schrotter as 75.61, by Bunsen as 113.4. Indium monoxide has the formula  $\text{InO}$ ; its sulphide is yellow, and closely resembles sulphide of cadmium. The chloride is produced by passing chlorine gas over the oxide mixed with coal, or over the metal; it can be easily sublimed to beautiful, brilliant, crystalline scales, and is highly deliquescent. Numerous salts of indium have been prepared, but none of them possess any particular value in medicine or the arts.

**INDO-CHINA**, or the **Indo-Chinese Peninsula**, the name given to the southeastern portion of Asia, bounded N. by Thibet and China, E. by the gulf of Tonquin and the China sea, S. and S. W. by the China sea, the gulf of Siam, the strait of Malacca, the gulf of Martaban, and the bay of Bengal, and N. W. by Hindostan; area, about 850,000 sq. m.; pop. about 25,000,000. It is also designated as Further India, and as India beyond the Ganges. Andaman, Mergui, Nicobar, Prince of Wales, and other adjacent islands and groups belong to it. The political divisions of this region are: British Burmah, or Aracan, Pegu, and Tenasserim, comprising the W. coast and frontier land; Siam, in the centre, extending to the gulf of Siam, and including the Malay peninsula; Cambolia, and French or Lower Cochinchina, on the S. extremity; Anam, including Tonquin and Cochinchina, on the east; and Burmah in the northwest, surrounded by British Burmah, Siam, Anam, China, and Thibet. The Laos race, numbering about 1,500,000, occupy a large portion of the interior of Indo-China

between Siam and Anam, in the dominions of China, Siam, Anam, and Burmah. (See the separate articles on the political divisions.)

**INDO-CHINESE RACES AND LANGUAGES.** The nations belonging to this division of the Mongolian race inhabit southeastern Asia, and speak monosyllabic languages. They may be subdivided into seven groups: the Thibetan and Himalayan or Bhotiya races; the Burmese and Lohita races; the aboriginal races of the Indo-Chinese peninsula; the Thai races; the Annamites; the aborigines of China; and the Chinese. Several ethnologists and linguists prefer various other classifications; but, as has been observed by Prof. Whitney and other authorities, one cannot well resist the conviction that these races, which speak the only languages known of a monosyllabic type, and which are clustered together in one corner of a single continent, all belong to the same family of mankind, and that the dialectic differences, however great, are the result of discordant historic growth.—The Thibetans inhabit Thibet proper, or the elevated region north of the Himalaya mountains. Several races in those mountains, between the Indus and the Brahmapootra, also speak a language related to the Thibetan tongue. They have all remained in a low stage of civilization, retain the superstitions of the ancient north Asiatic races and the custom of polyandry, and have kept aloof from Buddhism. As that religion was carried into Thibet about the 7th century of our era, it is supposed that these tribes separated from the kindred races in Thibet in the 6th century or earlier. The races belonging to this division are the Mishnu, Bors, Dophla, and Aka, between the Brahmapootra and the Chumulari mountains; the Lepchas and Bhotans, in the central region of the watershed of the Teesta; the Kiranti and Limbu, in the region of the Coosey; the Newar and Murmi, between the Coosey and Gunduck; the Sunvar, Gurung, and Magar, in the territory of the river Gunduck; the Rongbo and Gurwhal, in the territory of the Surju river; and north of them the Kohli, Kakka, Bamba, Gakar, Khatir, Avam, and Ganjuh. The lower region is inhabited by the Mecha, Kichak, Tharu, Denwar, Boksar, Hayu, Chepang, Kusunda, Durro, and Bramho tribes.—The Burmese inhabit the W. portion of the Indo-Chinese peninsula, where they conquered the aborigines and formed a mighty empire. They are closely related to the inhabitants of Aracan on the coast of the bay of Bengal. With these two races are connected a number of wild tribes, generally designated collectively as Lohita, which is another name for the Brahmapootra; their relation to the Burmese is similar to that of the Bhotiya or Himalaya races to the Thibetans. Each of these numerous tribes speaks a peculiar dialect. The most important of them are the Bodos, Borros, or Kacharis, who were formerly called Rangtsa, and who, according to their tradition, emigrated into their

ent country from some place N. of Assam. They were the conquerors of the ancient empire of Kamarupa, and the founders of the dynasty of Ha-tung-tsa. The Garrows live W. of the Cossyah mountains; the Changlos inhabit the upper valley of the Brahmapootra; the Singphos the hilly country N. of Luckimpoor; the Abors the mountainous region S. of the Singphos; the Singphos the N. portion of the Khasi empire; and the Mikirs the district of Jowong in central Assam. To this division also belong the numerous Naga tribes, or tribes according to their own designation; they inhabit the regions W. of the river Kopili, the mountains which separate Assam from the Bor-Khamti country, and N. of the Khasi range. The Khyeng inhabit the Naga range which separates Aracan from the valley of the Irrawaddy. The Karens inhabit the mountains of Aracan, in Pegu, and southern Burma; also in the valleys of the Irrawaddy and the Salween. The Sabaings dwell in the valley of Sittoung, near the mouth of the Toungoo, also belong to this group. The aborigines of the Indo-Chinese peninsula probably all the tribes inhabiting its mountainous districts and river valleys. They were driven back to the lowlands by the Anam and Thai races immigrated and settled in the valleys. They are barbarous nations, on whom neither Indian nor Chinese civilization has produced any impression. Among them may be mentioned the Mons, in the delta of the Irrawaddy, called Talaing by the Burmese; the Khmers or inhabitants of Cambodia, dwelling in the Mekong; the Tsiampas, S. of the Khmers, who call them Lau; the Kwantons, who are the real aborigines of Tonquin and inhabit the mountains on the frontier of China; the Moïs, W. of Cochin China. Several writers have described the last as being essentially of a negro type.—The Thai is the dominant race of the Indo-Chinese peninsula. The Siamese are the Thais proper, and most numerous. The Burmese, Chinese, and Annamese give them the name of Shian, and our people call them Siam. The Laos inhabit the interior and the mountains of the peninsula; they are subdivided into white Laos (*Lau-pang-kah*) and black Laos (*Lau-pang-dun*). Other Thai races are the Khams, Khamtis, and Cossyahs. The Annamese inhabit Tonquin and Cochin China; they are not as closely related to their western neighbors as to the Chinese.—Several unclassified races, which differ from the Chinese proper in language, religion, and manners, are to be found, and are called, the aborigines of the East. They adhere to the Shamanism of the mountains of High Asia. The most important among them are the Sifan, the Miautze, the Lolo. The Sifans inhabit the mountainous regions W. of the Chinese provinces Szechuen and Szechuan on the upper course of the Yangtze and the Hoang-ho and Yangtse-kiang.

They are mentioned in the annals of China from A. D. 634, and are at present tributary to the Chinese. They lead a nomadic life, raise sheep, and live in tents. The Miautzes are scattered over portions of several provinces, especially in Szechuen, Kweichow, Hunan, Hupeh, Yunnan, Kwangsi, and on the frontier land of Kwangtung. It is supposed that the inhabitants of Hainan are related to them. The Lolos are the aborigines of Yunnan in S. China; they are good miners and skilled forgers of weapons. In the ancient annals of China two barbaric races are mentioned, the Man and the Y; but it has not been determined whether they were distinct races, or related to those already described.—The Indo-Chinese languages, if we include those spoken in Thibet and China, comprise all the monosyllabic languages known. The language now spoken in Cochin China is to be considered, according to Max Müller, as a dialect of Chinese, at least as much as Norman French was a dialect of French. The Chinese was grafted on the Anamitic, the native language of Cochin China; yet few Chinese scholars would recognize their language in that of Cochin China. For instance, it is one of the most characteristic features of the literary Chinese, the dialect of Nankin, or the idiom of the mandarins, that every syllable ends in a vowel, either pure or nasal. In Cochin-Chinese, on the contrary, we find words ending in *k*, *t*, *p*; thus ten is *thap*, at Canton *chap*, instead of the Chinese *teh*. In Chinese, Anamitic, Burmese, Siamese, and all other monosyllabic tongues, there are six or eight musical accents or modulations by which the different meanings of the same monosyllabic root are kept distinct. The Chinese has no more than about 450 distinct sounds, and with them it expresses between 40,000 and 50,000 words or meanings. Thus, in Anamitic, *ba* pronounced with the grave accent means either a lady or an ancestor; pronounced with the sharp accent, the favorite of a prince; with the semi-grave accent, what has been thrown away; with the grave circumflex, what is left of a fruit after it has been squeezed; with no accent, three; with the ascending or interrogative accent, a box on the ear. Thus the series *ba*, *bà*, *bá*, *bí* means, if properly pronounced, "Three ladies gave a box on the ear to the favorite of the prince." The difference between the speech of the Siamese and their neighbors the Burmese is very marked. The Burmese use an excessive number of triple consonants, *mlw* and similar combinations; but in nothing is the difference more noticeable than in the frequent use by the Burmese of the *th* sound, uttered with a strong guttural breathing, where the Siamese use *s*. The two alphabets also are very dissimilar in form, the Burmese using a round character derived from Ceylon, while the Siamese have a comparatively square character supposed to be derived from the ancient Cambodian letters still used for their sacred books, and generally for the



and the British. He died insane in 1811, and the mistress Louise Byre acted as regent for Mulhar Row Holkar, his natural son by another woman, until she was murdered in 1817, and young Mulhar was seized by the army, which remained under his command, being sometimes against the British. After a decisive battle at Mandla, Dec. 21, 1817, a treaty was signed in January, 1819, by which the Marathas ceded a large part of their territory and retained the rest under British protection. Mulhar Row died in 1833; his successor, Marhat Row, was determined to make room for himself by an imbecile prince, who left the government to his adopted son Kumbhar; and when the last named died without heirs, the East India company assumed the right of nominating as his successor Malherjee Row Holkar, who took the reins of government in February, 1852. At the outbreak of the mutiny in 1857 he attempted to take the field for the British; but many of his troops deserted, and the remainder held him a prisoner in his palace and massacred a large number of Europeans. He is a town, capital of the state, situated in a plain on the left bank of the small river Kutki, 18 m. N. W. of the British military station of Mhow, and 317 m. N. E. of Bombay; pop. about 15,000. It is an ill-built place, contains a few mosques, several Hindoo temples, and the palace of Holkar, and has no handsome edifices except the houses of the English inhabitants. The palace, of granite, which fronts on an open place, is over 300 ft. square and six stories high, enclosing a court surrounded by pillars of black wood. Its style of architecture is impure Saracenic. The town is walled, but its defences are of no great strength. There is a British resident here. The present town is comparatively modern, the ancient Indore being on the opposite side of the river. Indore was plundered in 1801 by Sindia, and in 1804 it was occupied by a British force under Col. Murray, who surrendered it on the conclusion of peace in the following year.

**INDO-PROPRY RACES AND LANGUAGES.** See **INDO-PROPRY RACES AND LANGUAGES AND GEEKASTIC RACES AND LANGUAGES.**

**INDRE.** A central state of India occupying the territory of the Marathas called the *Indra* district, and consisting of several states, which watered over a large part of central India, aggregate area, 2,624 sq. m.; pop. about 277,000. It is bounded S. and W. by Deccan, the territory of the Bombay presidency, and N. and E. by Sindia and the peishwa of Deccan. It is traversed E. and W. by the Vindhya mountains, and the Nappora range runs in the same direction along its S. border. The valley between these ridges is watered by the Nappora flowing W. The N. part of this tract and most of the other portions of Holkar's territory, belong to the great table land of Malabar. The N. districts are watered by the Ghatal and its feeders. The soil is generally fertile, producing wheat and other grain, opium, pease, sugar cane, cotton, and tobacco. The inhabitants comprise Mahrattas, the dominant race, Bheels, Gonds, and a few Mohammedans. The Bheels and Gonds are numerous in all this part of India, and have given their name to the region of Gondwana, which extends S. from Indore. (See **BHEELS, GONDS, and MAHRATTAS.**) Like all states in subsidiary alliance with the British government, Indore is occupied by British forces, which protect it against invasion, and maintain the authority of the maharajah. The British government receives in return an annual subsidy, which may be paid, if preferred, by cession of territory, and reserves the right of interference in cases of bad government on the part of the native chief. In 1733 the town and district of Indore were given by the peishwa to Mulhar Row (or Rao) Holkar, a Mahratta leader, born a shepherd, who had risen by his courage and talents as a soldier. He died in 1766, and was succeeded by a grandson, who soon died insane, leaving the sovereignty to his mother, Alia Bacc, who retained it for 30 years. In 1797 the commander of her forces, Tookajee Holkar, died, and his illegitimate son, Jeswant Row Holkar, seized the government. He was expelled by the Sindia family, but reinstated himself in 1802. He inaugurated an extensive system of plunder, for which the British authorities made war on him. He advanced on Delhi at the head of 60,000 horse, but was defeated by Lord Lake in two engagements. In 1805 he entered the Punjab with a new army, but was closely followed by Lake, and in December concluded a treaty which left him in possession of nearly

all his dominions. He died insane in 1811, and the mistress Louise Byre acted as regent for Mulhar Row Holkar, his natural son by another woman, until she was murdered in 1817, and young Mulhar was seized by the army, which remained under his command, being sometimes against the British. After a decisive battle at Mandla, Dec. 21, 1817, a treaty was signed in January, 1819, by which the Marathas ceded a large part of their territory and retained the rest under British protection. Mulhar Row died in 1833; his successor, Marhat Row, was determined to make room for himself by an imbecile prince, who left the government to his adopted son Kumbhar; and when the last named died without heirs, the East India company assumed the right of nominating as his successor Malherjee Row Holkar, who took the reins of government in February, 1852. At the outbreak of the mutiny in 1857 he attempted to take the field for the British; but many of his troops deserted, and the remainder held him a prisoner in his palace and massacred a large number of Europeans. He is a town, capital of the state, situated in a plain on the left bank of the small river Kutki, 18 m. N. W. of the British military station of Mhow, and 317 m. N. E. of Bombay; pop. about 15,000. It is an ill-built place, contains a few mosques, several Hindoo temples, and the palace of Holkar, and has no handsome edifices except the houses of the English inhabitants. The palace, of granite, which fronts on an open place, is over 300 ft. square and six stories high, enclosing a court surrounded by pillars of black wood. Its style of architecture is impure Saracenic. The town is walled, but its defences are of no great strength. There is a British resident here. The present town is comparatively modern, the ancient Indore being on the opposite side of the river. Indore was plundered in 1801 by Sindia, and in 1804 it was occupied by a British force under Col. Murray, who surrendered it on the conclusion of peace in the following year.

**INDORSEMENT, or Endorsement.** See **EXCHANGE, PROMISSORY NOTE, and NEGOTIABLE PAPER.**

**INDRE,** a central department of France, formed chiefly from the old province of Berry, bordering on Loir-et-Cher, Cher, Creuse, Haute-Vienne, Vienne, and Indre-et-Loire; area, 2,624 sq. m.; pop. in 1872, 277,000. The surface is mostly level, and presents three marked and distinct divisions: Bois Chand, where the farms are small, and the scenery varied from the number of its hedges, hedge rows, and woods; Champagne, a flat treeless region, without hedge or shrubby enclosure of any kind; and La Brenne, a low district, covered in part with shallow ponds, the mephitic exhalations of which are very unhealthy. The principal rivers are the Indre, Creuse, Claise, Arnon, and Fouzou. The Indre rises in the department of Cher, and joins the Loire after a N. W. and W. course of about 130 m.,

the last 44 of which it is navigable. The soil, except in the district of La Brenne, is fertile and healthful. The soil is rather light and gravelly, but not ill adapted for the growth of cereals. Nearly two thirds of the whole area is sown. Grain is raised for exportation; next in importance are the crops of hemp and flax. Wine produced is not highly esteemed. There are large numbers of sheep with a very high quality of wool. Iron mines are worked, and there are a few quarries of marble, millstone, granite, and mica. Linen cloths, hosiery, paper, porcelain, and earthenware are the principal manufactures. The department is divided into the *arrondissements* of Bourges, Le Blanc, Issoudun, and La Ferté. Capital, Châteauroux.

**INDRE-ET-LOIRE**, a central department of France, in the old province of Touraine, bordered on Sarthe, Loir-et-Cher, Indre, Vienne, Maine-et-Loire; area, 2,861 sq. m.; pop. in 1877, 317,027. It is named from the rivers Indre and Loire, which unite within its limits. The Indre and the Creuse water it in the north.

In the N. districts are several arid districts, and all over the department many extensive forests, the largest of which are those of Bourges, Loches, and Chinon. The climate is favorable for its mildness and salubrity. The soil is in general extremely fertile. The soil on both sides of the Loire is called the *garçonnais*, and consists of a light but deep fertile loam. Grain, hemp, flax, anise, and clover are grown on a large scale. Fruit is abundant, and the Tours prunes are largely exported. Much wine is made, some of which bears a high reputation. Bees and silkworms are carefully tended; game and fish are abundant. The chief industrial products are iron, hardware, powder, woollen cloth, paper, and pottery. The department is divided into the *arrondissements* of Bourges, Chinon, and Loches. Capital, Tours.

**INDRE.** See **LEMAN.**

**INDULGENCE** (Lat. *indulgere*, to yield, to pardon), in the Roman Catholic church, the remission of the temporal penalty to be undergone by the sinner, after his sin has been forgiven in confession. The term originated in the discipline of the early church, when notorious sinners were sentenced, after they had repented in confession, to periods of public penance sometimes extending to the hour of death. The sincere sorrow of the offender and the intercession of those who were imprisoned about to suffer death for the faith, occasionally even the prayers of the civil rulers, induced the bishops to be indulgent to the penitents, by granting them a remission of the imposed canonical penance, or relaxing its rigor. The use of public penance was replaced both in the eastern and western churches by good works, private masses, and devotional exercises. When Christianity spread among the northern nations of

Europe, the canonical penances were found to be inapplicable to their condition. Their pagan jurisprudence had accustomed them to pecuniary mulcts, so that persons guilty of theft or murder could purchase exemption, and compound with the injured parties or their relatives, by paying a stipulated fine. This system was applied by the church to penitential atonements; and the money thus contributed was employed in almsgiving, or for the redemption of captives, the freeing of slaves, or the expenses of public worship. The directions drawn up by Theodore of Canterbury and Egbert of York in the 8th century, and by Halitgar of Cambrai in the 9th, were framed for the purpose of administering penance in conformity with these national customs. But this substitution of pecuniary fines gave rise to serious misapprehensions and gross abuses. It was easy for the unlettered multitude to confound the remission of the canonical penalty thus obtained for money with the purchase of pardon for sin. Many councils and ecclesiastical writers of these times either denounced the practice altogether, or urged upon the clergy the duty of instructing the people on the true nature of penitential satisfaction. The synod of Cloveshoo or Abingdon in 742 stigmatized the prevalent error that almsgiving releases the sinner from the more stringent kinds of penance; and in 818 the second council of Châlons uttered a similar warning. In 1095 the council of Clermont, by the authority of Pope Urban II., offered a "plenary indulgence" to all who took the cross for the purpose of delivering Jerusalem. It was enacted that all who, having confessed their sins with true repentance, might engage in the expedition, should be exempted, in consequence of the labor and dangers to which they voluntarily exposed themselves, from the canonical penances to which they were otherwise liable. The council of Lyons in 1274 extended the same indulgence to all who, unable to join the crusade in person, should by voluntary donations contribute to its success. From that period indulgences began to be multiplied, and as often as money was required for any object connected with the interests of the church, they were offered to the people. Out of this practice grew abuses of two kinds. The money thus obtained was frequently diverted from its original destination; and the office of collecting it being committed to inferior agents, secular as well as ecclesiastical, it became their interest, as they received a percentage on the amount, to exaggerate the advantages of the indulgence, and to impose upon the credulity and simplicity of the people. Severe constitutions were enacted by several popes to prevent such abuses, and to punish the rapacity and impiety of the collectors; but these laws were not enforced, and fell into disuse. Besides, during the great western schism the rival pretenders to the papacy lavished indulgences among their supporters. This brought both the

indulgence and the authority which dispensed it into discredit. The crisis came when Julius II. proposed the erection of the new basilica of St. Peter's on the Vatican hill, and published an indulgence in Poland and France in favor of all who should help defray its cost. His successor, Leo X., added to this object a crusade against the Turks, and extended the indulgence to the northern provinces of Germany. The papal commission for this purpose was issued to the archbishop of Magdeburg, who delegated it to the Dominicans, among whom was the notorious Tetzl. They spread themselves rapidly over Saxony, and, according to Luther, offered indulgences in the streets, markets, and taverns, teaching that every contributor, if he paid on his own account, infallibly opened to himself the gates of heaven; if on account of the dead, instantly liberated a soul from purgatory. These abuses were subsequently condemned by the council of Trent, and measures were prescribed for suppressing them or preventing their recurrence in each diocese. Since that period, though no such general abuses have been noticed by historians, yet in many Roman Catholic countries indulgences have continued to be published in forms which give great offence, especially to Protestants.—The expressions used, and the local customs relating to indulgences, can only be rightly understood from a clear statement of the doctrine of the Roman Catholic church on this subject. She teaches that by sacramental absolution the guilt of sin (*reatus culpæ*) committed after baptism is taken away, together with the eternal punishment it deserves, by virtue of Christ's sufferings; but that the pardoned sinner remains liable to the *reatus pænæ*, or to a temporal penalty to be paid in this life or the next. This penalty is not to be confounded with the "canonical penances" of the primitive church. It is held by Catholic theologians that St. Paul showed indulgence to the incestuous Corinthian before the institution of the system of canonical penances. These were established gradually by local usage in the East and West, without the authority of any general ecclesiastical law; and the penitential canons which regulated the application of such penances varied, like the usage itself, in different countries. As this whole system had been introduced by custom, so it fell into disuse without ever having been repealed by any general council. The church, meanwhile, never ceased to exact of the penitent the satisfaction due primarily to the divine law violated by his transgressions, and secondarily to the community scandalized and disturbed by them. So long as the penitential canons remained in vigor, the fulfilment of their prescriptions was held to be satisfactory before God and the church, releasing the penitent from the *reatus pænæ* both here and hereafter. A true satisfaction to the church meant a true satisfaction to God. In like manner, since the disuse of canonical penances, the fulfilment of those imposed by the church is to

be taken as the payment of what is due to God as well as to herself. Moreover, penitential works derive their worth and efficacy from their being performed in union with Christ's atonement. He and his sanctified members, whether in heaven, on earth, or in purgatory, form in the view of the church one moral person; and his Spirit imparts to the virtues and acts of his saints all the supernatural merit which they possess. Their merits added to his, like a finite quantity added to the infinite, do not increase the latter, but are only merged in it. These united merits of Christ the head and of all his true members constitute the property of regenerated humanity; they form a treasury committed to the guardianship of the church, of which she as his spouse is the dispenser. Out of this she sets apart a portion for her needy children, which they may make their own by the performance, in a state of grace, of specified good works, and with this acquired treasure purchase for themselves or for the dead perfect reconciliation and communion with God. The Christian who, by gaining an indulgence through the accomplishment of certain outward acts, thus becomes master of a portion of Christ's redeeming merits, purchases his own soul's perfect peace with "a price" which he presents to the divine justice through Christ; and if he offer the whole fruit for the release of a soul in purgatory, he does so through the church, *per modum suffragii*, as an intercessory offering, which God may or may not accept, but which the church assumes he actually does accept in ratification of her action. In both cases, when every prescribed condition for the gaining of an indulgence has been fulfilled, God remits in heaven what Christ's spouse remits upon earth. The nature and existence of this treasury of merits, its application, as here explained, to the living and the dead, and the ratification by God of the acts of the church relating to indulgences, are, without being defined as of faith, considered as *proxima fidei*. As the temporal satisfaction or penalty due by the sinner after sacramental absolution is a consequence of the sin itself, it has always been called sin in the style of the Roman chancery, and in the papal bulls which treat of indulgences and jubilees. Hence the phrase "full and complete remission of sins" is to be understood as meaning the full and complete remission of the temporal penalty secured by the fulfilment of the conditions prescribed for an indulgence, a necessary but tacit preliminary to which is sacramental absolution to the truly contrite. In no supposable case can indulgence be a pardon for the guilt of sin even to the most heart-stricken penitent, still less a prospective pardon of future sins, or a license for committing them. A plenary indulgence is the remission of the entire satisfaction due to God and subject to the power of the church. The indulgence of a jubilee differs from this, not in a fuller relaxation of penalty, but in the wider

ing faculties granted on such an occasion lessors. A partial indulgence, specifically limited time, alludes to the forms of penitential canons, which enjoined for in a penance proportioned in rigor and on to its gravity. The inscriptions found in Rome or elsewhere in Catholic churches on what are called privileged altars such offence to Protestants, because they denote that "these souls are delivered from purgatory." Benedict XIV. explains by saying that "whenever a pope de- an altar to be privileged, he sets apart, the eucharistic sacrifice is offered on a departed soul, a sufficient portion of church's treasure of merits to obtain from it so pleaseth him, the release of that from purgatory." This explanation also to the indulgences attached to certain churches, to privileged pilgrimages, to visiting churches, or to the performance of such as the "way of the cross." All can appropriated to the souls in purgatory in ay mentioned above.—The Scriptural ls to which Roman Catholic theologians in support of their doctrine of satisfac- and indulgences are: 1, for satisfaction, mples of Adam, Moses, Aaron, and Da- bo, though pardoned, were subjected to grievous temporal punishments; 2, for moes, the power of the keys bestowed er (Matt. xvi. 19), and on the apostles ively (Matt. xviii. 18), and their exercise ling (1 Cor. v. 4) and in loosing or re- (2 Cor. ii. 6). Moreover, they contend, trine of the church in this matter rests lition, which is interpreted by the per- usage of the church and the writings fathers.—See Wiseman's "Lectures Doctrines and Practices of the Catholic " (London, 1844; Baltimore, 1852); r's *Dictionnaire de théologie*; Hirscher's rom *Ablaus* (Tübingen, 1844); Nean- "History of Doctrines," vol. ii., 594, "Church History," vol. iii.; and Hodge's matic Theology," vol. iii.

**S**, or **SINDHU** (Sans. *Sindhu*, river; Pers. *Sind*), a river of Asia, rising on the N. of the Himalaya, in Thibet, and dis- ing into the Arabian sea. Its three re- feeders are the Senge-khabab ("sprung he lion's mouth"), also called the Singi- "lion stream"), the Lang-choo, and the g-choo. All three have their sources he Kailas range. The first named is the , and is considered the beginning of the

It rises near the Kailas Parbat moun- an elevation of about 18,000 ft., about 10' N., lon. 81° 20' E., not more than from the sources of the Sanpo, one principal feeders of the Brahmapootra, the Ganges. The Lang-choo flows he Senge-khabab before the Gartung, m. further, flowing N. W., the river Ladakh. At Raldang, 100 m. from affluence, it can still be crossed without

boats during the greater part of the summer. At Ranag, 9 m. below Raldang, it is passable for horses during the whole year. The extreme width of the river at this point, how- ever, is remarkable. The water surface, measured in summer, was 2,158 ft. across, and left nearly in the middle of the river a bank 1,155 ft. wide entirely uncovered. It is presumed that in seasons of flood the Indus attains here a width of 3,818 ft. The depth is only 2 or 3 ft. The width of the river decreases very rapidly from this point, and about 450 m. from its source, near the city of Leh, it is reduced in the summer to 75 ft., with a depth of 8 ft. The valley of the Indus is here only 10,733 ft. high, the river having fallen nearly 5,300 ft., or at the rate of 12 ft. to the mile. Continuing its N. W. course through the valley S. of the Kailas range, 50 m. below the town of Kalatse it is still 75 ft. wide, but on only one third of the surface are signs of a steady flow; the re- mainder is either in a state of stagnation, or moves on very slowly. The river is however very deep in its main channels, measuring from 18 to 22 ft. About 55 m. below it receives the river Dras from Cashmere, and at Kiria, 47 m. further, it is joined on the right by the large river Shy-yok. At the mountain Mendok-kar, near Iskardoh, the chief town of Bulti, which the river reaches by a circuit of 50 m., it is no more than 7,255 ft. above the level of the sea. The name Senge-khabab disappears here, and the river begins to be known as the Ab-Sind, or Indus. About 60 m. below Iskardoh it changes its course suddenly from N. W. to S., and crosses the Himalaya a few miles above the E. end of the valley of Gilgit, from which it receives the river Yasan. It descends in a torrent to Bunji, a town 20 m. further on and only 4,870 ft. above the sea. A few miles below this it leaves the territory of Bulti and enters that of Kafiristan, through which it flows for nearly 170 m. in a tortuous S. W. and S. course. The character of this portion of the river is almost totally unknown. It returns to the British territory at Derband, mea- suring in August nearly 300 ft. across, but without much depth. There are five fords between here and Attock, 60 m. below; they are at times somewhat treacherous, and it is related that at one of them, just above the in- flux of the Cabool, Runjeet Singh lost 7,000 men in trying to cross with his army. Al- though the Cabool is navigable for 40 m., the navigation of the Indus terminates just above its confluence. Attock is situated 1,049 ft. above the sea, or 9,674 ft. below Leh. The course of the river between these two cities is 470 m. long, which shows a fall of nearly 21 ft. to the mile over this distance, or of a little more than 16 ft. to the mile from the source. From Attock to the sea the Indus is 942 m. long. It moves at first impetuously through high cliffs of slate, which contract it to a width of 250 ft., but render it 180 ft. deep. Near Kalabagh it enters a plain, takes up the Swan or

Soohan, and expands again to 1,500 ft. with an average depth of 60 ft. For the next 350 m., to Mittun Kote, the Indus takes a more southerly course, and separates into numerous arms, enclosing fertile islands, which are covered during the summer inundations with an immense sheet of water, extending over the level country of the E. bank. The main channel near Kaheree is 3,000 ft. wide and 12 ft. deep. Near Mittun Kote occurs the influx of the Punjnad, which carries into it the waters of the Jhylum, Chenaub, Ravee, Beas, and Sutlej, the five rivers of the Punjaub. The Indus swells here in its lowest stage to a width of 6,000 ft., and spreads in times of inundation over 20 m. on the W. and 10 or 12 m. on the E. side. A S. W. course of about 50 m. carries it into the arid, rainless, alluvial plain of Sinde, where extensive irrigation works have been constructed by the British government, and others are in progress. The river has so frequently changed its direction in flowing through this region that traces of ancient channels are very numerous, the main channel being now considerably further W. than formerly. Its banks are higher than the adjacent tracts, the surface of which slopes away from the river. This peculiarity is due to the silt brought down by the waters of the Indus and deposited in consequence of the decreased rapidity of its current in this nearly level country. These silt deposits are constantly forming new land in some localities and causing the river to break through its banks in others. From Mittun Kote to the sea the Indus flows over a distance of about 450 m. The East Narra is an ancient channel which separates from it near Soodaja, and extends S. E. through the desert of Thur; it is now supplied with water by canals connecting with the Indus. The West Narra branches off 18 m. below Roree, follows a tortuous S. course of about 160 m., forms the Mantchoor lake, and returns to the Indus near Sewan, 10 m. below. From this point the bed of the Indus is depressed 16 to 18 ft. below the adjacent lands. The Fulailee was originally a natural branch of the Indus on the E. side, returning to it about 16 m. below Hyderabad, the capital of Sinde, which is situated on the tract of land thus turned into an island. It has been converted into a main feeder for irrigation canals, S. and E. of that city. The delta of the Indus consists of numerous mouths between Hyderabad and the Arabian sea, and is about 100 m. long and 130 m. wide. The principal mouths are the Koree, the Seer, the Mooll or Maw, the Kookcewarree, the Kedywarree, the Rechel, the Pinteeanee, and the Pittee. The last is at present the widest and deepest, and always navigable; the Hujamree was the most important till 1838, when a sudden change in the channel rendered it entirely useless. The tide rises as far as Tattah, about 70 m. from the sea. The Indus is not navigable above Roree for vessels of more than 4 ft. draught. The entire length of the Indus is

about 2,000 m., and the area of its drainage basin is estimated at 312,000 sq. m. The rise of the river commences in May, and its waters subside in the latter part of August.—The 1,700 m. of railroad now in operation through Bombay, Sinde, and the Punjaub render the Indus less important as a means of transportation than as a means of irrigation in a sultry climate where rain seldom falls. The water is very unwholesome in the early part of the inundation, and at other times it is wholesome only if kept until the earthy and vegetable admixtures subside. Fish are abundant, and form a large portion of the sustenance of the population of the adjacent country. The alligators in it are long-snouted, of the kind called gavial. In the Vedic writings the Indus is called the king of rivers, and the Ganges as well as the other streams sing praises unto it. It is generally designated in them as Sindhu, "the river." The ancient inhabitants had no more definite name for their country bordering on the Indus than *Sapta Sindhavas*, "the seven rivers," counting with it the Cabool and the five chief streams of the Punjaub.

**INDUSTRIAL EXHIBITIONS**, public competitive displays of products for the encouragement of arts and manufactures, local, national, and international. The first industrial exhibition was held in Paris in 1798, and comprised chiefly specimens of French art manufactures, not contributed by their producers, but loaned by owners. This display led in the same year to a larger exhibition of all kinds of French manufactures, and the utility and success of the show prompted the more extended exhibitions, under the consulate of Napoleon, in 1801 and 1802. Thereafter exhibitions intended to be triennial, but interrupted by political causes or by war, were held from 1806 to 1849, the 11th and last exceeding all former ones. The first industrial exhibition in Great Britain was opened under royal patronage in London in 1828, but was not successful. Local exhibitions of the industry of manufacturing districts were held at Manchester in 1837, at Leeds in 1839, and at Birmingham in 1849. The royal society of Dublin began in 1829 a series of triennial exhibitions of Irish manufactures. Similar local exhibitions were held at Ghent in 1830, at Berlin in 1834, and at Vienna in 1835.—The first international exhibition at Paris in 1844 was so successful as to commend the scheme to the London society of arts, and in 1849 it matured a plan for a "world's fair," which was presented to the public by the president of the society, Prince Albert, who declared that the time had come to prepare for a great exhibition, "not merely national in its scope and benefits, but comprehensive of the whole world." A royal commission was issued Jan. 3, 1850, and the queen headed a subscription list with £1,000. A building popularly known as the "crystal palace" was erected in Hyde Park, from designs of Mr. (afterward Sir Joseph) Paxton, composed, excepting the floor-

l joists, wholly of glass and iron. It was 51 ft. long and 408 ft. wide, with an aisle on the north side 936 ft. long and 48 ft. wide; height of central portion 64 ft., and height in the centre 108 ft.; entire area about 19 acres. Portions of the palace were assigned to different countries and arranged according to the space required by them. The articles, excepting heavy machinery, raw materials, machinery, manufactures, and fine arts. The paintings, however, were assembled together; but some of the most important pieces of sculpture were placed in different parts of the building, in order to attract attention and to add to the beauty of the interior. The building was begun in 1850, completed Feb. 3, 1851, and cost £1,000,000. On May 1 the queen opened the exhibition, which continued till Oct. 11. The number of visitors was 6,170,000, an average of 43,500 a day, and the greatest number on any day (Oct. 7) was 109,915. No record of the number of articles exhibited, exhibitors, or more than 17,000 exhibitors. The medals and prize medals and honorable mentions, were 5,084, and the exhibitors, occupying two fifths of the honors. In manufactures and in metal, glass, and porcelain manufactures, the British received the majority of the awards; in miscellaneous manufactures, textile manufactures, and fine arts, the foreign awards were more than the native; in raw materials and manufactures, the foreigners took nearly four times as many as the natives (988 to 262). The popularity of the world's fair was largely due to the number of gems, including the Koh-i-Noor and the works of art exhibited. The financial results were: receipts from subscriptions, £27,800; admissions, £425,000; refreshments, &c., £13,200; total, £506,000; expenses, £330,000; the balance in favor of the exhibition was increased by interest and receipts to £186,436. Those who were on the guarantee list were not called upon for subscriptions. The final balance, with parliamentary grants, was applied to the advancement of the fine arts and practical science. The "crystal palace" exhibition company, its reconstruction at Sydenham on an enlarged plan, began Aug. 5, 1852, and was reopened by the queen June 10, 1854. Since then it has been devoted to horticulture, monster concerts, and other public entertainments.—There was a successful exhibition of Irish arts and manufactures at Cork in 1853, which led to the much larger international exhibition at Dublin in 1853. This exhibition was organized by Mr. William Dargan, who spent £80,000. The building, 425 ft. long, 105 ft. wide, and 105 ft. high, with adjoining halls, cost £48,000. The exhibition was opened by the lord lieutenant May 12, and closed till Oct. 29. The value of the collection was £500,000, of which the fine arts represented

£200,000. Up to that time no finer collection of pictures had been assembled in the kingdom. The exhibition was popular, and had 1,150,000 visitors; but it was not financially successful, and entailed a heavy loss on the projectors.—The New York world's fair of 1853 originated with a company incorporated in 1851. The city gave a lease of Reservoir square for five years rent free, upon the conditions that the building should be constructed of glass and iron, and that the admission fee should not be more than 50 cents. Congress also passed an act constituting the building a bonded warehouse, into which foreign goods might be brought free of duty. In March, 1852, the company issued shares to the amount of \$300,000, afterward increased to \$500,000 and readily subscribed. The building was in the form of a Greek cross, 365 ft. long each way, and 150 ft. wide, with a central dome 123 ft. high and 100 ft. in diameter; and on one side another building, 450 ft. long and 75 ft. wide, was erected for machinery. The president of the United States, Gen. Pierce, opened the exhibition July 14, and it continued 119 days. There were 4,800 exhibitors, more than one half of whom were foreigners. Among the many causes which operated against the success of the enterprise were the Dublin exhibition of the same year, the long delay in opening, the distance of the locality from the then centre of the city, and the inadequate means of access. The principal feature of the exhibition was the fine display of American machinery and agricultural implements. The financial results were: cost of building, \$540,000; fitting and furnishing, \$100,000; receipts from admissions, sale of catalogues, &c., \$340,000. The exhibition was reopened in 1854, and in that and the following year the company expended \$200,000, thus exhausting the capital, receipts, and two loans. The building was afterward leased to the American institute and used for its annual fairs, during the progress of one of which, on Oct. 15, 1858, it was burned with all its contents.—The Zollverein exhibition at Munich, from July 15 to Oct. 15, 1854, was held in a building of glass and iron, 800 ft. long, 280 ft. wide, and 87 ft. high, covering 250 sq. ft. of flooring, and costing \$450,000. From 33 Zollverein states there were 6,800 exhibitors of goods, worth about \$7,500,000; but the advent of cholera in the autumn and other causes reduced the number of visitors, and the Bavarian government was obliged to make up a deficiency of \$1,000,000.—The Paris international exhibition of 1855 was organized as follows: the government was to bear the cost and appoint the commission. A joint-stock company erected in the Champs Elysées a main building of glass, stone, and brick, 800 ft. long and 350 ft. wide, and other buildings for machinery, paintings, &c., were added. In the main building the goods were arranged by countries, and were classified nearly as in the London exhibition of 1851. But

besides the machinery and art buildings, it was found necessary to erect smaller buildings for carriages, agricultural implements, and cheap articles. Spaces in the open ground were also devoted to the exhibition of certain articles. The government guaranteed 4 per cent. on the outlay, and a share of the profits, if there were any; but as there were none, all the receipts for admissions went to the company. The cost of the buildings and other expenses amounted to about \$5,000,000. The emperor opened the exhibition May 15, and it continued till Nov. 15, during which time there were 4,533,464 visitors, one third fewer than to that of London in 1851, though the Paris exhibition was open on Sundays. There were 10,691 exhibitors from France and her colonies, and 10,108 from 53 foreign countries and 22 colonies. As a grand display the exhibition was very successful, and it was estimated that the money spent in Paris by foreign visitors compensated for the financial failure of the exhibition itself. In 1861 there were important exhibitions at Haarlem of the industries of Holland; at Nantes of the manufactures and fine arts of France and Algeria; and at Florence of Italian silk in all stages of its culture and of silk goods in every variety of manufacture.—The second London international exhibition, in 1862, started with a guarantee fund of £450,000, to which Prince Albert subscribed £10,000. A building of brick, glass, and iron, with flooring and galleries covering 1,400,000 sq. ft., was erected at South Kensington. This exhibition was intended by the society of arts to follow the great exhibition of 1851 as the second decennial in 1861; but the Italian war postponed it a year. The exhibition continued 177 days, during which there were 6,211,103 visitors; the largest number in one day (Oct. 30) was 67,891, and the daily average 36,329. There were in the industrial division 17,861 foreign exhibitors, who took 9,344 prizes, and 8,487 British and colonial, who received 4,071 prizes. The total expenditures were £460,000; receipts from admissions, &c., £448,000; the deficiency of £12,000 was wholly due to the great cost of the building, which was designed to be permanent, but was subsequently demolished, and the materials were used in the construction of the Alexandra palace, destroyed by fire June 9, 1873.—In 1863 an exhibition was held in Constantinople, national for Turkish manufactures, and universal for foreign implements and machinery. It was not important, but was made attractive by the display of jewels from the imperial palace and seraglio. The exhibition at Amsterdam in 1864 was devoted to the display of Dutch industry, and in the same year smaller local industrial shows were held at Malta, at Calcutta, and at Lucknow, and a combined French and Spanish exhibition was held at Bayonne. The South London and North London working-class industrial exhibitions began in 1864; the latter was the most important, having 934 exhibitors, 200,000 vis-

itors in the 18 days of the show, and a clear profit of £300. The international exhibition at Dublin in 1865, from May 8 to Nov. 9, had 770 British and 288 colonial and foreign exhibitors; but the visitors numbered only 600,000, a little more than half of the number in 1853, and financially it was a failure. In 1865 there was an exhibition at Oporto, confined chiefly to Portuguese industry, though there was a show of British agricultural implements and machinery. In the same year there was a show of New Zealand manufactures at Dunedin; an international exhibition, chiefly agricultural, by Germany, Holland, and Belgium, at Cologne; and an interesting international display of fishing tackle, &c., at Boulogne. Working men's local exhibitions were also held at Birmingham, Nottingham, Manchester, Preston, &c., and one at Vienna which distributed 613 prizes to 1,025 exhibitors, and made a profit of 2,000 florins, which was given to city charities. Several comparatively small working-class industrial shows were held in London, but only one of them was financially successful. Of two similar exhibitions in London in 1866, one, by having a hall rent free, secured a small surplus, which was distributed in prizes; the other had 1,492 exhibitors and 53,000 visitors, and, with £1,066 rent, made £900 profit. In 1866 Sweden, Norway, Denmark, and Finland combined in a show of Scandinavian industry at Stockholm, in which manufactures in iron, steel, woollens, and earthenware were principal features. The Melbourne exhibition of the same year assembled 3,360 exhibitors from South Australia, Victoria, New Zealand, New South Wales, Queensland, and Tasmania. The Brazilian exhibition of 1866, first at Pernambuco and afterward at Rio de Janeiro, was mainly of raw produce, which was subsequently sent to the Paris exhibition.—The Paris universal exhibition of 1867 was held in the Champ de Mars, in an oval building 1,550 ft. long and 1,250 ft. wide, covering 11 acres, while smaller buildings increased the area to 35 acres. Seventy surrounding acres, partly laid out as a garden, were covered with all kinds of buildings, including model cottages, restaurants, theatres, and even places of worship. The main building was a series of ovals one within another, starting from a central pavilion containing the coins, weights, and measures of all nations. The ovals were devoted to the following uses: 1, to works of art; 2, to materials, &c., of the liberal arts, printing, books, stationery, surgical, scientific, mathematical, and musical instruments; 3, to furniture and household goods; 4, to clothing; 5, to raw materials; 6, to tools and light machinery; 7, to cereals, vegetables, food preparations, &c. There was also a gallery which exhibited the progressive history of labor. From the central pavilion avenues radiated like spokes through the ovals, and the spaces between the avenues were assigned to different countries, so that visitors making the tour of

each oval could compare the productions in each class of the different nations. The exhibition was open from April 1 to Oct. 31; there were 50,226 exhibitors and 10,200,000 visitors; the medals and honorable mentions numbered, with 44 grand prizes for especial merit, 12,944, of which United States exhibitors received 3 grand prizes, 17 gold, 66 silver, and 94 bronze medals. The exhibition expenses, including buildings, were about \$4,000,000, of which the government and city paid \$2,500,000; the receipts for admissions, &c., were \$2,000,000; and there was a claimed profit of about \$600,000. A fishery exhibition at Havre in the same year included fishing boats and all the appliances for curing fish, making fishermen's clothing, &c. A still more important international maritime exhibition of marine engines, nautical instruments, ships' fittings and furniture, fishing boats and tackle, life-saving apparatus, &c., was held at Havre in 1864.—There was a local exhibition of the industries of the Northwest Provinces of British India at Agra in 1867, and local industrial exhibitions were held in St. Petersburg, Ghent, and Berlin in 1868. The Amsterdam international exhibition of 1869 had 2,325 exhibitors, and was remarkable for its display of cheap clothing, prepared foods, house fittings, furniture, and other articles of domestic economy. The St. Petersburg industrial exhibition of 1870 was local, to show the Russian progress in the manufacture of steel guns, armor plates, rails, locomotives, &c. The intercolonial exhibition at Sydney, New South Wales, in 1870, was important in the exhibition of raw products, preserved meats, &c. It had 2,914 exhibitors, was open 29 days, and there were 184,000 visitors. The London annual international exhibition of 1871, from May 1 to Sept. 30, was the third in the originally proposed decennial series, but was made the first of an annual series, each to be devoted to specified branches of industry. It had 1,142,154 visitors; there were about 4,000 fine-art and 7,000 industrial entries, and 33 foreign countries were represented. There were no prizes, and the receipts were equal to the expenses. The Italian industrial association began at Milan in 1871 a series of annual exhibitions, each year to be devoted to specialties. Naples held an international maritime exhibition in 1871. Minor exhibitions were held in 1871, at Jersey, of the products and industry of the Channel islands; at Lima, of the products and manufactures of the South American Pacific States; and at Cordova, of Argentine industry and of foreign implements adapted to the development of local resources. The London annual international exhibition of 1872 was devoted principally to the show of arts connected with printing, paper, music and musical instruments, jewelry, cotton goods, and fine arts. The Dublin exhibition of the same year comprised chiefly Irish produce and manufactures, and was held in the building erected

in 1853, which had been purchased by Sir Arthur Guinness, and was given rent free for this exhibition. Other exhibitions in 1872 were the international one at Moscow, intended to compare the progress of Russian industry with that of other nations; the show of Scandinavian industry, with 4,000 exhibitors, at Copenhagen; the universal exhibition of silk, silk goods, furniture, machinery, tools, fine arts, &c., at Lyons; and the display of Colombian products and manufacture at Bogotá. In 1873 the London annual international exhibition made a feature of cooking science and apparatus. There was a school of popular cookery, with lectures which from April 14 to Aug. 15 were attended by 31,784 persons.—The Vienna international exhibition of 1873 was opened by the emperor May 1; the prizes were distributed Aug. 18; and the exhibition closed Oct. 31. The main building, of brick and glass, erected on the Prater, was 2,985 ft. long, 82 ft. wide, and 52½ ft. high, with a central dome; and opening out from this hall were 32 transverse galleries 250 ft. long and 49 ft. wide, the whole presenting a form which was compared to a gridiron, or to a fish's spine with the projecting bones. There were also a machinery annex of brick 2,614 ft. long and 155 ft. wide, a large fine-art hall, and numerous smaller buildings. The transverse sections were devoted to different countries in the order of their geographical position, beginning at the southwest main entrance with North and South America, thence in succession to Great Britain, France, Spain, Scandinavia, Germany, &c.; China and Japan occupying the remotest sections at the northeast end. The exhibits were classified into 26 groups, following nearly the plan of the divisions in the great exhibitions of London and Paris; but there were such special features as group 16, devoted to the art of war, and including everything for the equipment of an army and the care of the sick and wounded; 17, covering everything relating to sea, lake, and river navigation, ship building and fitting, construction of harbors and lighthouses, &c.; 19, private dwelling houses, inner arrangements, and decorations, to illustrate the domestic economy of different nations; 20, farm houses, furniture, and utensils of different countries; 23, art applied to religion in all the industries and fine arts employed in public worship. There were efforts also to show a history of prices of various important articles, at average periods of five years, as far back as possible, and the gradual conversion of waste into use in manufactured articles. The industries of nearly all the world were represented. The prizes were: 1, grand diplomas of honor; 2, bronze medals for progress, merit, fine arts, good taste, and coöperators. Of these, 349 were awarded to 643 exhibitors from the United States. The total number of visitors was 7,254,687. The exhibition cost more than \$12,000,000; the original gov-



ernment appropriation was \$3,000,000, accompanied with a provision that it was not to be exceeded; and as the receipts from visitors barely paid the running expenses, there was a deficit of about \$9,000,000. Among the causes which contributed to this failure were the financial panic and the comparatively small number of visitors during the summer months, which was due partly to apprehensions of the cholera, and especially to the utterly inadequate accommodations and the extravagant prices of living. But the industrial benefits of the exhibition to the Austro-Hungarian dominions, in bringing their productions to the notice of the world, and especially in the introduction of American agricultural implements and other foreign labor-saving inventions, were regarded as more than compensating the loss. The advantages gained by foreign exhibitors of valuable productions were also very great.—Of other industrial exhibitions in the United States, besides the world's fair in 1853, the most important are those of the American institute of the city of New York, founded in 1828, and incorporated in 1829, for the encouragement of commerce, manufactures, and art. For several years the annual fairs were in part agricultural and horticultural, but lately they have been almost wholly industrial, and are open to exhibitors from all parts of the Union. The large space required for the fairs has compelled the use in successive seasons of such places as Castle Garden, the crystal palace (1854-'8), and now (1874) the premises known as the "Rink," near the Central park, which the institute has purchased. The association has a fund of \$75,000 in government bonds, and owns real estate in New York renting for \$12,000 a year. Its fairs are profitable. The 42d exhibition, in September and October, 1873, had 1,146 exhibitors and more than 600,000 visitors; the receipts from admissions and other sources were \$63,382 32; expenditures, \$48,675 94; profit, \$14,706 38. The Franklin institute of Philadelphia, similar to the New York American institute and founded about the same time, is especially devoted to the mechanic and inventive arts, and has held occasional exhibitions; it also publishes a valuable journal, which at the close of 1873 had reached the 93d semi-annual volume. An association in Cincinnati has held four industrial exhibitions, and the fifth is announced for September, 1874. The ninth industrial exhibition of the mechanics' institute of San Francisco, from Aug. 18 to Sept. 18, 1874, is announced as "open to all the world." Baltimore, Boston, and Buffalo have held successful local industrial exhibitions. For several years past nearly all the county and state agricultural societies throughout the Union have made annual exhibitions of local manufactures, industries, and arts, as well as of agricultural products, with liberal prizes to competing inventors, manufacturers, and exhibitors.—Among important industrial exhibi-

tions that are now projected may be mentioned an international one of female industry at Florence, probably in 1874. The announcements of special industries to be exhibited at the annual internationals in London are made for each year from 1874 to 1880. A law of congress, March 3, 1871, authorizes "the celebration of the centennial of American independence by an international exhibition of the arts, manufactures, and natural resources of this and other countries." The proposed exhibition is to be held in Philadelphia from April 19 to Oct. 19, 1876. An act of congress, June 1, 1872, fixed the capital at \$10,000,000, which the commissioners apportioned among the states according to population. Up to June, 1874, New Jersey had appropriated \$100,000, Pennsylvania \$1,000,000, Philadelphia \$1,500,000, and local subscriptions, together with individual subscriptions throughout 25 states and territories, brought the sum total to about \$4,000,000; and an effort was in progress to procure private subscriptions for the balance.—Among the more important works relating to the principal exhibitions are: "The Official Catalogue of the Great Exhibition of 1851" (4 vols. 4to, London, 1851); "Official, Descriptive, and Illustrated Catalogue" of the same (3 vols.); "Reports by Juries" (6 vols.); "First Report by Commissioners" (1852); the elaborate work printed for the commissioners (13 vols. fol.), and the same in French (13 vols. 8vo, Paris, 1857-'66); "Report of the World's Fair" (New York, 1858); *Exposition universelle de 1855*, by the French commission (3 vols. 8vo, Paris, 1857-'8); "Reports of the International Mixed Jury" (in French, 2 vols. 4to, Paris, 1856; in English, London, 1856); the reports of the royal commissioners on the exhibition of 1862 (4 vols., London, 1863); "The Exhibited Machinery of 1862," by D. K. Clark (London, 1862); the reports of the French and English commissioners on the Paris exposition of 1867 (Paris and London, 1867); reports of the United States commissioners on the same (6 vols., Washington, 1870); the special report on "Machinery and Processes of the Industrial Arts and Apparatus of the Exact Sciences," by F. A. P. Barnard, LL. D., a commissioner for the United States (Washington, 1869); and "Reports of Artisans selected by the Society of Arts to visit the Paris Universal Exhibition of 1867" (London, 1867). No comprehensive work on the Vienna exposition of 1873 has yet appeared (1874), though several minor reports have been published.

**INES DE CASTRO.** See CASTRO, INES DE.

**INFALLIBILITY** (later Lat. *infallibilia*, not liable to be deceived, from *in*, privative, and *falli*, to be deceived, to err), a doctrine of the Roman Catholic church, which attributes to that church as the divinely appointed teacher of mankind, and to the Roman pontiff as pastor of the whole church, the privilege of being preserved from teaching error. Infallibility is not to be confounded with impeccability, which means im-

from sin. The special assistance of the Spirit which preserves a person from error in the discharge of a certain office is a grace supernatural order, called by theologians *gratia data*, a grace bestowed for the others than the recipient, such as the grace of the priesthood bestowed on good and just men, and the gift of prophecy found in Balaam and Caiaphas. It is thus distinguished from graces which are vouchsafed to their possessor, like that by which John the Baptist and Jeremiah were preserved before their birth; a grace of this sort is called *gratia gratum faciens*. The privilege of infallibility is also to be distinguished from inspiration; because inspiration in many cases is a new revelation, whereas both the inspiration of the pontiff and the witness, and judges of the revelation already made are merely preserved from error in expounding, and defending the revelation. By the dogmatic decree of the council of the Vatican, the infallibility is ascribed to the church by Catholics and is held to have been directly and immediately conferred on St. Peter, and in him on the bishops of Rome. I. Roman theologians ground the infallibility of the church principally on the texts of Matt. xvi. 19: "Go ye, therefore, and teach all nations, baptizing them in the name of the Father, and of the Son, and of the Holy Ghost; and whatsoever ye shall bind on earth shall be bound in heaven: and whatsoever ye shall loose on earth shall be loosed in heaven: and I will give unto you the keys of the kingdom of heaven: and whatsoever ye shall bind on earth shall be bound in heaven, and whatsoever ye shall loose on earth shall be loosed in heaven;" and Matt. xvi. 18: "I will build my church, and the gates of hell shall not prevail against it: and I will give unto thee the keys of the kingdom of heaven: and whatsoever thou shalt bind on earth shall be bound in heaven, and whatsoever thou shalt loose on earth shall be loosed in heaven." These words of Christ, constituting the commission or charter of the church, and maintaining, established her as the universal perpetual teacher of mankind, gave into the church the deposit of the divine faith and entrusted her office to be that of sole interpreter of the same, bestowed on her the sole authority existing upon earth in matters of faith and morals, over the reason and will of man, and that in the discharge of this office she should have the Lord with her until the end of the world. Faith in Christ through her teaching, and assistance to her in the fulfilment of her office, is required under pain of damnation. It is held to be repugnant alike to the nature of God and to that of man, that God should compel the assent of the reason and the will of the will to a teaching liable to be the object or matter embraced by this teaching is the whole body of revealed truth, written and unwritten, and all that is so held with it that without treating of it as the will of God could not be guarded, explained, and defended; such would be the destruction of the canon, authenticity, and true interpretation of Scripture, and the like. The church claims an infallible guidance

in discerning and defining all matters which are opposed to revelation; for, it is argued, she could not discharge her office of teacher of mankind, unless she were able to proscribe with infallible certainty all doctrines at variance with the Word of God. Hence, the direct object of the infallibility of the church is the revelation or Word of God; and the indirect object is whatever is necessary for its exposition and defence, or contrary to the law of faith and morality. II. Pontifical infallibility is thus defined in chapter 4 of the constitution *Pastor aeternus*, July 18, 1870: "We teach and define that it is a dogma divinely revealed, that the Roman pontiff, when he speaks *ex cathedra*, that is, when, in discharge of the office of pastor and doctor of all Christians, by virtue of his supreme authority, he defines a doctrine regarding faith and morals to be held by the universal church, by the divine assistance promised to him in blessed Peter, is possessed of that infallibility with which the divine Redeemer willed that his church should be endowed for defining doctrines regarding faith and morals; and that, therefore, such definitions of the Roman pontiffs are irreformable of themselves and not by the consent of the church." This definition declares that the pope is infallible when speaking from his seat of authority, in discharge of his office of pastor and teacher of the entire Christian fold, and challenging the assent of the universal church. The doctrinal point defined or finally decided must relate to faith and morals, and in such definitions, it is declared, he is divinely guided by virtue of the promises made to him in the person of Peter. This infallibility of the pontiff has the same extension as the doctrinal office of the church, and the final judgments pronounced in its exercise are in themselves irreformable or irreversible, even before the church has accepted them. The definition limits the infallibility and the divine assistance which secures it to the pope's official acts as pastor and doctor of all Christians. It thus excludes all his acts as a private person, doctor, theologian, local bishop, or ruler. He is exempt from error in only one capacity, that is, when as teacher of the whole church in faith and morals he speaks from the chair of Peter. The phrase doctrine of faith and morals signifies the whole revealed Word of God, the whole way of salvation through faith, or the whole supernatural order with all that is necessary for the salvation of mankind through Jesus Christ. The efficient cause of this infallibility or immunity from error is declared to be the divine assistance promised to Peter, and in Peter to his successors. This, it is asserted by Catholic theologians, is contained explicitly in the words of Christ to Peter, Luke xxii. 32: "I have prayed for thee, that thy faith fail not: and when thou art converted strengthen thy brethren;" and implicitly in Matt. xvi. 18: "And I say also unto thee, That thou art Peter, and upon this rock I will build my church; and the

gates of hell shall not prevail against it." The assistance thus promised and its effect are a divine ordinance. It is further affirmed that before the definition of the Vatican council, the infallibility of the pontiff was a doctrine revealed by God, delivered by the constant tradition of the church, recognized in œcumenical councils, presupposed by the acts of the pontiffs in all ages, taught by all the saints, defended by every religious order, and by every theological school except the Gallican, and in that school only disputed by a numerical minority and during one period of its history, and believed at least implicitly by all Catholics. The definition, Catholics believe, has added nothing to the intrinsic certainty of this doctrine, which is derived from revelation. It has only added the extrinsic certainty of universal promulgation, binding the whole church to believe the dogma explicitly.—The doctrine of pontifical infallibility, theologically considered, is intimately connected with the pontifical supremacy; and, considered historically, it is seen that from the exercise of the supremacy was gradually evolved and finally asserted the prerogative of infallibility. The bishops of Rome at a very early period claimed a supreme and final authority in deciding all ecclesiastical disputes; and this claim they founded on the fact of the see of Rome being the seat of Peter's authority, and of their being his successors with supreme jurisdiction over the entire church. On the other hand, the opposition to the exercise of this supremacy forms a parallel and continuous record in the early church down to the consummation of the Photian schism. Thus, in the ante-Nicene period Pope Victor I. (about 193) claimed to decide finally the controversy about the proper day for celebrating Easter, and excommunicated the Asiatic churches which refused to abide by his decision; and Pope Stephen I. (253–257) decided against St. Cyprian and the churches of northern Africa, that baptism performed by heretics should not be repeated, and annulled the sentence of a Spanish synod against two bishops. But the decision of Victor was set aside by the Asiatic bishops; and in like manner the bishops of Africa and Spain persisted in upholding their own local customs and established rights. Earlier still Tertullian, in his treatise *De Pudicitia*, complained that the Roman pontiff issued peremptory edicts, as if he were "bishop of bishops." From the time of Constantine the Great this exercise of supremacy, and the right on which it was founded, were brought into greater prominence by the part taken by the Christian emperors in convening councils and enforcing their decrees, by the conflicts which occurred between the councils themselves and the authority of the popes, and by the contests for preeminence waged by the see of Constantinople with the patriarchal sees of the East, and with Rome herself. Thus Leo the Great received the appeal of Celsidomus, bishop of

Besançon, deposed by Hilary of Poitiers, and restored him to his see; thus, also, it is maintained, his doctrinal letter was received as a final decision by the council of Chalcedon (451). Another document quoted by ultramontane theologians as pointing to an exercise of supremacy, is a letter of Pope Gelasius in 493, in which it is said: "The canons themselves refer the appeal of the whole church to the examination of this chair. They decree that from it there is no further appeal, and by it the whole church is judged; it goes for judgment to none, nor can its judgment be judged, nor its sentence reversed." (Labbe, vol. iv., p. 1169.) Against this claim of deciding all ecclesiastical causes without appeal, thus distinctly formulated in the 5th century, is quoted the recently established fact of the Roman presbyter St. Hippolytus having been at the time of his death in opposition to the pope, his superior, as well as the instances in which popes fell into heresy or encouraged heretical opinions. Such were the cases of Zozimus, who commended the Pelagian teaching of Celestius; Julian, who affirmed the orthodoxy of the Sabellian Marcellus of Ancyra; Liberius, who subscribed (359) the Arian creed of Rimini; Vigilius (547), who contradicted himself thrice on a question of faith; and Honorius, who lent the whole weight of his authority (633) to the support of the nascent Monothelite heresy, and was solemnly excommunicated by an œcumenical council for doing so. Still the bishops of Rome persisted in their claims, while in the East the resistance to them grew as the patriarchs of Constantinople rose in power and influence among the eastern hierarchy, until the conflict of jurisdiction ended (879) in the disruption of Christendom. In western Europe the primacy of the Roman bishops continued to be universally acknowledged after the separation of East and West; but their personal infallibility was never maintained in a formal theological thesis till the time of Thomas Aquinas. He however does not employ the term infallibility; he says that the same security from error in teaching, judging, and determining all that pertains to faith, which is ascribed to the church, belongs also to the Roman pontiff, by virtue of the promise made to Peter. The thesis, thus placed in distinct form before the great theological schools of Europe, soon acquired increased definiteness and interest from the contests between temporal princes and the popes, and between rival claimants for the papacy and the ecclesiastical assemblies convened to heal the great western schism. Philip the Fair in 1303 declared his intention of calling a general council to judge Pope Boniface VIII. In the council of Constance, where the French clergy largely predominated, the French theologians D'Ailly and Gerson proposed the framing of a decree declaring an œcumenical council superior to the pope. In the council of Basel, soon afterward, this superiority was urged against Ege-

particularly after he had dissolved that the superiority of œcumenical councils and authority was embodied in the pragmatism of Bourges in 1483, both as a legal maxim and as a rule of national conduct. Thenceforward the theologians were who maintained this superiority called Gallicans, and their opponents ultramontanes. Gallicanism, considered as a system of jurisprudence and theological doctrine, comprised the liberties or franchises of the Gallican church, and the peculiar tenets of churchmen with regard to the nature and extent of the pontifical supremacy. These franchises were understood in one sense by the churchmen, and in quite another by the magistrates. In reality they affirmed that the pope had no right, by virtue of his office, to interfere with the king in the exercise of his crown or the lawful exercise of his power; that the election of ecclesiastical dignities, the collation of benefices and the alienation of their revenues, the imposition of taxes on church property, beyond the inherent right and custom of the Gallican church, under the protection of the king. These franchises, and the doctrine of the Gallican church concerning the pope's inferiority to a general council, were formulated in six articles presented to Louis XIV., May 8, 1663, and were reaffirmed with greater solemnity in 1763. The famous "four articles" then adopted by the assembled clergy, besides the independence of the civil power, defined the plenitude of power in spirituals as belonging to the successors of St. Peter, and that by the decrees of the council of Constance which have ever been in force in the Gallican church; that the use of the pope's civil power is to be regulated by the laws and within the kingdom of France by the ancient rules, customs, and constitutions; that, although the pope has the chief authority in questions of faith, and his decrees bind all the churches, and each church in particular, nevertheless his judgment is not irrevocable until the consent of the whole church is obtained. The whole question of infallibility was debated by Jansenists, Gallicans and ultramontanes. The whole question of infallibility was debated by Jansenists, Gallicans and ultramontanes. When worship was restored by Bonaparte, the old French hierarchy with all its franchises, and established new sees and new episcopal dioceses. But Bonaparte inserted in the concordat, on its publication, what is known as the "organic articles," which among other things reaffirmed the offensive portion of the declaration of 1682. This was mainly the law of the land and a rule of policy through every change of government, although Gallicanism itself was on the wane. In 1867 it was resolved that an œcumenical council should be convened without delay; and it soon became generally known that one of the doctrinal questions to be decided in the council was that of pontifical infallibility. A warm discussion immediately began as to the opportuneness as well as the possibility of such a definition. Conspicuous among the opponents of the contemplated measure was Dr. Dollinger of Munich, and among its promoters Archbishop Manning of London. The Jesuits, always the most strenuous advocates of papal prerogative, used all their influence to secure the definition. In France the bishops were divided; in England, Ireland, the United States, Germany, and Austria, a majority would have preferred delay; but Italy and Spain were for instant definition. Among the European governments a strong diplomatic effort, originating with Bavaria and seconded by France, was made to dissuade the court of Rome from a step deemed full of danger. On Dec. 8, 1869, the council was opened by Pius IX. in the Vatican basilica of St. Peter's. A first doctrinal constitution on Catholic faith, having been elaborated and accepted, was officially proclaimed, April 24, 1870. Then began the discussion of a second constitution "on the church," ending with the decree on pontifical infallibility. Outside the council itself, the dogma in its theological and historical aspect, and its bearing on the relation of the church to civil governments, was vehemently discussed in the press. A correspondence between Bishop Dupanloup and Archbishop Manning, and the publication of an exhaustive Gallican argument by M. Maret, bishop of Sura, had created much interest just before the opening of the council; and this was largely increased by the appearance during its sittings of a series of letters in the Augsburg *Allgemeine Zeitung* signed "Janus," afterward published in book form with the title of "The Pope and the Council." (See DÖLLINGER.) Another series of letters from Rome were printed in England from the pen of "Quirinus," while two more issued from the French press entitled *Ce qui se passe au concile* and *La dernière heure du concile*. Within the council itself every portion of the *schema* or draught was warmly discussed. On July 11 the *schema* of the chapter on infallibility was discussed in detail and adopted in a general congregation; and the whole *schema* was put to the vote in another congregation held on the 18th. Each prelate voted *placet*, if content; *placet juxta modum*, if only content with a part; or *non placet*, if not content. The register showed 451 as voting *placet*, 62 *placet juxta modum*, and 88 *non placet*. On July 18, in solemn session, 534 prelates answered *placet*, 2 *non placet*, and 65 were absent, of whom a majority did not wish to vote favorably.—See Archbishop Manning's *Petri Privilegium* (London, 1871), and "The Pope and the Council," by Janus (Boston, 1870). (See also OLD CATHOLICS.)

**INFANT.** All persons are called infants, by the common law of England and America, until the age of 21, though in Vermont, Maryland, Illinois, and perhaps some other states, by statute, women are of full age, for most purposes at least, at 18. An infant becomes an adult, or of full age, at the beginning of the last day of his 21st year, or the day before his 21st birthday, upon the ancient principle that the law knows no parts of a day, and when the last day of infancy begins, it is considered as ending. The most general principle in reference to the legal condition of an infant is his inability to bind himself by his contract. The law asserts this inability for the sake of the infant, not as a restraint, but as a protection to him, and finds that upon the average of mankind this protection should be extended until the age of 21. This inability being intended for his protection only, in legal phrase it is said to be his shield, and he must not use it as his sword. Because it is for his benefit, the first and most important exception is, that he may bind himself by his contract for necessities; for it might harm and could not help the child if he were unable to pledge his credit for shelter, clothes, or food. At first the exception was confined to strict necessities; but it has been gradually extended, until now it is frequently said to mean all those things which it is perfectly proper for the infant to have, taking into view his age, his means, and his condition or circumstances. Thus he may make a valid bargain for clothes, or even ornaments or furniture, as well as food and lodging, more expensive than another may need, but not extravagant or superfluous for him. In England it has been held that instruction in reading and writing is among these necessities for every one who could pay for it. In the United States it is held that the full benefit of a good school education is among these necessities; and there seems to be no reason to doubt that a collegiate education will be held within the rule. So, as an infant may lawfully marry, necessities for his wife and children may be lawfully contracted for by him. The line is drawn so as to exclude quite distinctly all trade or business bargains; for the whole legal doctrine of infancy rests on the assumption of the infant's inability to carry on the business of manhood until he has the maturity of at least 21 years. And it should be noticed that not all his contracts even for necessities are, strictly speaking, valid. Thus, if he buys suitable food or clothing, and agrees to pay a certain price therefor, or gives his note therefor, he is not bound to pay that price or that note; but if sued on the promise, he may defend so far as to show that the food and clothing were not worth as much as he promised to pay, and then he will be held only for their value. But he cannot avoid his obligation to pay their full value, merely because he promised to pay too much. Formerly the distinction was, that an infant's contracts, not for

necessaries, were entirely void, if the court saw that they could not be beneficial to him, but only voidable by him if this were doubtful. Now, however, the prevailing rule is, that all contracts of an infant, not for necessities, are voidable by him, but that none are void; because all may be made valid by his ratification after full age, which could not be the case if they were wholly void at their inception. Any acts or words of affirmance on his part have the effect of this ratification, if they are made after majority; but a mere acknowledgment that when he was an infant he made such a promise, does not bind him when adult. The mere fact that, after full age, he does not disaffirm his contract made in infancy, does not amount to a ratification; but it may be made to have this significance and effect by circumstances, and certainly has this effect if after majority he voluntarily continues for any considerable time in use, possession, and ownership of property acquired by his contract made while an infant. A distinction is taken here between an infant's real estate and his personal estate; and it is said that he may ratify a contract for the latter with much less of formal and positive ratification than is necessary for the confirmation of his conveyances of real estate. Still, a silent acquiescence in the possession of his grantee, if long enough, and with full knowledge of his rights, may amount to ratification.—As the disability of an infant is only for his personal benefit, no one can take advantage of it but himself or his legal representatives. Therefore, if an adult makes a business contract with an infant, the adult is bound, although the infant is not. Thus, an infant may sue an adult for a breach of promise of marriage; but neither an adult nor an infant can sue an infant for such breach. So an infant may bring an action on a mercantile contract, although such an action cannot be brought against him. It is sometimes important to determine whether an infant is bound by the obligations which attach to property that he acquires by his contract. If he takes the property by direct operation of law, as by descent or marriage, there is no question, for the rule *transit terra cum onere* would apply, and be extended even to property that was not land. But if he acquires the property by his own act, the law may not be so certain. Thus, an infant who takes a lease of land, and holds possession until rent is due, is bound to pay the rent, like any other person; but he may, when he will, disclaim the land and annul the lease, or rather suspend the lease; for it is said that when he is of age he may avoid his disclaimer. So, if he buys stock in a corporation, he is liable like an adult for assessments and calls, but may waive his contract and give up his stock. While an infant is protected against his contracts, he is not protected against his acts; that is, he is answerable in like manner as any other person for the injury he inflicts by his wrong doing, excepting so far as actual infancy or in-

rity tends to make him irresponsible, or to  
 e him, as an equal amount of actual inca-  
 y would excuse any one. But, in the case  
 t, as before in the case of contract, if he  
 his promise or his note as a compensation  
 e wrongs he inflicts, he would be held not  
 s promise, but only to the extent of his  
 al liability. The most interesting and  
 ost difficult application of the rule, that  
 fant is liable for his wrong doings, occurs  
 tion to his frauds in representing him-  
 s of full age. Where his tort is merely  
 reach of his contract, he cannot be sued  
 e tort, for this would be holding him in-  
 dly to his contract. But if there is a dis-  
 wrong for which he is responsible, he is  
 erable, although it be connected with the  
 act; and this, whether it be before or af-  
 e contract. Thus, if he hires a horse for  
 unnecessary ride, he is not liable for the  
 but if in the course of the ride he abuses  
 njures the horse, for this we should hold  
 he would be liable; and if he should sell  
 orse, an action for its value would lie, nor  
 l his infancy be a bar. So if he falsely  
 raudulently represents himself as of full  
 nd on the strength of these representa-  
 his note or bond is received in payment  
 purchase, he cannot be held on the note  
 nd, nor as purchaser for the price of the  
 ; but the purchaser may have redress in  
 roper action for his fraud. And it would  
 that infancy should not be a bar to an  
 founded upon a false and fraudulent  
 nty, although on this point the authori-  
 re in conflict. So if goods are sold to an  
 t on his fraudulent representation that he  
 age, we should say that the seller might  
 ler the sale null and void, and reclaim his  
 as soon as he discovers the fraud; but  
 ps not until his refusal to pay, or some  
 indication of his intending injury. We  
 t think, however, that his mere silence, and  
 rmitting the seller to act on the suppo-  
 that he was of full age, would have this  
 . When goods are sold to an infant with  
 andulent representation on his part, and  
 a knowledge of his infancy on the part of  
 ilder, and the infant subsequently refuses  
 y for them, and avails himself of his in-  
 , as he certainly may, to refuse payment  
 e price, some doubt, or at least some con-  
 exists as to the rights of the seller. Some  
 rities hold that the seller is remediless,  
 se the privilege of the infant protects  
 altogether. Other authorities hold that  
 rilege goes no further than to permit  
 to cancel the sale if he will, for this is  
 enough for his protection; and when  
 ale is cancelled, its effect is wholly de-  
 ed, and the thing sold becomes again the  
 erty of the seller, who may repossess him-  
 f it at his pleasure. It seems to be un-  
 ily admitted that if the infant has re-  
 l the goods and paid for them, he may  
 n the goods and recover the money, but

cannot recover the money without returning  
 the goods.—A very important part of the law  
 of infancy, and that which perhaps gives rise  
 to more disputes and litigation than any other,  
 is that which determines the obligation of the  
 parents in respect to infant children. Unfor-  
 tunately, a part of this law is not quite settled.  
 In some form or other, and in some degree,  
 the obligation of a father to maintain his in-  
 fant child is acknowledged by the law of all  
 civilized communities. For the infant cannot  
 support himself, and therefore some one must  
 do it; and then the only question is, whether  
 this obligation falls directly on the state, or  
 in the first place on the father. Justice and  
 reason and all the best feelings of human na-  
 ture would seem to answer that it is primarily  
 the duty of the parent. But in England, after  
 some uncertainty, and with some reluctance,  
 and perhaps some tendency to make this moral  
 obligation of the father a legal one also, it  
 seems now to be the prevailing and perhaps  
 established rule, that there is no other founda-  
 tion for the liability of the father for necessa-  
 ries supplied to the child, excepting the princi-  
 ple of agency; that is, the father is liable only  
 when the child contracts for them, and may be  
 deemed the agent of the father in making the  
 contract. In a number of our states this doc-  
 trine has been very positively asserted. But  
 in England, and in all of the United States  
 which require the father's authority to be  
 proved, this authority is inferred from very  
 slight evidence. Perhaps no case goes so far  
 as to say directly, that if a father sees or  
 knows that goods are supplied to his infant  
 child, and he does not signify his dissent, his  
 assent and responsibility may be inferred; but  
 some of them go, in fact, to almost this extent.  
 But the question occurs: How would these  
 courts decide where the case was one which  
 made agency or authority impossible? As if  
 an infant of a month old, or an older child  
 reduced to utter incapacity by starvation or  
 illness, were lost in a wood, and found by a  
 person who supplied him with strict necessa-  
 ries; would he have no claim on the father?  
 Perhaps the law on this subject cannot be said  
 to be determined either in England or Amer-  
 ica; but as prevailing rules, in this country at  
 least, derived from an investigation and com-  
 parison of the authorities, we should say: 1,  
 where goods are supplied to an infant which  
 are not necessaries, the father is not answer-  
 able unless his authority can be proved in the  
 common way; 2, where necessaries are supplied,  
 his authority will be presumed, unless he either  
 supplied them himself, or was ready to supply  
 them; 3, where an infant lives with the father  
 or under his control, the father's judgment as  
 to what the child should have will be so far  
 respected, that he will be held liable only for  
 those things which were strictly necessary to  
 preserve the child from absolute want and suf-  
 fering; 4, where the child has voluntarily left  
 the father, and does not live with him, the

father's authority must be strictly proved, unless in case of extreme youth, or perhaps of absolute necessity; 5, where the child has been cruelly driven away by the father, he carries with him the father's credit for necessaries; 6, in all these rules, "necessaries" mean strict necessaries; and if the child is able to earn or provide them in part, this must be taken into consideration. Where a child has an independent property of his own, courts now go, in general, very far in requiring this to be made the fund for his support, before the father is called upon. Whether the mother is under the same liability as the father may not perhaps be certain; but we consider the decided weight of authority as qualifying the mother's liability importantly, even where its existence is admitted. —The father thus liable for the child is entitled to its custody (unless for special reasons), and is also entitled to all the child's earnings; but he may agree with his minor child to relinquish his right, and thereafter to have no responsibility for his support. Such agreements are common in the United States; but if a stranger supplied a minor child, at a distance from home, with strict necessaries, to save his life or health, even with knowledge of this bargain, we are not disposed to believe that it would bar his claim against the father. If a child is of full age, the obligation to support him is no entirely gone, that even if a father, after necessaries are supplied to an adult child without his request, promises to pay for them, he cannot be held on this promise, because there is no legal consideration for it. It may be added that if an infant, while under his father's care, and actually supported by him, makes a contract even for necessaries, and gives his own promise to pay for them, the infant is not liable on this contract or promise, because, as it is said, this would interfere with the father's right to judge what is necessary for him. Perhaps a better reason is, that in such a case these things are not necessary in any proper sense of the word, for the very reason that the child derives a sufficient support from the care of the father. — A father is never liable for the wilful tort of an infant child; nor has he a right, merely as father, to bring an action in his own name for an injury to his child, unless in some way, as by the necessary expense or otherwise, he is himself injured. Neither can he give a valid release for an injury to his child.

**INFANTE** (Lat. *infans*, infant), a title given in Spain and Portugal to the royal princes, the eldest of whom, the heir apparent to the crown, is alone called *el principe*, the prince. The feminine form of the word, *infanta*, is applied to the royal princesses. The term *infante* occurs in documents of the 10th century.

**INFANTE, José Miguel**, a Chilean statesman, born in Santiago in 1778, died April 9, 1844. He was one of the earliest leaders of the revolution of 1810, which ended in the independence of Chili; contributed to organize the *junta gubernativa* in the same year, and the

first congress, which assembled on July 4, 1811; and was a member of the new junta of 1813. In 1818 he became minister of finance under O'Higgins, against whom on Jan. 2, 1823, he delivered a noted speech. O'Higgins shortly afterward resigned, and the country was then governed by a junta, of which Infante was the first member, until the election of President Freire, by whom Infante was called to organize a senate. During the first session of that body, his bill for the abolition of slavery was enacted, June 24, 1823. Freire being absent in 1823, the government was reposed in a dictatorial council with Infante at its head. He advocated the formation of Chili as a federal republic, and founded a newspaper, the *Faldiciano Federal*, which he published from Jan. 1, 1827, till near his death. In 1831 he was appointed member of the congress of plenipotentiaries, and in 1843 chief judge of the supreme court of justice, and member of the faculty of law of the university of Chili. He was influential in establishing primary schools, and has been called the "father of his country."

**INFANTRY**, the foot soldiers of an army. The term is comparatively modern, having been first used by the Spaniards in the wars with the Moors, to designate the body guard of a royal prince or *infante*. It was gradually extended to the entire body of foot soldiers, and finally adopted throughout Europe. (See ARMY.) The infantry, from its powers of endurance, its capabilities for battle on all kinds of ground, and its independence of those casualties by which other arms may be completely paralyzed, is, and with few exceptions always has been, considered the first arm in importance. All other branches are subsidiary to it, and are employed for special purposes to supplement its final effects; and the fate of nations in war at the present day is decided by the discipline and efficiency of their infantry. The service of skirmishing and light infantry operations, as they were formerly called, which now devolve upon all infantry alike, demand great individual address, intelligence, and well developed physical power. It is generally conceded that against infantry operating with the modern breech-loading weapons, and with the improved system of tactics and defence, cavalry is powerless, except when operating dismounted and armed with breech-loading magazine rifles, or mounted to complete a victory already won, and to charge the disorganized and flying ranks. (See CAVALRY.) Artillery is of the utmost importance to cooperate with infantry, in opening engagements and in demoralizing the enemy with persistent shelling until the infantry is within firing distance. (See ARTILLERY.) The relative number of field guns varies with the ground and the special objects to be secured; from three to five guns to 1,000 men is the number adopted in most army organizations of the present day.—The lessons taught by history applicable to infantry of the present day are few and simple, but seem to

often or ignored by those in authority  
 outbreak of almost every great war.  
 re, that the infantry soldier should pos-  
 highest attainable mental, moral, and  
 development; be governed by the  
 discipline, and show implicit and un-  
 waning obedience to the superior officer;  
 controlled by the simplest possible manœu-  
 the field or in presence of the enemy;  
 loaded as little as possible either with  
 equipment. From the Napoleonic pe-  
 within the last 12 or 15 years some  
 ations had been made with reference to  
 y, but they were comparatively unim-  
 Within this period, however, the in-  
 of the rifle with the conical ball of  
 the breech-loading needle gun of Dreyse,  
 number of other modern improvements,  
 caused a very considerable change in the  
 organization and manœuvring of infantry; and  
 the general introduction of the breech-  
 rifle, with the improved system of field  
 art, has completely altered the phenomena  
 of battle field.—*United States.* The in-  
 fantry of the regular army of the United States  
 before the civil war has been reduced in num-  
 beral times, and now consists of but 20  
 regiments, each composed of 10 companies, and  
 a company on the peace establishment of  
 100 men. The officers of the regiment  
 consist of a colonel, a lieutenant colonel, a major, a  
 lieutenant adjutant, and a regimental quarter-

Each company is commanded by a  
 captain, and has one first and one second lieu-  
 tenant, and may have an additional second  
 lieutenant, a graduate of the military academy.  
 The non-commissioned staff consists of a quar-  
 ter sergeant and a sergeant major. Each  
 company has one orderly sergeant, three com-  
 munes, and four corporals. Congress,  
 when necessity arises, authorizes the presi-  
 dent, commander-in-chief, to increase the  
 number to the maximum standard. In each state  
 there is a militia, in time of peace under the  
 command of the governor, in time of war in  
 contingencies, under that of the presi-  
 dent of the United States, which conforms  
 in respects to the regular army in tactics  
 and arms. (See MILITIA.) The arm of the  
 States infantryman is the Springfield  
 breech-loading rifle. (See RIFLE.) The equip-  
 ment consists of a knapsack with greatcoat straps,  
 a canteen, a cartridge box, and  
 a net scabbard. The uniform, for pri-  
 vates, consists of a single-breasted dark blue  
 frock coat, sky-blue trousers, blue cloth cap  
 with white pompon; for officers, a double-  
 breasted frock coat of dark blue cloth, the  
 buttons determine the number of buttons,  
 light blue trousers with black stripes.  
 The greatcoat is a dark blue double-breasted  
 . (For detailed description, see gen-  
 erals No. 92, war department, adju-  
 tant's office, Oct. 26, 1872.) Privates  
 and non-commissioned officers are liberally  
 supplied with underclothing, blankets, and

waterproof blankets. They can either draw  
 their clothing in kind or commute it. Officers  
 and men are allowed a definite amount of  
 camp equipage, consisting of wall tents, shelter  
 tents, mess pans, camp kettles, hatchets, axes,  
 and spades. In the field, officers are allowed  
 a definite amount of baggage transported at  
 the expense of the government. Privates are  
 obliged to carry their personal effects on their  
 person. The pay of the United States infantry  
 is as follows: colonel, \$3,500 per annum;  
 lieutenant colonel, \$3,000; major, \$2,500;  
 captain, \$1,800; adjutant, \$1,800; regimental  
 quartermaster, \$1,800; first lieutenant, \$1,500;  
 second lieutenant, \$1,400; chaplain, \$1,500;  
 first sergeant, \$22 per month; sergeant, \$17;  
 corporal, \$15; private, \$13. An increase of 10  
 per cent. is allowed for every five years' ser-  
 vice, provided the total amount of increase does  
 not exceed 40 per cent. of the whole pay.  
 Mounted officers are allowed forage for their  
 horses. If quarters are not furnished by the  
 government, commutation is allowed. An in-  
 crease of \$1 a month for the third, fourth, and  
 fifth years of the first enlistment is allowed to  
 non-commissioned officers and privates.—The  
 great lesson taught by the civil war in Amer-  
 ica was, that the defence derived an immense  
 benefit from shelter, however slight. The  
 rifle pit in the last years of the war was per-  
 haps the most marked feature in the American  
 system. Though generally not armed with a  
 breech-loading weapon, but simply with the  
 Springfield muzzle-loading rifle, experience  
 showed that, so long as the men behind in-  
 trenchments preserved their *morale*, the dam-  
 age inflicted on the enemy was frequently  
 nearly ten to one. Skirmishing, which was  
 adapted to the character of the American hun-  
 ter and backwoodsman, and which was first  
 introduced to general notice in the war of the  
 revolution, received a new impetus in the civil  
 war, and was constantly employed on both  
 sides. The character of the ground, broken  
 and timbered, also generally favored this sys-  
 tem of warfare. The Prussians have since  
 adopted the skirmish line as the normal for-  
 mation for battle, having been compelled dur-  
 ing the Franco-German war to abandon the  
 attack in masses in consequence of the destruc-  
 tiveness of the breech-loader. They have since  
 adapted their tactics to the new method of  
 fighting. Cavalry cooperating with infantry  
 was rarely used; but field artillery was brought  
 to a state of great perfection, and was exten-  
 sively used to open engagements and coop-  
 erate with the foot. The infantry was generally  
 drawn up in one or two lines of battle in two  
 ranks, with a reserve at a proper distance in  
 the rear to supply gaps and strengthen that  
 portion of the line most heavily pressed. The  
 skirmishers were in advance whenever the  
 enemy's position was not known. The attack  
 was generally opened by a fire of artillery, fol-  
 lowed by a gradual advance of the whole line,  
 and finally a charge at a run. The system of



tactics used was that known as Casey's. It was an improvement on Scott's "Tactics," which was substantially a translation of the French *Ordonnances* of 1831 and 1845. Casey's system, which was succeeded by that of Hardee, was in turn superseded by that of Upton in August, 1867. This system, which is based upon a front of four men as a unit, seems the best adapted to meet the requirements of infantry manœuvres of the present day. To give the breed-leader its maximum effect, it provides a single-rank formation, and also a new method of deploying skirmishers by numbers, by means of which, without destroying the manœuvring unit of four, a battalion in line, in double rank, can promptly furnish one, two, three, and even four successive lines of skirmishers, each equal in strength to one eighth of the battalion. The first line, if too weak, may thus be reinforced by successive lines till one half of the battalion is engaged, leaving the other half in line in single rank, ready to advance to the support of the skirmishers if successful, or to receive them if repulsed. If necessary, the entire battalion may be advanced in successive lines or united into a single line of skirmishers. The term regiment is used in the United States for administrative purposes, and tactically is interchangeable with battalion, as it generally consists of but one, differing in this respect from most European armies, where a regiment is composed of two, three, and sometimes as many as seven battalions.—*Germany.* The highest division of infantry solely is the brigade, composed of two regiments, each regiment, with one or two exceptions, of three battalions of four companies each. Each regiment has a colonel, lieutenant colonel, and adjutant, besides a commander who is an officer of the staff, and one major as fifth officer of the staff. Each regiment has a band, varying in number. Each battalion, in war, has one wagon with munitions, containing from 16,710 to 16,910 cartridges and 1,250 explosive cartridges, 12 axes, 10 spades, &c.; one wagon containing the cash box of the battalion and accounts, articles of uniform in reserve, and the tools requisite for the shoemakers and tailors of the battalion; one cart containing drugs and medicine; one wagon for officers' equipage, and four horses with pack saddles. There are some slight changes in the arrangement for the fusileer and jäger battalions. There is still more than a nominal distinction between the different regiments of foot, those of fusileers and the battalions of jägers forming the light infantry. The fusileers have bayonets on their guns, but use short carbines. The jägers are, as far as possible, recruited from persons who wish to be hunters, and keepers and foresters, and have been accustomed to such before entering the army. Each battalion has a major and an adjutant, a captain, a lieutenant, a surgeon, a paymaster, a quartermaster, and two non-commissioned staff officers. Each company is composed of one captain, one first and one second lieutenant, and 250 enlisted men. The following table gives the numbers of the German infantry on a peace and on a war footing:

## PEACE FOOTING.

COUNTRIES	LINE		CHASSEURS		LANDWEHR		Total number of men.
	Battalions.	Men.	Battalions.	Men.	Battalions.	Men.	
Prussia*	845	201,279	14	8,021	277	8,651	212,944
Bavaria	48	26,590	10	5,500	82	512	32,602
Saxony	27	15,098	2	1,100	17	285	16,485
Württemberg	24	12,448	..	....	17	229	12,777
Total	444	255,408	26	14,621	293	4,657	274,711

## WAR FOOTING.

Number of battalions same as above.

COUNTRIES	IN THE FIELD		IN DEPOT		IN GARRISON		Total number of men.
	Line.	Chasseurs.	Line.	Chasseurs.	Landwehr.	Chasseurs.	
Prussia	856,845	14,864	189,495	4,812	194,264	8,500	710,466
Bavaria	49,844	10,920	19,406	8,050	27,434	2,100	112,616
Saxony	27,756	2,052	10,917	816	14,544	500	56,585
Württemberg	24,672	.....	9,704	...	18,712	...	65,088
Total	453,620	26,676	179,524	8,008	250,944	6,500	928,572

The gun of the German infantry during the Franco-German war was the needle gun of Dreyse. It admits of firing five times in a minute, and carries well 800 yards. It is being superseded by the Mauser rifle, sighted up to 1,600 yards, which is capable of being fired 18 times a minute, and the adapted French Chassepot, 400,000 of which were captured in the war. The prevailing color of the Prussian uniform is blue, and the coat is much like that of our own troops. For infantry the coat is a dark blue frock, with a single row of eight buttons, the collar and cuffs faced with red; pantaloons dark gray, with red cord down the seam; the boots have tops about 6 in. high; the cap for undress is of blue cloth, flat topped, with patent leather visor, and red band lace half an inch wide. The helmet is of glazed leather with a front and rear visor, a brass-sealed chin strap, a brass Prussian eagle displayed in front, and terminates at the top in a brass-pointed spike about 2 in. high. The overcoat is long and of the same color as the pantaloons. In addition the men have for fatigue and drill common cotton pantaloons and short cloth jacket. The dress of officers is very similar to that of the privates; the texture of the cloth is better, and their rank is determined by a system of braids and shoulder straps; a sword like the cavalry sabre of the American service is worn. The Prussian soldier ready

\* Including the troops of Hesse, Mecklenburg, &amp;c.

marching looks very much like the American under the same circumstances. His overcoat is made into a long slender roll and hung on the left shoulder, the two ends coming together, and being fastened on the right hip. The haversack of coarse white linen, and glass lenses covered with leather, are slung from the right shoulder. Around the flask are buckled broad straps, used in peace to cover the barrel of the gun. He wears no shoulder belt, a pipe-clayed waist belt, on which are slung two cartridge boxes of black leather, one on either side, each box holding 20 cartridges. The knapsack is of calfskin, tanned with the hair on, and is slung by two pipe-clayed leather belts. The knapsack is made in the shape of a light wooden frame. On the front end outside is a deep box in which is carried a case of 20 cartridges. On top of his knapsack is strapped a galvanized iron pot, containing about three quarts, with a tight-fitting cover, which is used separately for cooking. He wears on his waist belt a strong sword scabbard, long, which can be used for defence or for cutting wood or material for fascines and other uses. His gun is unburnished, so that it does not attract attention by flashing in the sun, and is pretty well coated with grease. He wears no blanket. A leather pouch for money is slung around the neck, and also a zinc plate attached to a card on which are engraved the name of the soldier's regiment, company, and number. The weight of arms and equipments is 50 lbs.—The tactics used by the German infantry throughout the war of 1870 was an adaptation of the French tactics of the Napoleonic period. A new ordonnance was issued in 1847 by the Emperor Napoleon III, the predecessor and brother of the present Emperor; but certain modifications have been made, from the experience of the late war, which are embodied in the royal Prussian ordonnance of March 19, 1873. (See article by Capt. von Bismarck in "United Service Magazine" 1873, No. 74.) The Prussian system is now, probably will be, the model for the rest of the world. The general theory is that every soldier must be adopted to increase the effect of his fire on the enemy's troops and to diminish the effect on our own. The tactical formation of the infantry of a recent period had been based upon the tactics of the Napoleonic era. This for the infantry was slow and very inaccurate, effective only to 200 or at most 250 yards; artillery fire was effective up to about 1,500 yards, but shell fire comparatively feeble, the greatest effect being really within the case zone of 500 yards, before effective infantry fire was reached. Under these conditions we see that troops attacking in such formations as the column of Macdonald's column at Wagram, consisting of three divisions, one of which had its battalions deployed in one great column, the battalions being in contiguous columns of battalions on the flanks; or as D'Erlon's columns at Waterloo, four divisions, each advancing in column on a front of a deployed battalion; or

as Ney's right column at Friedland, with a front of some 66 files and a depth of 80 ranks. The British troops used the line formation, at times two deep and at times four deep, in which latter formation both the guards and the 52d regiment moved at Waterloo to repulse the last attack of the French imperial guard. Passing through the skirmishers, who ran in, they advanced over the comparatively short distance which separated the contending bodies of troops, and fired upon the enemy. The attack of Longstreet's corps on the left flank of the Union army at Gettysburg is also a case in point. Such a system of tactics would be utter suicide with the weapons of to-day; and the column of attack, which has played so famous a part in modern military history, may be said to belong to the past as completely as the Macedonian phalanx or the wooden line-of-battle ships. The Prussians now employ a system of opening engagements with heavy fire of artillery, then attacking with a cloud of skirmishers, who take advantage of every hollow in the ground, tree, fence, &c., followed by columns to supply gaps. This shooting line no longer merely covers the fighting line as before, but it is the fighting line. Fed by small bodies successively brought up in extended order, their places as supports being taken by fresh bodies drawn from the rear, the fighting line may be brought to great strength. Little by little it is fed by troops not in close formation; little by little it works its way up close to the enemy; and by this feeding system of the shooting line a superiority of infantry fire is established, and the enemy's troops are demoralized. When the final attack is made, this shooting line has become much stronger, for whole battalions may have been absorbed. It is a line, but not a rigid one, depending on conditions of ground, and one which has worked its way to this point in small bodies in fighting order, without that fearful loss and consequent demoralization which must inevitably attend the advance of a rigid line of anything like its strength. Then comes the final attack, the rush of this reinforced line, this fighting division closely followed by the nearest supports. The Prussian instructions thus describe it: "If the enemy's line appears to be shaken in its holding of any part of its position, the shooting line, with the nearest but hitherto concealed supports, rush forward in quick, concentrated assault on this point; while these draw together in close division, it must be the officers' endeavor to get them quickly in hand, in order to be able to resist the enemy's counter-attack. In the mean while, the divisions in rear follow up quickly." This system of fighting requires great intelligence, individual judgment, and at the same time thorough discipline and subordination on the part of the private soldier. It is secured in Prussia by the compulsory system of education, and by the elaborate character of the military training which every soldier is obliged to undergo.—*Russia*. The Russian

army is at present (1874) undergoing a complete reorganization, and trustworthy statistics concerning its present condition cannot be obtained. The following table is derived from official statistics for 1871:

RUSSIA IN EUROPE.				
TROOPS.	PEACE.		WAR.	
	Officers.	Men.	Officers.	Men.
<b>FIELD TROOPS.</b>				
12 regts. of the guard.....	804	24,762	996	40,794
12 " of grenadiers.....	780	24,182	972	40,164
140 " of line infantry.....	8,993	216,916	11,344	464,380
24 battalions of chascours....	599	14,347	684	21,981
Staff of infantry.....	246	855	246	984
Total.....	11,427	281,012	14,238	568,258
<b>LOCAL TROOPS.</b>				
23 batt. of inf'y for fortresses.	299	8,128	401	24,225
<b>INTERIOR TROOPS.</b>				
1 batt. of body guard.....	22	561	22	561
2 " of line infantry.....	56	2,251	56	2,251
59 " of garrison.....	792	23,888	1,071	46,168
<b>RESERVES.</b>				
70 batt. of infantry.....	700	13,584	700	13,584
10 " of chascours.....	110	2,084	110	2,084
<b>TROOPS OF APPLICATION.</b>				
Inf'y, 1 batt. and 1 comp'y..	83	476	83	476

Besides the army of Russia in Europe, there are the army of the Caucasus, that of Turkistan, and that of Siberia. When the Russian army is completely reorganized it will consist in time of peace of about 750,000 men; in time of war the armies of Russia and the Caucasus will reach the number of 2,085,000 men. The proportion of artillery to infantry in the field will be about  $3\frac{1}{2}$  guns to 1,000 men; there will also be one mitrailleuse to every  $4\frac{1}{2}$  guns. The regiment is commanded by a major general in the guards and by a full colonel in the army. Each battalion has a lieutenant colonel at its head. The regimental staff consists of a regimental adjutant, a regimental quartermaster, a musketry instructor, and an officer in command of the non-combatant company. The non-commissioned staff consists of a drum major, a trumpet major, a sergeant major, three assistant sergeants, one or two chaplains, and non-combatant clerks, mechanics, &c. The battalion staff consists of a battalion adjutant, a battalion drum major, a battalion trumpet major, and an apothecary. A company has a captain, three lieutenants, and 211 non-commissioned officers and men on a war footing, as follows: 1 junker (candidate for admission), 4 senior sergeants, 12 junior sergeants, 20 lance corporals, 148 privates, 1 pay sergeant, 3 drummers, 3 buglers, 1 armorer sergeant, 12 privates in reserve, 1 apothecary, 1 assistant apothecary, 4 officers' servants. The Russian infantry has been armed with the Krinck converted rifle, but the Berdan breech-loader will shortly be issued to the whole army. The weapons are adjusted up to 600 yards, except those of rifle companies and eight picked shots in each com-

pany, whose sights are adjusted to 1,200 yards. Ninety rounds of ammunition are carried in the cartridge boxes; 40 more rounds are carried for each man in the company transports. Bayonets are always fixed. The weight of arms and equipments is 68 lbs., including three days' provisions. The infantryman has also a short sword. The uniform is gray; small shako hat; belts and straps white in the guard, except rifle companies; in the infantry of the line the belts are all black. The tactics are similar to those of the other great powers. The unit of administration in everything is the regiment. To make the infantry wholly independent of other arms, 10 men of each regiment are annually attached to the artillery, so there are always 80 men with eight years' service to help that arm in case of need. Eight men of each company carry intrenching tools, and are instructed in throwing up temporary works. There are schools in which the non-commissioned officers of the regiment are carefully trained, and they in turn teach the men. The standard is very high, and after their term of enlistment has expired they frequently decline commissions which they might obtain by passing a sufficiently high examination, and become schoolmasters and sometimes professors. The men receive but one new uniform a year. The companies make their own clothing entirely, even to the spinning of the braid. Army transportation is regimental; every company has a provision wagon with six days' rations, and a wagon with 40 rounds of ammunition to each man, with three horses driven abreast. Each regiment has an orderly wagon with lithographing press, &c., four ambulances, one hospital car, and one medicine cart; each brigade one band wagon, none in time of war. In some regiments the senior surgeon gives occasional lectures to the officers and men on the first steps to be taken when wounded in case skilled assistance is not at hand. Thus the regiment is an administrative unit, independent of extraneous aid. The private soldier is intelligent, though generally uneducated; but under the new system there will be a continual improvement.—*Austro-Hungarian Monarchy.* Military service is obligatory upon all citizens of Austro-Hungary, as in most other European nations. There are 36 divisions of infantry, each consisting of two brigades. Each regiment comprises in time of peace five battalions of four companies, with the skeleton of a supplementary battalion; in time of war, three battalions of four companies, two reserve battalions of four companies, and one supplementary battalion of five companies. The regiment of Tyrolese chascours has seven battalions of four companies, seven supplementary companies of reserve, and one supplementary battalion of seven companies in time of war. Each battalion of chascours has four companies, one company in reserve, and one supplementary company. The numbers in 1873 were as follows:

AUSTRIAN INFANTRY.

REGT.	PEACE FOOTING.		WAR FOOTING.	
	Regt.	Men.	Regt.	Men.
Line.....	400	144,830	480	485,440
Chasseurs..	40	21,451	41	58,758
.....		8,315		14,315
Austrian...	56	2,947	111	183,974
Hungarian..	56	9,344	126	150,290
.....	612	190,277	738	849,609

lions is commanded by a major or colonel; its strength on a peace 14 officers and 372 men. A company has 3 officers and 95 non-commissioned men. On a war footing a battalion has 734 men—a company has 4 and 236 non-commissioned officers and men, and 3 bearers of wounded. The infantry is to be armed with the Werndl, of which 400,000 had been issued in the proportion of artillery to the infantry guns to 1,000 men. The uniform is white; it is now bluish gray, of untanned leather; close-fitting aloons, terminating in a boot. The army is undergoing a partial change, and made to conform with some modifications of the German method.—The infantry her powers of Europe is all modelled less upon the systems already described. The French army is undergoing a reorganization. The defeat of the army in the war of 1870 was due rather to bad tactics, faulty administration, and lack of discipline, than to any specific defect in the organization. In France military service is obligatory on every man except under certain definitions. The system of education is complete as in Germany. The English army is kept up by a system of volunteer recruits, but there is a militia liable to service in case of war, in which all subjects from 18 to 45 of age are enrolled. The regular army in Great Britain numbers about 60,000; in India about 45,958 men; in the colonies 18,000 men. The term of service is 2 years. They are armed with the Martini breech-loading rifle. The infantry of the smaller states, in organization, tactics, &c., resembles that of the great powers. Of course it partakes of the characteristics of the different nations, and is efficient in proportion to the intelligence and discipline of the individual soldier. (See ARMY.)—Mounted infantry was largely employed during the war of the United States, and rendered valuable service. Under the command of General Sherman, it reached a degree of efficiency never before known; it possessed all the qualities of cavalry with the steadiness and mobility of the best light infantry. It marched abreast with cavalry, but fought habitually in a single line of skirmishers, with more or less space between the files as

the circumstances of the ground and position of the enemy required. The successful use of mounted infantry gave rise to a necessity for the assimilation of the cavalry and infantry tactics, so that the commands, instruction, and manœuvres might be as much alike as possible. The new tactics prepared under the direction of Gen. Upton have just been issued to the army (1874), and seem to fully embody all that is required for handling large masses of cavalry or mounted infantry. In future wars the armies should have a much larger number of such troops, in order to secure the mobility or marching power of the horses, combined with the fighting power of the best infantry. That nation which first appreciates and applies this lesson on a large scale may confidently count upon results in actual warfare quite in proportion to the expense of the undertaking. (See CAVALRY.)

**INFANT SCHOOLS.** Pestalozzi was the first teacher of modern times who systematized infant instruction, and in the early part of the present century his system, improved and developed by later writers, reached its culminating point. Infant schools were established throughout Great Britain and the continent of Europe, and in every considerable town in the United States; but it was found after a few years' experience that these schools were doing more injury than good, and they have been generally abandoned. In 1837 an eminent German educator, Friedrich Froebel, introduced a new method of infant training, which is producing better results, and which obviates the difficulties and evils of the Pestalozzian system. He gave it the name of the *Kindergarten* (children's garden). This consists of a series of large, well ventilated, well lighted, and pleasant rooms, opening upon a garden, in which, besides the play ground for all, and a large garden plot, there are small plots for each child old enough to cultivate them. In the large garden are flowers, useful vegetables, and trees, and birds are encouraged to make it a home. The children may be from the age of two months to 14 years. They pass from three to five hours a day at the gardens. The infants are accompanied by their mothers or nurses, or, in default of these, are placed in charge of the teachers, young well educated women who enter into the work from a sincere love for it and for children. Froebel was very particular in the selection of teachers, deeming it indispensable to the success of the institution. Not more than 25 children should be under the care of a single teacher, and the elder children are of great assistance in carrying out the system. No corporal punishment is allowed; exclusion from a game, or from the gardens for a day or more, is the only punishment found necessary. Froebel devised many games and exercises for his course of instruction, and, as a part of the necessary apparatus, prepared his six gifts, which are used in all the kindergartens. In the use of each of these an explanatory song,

sung at first by the teacher, and afterward by the children, accompanies each exercise or game. The first gift consists of six soft balls of different colors, and a string; the colors are red, blue, and yellow—green, violet, and orange. They are moved horizontally, vertically, and in circles before the infant, by the teacher or an older child, who sings the song explaining the motions. By these balls the child obtains ideas of form, color, size, and movement, as well as of his own individuality. The second gift is a cube, a cylinder, a wooden ball, a stick, and a string; these are rolled, whirled, dragged, and used in a great variety of ways, and from them the child acquires ideas of form, size, sound, movement, and of development according to a fixed law. The third gift is a cube cut into eight equal cubes; these the child arranges into other forms, and receives new lessons in the law of development, gets a notion of angles, cubes, the laws of construction, and the division of units into halves, quarters, and eighths. He should always be taught to construct from the centre. The fourth gift is a cube divided into eight equal planes. In the use of this the children unite around a table, and construct together their buildings and other objects. By means of this and the preceding gifts, the alphabet and the elementary principles of arithmetic and geometry may be taught. The fifth gift is an extension of the third; the cube is divided into 27 small cubes, and three of these are divided diagonally into halves and three into quarters. This introduces the triangle, and gives scope for the construction of the arch and other architectural objects, and for practical perspective. The sixth gift is an extension of the fourth, the cube being divided into 27 planes, of which six are again divided, three in height and three in breadth; in the use of these the children are taught to build from the teacher's dictation. A seventh gift is added, containing all the forms of the last four. To these gifts are subsequently joined movable lines or plaiting sticks, which are also used for construction, being united when necessary by softened peas, pasteboard, and tissue paper, to be combined into figures and objects, and soft clay for modelling, in which many of the children become very expert. Drawing in the net, that is, on a slate furrowed into squares, and subsequently on paper ruled with a pale ink in squares, and painting in the net, are also introduced. The gymnastic exercises are still plays, of which there are a great variety, intended to develop all the muscles; these, too, are all accompanied by songs explanatory and instructive. For older pupils Froebel established scholars' gardens, in which workshops took the place of the games. During Froebel's life (he died in 1852) more than 50 kindergartens were established in Germany, Belgium, and Switzerland. Prussia, Saxony, and several of the minor states in Germany prohibited in 1851 the establishment of infant schools accord-

ing to Froebel's system, on the supposition that it inculcated socialism and atheism. But as it very soon became evident that kindergartens, according to Froebel's original principles, though apt to be misused for party purposes, could not really injure the state, the prohibitions were recalled, and the system was rapidly introduced everywhere. Though strenuous efforts were made in several states for the establishment of such institutions in connection with the public schools, no government has as yet acceded to the demand, and the benefits of the kindergartens continue to be restricted to those classes which are able to pay for them. There are in Germany several institutions for the education of teachers for these schools, and several periodicals are devoted to a further development of Froebel's ideas. The *Kindergarten und Elementarklasse*, published in Weimar since 1861, and the *Kindergarten*, published in Berlin since 1866, enjoy great favor. The system has been introduced into the United States, and there are several such schools in New York, Boston, Philadelphia, and elsewhere, especially in the western cities with a large German population.—See "Moral Culture of Infancy, and Kindergarten Guide," by Miss Elizabeth P. Peabody (revised ed., New York, 1869), and "The Kindergarten in Public Schools," by Adolf Douai (New York, 1870).

**INFLAMMATION**, a process which occurs in the progress of many diseases, and which is also produced by wounds and the presence of foreign bodies acting as irritants. There has always been considerable controversy as to the nature of inflammation, some regarding it strictly as a morbid process, although often accompanying restoration or healing, while others contend that it is essentially a natural and healing effort, the morbid conditions which may accompany it not being a part of the true inflammation, but the cause of it; in other words, that it is an attendant on that vital force which has so long been known under the name of *vis medicatrix nature*, being a conservative process employed by the nervous force which has been excited to action by a hurtful presence. Others again look upon the results of the process as determining whether it is morbid or healthful. Hippocrates regarded inflammation, like many of the symptoms of disease, as a condition instituted by nature, or the *élan*, the essence or productive power of nature, for the purpose of restoration, and his practice was based upon this theory. Stahl, the elaborator of the phlogiston theory in chemistry, imagined an agent analogous to Hippocrates's *élan* dwelling in the human body, which he called *anima*, possessing a species of intelligence by which it could institute processes for the expulsion of hurtful intruders. Van Helmont had a similar theory, to which he added the necessity of two circumstances for the development of inflammation: the action of stimulants on parts having sensibility, and an increased activity of the arterial system, followed by redness, heat, swell-

ing, and pain in the parts. He compared the activity of the stimulus to that of a thorn, which gave alarm to the *archæus*, who immediately caused an increased flow of blood to set up a defence and a reparative process. Boerhaave attributed the swelling and obstruction to a change in the texture of the blood, which he maintained grew thicker and more viscid during inflammation, acquiring what he called a state of *lentor*. He supposed also that the increased action of the arteries forced larger particles of the blood into vessels too small to transmit them, constituting what was termed an *error loci*. Cullen, in place of the doctrine of *error loci*, proposed that of spasm and contraction of the capillary vessels, and taught that the system at the time possessed a peculiar condition, which he called *diathesis phlogistica*, consisting in an increased tone or contractility of the muscular fibres of the whole arterial system. Vacca, an Italian, about the middle of the 18th century, proposed a theory which was advocated by Mr. Allen of Edinburgh, and which contained an opposite idea, viz., that there was a want of tone or loss of power from which there arose a stagnation of the blood and a dilatation of the vessels of the part. John Hunter taught that the blood had a vitality of its own, and to support his doctrine cited the property of spontaneous coagulation. He says: "There is a circumstance attending accidental injury which does not belong to disease, viz., that the injury done has in all cases a tendency to produce both the disposition and the means of cure."—The general process of acute inflammation may be described as follows: If a translucent vascular membrane, as the web of a frog's foot, is sufficiently irritated by scratching it or pricking with a hot needle, there may be observed with the microscope a contraction of the capillary vessels, followed very soon by a dilatation. It is maintained by some that during the contraction the circulation is increased in rapidity, and that it is diminished during dilatation; while others maintain that the contrary action takes place in both cases, that is, that the circulation is slower in the first stage and faster in the second. This difference of opinion has arisen from not making the observations under precisely the same circumstances. When a capillary is enlarged throughout its whole length, the circulation will be for a short time more rapid than natural; and when it is constricted for a considerable distance, it will be slower; but if it be contracted in some places and dilated in others, the blood will move slower in the dilated places and faster in the contracted ones, as might naturally be expected from a consideration of ordinary hydraulic principles. After a time, however, the circulation in the dilated vessels becomes slower, and at the same time oscillating, and at last ceases, the vessel becoming distended with colored corpuscles. There is then an exudation of liquor sanguinis through the walls of the vessels, and occasionally, in

consequence of their rupture, extravasation of blood corpuscles takes place. The oscillation of the blood, which immediately precedes stagnation, has by some been attributed to arterial contraction and dilatation, while others have referred it to a rhythmical contraction and dilatation in the veins, which has been observed by Wharton Jones. In the natural circulation the colored corpuscles roll forward in the centre of the vessel, the space between them and the cell wall being occupied by the liquor sanguinis and a few lymph corpuscles. In young frogs the lymph corpuscles are numerous, and under irritation are said to increase and in that way impede the circulation; but in old frogs the same changes occur without the presence of lymph corpuscles. When stagnation or "stasis" takes place, it constitutes what is called the stage of congestion. If the morbid process continues the vessels may burst, or the liquor sanguinis may transude through the walls, without rupture, into the surrounding tissue. This constitutes exudation. The contraction of the capillaries in the first stage and their dilatation in the second are accounted for by supposing them to have the power possessed by involuntary muscular fibres, and John Hunter supposed that they possessed muscular power. It is known that they have permanent cell nuclei, similar to those of the involuntary muscular fibres of the intestines. Mr. Lister has found that fusiform cells, capable of contraction, are placed transversely around the vessels, which explains the fact that, like intestinal muscular fibres, they may be excited to contraction by mental emotions or by local applications. The recent observations by Claude Bernard and others of the effects produced by dividing the large sympathetic nerve trunk of the neck are cited by Dr. John Hughes Bennet as confirming the theory. It has been found that when innervation from whatever cause has taken place in a part, it is more prone to pass into the condition of inflammation. In regard to the four cardinal symptoms, as they have been termed, of heat, redness, swelling, and pain (the *rubor, calor, cum tumore et dolore* of Celsus), which were always enumerated by the older writers as constant, it has been found that some of the most fatal cases of inflammation are attended by only one or two of them, and in some cases not one of them has been present. The latent pneumonia of old people is thus graphically described by Dr. Bennet: "An old man may suddenly lose his appetite and strength; his respiration becomes hurried and feeble; his chest on examination is dull on percussion; mucous rattles are heard by the ear, and he dies. On opening his body gray hepatization has attacked the lungs, which are infiltrated with pus. He has from first to last had no pain; there has been no heat; on the contrary, the temperature was diminished; no redness nor swelling is anywhere detectable. Not only, therefore, are the cardinal symptoms

not characteristic of inflammation, but the idea that such is the case has led to the most mischievous results in practice." He maintains that irritation of texture, contraction or dilatation of the blood vessels, capillary hæmorrhage, serous effusion which constitutes dropsy, and stoppage of the sanguineous circulation, are only accompaniments of inflammation; and that its essential condition is exudation of liquor sanguinis. Dr. Alison observes that a precise notion of inflammation is obtained by including with the four cardinal symptoms a tendency to effusion of new products capable of assuming the form of coagulated lymph or purulent matter; but Dr. Bennet maintains that the tendency cannot be separated from the act itself, and that it is only when the exudation has taken place that there is proof that the tendency existed. The objection to this view is that inflammation may take place in non-vascular parts; to which Dr. Bennet replies that the changes which occur in these parts when irritated are widely different from those in vascular parts, and should not be confounded; and moreover, that what has been called parenchymatous inflammation is not true inflammation, which term should only be applied to that perverted action of the vascular tissues which produces an exudation of the liquor sanguinis, and that other results of irritation are simply congestion, or increased growth or hypertrophy. As to the terminations of inflammation, Dr. Bennet divides them into two, depending upon whether the exudation lives or dies. If it continues to live, it constitutes a molecular blastema, in which new growths, temporary or permanent, spring up according to the molecular law of development, such as pus and adhesive lymph. When, on the other hand, the exudation dies, three things may follow: 1, rapid death, with chemical decomposition, producing mortification or moist gangrene; 2, slow death, with disintegration of the tissues, causing ulceration; 3, what may be called a natural death, in which the exudation is broken down, liquefied, and absorbed, or in other words, resolution. When the exudation lives, it undergoes vital transformations which are greatly influenced by the condition of the system, whether it is healthy or diseased. In the healthy condition, when the exudation takes place on serous membranes, like the pleura, it has a strong tendency to form fibrous tissue; when it occurs on mucous membranes, or in areolar tissue, it is generally converted into pus corpuscles; when it occurs in dense parenchymatous organs, such as the brain, it has a granular development; and when it is poured out after wounds or injuries, the superficial portion is transformed into pus corpuscles, while the deeper seated is converted by means of nuclei and cells into nucleated and cell fibres, which ultimately form the cicatrix. The microscopic examination of a recent exudation of liquor sanguinis will reveal the appearance of bundles of minute filaments min-

gled with corpuscles. The filaments are formed by a simple precipitation of the molecules, like those which are developed in the buffy coat of the blood, and are from  $\frac{1}{1000}$  to  $\frac{1}{500}$  of an inch in diameter. Bundles of them cross each other, and in time assume the appearance of dense fibrous tissue. The corpuscles at first are transparent, but soon become distinct, and are seen to be composed of a cell wall enclosing from three to eight granules. They vary in size from  $\frac{1}{1000}$  to  $\frac{1}{500}$ , and the granules from  $\frac{1}{1000}$  to  $\frac{1}{500}$  of an inch in diameter, and are termed by Dr. Bennet plastic corpuscles. They are not pus, although Lebert called them pyoid, and it is generally believed that they are an intermediate or arrested stage of the degeneration of plastic lymph from its fibrillated development to pus. These plastic corpuscles after a time mostly disappear, some remaining in the form of permanent nuclei. After a time the surface of the exudation becomes villous, and loops of blood vessels penetrate the villi, by which the serum separating the surfaces is absorbed, so that they come together and unite, forming dense adhesions, which are often found in post-mortem examinations after inflammations of serous membranes. When the exudation takes place upon a mucous membrane, it may have the form of a fibrous mass, as in croup or diphtheria, but more often that of an opaque creamy fluid called pus. When it is poured into the meshes of the areolar tissue, or into the substance of the brain, it forms abscess. Pus corpuscles are of a globular form and yellowish color, varying from  $\frac{1}{1000}$  to  $\frac{1}{500}$  of an inch in diameter. They are composed of a cell wall containing from two to five granules, which are about  $\frac{1}{1000}$  of an inch in diameter. When a microscopic examination is made of a recently formed granulation on a healing wound, there will be observed around the looped extremities of the capillary vessels fibrous tissue in the process of formation containing plastic corpuscles, while pus corpuscles will be found developed on the surface. As the fibrous tissue becomes more dense the pus diminishes, and at last ceases, the fibrous tissue attaining a certain growth, and after a time contracting and forming a cicatrix. All pathologists agree very nearly as to the changes which are here described, but many, among them Virchow, Billroth, Simon, and Sir James Paget, believe that inflammation is not restricted to one act; that congestion and determination of blood may be considered its first stages; and that it may exist and pass away without exudation. They ask, if inflammation is produced by irritation, when this is in process of operation, where shall the dividing line be placed between the departure from health and the commencement of inflammation? It is also objected that the web of a frog's foot, as being a part of a cold-blooded animal, is not a proper subject for the experiment, and accordingly a bat's wing has been substituted. Sir James Paget

that in warm-blooded animals stagnation will be found in only the most severely affected parts, while in the others retardation exists. The difference of appearance of red corpuscles in natural human blood that drawn during inflammation is worthy notice. In healthy blood they have a tendency to run together in rows like a pile of chips tipped over, while in blood drawn during inflammation there is a tendency to run together in masses, leaving larger spaces of liquor viscosus between them. According to pressure, the effect of inflammation in recent wounds is not to promote direct healing, but to prevent it. When a fresh wound in a young person is closed and the blood forced out between the cut surfaces, the severed arteries unite directly, without, it is maintained, the exudation of plastic lymph; but if the edges of the wound are allowed to gape, an inflammatory action takes place, plastic lymph is forced out, and granulation follows in the manner above described.—The conservative treatment of inflammation may be observed in the case of punctured or gun-shot wounds of the cavities of the body. When a puncture is made into the abdomen, the great result lies in the development of extending inflammation of the peritoneal membrane, and greatly increased if any of the contents of the intestines are poured into the space between its surfaces. The irritation produced by injury excites adhesive inflammation between the different layers which compose the walls of the abdomen, and thus a simple abscess is established between the exterior and interior, which in course of time may heal by absorption and suppuration. Severe cases of inflammation, as that which supervenes upon a compound fracture, are attended with marked characteristic symptoms. There is a feeling of chill and of alternate heat and chilliness; the nose and mouth are dry; the pulse becomes rapid and the patient restless; the urine becomes scanty and more highly colored than natural, and great thirst is experienced; the tongue is dry and coated with a whitish fur; the bowels are absent or greatly disturbed, and a degree of delirium comes on, more especially at night. There is usually constipation, but when the bowels act, which generally requires medicine, the excretions are very offensive; there is swelling and tenseness of the tissues of the affected part, which when it subsides is attended with a remission of the constitutional symptoms. The skin and mouth become moist; the patient and restlessness pass gradually away, and the patient sinks into a slumber.—The varieties of inflammation are various, and may be divided into two classes, predisposing and exciting. The predisposing causes embrace constitutional and hereditary tendency, food, season of the year, and habit of body. The exciting causes are poisonous substances, including the poisons of different diseases; irritants, such as cantharides, pepper, mustard;

caustic escharotics, strong acids, very hot and cold bodies, wounds, and also exposure of the person to wet and cold, or to sudden changes of temperature. Excessive mental excitation is a cause of inflammation of the brain. Inflammation may be acute or chronic. That which has been described is acute. After a subsidence of the intensity, if the action continues, in consequence of any source of irritation remaining, or from a want of tone of the parts, it becomes chronic, and from the latter cause the symptoms sometimes assume the chronic form from the outset. Inflammation is said to be healthy or unhealthy. If restoration takes place during the process, it is said to be healthy; but if there is wasting or destruction of tissue, as in ulceration or mortification, it is said to be unhealthy. It may also be common or specific; the latter term being employed to denote that which is caused by certain contagious poisons, such as smallpox, gonorrhoea, and erysipelas. It is sometimes called after the tissue in which it occurs, as mucous or serous inflammation. Inflammation of particular organs is usually designated by adding the termination *itis* to the anatomical name of the part affected, as laryngitis for inflammation of the larynx, gastritis for inflammation of the stomach, cerebritis for inflammation of the brain; but the old nomenclature is often retained, as pneumonia for pneumonitis, quinzy for tonsillitis. No nomenclature, however, is better than the employment of the word inflammation, together with the name of the organ or part inflamed. Inflammation is most likely to attack children under ten years of age, nearly one half of the mortality of the race occurring during these years. Inflammations of the pleura, brain, liver, and membranes of the heart are more frequent after the age of manhood. Spring is more favorable than any other season to the development of inflammation, and moist weather than dry, as is exemplified by the great rarity of inflammatory diseases in the regions bordering on the Pacific coast. The color acquired by an inflamed part differs with the degree of inflammation and the organ affected. The tendons and ligaments are seldom reddened. The fibrous membranes, like the pericardium, the dura mater, and the sclerotic coat of the eye, acquire a lilac or purple hue inclining to blue. The mucous membrane of the intestines first presents a bright red, but during the progress of the disease becomes a dark violet or a black, especially when passing into gangrene. These changes may be seen in the mucous membrane of the throat in an attack of malignant scarlet fever. In inflammation of the pleura and peritoneum (serous membrane) the color commences with a lilac, which afterward passes to scarlet, brownish, or violet. In the arachnoid, the serous membrane of the brain, the discoloration is slight, the chief sign of the inflammation being the serous effusion. The salivary glands assume a pink color, the kid-



neys a deep violet, and the lungs vary from a light rose to a deep purple. The alterations in color are owing in a great degree to the carbonization of the blood which is caused by stagnation and want of aëration. The continuance of inflammation in an organ prevents nourishment, and consequently after the swelling subsides it will be smaller. The wasting of the system during fever is an analogous example.—*Treatment.* This is divided into local and general. The local treatment of an inflamed wound consists in reducing the temperature by the application of cold or cool affusions, depending on the intensity of the action. Cold water may be allowed to drip from a vessel properly arranged and suspended above the wounded part, which is covered with a layer of linen; or cloths may be moistened with cool water and laid upon the wound; care in either case being taken to preserve an even temperature, and not by an intermission of the application to allow reaction to take place. The general treatment consists in a plain diet, principally of liquid food, which however should contain enough nourishment to support the strength of the patient; and he should be allowed to partake freely of water and cooling drinks, although at times warm drinks of weak tea may be allowed. To relieve constipation laxatives may be given. In inflammation of membranes and organs accompanying diseases such as pneumonia and like various forms of fever, contagious or not, there is almost always a want of saline constituents of the blood, the result of waste, and this condition may often be remedied by the administration of saline medicines, such as the bicarbonates of soda and potash. In fevers generally the parched condition of the mouth and throat and dryness of the skin are caused by a want of secretion of the mucous follicles and sudoriparous glands of the skin; and these alkaline salts in conjunction with the free administration of water are well calculated to restore a healthy action. Local bleeding by cupping and leeching may often be resorted to with benefit; but general bleeding, which was formerly practised to a great extent, is now almost wholly abandoned.

**INFLUENZA.** See BRONCHITIS, vol. iii., p. 312.

**INFORMATION,** in law, a written charge or accusation made against an alleged offender, stating some violation of law, before a court of competent jurisdiction to try the same. This process has taken the place of the ancient writ of *quo warranto*, and it is common to speak of it as an "information in the nature of a *quo warranto*." It is in substance, and to some extent in form, an indictment; but an indictment can be found only by a grand jury, whereas an information is filed by an attorney of the state or United States, or other competent law officer, at his own discretion. Informations are sometimes filed for public purposes; but more often, in the United States, by some private prosecutor, who uses the name of the

attorney general to ascertain his rights, or obtain redress for some wrong. Although criminal in form, they are in their nature civil proceedings. When moved by a private person for his own purposes, he is called "a relator," and the case is entitled "Information of A. B. attorney general, *ex relations* of C. D. against E. F." But no such use of an information was known to the common law, as it springs altogether from statute provision; first, from the statute 9 Anne, ch. 20, and afterward by various state statutes in this country, and by adjudication founded upon the statute of Anne, in states in which there is no statute provision respecting it. The general purpose of informations is to inquire into alleged usurpations of, or intrusion into, or unlawful claim or exercise of official or corporate powers or franchises. Thus, they are often brought against banks, alleging that they unlawfully exercise banking privileges, when the real question is not whether they possess these powers or privileges, because they have been expressly conferred by the legislature, but whether they have not forfeited their charters by misconduct. So an information may issue against a medical school, to try its right of granting the degree of doctor of medicine with a corresponding diploma; or against the mayor of a city, to determine whether he has the right to admit freemen. The most important question is, how far informations will be granted to try questions which may be considered as of private right rather than public right. The court of king's bench refused to grant one against Sir William Lowther, to try the question whether he had the right to set up a warren, because it was of a private nature; and this principle has been applied with some severity in England. Here, however, informations are used very freely, to determine questions relating exclusively to private corporations, as banks, insurance companies, &c.; but in such cases the leave of the court to file the same is usually required. In general the court will not grant this leave where an adequate remedy at law is open to the relator; as where one sought an information against a turnpike corporation for going unlawfully through his land. The court will sometimes hear and decide the whole case on motion and argument; but if there be any question of fact, they will usually send the case to a jury. In general they will refuse an information, or determine otherwise against the relator, where there has been long and negligent delay, or persons from whom title is derived are dead, or persons having adverse title or interest have long acquiesced in the alleged usurpation. By statute in many of the United States an information is now substituted for an indictment; and where it is made use of, the rules governing indictments are applicable.

**INFUSORIA,** the name formerly given to numberless kinds of microscopic animalcules, the most minute of created beings, so called from

being especially abundant in water in- with vegetable matter. From their ex- ag the simplest forms of animal life, they grouped together under the division pro- but such a division, supposed to differ all other animals in producing no eggs, not exist in nature. Many are ascertained locomotive algae or seaweeds; others are alous mollusks, embryonic worms, or cea; they form favorite test objects for scopes, and have been carefully studied by Ehrenberg, and others. The majority e classed among worms near the turbel- or flat worms; they propagate by eggs, or transverse fission, and some present phenomena of alternate generation. (See ALGULES.)

**INGBERT**, or *Sanct-Ingbert*, a town of Ger- in Rhenish Bavaria, near the Prussian ; on the Roorbach, 10 m. W. of Zwei- en; pop. in 1871, 8,433. It is renowned coal and iron works.

**INGLOW, Jean**, an English poetess, born in n, Lincolnshire, in 1830. Her father was ker, and a man of superior intellectual e; her mother is of Scotch descent. As l Jean was exceedingly shy and reserved, e led a quiet, uneventful life till Novem- 363, when the publication of her "Po- secured her immediate recognition as a s of high rank. Several of the poems s volume, especially "Divided," "High on the Coast of Lincolnshire," and the rs of Seven," have become widely popu- id the last named (consisting of seven r representing seven epochs in the life man) has been published separately and ated. Her subsequent publications are: lies for Stories" (1864); "Poor Matt" ; "Stories Told to a Child" (1866; 2d 1872); "A Story of Doom, and other s" (1867); "A Sister's Bye-Hours" ; "Mopsa the Fairy" (1869); "The ions of the Unseen, and Poems of Love hildhood" (1870, published only in Bos- lass.); and "Off the Skelligs," a novel . In America her poems have reached a n 1874) of 98,000 copies, and her prose of 35,000. Miss Ingelow now resides in n. Three times a week she gives what lls a "copyright dinner" to 12 needy is just discharged from hospitals.

**INGMANN, Bernhard Severin**, a Danish poet, t *Torkildstrup*, on the island of Falster, 28, 1789, died in Copenhagen, Feb. 24,

He was the son of a clergyman, and ill at the university when he published a e of poetry in 1811. After his return his travels in Europe he became connect- 1822 with the academy of Sorø, of which s a director from 1843 till its suspension 19. His most celebrated works are his *Waldemar de Store* and *Holger Danske*, tional anthem *Danebrøeg*, and his sacred

Many of his picturesque novels in re- to mediæval Denmark have been trans-

lated into English and other foreign languages. His complete works include dramatic poems (6 vols., 1848), historical poems and novels (12 vols., 1847-'51), tales and stories (12 vols., 1847-'56), and ballads, songs, and fables (9 vols., 1845-'64). His autobiography, edited by Galskjøet, appeared in 1862.

**INGENHOESZ, Johannes**, a Dutch physician, born in Breda in 1780, died at Bowood, Eng- land, Sept. 7, 1799. In 1767 he went to Lon- don to learn the new mode of inoculation, and in the following year was sent to Vienna to inoculate the children of the imperial family, for which he was rewarded with the titles of aulic councillor and imperial physician, and a pension for life of £600. In 1776 he returned to England. Most of his essays were published in the "Philosophical Transactions."

**INGERMANNLAND**, or *Ingria*. See **INGRIANS**.  
**INGERSOLL**, a town of Oxford co., Ontario, Canada, on the Thames river and the Great Western railway, 85 m. W. S. W. of Toronto; pop. in 1871, 4,022. It has a large export trade in lumber and agricultural produce, and contains several grist and saw mills, manufac- tories of iron castings, machinery, woollens, wooden ware, cheese, &c., two branch banks, several hotels, two weekly newspapers, and churches of seven denominations.

**INGERSOLL, I. Jared**, an American lawyer, born in Connecticut in 1749, died in Philadel- phia, Oct. 21, 1822. His father was appointed stampmaster general for New England in 1765, but was soon forced to resign, and in 1770 was appointed admiralty judge for Pennsylvania, and removed to Philadelphia. Jared graduated at Yale college in 1766, studied law for five years in London, spent a year and a half in Paris, and then returning to Philadelphia be- came almost immediately prominent in his pro- fession. In 1787 he was one of the repre- sentatives of Pennsylvania in the convention which framed the constitution of the United States. He twice held the office of attorney general for the state, and was afterward United States district attorney for Pennsylvania. In 1812 he was the federal candidate for vice president of the United States. At the time of his death he was president judge of the district court of Philadelphia county. **II. Charles Jared**, an American statesman, son of the preceding, born in Philadelphia, Oct. 3, 1782, died there, Jan. 14, 1862. He studied law, became an attaché of Rufus King, minister to France, and travelled in Europe. On his return he pub- lished "*Chiomara*," a poem (1800), "*Edwy and Elgiva*," a tragedy (1801), and "*Inchiquin the Jesuit's Letters*," a political satire (1810). In 1813 he was elected to congress from Phila- delphia, from 1815 to 1829 was United States district attorney, in 1837 was a member of the Pennsylvania constitutional convention, and served again in congress from 1841 to 1847, distinguishing himself as a democratic leader. He then received from President Polk the nomination of minister to France, but the sen-

ate refused to confirm it. His other chief works are "Julian," a dramatic poem (1831), and "Historical Sketch of the Second War between the United States and Great Britain" (4 vols. 8vo. 1845-'52). III. **Joseph Reed**, an American statesman and lawyer, brother of the preceding, born in Philadelphia June 14, 1756, died there, Feb. 29, 1868. He graduated at Princeton college in 1784, studied law, and entered upon its practice in Philadelphia. In 1835-'7 he was a member of congress, but declined a reelection till 1841, when he was returned as a whig and protectionist, and held the office for four terms. From 1850 to 1853 he was minister to England. He was an able public speaker, and published several speeches and pamphlets, the principal one being "Secession a Folly and a Crime."

**INGHAM**, a S. county of the S. peninsula of Michigan, drained by the head waters of Grand river and by several smaller streams; area, 560 sq. m.; pop. in 1870, 25,298. It has a nearly level surface, timbered with sugar maple, beech, &c., and a fertile soil. Coal and iron ore have been found in the county. The Grand River Valley and the Jackson, Lansing, and Saginaw divisions of the Michigan Central railroad, the Lansing division of the Michigan Southern, the Detroit, Lansing, and Lake Michigan, and the Peninsular railroads traverse it. The chief productions in 1870 were 471,382 bushels of wheat, 382,164 of Indian corn, 233,594 of oats, 240,324 of potatoes, 281,562 lbs. of wool, 779,496 of butter, and 36,606 tons of hay. There were 5,954 horses, 6,535 milch cows, 1,200 working oxen, 8,138 other cattle, 62,407 sheep, and 11,491 swine; 24 manufactories of carriages, 4 of brick, 7 of clothing, 4 of cooperage, 12 of furniture, 6 of iron castings, 4 of machinery, 10 of saddlery and harness, 3 of sash, doors, and blinds, 6 of tin, copper, and sheet-iron ware, 1 of washing machines, &c., 1 of woollen goods, 3 planing mills, 28 saw mills, 4 breweries, 3 tanneries, 3 currying establishments, and 6 flour mills. Capital, Mason.

**INGHAM**, **Charles C.** an American painter, born in Dublin in 1797, died in New York, Dec. 10, 1863. He studied at the academy of Dublin, and obtained a prize for his "Death of Cleopatra." He settled in New York in 1817, and was one of the founders of the national academy of design, and its vice president from 1845 to 1850. Among his works, besides many female portraits, are "The Laughing Girl," "White Plume," "The Flower Girl," and "Day Dream."

**INGHIRAMI**, **Tommaso**, surnamed FEDRA, an Italian scholar, born in Volterra, Tuscany, in 1470, died in Rome, Sept. 6, 1516. He went to Rome when 13 years old. While he was acting the part of Phœdra in Seneca's "Hippolytus," some of the machinery broke down, and he entertained the audience till the injury was repaired by the recitation of extempore Latin poetry. The multitude at once saluted him with the title of Fedra, and Alexander VI.

made him a canon of St. Peter's. In 1495 he accompanied the papal nuncio to the court of the emperor Maximilian, who created him count palatine and poet laureate. Julius II. appointed him librarian of the Vatican, and pontifical secretary. His works include a "Defence of Cicero," "Compendium of Roman History," and "Commentary on Horace."

**INGLEBY**, **Clement Mansfield**, an English author, born at Edgbaston, near Birmingham, Oct. 29, 1823. He graduated at Trinity college, Cambridge, in 1847, and was professor of logic and metaphysics at the Midland institute of Birmingham from 1855 to 1858, when he received the degree of LL. D. In 1870 he became foreign secretary to the royal society of literature. His principal works are: "Outlines of Theoretical Knowledge" (1856); "The Shakspeare Fabrications" (1859); "A Complete View of the Shakspeare Controversy" (1861); "The Still Lion" (1867); "An Introduction to Metaphysics" (1869); and "The Revival of Philosophy at Cambridge" (1870).

**INGOLSTADT**, a fortified town of Upper Bavaria, on the left bank of the Danube, at the confluence of the Schutter, 85 m. S. W. of Ratisbon, and the principal place between that city and Ulm; pop. in 1871, 13,164. It has one Protestant and several Catholic churches, two convents, a Latin and an industrial school, an ancient castle, a military hospital, and several breweries. The defences of the town were demolished by the French after a three months' siege in 1800, but were restored from 1827 to 1847 with all modern improvements of fortification. Its Roman Catholic university, founded in 1472, and long famous, was transferred in 1800 to Landshut. The first Jesuit college established in Germany was founded at Ingolstadt in 1555. In 1632 the town sustained a siege by Gustavus Adolphus.

**INGRAHAM**, **Duncan Nathaniel**, an American naval officer, born in Charleston, S. C., Dec. 6, 1802, died there, June 10, 1863. He entered the navy as midshipman in January, 1812, and became a captain Sept. 14, 1855. While in command of the sloop of war St. Louis in the Mediterranean, in July, 1853, he interfered at Smyrna with the detention by the Austrian consul of Martin Koszta, a Hungarian, who had declared in New York his intention of becoming an American citizen. This affair was elaborately discussed at Washington, between M. Hulsemann, the chargé d'affaires of Austria, and Mr. Marcy, secretary of state. The conduct of Capt. Ingraham was fully approved by the government, and congress by joint resolution, Aug. 4, 1854, requested the president to present him with a medal. In March, 1854, he was appointed chief of the bureau of ordnance and hydrography of the navy department. He resigned this post Feb. 4, 1861, and was made chief of ordnance, construction, and repair in the confederate army.

**INGRAHAM**, **Joseph H.**, an American author, born in Portland, Me., in 1809, died in 1864.

After a brief experience of trade he became a teacher near Natchez, and in 1836 published "The South-West, by a Yankee." Subsequently he produced in rapid succession "Laitte," "Burton, or the Sieges," "Captain Kyd," "The Dancing Feather," and other romances, some of which attained a large circulation. He finally became a minister of the Protestant Episcopal church, and was rector of a parish and of an academy for boys in Holly Springs, Miss. His last works were: "The Prince of the House of David" (1855), "The Pillar of Fire" (1859), and "The Throne of David."

**INGRES, Jean Dominique Auguste**, a French historical painter, born in Montauban, Sept. 15, 1781, died in Paris, Jan. 14, 1867. In the school of David he made such rapid progress that by the age of 20 he had gained in two successive years the first and second prizes of the academy of fine arts. After 1806 he passed nearly 20 years in Italy, abandoning the dry, classic style he had acquired from David. In 1829 he became director of the French academy in Rome. He was made a senator in 1862, and a member of the council of public instruction. His works are numerous, and comprise generally serious historical and classical subjects; in the great exhibition of 1855 at Paris an entire room was appropriated to them. His best known pictures are "Edipus and the Sphinx," "Jupiter and Thetis," "A Woman in the Bath," "Ossian's Sleep," and "The Vow of Louis XIII." Many are in the Louvre, on the ceiling of one of the apartments of which is painted his "Apotheosis of Homer." His "Stratonicce," painted for the duke of Orleans, was sold in 1853 for 40,000 francs. Among his latest works was the "Apotheosis of Napoleon..." painted on the ceiling of the *hôtel de ville* in Paris. He painted the portraits of many distinguished personages, including Napoleon I.

**INGRIANS**, a tribe in the Russian government of St. Petersburg, belonging to the Tchudic branch of the Finns, now reduced to about 8,000, in 200 small and wretched villages. The Ingrians are poor and ignorant, but begin to assimilate more with the Russians; and many have forsaken the Protestant religion, which is that of the majority, for the Greek church. The Ingrians derive their name from the river Inger or Izhora. The strip of land between the Neva, the lake of Ladoga, the gulf of Finland, the Narva, and the governments of Pskov and Novgorod, was called Ingermannland or Ingria by the Swedes, who obtained possession of it at the beginning of the 17th century. Reconquered by Peter the Great in 1702, it has formed since 1783 the bulk of the government of St. Petersburg.

**INGULPHUS**, an English monk, born in London about 1030, died at the monastery of Croyland, Dec. 17, 1109. He was educated at Oxford, and attracted the attention of Editha, queen of Edward the Confessor, who became his patroness, and introduced him to William, duke of Normandy, who made the young Saxon

his secretary. He resigned that office in 1064; accompanied Sigfried, duke of Mentz, to the Holy Land, and became a monk in the abbey of Fontenelle, in Normandy, whence in 1076 he was invited to England by William, and appointed abbot of Croyland. The *Historia Monasterii Croylandensis*, from 664 to 1089, was long regarded as the work of Ingulphus, but Sir Francis Palgrave has proved it to be of a later age.

**INHAMBAN**, a town of East Africa, belonging to Portugal, near the mouth of the Inhamban river, N. of Cape Corrientes and 200 m. N. E. of Delagoa bay; pop. about 10,000. It has a harbor, and trades in beeswax and ivory.

**INJUNCTION**, a prohibitory writ. Courts of equity grant relief by injunction in those cases in which, but for their interposition, an equitable right would be infringed. In such cases courts of law can afford no remedy, for they cannot adjudicate upon an equity, and are powerless to prevent an invasion of it. Where then the rights of a party are wholly equitable in their nature, he can find no redress in the common law tribunals; but the mere existence of an equitable element in a suit being regarded by these courts as no bar to their procedure, they take jurisdiction, and, in deciding upon the legal merits of the case, must sometimes disregard the equity, because its recognition does not lie within their competence as courts of law. In such cases as these a court of equity, in the exercise of its distinctive jurisdiction, will interpose by injunction to protect the equity. This protection consists in restraining in behalf of the plaintiff the commission or continuance of some act of the defendant. An injunction is defined to be a writ, framed according to the circumstances of the case, commanding an act which the court regards as essential to justice, or restraining an act which it esteems contrary to equity and good conscience. As examples of those cases where relief is afforded to rights which either are wholly equitable, or under the circumstances of the case are incapable of being asserted in courts of law, may be cited instances in which trustees are enjoined from using their legal title to oust the possession of those who are equitably entitled to the benefit and enjoyment of the trust estate; so tenants for life or mortgagees in possession, who are not punishable at law for committing waste, will be enjoined in equity from doing so; and again, mortgagees in possession, though in some sense owners of the mortgaged estate, will yet be restrained by injunction from so reducing its value as to impair the security of the mortgagee. The administration and marshalling of assets, and the marshalling of securities, furnish other illustrations of the interposition of courts of equity by injunction to control the proceedings of creditors and others at law, and upon principles almost purely of an equitable nature.—A second class of cases includes those in which an equitable element is involved, but the matter of

which otherwise is cognizable at law. If in such cases the courts of law have already taken jurisdiction, a court of equity will in a proper case restrain their further procedure. Thus, when fraud, accident, or mistake has given one party to the suit an unfair advantage over his opponent, an equity arises in favor of the latter which will be protected by injunction. For example, if after judgment against the defendant at law a receipt is found, showing the payment of the very debt upon which he has been condemned, if there be no remedy in such a case at law, equity will enjoin, and so prevent, the execution of the judgment. Equity will also sometimes relieve against torts. The ground of interference here is, that between the complete right of the plaintiff and the largest remedy which he can receive at law for the wrong done him, there lies an equity which is not protected; this may rest either in the inadequacy of the money compensation which the plaintiff recovers, or in his right to be exempted from vexatious litigation. The equity jurisdiction in these cases is most frequently exercised in respect to waste, nuisances, and infringements of patent rights and of copyrights. The remedies at law in all these cases are similar. To cite alone that of nuisances, they can at most only abate or afford compensation for existing nuisances, but are ineffectual to prevent such as are threatened or in progress; if, however, the complainant's right be clearly admitted or established at law, and the nature of the threatened injury be such that it cannot be compensated by damages, or will occasion a constantly recurring grievance, equity has jurisdiction to enjoin. Farther, as examples of the equitable relief afforded by injunction, it may be mentioned that courts of equity will restrain the unjust conveyance of real property or the transfer of stocks during the pendency of suits which concern them; they will forbid the publication of private papers, letters, or manuscripts; they will enjoin a husband's transfer of property in fraud of the legal or equitable rights of the wife; and will compel the due observance of personal covenants where there is no effectual remedy at law.—In the cases thus reviewed, the court of equity issues the injunction by its remedial writ. The judicial writ is in the nature of an execution, and issues subsequently to a decree of the court. Injunctions may be either temporary, when they are granted for a limited time, or until the filing of the defendant's answer, or the hearing of the court; or perpetual, when in the opinion of the court, after a hearing of the merits of the case, the plaintiff has established his right to such relief.

**INK**, the name given to a variety of preparations designed for producing colored letters in writing or printing. The ink of the ancients appears to have been similar to the solid Chinese or India ink—a combination of lampblack with glue or gum, in the proportions, as given by Dioscorides, of three parts of the former to one of the latter. The liquor of the cuttle fish

is also said by Cicero and Pliny to have been in use for ink. These preparations were used in a fluid state, by means of a style with a split point. Manuscripts written from the 5th to the 12th century are generally very legible, while those of the 15th and 16th centuries are made out with difficulty in consequence of the discoloration of the ink. This is owing in the one case to the permanent quality of the ancient inks, which were of the nature of a black paint, and also to the use of parchment and of a porous paper of cotton rags which absorbed the ink; and in the other to the closer quality of the linen paper of the later period, and the changeable nature of the ink, which was in fact a dye prepared from nutgalls and sulphate of iron. Paper bleached with excess of chlorine would cause this kind of ink to be discolored. The decay of the vegetable portion of the ink would cause the color to fade, and ancient writings thus rendered illegible have been restored by careful application of an infusion of galls. In an essay on the "Origin and Progress of Printing," privately printed by the Philobiblon society in England, 1859, it is said: "The ink of the ancients, and that used in the middle ages, had a consistency much thicker than that at present in use; very highly gummed when applied to papyrus, parchment, or paper, it formed letters in relief, as if they were embossed, which has given rise to an erroneous conjecture that these writings were produced by a sort of typographic process. Black ink was in general used for manuscripts and characters. The basis of all the black inks was carbon in various forms, as lampblack. Red ink was generally employed for writing initials and the titles of books and chapters; hence the term rubrics, from *rubrica*, red. At Orleans there is a charter of Philip I., dated 1090, written in green ink. The emperors signed in purple ink obtained from the *murex*; gold and silver inks were chiefly employed on colored parchments or purple vellum. The celebrated codex of Upsal is written with silver ink upon violet parchment, the initials and some passages being in gold."—Though the same materials were used for several centuries that are now employed for the best inks, little was known of the real nature of the compounds produced until the researches of Dr. Lewis and of Ribaucourt toward the close of the last century; the latter published an interesting paper containing an account of his observations in the *Annales de chimie* of 1798. The inks from that time were improved; but the recipes have until recently been objectionable from the introduction of unnecessary ingredients, and particularly from the necessity of employing much gum to prevent the coloring matter from subsiding; this renders the ink thick and indisposed to flow freely from the pen, and also liable to become mouldy. The requisites of a good writing ink are permanency of character, close adherence to the paper, a good color, no tendency to mould, and a proper consistency.

A combination of nutgalls with sulphate of iron was long the only suitable black solution known. The galls contain four vegetable substances, viz., gallic and tannic acids, mucilage, and extractive matter. The acids are regarded as more particularly necessary to a good ink, forming with the oxide of iron of the copperas a tanno-gallate of iron. Of the three causes of the deterioration of ink—mouldiness, the separation of the black coloring matter, and the change of color—Dr. Bostock, in an able paper in the "Transactions of the Society of Arts" for 1830, attributes the first to the mucilage, the second to the extractive matter, and the third to the tannin, which is disposed to decompose and thus involve the destruction of the compound of which it is an ingredient. The more nearly the ink approaches the composition of a gallate of iron, the more permanent he regards it. Several of the recipes require long exposure of the decoction of galls to the air, after this is obtained by boiling in water, the effect of which is to convert much of the tannin into gallic acid. Dr. Bostock recommends that the galls should be macerated for some hours in hot water, and the fluid filtered; the filtrate should then be exposed for two weeks to a warm atmosphere, when any fungoid growth that forms must be removed; and the infusion being made stronger than usually directed, no addition of mucilaginous substance will be required to give it a proper consistency. The solution of sulphate of iron should also be boiled or exposed some time to the air, which causes a portion of sesquioxide of iron to be formed, the presence of which is advantageous. The recipes for this class of ink alone are very numerous. That of Booth for a fine black ink is: Aleppo galls 12 lbs., sulphate of iron 4 lbs., gum arabic 3½ lbs., water 18 gallons; the bruised galls to be exhausted by three successive boilings, each time with a reduced quantity of water; the decoction is strained, and while warm the solution of gum and copperas, also warm, is to be added, and the mixture is left for several weeks to deposit its sediment. A few drops of creosote added will prevent mouldiness.—Among the other kinds of ink, the following appear particularly worthy of notice. The blue ink first introduced by Mr. Henry Stephens of London, remarkable for a blue color which soon after drying changes to deep black, for perfect fluidity, and tenacious adherence to the paper, is a tanno-gallate of iron dissolved in sulphate of indigo, the coloring matter thus not being suspended as in the ordinary inks, but in complete solution. Another variety, also invented by Mr. Stephens, and remarkable for its tendency to fade by continued exposure to light, and to recover its hue when excluded from it, is made by submitting Prussian blue for two days or longer to the action of strong nitric or hydrochloric acid, then washing it well with water till all acid is removed, and finally dissolving it in oxalic acid. Hornung's recipe is to mix 4

parts of solution of perchloride of iron with 750 parts of water, and precipitate with 4 parts of cyanide of potassium in solution; the precipitate collected is washed with several additions of water, and allowed to drain until it weighs about 200 parts; it is then dissolved in one part of oxalic acid. Runge's ink, remarkable for its clearness and fitness for steel pens, which it does not corrode, is a cheap composition prepared by gradually adding one part of solution of chromate of potash to 1,000 parts of a strong cold decoction of logwood, 22 lbs. of logwood being boiled down with water to 14 gallons. The ink thus made is very black, and is not affected by weak acids, nor can it be washed out with water. It is, however, liable to become viscid and gelatinous. Dr. Normandy's indelible writing ink, which is remarkably permanent, is made by grinding 24 lbs. of Frankfort black with mucilage obtained by adding 20 lbs. of gum to 60 gallons of water, straining through a coarse flannel, then adding 4 lbs. of oxalic acid, and as much decoction of cochineal and sulphate of indigo as will give the required shade. Berzelius invented an ink which he regarded as the best writing ink known, and also nearly indelible; it is vanadic acid combined with ammonia and mixed with infusion of galls.—Copying inks, which are intended to give an impression of the writing made with them to a second or a third sheet moistened and pressed upon the original, are the ferro-gallic inks with a larger proportion of gum than they usually contain, and a portion besides of sugar or of sugar candy.—Red ink may be made by the recipe of Heusler, which is to boil 2 oz. of Brazil wood, ¼ oz. alum, and the same of crystals of tartar, in 16 oz. of pure water, till the water is reduced one half; in the strained liquor ½ oz. of gum arabic is to be dissolved, and a tincture added made by digesting 1½ dram of cochineal in 1½ oz. of alcohol of specific gravity 0.830. Booth employs Brazil wood 2 oz., chloride of tin ½ dram, gum arabic 1 dram, water 32 oz., and boils the whole down to 16 oz. Various recipes may be found for different colored inks, but there is little use for them. They are generally composed of coloring matter held in suspension by thickening the liquid with gum arabic. The nature of the Chinese or India ink has been already noticed. Proust says that lampblack purified by potash lye and mixed with a solution of refined glue, moulded and dried, makes a quality of this ink preferred by artists even to that of China. Until some recent discoveries it was supposed that this ink used with acidulated water was inattacked by chemical reagents that were not destructive to the paper.—The so-called indelible or marking inks were formerly altogether made by dissolving nitrate of silver in water and adding gum arabic and sap green, and were used in connection with a pounce, which was first applied to the linen on the spot to be marked. The pounce was an aque-

ous solution of carbonate of soda to which gum arabic was added. The best marking inks are now made by combining the two preparations at once, and bringing out the color after the application to the cloth by exposure to heat. A good ink is made by dissolving 7 parts of carbonate of soda in 12 of water, and adding 5 parts of gum arabic, then mixing with this 5 parts of nitrate of silver liquefied in 10 of ammonia; the mixture is to be gradually heated to ebullition in a flask, when it becomes very dark and of the proper consistence. Tartaric acid is sometimes advantageously employed to produce tartrate of silver, as by the following process: nitrate of silver is triturated in a mortar with an equivalent of desiccated tartaric acid; water added causes crystals of tartrate of silver to separate with liberation of nitric acid; this is neutralized by careful addition of ammonia, which also dissolves the tartrate of silver; the preparation is then thickened with gum, and coloring matter is added at pleasure. The Italian marking ink is terchloride of gold applied to cloth moistened with solution of chloride of tin. The subject of indelible inks will be further treated under NITRATES.—Sympathetic inks are preparations which when used for writing leave no visible, or at least only colorless, marks upon the paper. These are afterward brought out in colors by exposure to heat or to moisture, or by application of other substances. By the ancients it was known that new milk or the milky sap of plants might be so used, the writing with it being made visible by dusting over it a black powder. The property of writing made with the solution of acetate of lead to turn black by application of gaseous or liquid sulphuretted hydrogen was known in the 17th century, and ascribed to magnetic influences. The action was afterward styled sympathetic, and the name has continued to be applied to the various preparations of this nature. The materials of the common ferro-gallic inks may be used separately for a sympathetic ink, the writing being done with the sulphate of iron solution and washed over with that of the galls, as the writing of some old manuscripts is now occasionally restored. A dilute solution of chloride of copper used for writing is invisible until the paper is heated, when the letters are seen of a beautiful yellow, disappearing with the heat that developed them. The salts of cobalt, as the acetate, sulphate, nitrate, and chloride, possess a similar property, the letters appearing blue. The addition of a salt of nickel renders them green. The magic or chemical landscapes are made by the use of these metallic salts. The sky being painted with salt of cobalt alone, and foliage with the same mixed with nickel, the application of heat brings them out in their appropriate colors. A winter landscape, with the bare trees and ground covered with snow, may thus by accession of warmth be clothed with the green hues of summer.—Lithographers employ an ink for

tracing designs on paper, which are to be transferred to stone, composed of shell lac 1½ oz., soap 2 oz., white wax 8 oz., tallow 1 oz., a strong solution of gum sandarach 3 table-spoons, and lampblack; also an ink for taking impressions from engraved plates, which are to be transferred to stone, composed of tallow, wax, and soap, each 4 oz., shell lac 3 oz., gum mastic 2½ oz., black pitch 1½ oz., and lampblack.—Printing ink is a preparation very different from any of the inks used for other purposes; and its manufacture demands no little skill and experience. It should be of a soft adhesive character, readily attaching itself to the surface of the types, and as easily transferred to the paper pressed upon them, conveying in a clear tint the exact stamp. Thus spread in a thin film and pressed into the paper, it should quickly dry, and at the same time be so incorporated with the paper as not to be removable by mechanical means, while its composition insures for it durability and a power to resist the action of chemical agents as well as atmospheric influences. While disposed to dry readily on being applied to paper, it should retain its softness in the mass and while excluded from the air, and in this condition undergo no change. Its ingredients must not be of a corrosive nature to injure the rollers employed in spreading it. The appearance of good ink is glossy and somewhat oily; its texture smooth without grains; and its tenacity such as to cause it to adhere to the finger pressed against it, and yet leave but a short thread suspended from a portion taken out. The usual materials employed in its manufacture are linseed oil, rosin, and coloring matters. Rosin oil is largely used for some of the cheaper inks. For the best inks the linseed oil is selected of the purest quality, and this is clarified by digesting it for some hours with dilute sulphuric acid at a temperature of 212°, and then washing it with hot water; it will then dry much more quickly. The oil is then boiled, and the inflammable vapors that rise are ignited, and when they have burned a few minutes a cover is placed over the vessel, extinguishing the flame. The boiling is not stopped until a drop taken out and placed on a cold surface is covered with a film as it cools. A portion of rosin is then dissolved in the oil, the quantity depending on the degree of stiffness the ink may require; that for books and strong stiff paper bearing more rosin, and receiving in consequence more gloss, than the ink for newspapers. The degree of viscosity given to the oil should also have reference to the use required of the ink. For letterpress printing soap should be added to the materials to enable the ink to be taken up clearly from the types without smearing. The best kind is yellow rosin soap, cut up into slices, dried, reduced to powder, and incorporated with the oil and rosin, or varnish, and before mixing placed again over the fire to expel any remaining moisture. Lampblack is almost universally

as the coloring matter; and much given in the manufacture of this art-stain it of the very best quality. Oth-naceous blacks reduced to impalpable are sometimes employed. For colored ous pigments are introduced instead. ture is made with the hot compound t oil and rosin in a cylindrical vessel, b a revolving shaft with arms serves as : From this the ink is drawn off, and ground in a mill until the ingredients roughly incorporated. Various recipes found in Ure's "Dictionary" and Mus-'Chemistry" for printing inks of oth-rials than the above. For ancient pro-ee the work of Caneparius, *De Atra-ujuscumque Generis* (Rotterdam, 1718). **INKBERRY**, the popular name of *Ilex glabra*, now placed in the same genus with the ut formerly known as *prinos glaber*. nder and rather graceful, usually 2 to 4



Inkberry (*Ilex glabra*).

but sometimes much taller; its lanceo-oblond leaves, sparingly toothed toward t, are an inch or more long, evergreen, ; shining on the upper surface, and of ark green color; the small flowers are , and the solitary fertile ones produce lack berries. It is found in sandy along the coast from New England to . It is deemed efficacious in intermit-ers, but its chief use is for decoration. ate brilliant green leaves, upon slender stems, especially fit it for working in wers in bouquets. Quantities of it are m the southern counties of New Jersey ew York florists, who keep it in good on in a cool cellar for several months.

**INKMAN**, a Russian village in the south of nea, on the site of a ruined city, sup- to be the Ctenos mentioned by Strabo, head of the harbor of Sebastopol, and . S. W. of Simferopol. It stands at the

foot of a hill rising several hundred feet per-pendicularly above the valley of the Tchernaya, crowned by massive walls and remains of towers. The side of the hill is pierced by num-erous artificial caves, hewn from the solid rock, resembling the ruins found in Idumæa,



Monument at Inkerman.

but unlike any others in Europe. Near by is a church similarly constructed. The caves were probably made by the persecuted Arians, and were afterward occupied by Christian cenobites, as is shown by the paintings, chapels, and remains of altars found in them. On the heights of Inkerman, on the side of the valley opposite to the ruins, the Russians were de-feated, Nov. 5, 1854, by the French and Eng-lish. A monument to the memory of the fall-en has been erected on the battle field.

**INKMAN, Henry**, an American painter, born in Utica, N. Y., Oct. 20, 1801, died in New York, Jan. 17, 1846. He was preparing to enter the West Point academy when his taste for art led him to become a pupil of Jarvis the portrait painter, to whom he was apprenticed for seven years. Among his most characteristic por-traits are those of Chief Justice Marshall, Bish-op White, and Jacob Barker. He also painted landscape, *genre*, and history. In 1844 infirm health led him to visit England, where he was the guest of Wordsworth, whose portrait he painted, as well as those of Dr. Chalmers, Lord Chancellor Cottenham, and Macaulay. On his return to New York in 1845 he began a series of historical paintings for the national capitol. He was engaged upon one represent-ing the cabin of Daniel Boone in the wilds of Kentucky at the time of his death.

**INN** (anc. *Enna*), a river of central Europe, one of the principal tributaries of the Danube. It rises in the Swiss canton of Grisons out of the small lake of Longhino, W. of Mount Ber-nina, at an elevation of nearly 7,000 ft. It crosses the Grisons frontier above the gorge of Finstermünz, enters Tyrol by a narrow valley,



and runs with great impetuosity through the northern district, particularly the Upper and Lower Inn valleys, to the border of S. E. Bavaria, which it crosses a few miles N. of the fortress of Kufstein. After a course N. and then E. for about 90 m. through Bavaria, it reaches Braunau on the Austrian frontier, whence it flows in a N. direction, forming the boundary between Bavaria and Austria, until it joins the Danube at Passau, after an entire course of 315 m. Navigation begins at Innsbruck, and becomes considerable below Hall. Steamboats ply on the Inn, and on its largest tributary the Salzach. The beautiful valley of the Engadine, which is situated near the sources and extends along the banks of the Inn, is also called the valley of the Upper Inn, where in the Romansh language, which is spoken by the inhabitants, the name of the river is On.

**INN**, according to judicial decision, "a house where the traveller is furnished with everything which he has occasion for while on his way." It is sometimes important to determine whether a house be an inn and the master an innkeeper, because of the legal rights, on the one hand, and on the other the peculiar and stringent liabilities, of an innkeeper. It is clear that while a sign is the usual and proper evidence that a house is an inn, it is neither essential to an inn nor the only evidence of it. A mere coffee house, or an eating room, is not an inn. Neither is a boarding house; but the distinction between a boarding house and an inn is not always easy, in fact or in law; and it is the more difficult, because the same house may be an inn as to some persons within it, and a boarding house as to others. The best test of this question we apprehend to be the transientness or the fixedness of the alleged guest. The old law constantly held that an inn is for the benefit *transientium*. By this is not meant that a guest of an inn loses his rights, or that the innkeeper loses his rights over him, if the guest remains a long time in the inn, provided he remains there as in an inn; and he does so, if he makes no contract, and comes under no obligation, to stay a moment longer than he chooses to. If he goes to an inn, occupies his room, and takes his meals, with the right at any moment of going away, and of paying for what he has had up to that moment, and nothing more, he continues to be a guest although he remain there a year or years. But if, upon going there, or at any time afterward, he makes a bargain by force of which he must stay at least so long, whether it be a week or a month, he is no longer a "transient person," and loses the peculiar character of a guest at an inn.

**INNESS, George**, an American landscape painter, born in Newburgh, N. Y., May 1, 1825. His parents removed to Newark, N. J., where he early learned drawing and the rudiments of oil painting. He has from his youth been subject to epilepsy, which has interfered materially with the consecutive pursuit of his art. When 16 years old he went to New York to study

engraving, but ill health obliged him to return home, where he continued to sketch and paint until his 20th year. He then passed a month in the studio of Regis Gignoux in New York, which is all the regular instruction he ever had. He made two visits to Europe, and resided for some time in Italy. For a number of years after his return he made his home near Boston, where some of his best pictures were painted. In 1862 he went to reside at Eagleswood, near Perth Amboy, N. J., and a few years later removed to New York. Inness is very unequal in his efforts, but lovers of nature find much to admire in his landscapes. He inclines to the French school in style, and has been compared not inaptly with Rousseau. A follower of Swedenborg, he deals largely in allegory, and uses the forms of nature to illustrate thought. Among his best pictures are "The Sign of Promise," "Peace and Plenty," "Going out of the Woods," "A Vision of Faith," "The Valley of the Shadow of Death," "The Apocalyptic Vision of the New Jerusalem and River of Life," "A Passing Storm," "Summer Afternoon," "Twilight," and "Light Triumphant." In 1870 he went with his family to Rome, where he still remains. To the national academy exhibition of 1874 he sent a picture entitled "Washing Day, near Perugia."

**INNKEEPER**. Public policy imposes upon an innkeeper a heavy responsibility. (See **BANMENT**.) He is liable as an insurer of the property of his guests within his charge, against everything but the act of God or the public enemy, or the negligence or fraud of the owner of the property. He would therefore be liable for a loss caused by his own servants, by other guests, by robbery within or from without the house, burglary, riots, or mobs; for a mob is not a public enemy in this sense. It is however a good defence to the innkeeper, that his guest's loss was caused by the guest's servant or company, or by his negligence of any kind; or that the property was never in charge of the innkeeper because the guest had retained it in his own possession and under his own control. This last defence, however, is not made out by merely showing that the guest received and accepted a key of the room or of a closet, or that he exercised some preference and gave some directions as to where the property should be placed. But still an innkeeper may protect himself by requiring reasonable precautions from the guest. Thus, if he appoint a certain place of deposit for certain goods, as a safe for money or jewelry, with notice to his guests that he will not be responsible for their property of this kind if not put there, and a guest disregard this, the innkeeper is exonerated. But no especial delivery of the goods to the innkeeper is necessary to charge him, if they are in his custody in the usual manner. It is also held that he cannot refuse to receive a guest without good cause, as that his house is full, or that the guest is disorderly, or has infectious disease, or disreputable habits

ance. On the other hand, a guest is to select and insist upon a participant, or put it to other purposes than which it was designed.—An innkeeper is liable like any other person for injury caused by his own default or negligence; and so a boarding-house keeper is liable to this extent. But an innkeeper is liable for the loss of or injury to property of a guest without the innkeeper's own default or negligence.

So, if he receive the horse and carriage, and put them under an open shed on his premises, or leave them on a public road, because he is crowded, and cannot find room to put them there when crowded, he is liable for them as insurer. On the other hand, and perhaps as some compensation for the stringent liabilities, an innkeeper has the goods of his guest, for his charges as a guest; and he even has this lien for the horse or carriage, or other property stolen from him by the thief. He has no lien for the person of the guest; and certainly not for the clothing actually at the time on the guest. But the innkeeper's lien probably extends to other property of the guest, and as far as to cover the whole amount of the charges of the guest, for himself, his servants, or his family. But where a person visits an inn for a short time, as a friend, or by general invitation as one of many, or as one of the guests on a certain day, without paying or promising to pay anything, it has been held that the innkeeper is liable to the visitor for losses or injuries caused by the innkeeper's default or neglect.

**VI.** the name of 13 popes, of whom Innocent III. is the most important. **I. Saint Innocent**, pope of the name of Albano, died March 12, or, according to some authorities, July 28, 417. He succeeded Anastasius on April 27, 402. On his accession he acted without avail in behalf of the excommunicated Chrysostom, and excommunicated the heretics of Alexandria and other persecuted saints. The Donatists having been condemned by the council of Carthage (405), Innocent condemned the emperor Honorius to enact laws against them. On the invasion of Alaric at the head of the Visigoths, Innocent fled from Rome to save Rome from these barbarians, and sought refuge at Ravenna to solicit the interference of the emperor; but during his absence the city was taken in August, 410, and plundered. On the departure of the Goths, Innocent returned to Rome and exerted himself to relieve the distressed metropolis. His zeal and charity towards the Romans, heathen as well as Christians. He condemned the doctrines of Pelagius, who was supported by some Christians in the East, and evinced great severity towards the Novatians, who were numerous. His feast is celebrated on July 28. His works are attributed to him have been collected in Labbe's *Concilia*, vol. ii.; and Genesius *De Scriptoribus Ecclesiasticis*, has as his title a *Decretum Occidentalium et*

*Orientalium Ecclesiis adversus Pelagianos datum*, which was published by his successor, Zosimus I. **II. Gregorio de' Papi**, or **Papareschi**, born in Rome about 1090, died there in September, 1143. He was first a monk and afterward abbot of the convent of St. Nicholas, was made cardinal by Urban II., and appointed in 1124 legate to France by Calixtus II. His virtues, eloquence, and sweetness of temper secured him the affections of his colleagues; and on the death of Honorius II., before the event could be generally known, he was somewhat hastily proclaimed pope by 17 cardinals; but some of them who were dissatisfied met in the evening of the same day and gave their vote in behalf of Pietro di Leone, who assumed the appellation of Anacletus II. Pietro was possessed of immense wealth, which he lavished to make himself popular among the Romans. He was soon acknowledged all over Italy, while Innocent was obliged to take refuge in France. In an assembly of bishops at Liège, March 29, 1131, at which Lothaire II. of Germany was present, he declined the offer made by the latter to restore his authority in Rome, on condition of the pope's granting himself and his successors the right of investiture. Returning to France, Innocent secured the cooperation of St. Bernard, who accompanied him to Italy. There he was joined by Lothaire at the head of an army, whose services were rewarded by the temporary cession to that monarch of the provinces formerly belonging to the countess Matilda. After holding a council at Piacenza, Innocent reentered Rome with Lothaire May 1, 1133, and crowned him emperor in the church of St. John Lateran. Anacletus, however, still held possession of the castle of Sant' Angelo and several fortresses; he was also supported by Roger, king of Sicily; and Innocent was again driven from Rome, to which he did not return until the death of his opponent in 1138. He had now to negotiate for the abdication of Victor IV., another antipope who had succeeded Anacletus, and to secure the submission of the rebellious cardinals. He was then enabled to hold the second general council of Lateran, which was opened April 8, 1139, and attended by more than 1,000 bishops. But he was attacked by King Roger, and being taken prisoner could regain his liberty only by confirming this prince in the possession of Sicily and the title of king, which had been bestowed upon him in 1130 by Anacletus. Yielding to the entreaties of St. Bernard, he condemned in 1140 the opinions of Abélard; but soon becoming embroiled in a quarrel with Louis VII. of France, he put his kingdom under an interdict. This difficulty was not yet settled when the Romans, discontented with some of the pope's measures, and excited by the preaching of Arnold of Brescia, rose in arms against Innocent, and reestablished the senate and the tribunes of ancient Rome. The pope died soon after. Forty-three letters of Innocent II. are printed in Labbe's *Concilia*,

vol. x. **III. Giovanni Lotario Conti**, born at Anagni about 1161, died in Perugia, July 16, 1216. Being from his childhood destined for the church, he was sent to Paris to study theology, and then to the university of Bologna, where he mastered the science of law. He returned to Rome in 1181, and in 1190 was made cardinal deacon by his uncle, Pope Clement III. Being coldly treated by Celestine III., Clement's successor, he retired to Anagni, where he composed his treatise *De Contemptu Mundi, sive de Miseriis Humanæ Conditionis*. On the day that Celestine died, Jan. 8, 1198, although but 37 years old, he was unanimously chosen his successor by the college of cardinals. He reluctantly accepted the tiara; but as soon as he was firmly seated on his throne, he showed himself a worthy successor of Gregory VII. Aiming to establish the supremacy of papal power, he soon made his influence felt in nearly every part of Christendom. His first care was to restore order in the administration of the city of Rome, by forcing into submission such civil officers as had hitherto sworn allegiance to the emperor; he then extended his authority over the cities of central Italy which had been usurped by vassals of the empire, and, while vindicating his political rights, appeared as the champion of justice, humanity, and morality. Philip Augustus of France having repudiated his wife Ingeburga of Denmark to marry Agnes of Meran, Innocent excommunicated him in 1199, and put his kingdom under an interdict. After resisting for eight months, the king yielded to the pontifical authority, dismissed his new queen, and took back the Danish princess. Innocent had previously been instrumental in bringing about a five years' truce between Philip Augustus and Richard I. of England. About the same time he was appointed guardian of young Frederick of Hohenstaufen, the son of the late emperor Henry VI., and of Constanza, queen of Naples and Sicily; but he refused Frederick the investiture of his kingdom of Sicily until he had set at liberty Queen Sibyl, her daughter, and her son William, who had been imprisoned by Henry VI. He was soon called to interfere in the political affairs of Germany. Philip of Swabia and Otho of Brunswick were now contending for the imperial crown. Innocent, after trying in vain to bring about a pacification between the rivals, took the part of the latter, who nevertheless was unable to stand his ground, and was obliged to take refuge in England. Meanwhile the pope had increased his power in Italy, and concluded with the cities of Lombardy an alliance against Philip of Swabia, by which he was enabled to reappear as a mediator; he proposed a compromise, leaving Philip in undisputed right to the imperial crown, and declaring Otho his successor. This agreement had scarcely been entered into when the emperor was murdered by one of his followers. Otho was immediately acknowledged by most of the German princes, and in

1209 proceeded to Rome, where he received the imperial crown at the hands of the pope. But the new emperor soon showed signs of determined hostility to the power of the pope, seized upon several cities of central Italy, and claimed Naples and Sicily as fiefs of the empire. Innocent at once excommunicated him, called for the assistance of France, and summoned the electors to choose another emperor. They deposed Otho in 1212, and elected Frederick, king of Naples and Sicily. Innocent acted also a conspicuous part in the events which marked the latter part of King John's reign in England. The election of Stephen Langton to the archbishopric of Canterbury, supported by the pope and opposed by the king, was the cause of a protracted dispute, in the course of which John, resorting to violent and even cruel measures, saw his kingdom placed under an interdict, and himself excommunicated, and finally deposed by the pope, Philip Augustus being directed to put the sentence into execution. John, frightened into submission, complied with the humiliating terms which were dictated to him by the pope's legate, and put his dominions under the protection of the Roman see (1218). Innocent immediately commanded the king of France to desist from the attack upon England, which belonged to the church; thenceforth taking up the cause of his vassal, he supported him in his contest against his revolted subjects and the attacks of Louis of France, the son of Philip Augustus, but could not prevent his being driven out of England. His zeal in maintaining the sanctity of marriage was also displayed in the case of Alfonso IX., king of Leon and Castile, who had taken to wife his own niece, a daughter of Sancho I. of Portugal. As both princes resisted the repeated remonstrances of the pope, he laid their kingdoms under an interdict and themselves under the ban of excommunication, until the scandal ceased. Afterward he united these sovereigns and the kings of Aragon and Navarre in a crusade against the Moors, which resulted in the victory of Navas de Tolosa, July 16, 1212. Pedro II. of Aragon was crowned in Rome by Innocent, to whom he did homage for his dominions; and the title of king was conferred on Leo of Armenia, Premias of Bohemia, and Joannicus prince of the Bulgarians. In Norway Sverrer the Great had baffled all the efforts made by the legates of Celestine III. to check his tyranny. Innocent, being appealed to by the king and his nobles, after hearing both parties, excommunicated Sverrer, and released his subjects from their allegiance. One of his first undertakings after his election had been to preach and organize the fourth crusade. Its failure arose from the violation of the oath imposed by him on its chiefs not to make war on any Christian power. He displayed the most uncompromising severity against heresy, the extirpation of which was with him a matter at once of duty and policy; this led him to sanction the crusade against

Ibigensea, which was carried on by his  
s and Simon de Montfort with such rigor  
uently as finally to draw his censure upon

After being for 18 years the ruling  
of his age, he was carried off by a vio-  
ver which terminated in paralysis. In-  
t's works (Cologne, 1552 and 1575; Ven-  
578) consist of theological discourses,  
ies, a commentary on the seven peniten-  
alsms, and a number of letters. His let-  
hich are the most important in a histor-  
int of view, were printed by Baluze in  
fol. (Paris, 1682), to which Bréguigny  
u Theil in 1791 added 2 vols. containing  
letters collected from the Vatican ar-

Innocent is the author of a celebrated  
*Veni Sancto Spiritus*. The *Stabat Ma-*  
hich is also attributed to him, is claimed  
work of a Franciscan. The German his-

F. Hurter has published a remarkable  
y of this pope: *Geschichte Papst Inno-*  
*II. und seiner Zeitgenossen* (4 vols. 8vo,  
urg and Gotha, 1834-'42). See also his  
y A. É. de Gasparin (Paris, 1873). IV.

at XI., *Benedetto Odiscalchi*, born in Como,  
16, 1611, died in Rome, Aug. 12, 1689.

ians have confounded him with a name-  
and relative, who was a soldier in his  
but embraced the ecclesiastical profes-

Benedetto was descended from a wealthy  
; began his studies in the Jesuit college  
no, and graduated in theology and canon  
Rome, where he received holy orders.

as made cardinal by Innocent X. His  
s and talents secured him general esteem;  
his accession to the papal throne, he ap-  
himself to revive the ancient discipline of  
urch. He attempted to curtail the right

lum, which, being possessed by foreign  
adors, had extended to the entire dis-  
where their residence was situated. His  
ntentions were partly baffled by the op-  
on of Marshal d'Estrées, the French am-  
or; but he was prudent enough to avoid

time an open rupture with Louis XIV.  
omineering spirit of the king soon gave  
a quarrel. In 1673 a decree of Louis

ad the *regale*, that is, the royal privilege  
eiving the revenues and granting at pleas-  
e benefices of vacant bishoprics, to be ex-  
d over the provinces of France in which

not yet been in existence; this was op-  
by the bishops of Alet and Panniers,  
the pope earnestly supported. The king

summoned a general assembly of the bish-  
f his kingdom, who not only supported  
olicy concerning the *regale*, but issued  
celebrated propositions of March, 1682,

ring the power of the pope inferior to  
f a general council, and maintaining the  
l rights and privileges of the Gallican  
h. In answer to this Innocent held a sol-  
consistory, severely censured the bishops

had taken part in the proceedings, which  
declared null and void, ordered the four  
ditions to be burned, and refused to grant

canonical confirmation to such bishops as had  
been newly appointed by the king. This con-  
test was embittered by the renewal of the quar-  
rel about the right of asylum. By a brief of

May 12, 1687, Innocent formally abolished that  
right, and excommunicated all who should  
maintain it. Louis XIV. at once gave orders

to his new ambassador, the marquis de Lavar-  
din, to uphold the disputed privilege, even by  
force; and the marquis accordingly made a  
solemn and threatening entrance into Rome at

the head of about 800 armed men. The pope,  
considering him excommunicated *de facto*, de-  
clined to receive him, and ordered worship to  
be discontinued wherever he should present

himself. The king, exasperated at the pope's  
firmness, caused his parliament and a number  
of French bishops to appeal to a general coun-  
cil against Innocent's measures, had his nuncio

arrested at Paris, and seized upon Avignon.  
The pope continued inflexible to the last. It  
was during his pontificate that Michael Mol-  
nos, a Spanish priest, advanced in his "Spirit-  
ual Guide" the mystical doctrine known as

quietism. The book was condemned by the in-  
quisition, Sept. 8, 1687; the author abjured his  
doctrine publicly; and the proceedings were  
approved by the pope. In 1688 he received an

embassy from the king of Siam, who had been  
converted by Jesuit missionaries. Some histo-  
rians have affirmed that the Jesuits accused  
Innocent XI. of Jansenism; this the Jesuits

deny, and there exists no evidence of the accu-  
sation. His repeated entreaties induced John  
Sobieski to relieve Vienna in September, 1683,

when besieged by the Turks; the pope and the  
cardinals contributing a subsidy of 400,000  
crowns for the expenses of the war.

**INNS OF COURT**, colleges in London, in which  
students of law reside and pursue their studies.  
In England at a very early date the science of

law was taught in the metropolis in certain  
buildings in the immediate vicinity of the courts  
of law which were called inns of court, inn

anciently signifying a mansion or place. The  
establishment of the court of common pleas at  
Westminster led to the gathering in its neighbor-  
hood of the whole body of "common" law-  
yers, and to the establishment in the metropo-  
lis of hostels or *hospitia curia*, which were

so called because they were attached to or de-  
pendent upon the court. These hostels were  
occupied by the lawyers as offices and some-  
times as dwellings, and contained also schools

where the law was studied. But in 1846 the  
knights hospitallers of St. John of Jerusalem,  
to whom the pope had granted the English

estates of the suppressed order of knights  
templars, leased the buildings and gardens of  
the templars in London to certain students of  
the common law, who established in them a

hostel or inn of court. The place continued  
to be called the Temple, from its former occu-  
pants. In the course of a few years the num-  
ber of inns increased to four, which still exist,  
viz.: the Inner Temple, the Middle Temple,

Lincoln's Inn, and Gray's Inn, each of which contained 200 members. Stow, in his "Survey of London" (1598), says of the lawyers who occupied these inns: "These societies are no corporations, nor have any judicial power over their members, but have certain orders among themselves which by consent have the force of laws. For slight offences they are only excommunicated, that is, put out of commons, which is, not to eat with the rest in their halls; and for greater, they lose their chambers, and are expelled the house; and being once expelled, they are not to be admitted by any of the other three societies. The gentlemen in these societies may be divided into four ranks: 1, benchers; 2, utter benchers; 3, inner barristers; 4, students." In course of time two bodies were formed, called the "Honorable Society of the Inner Temple" and the "Honorable Society of the Middle Temple," who held their buildings as tenants of the knights hospitallers until the suppression of monastic bodies by Henry VIII., after which they held them of the crown by lease. In 1608 the buildings of the two temples were granted by letters patent of James I. to the chancellor of the exchequer, the recorder of London, and the benchers and treasurers of the Inner and Middle Temples, for "lodging, reception, and education of the professors and students of the laws;" and it is by virtue of these grants that they are still held by an incorporated society of the "students and practicers of the laws of England." The Temple garden, which lies between Whitefriars and Essex street, has been celebrated by Charles Lamb and Leigh Hunt, and was much frequented as a pleasure walk during the 17th and 18th centuries. In the hall of the Inner Temple, a noble room ornamented with emblematical paintings by Sir James Thornhill, and by portraits of Littleton and Coke, dinner is prepared for the members of the inn every day during term time. Students of law must keep 12 terms, that is, five years, at the inns of court before they are entitled to be called to the bar, and those of the Inner Temple are required to dine in this hall at least four times in each term. On certain "grand days" the judges, the masters in chancery, and many of the leading lawyers of England dine here, together with a large assemblage of the students. Formerly the Inner Temple was celebrated for the magnificence of its entertainments and revels,

especially in the 16th and 17th centuries. The hall of the Middle Temple, the largest and finest of the old inns of court, was built in 1562-'72. It is ornamented by elaborate carvings, by portraits and busts, and by the coats of arms of Somers, Hardwicke, Cowper, Thur-



Middle Temple Hall.

low, Dunning, Eldon, Blackstone, Stowell, Tenterden, Curran, and many other eminent lawyers, formerly members of the society, emblazoned on its windows. Lincoln's Inn, the next in importance to the Inner and Middle Temples, is on the W. side of Chancery lane.



Inner Temple Hall and Library.

and derives its name from being on the site of the palace of an earl of Lincoln who died there in 1310, and by whom the land was assigned to certain professors of the law for the establishment of an inn of court. The hall and library, designed by Hardwick, and finished

in 1845, form one of the noblest piles of building in London. The chambers of this inn are chiefly occupied by chancery barristers, conveyancers, and persons in attendance on the court of chancery, which court is held in its hall. Attached to the inn are extensive gardens, celebrated in the "Tatler," No. 100. Gray's Inn, the fourth inn of court in importance and size, is named from the lords Gray of Wilton, whose residence it originally was. It is in Gray's Inn lane, and has a garden which appears to have been planted with elm trees in 1600 under the direction of Francis Bacon, at that time treasurer of the society. The hall is a very handsome room, built in 1560. Its windows are emblazoned with the armorial bearings of Lord Bacon, Sir Nicholas Bacon, Lord Burleigh, and other eminent members.—Each of the inns of court forms an independent society, but they all agree in the observance of certain common regulations. No person can keep a term in any of them without being in the hall on three days when the grace is said after dinner. None of the societies can call a gentleman to the bar before he has been five years a member of the society, unless he is a master of arts or a bachelor of laws of the university of Oxford, Cambridge, or Dublin. No person in trade or in deacon's orders, and no one who has held the situation of a conveyancer's clerk, can be admitted at all; and solicitors and attorneys must have their names struck off the rolls for two years, and the articles of clerks must be expired or cancelled two years, before they can be admitted. An applicant rejected by one society will not be admitted by any other. On his admission the student pays various fees amounting to £30 or £40, and enters into a bond of £100 for the payment of his commons or dinners while a student. On the expiration of his terms he addresses a petition to the benchers at a special council; and if they approve, he waits upon them after dinner, the oaths are administered, and he is called to the bar. The fees for admission vary in the different inns from £66 in Gray's Inn to £93 in Lincoln's Inn. There are different degrees among the

members of the inns. The sergeants are the highest degree at common law, as the doctors are in civil law. Queen's counsel is another rank, admission to which is technically called giving a silk gown, the costume of the bearers of this honor. The benchers of the inns are elected from the barristers at the bar according to seniority. They govern the society, and may reject an application for admission without assigning a reason.—The four great inns of court have attached to them inns of chancery, of which the Inner Temple has two, Clement's and Clifford's (formerly also Lyon's, now the Globe theatre); the Middle Temple one, New Inn; Lincoln's Inn one, Thavies's; and Gray's Inn two, Barnard's and Staples's. Two others, Furnival's and the Strand, no longer exist. These inns are principally inhabited by attorneys.

**INNSBRUCK** (Ger. *Innsbruck*), a city of Austria, capital of Tyrol, on both sides of the Inn, near its junction with the Sill, 245 m. W. S. W. of Vienna; pop. in 1869, 16,810. The name, meaning Inn bridge, is the equivalent of that given to the locality by the Romans, *Cenipontum*; there are now several bridges. The town is surrounded by steep mountains 6,000 to 9,000 ft. high, and is well built, especially



Innsbruck.

on the right bank of the Inn. The finest street is the Neustätterstrasse, in which are the buildings where the Tyrolese estates hold their sittings, the post office, and a triumphal arch

erected by Maria Theresa. The Franciscan church (*Hofkirche*) contains one of the most splendid monuments of Europe, that of Maximilian I. (who ordered its construction, with a sepulchre for his own remains, but is buried in Neustadt, near Vienna). On each side of the aisle stands a row of tall figures, 28 in number, representing principally the most distinguished members of the house of Austria. The sarcophagus is ornamented with 24 representations of the principal political and domestic events in the life of Maximilian, sculptured in alto rilievo by Alexander Colin of Mechlin. In the same church is the Silver Lady chapel, so called after a silver statue of the Virgin, containing the mauseleums of the archduke Ferdinand and of his wife Philippine, which are also attributed to the genius of Colin, whose own tomb, said to be the work of his own hands, is in the cemetery of Innsbruck. The tomb of Andreas Hofer is in this chapel. In this church Christina of Sweden made her public renunciation of Lutheranism. There are altogether 11 churches, among which are the Capuchin church with the penitential cell of Maximilian II., and the St. James church, noticeable for its rich decorations. Among the other public buildings are the palace built for Maria Theresa, with an equestrian statue of Archduke Leopold V. in the courtyard, and a large edifice in the city square (*Stadtplatz*), once the residence of the counts of Tyrol, now a private dwelling, with a famous oriel window, covered with a golden roof (*das goldene Dachl*), built in the 15th century, at a cost of 30,000 ducats. The chief educational establishment is the Roman Catholic university, which was founded in 1672 by the emperor Leopold I. In 1873 it had 46 professors and 663 students, fully one third of whom are under the theological faculty, the professors of which are Jesuits. In consequence of the remonstrance of the liberal party in Austria and of a majority of the professors of the university against the privileged position of the Jesuits, the minister of public instruction in July, 1872, deprived the theological faculty of the right of electing a member of the academic senate, and, alternately with the other faculties, the rector of the university. In 1873 the right was restored to the Jesuits, provided the professors should individually qualify for their office like the professors of the other faculties. The library of the university has about 50,000 volumes. There are also a gymnasium, a commercial school, and a national museum founded in 1823, with rich collections of antiquities and works of art. The principal manufactures of the town are silks, ribbons, gloves, calico, and glass.—In 1234 Innsbruck was clothed with the privileges of a town by Otho I., duke of Meran. It subsequently became the residence of the Austrian archdukes, and its most prosperous period was in the early part of the 17th century, when Ferdinand II. held his brilliant court there. It was taken by the Bavarians in 1703, but was soon

recovered by the Austrians. In 1809 it suffered much during the war in Tyrol. After the second revolutionary outbreak in Vienna in 1848, the emperor Ferdinand fled to Innsbruck, and resided there for several months.

**INO**, in Greek mythology, a daughter of Cadmus and Harmonia. By command of Juno, Athamas, king of Orchomenus, had married Nephele, by whom he was father of Phrixus and Helle; but he was also secretly wedded to Ino, by whom he had Learchus and Melicertes. Hating the children of her rival, Ino persuaded her husband that the gods were angry with him, and could only be appeased by the sacrifice of Phrixus and Helle. Nephele rescued the children, and Mercury punished Ino by giving her the young Bacchus to nurse, which brought down on her and her husband the anger of Juno. Athamas was driven mad, and in this state killed his son Learchus; while Ino, flying for safety with Melicertes in her arms, leaped into the sea. Neptune changed her into a sea goddess, giving her the name of Leucothea, while Melicertes became Palaemon. There are wide variations in the traditions concerning Ino. Æschylus, Sophocles, Euripides, and Æchæus have used her story in their tragedies.

**INOCULATION**, the transmission of a disease from one individual to another by means of a morbid matter taken from the body of the first and introduced into the system of the second. The morbid matter may be introduced directly into the tissues by means of an incision or puncture in the skin, or it may be applied in a fluid form to an abraded surface, from which it is absorbed by the skin itself. There are only certain diseases which are communicable in this way, the simple inflammations and their products not having the power to breed a similar malady in a healthy person. But there are particular specific diseases, such as smallpox, cowpox, primary syphilitic and gonorrhœal inflammations, and the like, the exudations of which are charged with a peculiar organic virus which when introduced into the system of another individual gives rise to a disorder like that by which it was originally produced. Vaccination is simply the inoculation of vaccina or cowpox; and the term inoculation is sometimes restricted in common parlance to the intentional communication, by this means, of smallpox in its original form. The inoculation of smallpox was early found to mitigate the severity of the disease; but vaccination was afterward substituted for it (see **JENNER**), because vaccina, though milder still, was discovered to be an effectual protection against smallpox itself.

**INOWRACLAW**, or *Jung-Breslau*, a town of Prussia, in the province of Posen, 24 m. S. E. of Bromberg; pop. in 1872, 7,429, including over 3,000 Jews. It contains a Roman Catholic and a Protestant church, a synagogue, and large saltpetre works. An extensive deposit of mineral salt was discovered there in 1571.

**INQUISITION**, or **Holy Office**, a tribunal established in various Roman Catholic countries to search out and to try persons accused of heresy, as well as certain other offences against morality or the canons of the church. The first formal sanction of the inquisition by a papal bull was in the 13th century; but long before that heresy had been declared a crime, and inquisitors, or inquirers after heretics, had been appointed by Christian princes. Constantine the Great, the first emperor who made Christianity a state religion, made heresy a state offence, and repeatedly banished those who refused submission to his decisions in doctrinal controversies. Athanasius, the defender of orthodoxy, and Arius shared in turn the same fate. Under him and his sons commissions were also issued against the Donatists, who were visited with the most rigorous punishment. The terms "inquisition" and "inquisitors" appear for the first time in history in connection with the searching out and punishment of heretics under Theodosius I., who in 382 published an edict against the Manichæans and other sects. A law of Honorius in 398 threatened the professors of certain heresies, in particular the priests of the Montanists and Eunomians, with banishment and death if they persisted in bringing people together. The decrees for the extermination of heathenism were even more severe. Heathen sacrifices were forbidden by Constantius II. in 353, under pain of death. Theodosius I. in 392 proclaimed every form of idolatry a crime, and every attempt to learn the secrets of the future by animal sacrifices high treason. Theodosius II. remitted capital punishment in 423, but again enforced the law against heathen sacrifices in 426. Most of the earlier fathers were opposed to the punishment of heretics by the secular arm, and particularly to the infliction of death. Chrysostom and Augustine approved of their being confined or exiled, but only Jerome and Leo the Great were in favor of the death penalty. The first instance in which the blood of a heretic was shed by the solemn forms of law occurred in 355, when Priscillian, the leader of a Gnostic sect in Spain, was put to death by the sword, at the instigation of Bishop Idacius. The church was struck with horror at the act; Idacius was excommunicated and died in exile. Justinian, in his code, provided certain penalties for dissenters from the orthodox creed as expounded by the "four holy synods" of Nice, Constantinople, Ephesus, and Chalcedon; and from this code the future legislation against heretics was derived. For several centuries all cases of heresy came before the ordinary courts; but in the course of time the examination of the charge of heresy devolved upon bishops, who handed over those who remained obdurate to the secular courts for punishment. Sometimes, however, ecclesiastical councils specified the punishment to be inflicted on certain classes of heretics. The organization and development of the synodal courts in the 8th

and 9th centuries systematized also the proceedings against heretics; but no special machinery for the purpose was devised until the spread in the 11th and 12th centuries of the Euchites, Bogomiles, Paulicians, Waldenses, and the various sects comprised under the common name of Albigenses. This excited the alarm of the civil as well as the ecclesiastical authorities, heresy being regarded at the time as a crime against the state no less than against the church. At the beginning of the 13th century Innocent III. sent several Cistercian monks as his legates to the south of France, in order to force the great feudatories of Provence and Narbonne into a war against the Albigenses, and to assist the bishops in searching out the heretics and in giving them over to punishment. The fourth council of Lateran in 1215 enjoined upon the synodal courts the searching out of heresy and its suppression as a duty, and may therefore be regarded as having established the legal foundation of inquisitorial courts. The bishops were called upon either to visit personally or to send delegates into every parish suspected of heresy, and to cause several, or if necessary all, of the inhabitants to swear that they would inform against heretics as well as those attending secret meetings; all who refused to take this oath should be suspected of heresy themselves. These arrangements were confirmed and enlarged by the synod of Toulouse (1229), which issued on this point 45 propositions, among which were the following: "Any prince, lord, bishop, or judge, who shall spare a heretic, shall forfeit his lands, property, or office; and every house in which a heretic is found shall be destroyed. Heretics or persons suspected of heresy shall not be allowed the assistance of a physician, or of any of their associates in crime, even though they may be suffering under a mortal disease. Sincere penitents shall be removed from the neighborhood in which they reside, if it is suspected of heresy; they shall wear a peculiar dress, and forfeit all public privileges until they receive a papal dispensation. Penitents who have recanted through fear shall be placed in confinement." The synod also enjoined upon the bishops to bind in every parish a priest and two, three, or more laymen by oath to search out heretics. But as many bishops were accused of being either remiss or partial, Gregory IX. transferred the inquisition to the Dominicans, first in 1232 in Austria and Aragon, and next in 1233 in Lombardy and southern France. The persons thus empowered and sent by the pope to different countries were denominated collectively "inquisitorial missions." To aid the inquisitors in the exercise of their office, a guild was founded after 1279, called the *militia Jesu Christi contra hæreticos*. The church, however, contented itself with the examination of the heretics, and called on the secular arm to carry the sentences into execution. Louis IX. of France from attachment to the church, and Raymond VII. of Toulouse and Frederick II.



of Germany in order to escape the suspicion of heresy, complied with this request, and made the execution of the sentences passed by the inquisitors obligatory. The procedure of the inquisitors differed in many particulars from that of the civil courts. In accordance with a decree of the councils of Béziers and Narbonne, confirmed by Innocent IV. in 1254, the informers were never named to the accused; suspicion of heresy was considered a sufficient cause of arrest; accomplices and criminals were admitted as witnesses. If the accused denied the charges, he might be put to the torture to obtain his confession. The regulations of the earlier inquisitions are found in the *Directorium Inquisitorum* of Nicholas Eymeric, who for 42 years held the office of chief inquisitor in Aragon, and died in 1399. It was first published at Barcelona in 1503; again at Rome, with a commentary by Pegna, in 1578; and has often been reprinted. The power of the inquisition was greatly increased by the income which it derived from the property of the condemned. Innocent IV. in 1252 assigned to it one third of such property, and ordered one third to be reserved for future uses; in the 15th century it was common for the inquisitors to claim the entire property. Until 1248 the inquisitorial courts were only transitory tribunals; but from that date they became permanent, and the institution was successively introduced in this form into Italy, Spain, Germany, and the southern provinces of France. The people in the south of France rose repeatedly in rebellion, and took bloody vengeance on some of the inquisitors, as at Toulouse in 1245. The parliaments declared themselves against its proceedings as irregular and unprecedented, and several kings, as Philip IV. and Louis XI., limited its jurisdiction. Its influence was also weakened by the schism of the 14th and the reformatory councils of the 15th century. After the reformation of the 16th century, Henry II., urged by Pope Paul IV., made an attempt to reestablish it, and even extorted the consent of the parliament to an edict of this kind; but it never regained strength, was wholly abolished by Henry IV., and has not been reintroduced.—In Spain the inquisition was introduced soon after its establishment in France. The Aragonese branch can be traced by authentic records as far back as the year 1232, and in the course of that century courts were established in the dioceses of Tarragona, Barcelona, Urgel, Lérida, and Gerona. At first it passed no sentence more severe than confiscation of property, and even this was restored if the accused abjured his opinions within a term called the "period of grace." Toward the close of the 15th century a new impulse was given to it by Cardinal Pedro Gonzalez de Mendoza, archbishop of Seville, and in time it assumed gigantic dimensions, becoming more absolute and independent than in any other state of Europe. The probability of a union between the Jews and Moors

against the Christians at that time excited in Spain considerable alarm. The Jews formed a large proportion of the population, and held enormous wealth. Severe restrictive measures were passed against them by the civil authorities from time to time, and finally about 1477 certain of the clergy proposed to Ferdinand to establish the inquisition in Castile, with the primary object of searching out those who having been converted to Christianity had relapsed into Judaism, or who feigned conversion while secretly attached to the faith of their fathers. The king readily assented, and, the consent of Isabella having been reluctantly given, a papal bull was procured in 1478 authorizing the establishment of the tribunal. From this date forward Catholic writers regard the Spanish inquisition as a state tribunal, a character which is recognized by Ranke, Guizot, Leo, and even Llorente. In September, 1480, a royal edict appointed two Dominicans the first inquisitors, and the first court was established at Seville. They issued their first edict on Jan. 2, 1481, by which they ordered the arrest of several "new Christians," as converts were popularly called, who were suspected of heresy, and on Jan. 6 the first *auto da fé* was held, when six persons were burned alive. Executions soon became frequent. Several of those who had been condemned as contumacious appealed to Pope Sixtus IV., who in January, 1482, complained of the conduct of the two inquisitors, and recommended mildness and moderation. Soon after he appointed the archbishop of Seville apostolic judge of appeal for all Spain, with power to decide on all appeals from the judgments of the inquisition. In 1483 Torquemada became grand inquisitor general of all Spain, and at the same time Ferdinand appointed a royal council of the supreme inquisition (*consejo de la suprema inquisicion*), of which the grand inquisitor was president of right and for life, with a bishop and two doctors at law as counsellors. Torquemada in concert with the king framed the organic laws of the new tribunal, styled instructions, which consisted of 28 articles, and were promulgated at Seville in 1484. Additions were made to them in 1488 and 1496; and at last a new compilation of regulations, consisting of 81 articles, was made by the inquisitor general Valdez in 1561, which remained ever afterward the guide of Spanish inquisitors. All the penitents of the inquisition wore a peculiar habit, called *sambenito* (a corruption of *sacra bendita*, "the blessed vest" of penitence), of which there were three different kinds for the three classes of condemned, and an equal number for those who were doomed to suffer death. The *auto da fé* (act of faith) was, properly speaking, the public and solemn reading of the records of the court of inquisition, and of the sentence by it passed on persons found guilty; but it is popularly understood of the public ceremonies accompanying their execution. The accused themselves, if living, were always pres-

the occasion; if dead, their remains or were substituted for them. The civilities and corporate bodies were also to be in attendance, as well as the crinidger and his officers, whose duty it was to see the sentence carried out. When the execution was performed with unwonted solemnity, it was called *auto publico general*. It was also an *auto particular*, or private, in which the inquisitors and criminal judge were present; the *autillo*, held in the presence of the inquisition, which was attended by the ministers of the court and the permitted by them; and the *auto singular*, which took place in the church or in the public square and against a single person. The punishment was inflicted for what the ecclesiastical judges pronounced heresy, or a relapse into heresy, or apostasy from the Christian faith. The *auto publico general* occurred rarely, and only on the Sundays between Pentecost and Advent. The prisoners were conducted in procession to the public square, where they were arrayed by themselves and all the highest personages in the land and state attended, as at a drama which recalled the terrors of the judgment. Those condemned to death were dressed in a sack of sheepskin called *zamarra*, and a cap called *coroza*, both hideously painted. The others, the more guilty wore a sack of wool or of yellow stuff with a cross on the forehead.

Prisoners of the least guilty class wore a black coat and pantaloons, and walked bareheaded and barefoot. After the solemn reading of the sentences, the penitents were taken back to their cells in the prisons of the inquisition; and those condemned to death were offered a last option between death and recantation of the heresies with which they were charged. If they recanted, they also were conducted to prison. If they remained obstinate, they were handed over to the secular authorities and led to the *quemadero* or place of execution, which was generally outside of the city. By its compact organization the inquisition became very powerful. The inquisitor-general was appointed by the king and approved by the pope; but he was in reality independent of both. He named the subaltern inquisitors, and had an absolute control over all inferior courts. The expulsion of the Jews and the Moors (1500) from Spain, which tried to evade by conversion to Christianity, and later the spreading of Protestantism, furnished the inquisition with abundant material. According to the estimate of Llorente, whose accuracy has been called in question by Catholic writers, the number of those alive under Torquemada (1483-'98) was 8,800, those under Deza (1499-'1664), 1,664, and those under Cardinal Ximenes (1507-'17) to 2,536. The general result of the statements for the time from 1483 to 1808 is as follows: burned alive, 31,912; in effigy, 17,659; subjected to rigorous punishments and penances, 291,456. From the be-

ginning of the 17th century, when it had completely exterminated Protestantism in Spain, the inquisition became more lenient, and directed its efforts mostly to the suppression of heretical books. In the 18th century the *autos da fe* became very rare. Charles III. and his minister, Count Aranda, greatly restricted its jurisdiction, and Joseph Bonaparte entirely abolished it in December, 1808. It was restored by Ferdinand VII. in 1814, but again abolished by the constitution of the cortes in 1820. After the second restoration an inquisitorial junta reappeared in 1825, and in 1826 a tribunal was reestablished at Valencia. In 1834 it was again abolished, and in 1835 its property was confiscated for the payment of the public debt. The most complete work on the inquisition in Spain is Llorente's "Critical History of the Spanish Inquisition," translated into French by A. Pellier (4 vols. fol., Paris, 1817). An abridged English translation was published in London in 1826, and reprinted in Philadelphia. The author declares that he was secretary of the inquisition of Madrid during the years 1789-'91; that from 1809 to 1811 all the archives of the inquisition were placed at his disposal; and that he burned, with the approbation of Joseph Bonaparte, all the criminal processes except those which from their importance and the rank of the accused belonged to history. The accuracy of some of his statements is greatly doubted by many. Ranke does not hesitate to impeach his honesty; Prescott even pronounces his "computations greatly exaggerated," and his "estimates most improbable." The best work on the Spanish inquisition written from a Catholic standpoint is K. J. Hefele's *Der Cardinal Ximenes*, &c. (Tübingen, 1844).—An attempt to establish the Spanish inquisition in Naples was made by the Spanish viceroy in 1546; but the Neapolitans prevented it by energetic resistance. The towns of Lombardy successfully remonstrated against a similar attempt of Philip II., but it was introduced into Sicily and the Spanish colonies in America. In the latter the tribunals of Mexico, Cartagena, and Lima rivalled in severity those of Spain. Charles V. sent it to the Netherlands, where it greatly increased the discontent of the people with the Spanish dominion; and the attempt of Philip II. to reestablish it was among the principal causes which led to the revolt of the seven northern provinces and the rise of the Dutch republic. The inquisition was not introduced into Portugal till 1557. Its organization was nearly the same as in Spain. The supreme court of inquisition, to which all other courts of the kingdom were subordinate, had its seat at Lisbon; the grand inquisitor was appointed by the king and confirmed by the pope. John IV., after delivering Portugal from the Spanish rule (1640), intended to suppress the inquisition, but succeeded only in mitigating it. Its power was broken by King Joseph (died 1777) and his minister Pombal. John VI. (died 1826) abolished it both in Por-

tugal and in its dependencies, Brazil and Goa. —In Italy the inquisition never became as powerful as in France and Spain. It was introduced in 1233 against the Waldenses, and the chronicles of many Lombard towns mention the burning of heretics; but their number seems to have been less considerable than in France and Spain. A celebrated inquisitor, Pietro di Verona, who exercised his office with great severity during 19 years, was slain in 1252. In the 16th century courts for the suppression of Protestant doctrines were established in Tuscany, Venice, Milan, Parma, and other states; but their sentences remained subject to the sanction of the temporal sovereign. A supreme tribunal of the inquisition for the whole church, called the "Congregation of the Holy Office," and consisting of six cardinals, was established by Paul III. at Rome in 1543; but beyond the limits of the Papal States the authority with which the pope invested it was never conceded to it by the temporal sovereigns. Sixtus V. in 1588 changed the name of the congregation to that of the "Holy Roman and universal Inquisition," and made it to consist of 12 cardinals, with several assessors, consultants, and qualifiers (who had to prepare the cases). The Roman inquisition was the mildest of all tribunals of this nature, no instance having occurred of the punishment of death being inflicted through its agency. Napoleon abolished the inquisition in all Italy in 1808. It was restored in the Papal States by Pius VII. in 1814, and in Tuscany and Sardinia in 1833. Since the occupation of Rome by the Italian government in 1870 the inquisition has been abolished in the kingdom of Italy. The body bearing the name of "Congregation of the Holy Office" is composed of 12 cardinals, presided over by the pope. They pronounce on all questions relating to faith and morals, but have at present none but spiritual jurisdiction. —Outside of the territory of the Romanic nations the inquisition never gained a firm footing. In Germany it was established as early as 1231; but the severity of the first inquisitor, Conrad of Marburg, aroused so general and violent an indignation, that he himself was slain in 1233, and Germany remained for a long time without inquisitorial courts. An attempt to revive it was made in the 14th century in consequence of the appearance of the Beghards. Charles IV. in 1369 supported the inquisitors by three edicts. Pope Gregory XI. in 1372 appointed for Germany five inquisitors, and Boniface IX. in 1399 increased their number for northern Germany alone to six. In 1484 it was greatly extended for the purpose of ridding Germany of sorcerers and witches, but the reformation destroyed its power even in those portions of Germany which remained Catholic. Though attempts were made to restore it in Austria and Bavaria (1599), it never regained any considerable power, and since its abolition by Maria Theresa no trace of it has existed in Germany. In England, Hungary, Sweden, Norway, and

Denmark it was never permanently established; and in Poland, where Pope John XXII. introduced it in 1327, it was of but short duration. —A general history of the inquisition, critical and impartial, is still wanting. A critical survey of a number of works treating on the subject appeared in the "British Critic" in 1827, and was reprinted in the Philadelphia "Museum of Foreign Literature and Science" in the same year. See Limborch's "History of the Inquisition," translated by Chandler (London, 1731); Joseph de Maistre, *Lettres sur l'inquisition espagnole* (Paris, 1822); and W. H. Rule, "History of the Inquisition" (3 vols., London, 1874).

**INSANITY** (Lat. *insanitas*, from *in*, privative, and *sanitas*, health or soundness), unsoundness of mind. The term is usually applied to acquired unsoundness in contradistinction to that which is congenital, but treatises on the subject include the latter under the heads imbecility and idiocy. The legal relations of insanity will be treated under the synonymous but mere technical legal term *ЛУНАСЪ*. Locke says that "madmen do not appear to have lost the faculty of reasoning, but having joined together some ideas very wrongly, they mistake them for truths, and they err as men do that argue right from wrong principles." It will be seen however, from an examination of cases, that not only are madmen the subjects of delusions and hallucinations, but that their reasoning faculties are generally more or less deranged, and sometimes entirely perverted. The attempt to treat mental diseases from a purely psychological point of view has been the cause of much useless labor, and has resulted in many erroneous conclusions. —Insanity appears to have been of rarer occurrence in ancient than in later times, and it is also seldom met with among primitive people of the present day. The occupations of both men and women in antiquity were not of a character calculated to excite cerebral disease, even if the predisposing causes had been present. It is, however, a matter of doubt whether insanity can be induced without a pathological basis, the tendency being to the opinion that it cannot. The earliest references to mental disease in antiquity are the madness of Saul, the feigned madness of David, and that of Ulysses immediately before the Trojan war. Although several instances of real or feigned madness are mentioned by the ancients, their writings contain no account of any institutions devoted to the care of the insane, nor any laws for their protection. The opinions expressed by Plato in the "Timæus" and "Phædrus," in regard to the prophetic power of madness, which he looked upon as a sacred disease and full of blessings, are well known. Ancient Greek authors, especially Euripides, abound with allusions to the supposed power of Bacchus to produce madness. Lycurgus, king of the Edonians in Thrace, refused divine worship to Bacchus, for which the god visited him with madness.

In this condition, and under the delusion that he was cutting down a vine, he killed, according to Apollodorus, his own son. The three daughters of Prætus became insane for neglecting the work of Bacchus, and ran about the fields believing themselves to be cows. It is worthy of remark that in the Mosaic law there is no provision for insane persons. In the 6th century B. C. history records a remarkable example of insanity produced by epilepsy in the person of Cambyse, king of Persia and conqueror of Egypt. It is said that from his birth he was subject to fits of epilepsy, called the "sacred disease." The earliest medical writings which treat of insanity are those of Hippocrates. It is a remarkable fact that this earliest of observers should have, like those who are the most advanced in knowledge at the present day, regarded insanity as having a pathological basis, and that through all the intervening centuries the same sound opinion should have scarcely ever been thought of. He says: "And by the same organ (the brain) we become mad and delirious, and fears and terrors assail us, and dreams and untimely wanderings, and ignorance of present circumstances. All these things we endure from the brain when it is not healthy." One of the most noted ancient writers on insanity was Aesclepiades. He believed in stimulation, and applied it in the treatment of insanity. He therefore recommended wine and recreation, and that the patient should be placed in the light, and discouraged bleeding and the use of narcotic fomentations. Celsus exercised a powerful influence upon the treatment of the insane from his time even to the present century. He wrote the first independent treatise on the subject, entitled *De Tribus Insaniæ Generibus*, in which he gives a compend of all that had up to his time been found to be the most correct views. He has received much praise from many authors, but his treatment was harsh and such as would not be tolerated at the present day. Aretæus of Cappadocia, according to the notions of his age, attributed melancholia to black bile, but says that sometimes it arises from mental causes alone. He describes the passing of the disease into imbecility and bodily decline, and shows a good knowledge of the different forms of mania. He also carefully distinguishes between the delirium of fever and of intoxication or of poison and that of insanity. Cælius Aurelianus, who is supposed to have flourished about the time of Galen, advised in mania the shaving of the head and the application of cups, first over the chest, then between the shoulders, and next to the head. As reason returned, he recommended moderate exercise, riding, walking, and reading aloud. Theatrical entertainments were prescribed for melancholics, the scenes being of a lively or sad character, according to the state of mind of the patient. Acquaintances were to be employed to converse with the patients and amuse them, and during

the progress of recovery they were allowed to go and hear the disputations of the philosophers. The celebrated Galen, who flourished in the latter part of the 2d century, based his treatment on the humoral pathology which was in such high repute among the ancients. He recommends that should you be of opinion that the whole of the patient's body contains melancholy blood, you should bleed, especially from the median cephalic vein. Should the blood not appear of a melancholy quality, the vein is to be immediately closed. Thick and black wine is to be avoided, "as from it the melancholy humor is made." After Aurelianus and Galen no medical writer of any eminence appears until the dawn which followed the middle ages. The practice of mental medicine during this period was based upon mystical theories, and cannot be said to have had a system. "That man is sick in mind," says Paracelsus, "in whom the mortal and the immortal, the sane and the insane spirit, do not appear in due proportion and strength." "Mania is a change in the reason, but not in the senses." And he gives for causes over exercise of the reason, the elements, influences, constellations, conjunctions, microcosm, macrocosm, &c. As to remedies he says: "What avails in mania except opening a vein? Then the patient will recover. This is the arcanum; not camphor, not sage and marjoram, not clysters, not this, not that, but phlebotomy." The first institution for the insane was established in the East. It is said that one existed at Jerusalem in the year 491. In the 12th century the traveller Benjamin of Tudela says there was a large edifice at Bagdad, called "house of grace," in which the insane were received in summer and kept confined in chains until they recovered or died. It was visited by the magistrates every month, and those who had recovered were discharged. In the same century hospitals for the insane were founded in the Byzantine empire, and asylums for them are said to have been common among the Moors.—The amelioration of the condition of the insane is not difficult to trace, as it had its commencement in modern times. Bucknill and Tuke remark: "It must be a matter of surprise that the principles of treatment so well laid down by one or two of the ancient medical writers should have been so entirely forgotten or disregarded. It is indeed to be presumed that the directions of Celsus have exercised a most prejudicial influence, even till within a very recent period; and it is not difficult to recognize them in the writings of the classical Cullen, who did not omit to recommend the employment of 'stripes' in the treatment of the maniacal." The pursuit of mental philosophy by the metaphysicians of the 18th century was not accompanied or immediately followed by any corresponding advance in the study or treatment of mental diseases. This was brought about by the investigations of physicians and the ef-

forts of philanthropists. Systematic writers on the subject of insanity have usually dated the commencement of reform from the labors of Pinel, and to that great man too much credit cannot be well given. "The year 1792," say Bucknill and Tuke, "will ever be memorable in the history of the treatment of the insane. In that year the celebrated Pinel liberated 53 of the patients confined in the Bicêtre from the chains by which it was thought necessary to restrain their fury." Pinel's labors were attended by great results, but he was not the pioneer in modern reformatory treatment of the insane. The subject had received the attention of Benjamin Franklin and others in this country as early as 1750. At the organization of the Pennsylvania hospital at Philadelphia a department for the care of the insane was established, in which the system afterward advocated by Pinel was successfully practised. An act was passed founding "a hospital for the reception and relief of lunatics, and other distempered and sick poor." (See annual address before the medical society of the state of New York, 1868, by Dr. John P. Gray.) The reform in the treatment of the insane in England, particularly in regard to restraint and punishments and mode of confinement, forms an interesting chapter in the history of institutions for the insane. Bethlem hospital, or Bedlam, as it was commonly called, which on various occasions became notorious for the ill treatment of the insane, was founded and first provided for them with benevolent intentions. In 1547 Henry VIII. took possession of the monastery or hospital of St. Mary of Bethlem, and presented it to the city of London, with an order that it should be converted into a house for the reception of lunatics. This building, however, could accommodate only 50 or 60 patients, and therefore in 1675 a larger one was erected in Moorfields, capable of receiving 150 patients, and which remained as a hospital till 1814. In 1734 additions were made to Bethlem, and it still proving too small, St. Luke's hospital was established in 1751 by voluntary subscription. The York asylum was founded also by general subscription in 1777. The management of the asylums had previously begun to retrograde, but not many complaints were made until the year 1791, when some members of the society of Friends sent one of their family to the York asylum. The rules forbade any of her friends to see her; suspicion of something wrong was aroused, and a new establishment called "the Retreat" was founded by the society, chiefly through the influence of William Tuke, in the spring of 1792, the year in which Pinel caused the lunatics in the Bicêtre to be liberated from their chains. At the retreat no chains, leg locks, or handcuffs were employed from the opening of the establishment. A patient who had been chained naked for 20 years was admitted; no restraint except the occasional use of arm straps

was employed, and he was soon induced to wear clothes and adopt orderly habits; and there were many other cases of a like nature. Little was publicly known of the experiment till 1798, when De la Rive visited it, and was so delighted with what he saw that he published an account of it on his return to France. The publication of a "Description of the Retreat," by Samuel Tuke, in 1813, attracted still more attention to the institution. The physician of the York asylum took offence at some observations it contained, and a controversy arose which resulted in exposing a number of aggravated cases of bad management in the other asylums, and also in causing the house of commons in 1813 to appoint a committee to investigate the subject, who visited not only Bethlem and York asylums, but many private institutions, and brought a horrible condition of things to light. Among the minutes of evidence taken before the committee are the following. One witness, Mr. Edward Wakefield, said: "In the year 1808 I heard a physician state to the Rt. Hon. John Foster, that of the insane persons who were sent up to Dublin the treatment of them was so little understood that the accustomed mode was tying them with a cord to the back of a car and forcing them to walk the distance they might have to come; and this gentleman's expression was, 'I give you my honor that of the insane persons sent up to Dublin almost one in five loses an arm from the tightness of the ligature producing mortification, which renders amputation necessary.'" Dr. Richard Salisbury, a general practising physician, testified: "In one house the number of patients confined is 23, 14 men and 9 women; 7 of the men and 7 of the women supported at their own expense. One room was on the ground floor, 21 by 16 ft. and 7 ft. high, divided into 6 cells, 9 ft. long and 5 ft. wide, with a passage 3 ft. wide between; not the least air or light admitted except when the doors are open. The principal door immediately opposite a pig sty and dung heap about 7 ft. distant. Three only of the cells floored with wood, the other three were on the bare earth. A long box, 6 ft. by 2½ ft., was used for a bedstead, to which the patient was chained. Some had blankets, some only coarse straw. They were taken out to air once a week, during which time clean straw was supplied when necessary. The patients were so dirty in their persons that on opening the door of the first cell the smell was so offensive as nearly to prevent further inspection." The medical treatment in most of the establishments was of the lowest empirical kind. The physician of Bethlem said: "Twice a year, with few exceptions, the patients are bled, and after that they take vomits once a week for a number of weeks, and after that we purge them. That has been the practice for years, long before my time." But it must be remembered that although much of the treatment arose from cruelty and negligence, the system

posed by the more ignorant to be one of insanity. Lunatics were not looked upon as unfortunate sufferers from disease, but as subjects of demoniacal possession, as self-made victims of evil passions. Knowledge of the abuses aroused the public mind, and medical men not only felt called upon to pay more attention to the study of the methods of treating the insane, and to take the example of the Tukes at the asylum at Hanwell.

—*Causes.* The causes of insanity may be divided into predisposing and exciting. The general predisposing causes are sex, age, constitution, education. The question as to the influence of sex has not been definitely settled. Alienists are agreed that the existing statistical tables do not settle the question, and that the reports are apt to mislead, as the number of female patients in asylums may be increased by the greater unwillingness of friends to remove them from home than males. The statistics of Esquirol embrace about 70,000 patients in various countries, and show a small majority of males, and he and also Haslam thought insanity more frequent among women than men. Haslam said that women are more liable than men to inherit insanity, and Dr. Maudsley has arrived at this conclusion. In regard to the influence of age, cases of insanity are rare in childhood. The greatest number become insane between the ages of 25 and 50. It is difficult from statistical tables to determine the effect of social position. In England there are about 9,000 poor and 1,000 members of wealthy families in public asylums, and this is probably about the ratio of the poor to the rich; but it is probable that a state of poverty is more prolific of mental disease than one of affluence. It has been found more frequent among unmarried men and married women. Its great tendency among married women is probably due to care, anxiety, and over-exertion of the mind, and difficulties in gestation, and menstruation. Of the more predisposing causes, heredity plays an important part. Jacobi in 220 cases of insanity found hereditary predisposition in about one-third. Hagen in 170 cases found it in one-third. Esquirol found it among the rich more than one-fourth; in the rich, one-third; in the poor, one-fifth. Webster found at Bedlam, in 1,000 patients, hereditary predisposition in one-third, oftener in females. Skae of Edinburgh, in 248 admissions, found it in a little more than one-third. In a large number, from various Irish asylums collected by Dr. Jarvis in Massachusetts, it was found among 44,000 in the proportion of  $\frac{1}{5}$ , and 43,093 in the proportion of  $\frac{1}{4}$ . At Bloomingdale asylum, it was found to be about one-third. It was advanced by Esquirol, and confirmed by Baillarger in the examination of 453 cases of insanity, that insanity is more frequently transmitted from the mother than from the father. Baillarger found that the transmission from the mother to the sons was only about equal to that

of the father; but the transmission to the daughters was twice as frequent. This would indicate that women inherit insanity oftener than men, a point previously alluded to. It is also found that children who inherit insanity sometimes manifest the disease before the parents do; but they are more likely to inherit it if born after its appearance in the parents. There is also a tendency in hereditary insanity to show itself in much the same way in the different individuals of the family; thus it has been observed that a whole family of brothers and sisters have become insane at about the same age, and committed suicide. The disposition may be removed by marriage with healthy stock, or may be increased by intermarriage.

—The exciting causes of insanity may be divided into moral or psychical and physical. The principal psychical causes are grief, fright, anxiety, care, or an excited state of any passion, particularly if recurring often or prolonged; the emotions aroused by disappointment, by unfortunate love, by jealousy, by reflecting on misfortunes that have ruined the prospects of life; excessive or prolonged employment of the intellectual faculties, particularly when connected with the emotions, as the composition of poetry or romance, or the prolonged excitement attending the management of difficult legal cases. Anything which will produce a hyperæmia of a portion or of the whole of the brain, by which the nutrition and consequently the normal function is interfered with, may become an exciting cause. From the number of cases of insanity in men of business, who have broken down in the struggle to amass fortunes, it is fair to assume that the prominence given by Maudsley to the eager desire to get rich as a cause of insanity is amply justified. He says: "The occupation which a man is entirely engaged in does not fail to modify his character, and the reaction upon the individual's nature of a life which is being spent with the sole aim of becoming rich is most baneful. If one conviction has been fixed in my mind more distinctly than another by observation of instances, it is that it is extremely unlikely that such a man will beget healthy children; that, in fact, it is extremely likely that the deterioration of nature which he has acquired will be transmitted as an evil heritage to his children. In several instances in which the father has toiled upward from poverty to vast wealth, with the aim and hope of founding a family, I have witnessed the result in a degeneracy, mental and physical, of his offspring, which has sometimes gone as far as extinction of the family in the third or fourth generation." The principal physical causes are drunkenness and the use of narcotic or poisonous drugs; want of food; want of sleep and over-exertion; other nervous diseases, such as epilepsy, chorea, and hysteria, particularly the first; severe injuries to the head, particularly from blows, causing fracture of the skull or concussion of the brain; sun-

stroke, and tumors in the brain. Acute febrile diseases, as typhoid, typhus, and malarial fevers, are also causes of insanity; and it may occur during the course of pneumonia, generally in the form of acute mania. The poison of Asiatic cholera may so interfere with the nutrition of the brain as to produce not only transient delirium, but mania, which may continue for several days or weeks. Acute rheumatism is sometimes a cause of insanity; and it is an interesting fact that the mental symptoms follow the apparent disappearance of the rheumatic symptoms, and pass away upon the reappearance of the disease. Chronic constitutional diseases are frequent causes, and among the most formidable probably of these is constitutional syphilis. Its effects are produced in a variety of ways. The skull may be the seat of exostosis or of caries; the membranes may be affected and cause mal-nutrition of the cerebral substance; or tumors of the brain may arise directly from the effects of the syphilitic poison; or the nutrition of the whole body may be so interfered with that all the plastic material furnished by the food is vitiated and incapable of forming sound nervous tissue. The syphilitic affections of the nervous system have recently been the subject of careful examination by Drs. Wilks and Moxon. According to Dr. Wilks, there is in syphilis a disposition to a low form of lymph in nearly every tissue of the body, which does not readily form tissue, never that which is perfectly normal. According to Dr. Moxon, syphilis attacks the surface of the brain and its membranes in limited spots, spreading slowly. The lymph which exudes from the membranes destroys the gray matter of the convolutions, and syphilitic deposits may form fleshy tumors which contain a certain gummy characteristic substance; or the brain and spinal cord may be invaded by gummatous tumors springing from the dura mater or the bones. Paralysis of various degrees of intensity and extent, and also mental diseases, are the results. (See lectures of Dr. Broadbent, "London Lancet," 1874; also an illustrative case, with plates of pathological changes, "American Journal of Insanity," July, 1874.) Tuberculosis, particularly by inducing a state of exhaustion or degenerated tissue development, is sometimes an exciting cause of mental disease; and, as will be noticed further on, there are apparently intimate relations between tuberculosis and insanity and certain other forms of nervous disease. Diseases of the heart have been assigned as causes of insanity, and as far as they operate in exhausting the strength of the patient, they may be considered as such; but more often the heart disease is, along with the mental affection itself, the effect of other changes, such as disease of the arteries or capillaries, or of the vaso-motor system of nerves. Disease of the genital organs sometimes exerts an important influence in producing insanity. During the period of sexual de-

velopment, particularly when any morbid condition is present, resulting from secret vice or from any cause, insanity in some form, mania, melancholia, or dementia, is liable to occur. Disorders of menstruation at any period of life may bring on attacks of mental disease; as also may diseases of the uterus or ovaries, such as tumors, cysts, or displacements. Pregnancy, the puerperal state, and lactation are not infrequent causes of mania and melancholia. A state of melancholy during pregnancy is often the precursor of an attack of puerperal mania. Insanity from lactation is generally in consequence of the exhaustive effect of the function superinduced upon a hereditary predisposition. Sexual excess and unnatural vice, from inducing a perverted condition of the mind and nervous system, as well as from their weakening effects, are not uncommon exciting causes of insanity. But among all the causes of mental disease, it is acknowledged by most authorities that the excessive use of intoxicating drinks is the greatest. Of 1,428 cases admitted into Bethlem hospital, 12 per cent. were found to be caused by intemperance. The report of the commissioners in lunacy in England in 1844 gives, out of 9,668 cases, 1,792, or more than 18 per cent., as the proportion attributable to the effects of alcoholic liquors. Of 748 cases, Halloran found drunkenness a cause in more than one fifth. Prichard and Esquirol attribute half of the cases of insanity in England to intemperance. Dr. Rush gave it as the cause in one third of the cases in America, and more recent statistics of some asylums show a larger proportion. Blandford and other modern writers ascribe to it a potent influence. Dr. Dickson, late superintendent of St. Luke's hospital, London, takes a somewhat different though not opposite view. He says: "Although it is true that drunkenness is very frequently the exciting cause of an attack of insanity, yet the incentive to drunkenness is the result rather than the cause of brain deterioration in the first instance; a potentiality of insanity is often discovered on examining the history of the persons who complain of a constant sense of depression, and who seek to relieve that depression with stimulants." The continued use of intoxicating drinks and narcotic poisons, in the opinion of Dr. Carpenter ("Mental Physiology," 1874), destroys or weakens the will so that it loses its control over the emotions. The experiences given by De Quincey as to the weakening of the will in his own case, so that he became unable to perform what he had planned, not from want of brain power, but of volition, is instanced by Dr. Carpenter as an example; and he also points to the excessive use of tobacco in creating a mental state which manifests itself in deferring the performance of pressing duties. The effect of alcohol he regards as more potent in weakening the will and arousing the more violent passions than that of any other agent; and it is not improbable that the excessive and habit-

of alcoholic beverages, which are produced in such great quantities by civilized nations, has had much to do in inducing a strong tendency to insanity, and causing a great number of mental maladies to a greater extent civilized than among other nations. The researches of Morel on the cause of the origin of degenerate varieties of the human race are interesting as explaining the course of morbid action through succeeding generations, and the final extinction of the human race by the evil influences which produce disease, such as the poisonous air of a malarious country, or a badly drained and cleaned city, overcrowding and privation in large towns, intemperance and sexual excess, and inbreeding in families, unless counteracted, appear to increase through generations, and the continuance of the species is impossible. Insanity in any form, whether mania, melancholia, or dementia, as a stage in the progress toward sterile idiocy, as sometimes the result of the consequences of frequent intermarriage in foolish families. He relates the history of one family in which the progress of insanity may be briefly stated as follows: first generation—immorality, alcoholic excess, and degeneracy; second generation—hereditary insanity, maniacal attacks, general debility; third generation—sobriety, hypochondria, lypemania, systematic mania, and suicidal tendencies; fourth generation—feebleness, stupidity, first attack of mania, and final transition to complete idiocy, and procreation of the family.—*General Symptoms of Insanity.* The earliest symptoms of insanity are depressed manner, unusual irritability, anger, and rashness; and even these may be preceded by an altered manner, if no notice has been taken. An abnormal condition of brain exists, including a want of energy which creates a consciousness that there is something wrong; a want of coordination of the faculties produces false reasonings and conclusions as to the nature of the disease, and so as the disease progresses delusions and hallucinations make their appearance. An important symptom in all forms of insanity is impairment of the faculty of attention, which might be expected from the loss of energy which directs the attention. The inconsistency of the beliefs of the insane is one of the most noticeable symptoms, and they are commonly classified as "delusions" and "hallucinations." It is important that a clear conception of the meaning of these terms should be obtained. A delusion is a false belief in regard to a fact which generally concerns the patient, and which is so strongly rooted that all attempts to reason him out of it are futile. The patient may believe that a certain occurrence will take place at a certain time, or that he is a saint, or a prince, or that his head is made of metal. The delusions of the insane may be of a gloomy or exalted nature. A man who believes

poverty to be the greatest evil may, in consequence of false reasoning as to the state of his affairs, imagine himself to be ruined, and that his family will be turned out of doors. When the patient has exalted delusions he is apt to imagine himself immensely wealthy, or that he is the asylum in which he is confined is a palace and himself a monarch. A hallucination is a false perception of one of the senses; the patient may fancy that he sees a spirit, or a person who does not exist; such hallucinations are common in the temporary insanity of delirium tremens, when the patient may imagine that he sees serpents, or frogs, or insects, or that people, generally those whom he dislikes, come into the room. Hallucinations affect the different senses; thus the insane have hallucinations of sight, of hearing, of taste, of smell, and of touch. Hallucinations of sight are more liable to occur when the brain is in the greatest state of exhaustion, and to accompany the acute stages. They may be simply flashes of light or colors, or they may be objects like those in the state of exhaustion called delirium tremens. The hallucinations are oftentimes visions of the supernatural. Epilepsy in the insane is constantly accompanied by hallucinations of sight. Hallucinations of hearing occur in acute, but are more frequent in chronic cases, and are unfavorable symptoms; and those who are subject to them are often the most dangerous patients. They are liable to hear voices commanding them to perform certain acts, which they are blindly impelled to attempt, however absurd or destructive. Hallucinations of smell are generally not persistent, and belong to the acute stages; and those who have them are apt to imagine that their own persons have an intolerable stench. Hallucinations of taste are rather uncommon, and are generally associated with disordered digestion. Those of feeling are not uncommon, and patients often declare that they feel themselves touched, or that they feel snakes or other animals in their bodies. The acts of the insane are prominent symptoms. There is a proneness among them to strip off their clothes, arising from various causes. They often experience a feeling of uneasiness, often of heat from the pressure of their clothes, or they imagine that they are foul or poisoned. Sometimes in mania there is a desire to destroy them, and in other cases to expose the person. The desire to dress in a fantastic garb is common among the insane. In states of exaltation, whether of mania or of melancholia, the patient will often desire to assume a dress of authority, and the dejected melancholic will assume the most careless appearance. In some forms of insanity there is often a disposition to commit acts of violence and destruction. Sometimes these acts will be directed against inanimate objects, sometimes against other persons, and sometimes against the patient's own person. In the two latter instances it has received the



names of homicidal and suicidal insanity. Some authorities contend that such a classification should not be made; but there are too many cases furnished by insane asylums, and which have occurred under the notice of intelligent physicians, where lunatics have shown morbid impulses to commit wrong acts which they had not sufficient will to resist, to leave much room for doubt that such states of the mind do occur. Patients have under some circumstances committed deeds of violence under the influence of impulses, and have at other times, in anticipation of the coming on of those impulses, asked to be restrained, saying that they feared they would not be able to resist them. Considering the morbid perversion of the nervous system and the unhappy condition of the mind in some instances, it is not strange that the combined effects of these and of insane delusions and hallucinations should result in such acts, nor that the disposition to commit violence should under the circumstances take these forms.—*Classification.* There have been many classifications of insanity, but they have not thrown much light upon its nature, and in many cases have rather been hindrances to the discovery of the most important conditions (pathological) of the patient. The older writers divided insanity principally into mania and melancholia. Thomas Arnold in 1802 made a general division into ideal and notional insanity. The ideal he subdivided into: 1, phrenetic, or raving; 2, incoherent; 3, maniacal; 4, sensitive. Notional insanity he divided into: 5, delusive; 6, whimsical; 7, fanciful; 8, impulsive; 9, scheming; 10, vain or self-important; 11, hypochondriacal; 12, pathetic; 13, appetitive. The pathetic he subdivided into 16 varieties: 1, amorous; 2, jealous; 3, avaricious; 4, misanthropic; 5, arrogant; 6, irascible; 7, abhorrent; 8, suspicious; 9, bashful; 10, timid; 11, sorrowful; 12, distrustful; 13, nostalgic; 14, superstitious; 15, enthusiastic; 16, desponding. Pinel made four divisions, viz: mania, melancholia, dementia, and idiocy. Esquirol added to these another, monomania. Dr. Prichard, whose work, published in 1835, was for a long time high authority, made two general divisions, moral and intellectual insanity, subdividing the latter into three, monomania, mania, and dementia. The existence of such a disease as moral insanity is not recognized by a majority of modern alienists, and it is contended that the moral sentiments are often wanting in persons who are considered sane, as well as in the subjects of mental disease. Dr. Daniel Tuke divides insanity according as it affects—1, the intellect; 2, the moral sentiments; 3, the propensities. Maudsley classifies insanity into two great divisions, which are subdivided into varieties as follows: 1. Affective or pathetic insanity, including: 1, maniacal perversion of the affective life, *mania sine delirio*; 2, melancholic depression without delusion, simple melancholia; 3, moral alienation

proper. Approaching this, but not reaching the degree of positive insanity, is the "insane temperament." II. Ideational insanity, subdivided into: 1, general (*a*, mania, acute and chronic; *b*, melancholia, acute and chronic); 2, partial (*a*, monomania; *b*, melancholia); 3, dementia, primary and secondary; 4, general paralysis; 5, idiocy, including imbecility. In the first division the intellect may be comparatively unaffected, but there is insanity of feeling and action. In the second there is insanity of thought, or delusion. The "insane temperament" is a kind of potential insanity introduced by Maudsley to characterize a condition of mind in which great eccentricity of thought, feeling, and action, proceeding from a morbid nervous organization, does not make the person actually mad, but queer and morbidly eccentric. Individuals having this temperament have certain marks of genius, though never of the highest order. Griesenger, one of the highest modern authorities, says: "A classification of mental diseases according to their nature, that is, according to the anatomical changes of the brain which lie at the foundation, is at the present time impossible." He therefore classifies insanity according to the nature of the psychical symptoms, and says "that while it is the aim of clinical instruction to render conspicuous and to analyze the multiplicity of mental disorders in the concrete, nosology must content itself with establishing fewer principal groups, fewer abnormal states to which all the varieties of individual cases may be referred." He divides mental diseases into two grand groups. In one there is a morbid condition of the emotions, affecting, according to its nature, the whole mental life of the patient. In the other group insanity consists in disorders of the intellect and will, which exhibit, "without profound emotional excitement, an independent, tranquil, and false mode of thought and of will, usually with the predominant character of mental weakness." In most cases the conditions found in the first group precede those in the second, the latter generally being consequences and terminations of the former. The different forms of insanity may be conveniently considered under the following divisions: 1, melancholia; 2, mania; 3, general paralysis of the insane; 4, dementia; 5, imbecility; 6, idiocy.—*Melancholia.* This may be acute or chronic. The great majority of cases of insanity commence with a state of emotional perversion of a depressing and sorrowful character, which has been called the *studium melancholicum*, or initiatory period of mental disease, or the period of incubation. The first stages of melancholia are generally preceded by a condition called hypochondriasis, which may be considered as the mildest form of insanity. There is a feeling of bodily illness at this time more than at any other, or in any other form of insanity. It is often vague, and depends upon irritation of the nervous centres arising from disorders, some-

times obscure, of the viscera. The patient becomes peevish and suspicious, is easily fatigued, a mental apathy takes possession of him, and he becomes weary of life; or he passes into a state of extreme anxiety. The mention of a disease will often cause him to fancy that he is afflicted with it, and he is constantly feeling his pulse and examining his tongue and excretions. He often changes his physician, and so his opinion of the nature of his ailment. His feelings are not all imaginary; there is frequently indigestion, sometimes of an aggravated character, accompanied with great evolution of gas, which by its distention of the intestinal canal occasions uneasiness. The tongue is foul, the appetite irregular, the bowels constipated, and the skin in an unhealthy condition. Moral treatment is often beneficial, but should always be accompanied by therapeutical measures calculated to remove pathological conditions. This state is very often accompanied by an inherited tendency to mental disease, and when not relieved passes into that condition more definitely styled melancholia. Its delusions take a more decided character, and he fancies himself a criminal. He is now evidently to all observers an insane man, and becomes the subject, not only of delusions, but of hallucinations; he imagines that he is beggared, and that his family are to be thrown helpless on the world; that he is destroyed by odious diseases; that he has prosy, and that a loathsome smell emanates from his body. His countenance expresses intense woe, and he stands for hours in one place and in one posture, either in solitude or in the street; or he may be impelled to constantly wander about. He sleeps badly, and generally eats but little; the bowels are obstinately constipated, the breath offensive, and the pulse slow and weak. The age at which persons are liable to melancholia is often the prime of life, or when the vigor is beginning to fail, at 40, 50, or 60 years. Of 338 cases of melancholia admitted into St. Luke's hospital, London, only 9 were under 20 years of age. Women who have been weakened by parturition are sometimes the subjects, when it generally assumes an acute form, with sleeplessness and obstinate refusal of food. In this state there is almost always a disposition to commit suicide, which may manifest itself suddenly; sometimes it appears earlier in the disease, even before the other symptoms have been observed. The treatment of a case of chronic or sub-acute melancholia will vary with its history and symptoms. An asylum is indispensable if the patient's means are sufficient to provide him with proper care. He may be benefited by travel and change of scene; but when his condition will not admit of this, a proper place, either a private house or an asylum, should be selected, and an attempt made by therapeutical and hygienic measures to restore the cerebral defect by sleep and nourishment of the body. In many cases

recovery will be observed to rapidly follow medical treatment alone, some bad cases getting well in a couple of months. There are three conditions which require constant attention: want of sleep, rejection of food, and constipation. To remedy the first, chloral is much used by some; others prefer the effects of morphine or Dover's powder, believing that chloral is better suited to the more violent condition of mania. Wine and brandy are also used to give temporary strength, and have been observed to be of practical benefit, inducing sleep in some forms of insanity. As to whether the dyspepsia and other visceral disorders are the cause of the melancholia, or whether they are in common with it, the result of a primary nervous disorder, is one of those disputed matters about which physicians will probably never be perfectly agreed. The practical aim is, however, to produce regularity of the evacuations by laxative medicines, and to sustain the strength with nourishing food and wine. The prognosis in cases of melancholia is generally good. Some have recovered after having been a long time in asylums, and subject to suicidal impulse and delusions and hallucinations. If the melancholy becomes paroxysmal, or runs into mania, the prognosis is not so favorable, as pathological cerebral changes of a permanent character are liable to occur. The symptoms are intensified; there is now no longer mere depression or silent stupor or anxiety, but the patient becomes frenzied. He will hardly sit or lie in one position for a moment, and has to be placed in restraint, either mechanical or manual. He is extremely suicidal, and will not only try to put an end to his life, but will attempt to injure his person by gouging out his eyes, or swallowing nails or pieces of glass or corrosive liquids. He is not liable, like a subject of general paralysis or an epileptic maniac, to make homicidal attacks; but he will resist with violence the assistance of his attendants. He will not take food, will not be washed or remain in bed, and will strip himself of clothing. There is an increased weakening of the will, indicating great deficiency in cerebral nutrition. There is a great tendency to sink rapidly from exhaustion, and therefore the patient has generally to be forcibly fed, or, as is said, to be fed "mechanically." This is accomplished by forcibly opening the jaws and putting nourishing food into the pharynx with a spoon, or by introducing it with the œsophageal tube, which is generally preferred. Gentleness, however, will sometimes succeed in prevailing on the patient to swallow his food voluntarily, and must of course be tried until found of no avail. One great danger is death from starvation, and therefore food must be given, and in considerable quantities. Chloral is considered appropriate, and may be given alone, or in combination with conium, hyoscyamus, &c. If the patient refuses, it may be given by the rectum. Morphine is also of service,

particularly in the form of subcutaneous injections. Constipation is to be relieved by laxatives and clysters. Other medicines, as bromide of potassium and digitalis, according to Blandford, are not worth the trouble of administering. Warm baths will be of great benefit, and the room should be kept warmer than usual. The patient wastes rapidly, and it is often impossible to give him enough food. Another form of melancholia of a chronic character often follows an attack of mania. It is attended with less mental excitement, resembling more a state of dementia, but recovery from it sometimes takes place.—*Mania*. This is usually classified, in a general way, as acute and chronic, and Blandford adds a variety which he calls acute delirious mania. Mania, particularly where there is hereditary taint, may be brought on by grief, misfortune, or disappointment; but peculiar forms of it accompany epilepsy and general paralysis of the insane. Acute mania may come on suddenly, or it may be preceded by melancholy lasting for some time. The symptoms of acute mania are by no means obscure; there is almost always manifested extreme mischievousness, filthiness in person, and obscenity in language. One distinction between mania and melancholia is in the manner the mental state affects the acts. There may be delusions in mania, but they are of a more confused kind and the acts are more purposeless, while in melancholia there is the evidence of some plan. The conversation is more incoherent. Maniacs will heap abuse on all around them, and are inclined to use violence. They commit self-abuse, and may become shameless in the exposure of the person. The bodily health often does not suffer greatly, and they seldom die unless their health is broken at the commencement of the attack, in which case they may wear themselves out. They eat heartily, but generally grow thin, although not very rapidly. There is want of sleep. Sometimes they will pass a good night, getting several hours of sleep, and then may go several days with only two or three hours' sleep, shouting, laughing, and singing. The tongue is often clean, and the bowels are not generally constipated; hence maniacal cases do not yield to medical treatment as readily as some cases of melancholia. Chloral may be of benefit to procure sleep. The doses should be large, from 40 to 60 grains. Opiates are given by some and condemned by others. The prognosis, when acute mania is not complicated with other disease, is on the whole favorable. Much, however, will depend on the time which has elapsed since the commencement of the attack. If this has been long, recovery will be doubtful because of the changes which have taken place in the brain, a continued state of hyperæmia producing chronic thickening of the cerebral membranes and changes in the brain substance. The patient may recover, or die with a hyperæmic state of the brain, or gradu-

ally sink into a state of hopeless chronic mania or dementia, or become melancholic. From this he may recover, and again become maniacal. Acute delirious mania, as described by Dr. Blandford, differs from the preceding in being accompanied with more delirium and with more bodily disorder. The tongue is often coated, sometimes brown and dry, and as the patient becomes exhausted a typhoid condition ensues. The urine is scanty and high-colored, and the bowels rarely act without laxatives. The treatment consists in regulating the bodily functions, giving food freely, combined with plenty of drink, and also wine, and in the judicious use of hydrate of chloral. Opium should not be given, as it obstructs the secretions and is liable to increase the delirium. Rest is of the highest importance, and baths of warm water, in which mustard may be stirred, are of great benefit, the head to be kept cool during the operation. Purgatives at the outset of the attack may be of use, as aiding to arrest it. The termination is almost always recovery or death, melancholia or dementia rarely following. Where an acute case of mania is neglected or badly treated, or is of a violent and persistent kind, it may pass into a chronic state in which there is either constant excitement of a less violent kind, or a fixed delusion. The patient gradually becomes feebler in intellect, although his bodily health may improve, and with variable degrees of rapidity sinks into a state of dementia.—*General Paralysis of the Insane*. The peculiar form of disease accompanied by insanity to which this name has been given is of the most formidable character, no instance of recovery in a well marked case having been recorded. The French physicians are entitled to the credit of having first recognized and described it. Esquirol was aware of the complications of insanity with paralysis, but did not recognize the whole as a distinct disease. Bayle in 1823 attributed the cause to chronic inflammation of the arachnoid, and named the disease *arachnoiditis chronique*. M. Calmeil in 1826 gave a complete account of it, and for that reason he is often called its discoverer. It has received several names, as *folie paralytique*, *paralysie générale progressive*, and *Geisteskrankheit mit Paralyse*. In England and America it has usually been called general paralysis of the insane, or paralytic insanity, and lately it is often called simply "paresis." It is generally regarded as presenting three stages: 1, the period of incubation; 2, the acute maniacal period; 3, the period of chronic mania, leading into dementia, with utter prostration of both mind and body. At the commencement of the disease an alteration in the manner of the patient may be observed, similar to that which is noticed in other forms of insanity, although there are commonly other symptoms which are of importance in forming a diagnosis, such as excessive extravagance in the spending of money. A general paralytic is liable to com-

rageous and immodest acts, such as ex- of person and foolish assaults upon he is easily aroused into a passion, which es to uncontrollable fury; he neglects ness, fails to keep appointments, and a general weakening of the mind simi- at in the commencement of senile de-

This, occurring in a vigorous man, out be regarded as a remarkable symp- l of alarming import. These symptoms rapidly, so that the disease will have advanced in a few weeks. He sleeps ats and drinks irregularly and often uly, spilling his food on his dress, of e takes but little care. He is for a llen and morose, but as the disease ad- rows more and more excitable; and it comes evident that he needs restraint. cal condition ensues, in which he as- irs of great importance, imagines him- sessed of unbounded riches, and the f studs of the fleetest horses. An or- manic may imagine himself a duke and essor of vast wealth, but he will show onsistency in adhering to the same ; while the general paralytic will mself a duke, a prince, and a king al- the same sentence, and will announce tion of doing a hundred impossible n the next day. He has extravagant of his intellectual, and particularly of sical strength, and when in the last f bodily weakness will maintain that perform the most wonderful feats. He always says that he feels well, even t able to feed himself. In consequence : peculiar symptoms, the French have he disease *manie des grandsseurs*. His generally shows the first effects of pa- although it sometimes commences in er extremities. The articulation be- obstructed, somewhat like that of a man. It is not a true stammer, but want of power over the vocal organs. : often a peculiar tremulousness of the h as is seen in grief. The defect in varies from time to time, sometimes ng noticeable except to the practised n, and at others rendering the patient igitible. The subjects of the disease are always men in the prime of life. It t attack boys or old men, and rarely

The violence of the mania attend- eral paralysis is of the most danger- racter; its subjects become possessed blind fury, and know not what they are

In this stage they are not paralyzed n in their limbs to prevent them from erious harm; therefore the restraints ylum are almost absolutely necessary. mptoms appear in time. Fits resem- plexy or epilepsy occur from time a dividing the disease into stages, e called "congestive," or "paralytic," eptiform" attacks, and resemble some- e *petit mal* of epilepsy, at others the

*grand mal*. Again, they may not be attended by any convulsion, but by sudden collapse and paralysis, which slowly passes away. The epi- leptiform attacks have not the definiteness of epileptic fits, but may last an hour or two, or pass off so rapidly that the patient may con- tinue standing. It is important to distinguish these fits from those of true epilepsy, as the latter are more benefited by treatment, even when accompanied by insanity. In fits of gen- eral paralysis patients seldom bite the tongue, while in epilepsy they almost always do. The pupils of the eyes will generally be found ir- regular, and when this symptom is present it is important. In 108 cases of general paralysis examined by Dr. Nasse of Siegburg, the irreg- ularity was present in all but three. Dr. Aus- tin found only two exceptions in 100 cases. Irregularity of the pupils may, however, exist in other forms of insanity, and also in the sane in other affections of the brain, but it is much more rare. When accompanied with the other symptoms of general paralysis, it may be considered pathognomonic. The course of general paralysis has an average duration of about two years; some few cases last only a few weeks, and some may run on for five or six years. The maniacal or second period may last from a week to two months, and generally yields to treatment, the patient getting better, so that he is able to go about and appear like a sane man for a while; or he passes into a state of dementia, and so on downward to extinction of mind and body. Sometimes after apparent recovery the subjects of this disease may at- tempt to reëngage in business, but such attempts have always been found to fail. The last stage, that of dementia, is sad indeed, and it is fortunate that the disease is rapid in its progress. The patient can scarcely walk or feed himself, and there is constant tremor of the hands; a habit of grinding his teeth in a most horrible man- ner comes on at this time; and his appetite remains good, but the power of swallowing is greatly diminished, and he will often go on cramming food into his mouth until he be- comes nearly suffocated. The cause of general paralysis is a subject of discussion. Some au- thorities have but little doubt that it is gen- erally produced by fast living, excess in wine and in sexual intercourse, particularly the lat- ter. Others deny this, saying that it may arise from extreme mental exertion, greatly pro- longed, and point to examples in men of a high order of intellect in which this was the only assignable cause. Whenever it attacks women, which is but rarely, it is nearly always those who have led irregular lives. Dr. Dickson has observed that its subjects are almost invariably men who have had no children. If this be a rule, it may point to a hereditary origin, and also to a tendency to die out. He also inclines to the opinion that the excesses of the patients are more to be regarded as evidences of the disease than as causes.—The insanity which accompa- nies true epilepsy, and which is known as epilep-

tic insanity, has of late years received much attention, and many remarkable relations have been established between it and other diseases and insanity, especially that form called impulsive insanity. The tendency to epilepsy is hereditary, although it may be produced by blows on the head and other injuries to the brain. It has been found to have strong relations to paralysis, to chorea, and also to phthisis, which are indicated by the fact that children of tuberculous parents may inherit epilepsy, chorea, or paralysis, and *vice versa*; or insanity in offspring may follow these diseases in parents. These diseases may also follow each other in the same individual, an attack of mania appearing in place of epilepsy, the latter, however, being the primary disease. The investigations of Dr. Echeverria have aided in establishing many important facts in regard to the subject, which had previously received the attention of Delasiauve, Morel, Falret, Baillarger, Trouseau, and others. They comprised the examination of more than 700 epileptics, embracing a period of over 13 years. The recorded cases number 532, of which 267 were cases of epileptic insanity, comprising 141 males and 126 females. Out of these the causes were distinctly ascertained in 123 males and 104 females. Insanity, paralysis, or epilepsy occurred among the ancestors of 37 males and 46 females; among the ancestors of the 37 males there were 11 cases of phthisis, and among those of the 46 females there were 13 cases of phthisis. He found that epileptic insanity may have an intermittent, remittent, and a continuous form; the intermittent being characterized by periodical attacks of variable regularity, the remittent having only partial recovery of intellectual soundness between the epileptic paroxysms and maniacal attacks, and the continuous form presenting a permanent and unmodified condition of insanity. Dr. Echeverria does not find that the *petit mal* and the *grand mal* of epilepsy exercise so different an influence upon the violence of the succeeding maniacal attacks as has by some been supposed. The acts of the epileptic insane are always sudden and instantaneous, and beyond the control of the will; but it must not be assumed that the mania which causes the acts is itself instantaneous. He thinks that most of the cases of *mania transitoria* are those of epilepsy or epileptic insanity. Epileptic insanity is of a violent and dangerous character, with strong homicidal tendencies, and is remarkable from the fact that the patient during his maniacal excitement, which may last for hours, and during which he may be wandering around, is wholly unconscious. (See also Maudsley, "Responsibility in Mental Disease," 1874.)—The aphasia which occurs in certain cases of insanity is believed by many to have found an explanation in the experiments of Dr. Ferrier of King's college, London, which are regarded as strong evidence of the localization of cerebral functions; but the correctness of this conclusion is

denied by Dr. Brown-Séguard in a paper read before the national academy of science at Washington in April, 1874.—*Dementia*, or loss of mind, may be primary, or it may be secondary to other forms of insanity, as mania, general paralysis, epilepsy, and more rarely melancholia, and differs from idiocy and imbecility in not being congenital. It is the inevitable stage into which degeneration of brain tissue, if continued long enough, always passes, and is of course incurable, the only treatment being that directed to the general health, and when possible ministering to the comfort of the sufferer.—*Idiocy and Imbecility*. The great difference between these conditions is, that though they are both congenital, the subjects of the former have badly shaped and deficiently developed brains, while those of the latter are usually well shaped, but fail in consequence of congenital pathological conditions similar to those found in dementia. This condition is to a certain though less extent also found in idiots, but many of them are more susceptible of mental cultivation than imbeciles, because the brain of the idiot may be somewhat developed by exercise. (See Idiocy.)—*Pathology of Insanity in general*. The subject of an attack of acute mania may die in a week from the commencement. A post-mortem examination shows the cerebral membranes congested; the sinuses and the veins of the pia mater may be full of blood, and there may be effusion of serum beneath the arachnoid and the serous membrane. In those who have had previous attacks or who have been partially insane there is often thickening of the bones of the cranium, with adhesion and thickening of the dura mater, indications of a chronic inflammatory condition. The brain will present discolored patches of a pink or purple hue, and also softening. The cells, nerve tubes, and connective areolar tissue may also be found more or less changed. Blood cysts are often found in the cavity of the arachnoid, and extravasated blood on the surface of the convolutions and in the cerebral substance. In cases of chronic mania and dementia there are usually more definite changes. The nerve cells are altered in character, and the nerve tubes leading from them are shrunken and sometimes disconnected. The inferior tissues are increased, and abnormal tissues take the place of those that are healthy, interfering with the functions of that which remains. The wasting of the brain is an important pathological condition. There is a loss of substance, the brains of the insane weighing less in proportion to the cavity of the cranium than in other cases. Dr. Lockhart Clarke has pointed out peculiar and numerous cavities in the white substance of the convolutions and of the optic thalami of the brains of chronic maniacs and the demented, and also in those who have died of general paralysis. These cavities are generally regarded as widened perivascular spaces, formed by the dilatation of the perivascular canals which surround the blood ves-

robably the adventitious tunic of Virchow. They are called perivasculous cavities, and present the appearance of holes seen in rubber cheese. They are generally empty, with smooth walls, without any lining membrane, but some of them containing the vesicles of blood vessels, with a few granules of cholesterine. Drs. Batty, Tuke, and Rutherford also observed holes differing somewhat from these, which, from their ragged edges, they regard as produced by a solution of continuity of brain tissue, or to extravasation and subsequent absorption of blood. The folds of the corpora striata and other nervous matter, and of the convolutions, are found in places of pigmentary degeneration, and some in places of this fatty degeneration. Rindfleisch, Rokitansky, Wedl, Tuke, and Rutherford have pointed out hypertrophy of the connective tissue in long standing cases of insanity, particularly in the cortical layers of the brain in general paralysis. Increase of connective tissue was at one time thought to be peculiar to dementia following chronic alcoholism, as well as that which is consecutive to syphilis and in congenital idiocy. Schroeder van Kock found dark pigmentary degeneration of the ganglionic cells of the hypoglossal nerve, and of dementia after mania, where there is cerebral paralysis of the tongue. Pigmentary changes of a like nature have been found in the retina, in what is called *retinitis pigmentosa*; and it is an interesting fact that it occurs in members of the same family here there is common deficiency of dentin. A pathological condition has been described in general paralysis by Drs. Poincaré and Bonnet, which it is thought will throw light on the nature of this peculiar disease. They have found brown pigmentary degeneration in the ganglionic cells of the whole of the great sympathetic nerve, to a degree greater than in other cases. In the abdominal and thoracic ganglia they found a substance of adipose cells for nerve cells, and are led to believe that this is the starting point of the disease. A remarkable morbid change sometimes found, called the insane's *hematoma auris*, caused by an effusion of blood between the perichondrium and cartilage, which without bursting shrinks away and leaves the ear shrivelled, is a peculiar and ought certain evidence that the person has at some time been insane. The subject received particular attention from Dr. E. T. Wilkins, while special pathologist to the New York State lunatic asylum at Utica; and from his investigations, which were published in the *American Journal of Insanity* for July, 1871, he established the following general conclusions. Preceding the appearance of the disease (rarely both) of the ears becomes swollen, the face and eyes of the patient at the same time indicating strong degeneration of blood to the head. Sometimes,

however, the redness is absent, while the tumefaction is caused by an œdematous state of the auricle. In the course of a few hours, or it may be several days, an effusion of blood appears on the concave surface of the auricle, varying in size from a bean to a hen's egg, in the latter case obliterating the natural ridges and depressions. Although apparently hard and unyielding, a careful examination detects a feeling of fluctuation and sometimes slight crepitation, supposed to be owing to the breaking up of blood clots. The skin is smooth and distended, and of a purple color, except that of the lobe, which is unchanged. If the skin is ruptured, clotted blood escapes; and if left alone, the opening closes and the sac refills. If kept open, however, a sero-purulent discharge takes place, which may continue for a long time, exudation of plastic lymph occurring in the mean time, uniting the walls of the cavity, and by subsequent contraction of the cicatrix producing the peculiar shrivelled appearance which is the sequence of the acute affection. When the sac does not become ruptured, much less deformity results. Examinations of the pulse of the insane have revealed some remarkable characteristics, which are described in the article *PULSE*.—*Enumeration of the Insane*. The following table of the insane in various countries, compiled from the report of Dr. E. T. Wilkins, commissioner in lunacy for the state of California, made in December, 1871, contains the most complete synopsis of information that can be procured at the present time:

COUNTRIES.	Date of formation.	No. of institutions.	No. of insane in institutions.	Total number of insane.	Total population.
United States.....	1870	66	15,792	37,882	38,555,988
England.....	1870	176	85,915*	54,718*	22,090,168
Scotland.....	1870	46	6,685*	7,571*	3,222,837
Ireland.....	1870	44	10,258	17,194	5,195,336
France.....	1866	99	81,992	50,726	37,985,965
Italy.....	1864	..	8,191	..	24,265,920
Prussia.....	1864	59	5,740	16,929	19,252,869
Other German states.....	1864	64	10,565	..	13,747,637
Austria (proper).....	1864	18	8,215	..	13,600,000
Bavaria.....	1864	11	1,550	4,899†	4,867,440
Belgium.....	1865	51	5,431	7,451	4,954,451
Holland.....	1868	12	8,179	..	8,762,415
Denmark.....	1860	..	..	5,185	2,605,094
Sweden.....	1860	..	1,271	7,512	8,850,728
Norway.....	1864	5	557	..	1,668,264

TABLE OF INSTITUTIONS FOR THE INSANE IN THE UNITED STATES.

LOCATION.	When opened.	Character.	No. of patients at close of 1873.		
			Male.	Female.	Total.
Augusta, Me.....	1840	State.....	205	206	411
Canaan, N. H.....	1842	State.....	140	127	267
Brattleboro, Vt.....	1836	Corporate..	237	233	470
Somerville, Mass.....	1818	Corporate..	50	51	101
Boston, Mass.....	1839	City.....	106	91	197
Taunton, Mass.....	1853	State.....	238	196	434
Worcester, Mass.....	1832	State.....	208	261	469
Northampton, Mass.....	1857	State.....	210	220	430
Providence, R. I.....	1845	Corporate..	65	64	129

\* Including idiots. † In 1861.

Table of Institutions for the Insane—continued.

LOCATION.	When opened.	Character.	No. of patients at close of 1874.		
			Male.	Female.	Total.
Middletown, Conn.	1866	State	175	220	395
Hartford, Conn.	1824	Corporate	74	74	148
Litchfield, Conn.		Private			
Bloomington, N. Y.	1821	Corporate	64	105	169
Blackwell's Isl'd, N. Y.		City	25	1,049	1,074
Ward's Island, N. Y.	1861	City	559		559
Ward's Island (emigrant), N. Y.		State	95	69	164
Flushing, N. Y.	1845	Private	14	13	27
Flathush, N. Y.	1855	County	257	431	688
Poughkeepsie, N. Y.	1872	State	91	94	185
Troy, N. Y.	1859	County	34	57	91
Utica, N. Y.	1843	State	294	256	550
Willard, N. Y.	1869	State	817	458	1,275
Anburn (criminal), N. Y.		State	77	9	86
Canaanidaqua, N. Y.	1855	Private	37	35	72
Middletown, N. Y.	1874	State Homeopathic			27
Trenton, N. J.	1847	State	318	340	658
Pennsylvania Hospital for Insane, Philadelphia	1841	Corporate	210	206	416
Friends' asylum, Philadelphia	1817	Corporate	42	86	128
Almshouse, Philad'a.		City	441	582	1,023
Harrisburg, Pa.	1851	State	216	192	408
Danville, Pa.	1872	State	107	59	166
Dixmont, Pa.	1857	Corporate	251	199	450
Burn Brae, near Philadelphia		Private	15	10	25
Mount Hope, Md.	1842	Corporate	105	144	249
Catoonsville, Md.	1872	State	70	57	127
Washington, D. C.	1855	National	468	152	620
Williamsburg, Va.	1773	State	115	158	273
Richmond, Va.	1870	State	92	102	194
Staunton, Va.	1825	State	151	133	284
Weston, W. Va.	1864	State	151	188	339
Raleigh, N. C.	1856	State	124	118	242
Columbia, S. C.	1827	State	154	155	309
Milledgeville, Ga.	1841	State	294	270	564
Tuscaloosa, Ala.	1860	State	168	162	330
Jackson, Miss.	1855	State	150	154	304
Jackson, La.		State	76	89	165
Austin, Tex.	1861	State	60	55	115
Nashville, Tenn.	1848	State	188	184	372
Hopkinsville, Ky.	1854	State	202	120	322
Anchorage, Ky.	1873	State	87	65	152
Lexington, Ky.	1824	State	284	244	528
Carthage, O.	1860	City	275	302	577
Athens, O.	1874	State			
Dayton, O.	1855	State	262	298	560
Newburgh, O.	1855	State	137	118	255
Kalamazoo, Mich.	1859	State	157	148	305
Indianapolis, Ind.	1848	State	267	207	474
Jacksonville, Ill.	1848	State	235	237	472
Elgin, Ill.	1871	State	107	65	172
Anna, Ill.	1874	State			
Batavia, Bellevue pl., Ill.	1867	Private		30	30
Madison, Wis.	1860	State	149	165	314
Oshkosh, Wis.	1873	State	102	108	210
Mount Pleasant, Ia.	1861	State	273	222	495
Independence, Ia.	1872	State	57	56	113
St. Peter, Minn.	1866	State	159	144	303
Fulton, Mo.	1851	State	174	129	303
St. Louis co., Mo.	1865	County	129	170	299
St. Vincent's (St. Louis), Mo.		Corporate	115	98	213
Lincoln, Neb.	1871	State	32	21	53
Ossawatimie, Kan.	1866	State	98	81	179
Stockton, Cal.	1853	State	332	324	656
Portland, Oreg.		State	119	48	167
Steilacoom, W. T.	1872	State	29	7	36

—See the works of Thomas Arnold, P. H. Pinel, James Cowles Prichard, E. Esquirol, J. Haslam, J. Conolly, Pliny Earle, J. Thurman, Brierre de Boismont, F. J. Broussais, Feuchtersleben, Georget, and Bucknill and Tuke; "Medi-

\* 1872.

† 1870.

cal Jurisprudence of Insanity," by I. Ray (Boston, 1838, and later editions); "Medical Jurisprudence of Insanity," by D. Tilden Brown, in Beck's "Medical Jurisprudence;" "Mental Pathology and Therapeutics," by W. Griesinger, translated from the German (London, 1867); "Insanity and its Treatment," by G. Fielding Blandford (Philadelphia, 1871); "Physiology and Pathology of the Mind," by Henry Maudsley (London, 1872); "Insanity and its Relation to Crime," by W. A. Hammond (New York, 1873); "Contributions to Mental Pathology," by I. Ray (Boston, 1874); "Medicine in Relation to Mind," by J. Thompson-Dickson (London, 1874); "Responsibility in Mental Disease," by Henry Maudsley (New York, 1874); "Mental Physiology," by William B. Carpenter (London, 1874); "West Riding Lamentic Asylum Reports;" "Journal of Mental Science" (London); "American Journal of Insanity" (Utica, N. Y.); and the *Annales Médico-psychologiques* (Paris).

**INSECT FERTILIZATION.** It has long been a matter of common observation that many plants, with their stamens and pistils in separate flowers, whether monoecious or dioecious, depend upon insects for their fertilization; the insects, in their visits from flower to flower in search of honey, evidently bring the pollen from the anthers of the staminate to the stigmas of the pistillate flowers, as every gardener knows who has tried to keep his varieties of melons and other plants of the same family in a condition of purity. Darwin, in his work "The Fertilization of Orchids" (London, 1862), showed that many perfect flowers, with their pistils and stamens in close proximity, are so



Section of Iris.

constructed that the pollen can never without extrinsic aid reach the pistil of its own flower, or serve to fertilize that of any other flower. He showed that there is a complete provision that the flowers of many orchids should never

are fertilized by their own pollen—in other words, that in-and-in breeding is impossible—had arrived at the conclusion that cross fertilization is necessary among flowers of the same species, in order to promote the greater vigor of the whole, and to prevent the perpetuation and fixation of individual peculiarities. This subject has since received the attention of many close observers, and many interesting notes have been established. It has been found that in perfect or hermaphrodite flowers, which were supposed to be especially arranged for self-fertilization, the stamens and pistils, while close together, are really so placed with reference to one another that self-fertilization is almost impossible, and unless insects come to their aid no seed will be produced. It is another interesting point that flowers needing the aid of insects are supplied with an attraction or them in the form of nectar. In most flowers the pollen is a fine dust which readily adheres to whatever it touches, and the contrivances to prevent the pollen of a flower from reaching its own pistil are no more varied and interesting than those which insure that a bee or other insect shall come in contact with this pollen and carry it off upon its body. To illustrate this, an engraving (from Gray) of a section of the flower of a common iris or lower-de-luce will serve. In this there are three recurved outer petals and three erect inner ones, united below in a tube; the pistil has three styles, which are broad, petal-like, and notched at the top; each style bears just below the notch a stigma, which is a thin plate projecting like a little shelf, the upper side only of which is stigmatic, or capable of receiving pollen; below each stigma is an anther, as seen in the engraving. Here the stamen and pistil are not only in the same flower, but in actual contact; yet while everything appears favorable for the pollen to reach the stigma, it cannot do so of itself, for the anther or pollen case has the openings through which it discharges pollen turned outward, and the stigma is above and its receptive portion turned away from the anther. When an insect visits this flower, it can only get at the honey by crawling in under the petal-like style, and in so doing, as well as in making its exit, it must rub against the anther and become dusted with pollen; when the insect thus charged with pollen goes to another flower, it must, in its attempts to get under the style to reach the honey, dust some of its pollen upon the upper surface of the shelf-like stigma. To explain the many ways in which this plan is varied would require a volume; the curious modifications of it in only a portion of a single family, the *orchidaceæ*, fill a book of over 350 pages. The common barberry has irritable stamens, and the laurel (*Kalmia*) has its stamens bent like a spring, the anthers being caught in notches in the corolla, but when disturbed the bent filaments spring toward the pistil with force. These were both regarded as admirable

contrivances for bringing the pollen in contact with the stigma, but closer observation has shown that these sensitive stamens scatter their pollen rather on the insect which irritates them than on the pistil of their own flower. In order to insure cross fertilization in many cases, the stamens discharge their pollen before the pistil is sufficiently mature to receive it, or *vice versa*. Dichogamous is the term adopted to express this unequal perfection of stamens and pistils, of which the common plantain (*plantago*) affords an illustration. Flowers alike in all other respects are often dimorphous as to their stamens and pistils; primroses in the garden and the wild bluets (*Houstonia*), so common in spring, furnish examples. In these flowers the corolla has a long tube and an expanded limb. In some of the flowers the stamens appear at the throat of the corolla, while the style is very short; in others the style projects, and the stamens are low down in the tube. In either case self-fertilization is not likely to occur, but an insect with a long proboscis has an ample opportunity to effect cross fertilization. There are also trimorphous flowers, in which there are three kinds of stamens and styles as to length, admirably adapted to secure service from the different kinds of insects that visit them. Sometimes the insects suffer from the performance of this service; the pollen of the milkweeds (*asclepias*) is in waxy, pear-shaped masses, joined in pairs with an adhesive attachment to the little stalk which unites them. Did not the legs of the insects in search of nectar come in contact with this adhesive attachment, and by its means draw the pollen masses from their pouches, the pollen could never reach the stigma; it often happens that bees have their legs so encumbered by these adhering pollen masses, that when they reach the hive they are unable to climb upon the comb, but fall down and perish on the bottom of the hive. Some interesting experiments show that in many flowers where there is evident provision for self-fertilization, the stigma can hardly be impregnated by pollen from the same flower, while it will readily accept that produced by another flower, and that the agency of insects is absolutely essential to the production of seed in quite perfect flowers.—Excellent memoirs on this subject have appeared in "Nature," the "American Journal of Science and Arts," and the "American Naturalist." A useful résumé for young people is given in Prof. Gray's "How Plants Behave" (New York, 1872). The work of Darwin already referred to is admirable as showing how such investigations should be conducted.

**INSECTIVORA**, an order of mammals, separated from carnivora, feeding wholly or principally on insects, their teeth being studded with sharp points, feet short and plantigrade, often fitted for digging, and with perfect clavicles. The principal families are the hedgehogs, moles, and shrews, which have been described in their alphabetical order.



**INSECTIVOROUS PLANTS.** In the article DIONÆA the structure of the Venus's fly-trap has been described, and the recent discoveries in relation to its action have been briefly stated. The leaves of the *dionæa* present a beautifully designed and most efficient insect trap, and while the fact of its catching insects had long been known and wondered at, it has only within a few years been demonstrated that the plant does not catch insects for amusement, but food. The insectivorous propensity is more strikingly manifested in *dionæa* than in any other plant, and it is provided with a specially devised apparatus for its gratification; but there are other plants which destroy insects, and what is known of *dionæa* has put naturalists upon a course of observation. The *drosera* or sundew, some species of which are found in almost all parts of the world, has its leaves studded with short hairs, each of which is tipped by a little globule of a clear liquid which, though it looks like a drop of dew, is so viscid as to be able to hold fast a small insect that alights upon the leaf. Dead insects upon the sundews have long been noticed, but their occurrence was considered accidental. It is now known that sundews capture insects with a motion quite certain in its results. When an insect is caught by one or more of the sticky hairs, the other hairs upon the leaf incline toward it, and bring so many adhesive points in contact with it that escape is impossible; and the leaf itself curves and partly envelops the prey. In the case of one long thread-leaved sundew (*D. filiformis*), the leaves actually coil around the insect. As in the case of *dionæa*, the action is excited by a piece of beef as well as by an insect, but to an inorganic substance, as a bit of chalk, it is indifferent. The observations of Mrs. Treat ("American Naturalist," Salem, Mass., December, 1873) show that when a fly is pinned at the distance of half an inch from the leaves, they will bend toward and reach it. The sarracenias or pitcher plants, of which there is one species in the northern states and several in the southern, all have tubular leaves which contain water in which are found great numbers of dead insects. It is known that in some species at least there is near the opening of the pitcher a sweet secretion, which would appear to be placed there for the purpose of attracting flies and other insects; indeed, the whole structure of the leaves of these plants shows that they are designed as insect traps. The water, which in some species may be caught from the rains, is in others secreted by the plant, as the orifice is so covered by a hood that none can fall in; the interior surface of the pitcher-like leaves is mostly covered with fine sharp bristles which all point downward, and render it almost impossible for an insect that is once within to escape; if we add to this the attractive sweet liquid at the mouth of the pitcher, which has been observed in two species, we have a very complete insect

trap; indeed, the large leaves of the species called trumpets (*S. flava*) are said to be used in houses as fly traps. The abundance of dead insects in the leaves of those pitcher plants which are protected by a hood may be cited in evidence that their habitual drowning of them is not accidental, but that the apparatus is intended to capture and destroy them. When the contents of one of these pitcher leaves is examined there are found insects in all stages, from those recently caught to those so far decomposed as to make it impossible to identify them. The leaves of the related California pitcher plant (*Darlingtonia*) are most effective traps; according to Mr. Robinson, the tubular leaves are for a good portion of their length filled with a nearly solid mass of putrescent insects. The opinion that the animal matter thus abundantly secured by these plants serves to nourish them, though not demonstrated, is highly probable.

**INSECTS**, six-footed articulated animals, the most beautiful, most active, and most highly organized of the invertebrata, in which, anatomically considered, they bear a remarkable analogy to birds among the vertebrates. Like birds they inhabit the air, earth, and water, have an extensive respiratory apparatus, and consequently a higher calorific and motor power than any other invertebrates. The number of species and of individuals is exceedingly great, and their metamorphoses are among the most interesting phenomena in nature. The class of insects includes all articulates having a distinct head, thorax, and abdomen, with antennæ, three pairs of feet, an aerial respiration by means of tracheæ, a feebly developed circulating system, almost all being winged and undergoing transformation. The cutaneous envelope forms a kind of external skeleton, generally of a horny consistence, formed principally of chitine; it is made up of a considerable number of pieces more or less movable on each other, and is frequently provided with hairs, which are sometimes sharp and barbed (as in the processory caterpillars), producing considerable irritation when introduced into the human skin. The limbs, which are appendages of the thorax, are hollow tubes containing the muscles and nerves for their motion. The first segment constitutes the head, on which are placed the antennæ, the eyes, and the oral appendages. The antennæ are composed of a variable number of joints, generally resembling delicate and flexible horns, plumed, serrated, clubbed, or foliated, according to genera and families; they are principally organs of touch. The mouth in the chewing insects, like the beetles, cockroaches, and grasshoppers, consists of an upper middle piece or *labrum* with a mandible on each side, the latter being very hard, often toothed at the extremity; the *maxilla* or under jaws are softer and of many pieces, with maxillary jointed palpi, and the central piece is the *labium* or under lip, also supporting jointed palpi. At the base of the

lip is attached the tongue, which in some is abortive and in others long and into a suctorial organ. In the sucking insects the under lip is transformed into a closing delicate lancet-like filaments or modifications of the mandibles and ; in the *hymenoptera* (bees, &c.) the lip is intermediate between the chewing and suctorial, having parts belonging to both. In the *lepidoptera* (butterflies, &c.) the palpi are very small, but the under jaws are enlarged each into a semi-canal which may be divided up spirally. The eyes are either simple or compound, the first occurring chiefly in the larvæ of the metamorphic orders, and in perfect insects; some have both in the perfect state, and some adults and pupæ are blind. The compound eye is made up of many simple eyes, each with its cornea, conical vitreous body, pigmented nervous filament; the number of ommatidia is sometimes more than 25,000. Simple eyes (*stemmata*) consist of a cornea lodged in an expansion of the optic nerve and a surrounding pigment layer; they are placed either on the sides of the head, or in groups on the vertex. The thorax consists of the legs and wings, and consists of three rings, called respectively *prothorax*, *mesothorax*, and *metathorax*, each bearing a ventral arch a pair of legs; the wings are on the dorsal aspect of the two posterior. The limbs consist each of a trochanter, a femur, a tibia, a leg, and a kind of finger consisting of two to five joints terminated by claws; in the jumpers, like the grasshopper, the hind legs are very long and muscular; in the swimmers, like the water beetles, the legs are flattened, ciliated, and arranged for propulsion; in the flies, the feet are provided with claws and hooks by which they are enabled to cling to smooth surfaces; the antennæ are often enlarged, as in the mole cricket, which dig in the ground, and armed with spines, as in the mantis, which uses them to seize its prey; in some of the butterflies the limbs are mere rudiments, useless as organs of progression. The wings are membranous, rendered firm by solid veins; there are never more than two in each segment, one or the other may be wanting; in the butterflies they are covered with a coat consisting of microscopic scales; in the beetles the first pair becomes thick and forming the *elytra*, which cover and protect the second pair; the wings are sometimes membranous, half corneous, at others ditto barbed plumules, or wanting and replaced by the knob-like balancers. The legs are moved by striated muscles, attached directly to the cutaneous skeleton; in the flies the wings of the *diptera* have their venation separable into series of disks, the assemblage of which gives rapidity to their movements being dependent on alternate contraction and relaxation. The abdomen is composed of rings

movable upon each other, sometimes to the number of nine; they bear in the perfect insect neither legs nor wings, but are provided with various appendages useful in the economy of the animal, as the delicate bristles of the ephemera, the nippers of the earwig, the spring of the podurella, the sting of the bee and wasp, and the ovipositor of the grasshopper and the ichneumons. Besides the antennæ, the palpi about the mouth, the end of the suctorial tube, the ovipositor, and the feet in some instances, are delicate organs of touch; the tongue, when present, as in bees and flies, is undoubtedly the seat of an acute sense of taste. Though insects apparently perceive by the sense of smell what food is proper for themselves or their young, the seat of this sense has not been satisfactorily determined; Duméril and Cuvier, reasoning from analogy, concluded that it was placed at the openings of the respiratory tracheæ; Huber, from his experiments on bees, placed it in the mouth, Kirby in the anterior portion of the head or the nose, and others in the antennæ and palpi. Hearing is acute in many insects; the shrilling of the locust, the tick of the deathwatch, the song of the cricket, &c., would be useless unless they could be heard by their companions; in the *orthoptera* especially an auditory apparatus is connected with the stigmata of the thorax and the anterior legs; the sense has also been placed inward at the base of the antennæ. The sounds of insects are produced by the friction of one part of the external skeleton on another, by the vibration of special organs, or by a particular soniferous apparatus, always due to the action of voluntary muscles and unconnected with the respiratory system; the buzzing of flies seems to depend on the rapid vibrations of the thorax during flight and on the passage of air through the thoracic stigmata, perhaps intensified by the motions of the wings themselves; some beetles produce a sharp sound by rubbing the last abdominal segments against the curved points of the wing covers, or the thoracic rings against each other; the sounds of butterflies and of the death's-head moth are referred to friction of the hips together, and to various causes not at all satisfactory. The nervous system consists of a brain and spinal cord; the former is constituted by the ganglia which embrace the œsophagus, and is situated in the first segment; the spinal cord is made up generally of a double series of ganglia united by longitudinal cords, in number corresponding to that of the segments of the body; the three thoracic ganglia are much the largest, and from them are given off the nerves to the legs and wings. The alimentary canal is generally complicated and more or less convoluted; it consists of a pharynx, œsophagus, first stomach or crop, second or gizzard with muscular walls for trituration, third or chylific ventricle of soft and delicate texture, a small intestine, cæcum, and rectum; as in the higher animals,

it is shortest in the carnivorous families, and very long in the vegetable feeders; it is kept in place by numerous fine tracheæ which envelop its whole extent; in the sucking insects there is only a sucking stomach opening from the œsophagus, into which the fluid food is first taken, as in the first stomach of ruminants. The anus opens on the last segment, except in some non-feeding pupæ, in which both it and the mouth are wanting; the salivary glands are well developed, opening into the pharynx; the villosities of the third stomach seem to secrete a gastric juice, the biliary secretion being poured into this cavity; the office of a liver is performed by cæcal appendages lying upon the ventricle; similar organs on the small intestine sometimes perform the office of a pancreas. An adipose tissue is found in all insects, especially toward the end of the larva state, gradually disappearing in the perfect condition, freely traversed by trachean branches; the fatty contents are intimately connected with the functions of nutrition. The circulatory system consists of a contractile chambered dorsal vessel which serves as a heart, and a cephalic aorta which conducts the blood into the body; the blood moves from behind forward, and passes from the aorta all over the system, forming regular currents without vascular walls, and returning as venous blood to the lateral vessels; the blood is usually a colorless liquid, containing a few small oval corpuscles. Respiration is carried on by a system of tracheæ spread through the entire body, which open externally by stigmata, and admit air either directly or by means of lamelliform or tubular prolongations which have been compared to branchiæ; they divide into branches, gradually becoming smaller, ending cæcally, so that the air passes out by the same way that it enters. The branchial tracheæ are found in certain aquatic larvæ and pupæ, and never in the perfect insect; they do not communicate externally, but the air is received by endosmosis and exosmosis. The stigmata of the pulmonary tracheæ are usually bordered with a fringe of hairs, and can be opened and shut by internal muscles, whose action gives to the abdomen of many insects well marked movements of respiration; there is generally a pair on the upper portion of the interstices between the rings, being wanting between the head and prothorax and the last two abdominal segments; the tracheæ are often dilated into large reservoirs of air. Respiration is very active in insects, and performed by the movements of the abdominal segments; they require a great deal of air, and are very quickly asphyxiated by deprivation of oxygen; though not producing much animal heat ordinarily, sometimes, as in the bees when hived, the respiration is accelerated and their temperature perceptibly elevated. The Malpighian vessels, which were formerly supposed to be biliary, are now ascertained to be urinary organs, secreting uric acid products; they are small convoluted tubes,

yellowish or brownish, and open into the posterior extremity of the stomach. Many insects have secretory follicles just under the skin, whose ducts open between the segments or between the joints of the limbs, or by the side of the anus; the fluid secreted is generally of a disagreeable odor, and sometimes, as in the bugs, very fetid. The females in many of the *hymenoptera*, as the bees and wasps, have a glandular apparatus in the anal region, which secretes an irritating poison introduced into the tissues of their enemies by their hollow stings. Most insects undergoing a complete metamorphosis have in their larva state silk organs, whose secretion they use in the formation of their cocoons and webs; they consist of two long, flexuous tubes on the side of the body, continuous in front with two small excretory ducts opening on the under lip; in a few the silk is spun from a spinneret projecting from the anus; the wax-secreting apparatus has been described under *Bees*. The sexes are distinct, and the females often differ greatly from the males, as in the glow-worm; among the bees and ants the females are much less numerous than the males, and certain individuals of neither sex, or neuters, do the work and protect the colony. Most insects lay eggs, though a few, like the *aphides*, are viviparous; by means of an ovipositor many introduce their eggs into a deep-seated nidus, in or near which the young can find the food suited for them, almost always different from that required by the parents. There are generally two symmetrical ovaries and testes, situated in the abdominal cavity, and two oviducts uniting into a single one at the posterior end of the body. In their progress to maturity insects change their skins many times, and many of them undergo transformations as singular as those already mentioned in the frogs; on coming from the egg they are very different from their parents and from their pupa forms. Before arriving at their perfect state they usually pass through the larva and pupa form, which may be entirely different, or vary chiefly in the development of wings, according as the metamorphosis is complete or not. Insects with complete metamorphosis when they leave the egg or are in the larva state are more or less worm-like, with an elongated soft body divided into movable rings, normally 13 in number, sometimes with and sometimes without feet; in no respect do they resemble the parents; the eyes are generally simple, and occasionally absent; the mouth is almost always armed with jaws for chewing, even in insects which are sucking in the perfect state; these larvæ are called caterpillars or maggots, according to their size, form, and habitat. After remaining in this state, either in the water, in the air, or under ground, a certain length of time, varying according to the species, and undergoing several moults, rudimentary wings form under the skin, and they change into nymphæ, chrysalids, or pupæ; the

larval condition persists sometimes for several months, as from the autumn to the following summer, and in the case of the harvest fly a much longer period. Larvæ are generally voracious and active, but nymphs are generally motionless and do not eat; sometimes the larval skin hardens into a shell-like covering for the nymph; at others a thin inting pellicle applied to the body permits the larva to be seen through it. Before undergoing this change the larva often prepares a shelter, making a cocoon of silk secreted by itself; the nymph may be suspended from a twig by thin filaments or concealed in some crevice. In the nymph state growth takes place rapidly, and the form of the future insect is gradually assumed. The metamorphoses are easily traced in the common caterpillars, the bee, the mosquito, the fly, and the silkworm. The life of the perfect insect is short, enduring at most for the summer months, until the work of reproduction is completed; in the *ephemera* the adult state continues for a few hours only. Instances of incomplete metamorphosis may be mentioned the cockroach, the cricket, the grasshopper, and other *orthoptera*, in which the larva differs from the perfect insect principally in the absence of wings. For further details on larvæ and pupæ, the reader is referred

CATERPILLAR, CHRYSALIS, and the various orders in their respective order.—As insects furnish food for a great variety of vertebrate and invertebrate animals, their extermination would ensue were it not for their astonishing cunning, paralleled only in the case of fishes; female *termes* (ant) has been estimated to lay about 90,000 eggs in a day; the queen bee deposits between 5,000 and 6,000, the common wasp about 1,000 less, the wasp about 3,000; a sterility of 1,000 in one generation is common; in the silkworm the average is 500; the bees are far less prolific. Réaumur observed 40 young ones developed from the numerous eggs of a moth (*phalæna*), many of which died as caterpillars, so that only 65 females reached the perfect state; these were calculated to produce the following year 22,750, which in the next would produce 1,500,000. A single plant of *aphis*, which brings forth a numerous progeny, but only one at a time, according to the above author's calculation, would produce the fifth generation about 6,000,000,000, the next great-grandmother laying eggs when the 10th member of her descendants is capable of reproduction, without contact with the male.—The muscular activity of insects is very great, whether in leaping, swimming, flying, digging, carrying weights; no mammal can leap in proportion so high or so far as the flea, to a distance more than 200 times the length of its body; no bird has a facility of motion, and a rapidity and endurance of flight, comparable to those of insects. The wings of the butterfly have been found to display the structure ascertained by civil engineers to combine the greatest lightness with the greatest

strength; in the nervure of the wing, as in the strongest beam, the utmost possible material is thrown into the flanges, and the upright support is as thin as practicable; in the hollow nervures we have two flanges connected by the thin membrane of the wing, and the strongest nervure at or near the anterior edge. The apparatus by which many insects walk upon perpendicular surfaces is described in the article FLY. The larva of the ant lion digs its sand pit, and the fossorial wasp a hole for its eggs, in a very short time; a few ants are strong enough to drag from their hill a large caterpillar; a few burying beetles will place a mole under the earth in an hour, a feat equivalent to as many men burying a large whale in the same space of time; the gaddy is faster than the fleetest horse; a humblebee has been known to distance a locomotive going at the rate of 20 miles an hour, and a dragon fly to lead a swallow a weary chase of an hour, and at last escape. The instincts of insects, which sometimes closely border upon intelligence, are very remarkable, and calculated to excite the admiration of the most superficial observer. Insects apparently acquire knowledge from experience, possess the faculty of memory, and are able to communicate their purposes to their fellows; they evince great sagacity in their methods of procuring food and in defending themselves against their enemies; their devices for entrapping prey are very ingenious: to escape their enemies, some feign death, and others conceal themselves, fight bravely with their jaws and stings, and emit a nauseous odor or corrosive juices. As examples of insect instincts we need only mention those of the bee, wasp, and ant in constructing their habitations, of the silkworm, of the caterpillars (like *torrix* and the clothes moth) which roll up leaves or woolly materials for their protection, of insects which unite in communities for mutual protection and support, and of those which lay their eggs on substances most proper for their young, which they will never see, and which feed on matters entirely different from the food of their parents (as the wasps). In their adaptation of these instincts to accidental circumstances, they approach very near to intelligent acts. Insects have many passive means of avoiding their enemies in the form and structure of their bodies, and in their resemblance in color to the objects on which they live, whether ground or tree, as in beetles, grasshoppers, the mantis, and many bugs living on bark; the larvæ of tortoise beetles are spiny, others are hairy, and consequently avoided by insectivorous birds; hardness of integument and tenacity of life are also important means of preservation. The continuance of the species is secured by the strong sexual impulse, and by the care of the female in depositing her eggs in places where the future welfare of the young will be insured; the life of the insect generally ceases soon after the period of sexual activity;

among the social insects, the young are fed by the neuter and females. For details, see Kirby and Spence's "Introduction to Entomology."—The relations of insects to the rest of organic nature are very interesting and important. Most insects derive their food from the vegetable kingdom, to which they are both injurious and beneficial; by their simple agency not only is a limit set to the increase of plants, but their preservation is due in many instances to insect operations. Myriads of larvæ feed upon the roots, leaves, flowers, fruits, wood, and seeds of plants, not sparing the grains and vegetables most useful to man; the work of Dr. Harris on the "Insects Injurious to Vegetation" gives ample details on this point as far as the northern portion of the United States is concerned, and many of his observations are given in this work in the articles relating to these destructive creatures. On the other hand, fecundation in plants is often promoted by insects; butterflies, bees, wasps, flies, and bees convey the pollen to the female organs, and thus impregnation is effected in many cases where it would otherwise be unlikely to occur. Insects afford food for each other, for spiders, for many fresh water fishes, amphibians, reptiles, birds, and mammals; and the last two, with man himself, are infested with many parasitic insects. (See Erizoa.) The direct advantages derived from insects by man are not a few; many larvæ of beetles, grasshoppers, and locusts, South American ants, &c., are occasionally used as food by various savage tribes, the bee supplies honey and wax, the cochineal mummy and cochineal, the Spanish fly a well known blistering drug, the gall insects a valuable astringent, the silkworm a most valuable and beautiful material for clothing, &c.; and the larvæ of flies and many beetles are useful in removing decomposing animal matter. Insects are found everywhere, even on the surface of the ocean (*Hydromedusæ*), but they are essentially animals of the air; though a few may be seen in winter, most are active only in the other seasons, the winter is passed in a state of hibernation, either as eggs, larvæ, pupæ, or in a few instances as perfect insects; those of tropical regions are the largest, most numerous, and most gorgeously arrayed; they have been found within eight degrees of the north pole, but their geographical distribution has not received the attention it deserves; some are restricted within narrow limits, while others exist almost everywhere. Insects of a former geological æge are found in amber, a fossil resin, in most cases coming very near existing forms, and sometimes of being genera, the number of species thus found is considerable, and, though pertaining only to such as dwell in woods or on trees, it may reasonably be concluded that then, as now, the insect world was well filled, the beetles are well represented, the *Hydrophilæ* very abundant, the *Hydrophilæ* exceedingly rare, the *Hydrophilæ* and *Hydrophilæ* in very numbers

ous, and the *orthoptera* and *hemiptera* not common. Insect impressions have been described in the calcareous formations, especially such as might have been made by aquatic larvæ and insects; Dr. Hitchcock describes footmarks in the sandstones of the Connecticut valley as having been made probably by several genera of insects; and Prof. C. F. Hart has discovered near St. John, N. B., fossil remains of insects in the upper Devonian formation, which he considers the oldest known.—For the systematic classification of insects, and the history of the science, see ENTOMOLOGY.

**INSESSORES**, the perching birds, the most numerous of the class, differing from each other greatly in many respects, but agreeing in having three toes directed forward and one backward, neither armed with talons nor webbed. They have been divided by the German ornithologists into the suborders *strivora*, in which the hind toe may be turned forward, like the humming birds, swifts, and goatsuckers, with a feeble voice; *clamatoræ*, noisy, like the kingfishers and the flycatchers; and *oscines*, singing birds, in which the larynx has five pairs of muscles for the production of song. The last includes the thrushes, warblers, swallows, mocking bird, nightingale, lark, finches, sparrows, crows, and other birds noted either for their song or powers of mimicry or articulation.

**INSTERBURG**, a town of Prussia, in the province of East Prussia, capital of a circle of the same name, 58 m. E. of Königsberg, on the railway to Gumbinnen, and at the confluence of the Angerap and Inster rivers, forming the Pregel; pop. in 1871, 7,185. There are manufactories of beet sugar, wool, cotton, linen, earthenware, and leather, and an important trade in corn and linseed. The castle of Insterburg was founded by the Teutonic knights.

**INSURANCE**, in law, a contract whereby an insurer engages, for a consideration which is called a premium, to insure a certain party against loss of or injury to certain property by certain perils. The word peril here means not the danger but the happening of the event which was feared. When the contract is in writing, the instrument is called a policy of insurance. Marine insurance is the insurance of maritime property against maritime perils. Fire insurance is the insurance of houses or goods against fire. Life insurance (of which accident insurance, of recent origin, is properly a branch) will be separately treated under its own name. I. MARINE INSURANCE was wholly unknown to the Greeks and Romans, and to oriental nations. Chief Justice Coke (6 Rep. 47), about 1588, notices the practice of insurance as a mere novelty, and the first English statute which recognizes it is 43 Elizabeth, c. 22 (1601). But the 66th section of the laws of Wisby (a maritime code published probably about 1230) speaks distinctly of it. Some suppose this to be an interpolation; but it is at least possible that the practice of insurance was

more or less common among merchants centuries before it was recognized by the law. It is, in all events, no older than the late part of the middle ages; and it must be regarded as prominent among the many illustrations of that tendency to association which is at once the effect and the cause of our advancing civilization. By means of insurance the resources of many are aggregated for the protection of each. Merchants become members of what is often called, and by the universal practice of insurance becomes, the mercantile community. Each one pays over a part of his profits, so that he is not to inconvenience him, and thus obtains protection against a loss which would otherwise ruin him; and what he pays helps to form a common fund that indemnifies others. Hence, commerce is promoted and developed to an extent far beyond what would otherwise be possible, because enterprises become not only feasible but prudent by means of insurance, which without it would be so rash that only the reckless would undertake them. The law of insurance may be learned from the purpose of insurance. Thus, it is easy to say, as some do, that insurers should not be strict in their requirements, nor rest upon technical defences and the letter of the law. But all the losses paid by insurers must be paid out of premiums, or the business of insurance would stop; and these premiums must grow higher as the risk increases; and when they get so high as to be much beyond the actual risk incurred by prudent and substantial men who take care that their ships are what they should be, such men will no longer insure. Then the business of insurance will fall into the hands of the careless and the unprincipled, and then premiums must rise still further, and the mischief in this way confirms and enlarges itself. Instead of being a support to commerce, insurance will then only derange it, and be little better than legalized gambling. Similar principles will be seen, as we proceed, to be applicable to every part of the law of insurance; because the whole effort of the law is to make the business of insurance prudent and satisfactory, for merchants who transact a legitimate business honestly and carefully. Formerly much business was done by individual insurers, or underwriters as they are often termed from their subscribing the policies. Now, however, nearly if not quite all policies of insurance, in this country, are made by incorporated companies. These are of two kinds: 1, stock companies, where the stock is owned by persons who receive the profits (that is, the excess of premiums over losses) by way of dividends; 2, mutual companies, where the profits (deducting only the expense of transacting the business) are divided among the insured, or so applied to reduce the premiums that each insured pays only the equivalent of the actual risk. Some companies which operate on the mutual principle have also a certain amount of capital stock as a basis.—Large volumes are written about the law of insurance.

In this article we shall endeavor to exhibit only a brief and condensed statement of its leading principles. The contract of insurance ought always to be in writing; but it may be binding if only oral, unless the insurers are an incorporated company, forbidden by their charter to insure otherwise than in writing. An agreement to insure, entered and subscribed in the usual way in the books of the insurers, would generally be held to be a contract binding both parties to the terms usual in the common policies of those insurers. And it seems to be the settled law of the United States that a contract is made by letter, when either party, receiving a letter of proposals, puts into the mail an answer of acceptance, without having previously received a letter from the proposing party retracting his proposals. A policy is a very ancient instrument, and is substantially the same everywhere, but with special variations. It is subscribed only by the insurers, but the bargain binds also the insured if he accepts the policy and puts his property at risk under it. A policy may insure A specifically, or A "for whom it may concern," or use other equivalent words; and the effect of these words is to bring within the scope and benefit of the insurance every person interested in the property who authorized the insurance, and who was contemplated by A as being insured; or who, being so interested and contemplated, afterward in good faith adopts and ratifies the insurance. Sometimes the policy defines and exactly describes the property insured; sometimes it leaves this undetermined, but requires that it shall afterward be defined, in writing on the policy, as such or such property aboard of such or such a ship; the latter is called an open or running policy. Alterations made by agreement are valid, and are in practice often made and indorsed upon the policy. But a material alteration by the insured, without the assent of the insurer, destroys all claim against the insurer, and is said to have this effect although made in good faith, and with the expectation of obtaining his consent. An alteration by the insurers without the consent of the insured has no effect whatever. If there be a material mistake in the policy, courts having equity powers will sometimes amend it. A policy of insurance is not negotiable; yet, if transferred for value in good faith, the transfer may be so far valid (if not prohibited in the policy itself) as to give the assignee a right to sue in the name of the insured, or, in some states, in his own name, but always subject to any equitable defences which could be made against the insured. But an assignment or transfer of the property insured, before a loss, without a corresponding transfer of the policy with the consent of the insurers, destroys the claim of the insured, and gives none whatever to the assignee. If a loss has occurred, and a claim to indemnity vested in the insured, he may now transfer this claim. And if the bankruptcy of the insured transfers his property and with it

the policy to assignees, the insurers are still held; and on the death of an insured, the property and policy go to his legal representatives. Whatever is written on the face or back of the policy, and is referred to in the policy as a part of it, becomes a part of it; and so is a separate paper, if distinctly made a part by reference which amounts to an agreement. Policies which insure a person who has no interest in the property are called wager policies. They were formerly permitted, but are not legal or valid now either here or in England; it being a universal rule that the insured must have some interest in the property, and this interest must be at risk. If the policy be what is called an open policy, that is, if the interest be not valued therein, and a loss occurs, the insured proves his interest or the value of the property, and is paid accordingly. But the policy may be what is called a valued policy; that is, A may be insured "\$10,000 on the ship Orion, valued at \$20,000." This binds both parties, unless there be an over valuation so extreme as to be fraudulent, or to be equivalent to a wager policy. If A is insured as above, and the ship is totally lost, he receives \$10,000; but if the ship is partially lost, or injured to any one half of her value, then he receives \$5,000, because by causing himself to be insured only half of her agreed value he is considered as standing his own insurer for the other half. But if he be insured a round sum, without any valuation, he will receive the whole amount insured, provided he can show that he has lost so much by a peril insured against. The subjects of marine insurance are four—the ship, the cargo, the freight which the ship may earn, and the profits upon the cargo. Either may be valued, but it is common to value a ship, and not so common to value either of the other interests. If goods are valued, it is perhaps for the purpose of insuring the profits, by including them in the valuation of the goods, without insuring the profits under that name. It is not very common to insure profits by themselves; but when this is done, they are usually valued, although this is not necessary. If valued, and the goods are lost, the English courts require proof that they would have made some profit. In the United States the courts consider the loss of goods as implying the loss of some profits, and the valuation settles the amount. Any kind of interest will support an insurance, if it be such that a loss of the property will bring on the insured direct pecuniary loss. Any bailee of the property (or one having possession of it) may insure it if he have any interest in it or responsibility for it. If the property be mortgaged, both mortgagor and mortgagee have an insurable interest in it; so have factors on commission (or commission merchants), consignees, agents having possession, or carriers. The owner of the ship acquires an insurable interest in the freight it will carry as soon as he has retained the goods of another to be car-

ried, or has purchased goods to be carried on his own ship. It has made a distinct and obligatory contract with some one to send them, and his vessel is at all on the way to a port to receive them. The business of insurance is wholly void if the interest insured is illegal, or if a material and indispensable part of the contract or transaction is illegal, or if it distinctly contemplates an illegal act or act which is insured. But it is illegal a mere contrary to the laws of the country where the contract is made and is to be enforced. Thus, an insurance in America is never void intended to be smuggled and imported, and not be void in America, but would be in England. Some contracts of insurance are prohibited by the mere policy of the law, thus a mariner cannot make a valid insurance of his wages, because it is important that he should feel the danger of losing them if the ship is lost.—The subject of warranties in marine insurance is very important. These are promises of the insured that certain things exist or do not exist, or shall be or shall not be done; and if the promise is broken the contract is void, whether the promise is material or not, and whether the breach of the promise is the fault of the insured or not. And they must be exactly complied with, though the warranty will be construed reasonably, and according to the usage of merchants and insurers, and the best and actual intention of the parties. The warranty may be express or implied by law. If express, it must be written on or in the policy, or by distinct reference made a part of it. Any distinct assertion amounts to a warranty; if the ship be described as "the American ship Flying Cloud," this is a warranty that she is American. Express warranties are most usually: 1, of ownership; 2, of national character; 3, of the lawfulness of the goods or voyage; 4, of the taking of convoy; 5, of the time of sailing. There are also some implied warranties; but by far the most important of these is the universal warranty of seaworthiness. Every person who proposes to insure to insure his ship, engages and warrants that his ship is in every respect in a safe and suitable condition to encounter all common perils and dangers on the voyage or in the place where she is to be while under insurance. The insurers may expressly waive this warranty, but this is very seldom done; and whenever it exists, there it is a condition precedent to the obligations of the insurance; that is to say, if this warranty be not performed or complied with, the insurance never attaches. The insurance is equally avoided by unseaworthiness, although this was unknown, and indeed could not be known, to the insured. Seaworthiness requires reasonable soundness and strength in materials, and a full equipment of all appurtenances and implements which are necessary to the ship, with a proper master, officers, and crew, and proper papers. If the ship is seaworthy at the beginning, so that the

attached, the law may not be quite settled to the effect of a subsequent unseaworthiness. It certainly has no effect upon a total loss; and we consider the better rule that it only suspends but does not defeat the insurance. Thus if a ship loses her mainmast, this has no effect upon a total loss, nor upon a loss that occurs before the mainmast can be replaced. If the vessel is at a port where she might replace the mainmast, and does not, and sails and meets with a total loss, nearly all agree that the insurers are liable; but some authorities hold the vessel unseaworthy for a loss occurring during such unseaworthiness, if the loss is not caused by a peril insured against.—Another implied warranty is, that there be no false representations, and no concealment of material facts; for if there be either of these, the policy does not attach. In the case of insurance, that is a misrepresentation, which, however made, tends materially to induce the utterer of a contract which otherwise would not be made, or better terms than otherwise be granted. Concealment is a suppression of a material circumstance, for any purpose. Such misrepresentation or concealment discharges the insurers, although unintentionally and only through mistake; but it has not this effect if withdrawn before the policy is made, or if it ceases to be material before the risk begins. If the representation relates to the future, a future compliance with it is as necessary as a present compliance with a present representation. The insured is bound to communicate not only ascertained facts, but all intelligence, and even rumors, if they are such as may reasonably enter into the estimate of the risk; but he is not bound to disclose what are merely his own fears, nor such matters of general information or public notoriety as are likely to be well known to one person as to another; or anything which the insurers already know; or anything expressly provided for in the policy.

A substantial compliance with a representation is sufficient, although it be not so strict as would be required in the case of an express warranty.—As nothing prevents the insured from making what agreement they please, they sometimes omit, or expressly exclude certain risks; or the insured warrants that the loss, which comes to the same thing, is not caused by a peril insured against, as sometimes happens, causes a total loss, some of which are insured against, and some are not, it may be very difficult to determine whether the insurers are liable.

There are many such cases. The general rule is: *Causa proxima, non respectatur*. But even then it becomes difficult to know what is a proximate cause, and what is a remote cause. Here also the general rule may be given; it is, that the insurer is not liable for any effects of a peril which they insure, excepting those which are the natural, direct, and immediate effects thereof. One way in which insu-

urers seek to guard against this question, is by having a long list of what are called memorandum articles inserted in their policy, or referred to in it. These are grain, hides, and other perishable things, which are likely to be injured somewhat, either by slight causes, or without external causes; and it is provided that the insurers shall not be answerable for these, unless there is a total loss, or a certain large loss, or unless the loss is caused by stranding; for in either of these events, it will be probable that the loss is caused by a peril insured against.—Another implied warranty of the insured is, that there shall be no deviation; which means, primarily, that the ship shall go by the direct and usual course to the place whither she is bound. It means also, by construction and usage, not only that there shall be no departure from the proper course, but no unnecessary delay, or, more extensively, no material departure from or change in the risks insured against, not justified by a good cause. Nor need this change increase the risk, for the parties have a right to hold each other to their agreement. There may be deviation while a ship is in port, or where no particular voyage is indicated, the insurance being on time; and the rule concerning deviation, like nearly all those of the law of marine insurance, is equally in force in the lake and river navigation of this country as in its ocean commerce. The effect of deviation is to discharge the insurers altogether from all subsequent risks. If, when a deviation ceases, all subsequent risks are precisely the same as they would have been had the deviation not taken place, the obligation of the insurers might revive; but this can rarely be the case. There are cases where a slight deviation discharges the insurers; but it must have some reality and effect. Delay in commencing or in prosecuting a voyage may be a deviation. Going into a port out of the natural and proper course is certainly one. Liberty is often given in the policy "to enter" such a port, or "touch at," or "stop and trade at," or otherwise as the parties may agree; but such a liberty is usually construed very strictly. A deviation does not discharge the insurers, unless it be voluntary. Any necessity, as for repairs or provisions, or to save life, or to avoid a peril, justifies so much deviation as it requires. A mere intent to deviate has not the effect of deviation. Thus, for example, if a vessel sails from New York insured on a voyage to New Orleans, intending at a certain point in her course to bear away for Havana, and is lost before she bears away, the insurers are held.—We have already said that the consideration for the contract of insurance is called the premium; and this is a small sum of money, for which, in this country, the insured or his agent usually gives his note when the policy is made and delivered, which is called the premium note. This premium is never due in fact until it is earned by the risk, for insurance against which the pre-



mium is paid. If this risk never takes place, the promise to pay the premium cannot be enforced; and if it has been paid, the insurers must repay it. Hence it is always in the power of the insured to cancel the policy before the risk attaches, by refusing to put his property under that risk. But unless the voyage be abandoned, a notice of his wish to cancel the policy has no effect. If the whole risk attaches to the whole property for any time whatever, no part of the premium is returnable. If the risk attaches to a severable part of the property only, a proportional part only of the premium is earned, and the remainder is returnable. Clauses are sometimes inserted in policies defining certain contingencies upon which the premium is returnable in whole or in part.—The property insured should be described sufficiently to secure its identification; but the interest of the insured need not be described, as whether it is all, or half, or a quarter, or that of an owner, a mortgagee, or a factor. Insurance on a ship covers all the implements and appurtenants actually and properly used for her navigation, although not strictly necessary. An open policy on the ship does not cover the freight; but it is common to cover the freight by a valuation of the ship. One who owns both ship and cargo may insure his "freight," and thereby cover what his ship would earn by carrying for another owner that cargo for the same distance.—The insurers are never responsible for the acts of the insured, or for the direct and immediate consequences of those acts; but they may be for the consequences of the acts or omissions of the master and crew, although they are the servants of the owner, but not if their conduct was in compliance with the owner's orders or instructions. It may be stated as a universal rule, that the insurers are liable only for extraordinary risks; for the seaworthiness of the ship implies her competency to meet safely all ordinary risks. Hence they are not liable for any loss which shall be attributed to wear and tear, or ordinary breakage. So, too, insurers are never liable for losses which are the consequences of inherent defects or qualities of the property insured, unless these are made active and destructive by a peril insured against, as where hemp rots or lime takes fire from being wet by the effect of storm or wreck. If the losses occur by contraband trade, or a violation of the law of foreign countries, this, we have seen, does not discharge the insurers on the ground of illegality; but it does discharge them as a risk they never undertook, unless the insured had previously to the insurance informed them that the goods or ship would undergo this risk, or the insurers knew this otherwise.—American policies commonly enumerate the risks against which the insurance is made. They are usually perils of the sea, fire, barratry, theft, piracy, arrests, and detentions. A general clause, "all other perils," is usually added, but is restricted by the enumeration. Of these perils, the first, "perils of the sea," is by far the

most important, and would of itself include some of the others. It covers in general all loss or damage arising from extraordinary action of wind or sea, or from inevitable accidents arising from navigation. But no natural loss, as for example the destruction of a ship through leakage caused by worms, is a loss by a peril of the sea. Collision is a peril of the sea. The rule of the sea is, that when two ships collide, if neither is in fault, the loss rests where it falls. If one alone is in fault, the whole loss rests on him. If both are in fault, the common law courts let the loss rest where it falls; but the courts of admiralty divide the loss equally between the parties. For the loss a vessel suffers by collision, her insurers are answerable. It has been held that they were liable for what the vessel they insure had to pay because in fault; but the later and the better rule limits their liability to the loss actually sustained. To bring a loss within the clause of "theft or piracy," it is said that there must be violence, and that the thieves must not be the crew, unless they are in mutiny; but this is not certain, and it is now common to use the phrase "assailing thieves," in order to limit the liability of the insurers to a loss from violence from without the ship. What is barratry has been much disputed. It is an ancient maritime term, and may perhaps be best defined as any wrongful act of the master, officers, or crew, done against the owner. If it be a wrongful act, against him in fact, it may be barratry, although mistakenly intended for his benefit. But it must be against the owner of the ship, and is not barratry as against other parties if the act be done by the owner's command or with his consent. In American policies it is now common to add after the word "barratry" the words, "if the insured be not owner of the ship." The effect of this is, that ship owners are not insured against barratry, but shippers of goods are; and the reason is, that insurers are willing to insure shippers of goods against the misconduct of those they do not appoint, and cannot control, but are not willing to insure ship owners against the acts of their own servants.—The termini of the voyage must always be definitely stated (if the insurance be not on time), not only to determine whether there be a deviation, but also to show whether any loss that occurs takes place within the policy. It is important therefore to know precisely when the insurance begins and when it ceases. By the words usually inserted, "lost or not lost," the insurers make themselves responsible although the property be at that time wholly lost, provided the insured does not know it, or makes known all he knows about it. Insurance "at and from" a place begins when the property is there in a safe condition. Insurance "from" a place begins when the ship sails. English and American insurers now usually insert a clause in all voyage policies, that the insurance continues "until the ship be arrived and moored 24 hours in safety." This means safe-

from the perils insured against, and not the local ones of the port or place, as unsafe moorings, &c.; as otherwise it could not cease while the vessel lies there. The insurers are answerable if the loss occurs after the policy expires, provided it be the direct, immediate, and inevitable effect of an injury received at a time when the policy attached, from a peril insured against.—The loss may be total or partial; and a total loss may be actual or constructive. An actual total loss occurs when the ship or goods are actually submerged, or destroyed by fire or some other peril, so that no part of them of any value survives and is recoverable. A constructive total loss, or, as it is sometimes called, technical total loss, is one in which valuable portions of the property survive, but are transferred to the insurers by abandonment, so that the whole property passes out of the possession of the insured, and the insurers pay for the whole, and hold the salvage (or property saved) as their own. By the established usage of this country, confirmed by abundant adjudication, the insured has a right to abandon, and thus convert a partial loss into a total loss, whenever the partial loss exceeds one half of the value of the property insured. But our policies now generally contain the clause that here shall be abandonment only when the partial loss exceeds 50 per cent., estimated as a third off. This means, after a deduction of one third off. For it is one of the practical rules to which merchants have come, that in every case of partial loss one third shall be allowed as the benefit conferred by the new materials of repair; or, in the common phrase, "one third off, new for old." Thus, if a new vessel sails to-day, and to-morrow loses her masts and rigging so as to require that all her top hamper should be replaced, and the insurers pay the cost of this, the owners gain nothing. But if the same ship, after spars and canvas are nearly worn out, meets with the same disaster, and new ones are supplied, and the insurers pay the cost, the insured gains nearly all that he receives, for he lost very little by the disaster. Merchants and insurers, instead of trying to determine the proportion in each case, wisely conclude that the average, one third off, meets all cases fairly. Applying this to the case of constructive total loss, it is plain that a partial loss, to justify abandonment, must be more than 75 per cent. (For the loss of a ship by the sale of the master, in a case of strict necessity, see SHIPPING.) Whether the property insured be ship or cargo, it is the universal rule that a loss where anything is saved cannot be made total, excepting by transfer of salvage by abandonment to the insurers; and the same rule applies to all claims, rights, and interests in, to, or about the property, remaining in or accruing to the insured. Thus, if the insured lose by jettison or otherwise so as to acquire a claim to general average contribution, this claim must be transferred; and the insured have to pay a general average

contribution caused by a loss insured against, the insurers must repay it. (See AVERAGE, and SHIPPING.) There is no especial form of abandonment; but it must be made by the insured without any unnecessary delay, immediately upon learning the loss, and in terms distinctly indicating the fact of their loss, and their transfer of all salvage by abandonment, and their claim for a total loss. If the abandonment is accepted, it binds the insurers; but if they refuse the acceptance, their refusal cannot impair the rights of the insured. II. INSURANCE AGAINST FIRE. The principles of fire insurance are the same with those of marine insurance, excepting so far as the nature of the property and of the risk causes a difference. It is only these differences that we need to present. Marine insurance is usually effected through a broker; fire insurance usually by the party himself. He generally has to sign a formal application, and answer therein many questions; and the substantial truth of every answer would be taken as a condition precedent to any liability on the part of the insurers. It is common to state in the application, or policy itself, that certain risks are "hazardous," and a scale of premiums is sometimes given for different classes of property; and it is of extreme importance that the insured should not deceive the insurers on this point. But there must be a rational if not a liberal construction of all these rules. Thus, if "cotton in bales" is represented as particularly "hazardous," a policy would not be avoided by the fact that a person insured upon a store and goods had one or two bales there for retail. So if "storing" certain goods demands an extra premium, having a small quantity for home consumption, or even for sale, does not come within the meaning of this clause. If the insured proposes to make any alteration in the premises insured, he should make this known to the insurers, and, if he can, obtain their leave in writing. But we apprehend that mere alterations, however expensive or important, do not of themselves avoid a policy, unless they are such that they increase the risk substantially. While the alterations are in progress, and a new risk exists from them, the underwriters are discharged from liability caused by a loss arising from this risk, but not, we think, if it arises from a cause wholly independent of the risk; and if the alterations are finished, and the risk not altered, they do not affect the insurance. It is usual to provide in the policy, or by the rules of the company, for making necessary or proper repairs. The law of warranty, of representation, and of concealment, is much the same in fire insurance as in marine insurance. But some questions have arisen as to what part of a description is a continuing warranty. If expressly prospective, as that water tanks shall be kept in an upper story, or a certain watch maintained, these of course are continuing promises, and a breach avoids or suspends the policy. So a description that the house is slated

would be a continuing warranty that it should remain slated. But a statement that the house stands "500 feet from any other building" would not avoid the policy, if a neighbor should put up a building within 100 feet of the insured. There seems to be this difference between the two kinds of policies: a breach of warranty avoids a marine policy, however innocent the insured; but it seldom has this effect upon a fire policy, unless there be fraud or other default on the part of the insured. At the time of the insurance, the property must be in existence, and not then on fire, or in immediate danger from fire. Heat alone, however excessive, or however caused, or however destructive, does not make the insurers liable unless there be fire, or ignition. Hence, it is now settled that a loss by lightning is not a loss by fire, unless the property be lost by ignition caused by the lightning. But if there be a fire, usage and the law go very far in holding the insurers liable for the consequences of it. Thus, any loss caused by honest efforts to extinguish the fire, as by water poured upon it, or any loss sustained by removal of the insured goods from a peril of fire, or by the blowing up or tearing down of a building to arrest a fire, would fall on the insurers. But there must be an actual fire, near enough and dangerous enough to justify reasonable men in the measures which have resulted in the loss. While an explosion of or by gunpowder is a loss by fire, an explosion of or by steam has been held not to be so. Though the loss be caused by the negligence of the servants of the insured, the insurers are still held; and so they are if it be caused by his own negligence, unless that be so extreme and extraordinary as to raise a suspicion of, or rather imply, fraudulent intent. That the fire was caused by the insanity of the insured is no defence to the insurers.—Valuation is sometimes made in policies by stock companies upon chattels of uncertain value, as books, plate, or works of art; seldom by these companies on houses; and never upon anything, so far as we know, by mutual companies, for the purpose of determining the amount to be paid in case of loss. If a loss happens, the insured is entitled only to actual indemnity; but a valuation is required by the charters of most companies, that they may not insure beyond a certain proportion of the value, and the valuation for this purpose is usually binding on both parties. Insurers against fire generally stipulate that they may rebuild or repair the premises insured, if they prefer this course to paying for the loss; and they frequently avail themselves of the right. There is not in fire insurance any rule answering to the "one third off, new for old," in marine insurance; nor any usage of making a partial loss total by abandonment, although all insurers who pay a total loss are entitled to all salvage or remains. Nor is there anything of general average known to fire insurance.—As it is deemed especially important in fire insurance to prevent insuring

more than the value of the property, in order to guard against the temptation to burn it for the insurance, policies generally provide in substance and effect that any previous insurance, not made known, shall avoid any subsequent policy; and the law is very strict in construing and applying this rule or provision. It is now common to provide also that subsequent insurance, not made known and assented to, shall avoid the policy. (See LIFE INSURANCE.)

#### INTEGRAL CALCULUS. See CALCULUS.

**INTERDICT**, in the Roman Catholic church, an ecclesiastical censure, or penalty forbidding public worship and the administration of the sacraments to certain persons or in certain places. Generally speaking, what the Roman Catholic church considers as the necessary rites of religion were not forbidden, such as baptism, confession, and extreme unction. Indeed, all the sacraments in most cases continued to be conferred privately, the solemn services alone being suspended. The canon law recites three kinds of interdict, local, personal, and mixed. The first directly affected the place, and indirectly its inhabitants, and them only while within its limits. The second affected the persons, who were interdicted the solemn services wherever they might be. The third combined both these effects. In the beginning interdicts were employed by all persons having episcopal jurisdiction, but in course of time their use was restricted to the Roman pontiffs. They were scarcely known until after the Calvinian period, when the interdict became a powerful ecclesiastical weapon for restraining the violence of the feudal nobles. However, an instance of its use occurred in 583, when Queen Fredegonda having caused Praxertatus, bishop of Rouen, to be slain in his own cathedral, Landowald, bishop of Bayeux, with the advice of the local clergy, commanded all the churches in the city to be closed and public services to cease till the instigators and perpetrators of the crime had been discovered. In the 10th century the popes began to have recourse to interdicts in their contests with sovereigns. In 997 Gregory V. laid all France under an interdict because King Robert had married his own cousin, and the king was abandoned by most of his court. The same penalty was inflicted upon the kingdom of England under Stephen (1147) by Eugenius III., under John (1208) by Innocent III., under Henry VIII. (1535) with little effect by Paul III., and under Elizabeth (1587) by Sixtus V. Adrian IV. laid Rome under an interdict for the purpose of driving out Arnold of Brescia. Gregory IX. made use of the same weapon in his quarrel with the emperor Frederick II.; and Paul V. in 1606 laid an interdict upon the republic of Venice in consequence of the passage of certain decrees relating to ecclesiastical matters. The government resisted the promulgation of the bull, and ordered the parochial clergy to continue their functions as usual. From the time of the reformation, local interdicts became rare; personal

which are the severest forms of economic censure, are still imposed.

**INTERLAKEN**, or *Interlachen*, a village of 1,400 inhabitants, in the canton and 26 m. S. E. of Bern; pop. about 1,400. It is celebrated for its charming situation near the left bank of the Aar, in the valley of Bodeli, between the lakes of Brienz and Thun, with a view of the Jungfrau, and in the vicinity of which is the most picturesque scenery in Switzerland. It is the starting point from which, in each fall, the valley of Lauterbrunnen, the Staubach, and that of Grindelwald, with its glaciers, are usually explored by tourists, and is a favorite resort of a great

number of working men's interests in all countries. It originated at the time of the Polish insurrection of 1863. The London working men sent a deputation to Lord Palmerston, asking for interference on behalf of Poland, and also convoked an indignation meeting at St. James's hall, London, in April of that year. The Paris working men sent over two deputies, Tolain and Fribourg, to this meeting; and from the conferences of these delegates with the leaders of the London working men sprang the idea of establishing the international association. A few weeks later George Odger, an unsuccessful working men's candidate for the house of commons, drew up a manifesto which was



Interlaken—the Jungfrau in the distance.

translated into French and spread among the working classes of the continent, inviting them to send delegates to a great inaugural meeting in the autumn holiday season (September, 1864). This gathering, which took place at St. Martin's hall, was largely attended by working men of nearly every European country, and presided over by Prof. Edward Spencer Beesley. A general manifesto and the statutes, both drawn by Dr. Karl Marx, were approved for publication; the association was declared established, some funds were collected, a provisional committee was appointed, and Mr. Odger elected president of the association. Soon, however, this office having been declared incompatible with republican theories, the

presidency was abolished, a chairman being elected at every weekly meeting of the general council, and Dr. Marx became the leading spirit of the association. The first continental strike in which the aid of the general council was appealed to and granted was that of the Leipzig compositors and printers in April, 1865. But the statutes of the association were not considered finally established until the first congress at Geneva (1866) had given them a definitive sanction, for three rival programmes were brought forward: that of Mazzini, highly centralized, strongly conspiratory, and dealing much more with politics than with labor and capital; a wild and desultory one of the Russian Bakunin; and the radical and revolution-

ary one of Mazzini, highly centralized, strongly conspiratory, and dealing much more with politics than with labor and capital; a wild and desultory one of the Russian Bakunin; and the radical and revolution-

ary one of Mazzini, highly centralized, strongly conspiratory, and dealing much more with politics than with labor and capital; a wild and desultory one of the Russian Bakunin; and the radical and revolution-

next year 122 branch societies of middle and south Germany held a meeting at Nuremberg and joined the association in a body. The third general congress, held at Brussels about a month later (September, 1868), was probably the greatest success of the association, not only in the number of delegates attending it, but also in the importance that was given to the gathering by the leading journals. From the autumn of that year formidable strikes and disturbances occurred all over Europe until the beginning of the Franco-German war; among these were the cotton-spinners' strike at Rouen; the St. Etienne affair, in which more than 50 working men were killed by the troops; the strike at Le Creuzot; the monster disturbances at Vienna, in which more than 50,000 men took part and were dispersed by military force; and innumerable minor strikes in every European country and in almost every trade. At the fourth annual congress, held in Basel in September, 1869, at which a delegate from America was present, it was decided that the next annual gathering should take place in Paris in September, 1870. The war prevented the meeting, and seems to have inflicted a death-blow on the international, by weakening the radical party both in France and in Germany. At all events, the congresses, the general council, and the association itself were not heard of for 18 months, except in their manifestoes protesting against the savagery of warfare and defending the Paris commune. After that and some disagreements at a congress assembled at the Hague, Dr. Marx withdrew from the association, and the whole establishment went to pieces. But it must not be inferred that the theories of the international have also been abandoned. The various branches of trades unions were trained and made acquainted with each other during its five years' existence, and they are now quite capable of sustaining themselves, supported and informed as they are by the various organs of their party. The number of these journals on the continent is 29. The most important of them are: the *Volkstaat*, published at Leipzig; *Proletarier*, Munich; *Volkfreund*, Brunswick; *Volkswille*, Vienna; *Arbeiter-Zeitung*, Pesth; *Werkman* and *Aomodee*, Amsterdam; *Toekomst* and *Vryheid*, the Hague; *Vorbote* and *Egalité*, Geneva; *Arbeiter*, Basel; *Tagwacht*, Zürich; *Solidarité*, Neufchâtel; "Cause of the People" (in Russian), Geneva; *Internationale* and *Liberté*, Brussels; *Werker*, Antwerp; *Mirabeau*, Verviers; *Federacion*, Barcelona; and *Solidaridad*, Madrid. In the United States we know only of the "Workingmen's Advocate" of Chicago and Cincinnati, and the *Arbeiterunion* of New York, as accredited organs of the association.—The gist of all the theories of the internationalists is this: Wages-paid labor must pass away, as serf labor and slave labor have passed away, and must give place to associated labor, which is to be developed to national dimensions and fostered by national means. No

man has a right to call anything his own which he has not produced by his labor.—See the annual reports published in London; also an article by Prof. Beesley in the "Fortnightly Review" for 1870, and "History of the International," translated from the French of E. Villard by Susan M. Day (New Haven, 1874).

**INTESTINE**, the portion of the digestive apparatus situated below the stomach, divided into the small and large intestines. The former includes the duodenum, jejunum, and ileum; the latter the cæcum, colon, and rectum. Many of the details on these organs have been given in the articles ALIMENTARY CANAL, CÆCUM, COLON, and COMPARATIVE ANATOMY, and need not be here repeated. Next below the stomach comes the duodenum, the largest portion of the small intestine, about 12 in. long, receiving the ducts from the liver and pancreas, and furnished with numerous circular internal folds of mucous membrane (the *valvula conniventes*); above it is in contact with the liver and gall bladder, in front with the stomach and arch of the colon, and behind with the spinal column, right kidney, vena cava, aorta, and diaphragm; its arteries come chiefly from the superior mesenteric, and its nerves from the solar plexus. The jejunum and ileum, which follow, have no distinct line of separation, and may be described together as a canal four or five times as long as the body, arranged in numerous folds or convolutions, freely movable in front and on the sides, and attached to the mesentery behind; the upper portion is called jejunum from its being generally found empty. In front these are in relation with the omentum and the anterior abdominal wall, behind with the spine, and in various places with the large intestine; internally the structure resembles that of the duodenum, the valvulae diminishing gradually from above downward; the mucous membrane is studded with glandular follicles, and contains also the patches of Peyer, the seat of lesion in typhoid fever. Of the large intestine the only portion to be alluded to is the rectum, the terminal portion, ending in the anal opening protected by sphincter muscles; it lies in the concavity of the sacrum, is cylindrical, mostly on the median line, and somewhat dilated at the lower end; its principal relations in both sexes are with the genitourinary organs. Internally it presents longitudinal and parallel folds, with transverse semilunar wrinkles forming sacs in which fecal matter is often lodged for a long time; its mucous membrane possesses considerable absorbent powers, and may be used for introducing nutriment and medicine.—The common peristaltic movements of the intestinal canal depend upon the contractility of the muscular coat called into action by the stimulus of the contents, and are not dependent upon cerebro-spinal nervous influence, though they may be modified through the spinal and sympathetic systems. In the duodenum and beginning of

the jejunum are small branching clusters of follicles, the glands of Brunner. The follicles of Lieberkühn are simple open glandulæ, straight narrow cæca, very abundantly distributed through the entire length of the intestinal tube. The product of these two sets of glandular follicles is the intestinal juice, a colorless, viscid, alkaline secretion, which rapidly converts hydrated starch into sugar, and probably also effects other important changes in the digestive process. When the extent of these glandular structures of the intestine is considered, the beneficial action of purgative medicines, in hastening the removal of various morbid matters from the system by direct stimulation, may be easily understood.

**INVERNESS** (formerly Innerness), a borough and seaport of Scotland, capital of Inverness-shire, situated on both sides of the river Ness,

a mile from its estuary and 9 m. above the junction of the latter with the Moray frith, at the N. entrance of the Caledonian canal, and 115 m. N. N. W. of Edinburgh; pop. in 1871, 14,463. The principal part of the town is on the right bank of the river, and the two sides were formerly connected by a stone bridge, built in 1685, carried away by a flood in 1849, and replaced by an iron suspension bridge. The town has five principal streets, with houses generally well built of stone, and many fine churches, banks, hotels, and public buildings. It has a coasting and foreign trade through the Moray frith and Caledonian canal, and exports grain, potatoes, wool, woollen cloth, ropes, sail cloth, leather, ale, whiskey, and dairy produce. The imports in 1871 were valued at £27,714,012 (from the United States, £3,026,867), the exports at £6,339,701 (to the



Inverness.

United States £359,348).—Inverness is a town of great antiquity. On an eminence S. E. of the town anciently stood a castle, in which it is supposed that Duncan was murdered by Macbeth. The castle was destroyed by Malcolm Canmore, who erected a new one, which was for several centuries used as a royal fortress, within whose walls a parliament was held during the reign of James I. On the site of this castle, which was blown up in 1746 by the troops of Prince Charles Stuart, stand now the court house and the county buildings. Cromwell erected a fort on the N. side of the town near the mouth of the Ness, which was demolished at the restoration, but part of the rampart still remains. Culloden moor is 3 m. from the town.

**INVERNESS**, a county of Nova Scotia, Canada, occupying the W. portion of Cape Breton; area, 1,221 sq. m.; pop. in 1871, 23,415, of

whom 18,197 were of Scotch, 2,682 of French, 1,307 of Irish, and 1,030 of English descent. It is well watered, and contains excellent farming land. Coal and petroleum are found. The inhabitants are chiefly engaged in agriculture and fishing. Capital, Port Hood.

**INVERNESS-SHIRE**, a county of Scotland, stretching diagonally across the mainland from sea to sea, between lat. 56° 40' and 57° 40' N., and including on the west the island of Skye, several smaller islands, and most of the Outer Hebrides; area, 4,255 sq. m.; pop. in 1871, 87,480. The S. W. shores are deeply indented by arms of the sea, and on the N. E. is Moray frith. The country is mountainous, well wooded, and generally fertile; about 112,000 acres are under cultivation. The Monadhia (gray mountain), or Monagh Lea, and the Benalder mountains are the principal ranges, each with an altitude of 3,000 ft. Ben Nevis, the loft-

iest peak in Britain, rises to a height of 4,406 ft.; Cairngorm is 4,090 ft. high; and Ben Nevis, an isolated hill near Inverness, 4,130 ft. Veins of lead and silver and small quantities of iron ore have been discovered, but not coal. The chief rivers are the Spey, Ness, Beauly, and Garry, all of which have valuable salmon fisheries. Lakes occupy 132 q. m. of the area. The largest is Loch Ness, so deep that it never freezes; with its continuations and connections, it bisects the county from N. E. to S. W. Many of these lakes are surrounded by picturesque scenery. The Gaelic language, excepting in the town of Inverness, is more prevalent than English. Agriculture is prosperous; oats are the main crop. But tillage is secondary to the raising of cattle and sheep, the former generally of the Skye or Lyloe breed, and the latter Cheviot or Linton.

**INVERTEBRATA**, a negative term in zoology, employed by Lamarck to designate animals destitute of a vertebral column or backbone. Exclusive of the protozoa, these constitute three out of the four great divisions of the animal kingdom, viz., articulates, mollusks, and radiates; the remaining division consists of the vertebrates, or those having an internal skeleton with a backbone for its central support, including man and other mammals, birds, reptiles, amphibians, and fishes. The articulates, characterized by a jointed body, include insects, arachnids, centipedes, crustaceans (as crabs and mollusks), and worms; the mollusks are those usually denominated shell-bearing animals; the radiates include the echinoderms (or sea urchins, star fishes, and holothurians), the acorn-like or jelly fishes, and the polyps (like *hydra*, *medusa*, and the coral animals). There is no homology or affinity between the structural type of the vertebrates and invertebrates, though there may be analogy; for instance, the head of an insect is not homologous with the head of a man, a bird, a reptile, or a fish, as it has no distinct brain cavity nor cranial vertebrae, and its sense organs and other parts perform the same functions. Aristotle distinguished invertebrates from vertebrates, calling the former *aima* (bloodless) and the latter *evaiua* (having blood); Oken made the same distinction in his gut animals and flesh animals, and Ehrenberg in his *ganglioneura* and *myeloneura*; when Lamarck was aware that in his *invertebrata* all the organs are contained in a single cavity, while in the *vertebrata* there are distinct cavities for the nervous system and the organs of vegetative life. Lamarck divided the *invertebrata* into two orders and twelve classes, viz.: apathetic animals, with the five classes of *infusoria*, *polypi*, *radiaria*, *tunicata*, and *terres*; and sensitive animals, with the seven classes of insects, arachnids, *crustacea*, *medusa*, *cirripeda*, *conchifera*, and mollusks; distinguished from *vertebrata*, or intelligent animals. The development of the embryo and the methods of reproduction in the invertebrates are different from those of the verte-

brates. In the radiates the germ surrounds the yolk like a crust, from which the more animated parts are derived, the alimentary canal being formed from the central mass; reproduction may also take place by buds or by transverse division in the polyps and jelly fishes, the latter also presenting the curious phenomena of alternate generation. In articulates the embryo is formed at the lower part of the yolk, with its dorsal surface toward the latter, so that the yolk is enveloped from below upward, the uniting suture being upon the back. In mollusks the yolk is introduced from the lower side of the animal, as in vertebrates, but there is no upper cavity for the nervous system, as in the latter. It is thus evident that the term *invertebrata* is not equivalent in zoological precision to, and is far more comprehensive than, the vertebrate division; the oyster, the butterfly, the star fish, all invertebrates, have nothing in common but the absence of a vertebral column. Invertebrates include by far the most numerous and diversified forms in the animal kingdom; in them we find many important physiological questions answered, and by them we understand otherwise inexplicable problems of animal life and of its relations to changes in the earth's surface; in them we see a circulation of blood without a heart or without distinct vessels, respiration effected by a vascular integument, the nervous system reduced to its essential elements of ganglia with connecting cords, the external skeleton enclosing the muscles and organs, the plant-like mode of reproduction and of true hermaphroditism, and the multiplication of organs independently performing the same functions (as digestive sacs, gills, locomotive appendages, &c.). The different classes will be described more fully in their respective order. The whole subject is most learnedly treated by Prof. Owen in his "Lectures on the Invertebrate Animals" (1843).

**INVESTITURE**, the public delivery of a feud or fief by a lord to his vassal. Blackstone says: "Investitures, in their original rise, were probably intended to demonstrate, in conquered countries, the actual possession of the lord, and that he did not grant a bare litigious right, but a peaceable and firm possession. At a time when writing was seldom practised, a mere oral gift, at a distance from the spot that was given, was not likely to be long or accurately retained in the memory of bystanders who were very little interested in the grant." Investiture was performed by the presentation to the person invested of some symbol of authority and possession. Thus, when lands were transferred, it was customary for the grantor to give the grantee a turf as bearing resemblance to the property transferred.—In ecclesiastical history, by the right of investiture was meant that claimed by the temporal lord of presenting a prelate with the ring and crosier, the acknowledged emblems of episcopal and abbatial jurisdiction. Before the in-

vasion of the barbarians the election of bishops depended on the voice of the clergy and people and the suffrage of the provincial prelates. In feudal times the tenure of church property was likened to that of lay fiefs; bishops and abbots, like barons and knights, had to swear fealty and do homage to their lord paramount. The sovereign, to prevent the temporalities of an episcopal see or of an abbey from falling into the hands of his enemies, reserved to himself the right of nomination, as well as that of confirmation by investiture. These claims were resisted by churchmen as encroachments on their privileges. The general councils of Nice in 787 and of Constantinople in 869 condemned the nomination of bishops by lay authority. This condemnation was renewed in 1076 and 1080 by Gregory VII., and by Victor III. in 1087 at the council of Benevento, the latter placing under the ban of excommunication both the laymen who exercised the right of investiture and the clerics who submitted to it. But in spite of the decisions of popes and councils, the practice of investiture was continued by sovereigns. It was introduced into France and Germany by Charlemagne. The emperor Henry III. repeatedly enforced the right; and its exercise by the emperor Henry IV. was a chief ground of his quarrel with Gregory VII. The contest on this question between the popes and the emperors continued into the succeeding century, when, by a concordat agreed upon at Worms between Calixtus II. and the emperor Henry V., the latter renounced for ever his claim to invest bishops with the ring and crosier. The French kings, however, long continued to exercise a similar power, and the contests between them and the popes on the subject at length resulted in a compromise by which the monarch relinquished the presentation of the symbols, but retained the right to confer investiture by a written instrument. In England the controversy ended in a similar compromise between Paschal II. and Henry I.

**INYO**, a S. E. county of California, bounded E. by Nevada and W. by the Sierra Nevada mountains; area, 4,680 sq. m.; pop. in 1870, 1,956, of whom 29 were Chinese. The Sierra Nevada here embraces several lofty peaks, among which is Mt. Whitney. The Inyo, Telescope, and Amargosa mountains are parallel ranges E. of Owen's river, which flows from the north into Owen's lake, a body of water 18 by 12 m. in extent. The valley of the river is from 15 to 25 m. wide, but only a strip 2 to 3 m. broad can be cultivated. This strip, embracing about 250,000 acres, is very fertile. Argentiferous galena, gold, copper, sulphur, and tin are found. The chief productions in 1870 were 13,629 bushels of wheat, 22,915 of Indian corn, 2,175 of oats, 4,905 of barley, 6,336 of potatoes, 20,940 lbs. of butter, and 1,456 tons of hay. There were 1,514 horses, 5,662 cattle, 521 sheep, and 688 swine; 2 saw mills, and 12 quartz mills. Capital, Independence.

**IO**, in Greek mythology, the daughter of Inachus, the founder of the worship of Juno at Argos, or according to others of Piren or Jasus. She was beloved by Jupiter, who on account of Juno's jealousy changed her into a white heifer. Juno obtained from him the gift of the heifer, which she placed under the charge of Argus Panoptes in her grove at Mycenæ. Mercury, commissioned by Jupiter, was guided by a bird to Argus, slew him with a stone, and delivered Io. Thereupon Juno sent a gadfly, which tormented Io and pursued her in a state of frenzy over the whole earth, till at last she rested on the banks of the Nile, where she recovered the human form, bore a son to Jupiter named Epaphus, and, according to some accounts, introduced the worship of Isis, with whom she afterward became identified. The fullest narrative of her wanderings is in the "Prometheus" of Æschylus. As usually explained, Io represents the moon, and her wanderings the moon's phases; Argus, the stars of heaven; and Mercury, as the god of mists and clouds, is the Argus-slayer.

**IODINE** (Gr. *ἰώδης*, violet-colored), an elementary substance named from the color of its vapor, existing in various marine plants, the water of many mineral springs and of the ocean, the bittern of salt works, sponges, corals, and some rocks and minerals. It was discovered in manufacturing saltpetre by Courtois of Paris in 1812, and afterward examined and described by several chemists, but more particularly by Gay-Lussac (*Annales de chimie*, vols. lxxxviii., xc., and xci). It is represented by the symbol I; its chemical equivalent is 127. In its preparation it crystallizes either from solution or by sublimation in scales like those of micaceous iron, and in regular crystals of elongated octahedrons with rhomboidal base. These are brittle, opaque, bluish black, and of metallic lustre; their specific gravity is 4.95; they fuse at 225° F. into a dark liquid, and boil at 347°, giving off deep purple and violet vapors. Iodine is also volatile at common temperatures, and when exposed to the air diffuses an odor like that of chlorine, the vapor irritating the nostrils and exciting cough. This is among the heaviest of æriform bodies, its density being 8.7 times that of air. Alcohol, ether, and carbon disulphide dissolve iodine freely; pure water takes up only about  $\frac{1}{1000}$  of its weight of it, and thus acquires a yellowish or brown tinge. By adding nitrate or chloride of ammonium, common salt, or any of the iodides, to the water, its power of dissolving iodine is greatly increased, and the solution then takes a very deep brown color. Iodine gives a yellow stain to the skin, which soon disappears. Though resembling chlorine in its combinations and some of its qualities, it has not the property of bleaching, and its chemical affinities are weaker. Its remarkable property of imparting a deep blue color to a mass or solution of starch serves as a distinguishing test of extreme delicacy. The starch solution, if cold, will sensibly indicate the pres-



Iodine in solutions containing only  $\frac{1}{10}$  of it. It is supposed that the iodine is finely mixed in a finely divided state with starch. It must be free for the test to succeed to insure this, where the iodine may be in the state of an iodide, it is recommended to add to the solution a drop of sulphuric acid, or a little vapor of chlorine, or instead of these a drop or two of nitric acid may be used. Though iodine is detected in a multitude of natural bodies, principally those connected with the sea or in plants growing near the salt it is found in largest proportion in the common seaweeds, and other marine plants which grow at great depths. The *fucus vesiculosus* and *saccharinus* are especially rich in iodine. The preparation of the iodine of commerce is principally carried on at Glasgow, Scotland, at Donegal, Ireland, and at Cherbourg, France, to which places are brought the vitrified ashes produced by burning seaweeds collected on the coast. These are called kelp, or on the continent *vaees*, coarsely powdered, are digested some time in water, and the solution is then drawn off on a fresh portion, and from this upon a fourth, fifth, and it may be a sixth, the liquor has attained a density of 1.30. The various soluble salts, including the iodides and bromides of all the alkalies, are taken up and separated from the earthy matter. The solution is then drawn off into broad shallow pans, and concentrated to 60° B., or sp. gr. 1.30. At this point the iodides of soda and chloride of sodium begin to crystallize; they are ladled out as they separate from the solution, and placed so that the crystals from them run back into the pans. When they cease to appear, the liquor is left to stand to deposit more chloride in the pans. The liquor is then drawn off into coolers, and left for 24 hours for the sulphates to crystallize, as also the iodide of potassium. The liquor is then again drawn off in the pans, and at 68° T., or sp. gr. 1.30, deposits carbonate of soda, and more chloride of sodium and sulphate of soda. It is again drawn off to a cooler to cause a further separation of iodide of potassium. The process is some-what repeated, and the liquor brought by this operation to 74° T. After removing all the crystals that appear, there frequently remain in solution some chlorides, hyposulphite of sodium, and sulphide of sodium. Strong sulphuric acid is then added, and after agitation the mixture is left to stand for two days. The sulphuric acid compounds are in this time decomposed, and sulphur is produced with liberation of sulphuric acid in a free state, in sulphuretted hydrogen, and sulphurous acid. The iodine is fixed by combination with sodium, and, unless too much acid has been added, cannot be liberated by oxygen. The lye is now poured into a still lined with lead, and when heated in a water bath to 140°, a quantity of manganese dioxide is introduced, and the still is luted

and connected with its condensers. Iodine vapors come off at a temperature below the boiling point, and condense in the receivers. Particular care is required that the temperature does not exceed 212°, in which case the iodine is apt to combine with chlorine with loss. Cyanide of iodine often collects in white, prismatic crystals in the receiver furthest from the retort. A portion of iodine remains in the retort in combination with lead and sodium, which is recovered by first converting it into an iodide of copper by the addition of sulphate of copper, and, when this is separated by filtration, decomposing it by sulphuric acid and oxide of manganese, and collecting the vapor. The process above given is somewhat modified at different localities. A method has been proposed by Dr. Kemp to dispense with the burning of the plants, by which much iodine is volatilized and lost, and to crush the roots in which the largest proportion of iodine is concentrated, and set them to ferment; after which the iodine with other salts may be dissolved out by water acidulated with hydrochloric acid, and finally separated by proper reagents. It is also proposed to distil the seaweeds instead of incinerating them. Large quantities of iodine are now recovered from the nitrate of soda of Chili, according to a method invented by Thiercelin. The mother liquors resulting from the manufacture of saltpetre are treated with a mixture of sulphurous acid and sulphite of soda, and the iodine is precipitated as a black powder. This is placed in earthen jars, on the bottom of which are layers of quartz sand, fine at the top and coarse at the bottom; from these jars the iodine is removed by earthen spoons lined with gypsum, and the greater part of the water is thus separated. It is further purified by sublimation, but is often sold before undergoing the last named process. The amount of iodine thus reclaimed from Chili saltpetre in 1870 amounted to 30,000 lbs. —Iodine is useful as a test for starch, and also as an ingredient of various chemical reagents. Some of these are of great importance in the photographic art. From the iodide of potassium is prepared the iodide of silver, which constitutes the sensitive film upon the plates.—Iodine forms two important acids, iodic acid,  $\text{HIO}_3$ , and periodic,  $\text{HIO}_4$ . Hydriodic acid closely resembles hydrochloric acid, as the oxygen acids correspond respectively to chloric and perchloric acids.—Iodine has been employed in medicine since 1819, although burnt sponge, which depends upon iodine for its efficacy, had been previously used with advantage in treatment of goitre. A large number of preparations are employed both for external and internal application; the most important are solutions of iodine in alcohol, iodine dissolved in water by the aid of iodide of potassium, iodoform, the iodide of potassium, and iodides formed with mercury, iron, sulphur, sodium, and arsenic. Iodoform is a yellow salt in hexagonal flat crystals, which contains more than 96 per

cent. of iodine. Iodine and many of its compounds are absorbed with considerable rapidity from the stomach, and reappear in the excretions, especially the urine, in a short time. It has also been found in the saliva and milk; this is particularly true of the iodide of potassium. It remains but a short time in the system. Iodine itself is an irritant, and is used to produce counter-irritation. If taken in considerable quantities internally, it becomes a poison by exciting inflammation of the stomach, œsophagus, and fauces. When it is used in small doses long continued, a condition called iodism may arise, consisting in fever, restlessness, disturbed sleep, gastro-intestinal irritation, and progressive emaciation. These symptoms are not likely to arise either from the iodide of potassium or from the iodide of sodium, and are indeed not very frequent from the cautious use of iodine itself. The action of iodide of potassium in considerable quantity is sometimes marked by coryza, and a rash, like acne, upon the face and chest. Iodine has been principally used in diseases involving glandular enlargement, such as goitre and scrofula, and also with great benefit in syphilis and in chronic rheumatism. In chronic poisoning by mercury or by lead, the metal remaining in the system may be rendered more soluble, and removed by the iodide of potassium. This is shown not only by the improvement of the patient's condition, but by the detection of the metal by chemical tests in the urine. For these purposes it should be used in large doses of from 10 to 20 or 30 grains three times a day. Iodine, iodide of potassium, and iodides of sulphur, lead, and mercury are used externally in the shape of tincture and ointment. Some of these are useful counter-irritants. Any specific absorbent effect on the part of the ointment is not clearly proved. Injections of tincture of iodine have been made into diseased cavities, especially those lined with serous or synovial membrane, as the joints, tunica vaginalis, and ovarian cysts, to excite adhesive inflammation; and it has been injected into the pleura, and even the pericardium and peritoneum. Inhalations of the vapor have been employed in pulmonary disease. Iodic alimentation, by introducing iodine into articles of food, as bread, has been proposed. Iodine has also been united with cod-liver oil. A solution of iodine in iodide of potassium is useful in the detection of many alkaloids, with

which it forms more or less insoluble compounds. It has also been proposed as an antidote to alkaloid poisons; but it should be borne in mind that the compounds formed by iodine with strychnia, for instance, are probably only relatively harmless, and the absorption merely delayed, so that other means of treatment should not be neglected, although the iodine solution, if convenient, may be used to gain time. The special forms of disease in which iodine and its preparations have been found most useful are goitre, enlarged scrofulous glands, scrofulous ulcers and abscesses, secondary and tertiary syphilis, enlargement and induration of the ovaries, chronic affections of the os uteri, dysmenorrhœa, enlargement of the spleen, chronic rheumatism and gout, pleurisy with effusion, and tubercular affections of the head and chest. The dose of iodine for internal use is from  $\frac{1}{4}$  to  $\frac{1}{2}$  gr. three times a day; of iodide of potassium, from 1 gr. to 12 or 15 grs.; of iodide of sodium, 5 to 20 grs.; of iodide of iron, 3 or 4 grs.; of iodide of mercury,  $\frac{1}{2}$  gr. to 1 gr.; of biniodide of mercury,  $\frac{1}{4}$  to  $\frac{1}{2}$  gr.; of iodide of sulphur, 2 or 3 grs.; of iodoform,  $\frac{1}{2}$  gr. to 2 grs. Iodine and the iodides are best given before or after eating; they are apt to irritate an empty stomach. A generous diet is usually advisable in connection with a therapeutic course of iodine or of the iodides.

**IONA**, or *Icolmkill*, called also *I* or *Hy*, a small island of the inner Hebrides, situated in lat. 56° 22' N., lon. 6° 25' W., 9 m. S. W. of Staffa, and separated from the island of Mull by a channel  $1\frac{1}{2}$  m. wide, called the sound of *I* or



Ruins of St. Mary's Church

of *Icolmkill*. It is embraced within the parish of Kilfinichen and county of Argyll, and is 3 m. long by  $1\frac{1}{2}$  m. broad; pop. about 300. It has an irregular surface of moorland, rising in places to 400 ft. About 600 acres of the island are under cultivation, producing barley

nd potatoes, but the chief occupation of the inhabitants is rearing black cattle and fishing. There is a small village, containing two churches, 40 or 50 detached cottages, and a school.—The island was given by the Pictish king Bridius in 563 to St. Columba (hence the name Icolmkill, the island of Columba of the ill), who founded there a celebrated monastery. Previous to his time the island was the chief seat of the rites of druidism. He established a college, which acquired great wealth and increased in influence till the time of the reformation. The Culdees controlled it until the beginning of the 13th century, when they were driven out by those who acknowledged the authority of Rome. A nunnery established on the island about this time continued till 1543, when Anna Macdonald, the last prioress, died. The religious establishment was altogether broken up by the act of the Scotch parliament (1560) abolishing all religious houses. The island then passed into the hands of the McLeans, but is now the property of the duke of Argyll.—Iona is said to have had at one time 360 stone crosses, resembling those of Ireland, but most of them were destroyed by Puritan zeal, and only four now remain. Sepulchral remains cover the island, both in the shape of cairns and of stone monuments of all kinds, Iona having been considered from time immemorial a sacred island. An old prophecy declared that seven years before the end of the world a second deluge would drown all nations, but that St. Columba's isle would swim above the flood; and this tradition made it the chosen cemetery of kings. Numbers of Scotch, Irish, Norwegian, and even French kings were buried there, the last of whom is said to have been the famous Macbeth. Among the principal ruins are the church of St. Mary, a cruciform building with a square tower about 75 ft. high, dating from the beginning of the 13th century; St. Mary's nunnery, built in the 12th; and St. Bran's chapel, probably in the 11th.

**IONIA**, in ancient geography, a country on the W. coast of Asia Minor, lying mainly between the river Hermus on the north and the *Meander* on the south, and including the islands of Chios and Samos. This district was named after the Ionians, who returned from Attica to these shores, from which they had previously migrated to European Greece, and founded there the 12 cities, Miletus, Myus, Priene, Ephesus, Lebedus, Colophon, Teos, Erythrae, Nazomenae, Phocæa, Chios, and Samos, which were designated as the Ionian Dodecapolis. (See IONIANS.) The new colonists settled among kindred Greek tribes engaged in fishing and navigation, and the Lydians seem to have allowed their settlements on the coast without regarding them as an encroachment. The Ionians demanded rights of supremacy and the best localities for the foundation of cities for themselves, and drove the old inhabitants out of their seats. The legends speak of their struggles with the Carians and Leleges. The

religious and political centre of the Dodecapolis was the Panionium, which was a temple of Neptune, on the N. slope of Mount Mycale, near Priene, where the common affairs of the independent republics were discussed at regular meetings. About 700 B. C. Smyrna, which until then had belonged to *Æolis*, became by treachery a member of the Ionian confederacy, which subsequently consisted of 18 cities. The country soon attained great prosperity. Before the middle of the 6th century, however, the Ionian cities became subject to Lydia, and on the fall of Cræsus they were annexed to the Persian empire by Cyrus. In 501 and 494 the Ionians made unsuccessful efforts to regain their independence, and they assisted the Greeks against the Persians at the battle of Mycale (479). The Persian yoke was at length shaken off by the victory at the Eurymedon, but the peace of Antalcidas (387) renewed it. On the overthrow of the Persian empire by Alexander, Ionia became subject to Macedon, subsequently to the Syrian and Pergamene kingdoms; and in 188 it fell into the hands of the Romans by the bequest of Attalus III. of Pergamus. The Ionian cities soon lost their importance, and under the Turkish supremacy all but Smyrna disappeared or sank into total insignificance. Though Ionia never possessed great political power, the commerce of its cities extended to the shores of the Black sea and the sea of Azov, as well as to the coasts of the Mediterranean. Ionia was the cradle of Greek epic and elegiac poetry, history, philosophy, medicine, and other sciences; it developed a new style of architecture, and it was the birthplace of several celebrated painters.

**IONIA**, a S. county of the southern peninsula of Michigan, drained by Grand river; area, 576 sq. m.; pop. in 1870, 27,681. It has an undulating surface, about half of which is densely wooded. Red sandstone is quarried. The soil is rich, and much of it alluvial. The Detroit and Milwaukee, and the Detroit, Lansing, and Lake Michigan railroads pass through it. The chief productions in 1870 were 665,521 bushels of wheat, 366,811 of Indian corn, 284,314 of oats, 316,487 of potatoes, 32,825 lbs. of hops, 120,870 of maple sugar, 317,261 of wool, 656,369 of butter, and 34,271 tons of hay. There were 6,514 horses, 7,424 milch cows, 1,844 working oxen, 8,093 other cattle, 78,541 sheep, and 10,686 swine; 12 manufactories of agricultural implements, 10 of carriages, 6 of cabinet furniture, 10 of iron castings, 8 of saddlery and harness, 9 of sash, doors, and blinds, 3 of woollen goods, 2 planing mills, 19 saw mills, and 9 flour mills. Capital, Ionia.

**IONIAN ISLANDS**, the collective name of seven islands belonging to Greece, six of which are in the Ionian sea (a name applied from ancient times to the part of the Mediterranean between the W. coast of Greece and the E. coast of Italy and Sicily), viz.: Corfu, Santa Maura, Ithaca or Thiaki, Cephalonia, Zante, Paxo, and Cerigo, with some smaller dependencies,

between lat. 35° 48' and 40° 30' N., and lon. 19° and 23° 18' E.; aggregate area, 1,113 sq. m.; pop. in 1870, 229,516. The islands are very mountainous, and mostly rise with rugged abruptness from the sea, but have fine havens on their coasts. Mt. Ænos in Cephalonia is 5,246 ft. high, and in the other islands there are elevations ranging from 1,000 to 3,800 ft. The geological formation is chiefly limestone, mixed with sandstone and gypsum. There are no active volcanoes. Most of the islands abound in fine natural scenery, and here and there bear luxuriant vegetation. The soil is generally dry and calcareous, and about half the surface is arable. The climate is variable, but healthy. The spring is mild, the summer hot and dry, the autumn rainy, and the winter tempestuous. The sirocco is often felt, and N. winds blow violently during winter. Snow falls often, but does not last long except on the mountains. Earthquakes are not uncommon. Iron, coal, manganese, sulphate of soda, marl, clay, chalcidony, quartz, and gray marble are the most important minerals. The principal vegetable products are the olive, lemon, orange, and fig, grapes, currants, wheat, maize, barley, oats, flax, pulse, and cotton. The last is of very good quality. The celebrated currants of Zante are the fruit of a dwarf vine. The valonia oak (*quercus agilops*) is valued for its acorns, besides being a beautiful tree. Madder grows wild, and the *cactus Opuntia*, which furnishes the food of the cochineal insect, thrives in all the islands, but is little attended to. Experiments in the culture of indigo have succeeded. Farms are mostly small, and are generally let annually on shares. Sheep and goats are the only animals reared in considerable numbers. The manufactures of these islands consist almost entirely of coarse cloths, earthenware, soap, salt, some silk and cotton fabrics, and filigree work. Although the coasts abound with fish, the fisheries are not prosecuted systematically. A large coasting trade is carried on. The imports are sugar, coffee, drugs, raw and manufactured cotton and silk, wool and woollen cloth, glass, hardware, staves and hoops, iron, timber, wheat, Indian corn, rice, flour, cheese, salted fish, cattle, sheep, drugs, and tobacco; the exports are currants and olive oil, also wine, brandy, liqueurs, honey, wax, valonia acorns, soap, salt, and hare and lamb skins.—The natives are Greeks, with a considerable admixture of Albanian and Italian blood. Italian is understood in most of the large towns, and is generally spoken by the higher classes. Some thousands of the islanders cross annually to the mainland to assist in the labors of harvest, for which they receive payment in grain. Education flourishes, and each of the islands has an academy supported by the government, at which ancient Greek, Latin, modern languages, and mathematics are taught. A university was founded at Corfu in 1823. Four fifths of the population belong to the Greek church, under the archbishops of Corfu, Zante,

Cephalonia, Santa Maura, and Cerigo. The Roman Catholics have an archbishop of Corfu and a bishop of Zante and Cephalonia. There are several thousand Jews, living chiefly in Corfu, and enjoying rights of citizenship.—In Grecian history these islands figured singly as Corcyra, Leucas, Ithaca, Cephallenia, Zacynthus, Paxos, and Cythera. In the 12th century they were taken by the kings of Sicily, and in the 14th fell under the jurisdiction of the Venetians, and so remained till the fall of Venice threw them into the hands of the French by the treaty of Campo Formio (1797). Russia and Turkey jointly expelled the French, and in 1800 erected these islands into the Septinsular republic, which, under the protection of Turkey, failed as an experiment of self-government. By a secret article in the treaty of Tilsit in 1807 they were given to the French; but being occupied by the British during the war from 1809 to 1814, they were secured to that power by the treaty of Paris in November, 1815. From 1814 to 1863 the islands were a republican confederation, under the protectorate of Great Britain, and were called the United States of the Ionian Islands. The government was vested in a lord high commissioner appointed by the British crown, and a parliament consisting of a senate and legislative assembly. Attempts at insurrection in 1848 and 1849 were suppressed with rigor. In 1863-4 they were incorporated with the kingdom of Greece, when Cerigo was united as an eparchy with the nomarchy of Argolis and Corinth, and the remaining islands were formed into three nomarchies, Corcyra (Corfu), Cephalonia, and Zante (Zacynthus). (See GREEKS.)

**IONIANS**, or *Iaones* (Gr. Ἰωνεῖς and Ἰάωνες), an ancient maritime race of Greek descent, having their chief seat in western Asia Minor and the adjacent islands. The name was extended to cover countries further west as Greece and the Greeks became better known, appearing in various dialectic forms, as Javan (*Yavana*) with the Hebrews, Yuna or Yauna with the Persians, Unim with the Egyptians, and the Yavanas or Yonas in India. E. Curtius conjectures that after the Ionians had learned navigation and become masters of their own sea, they sailed in the track of the Phœnicians, and settled beside them in all parts of the eastern Mediterranean. The monuments of Egypt show as early as the 18th dynasty the same group of hieroglyphs by which the Greeks were designated at the time of the Ptolemies, and it is believed that the Unim first known to the Egyptians were the Ionian Greeks. If this is correct, the Ionians were settled already about 1500 B. C. in the delta of the Nile. Cyprus is called Yavnán, the island of the Ionians (Ἰωνῶν Ἰαβών), when it first became known to the Assyrians in the reign of Sargon; but in some of Sargon's inscriptions it is corrupted into Yánnan. The Mosaic table of nations mentions the children of Javan, among whom are included the Kittim of Cyprus; but the name Javan

as is expressly stated, covers a multitude of islands. The prophet Joel curses the towns of Tyre and Sidon for selling the children of Judah and Jerusalem to the children of Javan, and removing them far away among the gentiles. It is therefore supposed that the Hebrews were acquainted with the Ionians as early as 1000 B. C. It is noticeable that the term *Ἴωνες* only once occurs in the Iliad, and that in one of its later parts. The legendary accounts of the Greeks say that about the middle of the 11th century B. C. the Ionians emigrated from Attica and settled on the shores of Asia Minor, expelling and exterminating some of the inhabitants, while others were allowed to amalgamate with them. Other myths speak of nations from the east settling in European Greece. Notwithstanding the pride taken by the Greeks in their autochthony, they constantly connect the foundation of their social life with the arrival of highly gifted strangers, whose supernatural power and wisdom were believed to have brought a new order into their life. E. Curtius says: "Two different points of view are, however, undeniably maintained throughout these myths: in the first place, the notion of the foreign element, . . . and secondly, the notion of common relationship." "In what other way can these two undeniably dominant ideas be explained and harmonized, except by assuming that the colonists in question were also Hellenes; that they came from the east indeed, but from a Greek east, where, with the receptivity of mind characteristic of the Ionian race, they had domesticated among themselves, and given a Hellenic transformation to, the civilization of the East, in order to hand it over in this state to the brethren of their own race? But since these Ionic Greeks, for so we may shortly designate them as a body of population, had not only settled in their own home, but also among the Phœnicians, in lands colonized by the latter, in Lycia and in Caria, and in the delta of the Nile, the settlers coming from the other side, the heroes and founders of towns in question, easily came to be called Phœnicians and Egyptians. For it is inconceivable that Canaanites proper . . . ever founded principalities among a Hellenic population." Thus at the beginning of history Curtius finds traces of the Ionians on the shores of the sea of Thessaly, and of the sea of Eubœa, called Hellopia, after a son of Ion; in southern Bœotia, especially on the Asopus and the declivities of the Helicon; in the whole of Attica; further in a long connected line on either shore of the Saronic and Corinthian seas; in Argolis, and on all the coasts of the Peloponnesus; and in the mountainous country of the interior. The movement of the Ionians from Attica to the W. coast of Asia Minor was accordingly a re-migration to the original settlements. It was the natural result of the overpeopling of southern Greece, occasioned by the violent advance of the northern highlanders or the continental tribes of the Hellenic nation. In the

midst of these movements, which had revolutionized all the states from Olympus to Cape Malea, Attica alone had remained tranquil; but it now became the refuge of the multitudes driven out of the other districts, and the narrow and poor little land was overflowing with inhabitants, so that relief became necessary. All the Greeks belonging to the old Ionic race, suffering under this great pressure, therefore started, and having preserved an inner connection notwithstanding their dispersion, they re-assembled in the middle coast tracts of Asia Minor, and this land around the mouths of the four rivers became the new Ionia, into which were transplanted the political institutions, priesthoods, and festive rituals of Attica. (See IONIA.)—The Yavanas in ancient Sanskrit literature are supposed to have been Ionians, who made inroads into India through the north-west, probably through Cashmere, coming from the Euphrates, and penetrating as far as Orissa. The term Yavana was applied also to Greeks left by Alexander to garrison the banks of the Indus. Though Sir William Jones interprets the word as designating Ionians or Asiatic Greeks, yet the chief argument in favor of it is the difficulty of attaching it to any other people. Yavana does not seem to be exclusively applied to the Greeks. According to Caldwell, it had originally that signification, and was subsequently applied to any race approaching India from the west. According to Lassen, it was used to designate only the Semitic nations. The modern Hindoos of northern India apply the term Yavana to Mohammedans of every description, but it is certain that in works prior to the Mohammedan era some other people must be intended. Bunsen supposes that it may be an ancient inaccurate name of a people who pushed on toward the Mediterranean. In the present state of these researches it is impossible to retrace with certainty the occupancy of central Asia and India by the ancient Ionians.—See Ernst Curtius, *Die Ionier vor der ionischen Wanderung* (Berlin, 1855), and *Geschichte und Topographie Kleinasiens* (1872); Hunter, "Orissa" (London, 1872); and Chabas, *Les peuples connus par les Egyptiens*, in *L'Antiquité préhistorique* (Paris, 1873).

IONIES, a small tribe of Indians in the United States, belonging to the family of the Caddoes or Cadodaquios. They regard the Hot Springs of Arkansas as their original seat. They formed part of the confederation known to the Spaniards as Texas or Friends, and were first known about the time of La Salle, who passed through their country. They were long on the Red river, but about 1823 moved into Texas, finally settling on the Brazos. With the Caddoes they had suffered from disease and from the attacks of the Osages and Comanches. Their houses are a conical framework of poles, about 25 ft. in diameter and 20 ft. high, thatched with long prairie grass, with low doors. They are among the best of the

Indian tribes, cultivating enough land for their support. They were removed by government in 1859 to the "leased district" on the Washita river near old Fort Cobb, Indian territory, and in 1872 numbered only 85.

**IOSCO**, a N. E. county of the southern peninsula of Michigan, bordering on Lake Huron and Saginaw bay, intersected by the Au Sable, and drained by the Au Grais river; area, 575 sq. m.; pop. in 1870, 3,163. The surface is nearly level, and partly covered with pine forests. In 1870 there were 11 saw mills, producing \$646,151 worth of lumber, and 1 manufactory of ground plaster. Capital, Tawas City.

**IOWA**, one of the interior states of the American Union, and the 16th admitted under the federal constitution, situated between lat. 40° 20' and 43° 30' N., and lon. 90° 12' and 96° 38' W.; general extent N. and S. 208 m., and E. and W. about 300 m.; area, 55,045 sq. m. It is bounded N. by Minnesota, E. by the Mississippi, which separates it from Wisconsin



State Seal of Iowa.

and Illinois, S. by Missouri, and W. by the Missouri and Big Sioux rivers, which separate it from Nebraska and Dakota. The state is divided into 99 counties, viz.: Adair, Adams, Allamakee, Appanoose, Audubon, Benton, Black Hawk, Boone, Bremer, Buchanan, Buena Vista, Butler, Calhoun, Carroll, Cass, Cedar, Cerro Gordo, Cherokee, Chickasaw, Clarke, Clay, Clayton, Clinton, Crawford, Dallas, Davis, Decatur, Delaware, Des Moines, Dickinson, Dubuque, Emmett, Fayette, Floyd, Franklin, Fremont, Greene, Grundy, Guthrie, Hamilton, Hancock, Hardin, Harrison, Henry, Howard, Humboldt, Ida, Iowa, Jackson, Jasper, Jefferson, Johnson, Jones, Keokuk, Kosuth, Lee, Linn, Louisa, Lucas, Lyon, Madison, Mahaska, Marion, Marshall, Mills, Mitchell, Monona, Monroe, Montgomery, Muscatine, O'Brien, Osceola, Page, Palo Alto, Plymouth, Pocahontas, Polk, Pottawattamie, Poweshiek, Ringgold, Sac, Scott, Shelby, Sioux, Story, Tama, Taylor, Union, Van Buren, Wapello, Warren, Washington, Wayne, Webster, Winnebago, Winneshieck, Woodbury, Worth, Wright. Des

Moines is the capital. The cities of Iowa, as reported by the census of 1870, were: Burlington, having 14,980 inhabitants; Cedar Falls, 3,070; Cedar Rapids, 5,940; Clinton, 6,129; Council Bluffs, 10,020; Davenport, 20,038; Des Moines, 12,035; Dubuque, 18,435; Fairfield, 2,226; Fort Dodge, 3,095; Fort Madison, 4,011; Glenwood, 1,291; Independence, 2,945; Iowa City, the former capital, 5,914; Keokuk, 12,766; Lyons, 4,088; McGregor, 2,074; Maquoketa, 1,756; Marshalltown, 3,218; Muscatine, 6,718; Oskaloosa, 3,204; Ottumwa, 5,214; Sioux City, 3,401; Waterloo, 4,337; Waverly, 2,291; and Winterset, 1,485. The population of Iowa (exclusive of tribal Indians, now numbering about 300, other Indians being included in the total), according to the federal census, and its rank in the Union, have been as follows:

YEARS.	White.	Colored.	Total.	Rank.
1840.....	42,924	199	43,123	99
1850.....	191,951	888	192,839	57
1860.....	673,779	1,069	674,848	39
1870.....	1,188,207	5,763	1,193,970	11

According to the state census of 1873, the population had increased to 1,251,333. There were 231,540 dwellings and 238,098 families. The number of persons entitled to vote was 261,205; of militia, 190,383; of foreigners not naturalized, 26,250. The population of Burlington was returned at 20,156; Council Bluffs, 10,525; Davenport, 20,550; Des Moines, 15,061; Dubuque, 22,151; Keokuk, 11,761. Of the total population in 1870, 625,917 were males and 568,103 females; 989,328 were of native and 204,692 of foreign birth, including 115,033 males and 89,639 females. Of the native population, 428,620 were born in the state, 65,391 in Illinois, 64,083 in Indiana, 14,186 in Kentucky, 5,943 in Maine, 5,972 in Maryland, 8,929 in Massachusetts, 8,918 in Michigan, 13,831 in Missouri, 5,057 in New Hampshire, 5,688 in New Jersey, 79,148 in New York, 5,090 in North Carolina, 126,285 in Ohio, 73,435 in Pennsylvania, 12,204 in Vermont, 19,558 in Virginia and West Virginia, and 24,309 in Wisconsin. Of the foreigners, 17,907 were born in British America, 2,827 in Denmark, 3,130 in France, 66,162 in Germany, 16,660 in England, 40,124 in Ireland, 5,248 in Scotland, 1,967 in Wales, 4,513 in Holland, 17,558 in Norway, 10,796 in Sweden, and 3,937 in Switzerland. The density of population was 21.69 to a square mile. There were 222,430 families with an average of 5.37 persons to each, and 219,846 dwellings with an average of 5.44 persons to each. The increase of population from 1860 to 1870 was 76.91 per cent. The number of male citizens 21 years old and upward was 255,802. There were 894,696 persons from 5 to 18 years of age; the total number attending school was 306,353; 24,115 persons 10 years old and upward were unable to read, and 45,971 could not write; of the latter, 24,979 were of native and 20,692 of foreign birth; 44,148

white and 1,524 colored; 21,065 were and 24,704 females; 5,928 were from 10 years of age, 3,826 from 15 to 21, and 21 and over, of whom 14,782 were white 19,825 white females, 635 colored males, 1 colored females; 5.3 per cent. of the hults and 8.37 per cent. of the female were illiterate. The number of paupers ted during the year ending June 1, 1870, 443, at a cost of \$175,179; 853 were re-support at the end of the year, of whom cluding 56 colored, were of native, and foreign birth. The number of persons ed of crime during the year was 615.

number (397) in prison June 1, 1870, re of native and 110 of foreign birth. ate contained 465 blind, 549 deaf and 742 insane, and 533 idiotic. Of the to- lulation 10 years of age and over (837,- here were engaged in all occupations ; in agriculture, 210,263, of whom 69,- are laborers, 139,478 farmers and plant- d 810 gardeners and nurserymen; in ional and personal services, 58,484, in- : 1,596 clergymen, 15,725 domestic ser- 202 journalists, 24,823 laborers not spe- l, 456 lawyers, 1,865 physicians and sur- 6,012 teachers not specified; in trade nsportation, 28,210; and in manufac- nd mechanical and mining industries,

The number of deaths from all causes 97; from consumption, 1,313, being one rom that disease to 7.3 from all causes; neumonia, 678, or 1 to 14.2; from ing cough, 337, being a higher ratio of rom that disease than in any other state Nebraska and Arkansas; from diphtheria rlet fever, 473; intermittent and remit- vers, 161; enteric fever, 521; diarrhœa, sentery, 228; enteritis, 238.—Besides the ivers which bound it, Iowa has a large : of interior watercourses, many navi- nd others of less dimensions, but sup- abundant water power. All the streams state flow into the great boundary rivers. ississippi receives the Des Moines, the ne or Skunk, the Iowa and its affluent l Cedar, the Wapsipicon, the Maquo- e Turkey, the Upper Iowa, &c., all of have S. E. courses, and generally run with each other. The Iowa rises in k co., in the northern part of the state, pties into the Mississippi 85 m. above ton; its length is about 300 m., and ivable to Iowa City, 80 m. The riv- ring to the Missouri are short, and as me scarcely compare with the small- s flowing to the Mississippi. The Big forms a portion of the W. boundary. ariton, Grand, Platte, Nodaway, and batona rise in the south of Iowa, pass ssouri, and join the Missouri river in re through that state. The largest river of the state is the Des Moines, flows from N. W. to S. E. not less 00 m. through Iowa, and drains more

than 10,000 sq. m. of its territory. It forms a portion of the boundary line between Iowa on the N. E. and Missouri on the S. W. Next in size of the interior rivers is the Red Cedar, which rises in Minnesota, and after a S. E. course joins the Iowa in Louisa co. about 30 m. from its mouth. One of the most important streams of N. W. Iowa is Little Sioux river, which rises near the Minnesota border, and after meandering about 250 m. falls into the Missouri. In the northern portion of the state there are numerous small but beautiful lakes, which are a part of the system of lakes extending northward into Minnesota. One of the largest, Lake Okoboji, in Dickinson co., is about 15 m. long and from  $\frac{1}{2}$  to 2 m. wide.—The surface of Iowa is generally undulating, and forms a country of unrivalled beauty. It has no mountains nor even high hills; yet on the margins of the rivers there are frequent bluffs of calcareous strata intersected by ravines. These bluffs are generally from 40 to 130 ft. high, and are the breastwork of table lands which sweep away from them in gentle undulations. The southern portion of the state is the most picturesque, abounding with grassy lawns and verdant plains, interspersed with groves and meandering rivulets, and intersected by the larger rivers which flow to the Missis- sippi or by the numerous affluents of the Mis- souri. In the northeastern part the surface is more elevated, hills and mounds are not un- common, their tops covered with towering oaks, and the rivers tumble over precipitous ledges of craggy rocks. The N. E. section abounds in lead ore and various other metals, but nevertheless contains much excellent land. The unique and admirably diversified prair- ies of Iowa are, however, its most distin- guishing feature. These natural meadows are covered with a rich coating of coarse grass, forming excellent pasturage, and are not un- frequently interspersed with hazel thickets and fragrant shrubs, and in the season of flowers are decorated with a brilliant garniture of honey- suckles, jessamines, wild roses, and violets.—A geological survey of Iowa was begun under the direction of Prof. James Hall, the chemical and mineralogical department being conducted by Mr. J. D. Whitney, and a report in 2 vols. 8vo was published in 1858-'9, which presents the general arrangement of the formations, with details of their fossils and economical impor- tance. The survey was resumed in 1866, under the direction of Dr. Charles A. White of Iowa City. The geological formations are exclusively palæozoic, their range being from the Potsdam sandstone to the coal measures, inclusive. The latter formation occupies the S. and W. portion of the state, and reaches within a few miles at its S. E. corner of the Mississippi river, from which it is separated by a belt of about 20 m., over which the carboniferous limestone is spread out. This limestone outcrop thence ex- tends diagonally across the state to the ex- treme N. W. corner. Toward the northeast

lower formations continue to appear in succession, and stretch in long parallel belts N. W. and S. E. The course of the rivers, as they descend from the N. border of the state to the Mississippi, is along the range of these formations; and it is remarkable how each river keeps almost exclusively along the same geological belt for nearly 200 m. The successive belts are thus designated by Prof. Hall, advancing N. E. in the descending series from the coal measures and the underlying carboniferous limestone: the Hamilton and Chemung groups of the Devonian series, the Leclaire and Niagara limestones of the upper Silurian, the Hudson river shales, Galena limestone, Trenton limestone, St. Peter's sandstone, and Potsdam sandstone of the lower Silurian. The last occupy the N. E. corner of the state. The coal measures are regarded as the most permanent source of mineral wealth, though the lead mines in the Galena limestone have attracted the earliest and greatest attention, and have so far been the most important in the value of their productions. Their aggregate thickness in the S. part of the state is less than 500 ft., and in this are found several workable beds of bituminous coal, one of which is sometimes 7 ft. thick. The formation thins out as it spreads over the carboniferous limestone, and in this are found several outlying shallow basins of small extent. They are also met with beyond the limits of this rock, scattered in the depressions of the Devonian, and even the Silurian series, and resting unconformably upon the upturned edges of these lower formations. Along the Mississippi river, between Davenport and Muscatine, a deposit of this character stretches 20 m. up and down the river, and not more than 3 m. back from it. This is the extension on the Iowa side of the Illinois coal field, the Mississippi river having completely separated this marginal portion from the main body. The thickness of this isolated group of coal measures is not more than about 70 ft. It contains one coal bed which is identified as the lowest workable coal of the series; it is of no great importance, being only about 2½ ft. thick. A few yards beneath it is a bed of carbonaceous slate, which sometimes presents a seam of cannel coal a foot thick. The coal field of the state embraces an area of about 20,000 sq. m.; the coal is bituminous and of excellent quality. In the N. part of the state are extensive beds of superior peat from 4 ft. to 10 ft. in depth. The lead mines are in the belt occupied by the Galena limestone. This tract reaches the Mississippi river at Dubuque, and lies along the valley of Turkey river toward the N. W.; but the only mines that have been worked in it are near the Mississippi. The ore is chiefly found in vertical crevices which are traced in E. and W. lines with remarkable regularity. They are congregated in great number in the immediate vicinity of Dubuque, and from the report of the state geologists it appears that no district in the Mississippi valley has

produced so large an amount of ore for its extent as this tract of 12 or 15 sq. m. From 4,000,000 to 6,000,000 lbs. of ore have been smelted annually at the Dubuque mines, yielding about 70 per cent. of lead. The crevices in the limestone are frequently found to expand into what are called openings and large caves several hundred feet long. The walls of these are incrustated with the sulphuret of lead, of which a single cave sometimes furnishes several million pounds. The depth of the mines is limited to the thickness of the Galena limestone, which seldom reaches 200 ft. In the blue limestone, which underlies it, the crevices either close up or are unproductive. The yield of ore is very irregular, and the same mines rarely continue to be worked for even a few years. (See LEAD.) Iowa has also small deposits of iron ore, and there are many other minerals of considerable value. A deposit of gypsum of remarkable fineness and purity exists near Fort Dodge; it is confined to an area of about 6 by 3 m. on both sides of the Des Moines river, and is from 25 to 30 ft. thick. Plaster of Paris of superior quality has been manufactured from it. Building stone of the best description, various clays, &c., sufficient for all present or prospective requirements, are found.—The soils of Iowa are generally excellent, and no state of the Union has a smaller amount of inferior land. The valleys of the Red Cedar, Iowa, and Des Moines, as high as lat. 42° 30', present a body of arable land which, taken as a whole, for richness in organic elements, for amount of saline matter, and due admixture of earthy silicates, affords a combination that belongs only to the most fertile upland plains. North of this, the best agricultural region of the state, the lands are inferior, but still not unprofitable, and the lower grounds are either wet and marshy or filled with numerous ponds, and entirely destitute of timber.—The climate of Iowa is moderate, and highly favorable for agricultural operations. As a general rule the peach blossoms in mid April, and wheat ripens early in August. The winters, however, are severe from the prevalence of N. and N. W. winds, which sweep over the level prairies without obstruction; but they are very equable and healthful. In summer the winds are from the west and south, and, being constant, greatly relieve the heats of that season. The mean temperature of the year is about 48° F.; spring, 47½°; summer, 70½°; autumn, 45°; winter, 23½°. The highest temperature observed for 30 years was 99°, Aug. 31, 1854; the lowest —30°, Jan. 18, 1857. The temperature is seldom lower than —10°, or higher than 90°. The mean annual amount of rainfall for 30 years was 44.27 in.; least, 28.36 in.; greatest, 74.49 in. Iowa is classed among the most healthy countries of the world, a fact to be attributed to the excellent drainage furnished by its rolling surface. The exceptions to this condition are very rare.—The natural growths of Iowa are similar to those of the whole middle zone of the



North of lat. 42° timber is comparatively but south of that line and along the the country is well wooded. Ash, elm, and white maple, and cottonwood grow over bottoms; and in other localities are poplar, oak, hickory, walnut, basswood, &c. the north there is some pine timber. of cedar are found along the Iowa and the rivers. Among fruit trees, the apple, and pear attain the highest perfection; plum, grape, and gooseberry are indigenous. For the cultivation of the cereals no the country surpasses this state; it is favorable both in climate and soil for the oil plant, flax, tobacco, &c. Potatoes are a favorite staple. Tea has been raised in Crawford co., the yield being over 700 lbs. per acre. Iowa ranks high in agriculture. According to the census of 1870, it produced wheat and Indian corn than any other state in the Union except Illinois, and ranked first in the production of oats. The state had 9,396,467 acres of improved land, 96 of woodland, and 3,620,533 of other unimproved land. The total number of farms was 116,292, of which 84,041 contained from 0 to 50 acres, 41,372 from 50 to 100, 10,100 from 100 to 500, 321 from 500 to 1,000, and 1,800 over 1,000. The cash value of farms was \$2,662,441; of farming implements and machinery, \$20,509,582; total amount of wages during the year, including value of board, \$78; total (estimated) value of all farm products, including betterments and additions to stock, \$114,886,441; value of orchards, \$1,076,169; of products of market gardens, \$244,963; of forest products, \$1,200,000; of home manufactures, \$521,404; of animals slaughtered or sold for slaughter, \$25,-

781,223; of all live stock, \$82,987,133. There were on farms 433,642 horses, 25,485 mules and asses, 369,800 milch cows, 614,366 other cattle, 855,493 sheep, and 1,353,908 swine. The chief productions were 28,708,312 bushels of spring and 727,380 of winter wheat, 505,807 of rye, 68,935,065 of Indian corn, 21,005,142 of oats, 1,960,779 of barley, 109,432 of buckwheat, 42,313 of peas and beans, 5,914,620 of Irish and 34,292 of sweet potatoes, 2,475 of clover seed, 53,432 of grass seed, 88,621 of flax seed, 1,777,339 tons of hay, 71,792 lbs. of tobacco, 2,967,043 of wool, 27,512,179 of butter, 1,087,741 of cheese, 146,490 of maple sugar, 171,113 of hops, 695,518 of flax, 853,213 of honey, 2,225 of wax, 37,518 gallons of wine, 688,800 of milk sold, 1,218,635 of sorghum and 9,315 of maple molasses. According to the state census, the number of acres of improved land in 1872 was 9,987,788. There were produced in that year 32,437,836 bushels of wheat, 141,744,522 of Indian corn, 22,113,013 of oats, 5,770,169 of barley, and 2,348,884 lbs. of wool. The total assessed value of live stock in 1873 was \$36,521,346. There were 1,178,017 cattle, valued at \$12,931,807; 557,052 horses, \$18,936,037; 32,010 mules, \$1,357,478; 523,089 sheep, \$572,438; and 1,460,784 swine, \$2,723,586.—The total number of manufacturing establishments was 6,566, having 899 steam engines of 25,298 horse power, and 726 water wheels of 14,249 horse power, and employing 25,032 hands, of whom 23,395 were males above 16 years of age, 951 females above 15, and 686 youths. The capital invested amounted to \$22,420,183; wages paid during the year, \$6,893,292; value of materials, \$27,682,096; products, \$46,534,322. The chief industries were as follows:

INDUSTRIES.	Number of establishments.	Steam engines, horse power.	Water wheels, horse power.	Hands employed.	Capital invested.	Wages paid.	Value of materials.	Value of products.
Farming implements.....	55	457	20	552	\$548,040	\$182,188	\$401,372	\$829,965
Shoes.....	886	.....	.....	1,607	491,562	206,923	438,176	1,320,019
Woolen goods.....	590	.....	.....	1,292	401,593	301,174	543,086	1,218,480
Woolen and building.....	883	48	.....	2,385	298,220	527,888	1,550,274	2,981,988
Wagons.....	449	208	.....	1,662	1,084,882	566,222	739,240	1,952,143
Wheat and grist mill products.....	502	7,236	10,172	1,867	5,765,738	600,565	11,961,444	15,635,345
Wool.....	223	439	62	959	670,625	295,348	340,124	981,691
Salt.....	101	191	3	405	1,238,134	181,571	422,148	992,545
Planed.....	21	522	.....	191	201,800	82,738	707,344	867,415
Sawed.....	545	12,758	2,598	3,782	3,925,001	995,962	3,302,782	5,794,285
Woolen and.....	10	85	.....	328	927,150	45,170	1,064,100	1,190,400
Woolen and harness.....	325	.....	.....	879	417,615	208,232	591,272	1,110,522
Woolen goods.....	68	968	907	1,088	1,882,784	264,061	929,182	1,561,341

has no direct foreign commerce, but with the Atlantic and gulf ports and prior is comparatively extensive. The consist of the products of agriculture and the imports of eastern and foreign manufactures, groceries, &c. The shipping are Keokuk, Fort Madison, Burlington, Des Moines, Davenport, Clinton, Bellevue, Dubuque, McGregor, &c.; and at all of these places the trade is also carried on with the extent which they are connected to a large

extent by river steamboat routes and by railroad. The state has three United States ports of delivery, Burlington, Dubuque, and Keokuk. The total number of vessels registered, enrolled, and licensed in 1873 was 78, having a tonnage of 5,489; 70 of these belonged to Dubuque. At this point boat building is carried on to some extent; five vessels of 497 tons, including four steamers, were built here in 1873. In November, 1873, 75 national banks were in operation; paid-in capital, \$6,017,000;

bonds on deposit, \$5,909,000; circulation outstanding, \$5,363,885. The bank circulation of the state amounted to \$5,074,385, being \$4 75 per capita, 8 per cent. of the wealth of the state, and 88.3 per cent. of the banking capital. There were 23 banks, of which 15 were savings banks, organized under the laws of the state, having \$1,015,956 capital stock paid in, with assets amounting to \$3,879,083.—In the development of its railroad system Iowa has made rapid progress. The total mileage of main track has increased from 68 m. in 1855 to 655 in 1860, 891 in 1865, 2,663 in 1870, 3,160 in 1871, 3,643 in 1872, and 3,744 in 1873. In 1856 and 1864 grants of lands were made by congress to the state to aid in the construction of railroads; these lands were in turn granted by the state to various companies for the construction of five great trunk lines crossing it from east to west and extending from the Mississippi to the Missouri river. Four of these are now in operation, and the fifth is partially built. The most southerly is the Burlington and Missouri River railroad, which extends from Burlington to Council Bluffs. The Chicago, Rock Island, and Pacific, and the Chicago and Northwestern, have the same place as their western terminus in Iowa, the former extending from Davenport

and the latter from Clinton. At Council Bluffs, which is on the opposite side of the Missouri river from Omaha, Nebraska, these three lines connect with the Union Pacific railroad, which has its eastern terminus at this point, a bridge having been constructed across the Missouri. The next grand line crossing the state is the Iowa division of the Illinois Central railroad, which extends from Dubuque to Sioux City. The projected line will connect McGregor opposite Prairie du Chien, Ill., with Sioux City; it has been completed to Algona, 169 m. from the Mississippi, and is now (1874) operated by the Milwaukee and St. Paul railroad company. All these great channels have communication with Chicago and the great eastern commercial centres, and for their accommodation the Mississippi has been spanned with several bridges. The numerous railroads crossing these trunk lines give Iowa extended facilities of communication with the states lying to the north and the south. The assessed value of the 3,643 m. of railroad in the state in 1873 was \$18,842,592. The railroads lying wholly or partly within the state, together with their termini, are indicated in the following table, which shows also the number of miles completed within the state in 1873, and the entire length of the various lines:

NAME OF CORPORATION.	TERMINI.	Length completed in state, miles.	Total length between termini when finished, miles.
Burlington, Cedar Rapids, and Minnesota Milwaukee division.....	Burlington and Austin, Minn. ....	243	243
Branches.....	Cedar Rapids to Postville.....	106	...
	Vinton to Trues.....	25	...
	Muscotine to Iowa river.....	37	...
Burlington and Missouri River.....	Burlington and Council Bluffs.....	202	...
Branches.....	Chariton to Leon.....	22	...
	Creston to Hopkine.....	44	...
	Villisca to Clarinda.....	16	...
	Red Oak to East Nebraska City.....	51	...
Burlington and Southwestern.....	Burlington and St. Joseph, Mo.....	50	200
Central of Iowa.....	Northwood and Albia.....	180	...
Chicago, Burlington, and Quincy (branch).....	Burlington and Keokuk.....	42	...
Chicago, Clinton, and Dubuque.....	Clinton and Dubuque.....	60	...
Chicago, Dubuque, and Minnesota.....	Dubuque and La Crescent, Minn.....	92	119
Chicago and Northwestern:			
Iowa (Chicago, Iowa, and Nebraska).....	Clinton and Cedar Rapids.....	62	...
Division (Cedar Rapids and Missouri River).....	Cedar Rapids and Council Bluffs.....	273	...
(Stanwood and Tipton).....	Stanwood and Tipton.....	9	...
(Iowa Midland).....	Clinton and Anamosa.....	71	...
Chicago, Rock Island, and Pacific:			
Iowa division.....	Davenport and Council Bluffs.....	310	...
Branches.....	Wilton to Washington.....	20	...
	Washington to Sığourney.....	22	...
	Des Moines to Indianola.....	21	...
	Summerset to Winterset.....	25	...
Chicago and Southwestern.....	Washington and Leavenworth, Kan.....	125	271
Davenport and St. Paul.....	Davenport and Fayette.....	125	...
Branch.....	Eldridge to Maquoketa.....	22	...
Des Moines Valley.....	Keokuk and Fort Dodge.....	240	...
Dubuque and Southwestern.....	Farley and Cedar Rapids.....	55	...
Illinois Central:			
Iowa Division.....	Dubuque to Iowa Falls.....	143	...
	Iowa Falls to Sioux City.....	174	...
	Cedar Falls to Mona.....	76	...
Kansas City, St. Joseph, and Council Bluffs.....	Kansas City, Mo., and Council Bluffs.....	51	200
Milwaukee and St. Paul.....	Milwaukee, Wis., and St. Paul, Minn.....	55	205
Branches.....	Calmar to Algona.....	122	...
	Conover to Decorah.....	10	...
	Mason City to Austin, Minn.....	28	60
	Sabula to Marion.....	57	...
Missouri, Iowa, and Nebraska.....	Alexandria, Mo., and Nebraska City, Neb.....	12	200
St. Louis, Kansas City, and Northern (branch).....	Moberly, Mo., to Ottumwa.....	48	121
Sioux City and Pacific.....	Sioux City and Fremont, Neb.....	60	127
Sioux City and St. Paul.....	Sioux City and St. James, Minn.....	57	145

—The present constitution of Iowa was adopted in convention, March 5, 1857. It grants the right of voting to every male citizen of the United States who has resided in the state six months and in the county 60 days. The general election is held on the second Tuesday in October, except in the years of the presidential election, when it occurs on the Tuesday next after the first Monday in November. The legislature consists of a senate of 50 members elected for four years, half biennially, and a house of 100 members elected biennially. Senators must be 25 and representatives 21 years of age, and otherwise must have the qualifications of voters. In all elections by the legislature votes are given *viva voce*. The legislature meets on the second Monday of January biennially (even years). The governor and lieutenant governor are chosen by a plurality of votes, and hold office for two years. They must be at least 30 years of age, and have been citizens and residents for two years next preceding election. The salary of the governor is \$3,000 per annum. The secretary of state, auditor of state, treasurer of state, register of state land office, and superintendent of public instruction are elected by the people for two years, and have each a salary of \$2,200. The lieutenant governor and attorney general (salary \$1,500) are elected for two years, and the supreme court clerk and reporter are elected for four years. The adjutant and inspector general (salary \$2,000) and state librarian (salary \$1,200) are appointed by the governor for two years. The judicial power is vested in a supreme court, district courts, and such other courts, inferior to the supreme court, as the legislature may establish. The supreme court, with appellate jurisdiction only in chancery cases, consists of four judges elected by the people for six years, one every second year, and the one having the shortest time to serve is chief justice. Judges of the district court are elected in single districts (of which there are now 13) for four years. The salary of supreme court judges is \$4,000, and of district judges \$2,200 per annum. A district attorney is elected in each judicial district for four years. There are also 13 circuit courts, each with one judge, the circuits having the same boundaries as the judicial districts. The county officers consist of a board of supervisors, auditor, clerk, treasurer, recorder, sheriff, superintendent of common schools, surveyor, and coroner. The counties are subdivided into townships, each of which elects three trustees, a clerk, justices of the peace, constables, and road supervisors. Among the general provisions of the constitution are the following: The credit of the state shall not be given for any purpose; deficits in the revenue may be made up by borrowing money, but the sum not to exceed \$250,000 at any one time; debt may be contracted to repel invasion or suppress insurrection; no corporation shall be created by special law; stockholders in banks shall be individually liable to

double the amount of the stock, and billholders shall have preference over other creditors; suspension of specie payment shall not be permitted; no new county shall be made of less than 492 sq. m., nor shall any existing county be reduced below that size; no lease of agricultural lands shall be for more than 20 years; aliens, residents of the state, may hold and transmit real estate; imprisonment for debt is prohibited except in cases of fraud; parties in suit may be witnesses; duellists are disqualified from holding any office; the legislature is prohibited from granting divorces, or authorizing lotteries; in all prosecutions for libel the truth may be given in justification. The constitution requires a census to be taken in 1875 and every ten years thereafter; but a state census has been taken at frequent intervals. In 1872 the death penalty as a punishment for crime was abolished by a vote of 29 to 17 in the senate and 66 to 22 in the house; and it was provided that all crimes previously punishable with death should be punished by imprisonment for life, and that in these cases the governor shall not be empowered to grant a pardon except upon the recommendation of the general assembly. The executive council is required on the first Monday of March in each year to assess all the property of every railroad company in the state used in the operation of their roads; and it is made the duty of the officers of the company to report under oath the necessary facts for such assessment. All railroad property is taxable at the same rates and in the same manner as that of individuals. No distinction is made in law between the husband and the wife in regard to property. One third in value of all the real estate of either, upon the death of the other, goes to the survivor in fee simple. Neither is liable for the separate debts of the other. The wife may make contracts and incur liabilities which may be enforced by or against her in the same manner as if she were unmarried; and so a married woman may sue and be sued without the husband being joined in the action. Iowa is represented in congress by nine representatives and two senators, and has therefore 11 votes in the electoral college.—The total bonded debt of the state in November, 1873, was \$543,056. The receipts into the state treasury during the two years ending Nov. 1, 1873, amounted to \$2,407,988, and the disbursements to \$2,446,680. The income was from the following sources:

State tax levy.....	\$1,595,010	81
Interest on delinquent taxes.....	54,195	19
Insane dues from counties.....	224,250	13
Peddlers' licenses.....	8-3	66
Sale of laws and revisions.....	765	58
Railroad taxes received in 1873.....	84,290	68
Taxes on insurance companies.....	76,731	28
Auditor's fees from insurance companies.....	81,091	83
Secretary of state, fees.....	3,258	50
Register of the state land office, fees.....	215	25
United States war and defence fund.....	102,347	86
Sale of arms, &c.....	5,218	06
Other sources.....	278,861	85
Total.....	\$2,407,988	56

The total valuation of taxable property after equalization by the state board of assessment, and the state tax thereon, for a series of years have been as follows:

YEARS.	Total valuation.	Rate.	State tax.
1854.....	*\$214,625,730	1½ mills	*\$921,088 60
1859.....	197,823,250	1½ "	296,784 81
1860.....	*198,850,580	1½ "	*290,078 80
1861.....	177,451,008	2 "	354,901 92
1862.....	177,000,000	2 "	350,000 00
1863.....	167,108,974	2 "	334,217 90
1864.....	165,000,000	2 "	330,000 00
1865.....	215,068,401	2 "	430,126 88
1866.....	220,000,000	2½ "	550,000 00
1867.....	258,517,184	1:½ "	641,292 88
1868.....	250,000,000	1:½ "	650,000 00
1869.....	254,523,252	2 "	509,064 44
1870.....	300,000,000	2 "	600,000 00
1871.....	348,642,723	2 "	697,285 55
1872.....	366,076,206	2½ "	915,190 51
1873.....	364,886,560	2 "	723,672 73

The valuation for 1873 included 33,730,669 acres of land; reported value, \$217,907,148; reported value of town lots, \$47,642,585; equalized value of lands and town lots, \$273,797,687; value of personal property, \$71,683,367; of railroad property, \$18,885,526; reported total value, \$356,088,626; total equalized value, \$364,836,580. The entire tax in 1872 amounted to \$10,711,925, as follows: state tax, 2½ mills, \$909,464; county, \$1,460,734; insane hospital, \$217,691; county school, \$402,435; district school, \$3,954,210; bridge, \$705,445; road, \$360,700; special, \$433,108; judgment and bond, \$598,471; corporation, \$340,359; railroad, \$1,329,303.—The college for the blind at Vinton receives students who are citizens of the state free of charge for board and tuition. This school is strictly educational, and not for the treatment of disease. Since its opening in 1853, 269 pupils have been admitted; the number attending in 1873 was 112, who were instructed by 10 teachers. The total current expenditures for the two years ending Nov. 4, 1873, amounted to \$51,175. Instruction is afforded to the deaf and dumb of the state, between the ages of 10 and 25 years, by the institution at Council Bluffs; such persons may receive their board and instruction free of charge for a period of seven years. Established in 1855, this institution in 1873 had 7 instructors and 119 pupils; the current expenses for the two years ending Nov. 1, 1873, were \$56,221. Iowa has two hospitals for the insane: one at Mt. Pleasant, which at the end of 1873 had 495 inmates, and for which \$229,441 had been expended during the previous two years; and the other at Independence, which was opened in May, 1873, and at the close of the year had 152 patients. Of the patients treated in the former during the two years ending with 1873, 28.16 per cent. had recovered, 21.65 per cent. had improved, and

27.64 per cent. had remained stationary. Iowa has three soldiers' orphans' homes, at Cedar Falls, Davenport, and Glenwood. The support of these institutions during 1873 cost the state \$146,050, besides \$12,000 expended for improvements and \$550 for libraries. At the end of the year there were in these homes 508 children, of whom 256 were at Cedar Falls, 154 in Davenport, and 98 at Glenwood. There is a reform school for boys at Eldora, and one for girls near Salem. In 1873 there were in the former 146 boys and in the latter 11 girls. The cost of the boys' school for the two years ending Nov. 1, 1873, was \$32,031, and of the girls' \$2,250. The penitentiary at Fort Madison has 318 cells, and at the close of 1873 contained 276 convicts, of whom 63 were sentenced by the United States. The labor of the convicts who are employed within the prison is disposed of by contract at 40½ cents a day for each laborer. The number thus employed in 1873 was 258, and the earnings from this source for two years amounted to \$54,061. These contracts will expire Jan. 1, 1875, when it is believed that much higher rates will be realized. The institution is self-sustaining. The total receipts for the two years ending Nov. 1, 1873, were \$134,899, and the expenditures \$118,912. Another penitentiary is in process of construction at Anamosa, in Jones county.—According to the census of 1870, the total number of educational institutions in Iowa was 7,496, having 9,319 teachers, of whom 5,663 were females, and 217,654 pupils. There were 7,322 public schools, with 6,666 teachers and 205,923 pupils; 21 colleges, with 139 teachers and 3,061 students; 34 academies, with 103 teachers and 2,333 pupils; and 100 private schools, with 136 teachers and 4,673 pupils. The total income of all the educational institutions was \$3,570,093, of which \$63,150 was from endowment, \$3,347,629 from taxation and public funds, and \$159,314 from tuition and other sources. The system of public schools is substantially the same as that adopted in 1858. The constitution of 1857 vested the management of the educational institutions of the state in a board of education, consisting of the governor, the lieutenant governor, and an elected member from each judicial district in the state. This body was not empowered to levy taxes or make appropriations of money for school purposes, but was required to provide for the education of all the youths of the state through a system of common schools; such schools to be organized and kept in every school district at least three months a year, and any district failing to do so for two consecutive years may be deprived of its portion of the school fund. The permanent school fund embraces all lands granted to the state by the general government for schools, and all estates of deceased persons who have died without leaving a will or heir. The money paid for exemption from military duty, and the net proceeds of all fines collected in the several coun-

\* Partly estimated, some counties not having reported.  
 † Estimated, the valuation of realty being the same as the year previous.

Iowa was adopted in 1847. It grants the right of suffrage to every white citizen of the state who has resided in the state six months and paid taxes 30 days. The general election is held on the second Tuesday in October of the presidential year, and the Tuesday next thereafter. The legislature consists of 50 members, elected biennially, and a lieutenant-governor elected biennially. Senators are elected for four years and representatives 2½ years. They have the qualifications prescribed by the legislature. The legislature meets on the first Monday of January in each year. The governor and lieutenant-governor are elected by a plurality of votes. The governor must have been a citizen of Iowa for five years next preceding his election. His term of office is four years. The salary of the governor is \$3,000 per annum, and of the lieutenant-governor \$2,000. The auditor of state land is elected for two years, and his salary is \$1,500. The supreme court consists of five judges, elected for four years. The clerk of the supreme court is elected by the governor for two years. The clerk of the district court is elected by the governor for two years. The clerk of the district court is elected by the governor for two years. The clerk of the district court is elected by the governor for two years.

... on which the in... \$275,789. The... purposes amounte... \$248,676 was fo... cost of education... based on the total... school population (be... \$12.17 on the en... average attendance... heads of families, and... adult males. Based... cost was 11.59 mills... 17 mills for tuition... 8.18 for the erection... through normal instruction... institutions in the state... devoted exclusively to... The state teachers'... and there are nu... Teachers in the... required to hold certificates... term not exceeding one... 1873, examinations... perpetual state certificates... board of examiners consist... of the state university; but... abolished. The most im... institutions of Iowa, with... instructors and pupils during... were:

... on which the in... \$275,789. The... purposes amounte... \$248,676 was fo... cost of education... based on the total... school population (be... \$12.17 on the en... average attendance... heads of families, and... adult males. Based... cost was 11.59 mills... 17 mills for tuition... 8.18 for the erection... through normal instruction... institutions in the state... devoted exclusively to... The state teachers'... and there are nu... Teachers in the... required to hold certificates... term not exceeding one... 1873, examinations... perpetual state certificates... board of examiners consist... of the state university; but... abolished. The most im... institutions of Iowa, with... instructors and pupils during... were:

	When founded.	No. of faculty.	No. of students.
1860	80	551	
1869	17	208	
1853	10	113	
1866	5	199	
1855	14	200	
1873	4	15	
1867	5	150	
1869	8	40	
1855	16	253	
1855	4	120	
1854	7	170	
1854	2	49	
1854	5	125	
1873	19	881	
1873	5	150	
1860	6	191	
1861	6	185	
1853	5	61	

... of this institution two inter... iments have been made, and are... successful: 1, the union of manual... intellectual exercise as a part of the... students being required to devote an... 2½ hours a day throughout the col... manual labor; 2, co-education of... The institution has extensive grounds... able collections. Courses of instruc... provided in agriculture, four years;... and forestry, stock breeding, me... engineering, civil engineering, mining... architecture, "general science for... military tactics and engineering, nor... and course in bee-keeping. The... an Lutheran college, the largest Norwe-

gian institution of the kind in the country, was established by the Norwegian Evangelical Lutheran synod of Iowa and adjacent states, and is under the direction of that body. It is supported by voluntary contributions, and affords instruction free to all students. The plan of the Iowa Wesleyan university embraces a department of the liberal arts, comprising classical, scientific, normal, and preparatory courses; a department of technology, including courses in fine art and industrial art; and departments of theology, law, and medicine. Both sexes are admitted. Instruction in theology is afforded by the Wartburg seminary (Lutheran) at Casstown, the Swedish Lutheran mission institute at Keokuk, the German theological school of the Northwest (Presbyterian) at Dubuque, and the theological department of the Wesleyan university (Methodist Episcopal) at Mt. Pleasant, with courses in English and German; in law, by the law departments of the state and the Wesleyan university; in medicine, by the medical department of the state university, the department of pharmacy in the Wesleyan university, and the college of physicians and surgeons established in Keokuk in 1849, which had 10 instructors and 142 pupils in 1873; and in science, by the state agricultural college.—According to the census of 1870, there were in Iowa 233 newspapers and periodicals, having an aggregate circulation of 219,090, and issuing 16,403,380 copies annually. There were 22 daily, with a circulation of 19,800; 3 tri-weekly, 1,650; 1 semi-weekly, 1,000; 196 weekly, 187,840; 3 semi-monthly, 3,400; 5 monthly, 3,950; 2 bi-monthly, 750; 1 quarterly, 700. The state census of 1873 returned as published in Iowa 22 daily newspapers, 2 tri-weekly, 6 semi-weekly, 272 weekly, 2 semi-monthly, 19 monthly, and 1 bi-monthly. The total number of libraries in 1870 was 3,540, containing 673,000 volumes. Of these, 2,387 with 295,749 volumes were private, and 1,153 with 377,851 volumes were other than private, including 1 state, with 11,000 volumes; 23 town, city, &c., with 22,808; 11 court and law, with 944; 15 school, college, &c., with 18,747; 999 Sunday school, with 278,251; 85 church, with 25,584; and 18 circulating libraries, with 20,367 volumes. The chief libraries are the state library in Des Moines, which in 1874 had 12,000 volumes, exclusive of 4,000 duplicates; the Keokuk library association, 7,000; state historical society, Iowa City, 3,800; public library of Burlington, 5,398; and Jefferson county library association, Fairfield, 3,480. The state historical society at Iowa City is partly supported and controlled by the state. A chief object is the collection and preservation of historical works, manuscripts, relics, &c., pertaining to the history of the state.—In 1870 the state contained 2,763 religious organizations, having 1,446 edifices with 431,709 sittings, and property valued at \$5,730,352. The various denominations were represented as follows:

DENOMINATIONS.	Circulars national	Edi- fices.	Sittings.	Property
Baptist, regular.....	307	147	44,940	\$422,700
"    other.....	45	15	6,350	44,000
Christian.....	113	46	13,750	121,000
Congregational.....	1-7	125	33,925	329,000
Episcopal Protestant.....	58	36	9,584	197,000
Evangelical Association.....	82	11	2,400	27,000
Friends.....	52	60	17,075	127,000
Jewish.....	5	1	150	7,000
Lutheran.....	79	45	12,285	113,000
Methodist.....	992	492	142,655	1,400,000
Moravian (Unitas Fratrum)...	5	3	900	9,000
Mormon.....	6	1	200	600
Presbyterian, regular.....	270	156	44,265	374,200
"    other.....	165	66	20,625	23,100
Reformed church in America (late Dutch Reformed).....	4	4	1,500	25,000
Reformed church in the United States (late German Refor'd).....	13	13	3,950	44,000
Roman Catholic.....	216	163	57,290	1,314,100
Second Advent.....	28	10	2,950	14,000
Unitarian.....	3	2	715	17,000
United Brethren in Christ.....	158	28	10,445	60,250
Universalist.....	85	15	4,465	50,500
Total.....	2,768	1,446	431,709	\$5,730,352

—Iowa derives its name (said to mean in the language of the Indians "the beautiful land") from the river so called, and was originally a part of the vast territories included in Louisiana, ceded to the United States in 1803. The first settlement of whites within the present limits of the state was made by Julien Dubuque, a Canadian Frenchman, who in 1788 obtained a grant of a large tract, including the present city of Dubuque and the rich mineral lands in its vicinity. Here he built a small fort, and carried on the mining of lead and trade with the Indians until his death in 1810. In 1834 the territory now included in Iowa was placed under the jurisdiction of Michigan, and in 1836 under that of Wisconsin. No steps were taken toward its further settlement till the spring of 1833, when several companies of Americans from Illinois and other states settled in the vicinity of Burlington; and at a later period settlements were made at other points along the Mississippi. On June 12, 1838, Iowa was erected into a separate territory; and on July 4 ensuing the new government was formally installed at Burlington. Under its territorial organization Iowa included all the country N. of Missouri, between the Mississippi and the Missouri and to the British line, and consequently the greater part of the present state of Minnesota and the whole of Dakota territory, with an area of 194,603 sq. m. In 1839 the government removed to Iowa City. In 1844 a state constitution was formed, and a petition sent to congress for admission to the Union. This was not granted, on account of the constitutional limits assumed; and by an act of March 3, 1845, congress defined the boundaries that would be acceptable. The next year the proposed boundaries were approved by a convention assembled for the purpose; and on Dec. 28, 1846, Iowa was admitted into the Union. The capital was removed to Des Moines in 1837. On Jan. 24,

an act was passed by the legislature giving to the people the question of calling a constitutional convention. The proposition was approved, an election of delegates held in November, 1856. On Jan. 19, the convention met in Iowa City and adopted the present constitution, which was passed on Aug. 8, 1857, by a vote of 40,811 to 10,000. The word "white," where it had been used in defining the qualifications of electors on the basis of representation, and the obligation of militia duty, was stricken out by acts of the legislature, subsequently approved by the people in 1868. The question of revising the constitution was submitted to the people in 1874, when a majority voted against it. A report of a geological survey of the state during 1870, by Charles A. White, state geologist, published in Des Moines in 1870 (2 vols.).

**A. L. A. S. W. county of Wisconsin.** Bounded N. by Wisconsin river, and drained into the Mississippi by several branches of the Pekatonica; area, 720 sq. m.; pop. in 1870, 24,544. The surface is generally level and thinly timbered. Lead is abundant and copper and zinc are found. The Madison division of the Milwaukee and St. Paul railroad passes along the N. border, and the Mineral Point railroad terminates at its county seat. The chief productions in 1870 were 760,166 bushels of wheat, 705,792 bushels of Indian corn, 803,951 of oats, 40,867 of barley, 5,857 of flaxseed, 145,141 of potatoes, 1,000,000 lbs. of wool, 73,896 of hops, 84,023 of butter, and 88,054 tons of hay. There were 9,871 horses, 10,064 milch cows, 10,000 other cattle, 13,756 sheep, and 28,235 swine; 22 manufactories of carriages, 7 of furniture, 5 of pig lead, 1 of paints, 8 of distillery and harness, 3 flour mills, 4 breweries and 2 zinc-smelting establishments. Capital, Mineral Point.

**II. An E. county of Iowa.** Bounded N. by the river of the same name, E. by the Mississippi, S. by the English river; area, 1,000 sq. m.; pop. in 1870, 16,644. It has an elevated and well wooded surface, and a rich soil. The Chicago, Rock Island, and St. Louis railroad passes through the county. The chief productions in 1870 were 531,148 bushels of wheat, 1,281,123 of Indian corn, 1,000,000 of oats, 111,882 of potatoes, 499,379 lbs. of wool, 31,877 of butter, and 30,703 tons of hay. There were 6,564 horses, 6,481 milch cows, 10,995 other cattle, 8,806 sheep, and 10,000 swine; 4 manufactories of carriages, 4 of distillery and harness, 1 of woollen goods, 4 of flour mills, and a cotton and woollen works. Capital, Marengo.

**A CITY,** the capital of Johnson co., Iowa, founded in 1839 to 1857 the seat of the territorial state government, situated on the left bank of the Iowa river (here navigable by boats), 80 m. from its mouth, and on the N. W. corner of the Rock Island, and Pacific railroad, 130 m. from Des Moines; pop. in 1850, 1,250; in 1870, 5,214; in 1870, 5,914. Since the census of 1870 the city has been enlarged, and the population

now (1874) is about 9,000. It is built upon the highest of three plateaus, 150 ft. above the river, and is surrounded, at the distance of a mile, by an amphitheatre of hills. It is the seat of the state university, which has an attendance of 600 students in the academi- cal, law, and medical departments, an extensive laboratory, and a library of 6,500 volumes. The university occupies four buildings, the largest having been erected by the federal government for the territorial capitol. In connection with its medical department is Mercy hospital, with roomy wards and private apartments. (See Iowa.) The county offices and court house are the other principal public buildings. There are several flouring mills in operation, and the river furnishes motive power for various other manufactories. The city contains two national banks, the state historical society's rooms, with a library of about 3,500 volumes, four ward schools, three academies, a commercial college, a daily and three weekly (one Bohemian) newspapers, a semi-monthly periodical (published by the students in the university), and 15 churches.

**IOWA RIVER.** See Iowa.

**IOWAS,** a tribe of American Indians, belonging to the Dakota family. They call themselves Pahucha, "Dusty Nose," but were called by some Algonquin tribes Iowas, and by others Mascoutin or Prairie Nadouessis. Marquette in 1673 lays them down as the Pahoutet, back of the Des Moines. They consisted of eight clans: the Eagle, Wolf, Bear, and Buffalo, still existing, and the Pigeon, Elk, Beaver, and Snake, now extinct. Each of these was distinguished by a peculiar way of cutting the hair. The Jesuit Father André preached to a band of them about 1675, and ten years later a delegation met and wept over Perrot, according to the Sioux fashion, at his temporary fort on the Wisconsin. Their country was then in about lat. 43° N., 12 days' journey west of Green bay. In 1700 they were on the Mankato, and like the Sioux were at war with all the western Algonquin tribes. Charlevoix mentions that the great pipestone quarry was on their territory, and says they were famous in all the west as pedestrians, being able to travel 25 or 30 leagues a day when alone; and the names of chiefs show that they pride themselves on their walking. They were constantly at war, and about the beginning of this century were involved with the Osages, and soon after with the Omahas and Sioux. They seem to have numbered then about 1,500. They defeated the Osages in 1803, but soon after lost severely by smallpox; some years later many of them were killed and taken by the Sioux, and in 1815 they were again decimated by disease. The United States made a treaty of peace with Wyingwaha or Hardheart and other chiefs, Sept. 16, 1815. By another treaty, made with Gen. Clark on Aug. 4, 1824, Mahaskah or White Cloud, the greatest chief in the annals of the tribe, and Manehana or Great Walker,

would reveal a temple to that deity. In 1817 Belzoni, assisted by Capts. Irby and Mangles, removed 31 ft. of sand, when the top of the entrance was reached. This second and larger temple, standing 100 ft. above the water level, has a front 120 ft. long and 90 ft. high, surrounded by a moulding, and adorned with a cornice and frieze. In front, seated on thrones, are four colossal figures 65 ft. high, the largest in Nubia or Egypt. The third statue from the north has been shattered by an avalanche from the mountain, and a portion of the head lies in the lap of the figure. One of these colossi has a face 7 ft. long and measures 25 ft. 4 in. across the shoulders. According to Wilkinson, the figures are statues of Rameses II. The interior



Tomb, Ipsambul.

presents first the colonnade, the pilasters of which bear figures of Osiris 30 ft. high, and the walls exhibit sculptures representing battles and triumphs. Next is the great hall extending 200 ft. into the rock, with ranges of massive square columns adorned with statues. Beyond are an antechamber and the sanctuary with several side chambers. In the background is a colossal figure seated on a bench, and there are similar statues in the side chambers. In the centre of the sanctuary is a pedestal on which Heeren thinks a sarcophagus once stood, and hence he argues that the monument was not a temple but the sepulchre of a king. He believes, too, from the scenes of war and triumph sculptured on the walls, and

especially from four painted figures, one of which in red he takes to be a king, that the smaller monument also was a royal sepulchre. Burckhardt says that Ipsambul served as a refuge to the inhabitants of Beillany, 8 m. distant, against the annual incursions of a western tribe of Bedouins. In 1812, the year previous to his visit, the natives took refuge there with their cattle, and the Bedouins, after losing several men, failed to force the place.

**IPSARA**, or **Psara**, a barren and rocky island belonging to Turkey, in the Grecian archipelago, 10 m. W. of Scio; greatest length about 6 m., breadth 5 m. Those parts of it which are covered with a thin soil have been carefully cultivated, and before the Greek revolution the island was prosperous and densely populated, forming one of the most important marine stations under the control of Greeks. During the war it earned a national fame by the devotion and bravery of its mariners, but was captured and almost depopulated by the Turks (July 3, 1824); since that time it has been of little importance. There is but one town upon the island, also called Ipsara, and having hardly more than 500 inhabitants. It is situated on the S. side, where a small bay affords good anchorage; but it has little commerce, and the people are chiefly supported by fishing.

**IPSUS**, a town of ancient Phrygia in Asia Minor, probably about 10 m. S. E. of Synnada, and a short distance N. W. of the modern village of Bulavadin, 28 m. E. of Afium-Karahissar. It is famous on account of the battle fought in 301 B. C. (or in 300, as Grote conjectures), in the plain near it, when Antigonus and his son Demetrius were disastrously defeated by the forces of Seleucus, Cassander, Lysimachus, and Ptolemy. Antigonus fell, and the victory of his enemies was followed by a new division of the dominions of Alexander the Great, which terminated a bloody struggle of 20 years. In the 7th and 8th centuries Ipsus was the seat of a Christian bishop.

**IPSWICH**, a town of Essex co., Massachusetts, on both sides of Ipswich river, at its mouth, and on the Eastern railroad, 25 m. N. N. E. of Boston; pop. in 1870, 3,720. The river, which is here crossed by two stone bridges, one built in 1764 and the other in 1861, affords valuable water power, and in a bay of the same name at its mouth there is an excellent harbor. A number of vessels are owned here, and the town is interested to some extent in the coasting trade, and has small ship yards. There is a woollen mill, producing repellants, but the principal manufactures are of hosiery, employing 14 establishments, and of boots and shoes. The town contains a county insane asylum, a county house of correction, a female seminary established in 1828 and having in 1873 9 instructors and 60 pupils, a classical school founded in 1650, 10 public schools, including a high school, a weekly newspaper, a public library, and six churches. It was settled in 1633. Its Indian name was Agawam ("fishing station").



**IPSWICH**, a parliamentary borough and river town in England, capital of the county of Suffolk. It is situated on a gentle declivity near the confluence of the Orwell and Gipping, the junction of which, according to Camden, gave it its name, which was originally Gippesburgh. The streets are generally narrow and irregular, but are well paved and are lighted with gas. It has 42 churches and places of worship, a mechanics' institute, a working men's college, large iron founderies and soap works, breweries, corn mills, and ship-buildings. Among the principal buildings are Queen Elizabeth's grammar school, the town hall, a corn exchange, a county hospital, assembly room, and barracks. A grammar school was founded originally in the reign of Edward IV., and was revived by John Wolsey, who intended to make it a



Queen Elizabeth's Grammar School, Ipswich.

college for Christchurch college, which he founded at Oxford. Its charter was confirmed by Queen Elizabeth. The present building, the corner stone of which was laid by George Albert in 1851 on a different site from the ancient school, is 168 ft. front by 100 ft. deep. It accommodates, besides the grammar school, a public library and museum. Ipswich has considerable foreign and coast-trade, chiefly in grain, coal, timber, and manufactures. Ipswich was sacked by the Danes in the years 991 and 1000.

**IPSWICH**, a town of Queensland, Australia, on the river Bremer, 25 m. W. of Brisbane; pop. in 1871, 5,092. It has several churches, a hospital, a grammar school, a mechanics' institute with a library of 2,000 volumes, and two newspapers. Ipswich was incorporated into a municipality in March, 1871, and is now the second town of the colo-

ny, rivalling Brisbane in business importance. It is the starting point of the southern and western railways.

**IRAK-AJEMI**, a central province of Persia, comprising a portion of the great desert, and bounded N. by a range of mountains dividing it from the provinces on the Caspian sea, E. by Khorasan, S. and S. W. by Fars and Khuzistan, and W. and N. W. by Luristan, Ardekan, and Azerbaijan; area estimated at about 100,000 sq. m., pop. at 1,250,000. The surface consists chiefly of a high table land traversed by several mountain ridges and fertile valleys. The Kizil Uzen in the north and the Kerah in the southwest are the principal rivers. The country is almost destitute of trees, and a considerable portion of arable land is uncultivated, but there are excellent pasture lands. Some of the valleys which are well watered produce large crops of rice, wheat, and other grains; and fruits, opium, tobacco, cotton, saffron, and silk are staples. Ispahan, Teheran, Hamadan, Casbin, Kermanshah, and Kum are the principal towns.

**IRAK-ARABI**, or **Irak-el-Arab**, the Arabic name, and a common designation among orientalists, for the S. E. portion of Asiatic Turkey, and some adjoining territory to the east. It corresponds to ancient Babylonia and Elam or Susiana, and includes the pashalic of Bagdad, excepting the northern portion, and the S. W. frontier land of Persia, principally Khuzistan.

It comprises therefore the alluvium at the head of the Persian gulf as far north as about lat.

33°, in the neighborhood of Hit on the Euphrates, and between the Syrian desert on the west and the mountain ranges of Kurdistan, Luristan, and Khuzistan on the east. This alluvium is said to increase with extraordinary rapidity, and it is supposed that its growth was still more rapid in ancient times, and that when the first Chaldean monarchy was established the Persian gulf reached 120 or 130 m. further inland than at present. Rawlinson says of this region that nothing is more remarkable than its featureless character. It is a dead level, broken only by single solitary mounds, the remains of ancient temples or cities, and by long lines of embankment marking the course of ancient and recent canals. Near the streams and canals are lands of great fertility, but the rest, except in early spring, is almost as parched and arid as the most desolate districts of Arabia. The principal rivers are

the Tigris and Euphrates. A wide and deep channel, branching off near Hit, skirting the Syrian desert, and entering the Persian gulf by a separate mouth, was probably the ancient western limit. The part east of the Tigris is the most fertile, and forms in a large measure the storehouse of the remainder of this district. Nearly all of Turkish Khuzistan, however, is but little cultivated, though its soil has every characteristic of luxuriant fertility. The climate and products of the region are mainly described in the articles upon the two principal towns, Bagdad and Bassorah.

**IRAN.** See PERSIA.

**IRANIC RACES AND LANGUAGES.** The Iranic or Persian races form a branch of the Aryan or Indo-European family. They inhabit a territory in the immediate vicinity and west of the Indic races or Aryans proper. The first traces of the Iranic branch are found north of the Hindoo Koosh, near the elevated plateau of Pamir, and at the sources of the Oxus. In historic times the Iranians appear on the shores of the Oxus and of the rivers of upper Sogdiana, and spreading southwest through Badakhshan and Balkh, they people the entire country of the vast plateau known in a limited sense as Iran or Persia, excepting the S. E. corner, inhabited by the Braloocees, a Deccanese or Dravidian race. The Afghans have an Iranic language strongly interwoven with Sanskritic elements, for which reason some class them among the Indic races. Beyond the Persian district the Iranic branch extends over the mountainous region of Armenia into Asia Minor. It is probable that in the flourishing period of the Persian empire the Iranic races were spread also over the plateau on the Kur as far N. as the Caucasus; it is less probable that, as some suppose, they were scattered over the regions beyond the Caucasus, and mingled with the Slavs. Colonies of Iranians, however, were to be found as far as the Crimea, and mingled with the Thracians. It is thus established that the Iranians were in ancient times the connecting link between the Indo-Europeans of Asia and of Europe. At an early period the Iranians and Indians probably formed but a single group of races. The *Arya* of the Indic was the *Arya* of the Iranic race, and apparently they had the same religion. In what period their separation took place is unknown.—The first Iranic race that appears in history is that of the Medes. Their earliest territory is not clearly defined, but it probably comprised very nearly the same regions as their strictly historical habitat, reaching in the east as far as the Caspian gates, and in the north not quite as far as the mountains N. of Atropatene. The southern boundary was Susiana, and in the west the territory was separated from that of the Assyrians and Babylonians by the Zagros. According to Berosus, the Medes were an important race as early as 2400 B. C., at which time, he says, there was a Median dynasty in Babylonia. Syncellus calls Zoroaster

the founder of this dynasty; but though this name may have been furnished by Berosus himself, as Eusebius intimates, it does not follow that this Zoroaster was identical with the founder of the Iranian religion. More important than this single statement by Berosus are the contents of the Assyrian cuneiform inscriptions, which do not speak of the Medes as the conquerors, but as the subjects of the Assyrian empire. The oldest notice is probably one found in the inscription of the elder Tiglath-pileser, about 1100 B. C., in which a country named Amadana is spoken of in connection with Elam as a conquered territory. The Medes are mentioned again on the black obelisks of the 9th century, and more frequently in the inscriptions of Sargon toward the close of the 8th century. He and his successors Sennacherib and Esarhaddon speak of Media as if it were a distant country, and the Assyrians evidently did not consider it as important to conquer as Asia Minor and Egypt. It is therefore probable that the Semitic race was spread at that time much further over the mountainous districts of the Zagros than they were in more recent historical times. The Assyrian inscriptions agree with the statement of Herodotus that the Medes were at an early period subjects of Assyria. He adds that they were the first people to cast off the yoke after 520 years, and with this period of the revolt of the Medes he begins the history of the foundation of the Median empire. (See MEDIA.)—The oldest sources we possess for the history of the Iranians represent them as divided into several races. Those most frequently mentioned are the races of the western territory. Herodotus distinguishes among the Medes the Busee, the Paretaceni, the Struchates, the Arizanti, the Budii, and the Magi. The Persians he divides into Pasargadae, Maraphians, Maspiana, Pantiakians, Derusians, and the Germanians, all of whom were engaged in husbandry, and four nomadic tribes, the Daans, Mardians, Dripians, and Sagartians. The special territories occupied by these tribes are not known. The remark of Herodotus that the Pasargadae were the principal tribe, and that the Achæmenides were one of its clans, shows that each of these tribes consisted of several subdivisions. The Iranic races are also to this day subdivided into numerous tribes. The Indus is now the eastern boundary of these races. Near this river dwell the Belooches and Afghans. In the *dammann* or borderland of India are several Afghan tribes which are sometimes collectively designated as Lohani, and others further west, on the Solyman mountains, forming together the transition from the Indic to the Iranic race. A very few of them are still nomadic; the others are husbandmen and traders. Still further west are the Afghans proper, and S. of them the Belooches, the latter not of purely Iranic origin. (See AFGHANISTAN, and BLOOCHISTAN.) The Afghans are a well built people, with an elongated head, horizontal eyes, and

velvet-like skin. The Tajiks are also Iranian blood and speech. Khanikoff has lately disproved the tradition hitherto accepted by many scholars, that the Tajiks are a people from Babylonia. They are met among the Afghans and Belooches, but found in largest number in Bokhara and Kashan, and many have settled in Khokan, and Chinese Tartary. They are of good height and powerful frame, but have a head than the Afghans, and a thicker nose. In Bokhara and Khiva they belong to the literary class. They compose the part of the population of Cabool, Candahar, Herat, and Balkh. Their religious practices clearly show that fire worship is their ancient form of religion; they are not Sunnis. The Barezis and the Persians are considered branches of the Tajiks.—In the west, mainly on the borderland of Afghanistan, Khiva, and Persia, live the Aimags, whose language is of a very ancient type and is mixed with Arabic. They consist of the Turkmens, the Timuri, Timeni, Ferózkohi, and the Shidhi. Among the Iranian populations in Persia, the Bakhtiaris and Feilis of Luristan deserve special mention. The Persians are generally fairer than the Afghans, and their features are more regular, their physiognomy has been much improved by admixtures of Indian and Circassian blood. (See PERSIA.) Modern research has established that the Kurds also belong to the Iranian race. They are found in Khorasan, and inhabit the north-western slopes and valleys of the Elburz, but the eastern Kurds live on the Zagros mountains. The western Kurds have inhabited for a long period a portion of the Armenian mountain ranges on the northern limit of the Mesopotamian desert. (See KURDISTAN.) They possess the beautiful heads and pleasing features of the Kurds. The Yezids, who dwell in the Sinjar mountains, N. of Mosul, are also classed with the Kurds as Iranian. Among the Kurds live an agricultural people called Gurans, whose dialect is more related to Persian than the Kurdish.—The Kurds the principal Iranian populations in Persia. (See ARMENIA), the inhabitants of the southern shores of the Caspian sea, and those who live in Baku, and the Ossetes, on the sides of the Caucasus, near the Dariel. These generally surpass the Persians in stature. The large black eyes of the Armenians are admired.—LANGUAGES. The recovery of the ancient languages of Persia is an accomplishment of this century, and is especially due to the knowledge of Sanskrit. The oldest phases of Iranian speech lay in the sacred books of the Parsees and their cuneiform characters. Subsequent to the fall of the Persian empire by Alexander the Great, the documents of the religion of Zoroaster, founded by Zoroaster, were neglected under the reign of the foreign princes. The new Persian dynasty of the Sassanides

(226–651) reestablished the ancient religion in its former dignity, and the extant fragments of the holy books were carefully gathered. The conquest by the Arabs dethroned the native religion again, and almost wiped it out of existence. A few succeeded in retaining the ancient worship in Persia, as in Yezd and Kerman, and others introduced it into India. The remains of the holy books extant at the time of the Arab conquest are still preserved, partly in the original language, but mostly in an ancient translation. The oldest Iranian form of speech known to us was probably an eastern language, and Spiegel has given it the name of Old Bactrian. Others designate it as Zend, which was originally intended to be applied to the translation, but was subsequently used by mistake for the language of the text. The language of the translation is Huzvareh, which is the literary form of the Pehlevi. Anquetil-Duperron published in 1771 a French translation of the text under the title *Zend-Avesta*. (See ZEND-AVESTA.) The hints which he gave of the language were sufficient to prove its Sanskrit character, and Sir William Jones was the first to identify it as such (1789); but a whole generation passed before any real progress in the recovery of the language was noticeable. When the labors of Bopp and Schlegel had given a solid foundation to Sanskrit philology, the Iranian languages soon gained a similar basis through the labors of Olshausen, Burnouf, Hermann Brockhaus, Spiegel, Westergaard, Haug, Justi, Lagarde, and Lassen. The first attempt at a grammar of the Old Bactrian or Zend language was made by Haug in his "Essays on the Sacred Language, Writing, and Religion of the Parsees" (Bombay, 1862). In 1867 appeared Spiegel's *Grammatik der Altbaktrischen Sprache*, containing also an appendix on the dialect of the Gathas. Justi published in 1864 a *Handbuch der Zendsprache*, in which he furnished a lexicon of Old Bactrian, to which Paul de Lagarde has made valuable additions in his *Beiträge zur baktrischen Lexikographie* (1868). (See ZEND LANGUAGE.) For the old Persian language of the time of the Achæmenides, as found on the monuments of Cyrus, Darius, and Xerxes, see CUNEIFORM INSCRIPTIONS. Benfey, Mordtmann, and others are of opinion that the second column of the trilingual cuneiform inscriptions contains the language of the ancient Medes.—The language called Pehlevi, Pahlavi, or Huzvareh, is Iranian, but it is not positively known where and when it was spoken. Spiegel assigns it to the western portion of the empire of the Sassanides, and considers its Semitic elements of Nabathæan origin. It was probably used as a literary language from about the 3d century to the downfall of the Sassanian empire, and continued in use for religious documents. It is known through the translation of the *Avesta*, and through a few other religious works, as the *Bundehesh*, and through inscriptions, coins, and gems. It is not always the same, but dif-

fers in these various remains principally in a smaller or larger infusion of Semitic elements. Müller, Haug, Windischmann, Dorn, Mordtmann, Olshausen, De Sacy, and Levy are probably the most eminent scholars of Pehlevi. The language called Parsee or Pazend resembles Pehlevi in grammar, but its vocabulary has few words of Semitic origin, and is purely Iranic. It was probably in use at the same time as the Pehlevi, the literary language of the Sassanian empire, and finally became its successor. It maintained itself as such until the development of the modern Persian. When used in explanation of ancient religious texts, the Parsee language is styled Pazend. Spiegel published in 1851 a grammar of this language.—The modern Persian is purely Iranic in its older documents, but since the adoption of Islam the vocabulary has been full of Arabic words, though the grammar has remained essentially Iranic. (See PERSIA, LANGUAGE AND LITERATURE OF.) East of the territory of modern Persian are the Iranic dialects of the Afghans and Belooches, and west those of the Ossetes, Kurds, and Armenians, noticed in the articles relating to them.—See F. Spiegel, *Erânische Alterthums-kunde* (2 vols., Leipsic, 1871-'3).

**IREDELL**, a W. county of North Carolina, partly bounded W. by Catawba river, and drained by branches of the Yadkin; area, 695 sq. m.; pop. in 1870, 16,931, of whom 4,643 were colored. It has an uneven surface and a good soil. The Western railroad passes through it. The chief productions in 1870 were 67,687 bushels of wheat, 315,972 of Indian corn, 108,657 of oats, 67,071 lbs. of tobacco, 13,233 of wool, 86,058 of butter, 40,273 of honey, and 408 bales of cotton. There were 1,920 horses, 980 mules and asses, 2,738 milch cows, 4,608 other cattle, 9,723 sheep, 15,731 swine, and 1 cotton factory. Capital, Statesville.

**IREDELL**. I. James, an American jurist, of Irish ancestry, born in Lewes, England, Oct. 5, 1751, died in Edenton, N. C., Oct. 20, 1799. He emigrated to America at the age of 18, and was made comptroller of the customs at Port Roanoke, now Edenton, N. C., retaining the office for several years. He was admitted to the bar in 1770, was deputy attorney general in 1774, judge of the supreme court of the state in 1777, and attorney general in 1779-'82. In 1787 he began the collection published as "Iredell's Revision of the Statutes of North Carolina" (1791). In 1790 he was appointed a justice of the United States supreme court. His judicial opinion in the case of *Chisholm v. Georgia* contains the germs of all the later doctrines of state rights. The "Life and Correspondence" of Judge Iredell has been published by Griffith J. McRee (2 vols. 8vo, New York, 1857). II. James, son of the preceding, born in Edenton, Nov. 2, 1788, died in Raleigh, April 13, 1853. He graduated at Princeton in 1806, studied law, and served for ten years in the North Carolina house of commons, being twice speaker. In the war of 1812 he commanded a company of

volunteers. In 1819 he occupied during one circuit a seat on the bench of the superior court, declining a further appointment. In 1827 he was governor of the state, and from 1828 to 1831 a member of the United States senate. He afterward resumed the practice of his profession at Raleigh, and for many years was the reporter of the state supreme court. He published 13 volumes of law and 8 of equity reports. In 1833 he was appointed one of three commissioners to collect and revise all the statutes in force in North Carolina; the result was the work known as the "Revised Statutes." He afterward published a "Treatise on the Law of Executors and Administrators."

**IRELAND**, a European island, forming part of the United Kingdom of Great Britain and Ireland, situated between lat. 51° 26' and 55° 21' N., and lon. 5° 20' and 10° 26' W. It is bounded N., W., and S. by the Atlantic ocean, and E. by St. George's channel, the Irish sea, and the Northern channel, which separate it from England and Scotland. In shape it is a rhomboid, the greater diagonal of which is 300 m. and the smaller 210 across; greatest meridional length 230 m., greatest and smallest breadth 180 and 110 m.; area, 32,531 sq. m. It is divided into four provinces, Leinster, Munster, Ulster, and Connaught, and 32 counties, which, with their population and chief towns, are as follows:

PROVINCES AND COUNTIES.	POPULATION.		Chief towns.
	1861.	1871.	
<b>LEINSTER.</b>			
Carlow.....	57,187	51,472	Carlow.
Dublin.....	410,252	405,625	Dublin.
Kildare.....	90,946	84,198	Nass.
Kilkenny.....	124,515	109,302	Kilkenny.
King's.....	90,043	75,781	Tullamore.
Longford.....	71,694	64,408	Longford.
Louth.....	90,773	84,198	Drogheda.
Meath.....	110,873	94,480	Navan.
Queen's.....	90,650	77,071	Maryborough.
Westmeath.....	90,979	78,416	Mullingar.
Wexford.....	143,954	132,506	Wexford.
Wicklow.....	56,472	58,509	Wicklow.
<b>MUNSTER.</b>			
Clare.....	166,205	147,994	Ennis.
Cork.....	544,818	516,046	Cork.
Kerry.....	201,860	196,014	Trillick.
Limerick.....	217,277	191,818	Limerick.
Tipperary.....	249,106	216,210	Tipperary.
Waterford.....	184,252	122,825	Waterford.
<b>ULSTER.</b>			
Antrim.....	378,588	419,782	Belfast.
Armagh.....	190,086	179,221	Armagh.
Cavan.....	158,906	140,550	Cavan.
Donegal.....	297,895	277,775	Donegal.
Down.....	299,302	217,992	Downpatrick.
Fermanagh.....	105,768	92,688	Enniskillen.
Londonderry.....	184,309	173,982	Londonderry.
Monaghan.....	126,482	112,785	Monaghan.
Tyrone.....	228,500	215,668	Dungannon.
<b>CONNAUGHT.</b>			
Galway.....	271,478	248,257	Galway.
Leitrim.....	104,744	95,324	Leitrim.
Mayo.....	254,796	245,825	Castlebar.
Roscommon.....	157,272	141,246	Roscommon.
Sligo.....	124,845	113,811	Sligo.
Total.....	5,796,634	5,462,759	





, when the first complete census was taken, the population amounted to 6,801,827; in 1841, to 7,767,401; in 1851, to 8,199,853; in 1861, to 6,514,473. The great decrease since 1851, amounting to about 1,600,000, is due to the intervening famine and the rapid emigration. The number of inhabitants was 995,156 in 1861, 960,352 in 1871. The coast line is about 750 m. long. At the northern head in the extreme north to Cape Malinbeg, it is comparatively but little elevated and is low and flat, except in the northern part where the shore is rugged and precipitous; in the east it is much obstructed by rocks, bars, and sand banks. Between the two points named the chief openings to the coast are the loughs of Foyle, Belangford, and Carlingford; the bays of Malinbeg, Dundalk, and Drogheda; that of Malinbeg with the artificial harbor of Kingstown, Drogheda, Wexford, Waterford, Dungarvan, and Malinbeg; the magnificent harbor of Cork, in Queenstown; and Kinsale, Courtmacsherry, Rosscarbery, Baltimore, and Malinbeg harbors. On the southwest coast the coast presents the aspect of a rugged and western coasts of Norway, broken into narrow strips and ragged by bays and arms of the sea. These numerous bays and harbors, among which are the southwest and west, the bays of Malinbeg, Bantry, Kenmare, and Ballinskeltine harbor, the bays of Dingle and Malinbeg, and the estuary of the Shannon, navigable for small vessels to Limerick, Liscaheen, and Malinbeg, and the Killarney, Clew bay with Malinbeg, Westport, and Newport, Black Head, and Broad Haven; further north, Malinbeg, and Donegal bays, with Sheep Head, Malinbeg, and Malinbeg. The shores on this coast of Donegal they form in some places a perpendicular wall of 760 ft. On the Malinbeg coast are the celebrated colonnades of Giant's Causeway, near Coleraine, and the promontories of Bengore and Fairhead, the basalt rests on chalk-white lime beneath which appear the greensands of Malinbeg. Scattered along the coast are 196 islands, the principal of which are: on the Malinbeg coast, Malinbeg; on the S. E., the Saltees and Malinbeg; on the S., Malinbeg; on the Malinbeg coast, Malinbeg, Valentia, the Blaskets, the Malinbeg isles, Inishboffin, Inishturk, Malinbeg bay, the Achill isles, and the Malinbeg isles; and on the N., the North Arran isles, Malinbeg isles, and Malinbeg. The total number of islands is 90, of which 14 receive ships of Malinbeg, 17 admit frigates, upward of 30 Malinbeg enough for coasting vessels, and 25 Malinbeg summer roadsteads. There are also Malinbeg inlets which afford a shelter to the Malinbeg fishing craft. There are 62 lighthouses, Malinbeg and 26 are first-class lights.—The surface of the island is divided into a central basin and mountain ranges ringing the coast, with two great open-

ings on the east and west. Between these openings the central plain extends from Dublin to Galway and Clew bay, reaching northward as far as Lough Neagh and southward to the borders of Waterford and Cork. It is diversified by rich and rolling uplands rising to 200 and 320 ft. above the sea, and by flat tracts of sterile bog lying like huge black patches amid the universal green. The high hills and mountains are covered to their summits with heather. As compared with England, the country has but few trees and patches of forest, although in former times it bore the name of Island of Woods. Strictly speaking, there are no mountain ranges, if we except the Slieve Bloom and Devil's Bit mountains, which stretch in an irregular curve of about 30 m. through N. E. Munster and W. Leinster. Elsewhere the mountains form isolated masses near the coast, subsiding rapidly as they recede from it. The principal groups are: in the northwest, the Donegal mountains, highest point Errigal, about 2,500 ft.; in the northeast, those of Down, highest point Slieve Donard, 2,800 ft.; in the west, Trillickmore in Sligo (2,100 ft.), Nephin and Mulree in Mayo (about 2,700 ft.), and Twelve Pins in Galway (2,400 ft.). Kerry boasts the loftiest peaks in Ireland: Brandon, 3,120 ft., and Carn Tual, 3,414 ft. Of the Waterford mountains, Malinbeg Vullagh is 2,600 ft.; of the Wicklow, Malinbeg Lugnaquilla is 3,000 ft.; of the Dublin, Malinbeg Kippure is 2,470 ft. In Antrim the hills form an elevated plateau intervening between Lough Neagh and the North channel; Mt. Divis near Belfast is 1,560 ft., and Trostan further north 1,800 ft.—The great interior basin is chiefly covered with mountain limestone, through which protrude the Slieve Bloom and Slieve Baughta mountains, both consisting of clay slates between red and yellow sandstone. This clay-slate formation is the second in extension. It flanks the limestone plain to the east, abutting on the Wicklow granite mountains, extending thence westward into Kildare and eastward through Wicklow and Wexford to the sea, and from the western side of the Wicklow mountains reaching in a series of elevations southward and westward through Kilkenny and Tipperary to Limerick, Cork, and Kerry. They compose the mountain masses of Slievenamon, Knockmeledown, and Galtee, together with those which cover Kerry, terminating at Brandon head. Clay slates appear on the S. W. border of the Antrim trap bed, covering Down, Armagh, Monaghan, and Louth, with parts of Cavan, Meath, Longford, and Roscommon. Through this clay-slate tract in the north protrude the granite ridges of Mourne and Slieve Gullion. The granitic rocks form the Wicklow and Mt. Leinster groups, and appear to the north of Galway bay mixed with greenstone and quartz, Malinbeg being the culminating point. From Malinbeg northward to Killala lie a series of primitive rocks, principally mica slate and protruded quartz, forming the barrier between the ocean and the great central plain. This

barrier is broken only by the limestone plain of Mayo, extending to the shore of Clew bay. Mica slate and granitic ridges extend northward and eastward through Sligo to Donegal, forming almost the entire surface of the latter county and a great portion of Londonderry and Tyrone. In the N. W. part of this district the granite and quartz are intermixed with veins of primitive limestone, which also mingles with the mica slate constituting the remainder. East of this granite and mica slate district lies the great trap field of Antrim, the erupted rock over an extent of 800 sq. m. capping a stratum of indurated chalk, which rests on lias. Patches of the same metamorphic rocks also appear on the coast of Kerry, and on that of Antrim, where they terminate in Fair head. The ancient Irish annals contain many accounts of land eruptions proceeding from volcanic action; and in more modern times two are noticeable: one in 1490 at the Ox mountains, Sligo, by which 100 persons and numbers of cattle were destroyed; and a volcanic eruption in May, 1788, on the hill of Knocklade, Antrim, which poured a stream of lava 60 yards wide for 39 hours, and destroyed the village of Ballyowen and all the inhabitants save a man, his wife, and two children. The immense extent of bog is a great obstacle to a perfect knowledge of Irish geology. The coal fields, with the exception of a small field of bituminous coal in the west and a few patches in the north, are south of the centre of the island. The quality of the coal is inferior. The most valuable bed is in Kilkenny, and is made up of seven workable seams of anthracite, the coal containing from 94 to 96 per cent. of pure carbon. The largest field covers a considerable tract in the southwest; but the coal is not well adapted for domestic use, and is chiefly employed in malting and lime burning. In Tyrone, the district of Coal Island produces coal of good quality used in the neighborhood; the beds seldom exceed a few inches in thickness. In 1772, at Ballycastle, Antrim, a colliery was discovered, with gallery and branches, which, from the stalactite pillars and the sparry incrustations on the sides and supports, is believed to have been worked before the Norman invasion. Lignite, the only tertiary deposit, is found on the S. shore of Lough Neagh. The clay-slate formation contains copper ore, the chief mineral wealth of Ireland, the principal mines of which are in the counties of Wicklow, Waterford, Cork, and Tipperary. Lead is more abundant than copper; but in Ireland the mountain limestone is much less liberally supplied with it than in England. The coal measures are rich in iron; and silver is found in connection with lead ore in proportions varying from 7 to 120 oz. per ton. Native gold associated with magnetic ironstone was found toward the end of the last century in Wicklow, but all the efforts of the government to discover an available vein proved fruitless. Tinstone also exists in the same locality, but no working deposits have been discovered. Recent explorers have found

in the new red sandstone beds of salt promising an inexhaustible supply. The other minerals known to exist are antimony, zinc, nickel, iron pyrites, alum, clays of various kinds, gypsum, ochre, building stone, marble, and paving and roofing slates. Mineral springs occur at Mallow, where the water is 20° warmer than the atmosphere, and at Castle Connell, near Limerick, where the waters are chalybeate; and sulphur springs at Swanlinbar in Cavan, and at Lucan near Dublin.—Of the two kinds of bogs, the red or fibrous consists chiefly of bog moss (*sphagnum palustre*); it is reddish brown, approaching to olive when dry. Its surface is generally covered with heath. The black bog varies from dark brown to perfect black; in the latter case it becomes very hard and close-grained, and breaks into angular fragments. The deepest layers are still denser and darker, and very compact, resembling pitch or coal, and emitting when lighted an offensive odor. The average depth of these bogs is 25 ft.; in some places they attain a depth of 40 ft. They are always above the sea level, their greatest height being 488 ft. and lowest 25 ft. The peat is found to rest on a blue clay, and ultimately on gravel. The area of bog available for peat fuel is about 2,830,000 acres. This physical disposition accounts for the hydrographic features of Ireland. From any part of the country navigable water can be reached within a distance of 50 m. Few countries are so well supplied with rivers and lakes. The principal river is the Shannon, the largest in the United Kingdom, which has its source in the county Cavan at the foot of Mt. Gulcagh, and in a course of 250 m. forms Loughs Allen, Rea, and Derg. The other principal streams are the Blackwater, which has its estuary near Youghal; the Suir, the Nore, and the Barrow, which have their estuary near the city of Waterford; the Slaney, emptying into St. George's channel at Wexford; the Boyne, flowing N. E. from the elevated plain of Leinster into the Irish sea at Drogheda; the Bann, rising in the Mourne mountains, and flowing northward through Lough Neagh till it empties into the Atlantic at Coleraine; the Foyle, emptying into the lough of that name, and formed by the union of four streams from the interior of Ulster; the Erne, falling into Donegal bay; and the Liffey, flowing into Dublin bay. The principal of the numerous lakes are Lough Neagh in Ulster, the largest lake in the United Kingdom, covering 98,255 acres, and exceeded in extent on the continent of Europe by only a few lakes outside of Russia and Sweden; Lough Erne in Fermanagh, consisting of two lakes 5 m. apart, connected by the fine river of that name; Lough Corrib and Lough Mask in the west of Connaught, separated by an isthmus 3 m. broad; Lake Conn in the north of the same province; and the lakes of Killarney in Kerry, renowned for their beauty.—Giraldus Cambrensis praises the mild and equable climate of Ireland. At Dublin the mean annual temperature is a little



lower than 50° F.; the mean winter temperature is 40°, spring and autumn 50°, and summer 60°. There is a difference of 3° between the average temperatures of the extreme north and south. The average temperature of any month in each season varies but slightly from the above figures. There is perpetual moisture, which fosters vegetation and maintains unfailing pasturage; this is due to the prevalence of westerly winds which bring with them the tepid vapor-laden atmosphere of the Gulf stream. Hence the climate of the W. coast of Ireland is milder than that of the W. coast of England in the same latitude. The average spring temperature of Queenstown is 50°, the highest in the British isles. The average annual rainfall is estimated at 36 in., but in some elevated regions, as in Kerry, it is much higher. In the west the rainfall is much greater in winter than in the other seasons. Prolonged frosts and snows are rare, and thunder storms are neither frequent nor violent. The prevalent winds are from the west and south, the S. E. wind predominating in the early part of the year. Easterly winds are dry and keen and much dreaded by invalids. The climate on the whole is very salubrious. The frequency among the poorer classes of fevers and dysentery is attributed less to the humidity of the atmosphere and the exhalations from marsh and bog, than to unwholesome and insufficient diet, imperfect clothing, damp and close dwellings, and want of cleanliness.—One fourth of the entire surface is covered with sterile rock, water, marsh, and bog; arable soil of a mediocre quality composes another fourth; and the remainder is a deep rich loam generally covering a calcareous subsoil. This rich loam, with a subsoil of inferior depth, and producing a luxuriant herbage, is found throughout Roscommon, in some parts of Galway, in Clare, and in other districts. Both the loam and the subsoil attain their greatest depth in Meath, Longford, Tipperary, and Limerick; the Golden Vale district, belonging to the last two counties, is celebrated for its fertility. On the banks of the Fergus and Shannon the soil is different, though equally productive, and very marshy in appearance. These districts are called "carrasses;" the substratum is a blue silt deposited by the sea and partaking of the quality of the upper stratum, thus allowing the whole to be advantageously ploughed to any depth. In Limerick and Tipperary is another kind of rich soil, consisting of a dark, friable, sandy loam, which if kept clean will yield grain for several generations; it is equally well adapted for tillage and pasture, and seldom suffers either from extreme drought or excessive rain. The subsoil, being calcareous, needs no manuring. In the north the quantity of rich soil is not very considerable; but valleys of uncommon fertility are found in every county, even amid the bleak mountains of Donegal. In some parts, as in Galway, the rock protrudes above the surface in wave-like projections, and the interstices are filled with a

mould producing a thick sward very grateful to sheep. The only large tract exclusively devoted to sheep grazing is the Curragh of Kildare. The mountains are capable of cultivation to a considerable height, and their summits with few exceptions are fit for pasturage in summer. Indeed, both from soil and climate, Ireland is naturally a pastoral country; nor was it till 1727 that any systematic effort was made at large culture, when Primate Boulter, as one of the lords justices, urged on the English government the necessity of enforcing a tillage system. In the northern counties the farms are generally small, cultivated with the spade, and yield potatoes, oats, and flax. In the northern part of Fermanagh the farms are larger, the tillage better, and wheat is largely grown, oats however being the chief crop. In the five counties forming the northwest of Ireland, oats is the principal crop, and barley is raised near the sea; and since the famine of 1846 much of the land formerly under tillage has been converted into pasturage. In the southwestern counties grazing is more resorted to, tillage backward, and the farms small. In Tipperary and King's and Queen's counties the best farming is to be seen, wheat forming the staple crop. In Meath, Westmeath, Louth, and Kildare the tillage is inferior, the farms larger and treated after the English manner, and the chief crop is wheat. As the mean summer heat is 56°, the finer sorts of grain ripen in the island; while the open winters, by lengthening the period of grazing, favor the rearing of cattle. The country is very deficient in wood, although it is said to have been formerly covered with forests. The timber found in the bogs is oak, fir, yew, holly, and birch. The progress of agricultural improvement, and the timber act, which secures to the tenant at the expiration of his lease a pecuniary interest in the trees he has planted, promise a large supply of wood in future. Ireland is rich in cattle, horses, especially hunters, and sheep (with less wool than the English). There are many rabbits, but little game excepting deer. Fish abound, especially the salmon, pike, eel, and trout. The sunfish frequents the W. coast, which is occasionally visited also by whales. Seals are met with about the exposed headlands. There are frogs, but no toads or serpents. Bones of the elk or moose deer have been found in several places. Wolves were once numerous, and the Irish wolf dog was kept for hunting them. Of poultry the product is extensive. The flora of Ireland includes the *arbutus unedo* along the lakes of Killarney; new species of saxifrage and ferns have been discovered on the Kerry mountains; rare alpine plants are met with in Connemara (Galway), Benbulbin mountain (Sligo), and in the county Antrim, and peculiar kinds of algæ on various parts of the coast.—The majority of Irishmen resemble in temperament the southern rather than the northern races of Europe. This is most apparent in those parts of Ireland where English and Scotch

settlers do not preponderate. They are more impulsive and warm-hearted than the people of England and Scotland. As settlers in other parts of the world, especially in the United States, the Irish have proved very useful and industrious in various kinds of manual occupation, but at home they are principally tillers of the soil. A marked improvement in the condition of the country has taken place within the last 30 years. The work of bringing waste lands into cultivation reduced the uncultivated land from 6,295,735 acres in 1841 to 5,023,984 in 1851, and to 4,357,388 in 1871. Emigration, which had been powerfully stimulated by the potato disease of 1846-'7, showed a steady decrease for several years after 1852. In that year it was 190,322; 1853, 173,148; 1854, 140,555; 1855, 91,914; 1856, 71,724; 1858, 64,337; 1865, 101,497; 1866, 99,467; 1867, 80,624; 1868, 61,028; 1872, 72,763; whole number from 1851 to 1872, 2,157,257. The total number of paupers relieved was, in 1848, 2,043,505; 1850, 1,174,267; 1851, 755,347; 1852, 519,775; 1853, 409,668; 1854, 319,616; 1857, 190,851; 1861, 247,430; 1863, 317,624; 1866, 270,173; 1868, 339,728; 1871, 282,492. The following statement shows the progress of the agricultural wealth of the country: land under cultivation in 1854, 5,570,610 acres; 1858, 5,882,052; 1868, 5,498,278; 1872, 5,486,522. Of the last number, 2,090,673 were under cereal crops, 991,802 under potatoes, 346,464 under turnips, 135,650 under other green crops, 122,003 under flax, and 1,799,930 were meadow and clover. The produce in 1871 was as follows: wheat, 705,939 quarters; oats, 7,410,814; barley, bere, and rye, 965,709; beans and peas, 49,690; potatoes, 2,793,641 tons; turnips, 4,246,332; mangrel and cabbage, 761,863; flax, 12,929. The live stock in 1872 consisted of 560,500 horses and mules, 180,036 asses, 4,057,153 cattle, 4,262,117 sheep, 242,310 goats, 1,385,386 pigs, and 11,612,207 poultry. The aggregate value of the live stock was estimated in 1841 at £21,105,808; in 1851, £27,737,395; 1861, £33,434,385; 1871, £37,515,111.—The linen manufacture is the most important branch of Irish industry. The spinning wheel of the Ulster cottier gave place to the spindle in the early part of this century, when the first flax-spinning machinery was erected. The number of flax factories has increased from about 70 in 1849 to 154 in 1870, with 916,660 spindles and 14,834 power looms, employing 55,039 persons. One of the chief seats of this manufacture is Belfast. Of cotton factories there were 14 in 1870, woollen factories 61, and worsted factories 3. The silk manufacture, which was introduced into Dublin by French emigrants at the end of the 17th century, proved unprofitable: almost the only branch now flourishing is a fabric of mixed worsted and silk, known as Irish poplin or tabinet. Lace is manufactured to some extent in Limerick. Great progress has been made within the last few years in the manufacture of embroidered muslin. The chief

seat of this industry is in Glasgow; but while the initiatory and concluding manipulations connected with it are almost wholly performed in that city and its neighborhood, the needlework, although partly wrought in Scotland, is chiefly executed by the peasantry of Ireland. About 300,000 persons, principally females, are employed in this work in all the counties of Ulster and some localities of the other provinces, and the gross value of the manufactured goods amounts to about £1,400,000. Spirit distilleries were established in Ireland at an early period. The number of distilleries and rectifying establishments in 1871 was 63, against 93 in 1835; the number of gallons entered for home consumption 5,212,746, against 12,296,342 in 1838; the rate of duty is 10s. per proof gallon.—Among the fisheries of Ireland, those of salmon and herring are flourishing. The number of vessels and boats employed in fisheries in 1871 was 8,999, and the number of men and boys employed 38,629, against 19,863 vessels and boats and 118,073 persons in 1846. In the coasting trade of Ireland the entrances in 1871 were 18,676 sailing vessels, tonnage 1,598,843, and 5,947 steam vessels, tonnage 2,619,891; the clearances were 5,947 sailing vessels, tonnage 439,001, and 8,500 steam vessels, tonnage 2,660,027. The registered shipping in 1871 numbered 651 sailing vessels under 50 tons, tonnage 19,919; 923 sailing vessels above 50 tons, tonnage 148,555; 60 steam vessels under 50 tons, tonnage 1,555; and 143 steam vessels above 50 tons, tonnage 48,183. The commerce of Ireland consists of the provision trade and of the trade in the produce of the country with Great Britain and foreign nations. The exports are mainly sent to Liverpool, Bristol, and Glasgow, from Belfast, Londonderry, Drogheda, Newry, Waterford, and Limerick, and particularly from Cork and Dublin. The entrances of vessels engaged in the foreign trade in 1871 comprised 802 British and Irish, tonnage 282,752, and 920 foreign, tonnage 343,721; the entrances of vessels engaged in the colonial trade numbered 289 British and Irish, tonnage 125,679, and 34 foreign, tonnage 15,571. The principal ports of entry were Cork, Dublin, Belfast, Waterford, Limerick, Londonderry, and Newry. The importation of grain into Ireland in 1870 comprised 6,716,534 cwt. of wheat, 215,279 of barley, 9,670 of oats, 5,738,188 of Indian corn, and 193,707 of wheat meal or flour. By far the most extensive market for Irish products is Great Britain; but the abolition of duties on this cross-channel trade, which took place in 1825, has taken away the means of estimating the imports and exports. The total value of Irish and British products exported direct to foreign countries from Ireland in 1871 was estimated at £463,486. The direct trade between Ireland and the United States has of late decreased. The number of American vessels entering Irish ports in 1871 was only 38, tonnage 24,701. Marble, porter, ale, whiskey, and manufactured goods

from Dublin and Belfast are among the Irish exports to the United States, and tobacco, wheat, and corn among American imports into Ireland. In 1871 there were 17 lines of railway open in Ireland, of which the following were the most important: Belfast and Northern Counties; Dublin and Belfast junction; Dublin and Drogheda; Dublin, Wicklow, and Wexford; Great Southern and Western; Irish Northwestern; Midland Great Western; Ulster; Waterford and Limerick. The aggregate capital of the main lines (excluding that of lines leased or worked) is £27,028,580. In 1871 the number of miles open was 1,988 (in 1872, 2,091); of passengers carried, 15,547,934; gross receipts, £2,272,386; net receipts, £1,090,795. The lines of inland navigation are as follows: Grand canal with its branches, 165½ m.; Royal canal with its branches, 96½; Shannon navigation, river and canal, and two branches, 158; Lagan navigation, river and canal, 26½; Newry navigation, do., 35; Tyrone navigation, do., 4½; lower Boyne navigation, do., 19; Barrow navigation, do., 42½; Ulster canal, 24; Suir navigation, 16½.—Large amounts have been advanced by the government (according to statistics of 1872, £11,832,224) for the improvement of land by means of arterial and thorough drainage, post roads, farm buildings, &c. The encumbered estates court, established in 1849, has brought into market smaller holdings and estates overburdened by debt, and has proved of very great advantage to the prosperity of the country. The total amount expended in the purchase of property under control of the court from 1849 to 1858, when it was replaced by the landed estates court, was £22,000,000, of which £3,000,000 was invested by English and Scotch purchasers. The number of estates sold was 2,380, divided into more than 11,000 lots, and 8,235 conveyances have been executed by the commissioners. The total number of letters delivered in 1871 was 71,164,000, giving an average of 13 letters for each person. The number of newspapers published in 1873 was 154. Savings banks were introduced in 1810; in 1845 the amount deposited reached nearly £3,000,000, but owing to the famine it fell below £1,500,000 in 1849; a gradual increase has since taken place, bringing the deposits up again to £2,220,000 in 1871. Of loan societies there were 81, which advanced 115,095 loans, the amount circulated during the year being £542,295. The bank-note circulation in 1871 was about £7,500,000. There are 8 banks, all issuing their own notes excepting the Hibernian joint stock company and the Royal bank of Dublin. The most important is the bank of Ireland, which acts as banker to the government, and which is bound to make weekly returns similar to those of the bank of England. It has 42 branches; its capital is £3,000,000, its reserve fund about £1,000,000, and at the end of 1872 it circulated notes to the amount of about £3,392,000. The next

most important establishments are the Provincial bank of Ireland, with a capital of £2,040,000 and 44 branches, and the National bank, with a capital of £2,500,000 and 73 branches.—The public institutions for religious, benevolent, and educational purposes are numerous. The Episcopal or Anglican was formerly the established church of Ireland, but by act of parliament it was disestablished on Jan. 1, 1871. (See IRELAND, CHURCH OF.) The dignitaries of the Roman Catholic church of Ireland are the four archbishops of Armagh, Dublin, Cashel, and Tuam, and 24 bishops. The number of priests in 1873 was upward of 3,200, nominated by the bishops, and supported altogether by voluntary contributions. The "Presbyterian church in Ireland" in 1872 had 627 ministers and 558 congregations. There are eight other small Presbyterian and three Methodist organizations, with a small number of Congregationalists, Baptists, Moravians, and others. According to the census of 1871, there were 4,141,938 Roman Catholics, 688,295 persons reporting themselves as belonging to "the church of Ireland" or as Protestant Episcopalians, 503,461 Presbyterians, 41,815 Methodists, 4,485 Independents, 4,649 Baptists, 3,834 Friends, 19,035 of other denominations, and 258 Jews.—The chief educational institution is the university of Trinity college, Dublin, founded in 1591, with an average attendance of nearly 1,200 students. Among the other principal seats of learning are the queen's colleges of Belfast (351 students in 1871-'2), Cork (258 students), and Galway (141 students), established by acts passed in 1845 and 1850. Maynooth college and All-Hallows college, Drumcondra, are the chief institutions for the education of Roman Catholics for the priesthood. The establishment of a Roman Catholic university was agreed upon by a synodical meeting in 1854, and the schools were opened in the same year. On July 20, 1862, the corner stone of a new university building was laid at Drumcondra. The Roman Catholics have also colleges affiliated with the Catholic university at Clonliffe, Tuam, Cloyne, Armagh, Carlow, Athlone, Tullamore, Thurles, Castleknock, Kilkenny, Fermoy, Longford, and Ellis. The Presbyterians have a theological college at Belfast, and Magee college (established in 1865) in Londonderry; the Methodists a college at Belfast (established in 1868). The college of St. Columba, at Rathfarnham, is an Episcopalian institution. The Alexandra college in Dublin was founded in 1866 for the higher education of females. The royal college of science for Ireland was established under the authority of the science and art department, London, in August, 1867, in place of the museum of Irish industry, which then ceased to exist. The church education society, instituted in 1839 for the education of its pupils in the principles of the church of England, had 52,166 pupils in 1870, of whom 3,757 were Catholics. Since 1837 the grants of public money for the education of the people have

been under the superintendence of commissioners, who were incorporated in 1835 under the name of the commissioners of national education in Ireland. Their report shows that on Dec. 31, 1872, there were 7,059 schools in operation, with 1,010,148 children on the rolls. There were 184 new schools, and 48 struck off, showing a net increase of 136. The commissioners had made grants for the erection of 98 additional schools to accommodate 13,045 children. The pupils were divided in reference to religious denominations as follows: Roman Catholic, 804,222; Presbyterian, 112,465; Episcopalian, 80,893. There were 125,347 Episcopalian pupils mixed with 27,312 Roman Catholics under exclusively Protestant teachers; 18,957 Protestant pupils mixed with 11,270 Roman Catholics under joint teachers of both creeds; and 26,172 Protestant children with 862,318 Roman Catholics under exclusively Roman Catholic teachers. These statistics are independent of the schools conducted by the Christian Brothers, which are numerous and largely attended; the teachers are experienced and well educated, and have the confidence of the people. The national schools are open during the entire year, five hours daily. The books used are the same in every school throughout the country, and the instruction embraces reading, writing, arithmetic, grammar, geography, geometry, trigonometry, algebra, bookkeeping, chemistry, hydrostatics, acoustics, electricity, mechanism, music, and drawing; and the girls in addition are taught plain and fancy sewing and knitting. The national system receives but small assistance from government; the entire amount paid out of the treasury in 1872 for teachers, tutors, and work mistresses was \$322,000. The principal establishments for the promotion of literature, science, and art are situated in Dublin, among which are the royal Irish academy, the royal Hibernian academy of art, and the royal Dublin society; literary and mechanics' societies are scattered all over the country. The great industrial exhibition of 1853, called into existence by the exertions of William Dargan, produced increased interest in institutions calculated to diffuse a knowledge of useful sciences among the people. The foundation for a national gallery of art was laid in Dublin in 1859. Medicine, the various branches of natural history, archaeology, and other departments of science as well as of the fine arts, are represented by numerous societies in Dublin, Belfast, and other towns.—Charitable institutions abound in Ireland. Infirmaries for counties and cities, supported by assessment and governed by corporations, afford annual relief to about 60,000 sufferers. Public hospitals for counties, districts, and poor-law unions are distributed over the country, besides various private establishments. The number of insane in 1871 was 18,327. There are houses for the relief of the poor in 163 unions of Ireland. The poor-law system is conducted with a view of assisting those who

cannot support themselves by their personal labor, but at the same time of discountenancing in able-bodied persons all dependence on eleemosynary relief. The poor rate is levied under the assessment of poundage rate on the net annual value of various kinds of ratable property. In 1871 the valuation of the assessable property was £18,239,394, and the average poundage 1s. The total amount expended on the relief of the indigent in that year was £685,668, chiefly for indoor maintenance. Out of 282,492 persons assisted during the year, 56,416 received outdoor relief.—The number of offenders tried at assizes and quarter sessions has materially decreased since 1849. The total number of persons committed or held to bail in 1872 was 4,476 (including 814 females), of whom 2,563 were convicted. From 1865 to 1871 there were 21 persons sentenced to death, and 13 were executed. The number of county prisons is 33, of city or town prisons 5, and of bridewells 106. A law for the promotion and regulation of reformatory schools for juvenile offenders was passed in 1858.—The government is administered by a lord lieutenant (in 1874, the duke of Abercorn), who is assisted by a privy council appointed by the crown, and by a chief secretary for Ireland, a cabinet minister (in 1874, Sir Michael Hicks-Beach). In the absence of the lord lieutenant, he is replaced by lords justices, usually the primate or archbishop of Dublin, the lord chancellor, and the commander of the forces. Each county is in charge of a lieutenant, generally a peer of the realm, assisted by deputy lieutenants and magistrates who officiate gratuitously, and one or more resident paid magistrates, all appointed by the crown during pleasure. The cities, towns, and boroughs are governed by local magistrates. Justice is administered by the lord chancellor, the master of the rolls, four judges in each of the courts of the queen's bench, common pleas, and exchequer, an assistant barrister for each county, a bankrupt court with two judges, and the judges of the prerogative court and of the admiralty. Assizes for criminal and civil pleas are held by two of the judges in each county in spring and summer of every year. The execution of the laws is intrusted to the constabulary in the counties and the police in Dublin. The total of the constabulary amounted, Sept. 30, 1871, to 12,274. The revenue police, organized for the suppression of illicit distillation, comprises about 400 officers and men. The Irish militia is composed of 12 regiments of artillery and 25 of infantry, numbering when embodied 21,973 men. Ireland is represented in the British parliament by 28 representative peers elected for life, and 105 commoners. Of the latter, 64 represent the counties, 2 the university, 12 the cities and towns of Dublin, Cork, Limerick, Waterford, Belfast, and Galway, and 27 the boroughs. The number of county electors in 1871 was 175,149; of city and borough electors, 48,356. No separate return of the rev-

nue and expenditure of Ireland has been given in the finance accounts since 1870; the gross amount of customs collected at the Irish ports in 1871 was £1,942,721, and the net amount of excise duties received in 1872 was £4,056,019. —The antiquities of Ireland are of various kinds: cromlechs, cairns (either simple mounds or to mark burial places), pillar stones, barrows, duns or defences of stone, lis or fortifications of earth, raths or villages, ancient stone-roofed buildings, round towers (of which there are 118, in height from 35 to 120 ft. with an internal diameter of 10 to 16 ft.), ecclesiastical architecture of all ages, with a vast number of castles and fortalices. The origin and use of the round towers have been much discussed. Of recent archæologists, Dr. Petrie believes them to be Christian ecclesiastical structures dating for the most part from the 9th and 10th centuries; Dr. O'Brien thinks they are phallic monuments of remote pagan antiquity; and the Rev. R. Smiddy in 1878 claims them as Christian baptisteries. Ancient weapons of bronze and ornaments of gold are frequently found in turning up the soil, the jewelry especially showing a high degree of artistic skill. The mediæval architecture of Ireland has been largely illustrated by the labors of Dr. Petrie and his school. The round or oval structures of rough stone and earth, popularly called beehive houses, which are still found in great numbers on the islands off the coast of Connemara, county Galway, are probably of the 6th or 7th century. Of Cyclopean architecture, the most remarkable examples are the Dun Aengus, on a high cliff on the great Isle of Arran; Knockfennell in Limerick, 360 ft. in circumference, with walls 10 ft. thick; and the Staigue fort near Kenmare bay, circular, 90 ft. in diameter, with walls 18 ft. high and 13 ft. thick. Several ancient oratories built of uncemented stones admirably fitted, and their side walls and to some extent also the end walls converging from the base to the summit in curved lines, exist in county Kerry. The most beautifully constructed and best preserved of these ancient relics is the oratory of Gallerus. A building unique in Ireland is Cormac's chapel, on the rock of Cashel, constructed in the 12th century, covered with ornaments of the richest Norman character, of the period and probably the work of Anglo-Norman masons and sculptors. The church or chapel of St. Doulough's, near Dublin, dating from the 14th century, presents a singular combination of church, house, and castle, all comprised in the space of 40 ft. long by 16 wide. Many parts of Ireland abound with ruins, especially of old manor houses, built in the form of towers for defence, and hence called castles, or the Irish towers. They are of all periods from the 12th to the 16th century. Besides these there are numerous real fortified castles, some of which furnish admirable specimens of the military architecture of the middle ages. Many smaller castles combining the military and do-

mestic character are provided with keeps and exterior walls like the baronial castles of Britain. Conspicuous among these is Bullock castle, at Dalkey, near Dublin, which protected the port of Dalkey, where the commerce of Dublin was carried on for centuries. Among the principal tower houses are Loughmore castle, county Tipperary, Athenry castle, Galway, Blarney castle, near Cork, and Augnure castle, county Galway, on the borders of Connemara. Many buildings of the Elizabethan period exist in Galway; the finest are the Lynch castle and Castle Banks. Few countries offer so fine a field for the archæologist. —According to the map of Ptolemy, the central portion of Ireland was inhabited in his day by the Scoti; the north by the Robogdii; the east by the Darnii, Voluntii, Eblani, Caui, Menapii, and Coriundi; the south by the Brigantes, Vodii, and Ibernii; the west by the Lucenti, Velaborii, Cangani, Auteri, Magnata, and Haudinii. In the *Argonautica* of Orpheus of Crotona (500 B. C.), the island is called Iernia. In the *De Mundo*, attributed to Aristotle, "Albion" and "Ierne" are mentioned. Diodorus Siculus alludes to the latter as Iris or Irisi, and Strabo names the island *Ιέρων* (Ierne); Cæsar, Tacitus, and Pliny call it Hibernia; Mela and others, Juverna. The native name is Ir, Eri, and Erin. The name of Ogygia, "most ancient land," was also applied to it by Plutarch. A very remote antiquity is claimed and supported with much display of erudition by Irish writers. The researches of the last 50 years have exposed the fallacies and fictions of previous writers on Irish history and antiquities. "The Annals of the Four Masters," as translated by John O'Donovan and Owen Connellan, with the remarkable collections of erudition forming the notes to these volumes, together with the researches of the former and Eugene O'Curry into Gaelic annals, rare works, and unpublished records, appear to authenticate the following statements in reference to ancient Ireland. During the reign of Ollav Fola, about 900 B. C., it is said, a species of parliament was organized by a triennial assemblage at Teamor or Tara, of the chiefs, priests, and bards, who digested the laws into a record called the psalter of Tara. Ollav Fola also founded schools of philosophy, astronomy, poetry, medicine, and history, which were protected by his successors. Kimbath, who reigned about 460 B. C., like Ollav Fola, promoted the civil interests of his kingdom. Three reigns afterward Hugony the Great (800 B. C.) married a daughter of the king of Gaul, obliged the Picts to pay tribute, conquered the Western isles, and divided Ireland into 25 administrative provinces. The crown was declared hereditary in his family, in order to avoid the disorders caused by elections. To this period also is traced the division of Ireland into four provinces; and in the 1st century of the Christian era a portion was cut off from each to form a national district surrounding the cap-

ital. Crintham, one of Hugony's successors, married the daughter of a Pictish chieftain, and joined the Picts in their forays against the Romans. Tacitus mentions that, about this time, an Irish prince who had been exiled from his country solicited Agricola to invade Ireland, assuring him that a single legion would be sufficient to conquer it; but there is no trace or record of Roman occupation. Tacitus also notes the commerce existing between Ireland and Chester in England, and says that the harbors of Ireland are better known than those of Britain. Of Crintham's successors it will suffice to mention Feradach, surnamed the Just; Tuathal (A. D. 95), who erected temples for the sacred fire of the druids, and quelled "the revolt of the plebeians," which had lasted 25 years; Conn Keadeahagh, or Conn of the hundred battles, who was forced to give up half the kingdom to Modha Nuol, king of Munster, their respective shares being partitioned by a wall and ditch from Dublin to Galway, the country north being Leagh Cuin, or Conn's share, and south Leagh Modha, or Modha's share—names yet remembered, although the division lasted but a year. Subsequently Conn became sole monarch. In the reign of his grandson Cormac flourished the military brotherhood of the Fianna Eirionn, commanded by Finn McCool or Fingal, and cut to pieces at the battle of Gabra, in Meath, in the succeeding reign. Cormac was famous in peace and war. He enlarged the educational establishment originated at Tara by Ollav Fola, added to the number of military academies and law schools, and renewed the statutes concerning the psalter of Tara and the registration of individual histories. Nial of the nine hostages fought in Scotland, England, and France, and was killed by an arrow on the banks of the Loire. His successor Dathi, pushing his conquests through Britain into Gaul, was killed at the foot of the Alps. He was the last pagan king of Ireland. At this period the inhabitants were Scoto-Milesians, or Scots mixed with the descendants of an Iberian hero Mileagh.—From the 3d to the end of the 10th century the whole island took the name of Scotia, a term not then applied to the country now called Scotland. Usher and other historians mention four holy men who had preached the gospel in Ireland before St. Patrick. A fifth was sent by Pope Celestine I. in the person of Palladius, archdeacon of the Roman church. Arriving in the reign of Laogare II., he was expelled after a few months, and died in Britain. Patrick, a native of Gaul, and a relative of St. Martin of Tours, was sent to Rome by Germanus of Auxerre, and intrusted by the pope with the mission of converting the Irish people. He arrived in Ireland about the middle of the 5th century, and died in 493, leaving the island Christian. This event gave a considerable impulse to civilization. The churches and monasteries founded by Patrick became so many schools, a zeal for learning spread among clergy

and laity, and the favorite monastery of St. Patrick at Armagh became famous as a school all over Europe. For a time Ireland was so noted for the learning and piety of its ecclesiastics that it was called *insula sanctorum*, isle of saints. One of the most important events which happened about this time was the foundation of the Dalriadan or Scoto-Milesian kingdom of Albania, the first colonization of which from Ireland took place about A. D. 234. It had been established with the aid of the Nialls or O'Neills of the north of Ireland, and when Columba landed in Albania in 563 he found at the head of the colony Connal, one of his own blood relatives. Connal's successor Aidan was anointed king in Iona by Columba; and in 590 both went to Ireland, where, in the general assembly of Drumceat, Columba obtained a recognition of the new Scottish kingdom and the abolition of the colonial tribute paid to the Irish kings. According to Bede, in the year 646 many Anglo-Saxons settled in Ireland. In 684 it was invaded by Egfrid, king of Northumberland, who ravaged many churches and monasteries. More serious predatory incursions by the Scandinavians took place toward the close of the 8th century. Soon the idea of a permanent foothold seized the pirates, and they occupied good maritime positions, as Dublin, Drogheda, Waterford, Limerick, and Wexford. About the year 840 a powerful fleet arrived under Turgesius (Thjorg?), who for nearly seven years exercised authority over a large district, proscribed the Christians, dispersed the schools, burned the books, and issued his mandates from the high altar at Clonmacnoise. Turgesius was killed by Malachi, prince of Westmeath, and the Irish, rallying under the chief king Niall III., broke the supremacy of the Danes. Still they clung to the seaports, and by paying tribute when necessary and forming alliances with and against the Irish princes, retained occupation for more than two centuries, and were the source of great national decadence. In 1002 Brian Boru, or Boroimne, king of Munster, expelled the Danes from his own kingdom, and, seizing the national authority, was crowned at Tara as king of Ireland. Ere long he expelled the Danes from the whole country. Having accomplished this result, he further effected great civil reforms, founded churches and schools, opened roads, built bridges, and fitted out a fleet. He also introduced the use of surnames, and made the marriage contract permanent. Another invasion by the Danes, incited by the king of Leinster, led to the decisive battle of Clontarf, Good Friday, April 23, 1014, in which the power of the Danes was finally broken. Brian was killed in his tent by a party of the flying enemy. His son and grandson perished on the same occasion. Malachi II., dethroned by Brian, now became king. His death in 1022 marks the decline of the Irish monarchy. The country in the 12th century presented a scene of almost ceaseless disorder, the five kingdoms of

Ulster, Meath, Connaught, and Munster, besides a number of petty principalities, continually at war with each other. The land had fallen into a state of degeneracy and variance with its former title of island of St. Bernard of Clairvaux called the island of Rome to this, and Pope Eugenius IV. Cardinal Papiron to correct abuses and restore discipline. The synod of Kells, under his auspices in March, 1152, recognized the supremacy of Rome, established the archbishoprics of Dublin and Tuam, and Cashel already existing, and reprobated simony, usury, and concubinage. A bull is said to have been issued by Adrian IV., the existence of which is confirmed by conferring the sovereignty of Ireland on Henry II. of England; but the latter did not avail himself of it for many years. The death of Dermot McMurrrough, king of Leinster, reinstated on the throne from which he had been justly driven, furnished a pretext for the invasion of Ireland by two bands of adventurers, one under Robert Fitz-Stephen in 1169, and another under Richard de Clare, earl of Pembroke, commonly called Strongbow, in the same year. The success of the latter's allies aroused the suspicions of the king, who issued a proclamation recalling the king and all Englishmen, under pain of death. This course gave him in the eyes of the Irish the aspect of a deliverer rather than that of an invader; and when in 1171 he landed at Waterford, many native princes invited him as liege lord, so that he might settle their existing difficulties, and guarantee their own possessions and dignities. He departed away in the next year, and his lieutenant soon developed a system of spoliation. The king's son John was made lord of Ireland in the same year Cardinal Vivian, the pope's legate, convening a synod at Dublin, confirmed King Henry's title to Ireland by papal ratification. In 1185 John landed with a fleet of 60 ships, was defeated by Hugh de Brien, and soon returned with charges against Hugh de Lacy, chief of the English in Ireland. In 1210 King John arrived in Ireland, chiefly occupied in chastising the most powerful of the Anglo-Norman lords. He divided the country into counties, established a court in Dublin, appointed judges, circuits, and coronations, established a new coinage, and regulated the currency of England and Ireland. In 1216 Magna Charta, or the great charter of liberties, was granted to the Irish by King John. Many years were passed in contending among the rival English lords as well as the native chiefs. On May 23, 1315, at the death of several Irish princes, Edward Bruce landed in Antrim, where he was joined by Hugh O'Neil, prince of Ulster. The natives rallied to his standard. The Anglo-Norman lord Conor of Connaught opposed him, and O'Neil marched southward, overtook the Anglo-Norman army, captured

all the great towns on their route, and went into winter quarters at Christmas "in the midst of the most considerable chiefs of Ulster, Meath, and Connact." In the spring, having made a triumphant march south, they returned to Dundalk, when Bruce was elected and crowned king. Robert Bruce came to the aid of his brother, and, after a successful incursion as far as Limerick, returned to Ulster in May, 1317, the troops having been decimated by a famine of such severity as to compel a suspension of hostilities, after which Robert Bruce returned to Scotland. In August, 1318, the armies were moving. The English under John de Bermingham were in the field first, found Edward Bruce at a disadvantage, and defeated and dispersed his troops at Fangard, Oct. 14. Bruce himself perishing on the battle field. Unexpected dangers interfered with the subjection of Ireland. Notwithstanding incessant warfare between the Normans and the natives, the middle of the 14th century found the Irish language, laws, manners, and customs universally adopted by the former, while marriage and "fosterage" between the nobles of both races were making the Anglo-Normans "more Irish than the Irish." To avert this danger, many measures were adopted. By an ordinance of Edward III., 1341, all offices in Ireland held by Irish or English men who had estates or were married in Ireland were to be vacated, and filled by Englishmen who "had no personal interest whatever in Ireland." In 1367 a parliament at Kilkenny, under the auspices of the king's son Lionel, passed the memorable "statute of Kilkenny," directed against the English who adopted Irish customs or manners, and making intermarriage, fostering, or trading with the natives, treason. Near the end of the century Richard II. twice landed in Ireland with a large force, but he was completely baffled by Art McMurrrough, who in the succeeding reign defied and fought the duke of Lancaster under the walls of Dublin. In the reign of Edward IV. was passed the "head act," which made it lawful to kill "any persons going or coming, having no faithful man of good name and fame in their company in English apparel." Henry VII. undertook still further to reduce the country to a condition of complete dependence by ordaining that no parliament should meet without his permission, and no law be valid unless sanctioned by the English king and council. To meet his view Sir Edward Poynings, then lord deputy, assembled a parliament at Drogheda in 1495, at which was enacted the "Poynings law," which took away the independence of the Irish parliament, making all its acts subordinate to that of England. A parliament in Dublin, in 1537, passed the act of supremacy, declaring Henry VIII. supreme head of the church, prohibiting intercourse with the court of Rome under penalty of *præmunire*, and making it treason to refuse the oath of supremacy. Henry VIII. also took the title of king of Ireland, although in his day

only an inconsiderable portion of the country was practically subject to the English law. This reign was marked by the insurrection of Lord Thomas Fitzgerald, which ended in the total ruin of the powerful house of Kildare. Henry introduced the Protestant reformation into Ireland with as little difficulty as he had into England. A few partial disturbances happened, but nothing of national importance till the reign of Elizabeth, during which fierce and almost incessant wars were carried on with the Desmonds in Munster, and other Anglo-Irish families who resisted the reformation. During the last 15 years of her reign the contest raged with fury, particularly against the O'Neills, O'Donnells, and other Ulster princes and chiefs. It is estimated that this war of Elizabeth cost £3,000,000 and 200,000 lives, about equally divided between the English and the Irish. A great parliament summoned by the lord deputy Sir John Perrott, in 1585, was attended by nearly all of the great Irish chiefs and representatives of the Anglo-Irish families. James I. introduced into Ulster many Scotch and English Protestant settlers. The civil wars in England supplied the Irish and Anglo-Irish Catholics with a favorable opportunity to make an attempt to overthrow the new settlements and protect themselves. Accordingly, in 1641, an insurrection broke out in Ulster, which quickly spread to all parts of the island. Dublin narrowly escaped falling into their hands. Social and religious animosities alike served to embitter the contest, which was marked by great atrocities. As the abbé MacGeoghegan says, both sides were culpable, and the massacre "was one of the most cruel and barbarous that has been recorded among Christians, both on account of its duration and the fury of those who were the authors of it." In 1642 a national synod established the "Confederation of Kilkenny," issued a plan of provisional government, and called a general assembly of the whole kingdom, Oct. 23, at which a supreme council of 24 (comprising 3 archbishops, 2 bishops, 4 nobles, and 15 commoners) was elected. This power exercised the functions of a national government for several years, coined money, appointed judges, held assizes, commissioned officers, and sent ambassadors abroad. Charles I. negotiated publicly and privately with it. Its favorite general, Owen Roe O'Neill, gained a great victory over the English army at Benburb, June 5, 1646; but it was finally distracted and destroyed by intrigue. The country was a prey to anarchy till 1649, when Cromwell appeared on the scene. He took Drogheda by storm, and delivered it up to the license of his soldiery. One after another the Roman Catholic strongholds fell, till the whole country lay at his mercy, and for the first time English supremacy might be said to be established. Four fifths of the whole soil was confiscated. Once more, in 1688, the Catholics took up arms. James II., after his flight from

received with acclamation. An army was speedily organized under the Irish and French officers whom he had brought with him. But the superior genius of William of Orange, displayed at the battle of the Boyne in 1690, broke the current of the ex-king's success. The battle of Aghrim followed, July 12, 1691, where the Irish met with a disastrous defeat; the fugitives retired to Limerick, and after a final stand surrendered, Oct. 3, 1692, on terms which were violated by the victors. Renewed confiscations followed. A large number of Roman Catholics fled the country, and those who remained were barely permitted to exist. The next hundred years of Irish history record little else than relentless persecution of the Catholics. Even so late as toward the close of the 18th century the penal laws were tyrannous. Catholics were not eligible to offices of trust, were not allowed to serve in the army or navy, nor to possess arms, nor to exercise many other of the rights of citizenship. The gloom of the penal days was only broken by brave utterances from noble Protestant men in behalf of the general rights of the kingdom, such as Molyneux's "Case of Ireland stated," Dean Swift's "Drapier" letters, and Dr. Lucas's protests against the encroachments on constitutional rights. Molyneux's book was burned by the common hangman; a reward was offered for the Drapier, and his printer arrested; and Lucas had to find refuge in England from laws enacted by and for the English interest in Ireland. In 1782 Henry Grattan, backed by the arms of the volunteers who had organized to defend the country against an expected French invasion, achieved the independence of the Irish parliament by the repeal of the act 6 George I., the Poyning's, and other objectionable acts. Still the Catholics had cause to sue for "emancipation," meaning thereby a complete community of privileges. The Protestants, too, had their grievances on various matters connected with trade and revenue. War with the American colonies touched their interests in various ways, chiefly by closing the markets for their linens, and by putting a stop to the emigration which was even then beginning to be developed. Hence the universal emancipation of nations proclaimed by the French revolution appealed powerfully to the Irish of both creeds. Theobald Wolfe Tone had founded the first society of United Irishmen, Oct. 12, 1791. His avowed object was to break the connection by means of a union of Protestant, Catholic, and Dissenter. The British government, naturally jealous of the discontent everywhere manifest, increased its severities, suspended the *habeas corpus* act, dispersed meetings by force of arms, and distributed troops at free quarters upon the people. In defence the "United Irishmen" became a secret society, and besought French aid. The recourse to arms contemplated by the United Irishmen was forced to a premature culmination by the government, which through



the viceroy Lord Camden proclaimed all Ireland under martial law, March 30, 1798. This led to great excesses on the part of those in power, and localities in which the united Irish organizers had little hold, like Wexford county, were goaded into revolt. The active civil war lasted less than five months, during which many notable battles occurred, as at New Ross, Ennisorthy, and Vinegar Hill. England employed 137,000 men. Its cost is variously estimated at £30,000,000 and £50,000,000. The English lost 20,000 men, the Irish 50,000. Many of the leaders were executed, Lord Edward Fitzgerald died of his wounds in prison, and Tone, who was captured on board the *Coche*, the admiral's ship accompanying the Irish expedition which he had projected from France and Hamburg, committed suicide in prison. Of the leaders of the United Irishmen fully two thirds were Protestants and Presbyterians. Lord Cornwallis was appointed lord lieutenant, with instructions to pursue a pacific policy. A bill of amnesty was passed in 1799, and the country settled into the appearance of quiet. The government took advantage of the rebellion to strengthen the legislative union of the two countries, which, despite the eloquent opposition of Pitt and his party, went into effect Jan. 1, 1801. The articles of the act of union were: 1, that the two islands be called the United Kingdom of Great Britain and Ireland; 2, the succession to the throne to continue as existing, limited; 3, the kingdom to be represented by one parliament; 4, that Ireland be represented in the house of lords by 28 temporal peers elected for life from the Irish nobility, and in the house of commons by 100 representatives; 5, that the state churches of the two islands be united, their doctrines and discipline being one; 6, that the population of the two countries be on the same footing as regarded manufacturing, trading, and commercial privileges; 7, that the expenditure be in the proportion of Britain 15 to Ireland 2 for 20 years, afterward to be regulated by parliament; 8, that the existing laws and courts be continued, excepting that appeals from the Irish chancery be to the British house of lords. The extremes of both parties were dissatisfied. An insurrection broke out in Dublin, July 23, 1803, but was speedily suppressed. Robert Emmet, the young enthusiast who led it, died on the scaffold. The outbreak had little other result than to cause the revival of harsh measures and of repression. For several years the question of Catholic emancipation was a standard subject of excitement; it was periodically mooted in parliament, and as regularly thrown out, for nearly 20 years. In 1821 George IV. paid a state visit to Ireland, where he was received with demonstrations of loyalty. In 1822 Ireland suffered from a famine, produced, says Alison, "by the contraction of the currency and consequent fall of the prices of agricultural produce 50 per cent." Cobbett says there was food enough, but no money to purchase it. In

1823 the question of Catholic emancipation assumed larger proportions. Daniel O'Connell was the most prominent public man from this period till his death in 1847. Various associations were organized in aid of the ends for which the Catholics, supported by the liberal of all parties, were striving. The chief of these was "the Catholic Association," of which the ostensible object was, in brief, the removal of all political and civil disabilities. Its ramifications extended throughout the country, and it derived from voluntary contributions a large revenue, known in the records of the time as "the rent." This organization exercised an important influence on the domestic political policy of the country, and may indeed be said to have effected its object, for, on April 18, 1829, the long-sought act of "Catholic emancipation" received the royal assent. Sir Robert Peel, in addressing parliament on the bill, made the admission that scarcely for one year since the union had Ireland been governed by the ordinary course of law, without the intervention of insurrection acts, suspension of the *habeas corpus*, or martial rule. O'Connell took his seat as member for Clare, and immediately proclaimed an agitation for repeal of the legislative union. The tactics that had carried the measure of emancipation were revived. The repeal association followed the Catholic. Combined with this primary object were complicated lesser issues, such as a movement against the payment of tithes. Of the 8,000,000 inhabitants of Ireland, only one tenth were members of the established Protestant church, yet tithes for its support were exacted indiscriminately from all. The "tithe war" was distinguished by many disgraceful and heart-rending transactions, notably the massacre at Newtownbarry and Carrickshock in 1831, and at Rathcormack in 1834. At length, in 1838, the obnoxious features of the tax were concealed by the substitution of a fixed rent charge payable by the land owners. The parliamentary reform bill, in 1832, gave to Ireland five more members in the house of commons; and the municipal reform act, in 1840, removed many minor administrative grievances. In 1831 the national system of education was established by act of parliament. In 1833 the expenditure of the grants for public education was intrusted to the viceroy under the superintendence of "commissioners of national education;" and in 1835 these commissioners were incorporated, with power to hold lands. In 1838 the English poor-law system was introduced, and during the succeeding ten years received extension and adaptations as circumstances required. The organization of the police force kept pace with these ameliorations. In 1836 it was consolidated into the semi-military arm it now is. During the progress of these events the repeal agitation was increasing, until it culminated in "the repeal year," 1843. Monster meetings were held at various places. A final one, on a yet more gigantic scale, was proposed to be held at Clontarf, but

the government having forbidden it, it did not take place. In February, 1844, under the Peel administration, O'Connell and his fellow agitators were convicted and sentenced to a short term of imprisonment. An appeal to the house of lords set them at liberty. The agitation did not flourish afterward. In 1846 and the succeeding year a great famine fell upon the land, through the rotting of the potato crop, upon which most of the peasantry depended for sustenance, and thousands perished of hunger. Parliament made successive grants in aid, amounting in the aggregate to £10,000,000. Large sums were subscribed abroad; and among other donations, a cargo of food was sent from the United States. The crops of the two succeeding years were short, but gradually plenty came again. The young Ireland party, which had grown under the auspices of O'Connell, rejected his peace policy, and remonstrated against his affiliation with the English whigs. It received great accessions from the country, and on Jan. 13, 1847, formed the "Irish Confederation." Although it had upward of 150,000 enrolled men in its clubs, its organization was imperfect, and the amount of arms in its possession insignificant. Neither was its purpose distinctly defined or understood. John Mitchel, seeing nothing in the famine policy of the government but "a machinery deliberately devised and skilfully worked for the entire subjugation and slaughter or pauperization of the people," advised resistance and a general arming. William Smith O'Brien, C. Gavan Duffy, T. F. Meagher, and the "Nation" party thought this would be a virtual declaration of war. But the French revolution of February, 1848, gave a great impetus to Mitchel's views, and set all the confederate orators on the path of revolution. The confederation sent to France a deputation, with an address which declared that the heroism of the French republic "taught enslaved nations that emancipation ever awaits those who dare to achieve it by their own intrepidity." The parliament hurriedly passed a "treason-felony" act. Mitchel was arrested, tried, and banished for 14 years. The nationalists desired to wait for the harvest; but the government, as on former occasions, put forth all its power to force an immature rising. The "Nation," "Tribune," and "Felon," which had succeeded Mitchel's "United Irishman," were seized, and their writers thrown into prison. The "gagging act" prevented freedom of speech at the clubs; and the suspension of the *habeas corpus* act compelled those who were objects of suspicion to evade the authorities. Thus the leaders were thrown on the country, and rewards offered for them. Hunted with celerity, they strove to face the emergency in hurried councils and with undisciplined material, and having come in contact with the forces at the slate quarries, Mullinahone, Killenaule, Ballinacarry, Abbeyfeale, and elsewhere, they were either captured or found safety in exile. O'Brien, Meagher, McManus,

and O'Donoghue were sentenced to death; Martin and O'Doherty were banished for a term of years to Australia; and Doheny, Dillon, Devin Reilly, and O'Gorman found their way to America. Later in the year (September) a more persistent effort was made by John O'Mahony and John Savage to rally the people in Tipperary, Waterford, and Kilkenny, but it was hopeless. The government had 40,000 troops in the country. None were executed, the sentence of death having been commuted to transportation, and in most instances pardons were extended in 1856. In 1849 came into operation the act establishing courts for the sale of encumbered estates. To May 25, 1857, property had been sold to 7,216 persons, 6,902 of whom were Irish, the rest English, Scotch, or foreigners. The amount realized for the same was over £20,000,000. In 1849 a serious collision took place between some Orangemen and unarmed Catholics at Dollysbrae, county Down, which necessitated the dismissal of Lord Roden and another Orange magistrate from the commission of the peace by the viceroy, Lord Clarendon. In the same year Queen Victoria paid her first visit to Ireland, and she again visited it in 1853 to witness the great exhibition of Irish industrial products, opened at Dublin, May 12. The year 1854 was signalized by the foundation of a Roman Catholic university. The political excitements of this period were an agitation by Protestants against the governmental grant to the college of Maynooth, and by the Catholic defence association in favor of perfect religious equality. "Tenant right," with other secular questions, under discussion at the same time, produced considerable effervescence. In 1857 the Phoenix society developed some active revolutionary spirit in the south of Ireland. This was followed up by the "Irish Revolutionary Brotherhood," the form under which Fenianism became known in the British islands. The rise and progress of the Fenian movement on both sides of the Atlantic is treated under FENIANS. It is only necessary here to allude to the measures passed by the British parliament growing out of the Irish efforts from 1857 to 1871. The government put forth its most vigilant and effective resources in Ireland, twice suspending the *habeas corpus* to strengthen the hands of the Irish executive. Mr. James Stephens was the controlling influence of the "Revolutionary Brotherhood" in Ireland, and the seizure of his organ, "The Irish People," in September, 1865, and of himself in November, created intense excitement, which was more widely extended by his escape on the 24th of the same month. The rising in March, 1867, gave a great number of active spirits into the hands of the government. Following the failure, the parliament passed a reform bill extending the franchise; this was supplemented by Mr. Gladstone's bill for the disestablishment of the Anglican church in Ireland, which was followed by a land-tenure bill for Ireland and a naturalization bill. Through-

1868-'9 immense meetings were held in favour of amnesty for the political prisoners, in which the corporations of leading cities took part.

This developed so much national spirit and concentration of feeling that it was taken up by Mr. Isaac Butt, to direct its energy and fervor into a new national movement on a constitutional basis. Gentlemen of various classes and religions entered the "Home League," and a great national convention of conference was held in Dublin, Nov. 18, 1868, at which the principles and objects of the movement were declared. The conference solemnly asserted the inalienable right of the Irish people to self-government, and adopted "the principle of a federal arrangement, which would give to an Irish parliament the right of legislation for and regulating all matters relating to the internal affairs of Ireland, while leaving to the imperial parliament the power of dealing with all questions affecting the imperial crown and government, legislation regarding the colonies and other dependencies of the crown, the relations of the empire with foreign states, and matters appertaining to the defence and safety of the empire at large, as well as the right of granting and providing the supplies necessary for imperial purposes." In the election following the dissolution of parliament in 1874, the success of the home rule cause was very significant. In Ireland 60 nobles and gentlemen elected were pledged to support the rule, while England sent 28 also pledged. A new Disraeli administration initiated its policy by warning, on April 17, through the lords justices, a national Dublin journal. The act having been brought before parliament.

May 1, 1874, was defended by the secretary of Ireland on the ground that "a spirit of division still existed there which might be fanned into a flame."—See Giraldus Cambrensis, *Topographia Hibernica* and *Expugnatio Hibernica* (Frankfort, 1602, and in Holinshed's edition); Lanigan's "Ecclesiastical History of Ireland to the 13th Century" (4 vols., Dublin, 1822); Betham's "Irish Antiquarian Researches" (2 vols., Dublin, 1826), and "The Antiquities and the Cymbri" (1834); O'Connor's "Annals of Eri" (2 vols., Dublin, 1832); "Annals of Ireland," by James Graceless (1842); "The Annals of Ireland," by John Glyn (Dublin, 1849); publications of the Irish archaeological society (Dublin, *et seq.*); publications of the Ossianic society (Dublin, 1853 *et seq.*); O'Brennan's "Annals of Ireland" (Dublin, 1855); "The Four Masters' Annals of the Kingdom of Ireland," edited by J. O'Donovan (7 vols., Dublin, 1856); Todd's "Wars of the Irish and Danes" (1858); MacGeoghegan's "History of the Ancient and Modern," continued up to the present date by John Mitchel (New York, 1858); Gustave de Beaumont, *L'Irlande sociale et politique* (2 vols., Paris, 1839); and Perraud, *Études sur l'Irlande contemporaine* (Paris, 1862).

**IRELAND, Church of**, the name of the Irish branch of the Anglican Episcopal church. Until Jan. 1, 1871, this church was an integral part of the "Church of England and Ireland," which was the establishment in Ireland as well as in England. (See ENGLAND, CHURCH OF.) In 1868 the house of commons, on motion of Mr. Gladstone, resolved to disestablish the church in Ireland. The house of lords rejected the proposition, but under the pressure of public opinion, which strongly expressed itself against the continuance of the privileges of the Irish church, the "royal commissioners on the revenues and condition of the church of Ireland" recommended important reductions as to the benefices of the Irish church. Mr. Gladstone, having become prime minister toward the close of the year 1868, introduced in March, 1869, a new bill for the disestablishment and disendowment of the Irish church, which was passed by both houses of parliament, and on July 26 received the royal assent. By this act a body of commissioners of church temporalities in Ireland was appointed, in whom the whole property of the Irish church was to be vested from the day the measure received the royal assent. A distinction was made between public endowments (valued at £15,500,000), including everything in the nature of a state grant or revenue, which were to be resumed by the state, and private endowments (valued at £500,000), which were defined as money contributed from private sources since 1660, and which were to be restored to the disestablished church. Provision was made for compensation to vested interests (including Maynooth college and the *regium donum* of the Presbyterians), the largest of which in the aggregate were those of incumbents, to each of whom was secured during his life, provided he continued to discharge the duties of his benefice, the amount to which he was entitled, deducting the amount he might have paid for curates; or the interest might under certain circumstances be commuted upon his application for a life annuity. Other personal interests provided for were those of curates, permanent and temporary, and lay compensations, including claims of parish clerks and sextons. The aggregate of the payments would amount to about £8,000,000, leaving about £7,500,000, giving an annual income of about £30,000, at the disposal of parliament. When the affairs of the establishment should be wound up, the commissioners were to report to the queen that the objects immediately contemplated by the act had all been provided for, and to report the amount of surplus available for charitable purposes. The actual disestablishment provided for by the Irish church act took effect on Jan. 1, 1871, when all church property became vested in the church temporalities commissioners, and the right of the Irish bishops to sit in the house of lords ceased. Previously a general convention held in Dublin in 1870 adopted a constitution for the

church of Ireland. The church is governed by a general synod, meeting annually in Dublin, and consisting of a house of bishops and a house of clerical and lay delegates. The house of bishops have the right of veto, and their veto prevails also at the next synod. The bishops are elected by the diocesan convention, but whenever the latter fails to elect a candidate by a majority of two thirds of each order, the election devolves upon the house of bishops. The primate (archbishop of Armagh) is elected by the bench of bishops out of their own order. The property of the church is vested in a "representative church body," which is composed of all the archbishops and bishops, of one general and two lay representatives for each diocese, and 12 co-opted members. At the first general synod of the church several resolutions against the introduction of ritualistic practices were adopted. As late as 1833 the church of Ireland, notwithstanding its small membership, had four archbishoprics and 18 bishoprics; in that year the number of archbishoprics was reduced to two, Dublin and Armagh; and the number of bishoprics to ten, five for each archbishopric. The number of benefices in 1873 was 1,548; the number of curates 622. The population connected with the church of Ireland, according to the census of 1861, was 693,357, or 11.9 per cent. of the total population; in 1871, 683,295, or 10 per cent. of the total population. Immediately on the passing of the Irish church act, the church temporalities commissioners took charge of all the property formerly belonging to the established church, and issued forms of claims to be filled up by clergymen or other persons entitled to receive a continuance of clerical income or compensation. The total number of clergy and officers who had commuted under the provisions of the act to the end of 1873, when the time expired, was 6,162, of whom 1,459 were incumbents, 921 curates, 579 non-conformist ministers, and 3,203 church officers. The total number of non-commutants was 415, of whom 20 were incumbents, 15 curates, 30 nonconformist clergy, and 300 church officers. The total amount of commutation paid in respect of claims investigated up to February, 1873, was £8,259,673.

**IRELAND. I. Samuel**, an English engraver and author, born in London, died there in July, 1800. After learning engraving, he became a dealer in curiosities, scarce books, prints, &c., but ultimately turned tourist and author. He visited Holland, Brabant, France, and various parts of England, and published several illustrated works of travel and scenery, none of which have now much interest or reputation. He also published "Graphic Illustrations of Hogarth" (1794-'9). **II. William Henry**, son of the preceding, born in London in 1777, died there, April 17, 1835. He was educated in France, and at the age of 16 was apprenticed to a conveyancer in his native city. Having accompanied his father to Strat-

ford-upon-Avon, and noticing his enthusiasm for Shakespearian relics, he forged a deed or lease containing a pretended autograph of the poet, which he said he had found among some old law papers. The eagerness with which his father believed this tale induced him to manufacture other documents of the same description; and he finally produced a play called "Vortigern," purporting to be by Shakspeare. It deceived many literary men, and Sheridan purchased it for Drury Lane theatre, where it was produced with John Kemble in the leading part; but the total failure of the play, joined with the attacks of Malone and others, soon led to a general conviction of young Ireland's dishonesty. "Vortigern" and "Henry II." a similar production, were printed in 1799, and the former was republished in 1832, with a facsimile of the original forgery. Being required to show the source from which he had derived the manuscripts, he confessed his deception, left his father's house, and abandoned his profession. He passed the rest of his life in literary pursuits, publishing several novels which never had much popularity, "Neglected Genius," a poem (1812), &c. A new edition of his "Confessions" (1805), containing a full account of his literary forgeries, was published in New York in 1874, with additional facsimiles, and an introduction by Richard Grant White.

**IRENÆUS**, *Salut*, one of the fathers of the church, supposed to have been born near Smyrna about 135, died in Lyons about 202. In a letter to the Valentinian Florinus, Irenæus reminds him of their having been both disciples of Polycarp; he also studied under Papias, according to Jerome. He probably accompanied Pothinus into Gaul, was ordained priest by him, and labored under him among the Greek colonists on the Rhône. In the beginning of 177 he was sent to Rome by the church of Lyons and Vienne, to consult with Pope Eleutherus about the spread of the Montanistic doctrines, and was while there elected and consecrated bishop of Lyons. In the controversy relating to the celebration of Easter, Irenæus acted as mediator between the eastern bishops and Pope Victor I. About 181 he published in five books his work *Adversus Hæreses*, which is considered the most valuable relic of early patristic literature. Of the original Greek, only the greater part of the first book has been preserved in the writings of Epiphanius and of Hippolytus, who was a pupil of Irenæus; but the existing Latin version, in five books, is very ancient, and perhaps contemporary with the author. Four Greek fragments of other compositions attributed to him were discovered by Pfaff at Turin in 1715. The first edition of his works is that of Erasmus (Basel, 1526, frequently republished); the best are those of Grabe (Oxford, 1702), Massuet (Paris, 1710, and Venice, 1734), Stieren (Leipzig, 1851-'3), Harvey (Cambridge, 1857), and in vol. vii. of Migne's *Patrologie grecque*.

**E**, a Byzantine empress, born of obscure parents in Athens about 752, died on the island of Lesbos, Aug. 15, 803. She was an orphan 17 years old when her beauty and attractions attracted the attention of the emperor Justinian V. Copronymus, who destined her to be the wife of his son and heir Leo. Their nuptials were celebrated with royal splendor in Constantinople in 769. Her husband compelled her to abandon the worship of images, but she gained his love and confidence, and was appointed in his testament (780) to administer the government during the minority of his son Constantine VI., then nine years of age. In 786 she assembled at Constantinople a council to restore images in the churches; this was interrupted by the garrison of the city.

In the following year she called a council at Nicæa, in which the veneration of images was declared agreeable to Scripture, and to the fathers and councils of the church. Constantine was encouraged by his friends to throw off the maternal yoke, and she pronounced the perpetual banishment of Irene. Her vigilance disconcerted the project, while the two factions divided the empire. The Armenian guards refused to take the oath of fidelity which she exacted to herself, and Constantine became lawful emperor. He was dismissed to a life of solitude in the imperial palaces, but her intrigues and several conspiracies for her restoration. On the return of Constantine from an expedition against the Arabs in 797, he was assailed in the hippodrome by assassins, but escaped, and fled to Phrygia. Irene joined her son and led him to return to the capital. There she was surprised by her emissaries, and stabbed in the eyes, but, according to Gibbon, survived for many years. Irene ruled the empire for 20 years with prudence and energy. In 802 she was renewed by the Byzantine emperor and that of Charlemagne, and she is said to have sent ambassadors (about 800) to negotiate a marriage between that emperor and her son, to unite the empires of the East and West, but there is reason to doubt that this was the object of the embassy. As her golden chariot moved through the streets of Constantinople, the reins of the four white steeds were held by as many patricians marching on foot. One of these patricians was a eunuch; and this man, the great treasurer Nicephorus, had been secretly invested with the purple, and he had caused her arrest, and, after treacherously obtaining possession of her treasures, had banished her to the isle of Lesbos (802). There, destitute of all means of subsistence, she gained her livelihood by spinning, and died of starvation within a year. Her protection of images has caused her to be enrolled among the saints in the Greek calendar.

**ON, Henry**, an English soldier, son-in-law of Oliver Cromwell, born in Nottinghamshire, died in the camp before Limerick, Ireland, Aug. 15, 1651. He graduated at Trinity col-

lege, Oxford, and commenced reading for the law; but his studies were interrupted by the civil war, and he joined the parliamentary army. At the battle of Naseby he was taken prisoner, but escaped. Having married Bridget Cromwell, Oliver's eldest daughter, in 1646, he was appointed captain of horse, and soon afterward colonel. Ireton was one of the most active in compassing the death of the king, and signed the death warrant. Under the protectorate Cromwell made him president of Munster and afterward lord deputy of Ireland, in which capacity he acted with much administrative vigor, and the greater part of the island submitted to him without resistance. He died of the plague. His body was carried to London, and buried in the chapel of Henry VII. in Westminster abbey. On the restoration his remains were exhumed, exposed on a gibbet, and burned by the hangman at Tyburn. The royalists admitted his ability, but denounced him as treacherous and hypocritical; his friends eulogized his sanctity and talents. From his skill in drawing up ordinances, petitions, and declarations, he was called "the scribe." A pension of £2,000 from the confiscated estates of the duke of Buckingham, refused by him, was settled on his family.

**IRIARTE**. See **YRIARTE**.

**IRIDIUM** (Lat. *iris*, rainbow), a metal so named from the colors exhibited by its solutions; symbol, Ir; chemical equivalent, 98.56. It was discovered by Descotils in 1803, and by Smithson Tennant in 1804. It occurs native and nearly pure, also associated with osmium, platinum, and rhodium, and in alloys of various proportions of these metals. An alloy of one fifth platinum and four fifths iridium has been met with in octahedral crystals whiter than platinum, and of specific gravity 22.66. When native platinum is dissolved in nitro-hydrochloric acid, black scales remain behind, which are composed of iridium and osmium. These metals may then be separated by one of the methods in use, and the iridium is obtained in a gray metallic powder, resembling spongy platinum. It is very hard, white, and brittle, and may be melted on lime by the oxyhydrogen blowpipe, or by the heat of the voltaic current. When thus fused it has the specific gravity of 21.15. None of the acids attack the pure metal, but when alloyed with platinum it is readily dissolved by aqua regia. Iridium black, similar to platinum black, may be obtained by decomposing a solution of its sulphate by alcohol. If heated in a finely divided state in the open air, iridium absorbs oxygen; it is also oxidized by nitre and caustic potash. Small grains of iridium containing a little platinum are picked out from the grains of the latter metal, and from their extreme hardness make excellent nibs for gold pens.

**IRIS**, in Greek mythology, a daughter of the sea god Thaumias and of the oceanide Electra, and sister of the Harpies. According to some writers she was a virgin; others make her the

wife of Zephyrus and mother of Eros. She was the personification of the rainbow, and messenger of the gods.

**IRIS**, in botany, the generic name of a number of beautiful plants belonging to the natural order *iridaceæ*. The plants of this order are endogenous, having a creeping rootstock (*rhizoma*), or else a flat tuber (*cormus*), equitant leaves, irregular flowers, three stamens, and an inferior ovary. They are represented equally in the temperate and hotter regions of the globe. The wild species of iris are generally called blue-flag, and the cultivated flower-de-luce, from the French *fleur de Louis*, it having been the device of Louis VII. of France. Our commonest blue-flag, *I. versicolor*, is a widely distributed plant, its violet-blue flowers, upon stems 1 to 3 ft. high, being conspicuous in wet places in early summer; the root of this possesses cathartic and diuretic properties, and is used by some practitioners. The slender blue-flag, *I. Virginica*, found in similar localities near the Atlantic coast, is smaller in all its parts. A yellowish or reddish brown species, resembling the first named in appearance, is *I. cuprea*, found in Illinois and southward. There are three native species which grow only about 6 in. high and have blue flowers: *I. verna* and *I. cristata*, in Virginia and southward, and *I. lacustris*, on the shores of the great lakes; these are sometimes seen as garden plants. The orris root of the shops is the



Iris Florentina.

produce of *I. Florentina*, *I. pallida*, and *I. Germanica*, which grow wild in the south of Europe; the rhizomes are pared and dried, and exported from Trieste and Leghorn, chiefly for the use of perfumers; they have the odor of violets. The garden species of iris are numerous, and these by hybridizing and crossing have produced a great many known only by garden names. The dwarf iris, *I. pumila*, from 3 to 6 in. high, flowers very early and

makes good edgings to borders; the common flower-de-luce of the gardens is *I. Germanica*; the elder-scented flower-de-luce is *I. sambucina*. There are several with yellow and brownish flowers, among which are *I. pseudacorus* and *I. flavescens*; the recently introduced *I. Iberica*



Mourning Iris (Iris Susiana).

presents a remarkable combination of colors. These and many others are hardy in our climate, and readily multiplied by division of their rootstocks. *I. Susiana*, the mourning or crape iris, is one of the finest of the genus, its flowers being very large, dotted and striped with purple on a gray ground. In the northern states it needs winter protection. There are several species of iris with bulbous roots, and highly ornamental, such as the Spanish iris (*I. ziphoides*) and the Persian iris (*I. Persica*), with exquisitely scented blossoms of an elegant pearly whitish hue, admirably adapted to forcing in pots for the drawing room.

**IRISH MOSS.** See CARRAGEEN.

**IRISH SEA**, that part of the Atlantic ocean which lies between Scotland on the north, England on the east, Wales on the south, and Ireland on the west. It contains the isle of Man, Anglesea, Holyhead, and a few islets. Carnarvon and Morecambe bays, and the estuaries of the Dee, Mersey, and Ribble, are its inlets in England; Solway frith, Wigtown and Luce bays, in Scotland; and Dundrum, Carlingford, Dundalk, and Dublin bays, in Ireland. The principal rivers flowing into it from Great Britain are the Esk, Ribble, Mersey, and Dee; from Ireland, the Liffey and the Boyne.

**IRKUTSK.** L. A government of Asiatic Russia, in the S. part of E. Siberia, bordering on Mongolia; area, 271,875 sq. m.; pop. in 1870, 365,810. The continuations of the Altai mountains form its S. boundary. The surface is elevated, the general level in the north and east being from 2,500 to 3,000 ft., and that in the south 1,200 to 2,000 ft. It is watered by the Angara, Lena, and several smaller rivers, and

contains Lake Baikal. It is rich in minerals, among which are gold, silver, copper, and iron. Extensive forests, furnishing excellent timber, and abounding in all kinds of game, occupy a large portion of the country; and agriculture is prosperously conducted, barley and rye being the principal crops. The pastures support great numbers of cattle and sheep. The summers are short, but very warm and generally clear, while the winters are so cold that sometimes mercury freezes. A considerable portion of the inhabitants are descendants of Russian exiles, and the majority of the natives are Mongols, Tunguses, and Buriats. II. A city, capital of the government and of E. Siberia, on the right bank of the Lower Angara, about 85 m. from its source in Lake Baikal; pop. about 30,000. It lies on both sides of the mouth of the Ushakovka, a small tributary of the Angara, and opposite the confluence of the Irkut with the latter river. It is well built, paved, and lighted. The principal streets run parallel with the Angara, on the banks of which are the exchange, the admiralty offices and dockyards, the governor general's palace, and various government factories and workshops in which convicts are employed. In the centre of the city is a handsome public square, on which front the houses of many of the functionaries, and the guard house. The school of medicine, the gymnasium, and the former depot of the Russian American company are fine and spacious. There are many public schools, a high school for navigation, a female orphan school, a theatre, and a good bazaar. The city is fortified, and has a citadel. It contains 15 churches, and numerous convents and hospitals, and is the see of an archbishop. Nearly all the houses are of wood, neatly planked, and painted yellow or gray. The principal manufactures are woollens, linens, leather, glass, and soap. The trade of Irkutsk is important. It is the great commercial entrepot between the Chinese empire and European Russia, exporting to the latter tea, rhubarb, fruits, porcelain, paper, silk, &c., in exchange for furs, metals, and various European goods. It has a great fair in June.

**IRON**, one of the elementary substances, possessing when pure the following characters: specific gravity, 8.1393 (Percy); hardness, 4.5; crystalline form, isometric; color, silver-gray; lustre, metallic; atomic weight, 56 (O = 16); specific heat, 0.113795. Its symbol is Fe (*ferrous*). Although seldom found native, and never pure, iron is the most universally and extensively distributed of metals. It occurs in large deposits in the form of oxide, and constitutes an ingredient of nearly all rocks, soils, and natural waters. So-called chalybeate mineral springs contain it in relatively large amounts. As a consequence of this wide distribution in the inorganic world, it is found also in vegetable and animal organisms, constituting 0.07 per cent. of the blood, or 5.5 to 8.5 per cent. of the ash of blood. Pure iron is un-

known in the arts; and, owing to the difficulty of procuring it on a large scale, its properties have been but slightly investigated. Peligot states that iron prepared by the reduction of its protochloride by hydrogen, is filamentous, compact, malleable, and almost as white as silver. Iron deposited by the galvanic battery is grayish white and susceptible of a high polish; it is scarcely attacked by sulphuric or muriatic acid at ordinary temperatures, but is dissolved on application of heat, evolving hydrogen free from fetid odor (in contradistinction from manufactured iron). Its malleability is not affected by rapid cooling after exposure to a high temperature. Iron may be rendered strongly magnetic by induction, but loses its magnetic power, when pure, as soon as the source of magnetism is removed. Throughout a wide range of temperature, from red heat to near its melting point, iron is more or less plastic. At red heat it is readily forged under the hammer, and at white heat two masses of iron can be firmly and intimately incorporated with each other (welded) by hammering or pressure. Welding, though not exclusively a property of iron, is possessed by no other metal to so great a degree. It is volatilized in the heat of the voltaic arch.—Iron is a metal of active chemical affinities, and enters into a large number of compounds. It combines with oxygen in four proportions, as follows:

COMPOUNDS WITH OXYGEN.	Formula.	Iron, per cent.	Oxygen, per cent.
Ferrous oxide (protoxide of iron).....	FeO	77.77	22.23
Ferric oxide (sesquioxide of iron).....	Fe <sub>2</sub> O <sub>3</sub>	70.00	30.00
Ferroso-ferric oxide (protosessquioxide of iron; magnetic oxide).....	Fe <sub>3</sub> O <sub>4</sub>	72.41	27.59
Ferric acid.....	FeO <sub>3</sub>	58.90	41.10

Metallic iron rusts when exposed to moist air, and is gradually and completely converted into oxide. Mr. Grace Calvert, investigating the conditions necessary or favorable to the rusting of iron, has found that it is not acted upon by pure, dry oxygen or carbonic acid, while it is feebly attacked by moist oxygen or carbonic acid, and most rapidly by moist oxygen containing traces of carbonic acid, which forms first oxide, then ferrous carbonate, and finally hydrated sesquioxide, with admixtures of ferrous oxide and carbonate. Carbonic acid and water likewise act with energy. Solutions of alkaline hydrates, carbonates, or bicarbonates prevent the rusting of iron, while a solution of sugar promotes it. The oxidation of iron may be hindered by attaching it to a more electro-positive metal, such as zinc, or promoted by the presence of a more electro-negative metal, such as copper. Under ordinary circumstances zinc will protect iron when it covers only  $\frac{1}{15}$  of the surface of the latter, but in a solution of sugar the proportion of surface covered by zinc must be 1 to 15. The following analysis by Grace Calvert gives the composition of rust from Llangollen, Wales:

Ferric oxide.....	98.004	Silica.....	0.196
Ferrous oxide.....	5.810	Ammonia.....	trace.
Ferrous carbonate.....	0.805		
Calcic carbonate.....	0.295		100.000

Iron decomposes steam at a red heat and is converted into oxide, hydrogen being liberated. But hydrogen passed over oxide of iron at a red heat reduces it to metallic iron, water being formed. The character of the action is here determined by the relative amounts of free hydrogen and steam. If the former predominates, reduction takes place; if the latter, oxidation. Dilute mineral acids dissolve iron, converting it into a ferrous salt, hydrogen being evolved. Under certain circumstances iron becomes "passive," and is not attacked by strong acids. This condition is brought about in various ways, and seems to be connected with a superficial oxidation of the iron. Iron burns with brilliancy in oxygen gas. Reduced by hydrogen from finely pulverized oxide, it burns readily in the air, taking fire spontaneously when the temperature of reduction has not been too high, but otherwise requiring to be first ignited. Ferrous oxide possesses so strong an affinity for oxygen that it is isolated with difficulty. Its salts are permanent when crystallized, but rapidly absorb oxygen when exposed to the air in solution. Ferrous carbonate occurs abundantly in nature. The most important ferrous salt is the sulphate, commonly called green vitriol or copperas, obtained as an incidental product in many metallurgical operations, and applied to manifold uses in the arts. It forms a number of double salts with other sulphates. Ferric oxide occurs abundantly in nature. (See IRON ORES.) It may be prepared artificially by precipitating the hydrate from solution and subsequently igniting it, and also by simple ignition of the sulphate or nitrate; its powder is red. Ferric oxide and its salts are stable in the air, but part with a portion of oxygen when in contact with organic matter; a familiar instance is the rotting of fabrics of cotton or linen by "iron mould." On this property depends the disinfecting power of iron compounds. Ferric oxide acts also as a carrier of oxygen. Bischof has shown that spongy metallic iron is a powerful disinfectant, probably first becoming oxidized itself, and subsequently parting with its oxygen to the organic matter, then becoming again oxidized, and so on. Ferric oxide is largely used in the polishing of metals and glass. It forms salts which do not crystallize as readily as the ferrous salts. Ferroso-ferric oxide, generally called magnetic oxide, is abundant in nature, and may be regarded as a compound of the two oxides, and its salts as compounds of ferrous and ferric salts; it is perfectly stable; its powder is black. Ferric acid is formed by heating together ferric oxide with saltpetre; it forms salts which are very unstable.—Iron combines with sulphur in two proportions, forming a proto- and a bisulphide. The former is largely used in

the preparation of sulphuretted hydrogen for chemical purposes. The latter, known as pyrite or iron pyrites, occurs abundantly in nature, and is used largely as a source of sulphur in the preparation of sulphuric acid. Iron forms a definite compound with nitrogen,  $\text{Fe}_2\text{N}_3$ ; but it is doubtful whether nitrogen plays any part in the manufacture of iron or steel. Compounds of carbon, phosphorus, and silicon with iron also exist; the effect of these substances on the properties of iron is discussed below. The compounds of iron with chlorine and cyanogen are of great importance in chemistry and in the arts. There are two chlorides,  $\text{FeCl}_2$  and  $\text{Fe}_2\text{Cl}_6$ , corresponding to the two oxides, and two double compounds with cyanogen, potassic ferrocyanide or yellow prussiate of potash,  $\text{K}_4\text{FeC}_6\text{N}_6$ , and potassic ferricyanide, or red prussiate of potash,  $\text{K}_3\text{FeC}_6\text{N}_6$ , which are valuable chemical reagents. The ferrocyanide of iron, or Prussian blue,  $\text{Fe}_4\text{FeC}_6\text{N}_6$ , is formed by precipitation of a solution of a ferric salt with yellow prussiate of potash.—Iron is used in medicine as a reconstructive tonic. It is an important constituent of the animal tissues, and under ordinary circumstances the supply normally present in the food is equal to the demand; but when the number of red blood corpuscles, which contain much iron and are the special carriers of oxygen, is diminished, then their re-formation may be promoted by the administration of iron preparations. This condition (anæmia) is the real indication for iron, most of the special diseases in which it is used being dependent upon or accompanied by this condition. Hence it is largely used not only in anæmia, but in neuralgic affections, dropsy, Bright's disease, scrofulous affections, incipient phthisis, hæmorrhages, the various diseases of females, in the convalescence from acute diseases, and in the protean forms of debility and weakness. A few of the salts are astringent, and a portion of their effect is probably due to their local action upon the stomach. These may be used not only as reconstructive agents, but to check discharges and arrest hæmorrhage. Iron is absorbed in small quantity, so that a considerable proportion of every dose passes through the bowels unappropriated. It may be detected in the urine, and the amount normally present has been found increased in the milk of animals to which iron has been administered. The bodily temperature is raised, the pulse quickened and strengthened, and the appetite and nutrition improved by its administration. Headache and constipation are the consequences of too large doses or too long continued use. The number of preparations in use is exceedingly and unnecessarily large, and constantly increasing. Among them are metallic iron, a grayish powder; the protocarbonate, in pills and mixture; the sulphate; hydrated oxide, usually called subcarbonate; tincture of the chloride; wine of iron; tartrate of iron and potassa; phosphate, lactate, and iodide; citrate



and quinia; iron and strychnia, &c. The best preparations are the perchlorate, and ferric alum. The fresh-precipitated sesquioxide is the best antidote. In cases of decided anæmia, the preparations of iron are indicated, as ferrous chloride, the perchloride, and sulphate. In other cases the milder preparations are generally preferred. The iodide of iron is especially adapted to scorbutic affections. The addition to iron of nux vomica or quinia, or of bitter tonics like gentian, often increases its therapeutic action. The administration of iron is contra-indicated by gastric or enteric inflammation, by plethora, and febrile conditions generally. The dose varies with the preparation used, the amount of food, and is best given with orange juice. During its use, the feces are black by it.—In the arts, iron occurs in many forms, as wrought iron, cast iron, and pig iron. Wrought iron is nearly pure, and highly malleable, ductile, and weldable. It is fused at a high temperature, and its finished forms are generally wrought at a welding heat. It contains invariably a small amount of chemically combined carbon, 0.25 per cent. or less, and a small amount of slag or iron-ore cinder. Its specific gravity is from 7.3 to 7.8. Its temperature of fusion is about 1800° C. or 3240° F. Cast iron is in most respects the opposite of wrought iron. It is not in the slightest degree malleable, ductile, or weldable. It is readily fused and is therefore always cast in moulds. It is much harder than wrought iron, and is brittle and rigid. There are many varieties of cast iron, exhibiting great diversity of properties. In color, the extremes are white and gray, with a number of intermediate shades. The hardness and brittleness vary through wide limits. White cast iron is the hardest, most rigid, and most brittle; in its action of the file and drill, while the dark varieties can be tooled with ease, the fusibility of the different varieties of cast iron likewise differs greatly. The dark varieties generally require a high heat for fusion, and become thin and liquid; they fill forms well, they expand in cooling, make sharp angles, and are hence often called foundry iron. The lighter shades do not become so thin when fused, and as they contract they are not adapted for castings; they contain a smaller amount of foreign matter, and hence, being adapted to conversion into wrought iron, are called forge irons. The specific gravity of cast iron varies from 6.9 to 7.8. Its melting point is about 1500° C. or 2700° F. The difference between gray and white iron is most marked in the molten condition, as they come from the furnace. Dark cast iron contracts quickly and sets without any movement of the surface; when hard, the upper surface is concave and the lower convex. White iron emits a shower of brilliant sparks, and its surface is easily agitated by the formation of crystals;

the forms of the crystals are characteristic of the grade of the iron; when hard, the surface is honeycombed and depressed. There are two other varieties of cast iron: specular iron, or *Spiegeleisen*, and silvery or glazy iron. They are both white, but differ in character and composition from each other and from ordinary white iron. Chemically, cast iron is further removed than wrought iron from the pure metal; it always contains from 2 to 5 per cent. of carbon. The union of the carbon with the iron may be either chemical or mechanical, and usually both conditions are present in the same mass. The result of the chemical union of iron and carbon is white iron, while the mechanical mixture of iron with black scales of graphite is dark-colored; the preponderance of one or the other of these conditions gives the various shades from black to white. Sometimes cast iron is composed of a mixture of white and gray iron in patches; the iron is then called mottled. The different grades of pig iron are generally designated by numbers. No. 1 stands for highly graphitic open-grained iron, and Nos. 2, 3, and 4 for the lighter and more compact varieties, passing toward white. Mottled and white irons are generally designated by name. Malleable castings (see IRON MANUFACTURE) are cast iron which has been rendered partially malleable without alteration of form.—Steel holds, both in physical properties and in chemical composition, an intermediate position between cast and wrought iron. It may be considered as a compound of iron with 0.25 to 2 per cent. of carbon. The limits given for carbon in wrought iron, steel, and cast iron, viz., 0.25 per cent. or less in wrought iron, 0.25 to 2 per cent. in steel, and from 2 to 5 per cent. in cast iron, are to be regarded as approximate only. No sharp and accurate distinction, based on chemical composition, can be drawn between these three varieties of iron. Steel with the minimum of carbon (mild or soft steel) can scarcely be distinguished from wrought iron; it exhibits the properties of malleability, ductility, and weldability nearly to an equal degree with wrought iron; while steel with the maximum of carbon (strong or hard steel) approximates so nearly to cast iron that the above properties are almost entirely wanting. The fusing point of steel is intermediate between those of cast and wrought iron. The properties that preëminently characterize steel are connected with hardening and tempering. When heated to redness and suddenly cooled by plunging into water or other liquid, it becomes hard in proportion to the amount of carbon it contains, the temperature to which it has been raised, and the rate of cooling. Such hardened steel, being again heated and allowed to cool slowly in the air, loses its hardness to a degree proportional to the temperature to which it was reheated. This process is called tempering. Hardening and tempering are generally regarded as pe-

cellular to steel; but, properly considered, they belong to all compounds of iron and carbon. Wrought iron contains too little carbon to show much hardening when rapidly cooled from a high temperature, but it is generally rendered more rigid by such treatment. Cast iron becomes very hard and brittle on sudden cooling, but, since it is much more complex in composition than steel, the circumstances controlling the hardening are not so well understood. Cast iron which has been hardened may by a process of tempering be rendered soft again. The precise nature of the hardening process is not understood. It has been supposed to result from a chemical union of the carbon with the iron, formed at high temperature, and maintained under rapid, but resolved by slow cooling. It has also been ascribed to a state of tension or polarity of the particles, which is relieved by tempering. In the case of cast iron a change in the condition of the carbon may be often observed; some dark graphitic irons become perfectly white (chill) on sudden cooling. As to the character of the union of iron and carbon in cast iron, a difference of opinion exists. Gurlt, Mayrhofer, Hahn, and others, have endeavored to establish the existence of definite combinations of iron and carbon, such as  $\text{FeC}$ ,  $\text{Fe}_2\text{C}$ ,  $\text{Fe}_3\text{C}$ ,  $\text{Fe}_4\text{C}$ , and suppose the different varieties of cast iron to be compounds or mixtures of these definite carburets with iron. The formula of spiegeleisen, in which the carbon is all combined, was supposed by Karsten to be expressed by  $\text{Fe}_3\text{C}$ , which would require 5.8 per cent. carbon, but this amount is never found in reality. Gurlt proposed a lower carbide,  $\text{Fe}_4\text{C}$ , which he supposed to stand in the same relation to gray iron as Karsten's tetracarbide did to white iron. These formulas, although interesting and attractive in a theoretical point of view, must be regarded as purely imaginary. Isolated analyses may seem to indicate their existence, but extended investigations show that the variations of composition in cast iron are too great to admit of any definite formulas. In the molten condition all the carbon is most probably combined with the iron. The separation of carbon as graphite takes place on cooling, and the amount separated is, other things being equal, determined by the rate of cooling. When we consider the number of factors that enter into the case, it is not surprising that we fail to detect any regularity in the composition of cast iron. Durré proposes a classification of cast iron based on physical characters. He considers all pig irons to be mixtures of two different substances, namely, graphite and a white or light gray matrix or ground mass. He recognizes three types of iron, represented by spiegeleisen, in which the ground mass forms bold, brilliant, reed-like bundles of crystals; Swedish cannon iron, in which it appears as thin thread-like bundles; and Scotch iron, in which it presents short interlaced figures, almost obscured by the graph-

ite.—The manifold properties possessed by iron in its various forms constitute its great value in the arts. No other metal or metallic combination possesses such a wide range of properties. The hardness and rigidity of pig iron, and the facility with which it can be cast into any desired form, adapt it to use in construction for the resistance of a crushing weight, and also to an infinite variety of utensils. The purer kinds often possess moreover great toughness, and are available for ordnance. Wrought iron, having a high degree of tenacity and elasticity combined with malleability and ductility, is applicable to numberless uses in every-day life, particularly those which require not only strength, but the ability to resist shock. Steel is stronger than wrought or cast iron, but is intermediate between the two in rigidity. It replaces wrought iron advantageously in construction where strength is required in small bulk; but it is excluded, except in the softest varieties, where shocks are to be encountered. Its property of hardening, combined with malleability and ductility, adapts it for the manufacture of cutting tools. Until the comparatively recent introduction of the Bessemer process and the Siemens regenerative heating furnace (see FURNACE), it was impossible to melt wrought iron on the large scale; and the distinction between wrought iron and cast steel was therefore well marked in their physical characters, steel showing a homogeneous crystalline, and wrought iron a more or less fibrous structure, due to the intermingled cinder. This distinction in physical characters disappears when soft iron (that is, iron with 0.25 per cent. or less of carbon) is melted and cast in moulds; and the tendency of metallurgists at the present time is to call this product steel, without regard to its contents in carbon or its susceptibility to hardening. Bessemer and open-hearth (Martin) steels include products varying from hard steel to soft iron; they have, however, the common property of homogeneity, whence the name sometimes applied to them of "homogeneous metal." In both steel and wrought iron, therefore, the distinction is to be observed between welded and cast products. (See STEEL.)—Manufactured iron has thus far been considered in the present article merely as a compound of iron and carbon. It is generally, however, much more complex in composition, and we will now consider each kind separately in greater detail. I. CAST IRON. This is the product of the blast furnace (see IRON MANUFACTURE), and contains a number of elementary substances derived from the ore, flux, and fuel used in its production. The substances most commonly met with (besides carbon, which must be regarded as essential) are silicon, sulphur, phosphorus, manganese, and more rarely, or in smaller quantities, chromium, copper, nickel, cobalt, titanium, arsenic, antimony, aluminum, m, and magnesium. The following analyses will serve as examples:

ELEMENTS	WHITE IRON.				SPINDLE IRON.				BOTTLED IRON.				GRAY IRON.							
	1	2	3	4	5	6	7	8	9	10	11 a	11 b	12	13	14	15	16	17	18	19
Iron	94.244	94.400	97.800	94.00	98.926	91.049	90.087	87.997	92.800	98.900	91.078	92.085	98.970	98.980	92.284	91.900	98.191	99.480	91.084	91.180
Cast-iron	8.106	8.350	0.900	4.40	2.006	4.188	4.188	8.706	4.888	0.850	1.080	0.084	0.044	0.280	0.744	0.108	0.108	1.280	0.884	0.180
Graphite	0.351	0.770	1.000	0.75	1.083	0.430	0.401	0.497	0.997	0.500	0.897	0.508	0.171	0.180	0.940	0.507	0.928	0.900	0.418	0.180
Silicon	2.023	0.184	0.110	0.84	0.559	4.378	4.298	6.555	10.707	0.600	0.918	0.388	0.880	0.800	1.040	0.307	0.640	1.580	1.471	0.180
Manganese	0.027	0.027	0.110	0.84	0.559	4.378	4.298	6.555	10.707	0.600	0.918	0.388	0.880	0.800	1.040	0.307	0.640	1.580	1.471	0.180
Phosphorus	0.083	0.083	0.096	trace	0.055	0.090	0.110	0.171	0.014	0.350	0.081	0.081	0.082	0.070	0.011	0.004	0.070	0.018	0.018	0.170
Vanadium	0.085	0.085	0.200	0.07	0.090	0.187	0.110	0.573	0.080	1.000	0.088	0.010	0.080	1.580	0.085	0.054	0.140	0.140	0.083	1.180
Copper	0.065	0.108	.....	.....	.....	0.065	0.190	0.065	0.016	.....	0.011	0.039	0.085	.....	0.050	0.108	.....	0.06	0.100	.....
Nickel	.....	.....	.....	.....	.....	0.043	.....	.....	.....	.....	.....	.....	.....	.....	.....	.....	.....	0.080	0.080	.....
Cobalt	.....	.....	.....	.....	.....	.....	.....	.....	.....	.....	.....	.....	.....	.....	.....	.....	.....	.....	.....	.....
Aluminum	.....	.....	.....	.....	.....	.....	.....	.....	.....	.....	.....	.....	.....	.....	.....	.....	.....	.....	.....	.....
Titanium	.....	.....	.....	.....	.....	.....	.....	.....	.....	.....	.....	.....	.....	.....	.....	.....	.....	.....	.....	.....
Magnesium	.....	.....	.....	.....	.....	.....	.....	.....	.....	.....	.....	.....	.....	.....	.....	.....	.....	.....	.....	.....
Calcium	.....	.....	.....	.....	.....	.....	.....	.....	.....	.....	.....	.....	.....	.....	.....	.....	.....	.....	.....	.....
Alkalies	.....	.....	.....	.....	.....	.....	.....	.....	.....	.....	.....	.....	.....	.....	.....	.....	.....	.....	.....	.....
Arsenic	.....	.....	.....	.....	.....	.....	.....	.....	.....	.....	.....	.....	.....	.....	.....	.....	.....	.....	.....	.....
Antimony	.....	.....	.....	.....	.....	.....	.....	.....	.....	.....	.....	.....	.....	.....	.....	.....	.....	.....	.....	.....
Chromium	.....	.....	.....	.....	.....	.....	.....	.....	.....	.....	.....	.....	.....	.....	.....	.....	.....	.....	.....	.....
Vanadium	.....	.....	.....	.....	.....	.....	.....	.....	.....	.....	.....	.....	.....	.....	.....	.....	.....	.....	.....	.....
	100.000	99.015	100.91	100.51	100.00	100.008	99.980	100.000	99.885	100.990	99.909	99.888	99.997	100.18	100.000	100.000	100.000	99.86	100.000	99.99

The localities of the samples furnishing the above analyses, and their description as far as given, are as follows: White iron.—1. Mariazell, Styria; charcoal; sp. gr. 7.729. 2. Reschitz, Hungary; charcoal. 3. Cleveland, England; coke. 4. Medellin, Colombia, used for stamp heads; sp. gr. 7.45. 5. Primör, Tyrol; spiegeleisen. 6. Sava, Carniola, Austria. 7. Fröschnitz, Styria. 8. Bieber, Prussia. 9. Müsen, Prussia. Mottled iron.—10. Cleveland, England. 11. Styria: a, white portion, sp. gr. 7.069; b, gray portion, sp. gr. 6.928. Gray iron.—12. No locality; analysis by Fresenius. 13. Cleveland, England. 14, 15, 16. Bessemer iron: Reschitz in Hungary, Neuburg in Styria, and English (hematite). 17. American gun iron. 18. Austrian gun iron. 19. "Glazy" iron, English. The influence which each of these elementary substances exerts on the physical properties of pig iron cannot be stated with precision. The subject is one of great complexity, and has not been thoroughly investigated. The following comprises what is known about it. When iron is fused in the presence of carbon, in a reducing atmosphere—conditions which obtain in the blast furnace—it combines with a portion of carbon, forming a readily fusible compound. The condition of the carbon in the molten iron is not certainly known, but it is probably in chemical combination. When, however, this carburetted compound solidifies, the carbon may either remain in combination, giving the iron a white color; or it may assume the form of graphitic scales, mechanically disseminated throughout the mass, giving it a black color; or both conditions of the carbon may coexist, imparting to the iron a shade of gray. So far as is known, these conditions are determined by the rate of cooling of the iron. When the iron is quickly cooled, as on being cast in iron moulds or poured into water, the carbon will remain in combination; when the iron is cooled slowly, the carbon has time to separate, and a part at least will appear as graphite. Snelus ("Journal of the Iron and Steel Institute," vol. i., p. 28) has proved conclusively the separate existence of graphite in pig iron. Bell's experiments ("Chemical Phenomena of Iron Smelting") seem to show that there is no difference in the amount or condition of the carbon in gray and white pig iron made at the Clarence furnace in the Cleveland district, England and he considers the difference of color to be due to the fact that in the white varieties the graphitic scales are so minute as to be no longer visible. His experiments contradict results obtained by investigators in other localities, and have not as yet been confirmed. The highly graphitic variety of pig iron is usually produced at a higher temperature than the white; and it has been noticed that when white iron is exposed to the temperature of a furnace making gray iron, it is changed into gray. This has led to the opinion that the temperature of production is the sole cause of the

difference in the two varieties. A more correct statement of the fact would perhaps be, that the color of the pig metal, or in other words the amount of graphite separated, is due, other things being equal, to the time or rate of cooling. White iron caused to solidify very slowly becomes gray; and gray iron cooled quickly becomes white. The cause of this difference is conceivable on one supposition only, viz.: that there is a limited range of temperature, probably near the point of solidification of the metal, within which the separation of the carbon from the iron takes place, and that the amount of carbon separated in any given instance is proportional to the time consumed by the cooling pig iron in passing through this range of temperature. It is evident that the time required for the metal to cool a given number of degrees, near its point of solidification, must depend partly upon the temperature of the surrounding moulds. The hotter the metal leaving the furnace, the more will it have heated the moulds as it approaches solidification, and consequently the slower will have become the rate of cooling, the longer will be the period during which carbon can separate, and the larger will be the amount of graphitic carbon in the final product. Carbon, as already remarked, increases the fusibility of iron. In chemical combination it renders iron brittle, the brittleness decreasing in proportion as the carbon separates as graphite.—Silicon is nearly always present in pig iron. White iron is occasionally almost free from it, but the darker sorts may contain as much as 8 per cent.;  $\frac{1}{2}$  to 3 per cent. is usual. The conditions favoring the production of a highly siliconized pig iron are slow working, a high temperature in the furnace, and a cinder rich in silica. Silicon, like carbon, renders iron more fusible. The temperature of solidification of pig iron rich in silicon is therefore relatively low; and this fact, combined with the high temperature of production, affords ample opportunity for the carbon to separate as graphite. We consequently find such pig iron always highly graphitic, and very difficult to chill, or convert into white iron by sudden cooling. In many articles made of cast iron, such as rolls, car wheels, &c., it is desired to combine toughness of structure with a hard wearing surface. This is effected by casting the object in a suitable mould of iron, so that the molten iron shall be suddenly solidified on the outside, and rendered white to a moderate depth, while the mass of the casting remains gray. The casting is subsequently annealed, to relieve the tension caused by the unequal cooling. The irons most suitable for this purpose are produced with charcoal and with a cold or but moderately heated blast, and are of exceptional purity. Any considerable amount of silicon prevents the iron from chilling. Silicon renders iron brittle and weak. When present in very large quantity it makes the iron worthless both for castings and for conversion

into wrought iron. It plays an important part in the pig iron employed for making Bessemer steel, supplying by its oxidation the greater part of the heat required to retain the metal in a molten condition. The amount of silicon in Bessemer pig iron varies from 1 to 3 per cent. Silvery or glazy pig iron, occasionally produced when the furnace is working very hot with an excess of fuel, is white, but has none of the properties of white iron properly so called, and is weak and worthless for all purposes. It has not been thoroughly investigated. An analysis (No. 19) given above shows it to contain over 5 per cent. of silicon.—Sulphur is present in many ores of iron and in almost all mineral coals. The hotter the furnace and the more basic the cinder, the more sulphur will be removed in the cinder. Where the opposite conditions exist a large part of the sulphur in the charge will be found in the pig iron. The influence it exerts on pig iron has not been determined with precision. According to Egertz, 0.4 per cent. of sulphur renders pig iron stronger and more mottled. Swedish cannon iron contains from 0.07 to 0.1 per cent. of sulphur. It is the general impression among iron founders that sulphur renders pig iron harder, whiter, and more infusible; but experimental proof is wanting on this point. Phosphorus is almost always present in cast iron. Few iron ores or limestones are absolutely free from phosphorus; and almost the entire amount of this element present in the charge is absorbed by the iron, which it renders thinly liquid when fused, and crystalline and hard when solid. Such iron is well adapted to form ornamental and intricate castings, since it fills the mould well and brings out the fine outlines with sharpness. Less than 0.5 per cent. of phosphorus does not materially affect the physical properties of pig iron; and more than 0.5 per cent. renders it too weak and brittle to be used. The following table shows the amount of sulphur and phosphorus in some well known brands of English pig:

BRANDS.	Phosphorus, per cent.	Sulphur, per cent.
Whitehaven (hematite).....	0.144	
South Wales.....	0.473	
South Staffordshire.....	0.420	
Yorkshire.....	0.240	
Scotland.....	0.720	
Derbyshire.....	0.520	
North Staffordshire.....	1.070	
Northamptonshire.....	1.143	
Cleveland.....	1.220	

In the conversion of pig into wrought iron by puddling, the phosphorus and sulphur are to a considerable extent eliminated. In the conversion into Bessemer steel, however, these elements remain with the iron, and therefore only the purest pig irons can be used in this process. The maximum amount of phosphorus (the most deleterious element) that Bessemer pig iron may contain is 0.1 per cent.—Manganese resembles iron in many of its chemical

properties, and generally accompanies it in its ores. The amount in spathic iron ores is often large, in other ores usually small. Manganese is reduced from its oxide with much more difficulty than iron. When the manganese forms an integral part of the iron ore, it is reduced to a large extent together with the iron; but when the oxide as such is present in the charge, it passes mainly into the slag, unreduced. The effect of manganese on cast iron is peculiar. Specular iron, generally known by its German name *Spiegeleisen*, made from spathic ores rich in manganese, contains from 4 to 12 (exceptionally as high as 20) per cent. of the latter metal, and also nearly 5 per cent. of carbon, all chemically combined, and but a fraction of 1 per cent. of silicon. On its freshly fractured surface it is white and resplendent, with large crystalline faces. It is very hard. Gray pig iron may contain as much as 6 per cent. of manganese without showing any tendency to whiteness; the effect of manganese may here be counteracted by the silicon. Pig iron containing manganese is preëminently adapted for conversion into wrought iron and steel. The part that manganese plays in these processes is not well understood. It replaces silicon as a heat producer in pig iron employed in the Bessemer process. *Spiegeleisen* is generally very pure, and is almost exclusively used in steel-making. The effect of the other substances mentioned above on the physical properties of pig iron is not known definitely. II. WROUGHT IRON. By far the largest amount of wrought iron in the arts is made from pig iron by the removal of the carbon, silicon, &c., through oxidation in a reverberatory furnace. (See IRON MANUFACTURE.) The iron is removed from the furnace in the form of a white-hot ball or bloom, composed of small particles of soft iron, intimately mingled with cinder. The cinder is expelled and the particles of iron are united by squeezing, hammering, or rolling. Slabs of iron thus made are welded by exposing them to a white heat and rolling them out together. The homogeneity of the product depends on the thoroughness of the working, and this in turn on the temperature and the fusibility of the cinder. The fibrous character of wrought iron is due to the elongation of the granules or crystals of iron by rolling with intermingled cinder. Fibre, however, is not a condition inherent in iron, nor is it necessarily characteristic of good or strong iron, as is often supposed. Iron from which the cinder has been removed by thorough working, or by fusion, exhibits the granular crystalline fracture proper to the metal itself; and such iron is, other things being equal, stronger than that showing well developed fibre. But fibrous structure is evidence of good quality in iron, in so far as it shows the absence of substances (notably phosphorus) which tend to make it crystalline and brittle. It is to be observed that all iron, even the most fibrous, shows a crystalline character when broken short off; and that some

varieties of crystalline iron may appear fibrous when bent and broken slowly. The specific gravity of wrought iron differs according to treatment. The following determinations are by Kirkaldy: rolled, 7.7626 to 7.2898; hammered, 7.8067 to 7.7206; angle iron, 7.7810 to 7.5297; sheet iron, 7.7419 to 7.5381. The physical properties of wrought iron are intimately connected with its chemical composition. Carbon is almost always present in minute quantity; without it, iron is liable to take up oxide of iron and become rotten or "burnt." In the analysis of wrought iron it is often difficult to determine whether a substance is present in the iron itself or in the cinder. This is especially the case with silicon. The amount of silicon in wrought iron is never large (disregarding cinder), as it is the element most readily removed by oxidation in the operation of puddling. It is supposed to render the iron weak and brittle. Sulphur and phosphorus are frequently met with in wrought iron, and their effects have been tolerably well determined. Sulphur makes iron "red short" or "hot short," that is, brittle at a red heat. Phosphorus, on the contrary, makes iron "cold short," that is, brittle when cold. A red short iron can be worked cold, and a cold short iron hot. According to Eggertz, iron with 0.04 per cent. of sulphur can still be punched hot. More than this amount renders iron perceptibly red short. The effect of phosphorus on wrought iron differs according to the treatment it has received. Its tendency, even in proportions as low as 0.1 per cent., is to make iron coarsely crystalline in texture; this tendency is increased by prolonged heating. The strength and extensibility are thereby decreased and the hardness increased. If however the phosphorus is in not too large quantity and the iron is drawn out to such an extent that on slow fracture it exhibits a fibrous structure, the metal becomes both strong and tenacious. The presence of cinder facilitates the formation of fibre; and iron with an abundance of cinder (2 to 3 per cent.) has been found by Knut Styffe to be tenacious with 0.25 to 0.35 per cent. of phosphorus. He considers that phosphorus, like carbon, raises the elasticity and strength within the crystalline particles of the iron (whence results its superior hardness), but that it does not increase the cohesion between the separate crystals. The general impression among iron workers is that phosphorus and sulphur neutralize each other in iron, so that a "neutral" iron can be made from a mixture of cold and hot short irons. Whether the effect produced by such a mixture is one of neutralization, strictly speaking, or merely of dilution, remains to be determined. Little is known of the effect of other elementary substances on wrought iron. Manganese, if present in pig iron, is almost entirely removed on conversion into wrought iron. Chromium, titanium, tungsten, manganese, and other substances are sometimes added to

steel in the process of manufacture, and appear to modify its properties materially.—Prof. Graham ("Chemical Journal," vol. v., 1867), in his investigations on the occlusion of gases in metals, found that wrought iron contained many times its own bulk of gas, notably carbonic oxide. Mr. John Parry, of the Ebbw Vale iron works, Wales, has studied the subject more closely, and found that all iron contains occluded gas. In his experiments the amount of gas evolved was not determined, but its composition is as follows:

KINDS.	Carb. oxide.	Carb. acid.	Hydrogen.	Nitrogen.
Pig iron:				
Spiegeleisen.....	17.570	0.942	81.105	.....
White iron.....	2.820	6.800	54.000	6.650
Gray iron.....	5.200	1.600	89.700	8.250
Wrought iron.....	84.262	9.920	54.100	1.718
Soft steel.....	24.352	16.350	52.610	6.483

The amount of hydrogen that gray pig iron is capable of absorbing when heated in an atmosphere of this gas has been found by Parry to be 20 times its volume. By increasing the heat the gas thus absorbed is given off. Of the effect of gases on the physical properties of iron nothing is known, and the part they play in the various manufacturing processes is only beginning to be investigated. (See IRON MANUFACTURE.)—Compounds of iron with potassium, aluminum, manganese, nickel, lead, antimony, tin, and copper are known; but none of them have found important application in the arts, except ferro-manganese, which is often used instead of spiegeleisen in the Bessemer and Martin processes. It contains sometimes over 40 per cent of manganese, with a very small amount of carbon, is acknowledged to give better results than spiegeleisen, and would supersede the latter but for its cost.—*Strength of Iron.* The strength of cast and wrought iron varies through wide limits. Cast iron is inferior to wrought iron in strength when exposed to tensile, torsional, or transverse strain, but shows a very high resistance to compression. Owing to its rigidity, it stretches but slightly under stress, while wrought iron elongates considerably. In estimating tensile strength, therefore, regard must be had to the fractured as well as to the original area. The softest and purest irons elongate most, and consequently show a low tensile strength when referred to the original area, but a high degree of resistance when referred to the fractured section. A gradual increase in the amount of extension under strain is noticed from cast iron through steel to the softest wrought iron. The following tables, compiled from the experimental results of Hodgkinson, Fairbairn, Kirkaldy, Thalén, Rodman, and others, show the limits of strength of cast and wrought iron and steel under different conditions and treatment. (Steel is included here to facilitate comparison. For more detailed information with regard to this substance, see STEEL.)

Tensile and compressive Strength of various descriptions of English Cast Iron. (Hodgkinson.)

KINDS.	Tensile strength per sq. in.		Crushing weight in tons per sq. in.	
	Lbs.	Tons.	½ in.	¾ in.
Lowmoor, No. 1.....	12,694 = 5.667		29,549	35,191
" " 2.....	15,456 = 6.901		44,490	41,219
Clyde, No. 1.....	16,125 = 7.193		61,459	59,616
" " 2.....	17,807 = 7.949		69,108	45,549
" " 3.....	22,468 = 10.477		67,855	66,221
Blaenavon, No. 1.....	13,933 = 6.222		40,542	35,944
" " 2.....	16,734 = 7.468		52,502	45,717
Brymbo, No. 1.....	14,438 = 6.440		38,369	33,754
" " 3.....	15,508 = 6.928		38,946	34,834
Yniseedwyr, No. 1.....	13,922 = 6.220		37,261	35,115
Anthracite, No. 2.....	13,949 = 6.229		34,430	33,646

The tensile strength of Austrian gun iron is from 30,000 to 38,000 lbs.; of Russian, about 27,000 lbs.; and of Swedish, about 34,000 lbs. Experiments made by Capt. Rodman of the United States ordnance corps, with Greenwood, Springfield, and Salisbury pig irons (charcoal), and mixtures of the same, showed in 16 determinations a minimum specific gravity of 7.099 and a maximum of 7.307; a minimum tensile strength of 22,179 lbs. and a maximum of 42,884 lbs. to the square inch. The following determinations of the strength of Richmond (Mass.) charcoal pig were made at the South Boston foundry. This iron is smelted from pure red hematite, with temperature of blast varying from 100° to 350° F., and is largely used for ordnance:

	Specific gravity.			Tensile strength, in lbs. per sq. in.		
	A	B	C	A	B	C
No. 1.	7.0820	7.0568	7.0909	14,379	16,088	13,813
" 2.	7.1220	7.1252	7.0797	16,286	19,781	14,671
" 3.	7.1890	7.1796	7.1750	16,264	20,119	13,987
" 4.	7.2549	7.2633	7.2125	25,188	23,606	24,720

Remelting in a reverberatory furnace raised the average specific gravity of this iron to 7.3185, and the average tensile strength to 40,022 lbs. per square inch. Fairbairn has determined the transverse strength of cast iron rectangular bars from nearly all the British iron works. In 51 experiments on all shades of gray pig iron, the minimum breaking weight for bars 4 ft. 6 in. between supports was 357 lbs. to the square inch, corresponding to a specific gravity of 6.916, and the maximum 581 lbs., corresponding to a specific gravity of 7.122. Irons intermediate in strength, however, often show a higher specific gravity. From experiments made by Fairbairn to determine the effect of hot blast on the strength of pig iron, he concluded that No. 1 irons had been deteriorated, No. 2 slightly injured by it, and No. 3 improved by the use of hot blast. According to experiments on the resistance to torsion in cast iron, the length of the bar submitted to torsion being about eight diameters, the ultimate strength of seven samples varied from 6,176 to 10,467 lbs. to the square

The force requisite to give the bar a permanent set of half a degree is about nine of that which will break it. The following table shows the effect of successive annealings on the strength of cast iron, from annealings by Fairbairn; the iron used glinton No. 3, hot blast:

OF INCH.	Sp. gravity.	Mean breaking w'ght in lbs. per sq. in. for bars 4 ft. 6 in. be- tween supports.	Resistance to compression for cubes 1 in. square.
		Lbs.	Tons.
.....	6.969	480.0	44.0
.....	6.970	441.9	48.6
.....	6.886	401.6	41.1
.....	6.885	418.4	40.7
.....	6.842	481.6	41.1
.....	6.771	485.7	41.1
.....	6.879	449.1	40.9
.....	7.025	491.8	41.1
.....	7.102	546.8	55.1
.....	7.108	546.9	57.7
.....	7.118	651.9	69.8 mean.
.....	7.160	692.1	.....
.....	7.184	684.8	78.1
.....	7.580	636.4	66.0
.....	7.248	871.1	95.9
.....	7.890	851.8	76.7
.....	lost.	.....	76.5
.....	7.885	812.7	88.0

g per se cannot have any effect on the physical properties of iron, and any change in it on melting must be referred to a change in chemical composition, leaving out of consideration accidental imperfections of cast-iron. Melting may be effected in three ways: in a cupola or shaft furnace, or in a reverberatory or air furnace. In a crucible, exclusion of air, the iron should be used; in a cupola the atmosphere is reduced, and an increase of carbon or silicon may be effected; while in the oxidizing atmosphere of a furnace the silicon and carbon are gradually removed. The following tables give the results of wrought iron of various manufacturing-composition, &c., under varying strains; added for comparison:

Tensile Strength of Iron Bars. (Kirkaldy.)

KINDS.	Breaking weight per sq. in. in pounds.		Difference between ori- ginal and fractured area, per ct.
	Original area.	Fractured area.	
Swedish (charcoal).....	47,584	160,520	70.5
Staffordshire ".....	58,086	150,984	61.6
Yorkshire "Lowmoor".....	65,166	140,920	58.7
Staffordshire B. B. scrap.....	59,570	125,180	52.4
Scotch extra best best.....	59,726	102,118	41.5
" best best.....	66,863	97,721	32.1
" common.....	59,272	82,818	28.4
Russian C. C. N. D.....	56,447	69,888	10.2

Tensile Strength of Iron Plates. (Kirkaldy.)

KINDS.	Breaking weight per sq. inch, lengthwise.		Difference of ori- ginal and fract'd area, per cent.	Breaking weight per sq. inch, crosswise.		Difference of ori- ginal and fract'd area, per cent.
	Orig. area.	Fract'd area.		Orig. area.	Fract'd area.	
	Yorkshire.....	58,686		92,468	36.5	
Staffordshire, Brad- ley.....	60,697	70,968	15.7	51,025	55,490	8.0
Scotch best boiler.....	55,176	63,180	12.7	48,000	51,291	6.4
Staffordshire best best.....	48,828	58,781	9.1	46,948	49,656	5.4
Scotch ship.....	47,780	50,085	4.6	44,366	45,321	2.5
" common.....	43,831	46,439	5.6	42,738	43,460	1.6

Average Results obtained by Rupture of 64 square Bars of puddled Steel and Iron from Surahammar, Sweden; temperature 60° F. (From Knut Styffe's "Iron and Steel.")

KINDS.	No. of bars.	Elongation per cent. rupture.	Breaking weight per sq. in. on the original mean area.		Breaking weight per sq. in. on the section of rupture.
			Lbs.	Tons.	
Hard puddled steel.....	18	6.20	89,189	80.61	122,240
Middling hard puddled steel.....	18	6.99	80,686	85.69	118,670
Soft puddled steel.....	14	10.48	70,878	81.61	112,088
Puddled iron.....	14	20.26	48,819	21.65	190,770

The elongation given in this table is very low, owing to the fact that the experimenter, Herr Thalén, did not measure the elongation in that foot of length in which the fracture took place, but in the other 4 ft. of the length of the bar.

Results of Experiments on the Tensile Strength of Bessemer Steel and Cast Steel at 60° F. (From Knut Styffe's "Iron and Steel.")

KINDS.	Amount of carbon per cent.	Amount of phos- phorus per cent.	BREAKING W'GHT.		Elongation by rupture.	Load per sq. in. at the limit of elasticity, lbs.
			Original area, lbs.	Fractured area, lbs.		
Bessemer steel from Högbo.....	1.10	0.018	127,564	316,158	2.9	85,481
Bessemer steel from Carlsdal.....	0.84	0.028	64,709	141,219	16.7	84,990
Cast steel from Wikmanshyttan (Uchatius steel).....	1.16	0.011	189,847	159,610	4.6	71,707
Cast steel from Krupp.....	0.61	0.080	82,549	172,804	5.5	55,926

Results of Experiments on the Tensile Strength of Iron at 60° F. (From Knut Styffe's "Iron and Steel.")

KINDS.	Amount of carbon per cent.	Amount of phosphorus per cent.	BREAKING WEIGHT PER SQUARE INCH.		Elongation by rupture per cent.	Load per sq. inch at the limit of elasticity, lbs.
			On original area, lbs.	On fractured area, lbs.		
Puddled iron from Lowmoor.....	0.21	0.069	56,944	180,588	20.5	84,025
" " from Cleveland.....	0.07	0.295	72,591	109,738	18.7	.....
" " from Dudley.....	0.09	0.846	47,558	62,082	7.4	28,668
" " from Motala works, Sweden.....	0.20	0.020	52,681	100,665	17.8	29,506
Iron made in charcoal hearth, Sweden.....	0.18	0.264	68,478	76,864	8.2	40,485
" " in Lancashire hearth, Sweden.....	0.07	0.022	45,014	192,758	22.0	24,860

Results of Experiments on the effect of Hardening on the Extensibility and Strength of Iron and Steel.  
(From Knut Styffe's "Iron and Steel.")

KINDS.	Treatment of bar before experiment.	Amount of carbon per cent.	Breaking weight per sq. inch, original area, lbs.	Ratio bet'n area of fracture and orig. warm area.
Bessemer steel from Ilgbo.	Heated to redness and hardened in water.	0.28	79,573	0.42
	Heated to redness and slowly cooled in warm coal dust.	0.28	51,239	0.27
Uchatius steel from Wikmanshyttan.	Strongly heated and hardened in oil.	1.22	101,231	1.50
	Heated to redness and slowly cooled in warm coal dust.	1.22	54,614	0.59
Puddled iron from Surahammar.	Heated to redness and hardened in water.	0.20	65,757	0.79
	Heated to redness and slowly cooled in hot coal dust.	0.20	44,780	0.26
Iron made in charcoal hearth from Lesjöfors.	Heated to redness and hardened in water.	0.08	62,551	0.28
	Heated to redness and slowly cooled in hot coal dust.	0.08	44,577	0.23

Results of Experiments on the Strength of Iron rolled cold. (Fairbairn.)

CONDITION OF BAR.	Br'king weight, per sq. in., tons.	Strength (untouched=1.000).
Untouched (black).....	26.178	1.000
Rolled, cold.....	39.883	1.500
Turned.....	27.119	1.036

The resistance of cold rolled iron to tension, compression, and transverse strain, and also its hardness, are increased in nearly the same ratio as its breaking weight. The following table exhibits the results of experiments to determine the strength of the iron from two exploded boilers, compared with other brands of American iron and English Lowmoor boiler plate:

KINDS.	Average breaking weight per sq. in., lbs.	Highest.	Lowest.	Ratio to the former per cent.
Exploded boiler, steamer Westfield, 38 experiments.....	41,658	50,182	29,012	42
Ilgbo boiler plate, 16 experiments.....	54,123	57,019	51,513	9.1
American flange iron, 15 experiments.....	42,144	53,277	.....	.....
Tank iron, 6 experiments, 3 makers.....	48,831	58,174	34,111	32
	42,011	45,525	35,079	29
	41,349	52,277	33,008	31
Exploded boiler, steamer Red Jacket, 2 experiments.....	49,000	56,000	42,000	25
English best Lowmoor boiler plate, 5 experiments.....	58,954	64,000	53,900	14

The great variation in strength in the iron from the exploded boilers was supposed to be due to the wrenching and twisting accompanying the explosion. From the foregoing tables it will be seen that the physical properties of iron, strength, elasticity, &c., vary according to composition and treatment. The following are some of the conclusions of Knut Styffe ("The Elasticity, Extensibility, and Tensile Strength of Iron and Steel," translated by C. P. Sandberg, London, 1869): "The limit of elasticity, the absolute strength, and the extensibility are to a great extent dependent, in both iron and steel, on the mechanical treatment to which the material has been submitted, and on the temperature to which it has been exposed, either during working or subsequently. By cold-hammering, cold-rolling, and other forms of mechanical treatment applied at a low temperature, both the limit of elasticity and the absolute strength are increased; while by the same treatment the extensibility is diminished. In these respects heating produces an opposite effect. When the proportion of carbon in iron or steel is increased, while the other conditions remain the same, the limit of elasticity, as well as the absolute strength, is to a certain extent increased; but the extensibility, on the contrary, is diminished. The absolute strength, which in good soft iron may be estimated in round numbers at 48,034 lbs. or 21.44 tons per square inch, seems to attain its maximum in steel containing about 1.2 per cent. of carbon, and is then in good cast steel or Bessemer steel about

137,240 lbs. or 61.26 tons per square inch. A small proportion of phosphorus in iron generally raises the limit of elasticity and the absolute strength, and therefore also the hardness of the metal; but at the same time it diminishes its extensibility, provided that the iron during its manufacture has been so much drawn out that on slow rupture it exhibits a fibrous fracture. By admixture, however, of slag (which always makes the iron unsound and difficult to be re-formed when heated, but which facilitates the development of a fibrous structure), an iron containing 0.25 per cent. of phosphorus seems capable of acquiring nearly the same extensibility as an iron which contains only traces of phosphorus. The presence of slag also seems to oppose the tendency of the iron to become when strongly heated crystalline, and therefore cold-short. By heating and sudden cooling (hardening), the limit of elasticity is raised, while the extensibility is diminished, not only in steel, but also in iron. The absolute strength likewise is increased by hardening, if this be performed in a manner adapted to the quality of the material. Hardening in water without subsequent moderate heating (tempering) generally diminishes the strength of hard steel to a very considerable extent; while hardening in oil does not occasion this inconvenience, provided the heat previous to hardening has not been too high." Styffe likewise gives the result of an elaborate series of experiments on the strength of iron and steel at different temperatures from -40° F.



to 418° F., from which he deduces the following conclusions: "The absolute strength of iron and steel is not diminished by cold, but even at the lowest temperature which ever occurs in Sweden, it is at least as great as at the ordinary temperature (about 60° F.). At temperatures between 212° and 392° F., the absolute strength of steel is nearly the same as at the ordinary temperature; but in soft iron it is always greater. In neither steel nor iron is the extensibility less in severe cold than at the ordinary temperature; but from 266° to 320° F. it is generally diminished, not to any great extent in steel, indeed, but considerably in iron. The limit of elasticity in both steel and iron lies higher in severe cold; but at about 284° F. it is lower, at least in iron, than at the ordinary temperature." In the experiments on which these conclusions are based, the strength was determined by a gradually increasing strain. The result is quite different if the strain is applied suddenly, that is, if the iron or steel is submitted to shock, as is shown in the following experiments made by C. P. Sandberg (appendix to the work of Knut Styffe):

*Height of Fall of Ball (weighing 9 out.) required to break each Rail (Iron) at different temperatures. Distance between supports 4 ft.; length of rail 10 ft. 5 in.*

WORKS WHERE RAILS WERE MADE	TEMPERATURE.		
	84° F., R.	35° F., R.	10° F., R.
Aberdare, Wales .....	45	26	..
" " .....	56	26	..
" " .....	85.5	11	..
" " .....	45.8	5	..
" " .....	56	..	13
" " .....	56	..	5
" " .....	85	..	5
Le Creusot, France .....	45	..	26
" " .....	35	..	11
" " .....	85	..	13
" " .....	45	..	11
" " .....	85	..	5
Dorlodot's, Belgium .....	22	..	4
" " .....	30	..	4
Average of 7 English rails .....	49.6	..	9.8
" 5 French .....	89	..	14.2
" 2 Belgian .....	26	..	6.5
and 2 English, 5 French, and 2 Belgian rails .....	89	..	11

Mr. Sandberg concludes from these experiments that for such iron as is usually employed for rails in Wales, France, and Belgium, the breaking strain, as tested by sudden blows or shocks, is considerably influenced by cold; such iron exhibiting at 10° F. only from one third to one fourth of the strength which it possesses at 80°. The ductility and flexibility of such iron he finds also much affected by cold; rails broken at 10° showing on an average a permanent deflection of less than one inch, while the other halves of the same rails, broken at 84°, showed a set of more than four inches before fracture. He says that at summer heat the strength of Aberdare rails was 20 per cent. greater than that of Creusot rails; but that in winter the latter were 30 per cent. stronger than the former. The confusion in the statements regarding the strength of iron and steel

at different temperatures has arisen from the fact that in the experimental determinations the difference between the effect of a gradually increased, and a suddenly applied strain has been overlooked. The experiments of Mr. Sandberg are conclusive on this point, and confirm the universal experience that iron and steel tools and utensils are much more liable to break in cold than in warm weather. The breaking of rails in winter has also been referred to the hardness and rigidity of the road bed; no experiments have yet been made that confirm this view.—A very thorough investigation of the strength of wrought iron at different temperatures was made by a committee of the Franklin institute of the state of Pennsylvania, consisting of Prof. W. R. Johnson, Prof. A. D. Bache, and Benjamin Reeves, from 1882 to 1887. These experiments were 73 in number, at temperatures from 212° to 1317° F. A remarkable anomaly was discovered in the behavior of iron at a temperature between 500° and 600°. About 572° was found to be the temperature of the maximum strength of iron; and the best qualities then showed a tenacity 15.17 per cent. over that possessed by the same iron at ordinary temperatures. Sir William Fairbairn made a similar observation on South Staffordshire iron. It showed from 60° to 325° a regular increase of tenacity from 62,186 lbs. to 84,046 lbs. per square inch, or 30 per cent. Mr. Clay has determined the effect of repeated workings on the tensile strength of wrought iron as follows:

	Lbs. per sq. in.		Lbs. per sq. in.
1. Puddled iron.....	43,904	7. Reheated .....	59,585
2. Reheated .....	52,864	8. " .....	57,344
3. " .....	59,585	9. " .....	57,344
4. " .....	59,585	10. " .....	54,104
5. " .....	57,344	11. " .....	51,968
6. " .....	61,224	12. " .....	43,904

The increase of strength is doubtless due to the increase of homogeneity, and the subsequent decrease to an oxidation of the iron.—A. Wöhler (*Ueber die Festigkeitsversuche von Eisen und Stahl*) has investigated the effect of repeated strains on iron and steel, and has shown that the rupture of a material may be effected by frequently applied strains, none of which exceed the limit of rupture; that the destruction of cohesion depends on the differences of tensions which form the limits of the oscillations of the strain; and that the absolute amount of the extreme tensions is only of importance in so far as the differences of strain which effect rupture decrease with the increasing tension. When a fibre passes from a state of tension to a state of compression, or *vice versa*, we should consider the tensional strain as positive, and the compressive strain as negative, so that the variation will be equal to the sum of the tensional and compressive strains. This condition, often called the "fatigue" of metals, is shown in the following table:

KINDS.	Ultimate breaking strain in lbs. per sq. inch.		Elongation per cent.	Strain applied in lbs. per sq. inch.		Difference in maximum and minimum.	No. of applications before fracture.
	Orig. area.	Fract'd area.		Maximum.	Minimum.		
Wrought iron, Phoenix company, 1857.....	47,080	66,126	17.8	51,860 38,520 47,080 47,080 55,800	0 0 21,400 23,680 0	51,860 38,520 25,680 21,400 55,800	680 450,532 2,572,484 4,036,000 not broken. 18,741
Cast-steel axle, Krupp, 1862.....	109,675	185,997	12.1	49,220 55,800 17,050 10,700	0 87,450 0 0	49,220 48,150 17,050 10,700	12,900,000 not broken. 12,000,000 not broken. 2,140 7,600,800 not broken.
Piece of cast-iron cylinder, Stettin.....	.....	.....	.....	.....	.....	.....	.....

The effect of vibration on fibrous iron, it has been generally supposed, is to make it crystalline. Experimental evidence is however lacking on this point. Iron subjected to vibratory shocks may become weak and break from "fatigue," or by reason of poor material or bad working; but there are no facts to prove that weakening is the result of a passage from the fibrous to the crystalline condition.—Prof. Robert H. Thurston has investigated the effect of unintermitted static stress on wrought iron and steel strained beyond the limit of elasticity, and has found that they do not lose their power of resistance or yield in the slightest degree. He has further determined that iron and steel, if strained beyond the limit of elasticity, and left under the action of the distorting force which has been found just capable of equilibrating their power of resistance, gain resisting power to a degree which has a limit in amount approximating closely, if not coinciding with, the ultimate resistance of the material, and which had a limit as to time in experiments hitherto made of three or four days. Releasing the piece entirely and again submitting it to the same force immediately does not produce this strengthening effect.—The production of iron and steel in the United States in 1872 was as follows, in tons of 2,000 lbs.:

Iron and steel rails.....	941,992
Other rolled and hammered iron.....	1,000,000
Forges and bloomeries.....	5,000
Cast steel.....	82,000
Bessemer steel.....	110,500
Martin steel.....	8,000
Pig iron.....	2,580,070

The following is the production of England, Prussia, and Sweden for 1871, and France for 1872:

COUNTRIES.	Pig iron.	Wrought iron.	Steel.
England.....	6,627,179	5,566,175	
Prussia.....	1,827,934	897,278	211,847
France.....	1,299,830	971,899	152,409
Sweden.....	292,550	183,959	84,568

**IRON.** I. A S. E. county of Missouri, drained by affluents of the St. Francois and Big Black rivers; area, about 500 sq. m.; pop. in 1870, 6,278, of whom 352 were colored. Iron mountain and Pilot Knob are on the N. E. border. The surface is hilly and mountainous. There are large forests of oak, hickory, pine, and cedar. Iron ore is abundant, and other metals

are found. The St. Louis and Iron Mountain railroad crosses the county. The chief productions in 1870 were 12,221 bushels of wheat, 90,385 of Indian corn, and 28,141 of oats. There were 690 horses, 919 milch cows, 1,708 other cattle, 8,178 sheep, and 4,714 swine; 5 manufactories of carriages, 1 of charcoal, 1 of pig iron, and 5 saw mills. Capital, Ironton. II. A S. county of Utah, extending from Colorado on the E. to Nevada on the W.; area, 9,200 sq. m.; pop. in 1870, 2,277. It is intersected in the E. by the Colorado river, and crossed in the W. by the Wasatch mountains. Iron ore is found in this range, and at its base is some land suitable for agriculture, but much of the county is unavailable. The chief productions in 1870 were 8,917 bushels of wheat, 2,857 of Indian corn, 21,276 of potatoes, 17,966 lbs. of wool, 21,855 of butter, and 736 tons of hay. There were 732 horses, 2,114 cattle, 4,548 sheep, and 3 saw mills. Capital, Parowan.

**IRON-CLAD SHIPS, or Armored Ships,** vessels covered or plated with iron for the purpose of rendering them impenetrable to the fire of artillery. The idea of strengthening the sides of ships so as to enable them to resist attack is nearly as old as the art of navigation itself. From the time of the Norman freebooters, who protected themselves by ranging their bucklers along the sides of their vessels, down to the battle between the Kearsarge and the Alabama in 1864, in which the sides of the former were protected by hanging chains over the bulwarks, and from the time of the Romans, who built their triremes with castellated prows, to the English, who have covered their frigates with plates of solid iron, all nations have sought by means more or less perfect to make their ships impenetrable, and to render them invincible in battle. The first attempts at making iron-clad vessels were made by the Normans in the 12th century, who put an armature or belt of iron around their vessels just above the water line; this belt terminated in front by a spur. In some instances this armature was converted into a curtain of iron or brass reaching above the bulwarks for the protection of the combatants. The crusaders of the 12th and 13th centuries protected their ships in a similar manner. Pedro of Aragon in 1354 ordered the sides of his ships to be covered with leather or raw hide to protect them against incendiary compounds. Andrea Doria, who commanded in the expedition

mis in 1535, had one vessel plated in his fleet, furnished by the knights of Jerusalem; and at the battle of 1571 many of the Genoese ships strengthened by blindages or bulwarks of heavy beams, old sails, cordage, 782 the chevalier d'Arçon, on the of M. de Verdun, at the unsuccessful Gibraltar, constructed and used 10 batteries having their tops bomb-proof, les protected by parapets 6 ft. thick, of hard wood reinforced by cork her, and bars of iron. These floats carried 214 guns of large calibre, 72 were reserves, and for several lose range withstood the heavy fire y concentrated upon them. They ally only to red-hot shot, and all ere burnt or blown up. In 1814, end of the war with England and access of the first steamboats, Robert posed to construct a floating battery ited States government, capable of ve or six miles per hour, and having f against the heaviest artillery. The aking the blockade of the Hudson peake caused this proposition to be ith enthusiasm. The vessel was be-



Fig. 1.—Demologos (elevation).

ne and launched in October of the ; but owing to delays in completing ury, she was not ready for service 1815, after the declaration of peace. ry, called the Demologos, was 150 ft. was composed of two hulls coupled ut separated by an open space 13 ft. e wheel was placed between the two e battery and machinery were pro- wooden wall about 6 ft. thick and 3 ft. below the water line. The ar- onisted of 30 32-pdr. guns. The

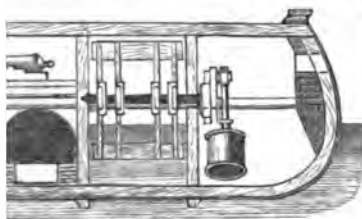

Fig. 2.—Demologos (section).

he vessel reached nearly six knots Her name was changed to the Ful- he death of that distinguished engi- is vessel seems to have been far ahead

of her time, and, although never used in warfare, was doubtless superior to anything of the kind ever built up to that day. She was destroyed by the explosion of her magazine in 1829. In 1838 the Fulton II. was constructed, but with improved engines and greater speed. She was a true side-wheel steamer, and her wooden walls are said to have been covered with a thin plating of iron.—In 1826 an anonymous writer in Paris proposed the construction of iron or iron-clad frigates, the walls of which should have a thickness sufficient to resist cannon shot, asserting that when the enemy should have adapted the Paixhans system of horizontal shell firing wooden ships would no longer serve for the purposes of war. This was a correct idea, but only an idea at that time; and it is nearly impossible to find the real inventor of iron-plated ships, or ironclads, as they are now commonly called. The idea was public property and the natural outgrowth of the improvements made in artillery; the inventors were those of all nations who gave the idea form and feasibility. The remarkable results obtained by the employment of Paixhans's system of artillery called the attention of all nations to the means of defending both ships and land batteries from the destructive effect of horizontal shell firing. Some experiments were made in 1834 at Metz and Gavres for the purpose of determining the power of different materials to resist penetration, in consequence of which Gen. Paixhans recommended that the French vessels of war should be strengthened by plating them with iron; but this was rejected by the board of naval construction in 1841. In 1835 Mr. John Podd Drake proposed to the English naval department the protection of the machinery of steam men-of-war by iron plating  $4\frac{1}{2}$  in. thick, and in 1841 he promulgated the idea of iron-clad blockading ships.—In 1842 Robert L. Stevens of Hoboken, N. J., proposed to the United States government the construction of iron-clad steam batteries for the purpose of defending the commercial ports from the chances of bombardment by hostile fleets. After recognizing the importance of this idea, the government decided to make a series of experiments with the view of determining the best arrangement for the walls of such batteries. These experiments demonstrated that an iron wall  $4\frac{1}{2}$  in. thick was sufficient to resist the largest projectiles then in use. The construction of one battery was decided upon, but it was not commenced till 1854. From the best information which can be obtained, her length over all is 420 ft., her breadth 52 ft., depth from fighting deck 28 ft., draught of water with coal and stores on board 20 ft. 6 in., fighting draught 22 ft. 6 in. The vessel is an iron screw steamer, secured by longitudinal bulkheads, by a heavy box keelson running from stem to stern, and by shot-proof decks and continuous side armor. She has two screw propellers working independently, each being

driven by four compact beam engines working entirely below the water line. Cylinders are 3 ft. 9 in., with 3 ft. 6 in. stroke, driven by 10 boilers and capable of developing 8,600 horse power. The leading principles of this vessel's construction are as follows: 1. When ready for action the ship is to be settled 2 ft. lower in the water, by letting water into compartments which can again be emptied rapidly by powerful steam pumps provided for that purpose; this is done in order to save the weight and cost of the additional armor which would otherwise be necessary; to allow a flatter slope and secure greater resistance of the armor; to employ the resistance of the water; to give the vessel a greater speed by expelling the water from her compartments, and to enable her when thus lightened to enter harbors into which she could otherwise not go. 2. The use of inclined instead of vertical plating, for the purpose of changing the direction and throwing off instead of stopping the enemy's projectiles. The side plating consists of the best iron slabs  $3\frac{1}{2}$  in. thick, laid upon a triangular backing of locust timber extending outside the shell of the vessel from stem to stern, and to a depth of 4 ft. below the water line when the vessel is ready for action. From the outer edge of this side protection the shot-proof casemate or main armor proceeds, upward and inward, at an angle of one vertical to two horizontal, to a height of 28 ft. from the bottom of the ship, and  $5\frac{1}{2}$  ft. from the fighting line, where it is covered by a flat shot-proof deck. The main armor extends only over the engine's boilers, blowing and pumping machinery, that is, 107 ft. forward and 74 ft. aft the centre. Its ends slope upward and inward at a similar angle, from the 21-foot deck, which is shot-proof, and which extends forward and aft the armor to the extreme bow and stern. The inclined armor, or casemate, is composed of  $6\frac{1}{2}$  in. of iron plates, backed by 14 in. of locust timber, in which are imbedded six-inch wrought-iron girders 2 ft. apart. The whole is lined with half-inch plate iron. It is supported by the engine frames, by heavy braces and girders between the boilers, and by the frames and sides of the ship. The horizontal shot-proof decks are composed of  $1\frac{1}{2}$  in. of iron plates, resting on six-inch wrought-iron girders, filled with locust timber and backed with half-inch iron plate. The guns will be loaded by being pivoted to a hole in the deck protected by a shot-proof hood, below which is a steam cylinder of which the piston rod is the ramrod of the gun. All the machinery and men for working the guns are thus within the shot-proof armor. The guns are protected by a covering of wrought-iron armor in addition to their own immense thickness, and will be trained by steam power. The shot-proof deck fore and aft the central casemate affords ample accommodation for men and officers. Above this deck, and flush with the 28-foot gun deck, which forms the top of the casemate, is a light deck, extending at the sides of the casemate, and forward and aft from stem to stern. The entire 28-foot or gun deck is thus level (excepting the usual camber), and unencumbered over the whole vessel. Only the part of it that forms the top of the casemate is shot-proof. Above the 28-foot deck are flying bulwarks to be turned down in time of action. The height of the bulwarks from the water at the load line will be  $13\frac{1}{2}$  ft. The 14-foot deck affords ample space for stores, and for the salt-water tanks designed for settling the vessel to the fighting line. Below the 14-foot deck, forward of the boilers, are the blowers and pumping engines and coal bunkers. Aft the engines are coal bunkers also. Capacity for coal, 1,000 tons. The vessel will have two light masts for emergencies, but will not ordinarily carry sails. Her projector claimed that her iron casemate,  $6\frac{1}{2}$  in. thick backed by 14 in. of hard timber, and standing at the acute angle of one base to two perpendicular, is a stronger protection than has ever been applied, and that at the same time it is comparatively light, as its extent is reduced by confining it to the central part of the vessel, and by immersing the vessel to a deeper fighting draught. The parts of the vessel fore and aft the central casemate are also thoroughly protected by a horizontal deck, which is not only shot-proof but one foot below the fighting water line. The water protection, as far as it can be judiciously employed, is at once the most perfect and cheapest armor. 3. The side protection, extending from stem to stern, is intended to answer these four important purposes: 1, protection from projectiles; 2, from disaster by collision; 3, increasing the immersed beam, and the consequent stability of the ship when fighting; 4, adding in a very great degree to the horizontal and vertical strength and stiffness of the vessel. 4. The immense power of the engines and the fine lines are intended to give a much higher speed than has been attained by any sea-going war or commercial steamer. The sharpness of her lines is unprecedented in any government practice, and in any except the latest and most successful commercial practice. 5. The ability of the vessel to turn rapidly round on her own centre, without making headway, by means of two screws, instead of occupying the time and making the circuit required by all other war vessels, it is thought, will give her remarkable and important facilities for manœuvring when in action. 6. The employment of barbette guns, or on the top of the casemate instead of within it, gives the free range of the entire horizon. Three guns can be fired at a time in line with the keel, forward or aft. 7. As there is no casemate over the guns, the enemy cannot pour shot and shell into port holes at close quarters; for the same reason the guns will not be limited to the few degrees of range permitted by the ports, but can sweep the horizon. The cost and weight of the casemates over the guns

re dispensed with, and the seven guns thus arranged will be as formidable as a whole broadside arranged in the ordinary way. This vessel was still incomplete when it was announced to be sold by auction on Oct. 2, 1874, by the state of New Jersey, to which it was bequeathed by Mr. E. A. Stevens.—The experiments of the American government to test the theories of Mr. Stevens were repeated by the English admiralty at Woolwich. A target was constructed of 14 thicknesses of sheet iron, or about 2½ in., riveted together and backed by 2 ft. of oak. It was fired at with 64- and 32-pdr. guns, at a distance of 375 yards; 32 projectiles were used, 8 of which broke the plating, but none of which succeeded in piercing the target. A new series of experiments was made in France in 1843 and 1844, at the request of the prince de Joinville; and in 1845 M. Dupuy de Lôme published a memoir urging the construction of iron-plated frigates, having thinner plating than it was generally thought experiment had shown to be necessary, but carrying fewer guns of heavier calibre. The experiments up to that time had not indicated clearly enough the manner of constructing the walls of ships, and as Dupuy de Lôme's memoir demanded still further experiments, the construction of ironclads was not yet undertaken. In 1846 the English admiralty made further experiments with 32-pdr. guns at 200 yards, against targets composed of iron plates riveted together. The results were thought to be unfavorable, and no further steps were taken at that time toward the employment of iron in the construction of ships of war. In 1847 M. Gervaise proposed a screw ship composed entirely of iron, and, basing his opinion on the experiments undertaken at Gavres in 1843-5, he asserted that the impenetrability of iron walls is as much greater than that of wood, as the penetrating power of solid shot is greater than that of shell, and that consequently the true machine for naval warfare is the iron ship. He also claimed the possibility of using such vessels as rams, owing to their superior swiftness and solidity. These ideas were also put aside for the time being, and further experiments were undertaken, without any notable results till active operations in the war of England and France against Russia had taken place in 1854. It was then found that the English and French war ships drew too much water to get within close range of the forts in the Baltic, and hence it became necessary to construct vessels of lighter draught and greater force. The emperor of the French authorized M. Guieyasse to make such further experiments as might be found necessary in deciding upon the plan. These were made at Vincennes, and resulted in a determination to lay the iron plates on an elastic backing of wood, and to have the plates rolled to the required thickness rather than composed of thin plates united together. The plans of Guieyasse were adopted, and five floating batteries, the Dé-

vastation, Tonnante, Lave, Foudroyante, and Congrève, were begun. They were 160 ft. long at the water line, 49 ft. wide, and 8 ft. draught. Their armament consisted of 16 50-pdr. guns under the cuirasse and 2 12-pdrs. on the forecastle; the plating was composed



FIG. 3.—The Dévastation.

of 4½ in. of iron backed by 8 in. of oak. The engines were of 225 horse power, with boilers designed to act under a pressure of 75 lbs. to the square inch. The first of these vessels was launched in March, 1855, and the rest soon after. At the same time that the order for these vessels was given the French minister of marine, M. Ducos, sent the plans to the English government; but Sir James Graham, the first lord of the admiralty, hesitated much before deciding to build any of this new class of ships. As a preliminary measure the experiments made at Vincennes were tested at Portsmouth in September, 1854, in the presence of Garnier and Guieyasse. The results were satisfactory, and on Oct. 3 the admiralty ordered the construction of five batteries of the new type. Although they were sea-going vessels, they were without claims as ships, being designed simply for strong floating batteries. The French vessels of this class were towed to the Baltic by the screw frigates. On Oct. 17 the Lave, Tonnante, and Dévastation attacked the fortress of Kinburn at close range, and, although they were hit many times, succeeded after five hours and a quarter in silencing the enemy's guns. The performances of these vessels left no doubt as to the utility or soundness of the idea on which they had been constructed, and at once attracted the attention of naval constructors throughout the world to the necessity not only of vessels of this class for harbor defence and attack, but also of having iron-clad cruisers and rams of high speed and fine sea-going qualities. The French themselves were the first to profit by their own experience, and at Toulon on March 4, 1858, under the orders of Napoleon III., began the construction of the Gloire, an iron-plated screw frigate of the first class. Her form does not essentially differ from that of the ordinary



FIG. 4.—The Gloire.

wooden frigates of the French navy, although, as she is also intended to act as a ram, her bows have a peculiar form specially designed for crushing the sides of her opponents. Her length over all is 250 ft., breadth of beam 55 ft.; her armament consists of 36 guns of 6.3 in. calibre. Her armor, which covers only her

sides amidships, consists of solid plates  $4\frac{1}{2}$  in. thick, backed by 2 ft. of timber. The completion of this ship marks an epoch of the greatest importance in naval warfare and architecture. From that day wooden ships gave way to a new class practically impenetrable to the projectiles of artillery, and endowed with speed and sea-going qualities equal to those of the vessels they were destined to replace. The science of ordnance and gunnery also received a new impulse, as guns of larger calibre and greater penetrating power became necessary. Every subsequent improvement in the construction of iron-clad ships has been followed if not preceded by a corresponding improvement in artillery, and in no branch of human industry have greater ingenuity or more persistent efforts been displayed.

Shortly after the *Gloire* was begun, the French laid the keels of the *Normandie* and the *Invincible* on the same plans, and the *Couronne* on the plans suggested by M. Audinet. The construction of these ships was looked upon by all maritime nations as betraying an intention on the part of Napoleon III. to make France the principal naval power of the world, and was regarded by the English as a direct challenge which could only be properly met by the construction of a fleet of still more formidable vessels. Accordingly the admiralty ordered the building of the *Warrior*, and shortly afterward of the *Black Prince*, *Defence*, and *Queen*. These vessels were the forerunners of a new fleet composed entirely of ironclads, built at an enormous cost, but making good her position as the first naval power of the world. The plating of the *Warrior*, like that of the *Gloire*, is only  $4\frac{1}{2}$  in. thick, and is applied amidships only. It is backed by 18 in. of teak, and is of uniform thickness, designed to resist 68-pdr. shot and shell. She is a long, handsome frigate, masted and rigged as usual, and sails faster than the *Gloire*, but owing to her greater length is not so handy at sea. The *Defence* and the *Resistance*, constructed upon the same plan, but smaller, soon followed. About the same time the French built the *Magenta* and the *Solferino*, admirable vessels, but as war ships in some respects less effective than the *Gloire*. The example of France and England was soon followed by the second-class naval powers. Austria undertook the construction of two frigates and Italy of two corvettes in 1860.—Up to this time all the efforts of constructors had been directed to the building of vessels after the old patterns, simply using iron

instead of wood, or in order to strengthen the wooden walls of old ships, without any essential modification of form or change of model. The outbreak of the civil war in the United States gave a great impulse to invention in this direc-

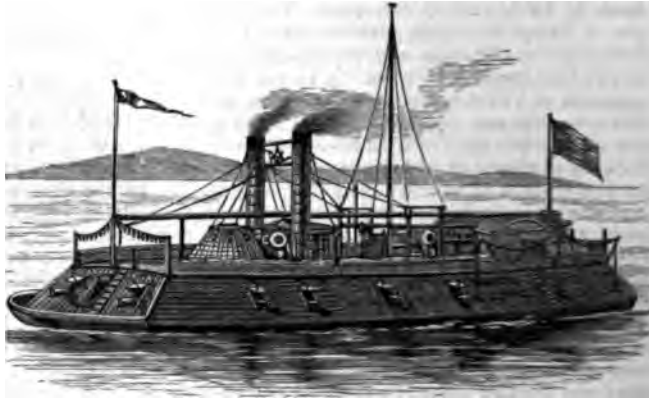

FIG. 5.—The St. Louis.

tion. The seizure of the important points on the Mississippi river below Cairo enabled the confederates to erect batteries and to stop navigation, and rendered it necessary for the Union fleets to be accompanied by ironclads. The first of these were constructed by James B. Eads, a civil engineer residing in St. Louis. He built the *St. Louis*, *Carondelet*, *Cairo*, *Mound City*, *Louisville*, *Cincinnati*, and *Pittsburgh* in 1861, and later the *Benton* upon the model known subsequently as the "turtle-back." They were plated with iron slabs  $2\frac{1}{2}$  in. thick and 11 in. wide, rabbeted together and laid on a 4-inch backing of oak inclined at an angle of about  $45^\circ$ , and each armed with 13 9- and 10-inch guns. These vessels were built under the orders of the war department, and were the first ironclads actually employed in warfare by the United States. While they were not impenetrable to the fire of heavy rifles, or even to the 8- and 10-inch columbiads used by the confederates, they did excellent service till the end of the war. Mr. Eads designed and constructed the *Osage* and the *Neosho* after the model of the *Monitor*, each having a turret carrying two 11-inch guns. The turret plating was 6 in. thick, the hull plating  $2\frac{1}{2}$  in., the deck plating 1 in., while the draught of water was only 4 ft. They were 145 ft. long and 65 ft. wide. He also designed the *Winnebago*, the *Milwaukee*, the *Chickasaw*, and the *Kiapoo*, each carrying two turrets, the sides of which were 8 in. thick, with hull plating 3 in. thick, and deck plating  $1\frac{1}{2}$  in. They were each 226 ft. long, 56 ft. wide, and drew only 6 ft. Each turret carried two 11-inch guns.—The confederates, shortly after the commencement of hostilities, seized the navy yard at Norfolk, in the harbor of which the wooden frigate *Merrimack* had been scuttled and sunk. They

raised her, cut down her sides, and converted her into an iron-clad ram, which they called the Virginia. She was covered with railroad iron, laid on in an oak backing inclined at about 45° to the water surface. She was armed with 10 9- and 10-inch guns, and on March 8, 1862, sallied out upon the shipping in Hampton Roads, sinking the frigate Cumberland by ramming, and subsequently destroying the Congress. On the 9th she resumed operations, and after a contest with the frigate Minnesota was met by the Monitor, a novel ship constructed by John Ericsson of New York, which after a brief but remarkable combat disabled and drove the Virginia back to Norfolk. This combat marks one of the most notable epochs in naval warfare, and changed the course of naval construction throughout the world. The essential feature of this vessel was a revolving turret, composed of wrought-iron plates an inch thick, bolted together till a thickness of 8 in. had been obtained. The turret was 20 ft. in diameter and 9 ft. high; it contained two 11-inch Dahlgren guns, trained side by side and revolving with the turret, and throwing solid shot weighing 166 lbs., with a charge of 15 lbs. of powder. The hull of the vessel itself was of iron, 127 ft. long, 36 ft. 3 in. wide, and 12 ft. depth of hold. Her extreme length over all was 173 ft., extreme



FIG. 6.—The Monitor (elevation).

width 41 ft. 6 in. She had a very low freeboard, and sat so deep in the water that she seemed submerged. She was built at Greenpoint (Brooklyn), N. Y., in 100 days, and cost \$275,000. The plan upon which she was built is known as the turreted or monitor system, and was invented by Theodore R. Timby of Dutchess co., N. Y. The essential part of the plan was conceived when he was a boy, and the germ of the whole invention was embodied in a model which he completed in 1841. On Jan. 18, 1843, he filed his first caveat for the invention in the United States patent office. His specifications were "for a revolving metallic tower, and for a revolving tower for a floating battery to be propelled by steam." In the same year he completed and exhibited an iron model showing all the essential parts of the system as subsequently adopted, and still later another, which he presented to the emperor of China through Mr. Caleb Cushing, the American minister. In 1848 a committee of congress made a favorable report to the secretary of war upon the system. This was several years previous to the time when Capt. Coles of the English navy claimed to have invented the turret. When the civil war broke out Mr. Timby constructed a fifth model of his invention, embodying all the improvements which he had made. His patents covered the broad claim "for a re-

volving tower for offensive and defensive warfare, whether used on land or water." When therefore the monitors were to be built, the constructors at once recognized the validity of his claim, and paid him a liberal sum for the right to use his invention. Fig. 7 presents the sec-

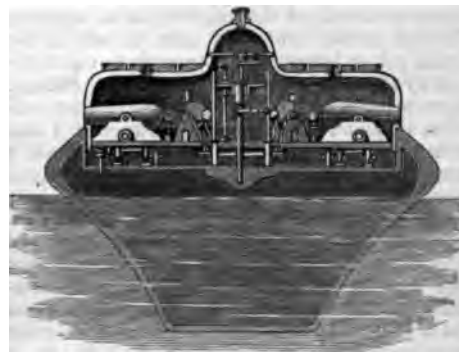

FIG. 7.—Timby's Revolving Turret.

tion of a naval tower designed by Mr. Timby. It is supposed to be 40 ft. in diameter, with space for six guns. Revolving once a minute, its capacity would be one shot aimed at any given point every ten seconds. Thus it seems to be clear that the idea upon which the monitor system is based was invented and first presented to public notice by Mr. Timby; but it remained for Ericsson to give it practical application in this country, and Capt. Coles in England, although the latter did not at first propose to use revolving turrets.—The results of the combat in Hampton Roads were far-reaching in effect; they demonstrated not only the destructive power and practical invulnerability of ironclads, but the utter inability of wooden frigates, no matter how armed or commanded, to contend with them. It was the first contest between the new and the old systems, and left no uncertainty as to their relative merits. All maritime nations addressed themselves actively to the transformation of their old wooden steamships, wherever they were sound, by cutting down and plating their sides, and to supplying themselves with ships built according to the new system. The English displayed extraordinary activity in this direction; public opinion forced the government to build monitors as well as iron-clad frigates; also to employ the best talents the country afforded in improving her system of artillery, as well as in experimenting upon the best combinations, whether of iron or of wood, for constructing impenetrable armor. Mr. E. J. Reed, secretary of the society of naval architects, was called to the post of chief constructor, and began at once a radical modification of the English naval marine. In 1863 the Bellerophon, representing the ideas which Mr. Reed had carried into the English admiralty, was put upon the stocks. The Warrior and

the earlier English ironclads were constructed with deep frames running in a longitudinal direction through the greater part of the ship's hull, combined with numerous strong transverse frames, formed of plates and angle irons. In fact, up to the height of the armor, the longitudinal framing of the older ironclads closely resembles that of the roadway of a common English girder bridge of iron, in which the principal or longitudinal strength is contributed by the continuous girders that stretch from pier to pier, and the transverse framing consists of short girders fitted between and fastened to the continuous girders. If such a structure be conceived to be curved transversely to a ship's shape, and the under side to be covered with iron plating, a fair idea will be had of the construction of the hull of the Warrior. If instead of this arrangement the continuous longitudinal girders be considerably deepened and the transverse girders be replaced by "bracket frames," and, after curving these to the ship's form, both the upper and lower side thereof be iron-plated, a correspondingly good idea will be had of the construction of the hull of the Bellerophon. In other words, the construction of the latter is identical with the cellular system of the Menai and other tubular bridges, which best combines lightness and strength in wrought-iron structures of tubular cross section. This double-skinned or tubular system, in addition to giving greater strength and safety than the single-skinned system, is also better adapted to resist the explosive effect of torpedoes, which are fast becoming one of the most important adjuncts to naval warfare. No ship's bottom can be made strong enough to resist the shock of a torpedo's explosion, and consequently Mr. Reed provided as far as possible against the danger of sinking by dividing his ships into water-tight compartments. Notwithstanding the superior strength and safety thus given to the Bellerophon, the weight of her hull was considerably less than it would have been if built of wood, and was very much less than the total weight of armor, armament, and equipment. In the wood-built ironclads the weight of hull was generally about equal to that of the total weight carried, and in the earlier built ironclads the hull was heavier than the cargo. In the Black Prince the weight of hull was 4,969 tons, and the total weight carried 4,281 tons. In the Bellerophon the hull, with thick skin plating and extra girders, was 3,652 tons, while the total weight carried was 3,798 tons. In the case of the Monarch, a turret ship built after this system, the weight of the hull is 3,674 tons, while the weight carried is 4,632 tons. In all the later ships constructed by Mr. Reed the carrying power is much greater than the weight of the hull, and is due mainly to the improved structural arrangements introduced by him. This system is known among naval constructors as the "bracket-plate system," and is now generally employed even by the private ship builders of England who build ships of war.—Iron-clad ships are substantially of two forms or types: those in which the batteries are protected by armor laid upon the walls of the ships, such as the New Ironsides, Warrior, Hercules and Bellerophon, and those carrying their batteries in turrets, such as the Miantonomoh, Monitor, Glatton, Thunderer, and Devastation; and they are divided into classes according to their uses for cruising, defending harbors, guarding coasts, or operating upon rivers and lakes. While there is a certain similarity in all the vessels of each class, there are also many differences in details, according to the intended use. The Warrior is armed only at the middle, with 4½-inch plates, while both bow and stern, including the steering gear, are exposed to shot and shell. In all the more recent English ships this central battery or "box" has been enlarged by a continuous belt of armor extending from stem to stern, and protecting the region of the water line and steering gear. The Warrior's armor is of uniform thickness; but in recent ships the most vital parts, such as the region of the water line and over the machinery, have been further protected by thick armor, additional backing, and iron bulkheads fitted inside. The Warrior possesses only broadside fire; all the later vessels have their fighting capacity increased by bow and stern fire of greater or less extent. The Warrior has only her main-deck battery armor-plated; recent ships have a protected upper-deck battery. The Warrior has her guns well spread out; later ships carry their battery concentrated, and composed of much heavier guns. The Warrior was made extremely long with a view to speed; recent ships are much shorter in proportion, and are handled more easily. The Warrior has a single-skinned hull and comparatively light and weak framing; later ships are double-skinned, with deep, strong framing and water-tight compartments. The armor of the Warrior, as before stated, is only 4½ in. thick; that of the Bellerophon is 6 in., of the Hercules 9 in., of the Hotspur 11 in., and that on the sides of the monitors Glatton, Thunderer, and Devastation is 12 in., while their turrets are 14 in. Presuming that the resistance offered by armor plates to penetration varies as the square of the thickness, which is approximately correct, the armory of the Bellerophon is nearly twice as strong as that of the Warrior, of the Hercules about seven times, of the Hotspur six times, of the Glatton seven times, and of the turrets of the latter nearly ten times. The guns (rifled) used by the Warrior weigh 4½ tons, those of the Bellerophon 12 tons, of the Hercules 18 tons, of the Glatton 25 tons; while those of the Thunderer and Devastation weigh 30 tons. The necessity of carrying such armor and guns, and of firing ahead and astern, as well as from the broadside, has rendered essential many changes in the sizes, forms, and arrangements of the sides, decks, and batteries



and ships. The introduction of twin muzzles led to the necessity of having light-armor for coast and harbor defence, and led to further differences. When the first English ironclads were constructed, powerful guns used by their ships were 68-pdrs. or 8-inch smooth-bore. The Americans then used 9- and 10-inch guns. 4½-inch armor plating was deemed sufficient when properly backed and supported. The necessity of armor backed in various ways led to the construction of a large number of the French ironclads. In the first ironclad, the Warrior, Black Prince, Achilles, Resistance, Hector, and Valiant, the armor was backed by 18 in. of teak inside the hulls; and in the wooden armor was bolted on the outside of the plating. In the Minotaur class the plating was increased to 5½ in., but the backing was reduced to 9 in., so that practically the latter class are of the same strength as the Warrior class. In the Belletroupe armor plating is 6 in. and the backing is still further strengthened by the skin plating 1½ in. thick, or 1 inch thicker than in the older ironclads. The armor of sea-going broadside ironclads according to some English authorities, has its greatest thickness in the Hercules class, 9-inch armor at the water line, and the most important parts of the hull and 6-inch on the remainder, with 10 and 12 in. thick outside the 1½-inch plating. Below the lower deck, and the lower edge of the armor, the armor is often made of "wing passages" are filled with solid teak backing, inside of which is an iron skin ¼ in. thick, supported by 7 in. of iron. The total protection in the region of the water line therefore is 11½ in. of iron, of which 9 in. are backed, and 40 in. teak backing. The target at Shoeburyness, constructed at this part of the ship's side, proved to be virtually impenetrable to the 600-lb. gun. But the maximum thickness of armor must not be considered to have been attained. Coast-defence vessels and ships have been built to carry 11- and 12-inch guns. Ships have been designed and will be built for sea-going purposes to carry 8, and 20 in. of armor, either in turrets or broadsides. There can be little doubt that improvements are made in the manufacturing of heavy guns, correspondingly will be made to the thickness of armor. It is hardly possible to foresee in what competition between guns and ships will be made. Grouping the iron-clad ships according to the thickness of armor and backing, without regard to the extent of the surface providing them into iron-built and wooden, and remembering that turret armor is a little stronger than the side

armor, the preceding facts may be summarized as follows:

IRON-BUILT.

VESSELS.	Armor.	Back- ing.	Skin plating.	Remarks.
	Inches.	In.	Inches.	
Scorpion .....	4½	9	½	The weakest of English ironclads. But very slightly stronger than the above.
Wivern .....				
Viper .....				
Vixen .....				
Waterwitch .....				
Warrior .....	4½	18	½	All of equal strength to resist shot.
Black Prince .....				
Achilles .....				
Defence .....				
Resistance .....				
Hector .....				
Vallant .....				
Prince Albert .....				
Agincourt .....				
Minotaur .....				
Northumberland .....	5½	9	½	The greater thickness of skin plating in this and most of the following ships is obviously equivalent to an increase in the thickness of armor. Armor only 5 in. thick on some parts of the broadside.
Bellerophon .....	6	10	1½	
Penelope .....	6	10	1½	These have 8-inch armor on the water-line belt.
Invincible .....	6	10	1½	
Audacious .....				
Vanguard .....				
Iron Duke .....				
Swiftsure .....				
Triumph .....	7	12	1½	The Captain had 8-inch armor in the wake of the turret. An additional protection of about 30 in. of teak, backed by a ½-inch iron skin, in the neighborhood of the water line.
Monarch .....				
Captain .....	9	10	1½	
Her- cules	On belt... Over gun- sides....	8	10	1½
Sul- tan	On sides generally.	6	12	1½
Hot- spur	On sides... On breast- work....	11 8	12 12	1½ 1½
Ru- pert	On sides... On breast- work....	11 12	12 12	1½ 1½
Glatton .....	12	12	1½	
Thunderer .....	12	18	1½	
Devastation .....				

WOOD-BUILT.

VESSELS.	Armor.	Thickness of side.
	Inches.	Inches.
Caledonia .....	4½	20½
Ocean .....		
Prince Consort .....		
Royal Oak .....		
Zealous .....		
Pallas .....		
Favorite .....		
Research .....		
Enterprise .....		
Royal Sovereign .....		
Royal Alfred .....	6	20½
Repulse .....	6	31
Lord Clyde* .....	4½	31½
Lord Warden* .....		

\* These two ships have an inner skin of 1½-inch iron, and a strake of 5½-inch armor at the water line, and the frame is filled in solid behind the armor; so that in addition to the outer and inner armor, the whole thickness of the side is available to resist penetration. In all the other wooden ships water can enter when the outside planking, which is only 8 or 10 in. thick, is penetrated.

The information contained in the preceding summary of the English ironclads is illustrated in the accompanying engravings, showing specimen blocks cut from the sides of the ships which may be taken as fair representatives of the various classes. The section from the side of the Kalamazoo may be regarded as fairly representing the strongest class of American monitors. The latest publication concerning the English iron-clad navy (April, 1874) gives a list of 55 vessels, of which 41 are sea-going ships and 14 are available for harbor and coast defence. Of the sea-going ships 5 are in the course of construction, and 9 are not fit to go to sea, or worth making fit; and 9 more which are not

yet available for service should also be deducted, leaving 18 now about ready. Of the 14 coast-defence ironclads, only 9 are fit for service; the other 5 are on foreign stations and said to be not worth taking home. The French ironclads Gloire, Magenta, and Solférino have armor a little over 4½ in. thick, worked upon ordinary wooden hulls. The iron-built frigate Couronne and the small wooden floating batteries of the Palestro class carry about the same thickness of armor. All the other floating batteries are iron-built and have 5½-inch armor. The frigates of the Flandre class and the ram Taureau have armor a little less than 6 in. thick laid upon wood

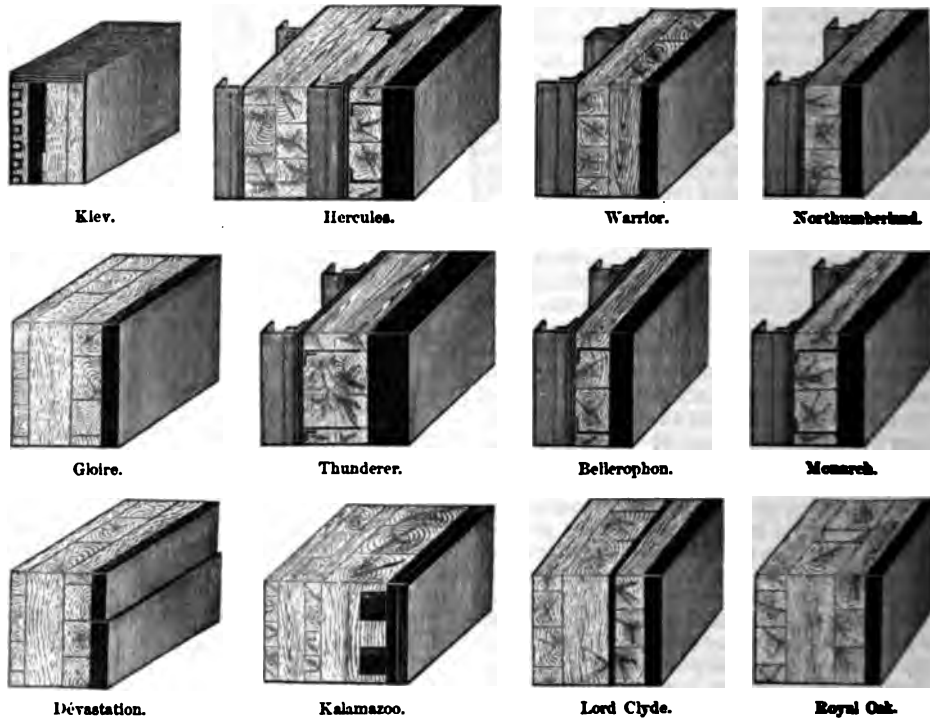

FIG. 8.—Sections of the Sides of Iron-clad Ships of the Various Classes.

hulls, while the corvettes and second-class frigates of the Alma class have armor  $5\frac{1}{8}$  in. thick at the water line, and 4 and  $4\frac{5}{8}$  in. on the other parts. The vessels of the Marengo class, corresponding very nearly to the English Invincible class, have  $7\frac{1}{8}$ -inch armor at the water line, and from 4 to 6½ in. on other parts. The rams of the Bélior class have 7- and 8½-inch armor. By far the greater number of the French ironclads are wood-built, the armor being simply laid upon the outside planking, without inner skin plating or longitudinal girders to give greater strength. They are therefore weaker than the English ships even when the armor and backing are equal.—In the American sea-going ironclads, what is

known as laminated armor has been largely if not almost exclusively used. This was rendered necessary at first by the fact that thick armor plates could not be produced by the rolling mills in anything like sufficient quantities; but a few ships like the Roanoke and New Ironsides have been made with solid armor, the former having plates 5½ in. thick and the latter 4½ in. With this exception, the armor of our ironclads is made up of consecutive plates averaging 1 in. thick, but backed, as in some of the monitors, by armor stringers or plank armor of small breadth and moderate thickness. Experiments made by the English admiralty at Shoeburyness prove this laminated armor to be far inferior to solid armor in power

ance, and that no amount of strength-  
 and compensate for the defects of the  
 d system. The resistance of single ar-  
 tes, shown by direct experiment for all  
 ses up to 5½ in. to  
 the square of the  
 s, does not obtain  
 nated armor. For  
 , a 4-inch solid plate  
 e 16 times as strong  
 ch plate, but would  
 our times as strong  
 1-inch plates riv-  
 urther, although it  
 be much stronger  
 e laminated struc-  
 xcluding the Roan-  
 New Ironsides and  
 r ironclads, which  
 only the Monitor  
 he armor of the  
 n ironclads may be  
 summarized as fol-  
 he original Monitor  
 hull protected by  
 ers of 1-inch plate,  
 ing first to 4 in.

a to 3 in. in thickness below the wa-  
 her turret, as previously stated, was  
 eight layers of 1-inch iron. The  
 eaking of the hull armor was 27 in.  
 lted to ¼-inch iron skin plating. The  
 class have armor of the same thick-  
 the first Monitor, but have 39 in. of  
 eaking. The Canonicus class have five  
 f 1-inch plates, supported by two ar-  
 ringers let into 27 in. of wood backing;  
 rrets have 11 layers of 1-inch plates.  
 ontomoh and the Monadnock, which  
 d-built, are protected much like the  
 us. The Puritan and the Dictator  
 layers of 1-inch plates on their sides,  
 in. of wood backing; their turrets are  
 hick, made up of two drums, with  
 s of wrought-iron hoops 5 in. thick  
 between the drums, which are com-  
 f layers of 1-inch plates. In the Kala-  
 class the total thickness of hull ar-  
 6 in., made up of two layers of 3-inch  
 backed by 30 in. of oak, still further  
 ened near the water line with three  
 tringers, 8 in. square, let into the back-  
 only a few inches apart. This is by  
 most formidable armor carried by any  
 merican monitors; and while there are  
 places 14 in. of iron, there is no part  
 rly so strong as it would be with that  
 s in solid plates. The turrets of the  
 zoo are 15 in. thick, like those of the  
 ; but none of them have any backing  
 d about them. The rapid diminution  
 ness of armor on these vessels is a se-  
 fect, leaving no ground for comparison  
 rresponding English ships. The Dic-  
 r instance, 2½ ft. below the water line,  
 two 1-inch plates, and at 3 ft. only one.

Fig. 9 shows a section of the Dictator's armor,  
 with one of the English turreted ship Thun-  
 derer. Though generally unfit for cruisers, the  
 monitors are well adapted to coast and harbor

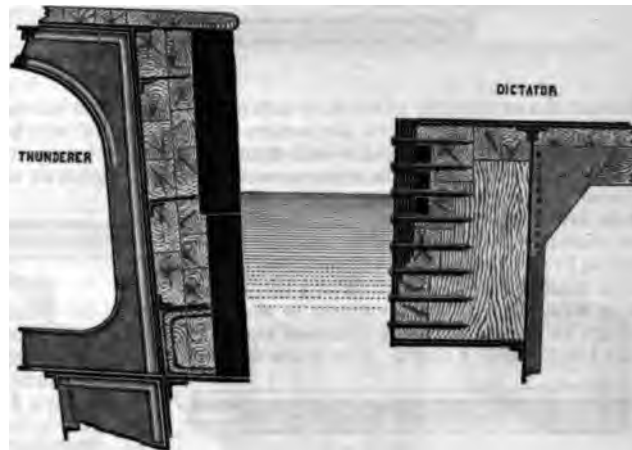

FIG. 9.—Sections of the Armor of the Thunderer and Dictator.

defence. The present strength of the United  
 States iron-clad navy is as follows:

NAME.	Rate.	Guns.	Tonnage.
Ajax.....	Fourth.....	2	550
Albatross.....	Fourth.....	2	498
Amphitrite.....	Third.....	4	574
Canonicus.....	Fourth.....	2	550
Cassin.....	Fourth.....	2	498
Catakill.....	Fourth.....	2	498
Chickasaw.....	Fourth.....	2	450
Coloche.....	Fourth.....	2	498
Colossus.....	Second.....	10	2,127
Dictator.....	Second.....	2	1,750
Etah.....	Fourth.....	2	458
Hero.....	Fourth.....	1	458
Iris.....	Fourth.....	2	458
Jason.....	Fourth.....	2	498
Kewadin.....	Fourth.....	4	540
Klamath.....	Fourth.....	2	458
Koka.....	Fourth.....	2	458
Lehigh.....	Fourth.....	2	498
Mahopac.....	Fourth.....	2	550
Manhattan.....	Fourth.....	2	550
Massachusetts.....	Second.....	4	2,127
Miantonomoh.....	Third.....	4	1,225
Minnetonka.....	Fourth.....	1	458
Modoc.....	Fourth.....	1	458
Monadnock.....	Third.....	4	1,091
Montauk.....	Fourth.....	2	498
Nahant.....	Fourth.....	2	498
Nantucket.....	Fourth.....	2	498
Napa.....	Fourth.....	1	458
Nauset.....	Fourth.....	2	458
Nebraska.....	Second.....	4	2,125
Niobe.....	Fourth.....	2	458
Oregon.....	Second.....	4	2,127
Otsego.....	Fourth.....	1	458
Passaic.....	Fourth.....	2	498
Pascataqua.....	Fourth.....	1	458
Puritan.....	Second.....	2	1,870
Roanoke.....	Second.....	6	2,240
Saugus.....	Fourth.....	2	550
Shawnee.....	Fourth.....	2	458
Suncook.....	Fourth.....	2	459
Terror.....	Third.....	4	1,053
Umpqua.....	Fourth.....	1	458
Wassuc.....	Fourth.....	1	458
Winnebago.....	Fourth.....	4	540
Wyandotte.....	Fourth.....	2	550
Yazoo.....	Fourth.....	2	458
Yuma.....	Fourth.....	2	458

—In the earlier English ironclads the armor extended over a portion of the broadside only, as in the case of the Warrior, whose length is 380 ft., and the armored portion only 213 ft.,

ends of the ship are not overloaded as in the complete protection system. An important modification of the method of applying the armor is shown in the engraving of the Invincible,

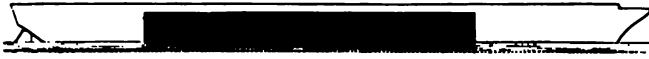

FIG. 10.—Warrior.

leaving the extremities of the ship entirely unprotected. At the ends of the armored portion iron-plated bulkheads are built across the ship, making with the side armor a central or "box" battery extending to a little more than 6 ft. below the water line. This box battery, or partial protection, is also adopted on the Black Prince, Defence, and Resistance, but has been modified by the addition of a belt of plating extending from the upper to the main decks, before and abaft the broadside armor, on the Hector and Valiant. The main deck on



FIG. 11.—Hector.

which the guns are fought is thus protected throughout its entire length, but the extremities between wind and water are quite unprotected. Both these plans of disposing the armor were considered unsatisfactory, and in the Minotaur and converted ships of the Caledonian class, the "complete protection system," in which the armor extends from stem to stern, and 6 ft. below the water line, was adopted. This system is followed in nearly all the monitors, both English and American, and in nearly all the French ships. The great development in the power of ordnance has led not only to increased thickness of armor, but to different modes of disposing it. In the Bellerophon and Hercules, and in oth-

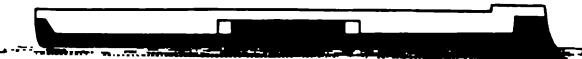

FIG. 12.—Hercules.

er large English ships, an arrangement of the armor consisting of a middle course between the Warrior and Minotaur has been adopted.

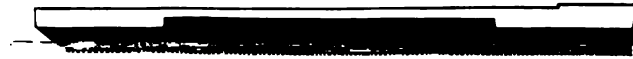

FIG. 13.—Achilles.

The Achilles, a ship of the Warrior class, had the water-line belt added. This plan of plating is known as the central battery and armor belt system. In this arrangement the great weight of the armor and battery is amidships, and the



FIG. 14.—Invincible.

by which the plating is continued up to such a height above the upper deck, amidships, as to protect four heavy guns mounted at the angles of an octagonal battery, of which the ends are closed by transverse iron-plated bulkheads. Previously to the design of this arrangement the Lord Clyde



FIG. 15.—Lord Clyde.

and Lord Warden were supplied with powerful armored bow batteries on the upper deck, but the arrangement of the Invincible has many advantages. In their recent ships the French have abandoned the complete protection system, and adopted the central battery and armor belt system, and generally follow the varieties of English practice. The American practice, as shown in the New Ironsides and Roanoke, is essentially the same as the central box or partial protection system. In the monitor system the practice has been sufficiently indicated. With the low freeboards of these vessels, the armor that would otherwise go upon the sides has to be spread upon the deck to prevent penetration by plunging and vertical fire, to which they are peculiarly liable. The English admiralty have designed an arrangement of armor which they apply to what they call "breastwork monitors." They resemble American monitors, in having their upper decks at comparatively small height above water; but instead of having these decks flush, except where the turrets, funnels, air shafts,

and hatchway casings rise above the deck, they have a space amidships surrounded by an armored breastwork, which rises several feet above the deck, and encloses the parts just mentioned. By this means the height of the freeboard is materially increased for a great part of the ship's length; the height of the turret parts above water is made much greater than is usual in American monitors; and the liability to serious injury, resulting from the



FIG. 16.—Cerberus.

perforation of the deck and funnels and from heavy blows upon the base of the turrets, is much reduced. The Cerberus is a fair representation of the breastwork monitors.—The monitor or turret

system possesses many advantages, but also under some circumstances so many disadvantages that its introduction has occasioned much diversity of opinion among naval officers and constructors throughout the world. The advantages are as follows: the facility with which large guns may be smoothly and easily trained, and with which the same guns may be used in all directions; the small size of the ports, and the difficulty of hitting them; the low freeboard, and consequently small target offered to the enemy's fire; the great thickness which may be given to the armor, and the great size and penetrating power which may be given to the few guns protected by it. As fighting ships, there is no reason why the monitors may not be made superior to any other form of ironclad yet invented. The only serious defect which has been developed in their fighting power is the liability of the turret as originally constructed to become jammed by being struck at

sea-going vessel. On the other hand, with such improvements as have been or may hereafter be made, this class of ships are and will probably remain unrivalled for harbor and coast defence, and for use against land batteries and fortifications, and may ultimately be made to serve successfully as cruisers. Two circular monitors, the Kiev and Novgorod, designed by Admiral Popoff, have been constructed by the Russian government, for use in the

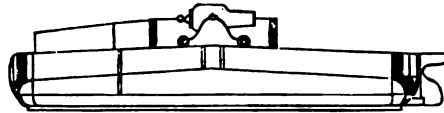

FIG. 18.—Russian Circular Monitor, Elevation and Deck.

North and Black seas. These batteries are called Popoffka, and are about 100 ft. in diameter, bordered with wood and lined with copper, after the system followed in the construction of the Raleigh in England. Their draught is about 12 ft., height of upper deck above water about 2 ft., and displacement about 2,530 tons. Their stability in the water is secured by 12 keels. The middle of the vessels is surmounted by a turret 30 ft. in diameter and 7 ft. high, carrying two steel 11-ton 8-inch breech-loading rifles. The lower part of the hull is double-skinned, the outer skin being about  $\frac{1}{4}$  in. thick, and the inner one  $\frac{1}{8}$  in. The space between is about 8 ft. and divided into water-tight compartments. They are propelled by six separate engines and screws, each working up to 80 horse power. Their speed is about 9 knots per hour; complements of

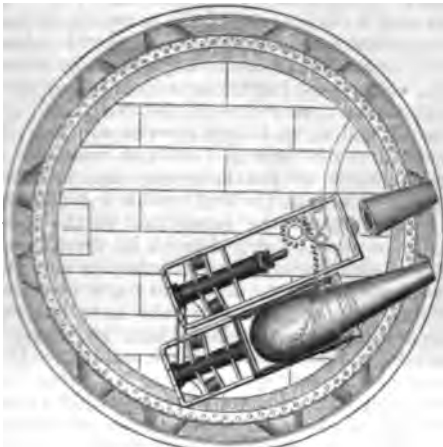

FIG. 17.—Eads's Revolving Battery.

or near the junction with the deck, so that it will not revolve. This defect has been partially remedied by the use of a massive ring of iron, surrounding the base of the turret, and by the breastwork system. A still better remedy has been introduced by James B. Eads, C. E., of St. Louis, who constructed stationary turrets and arranged the guns so that they might be traversed in pairs, as shown in fig. 17. The greatest defect in this system is that ships constructed after the original Monitor model are poorly adapted for sea-going purposes, and hence cannot be made first-class cruisers. This opinion is not controverted by the fact that the Miantonomoh and similar ships have crossed the ocean in various directions. It is now generally admitted that no monitor, with turrets standing upon the low deck, unprotected by breastworks, with hatchways, air shafts, and low turret tops opening through her deck only two or three feet above the water line, can be considered as a satisfactory

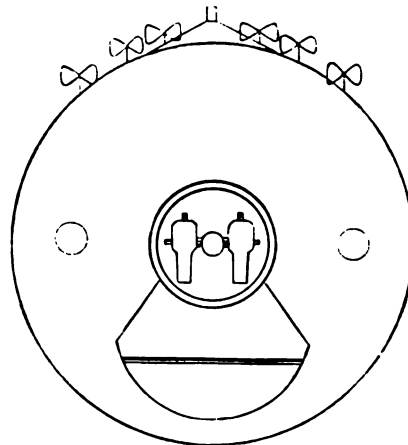

FIG. 19.—Deck of Russian Circular Monitor.

officers 11, men 85 to 90. The hull armor is composed of two strakes of plates each  $2\frac{1}{2}$  ft. wide, the upper one about 9 in. thick and the lower about 7 in., backed by 7 and 9 in. of teak respectively. The turrets are constructed

in the same manner, but the plates are 9 in. thick throughout. This system seems to be capable of great expansion as affording the means of constructing batteries practically indestructible, and capable of carrying any weight of armor or armament.—The offensive powers of ironclads, in common with those of other ships of war, are measured by the number and power of their guns, the rapidity with which they may be loaded and fired, and the facility with which they may command all points within range. The wooden frigates of the English navy in use before the construction of ironclads carried 32-pdrs. and 68-pdrs.; while the Americans used 42s, 64s, and 9- and 10-inch Dahlgren smooth-bore shell guns, which at the outbreak of the civil war they increased to 11-inch guns. Subsequently they adopted 13- and 15-inch iron guns of the Dahlgren model, cast after the Rodman process, the 15-inch guns throwing solid shot weighing 450 lbs., with a charge of 60 lbs. It is now proposed to make and use on the monitors 20-inch guns throwing shot weighing 1,080 lbs., with a charge of powder weighing from 120 to 250 lbs. It is thought to be practicable to construct and use even 25- or 30-inch guns of this model. This system is based upon the idea of a heavy projectile of large size moving at comparatively low velocity, instead of an elongated projectile moving at a high velocity, and is termed the "racking or battering" system, in contradistinction to the English "punching system," based upon the use of rifle guns throwing large elongated shot at higher velocities. The latter, instead of using the 68-pdr. (8-inch) gun, which failed to penetrate the Warrior's armor at 200 yards, now use 64-ton rifle guns, which would pierce it at 500 yards, 12- and 18-ton guns, which would do the same at 2,000 and 3,000 yards, and 25-ton guns, which would probably penetrate any ironclad afloat, except perhaps the Hercules, at 4,000 yards. They have made and will use on the Thunderer and Devastation 30-ton rifles, throwing shot weighing 600 lbs. They contemplate the construction and use at an early day of 70- and 80-ton rifles, and ultimately will doubtless construct them of still greater weights and power. The projectile of the 64-ton guns is 7 in. in diameter and weighs 115 lbs., taking a charge of 22 lbs.; that of the 12-ton gun is 9 in. in diameter, weighs 250 lbs., and is fired with 43 lbs. of powder; that of the 18-ton gun is 10 in. in diameter, weighs 400 lbs., and is fired with 60 lbs. of powder; while those for the 25- and 30-ton guns are 12 in. in diameter, weigh 600 lbs., and are fired with 70 lbs. and 100 lbs. of powder respectively. Great differences of opinion prevail with reference to the merits of these two systems, but experiments made by the English seem to fairly indicate the superiority of the punching system. They show, for instance, that the 15-inch smooth-bore gun, throwing a spherical solid shot weighing 484 lbs., with a

charge of 50 lbs. of English powder (said to be equal to 60 lbs. of American powder), would fail to penetrate the Lord Warden's side (see fig. 8) at any range, while the English 9-inch 12-ton gun, with an elongated shot weighing 250 lbs. and a 43-lb. charge, would penetrate her at 1,000 yards. They also show that the 15-inch smooth-bore gun would not penetrate the Warrior at a greater range than 500 yards, while the 7-inch 64-ton rifle, weighing only about one third as much, would penetrate her at the same distance with a charge of 22 lbs. and a shot weighing 115 lbs. As a matter of course, the rifles of 12, 18, 25, and 30 tons would penetrate at correspondingly increased distances. On the other hand, there seems to be but little doubt that the American guns have greater battering power; the real question at issue is as to the relative merits of penetration and battering or racking. The English and the French prefer the former, and for apparently sound reasons, while the Americans as yet prefer the latter and point to the experience of the civil war in vindication of their opinion. But it must not be forgotten that the ironclads disabled or captured by them from the confederates were hastily constructed and poorly armored, and carried light guns in comparison with those of the well built and strongly armored ships of the European navies. The advocates of the racking system lay particular stress upon the "smashing" of the sides of the casemated ship Atlanta by the 15-inch shot of the monitor Weehawken, at a range of 300 yards; but the Atlanta was not a first-class ship in any respect. There is now but little doubt that the United States government will be forced to abandon the racking system in its future vessels, or better still, to combine it with the punching system.—*Iron-clad Rama.* The introduction of steam men-of-war gave rise to numerous proposals for reviving the ancient method of naval warfare, that of disabling or sinking an enemy by ramming; and when the Gloire and the Warrior were built, their bows were designed, strengthened, and projected with this object in view. In all succeeding ironclads more or less efficient provisions have been made to adapt the bows to the same purpose. In the American navy a special class of small swift river steamers were fitted up specially for this purpose during the civil war. The confederates built several extraordinary crafts of this class, designed specially for harbor defence, among the most notable of which was the Merrimack already mentioned. Most if not all of the monitors were also strengthened for ramming, and several of the engagements, particularly those on the Mississippi, were greatly influenced if not decided by ramming. The French and English followed the example of the Americans, and at the end of the war they had generally adopted the opinion of our naval officers that "every ironclad should be an unexceptionable ram; in other words, susceptible herself of being used

as a projectile." The victory of the Austrian over the Italian fleet at Lissa in 1866 was in a great measure due to the excellent services of the Austrian ship Ferdinand Max, which rammed and sunk the American-built frigate *Re d'Italia* and damaged other ships severely. It afforded conclusive evidence of the great results which may be achieved by the proper use of this method of attack, and attracted renewed attention to the construction and manœuvring of iron-clad rams. In order that a ship may be efficient as a ram, it is obvious that she should be swift and handy under steam, so as to enable her not only to overtake her enemy, but to hit her directly and squarely in the side. These qualities are incompatible with either great size or great length. Hence the ram should have moderate dimensions and proportions, in combination with powerful machinery, twin screws, and improved means of steering. As to the proper form of ram bows, there are some differences of opinion among naval constructors. Some favor stems reaching forward above water, others prefer upright or nearly upright stems; but the majority are decidedly in favor of the under-water prow, spur, or *iperon*, which has been generally adopted in European navies. The advocates of the forward-reaching stem, like that shown in the *Warrior*, think that there is an advantage in delivering the blow above water rather than under, particularly in ramming low-decked monitors or ships with low sides, on the ground that there is a probability of overrunning the enemy and making the weight of the ramming ship aid in sinking her. The advocates of the upright stem, like that shown in the *Achilles* and *Invincible*, assert that the blow delivered thereby is not so local in its effect, and that this form of bow can be more readily disengaged after ramming; while the advocates of the spur bow (shown in the *Lord Clyde*) believe that it is specially adapted to sink an enemy by penetrating the weak side below the armor, and particularly about the rudder, and that it possesses greater penetrating power than any other bow. Mr. Reed, late English naval constructor, holds that this form possesses special advantages against American monitors, the armor of which generally terminates at comparatively slight depth below water.—The following table shows the strength of the iron-clad navies of the world in 1873:

COUNTRIES.	Number of ships.	Aggregate number of guns.	COUNTRIES.	Number of ships.	Aggregate number of guns.
Great Britain.....	54	721	Sweden & Norway.....	13	23
France.....	44	857	Turkey.....	22	127
Germany.....	6	79	Greece.....	2	..
Austria.....	11	166	United States..	43	121
Italy.....	23	207	Brazil.....	13	64
Spain.....	7	145	Chili.....	2	..
Holland.....	20	61	Peru.....	6	24
Denmark.....	6	69			
Russia.....	25	190			
			General total.	306	2,344

—See "Ordnance and Armor," by A. L. Holey (New York, 1865); "History of the Navy during the Rebellion," by the Rev. O. B. Boynton (New York, 1867-'8); "System of Naval Defences," by James B. Eads (New York, 1868); "Our Iron-clad Ships," and "Ship Building in Iron and Steel," by E. J. Reed (London, 1869); *L'Art naval à l'exposition universelle de Paris en 1867*, by Vice Admiral Edmond Paris (Paris, 1869); "Reports of the Committee appointed by the Lords Commissioners of the Admiralty to examine the Designs upon which Ships of War have recently been constructed" (London, 1873); *La marine cuirassée*, by M. P. Dialère (Paris, 1873); and reports of the secretary of the navy.

**IRON MANUFACTURE.** Since the reduction of iron from its ores is an operation of simple character, requiring merely that the ore shall be in contact with burning fuel in an enclosed space, or in the midst of the fire, it is not surprising that the process was employed in remote antiquity. The Greeks attributed the discovery of iron to the burning of the forest on the mountain of Ida in Crete about 1500 B. C. The rapidity with which iron rusts on exposure is no doubt the reason why so few ancient articles of this material are preserved. Pliny quaintly says: "Nature, in conformity with her usual benevolence, has limited the power of iron, by inflicting upon it the punishment of rust; and has thus displayed her usual foresight in rendering nothing in existence more perishable than the substance which brings the greatest dangers upon perishable mortality." Copper and bronze are not so liable to oxidation, and are consequently better preserved. Iron is occasionally found in the metallic state in meteorites, but its amount is too small to be of importance to any nation. There is abundant historic testimony to the great antiquity of iron. The Bible contains a great number of references to it. Wilkinson says: "Iron and copper mines are found in the Egyptian desert, which were worked in old times; and the monuments of Thebes and even the tombs about Memphis, dating more than 4,000 years ago, represent butchers sharpening their knives on a round bar of metal attached to their aprons, which from its blue color can only be steel; and the distinction between the bronzed and iron weapons in the tomb of Rameses III., one painted red, the other blue, leaves no doubt of both having been used (as in Rome) at the same period. In Ethiopia iron was much more abundant than in Egypt." According to Diodorus, the Egyptians assigned the art of working iron to their great national divinity Osiris, thus implying that it was known from time immemorial. Herodotus and Pausanias mention that the Lydian king Alyattes, the father of Croesus, who died about 570 B. C., presented as an offering at Delphi a curiously inlaid iron saucer made by Glaucus, an inhabitant of Chios. Both Diodorus and Herodotus mention the island of Elba as abounding in ironstone,

and describe the method of melting it. In the time of Æschylus (born in 525 B. C.) the Chalybes were famous workers in iron, and Chalybia was called the mother of iron. Strabo, writing about the beginning of the present era, speaks of the iron mines of Chalcis in Eubœa as almost exhausted by the extensive mining operations of the Athenians. He also mentions iron brought from Britannia, and speaks of the mines of Elba, famous to this day, then called by the Greeks, from the blazing fire of its iron works, Æthalia. Pliny the Elder devotes two chapters of his "Natural History" (xxxiv. 14, 15) to an account of iron, its uses and manufacture. He speaks of an iron statue of Hercules by Alcon at Thebes, and bowls of iron in the temple of Mars at Rome; of different qualities suited to different purposes, some being adapted for hardening into steel, or else prepared in another manner for making thick anvils or heads of hammers; and of the Serican, Parthian, and Norican irons. He was aware of the magnetic property of iron, and speaks of an iron statue of Arsinoë, sister of Ptolemy Philadelphus, which it was proposed to suspend in air, in a temple, by means of a vaulted roof of loadstone. Iron of great antiquity has been found in eastern countries. Belzoni describes the discovery, under the feet of one of the sphinxes unearthed by him at Karnak, of an iron sickle, which he considers to be at least as old as the age of the Ptolemies. It was of the same form as those depicted in the tombs at Memphis. At Memphis iron has been found in the ancient structures, and two pieces have been taken from the great pyramid of Gizeh. Layard discovered at Nimrud a large number of articles showing great knowledge and skill in working this metal possessed by the Assyrians. Most of them, having been wholly converted into oxide, fell to pieces when touched. Among the objects found were armor scales, daggers, shields, heads of spears and arrows, a pick, a double-handed saw, articles of combined bronze and iron (the former having been cast around the latter), part of a stand consisting of an iron ring with three feet of bronze, &c. Iron ornaments of the ancient Chaldeans have been discovered, but no implements, showing that with them iron was still a precious metal. The most remarkable evidences of the progress made by the ancients in iron metallurgy are found in India, although, strangely enough, the art as practised in that country at the present day is extremely rude and simple. In the remains of temples are found iron beams, one of which measures 24 ft. in length and 8 in. in section. The famous Delhi wrought-iron pillar, called Cuttub Minar, at the mosque of the Cuttub Shaw, is upward of 48 ft. long. Its lower diameter is about 16½ in., its upper diameter 12 in. It contains upward of 80 cubic feet of metal, and weighs 17 tons. It is supposed to have been erected A. D. 319. How such a forging could have been effected is a mystery.

The only probable suggestion hitherto brought forward is, that it was made by welding each bloom directly to the previously made bloom, and that as the column grew in height the furnace was elevated by throwing up a mound of earth, so that the top of the pillar formed the bottom of the furnace, and the blooms as soon as formed were directly welded to the top of the still glowing pillar.—From some obscure remarks by ancient writers it has been inferred that cast as well as wrought iron is of great antiquity; and it has been suggested that the ancients practised the art of steel making described by Vanoccio Biringuccio in 1540 and by Agricola shortly after, which consisted in immersing pieces of soft iron in a bath of molten iron. This we can only conceive possible by supposing the metal bath was well carbonized. The evidence for this is however very slight. Aristotle writes: "Iron may be cast so as to be made liquid and to harden again; and thus it is they work to make steel." Pliny in describing the process of iron smelting says: "It is a remarkable fact that when the ore is fused, the metal becomes liquefied like water, and afterward acquires a spongy brittle texture." This may refer, however, to the liquefaction of the cinder. Diodorus gives a clearer and more comprehensible account of the smelting process on the island of Elba, and says nothing about molten metal: "The workmen employed first cut the stone in pieces, and then melt them in furnaces built and prepared for the purpose. In these furnaces the stones, by the violent heat of the fire, are melted into several pieces in form like great sponges." This description might equally apply to the bloomary practice of the present day.—Though so little is known of the methods employed by the ancients for the reduction of iron from its ores, it is not improbable that they were similar to those still in use in eastern countries, which have been practised from time immemorial. A low stack, either built of clay or excavated on the hillside, with openings at the bottom for draught of air or for an artificial blast, is all the apparatus required for the successful manufacture of iron. The furnaces of India are usually from 3 to 6 ft. high and from 10 to 18 in. in diameter. The blast, supplied by bellows made of skins, is forced into the furnace through clay tuyeres. The furnace is charged with ore and charcoal alternately, until the requisite amount of ore has been added. After a blast, varying from 3 to 4 up to 18 hours, a mass of soft malleable iron mingled with cinder is removed from the furnace, either by breaking away the lower part of the stack, or by lifting the bloom out of the top with tongs. The weight of the iron bloom varies from 4 or 5 up to 200 lbs. It is hammered while still hot, reheated and again hammered, until the greater part of the cinder is expelled.—The knowledge of the method of reducing iron was probably introduced into Europe from the East, but when and by whom is unknown. Traces of early workings



in Spain and England are abundant. The method employed differed from that in use at the present day in India. Charcoal and ore were placed in a furnace consisting of a small hearth, 4 to 6 ft. rectangular, provided with a tuyere on the left side, a brick wall, and resembling a blacksmith's anvil. This form of furnace has descended to the present day, and is still in use in many parts of Spain. The Catalan forge, used mainly in the Pyrenees, and the American (a modified German) now chiefly confined to Canada and the northern New York, are the most prominent examples of this ancient method. (See *Art.*) The nature of the process in low furnaces or hearths is extremely simple. The ore is reduced by the carbon and iron oxide, and, not being fusible at the temperature of the furnace, agglutinates together to a pasty mass, which gradually sinks and accumulates in the bottom of the furnace. The completeness of the reduction depends on the time of exposure and the amount of charcoal used. When reduction is complete, the unreduced ore fuses and melts with the iron. When silica is present in the ore, as is almost always the case, it unites with a portion of ferrous oxide and forms a silicious silicate or fusible cinder, part of which floats off, while part remains incorporated with the iron and is largely expelled in the subsequent working. Complete reduction of the ore is never attainable in low furnaces, and the loss of iron is greater the more silicious the ore. Rich ores consequently are the best adapted to the process. The iron produced in low furnaces is generally of low quality, because the impurities of the ore, being reduced at the comparatively low temperature which prevails, pass off in the slag. But the iron is apt to lack uniformity of structure and in composition. The tendency is to increase the height of the furnace, in order to increase the yield and thereby reduce the cost, was thwarted by the production of a fluid iron, which was probably first made as a waste product, since no method of utilizing it was known. The absorption of carbon by the iron and its conversion into steel or cast iron, which is readily fusible depend mainly on the heat of the furnace, and this in turn depends on the amount and pressure of blast. Increasing the height of a furnace necessitated a corresponding increase in the diameter of the blast to overcome the resistance of a column of material; and carburization of the iron necessarily follows. The progress of the iron industry from the low furnaces and to the modern high furnaces was therefore inevitable; and it was not until the art of making cast iron and the method of converting cast iron into wrought iron were discovered, that modern metallurgy took its rise. According to tradition, cast iron was known in Holland in the 15th century, and stove plates were made in Alsace in 1400. Ancient ornaments of iron have been found in Sussex, England, and have been referred by Lower to the

14th century; but Karsten says that the systematic production of iron for foundry purposes cannot be traced with certainty to an earlier period than the end of the 15th century. According to Lower, the first cast-iron cannon made in England were cast by Ralph Hogge in 1548. Up to the year 1595 Thomas Johnson had made for the earl of Cumberland 42 cannon weighing three tons apiece. The method of converting cast into wrought iron, by exposing the fluid iron to a blast of air, was discovered very early. It is mentioned distinctly by Agricola, who died in 1555; but the regular manufacture of wrought iron by this method began some time later. In Styria, where the pure spathic ores have been regularly smelted since the year 712, there were in 1625 19 *Stücköfen* or *Wolföfen* (shaft furnaces 10 to 16 ft. high), producing mainly malleable iron, which was taken from the furnace in a mass (*Stück* or *Wolf*). The process lasted about 18 hours, and the weight of the mass often reached 1,800 to 1,400 lbs. There was also produced at the same time more or less fluid carburized iron. The form of the furnace resembled two truncated cones placed base to base, a construction which has been retained to a great extent to the present day. In 1760 so-called *Flossöfen*, 25 ft. high, were introduced, and white pig iron was regularly and continuously made. This iron was subsequently decarburized and converted into wrought iron in charcoal hearths. From this time the *Stücköfen* gradually disappeared. They lingered in some localities for a long time owing to the demand which still continued for *Stücköfen* iron, than which nothing could be purer; but finally, during the early part of the present century, they had entirely ceased to exist. The *Flossöfen* gradually enlarged into the *Blauoöfen* or *Blaseöfen*, of which there were 34 in Styria in 1864. These furnaces are from 28 to 46 ft. high, and differ from the modern blast furnace mainly in having a closed breast with tapping openings for iron and cinder, while the blast furnace has an open fore hearth, originally designed doubtless to permit the dipping out of fluid iron for castings, and now generally retained on account of the facility of access it gives to the interior of the hearth of the furnace, in case obstructions or deposits have to be removed. Of late years the closed front has been adopted in many large blast furnaces with success; but the fore-hearth construction is still the prevalent one. Increasing the height of the furnace and the strength of the blast had for its immediate effect the more perfect extraction of the iron and a decided economy of fuel. The addition of lime as a flux to silicious ores likewise facilitated the complete extraction of the iron. The cinder thus produced, instead of being rich in iron, as was previously the case, contained only the earthy ingredients of the ore with but a trace of iron. The cinders produced in low furnaces were for a long time successfully smelted in the *Blauoöfen*.—In

England the birth of the iron manufacture dates back to the days of the early Britons, and relics of the iron smelting of the Romans are abundant. In the 16th century the iron manufacture had increased to such an extent that, in order to check the rapid destruction of the forests, restrictions were laid on the cutting of wood for charcoal, by laws enacted in 1558, 1581, and 1584. As a consequence the iron manufacture declined, until in the early part of the 18th century there were but 59 iron works in the country. The supply of iron at this time was mainly from Russia, Sweden, and Spain. Numerous attempts were made to use mineral or pit coal for smelting iron, and patents for alleged discoveries were freely granted; but no manufacture based on mineral coal was established till 1619, when Dud Dudley obtained his patents. He successfully carried on the manufacture for many years, making iron cheaply and of good quality; but, being much persecuted by envious rivals, he finally succumbed to his misfortunes, and dying left no record of his invention behind. It was not till 1735 that the next successful attempt was made to use mineral coal. At that time the difficulties of the case were again conquered by Abraham Darby, who, before using the coal in the furnace, submitted it to the same process as wood undergoes in its conversion into charcoal; in other words, he converted the coal into coke. From this time the progress of the English iron industry was rapid. In the century following Darby's discovery, bellows gave way to blowing cylinders, and water power to steam, which greatly increased the efficiency and yield of the furnace; while the application of the hot blast by Neilson in Scotland, and the utilization of the waste gases by Aubertot in France, added vastly to its economy of working. —The blast furnace consists of a vertical shaft of circular section lined with fire brick. The lowest part is ordinarily in the form of a cylinder, and is known as the hearth. In the masonry of the hearth are built the tuyeres (two to eight in number), which are hollow truncated cones of metal supplied with a constant current of cold water. Into these tuyeres project the nozzles of the pipes that supply the blast. The part of the hearth below the tuyeres is called the crucible; in it the iron and slag accumulate until tapped off. The hearth is prolonged toward the front of the furnace (fore hearth), and is closed by the dam and covered in by the tympan arch. At the bottom of the dam is a channel communicating with the bottom of the crucible through which the iron is tapped off, and on the upper edge of the dam is a notch (cinder notch) over which the cinder flows. The tympan arch is covered by the tympan, a long hollow casting through which water circulates. The sloping walls connecting the hearth with the widest part (belly) of the furnace are called the boshes, the angle which they form with the horizontal line being called the angle of the boshes. In many furnaces the

hearth expands into and is continuous with the boshes. From the widest part of the furnace the walls usually slope inward toward the mouth, which may be either permanently open, or provided with a mechanical arrangement by which it is kept closed except during charging. There are openings in the walls of the furnace, close to the top of the stack where it is closed, and some distance down where it is open, to conduct off the escaping gas. Until comparatively recently furnaces were built entirely of masonry, the outer walls consisting of massive stone work. At the present day this heavy construction has been almost entirely superseded by slender stacks encased in brick work and surrounded by sheet iron. In building a blast furnace, the main body of the shaft is supported on pillars, usually of cast iron, and is entirely independent of the boshes and hearth, which are put in subsequently, and can be removed and repaired without interfering with the upper portion of the furnace. In the Böttgenbach system of construction the main shaft consists of one layer only of fire brick 18 in. thick, without outer casing of any kind. The charging floor on the top of the furnace is supported by hollow cast-iron columns, which serve also to conduct down the gas to the stoves. This construction is mainly recommended by its cheapness. The dimensions of blast furnaces vary greatly. The height ranges from 30 to 100 ft., the greatest diameter from 6 to 30 ft., and the capacity from 500 to 40,000 cubic feet. The relative dimensions of hearth, boshes, and throat likewise vary greatly. The cause of this great variation in dimensions is partly due to differences in ores and fuels, and partly to the fact that there are no fixed principles of blast-furnace construction that have found general acceptance. The more refractory the ore and the more dense the fuel, the larger, as a rule, is the furnace; but as to the proper outline of the interior there is great difference of opinion. Most metallurgists are so far agreed as to have abandoned the flat boshes, narrow mouths, and abrupt changes of outline of the older furnaces; but further than this there is no uniformity in modern blast-furnace construction. The following are some of the considerations which should determine the dimensions and outlines of blast furnaces. The temperature attained in the hearth, upon which the nature and quality of the iron depend, is the result of a number of factors, such as pressure or penetration of blast, character and amount of fuel, and diameter of hearth. The last is readily fixed when the others are known. The regular working of the furnace depends in a great measure on the regular descent of the charges. Now, as the charge diminishes in bulk in descending, owing to the reduction of the iron and the combustion of the fuel, the capacity of the furnace should diminish correspondingly; that is, the walls should taper downward. The amount of this tapering, or, in other words the angle of the boshes, should

respond to the rate of the shrinkage, which is more rapid as the charge approaches the hearth. This principle is generally recognized; it is applied in practice to the lower part of the furnace only. It seems rational to suppose that advantage would result by applying this principle to the whole length of the furnace, and making the greatest diameter correspond to the part where the charge occupies the greatest bulk, namely, at the mouth. The difficulty of properly distributing the charges over a large mouth is however at present a practical objection; and it may be also that the reaction in the upper zone of the furnace, by which iron is deposited, would be unfavorably affected by such a construction. The height

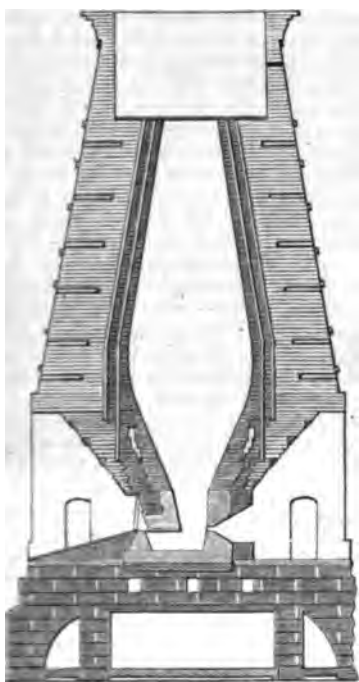

FIG. 1.

of the furnace depends primarily on the nature of the charge. If this is disposed to crumble, a furnace composed of fine particles that might be blown out and impede the passage of the blast, a blast furnace would be inadmissible; but, other things being equal, the higher the furnace the greater is its yield and economy of working, the reducing gases are more thoroughly intercepted and utilized. Fig. 1 is a vertical section through the fore hearth of a German blast furnace built entirely of masonry. Its height is 56 ft. and greatest diameter 14 ft. Fig. 2 is a vertical section of a blast furnace at Chicago. It is 66 ft. high and 17 ft. in greatest diameter. The top is closed by a "bell and hopper." The right column at the side is the gas conductor. Fig. 3 is an elevation of the same furnace show-

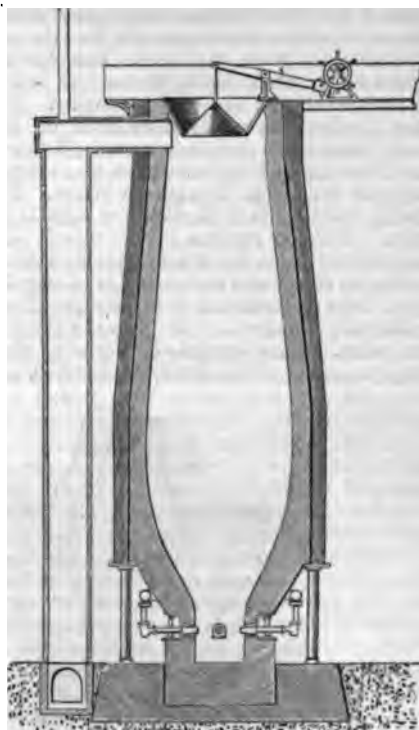

FIG. 2.



FIG. 3.

ing the sheet-iron casing.—The essential accessories of the blast furnace are the blowing engines, hot-blast ovens, and hoist. The blowing engines are of three kinds, the vertical beam, the horizontal, and the upright engine. The latter has been generally introduced of late years, owing to its compactness and efficiency. One of the largest blowing engines ever erected is a beam engine at Dowlais in Wales. The blowing cylinder is 12 ft. diameter with 12 ft. stroke. With 19 strokes per minute it discharges 51,528 cub. ft. per minute at a pressure of 3 lbs. to the square inch, capable of supplying six large furnaces and four fineries. From the blowing cylinders the air passes to the hot-blast ovens. These consist of a series of cast-iron pipes, arranged in a fire-brick chamber, and

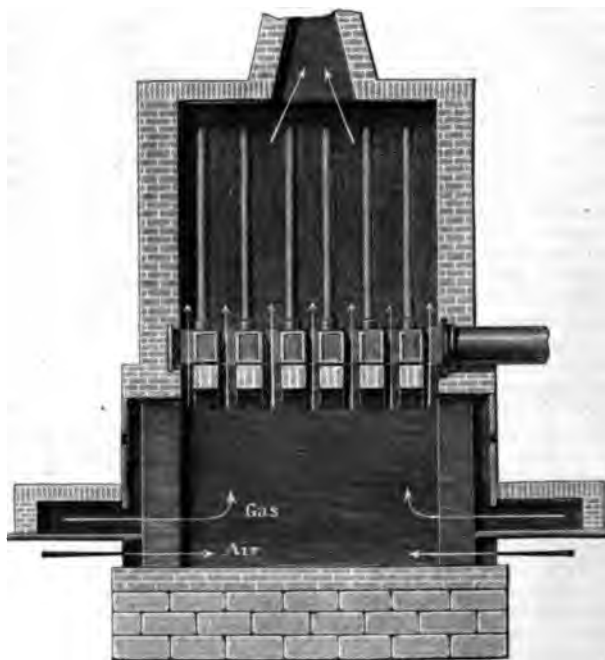

FIG. 4.

heated by the combustion of the gases drawn from the top of the furnace. The gases are generally burnt in a special combustion chamber, and the products of combustion only pass into the chamber containing the pipes. Equable heating without danger of injury to the pipes is thus effected. This arrangement is shown in fig. 4. Recently Siemens's system of regenerative heating (see FURNACE) has been applied to hot-blast stoves, and a much higher temperature of blast attained than could be produced by the simple combustion of the gas. Whitwell's and Cowper's stoves are both constructed on this system. The former are being extensively adopted. They consist of two "regenerators" of fire brick, which are heated alternately by the combustion of the furnace

gases. While one is heating, the blast passes through the other, and the currents of air and gas are changed at intervals of about half an hour. The temperature of the blast ordinarily employed varies greatly. A few furnaces are still blown with cold blast, where it is desired to produce an iron of superior quality; but usually the blast is heated from 500° to 1000° F. The hotter the blast, the sooner the pipes in the ovens burn out, and therefore the temperature rarely reaches 1000° with iron pipes. In Whitwell's stoves a temperature of 1550° may be obtained; but it does not generally rise above 1200° or 1400°. The pressure of blast varies from 1 lb. per inch to 5 or 6 lbs. Charcoal furnaces are usually blown with the lowest pressure, anthracite furnaces with the

highest, and coke furnaces with a pressure of 3 or 4 lbs. Occasionally furnaces are situated on a hillside, and the stock of ore and fuel is on a level with the mouth of the furnace; but ordinarily lifts or hoists are required to raise the materials of the charge from the ground to the top of the furnace. There is a great variety of lifts, embracing among others the hydraulic, the pneumatic, and the steam lift.—The blast-furnace process, expressed in its simplest form, is as follows: The furnace is charged with ore, fuel, and limestone, which gradually descend the shaft as the smelting proceeds. The air of the blast, on coming in contact with the incandescent fuel, is converted into carbonic acid gas, but, speedily taking up another atom of carbon, is reduced to carbonic oxide, which, together with the inert nitrogen of the air, rises through the descending charge, abstracts the oxygen of the ore, and passes out of the mouth as carbonic acid. When the reduced iron

reaches the vicinity of the tuyeres, it takes up carbon, melts, and drops down into the crucible of the furnace, while the earthy ingredients of the ore, flux, and fuel unite and form a solid cinder, which likewise drops into the crucible and floats on the top of the molten iron. At regular intervals the iron is tapped off into moulds of sand or iron, where it cools in "pigs." The foregoing expresses merely the general progress and final results of the blast-furnace process. In practice it has been found that the changes which take place are very complicated and involved, and depend on a great number of conditions. The phenomena of iron smelting have recently been the subject of searching investigation; and we are mainly indebted for our present knowledge

The studies of Bell in England, Tunner in Austria, Akerman in Sweden, and Gruner in France. What follows contains the principal results of these investigations, especially those of Lowthian Bell, which have been the most decisive and the most fruitful of valuable conclusions. The mutual reactions of carbon, carbonic acid, carbonic oxide, metallic iron, and oxide of iron are expressed in the following formulas:

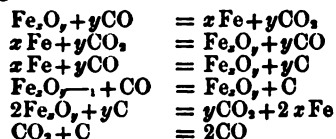

These reactions show that carbonic oxide not only abstracts oxygen from oxide of iron, but also imparts oxygen both to metallic iron and to its lower oxide; that carbonic acid, which results from the reduction of iron by carbonic oxide, may also oxidize metallic iron; and that carbonic acid is capable of taking up a second atom of carbon. The nature of the reaction in any given instance is dependent mainly on the temperature, and also on the relative proportions of the gases. The taking up of carbonic oxide and the deposition of its carbon was discovered by Bell. The conditions governing this remarkable reaction have been studied by him and by Gruner.

The following are the results of Gruner's experiments on this point: On passing carbonic oxide over a fragment of iron ore at a temperature of 300° to 400° C. (572° to 752° F.), the ore is gradually reduced, the reduction proceeding from the surface to the interior of the mass. When metallic iron is formed on the surface, the ore cracks and expands, and becomes covered with a fine deposit of carbon. As carbon deposition diminishes as the reduction of the ore proceeds; and were it possible to effect complete reduction in this way, it would finally entirely cease. Pure carbonic oxide is not decomposed by metallic iron at -400° C.; but when the carbonic oxide is mixed with carbonic acid, deposition of carbon takes place. The amount of the CO<sub>2</sub> must not, however, exceed 1 volume to 2 volumes of CO. The deposited carbon is not pure, but contains 7 per cent. of metallic iron, and also some oxide of iron, mainly magnetic. The formation of this deposit of ferruginous carbon is the result of the mutual reaction of two molecules of carbonic oxide, whereby 2CO = CO<sub>2</sub> + C; but it is absolutely necessary that there should be present simultaneously metallic iron or ferrous oxide, the former to fix the carbon and the latter to hold for an instant the oxygen, and then to give it again by the action of carbonic oxide. The following formulas express the reactions: C + O + CO = Fe<sub>2</sub>O<sub>3</sub> + C, and Fe<sub>2</sub>O<sub>3</sub> + CO = FeO + CO<sub>2</sub>; and so on indefinitely, provided that the reducing action of carbonic oxide is counteracted by a certain amount of carbonic acid.

If the temperature is raised to a red heat the deposition ceases, and the carbon already deposited unites with the remaining oxide of the ore. It is probable that the deposited carbon plays an important part in the final reduction of the ore in the blast furnace. The dissociation of carbonic oxide (2CO = CO<sub>2</sub> + C) is accompanied with a development of heat, every unit of carbon deposited corresponding to an evolution of 3,184 heat units.—The temperature at which the iron ore begins to lose oxygen in the blast furnace depends on the molecular constitution of the ore and the relative amount of carbonic oxide in the gas. Bell has found that the temperature of incipient reduction of oxide of iron by pure carbonic oxide varies from 141° C. (285° F.) to 208° C. (407° F.), according to the nature of the oxide or ore. The temperature at which carbonic acid begins to oxidize metallic spongy iron was found by him to be about the temperature of melting zinc, 417° C. (782° F.). In both cases the energy of the action is promoted by increasing the temperature, but the oxidizing action of the carbonic acid increases in a greater ratio than the reducing action of the carbonic oxide. The point of equilibrium of the two gases toward metallic spongy iron at different temperatures was found to be:

Low red heat.....	150 vols. of CO <sub>2</sub> for each 100 vols. of CO.
Full red heat.....	47 " " " "
Approaching whiteness.....	11 " " " "

The point of equilibrium of a mixture of carbonic oxide and carbonic acid toward oxide of iron depends likewise on the temperature, and also on the molecular structure of the oxide. At a red heat a mixture of 100 volumes of carbonic oxide and 600 of carbonic acid is nearly neutral to calcined Cleveland ore, while at 417° C. the point of equilibrium is found in a mixture containing 100 volumes of carbonic oxide to 50 of carbonic acid. Again, a mixture of equal volumes of carbonic acid and carbonic oxide at a temperature of 417° C. is found to reduce *Eisenerz* spathic ore actively. The temperature at which carbon (coke) begins to decompose carbonic acid is, according to Bell, 410° C. (770° F.).—The composition of blast-furnace gases at different levels of the furnace has been investigated by a number of observers. The following analyses are by Bell and Tunner:

Wear Furnace, 80 ft. High. Capacity, 17,500 cub. ft. Consumption per ton of iron, 23.5 cwt. of coke and 12.8 cwt. limestone. Ore, roasted carbonate. (Bell.)

LEVELS.	BY VOLUME.			BY WEIGHT.		
	N.	CO.	CO <sub>2</sub> .	N.	CO.	CO <sub>2</sub> .
At mouth.....	60.57	29.99	9.44	56.9	28.2	14.9
16½ ft. from top....	65.46	31.66	2.84	64.8	30.3	4.4
26 " " ".....	67.09	28.54	4.37	65.5	27.3	6.7
39 " " ".....	65.76	31.98	2.26	64.9	31.6	3.5
52½ " " ".....	64.48	34.66	0.91	64.5	34.1	1.4
65 " " ".....	65.05	34.64	0.31	64.9	34.6	0.5
70½ " " ".....	65.22	34.73	.....	65.2	34.5	0.0
76½ " " " at the tuyeres.....	62.76	35.59	1.65	62.7	34.7	2.6

Widna Furnace, 86 ft. high. Capacity, 1,300 cub. ft. Consumption, 14 cwts. of charcoal per ton of iron. (Turner.)

LEVELS.	BY VOLUME.				BY WEIGHT.			
	H.	N.	CO.	CO <sub>2</sub> .	H.	N.	CO.	CO <sub>2</sub> .
At mouth...	5.61	56.82	24.40	18.67	0.39	54.90	28.51	20.90
18 ft. from top	18.89	50.47	24.21	11.98	1.01	58.38	25.82	19.79
25 1/2 " "	8.98	56.71	25.92	13.44	0.27	54.57	24.87	20.29
28 " "	8.45	56.48	27.95	12.12	0.24	55.00	26.26	18.50
22 " "	2.91	56.62	28.42	12.65	0.20	54.34	27.82	18.14
24 1/2 " "	1.54	57.52	28.00	2.94	0.11	57.85	27.98	4.61

The hydrogen in the gases from the Wear furnace was not determined; it is never present in large quantity, and plays no important part in the blast-furnace process. Hydrocarbons and cyanogen are also sometimes present in small quantity. The former are abundant in the upper part of the furnace, when raw bituminous coal is used. It will be noticed in the above analyses that the escaping gases still contain a considerable amount of carbonic oxide. An ideal furnace process would be one in which the carbonic oxide was completely utilized, and only carbonic acid escaped from the furnace. From the experiments of Bell, quoted above, it is evident that such a condition is practically impossible; yet the relative amount of carbonic oxide is a measure of the economy of working. Formerly the gases were allowed to burn at the mouth of the furnace; now they are invariably utilized, either wholly or in part, to heat the blast, raise steam for the blowing engines, or roast ores. The gases likewise possess a certain amount of sensible heat, from which also the economy of working may be judged. The ultimate practical economy of fuel that can be attained in the furnace is reached when the gases contain such a relatively small amount of carbonic oxide that they are no longer capable of reducing the ore at the temperature at which they leave the furnace.—In the year 1829 there were used in Scotland about eight tons of coal in the form of coke to produce one ton of pig iron; at the present time in Cleveland the consumption of coal is but 33 cwts. per ton of iron. This great economy of fuel has been reached by increasing the dimensions of the furnace, by complete utilization of the carbonic oxide in the escaping gases, and by the use of heated blast. Increasing the height and diameter of the furnace prolongs the contact of the charge with the hot reducing gases, whereby the sensible heat of the latter is more completely transferred to the descending materials, and the reducing power of the carbonic oxide is more thoroughly utilized. Widening the throat and mouth of the furnace has the same effect, by decreasing the rapidity of the gaseous current. It would at first sight appear that the dimensions of the furnace could be so far increased as to intercept the total amount of sensible heat. This is found not to be the case in practice. Bell has shown by experiment that the temperature of the gases at the mouth of a

furnace having a height of 80 ft. and a capacity of 12,000 cub. ft. is not materially higher than that of gases from furnaces 108 1/2 ft. high with a capacity of 33,000 cub. ft. The cause of this has been shown by Bell to be, that there is a constant source of heat production in the upper part of the furnace, caused by the reduction of the ore and the deposition of carbon; and increasing the height of the furnace merely serves to raise this zone of reduction. From the reduction of the ore by carbonic oxide, the heat development is very small, as a given weight of oxygen uniting with iron or carbonic oxide produces in either case nearly the same amount of heat. According to Dulong, one litre of oxygen gas gives 6,216 units of heat when it combines with iron, and 6,260 when it combines with carbonic oxide. But the heat development by the dissociation of carbonic oxide, as described above, is 3,134 heat units for each unit of carbon deposited. The utilization of the carbonic oxide in the gases for heating blast or boilers directly effects a saving of a corresponding amount of coal. The saving of fuel consequent on heating the blast is very marked. The cause of this saving was for a long time sought in vain. On the first introduction of the hot blast in Scotland it was found that by burning 5 cwts. of coal to heat the blast to 450° F. there was effected a saving of 47 cwts. of coal in the furnace; and by burning 8 cwts. of coal, to heat the blast to 612° F., the saving was 83 cwts. or 69 per cent. Experience has shown that the economy of fuel attained by the use of hot blast depends on the height of the furnace and on the reducibility of the ore. The higher the furnace and the more susceptible the ore to the reducing action of carbonic oxide, the smaller is the saving of fuel effected. The enormous saving shown in the Scotch furnaces was due to the fact that both conditions were favorable to the use of hot blast, viz.: the furnace was low and the ores were refractory. The economy of fuel by hot blast in modern high blast furnaces does not often exceed 10 to 12 cwts. of coke per ton of pig iron. The ideal working of the blast furnace is as follows: A certain amount of fuel is burned before the tuyeres, and generates enough heat to melt the reduced iron and the cinder. The carbonic oxide, which is the end result of this combustion, ascends through the ore, which it reduces to metallic iron, and passes out of the furnace as carbonic acid. It is found, however, that the minimum amount of fuel that will melt the iron and cinder does not, under the conditions that obtain in the blast furnace, supply sufficient carbonic oxide to do the work of reduction. It has further been found that the rapidity of the reduction of the ore depends on its molecular constitution, or the proportion that carbonic oxide bears to carbonic acid in the gases, and on the temperature. Let it be supposed that in a blast furnace working with a given quantity of fuel, a certain ore requires

s for complete reduction, while an- requires fourteen hours. If it is d to smelt the refractory ore so as to duction equal to that afforded by the is necessary either to give it four- exposure or to increase the rapidity on. The first of these conditions is ed by doubling the height of the rd the second by increasing the tem- ough the use of more fuel. In the there is no more heat utilized, in e greater amount of fuel, than when e easily reducible ores, presuming ave approximately the same compo- is merely the rate of reduction that d; and the excess of heat passes off ping gases. Of these two methods g refractory ores, the latter was the ad until a comparatively recent peri- ecreased height of furnace was found e same result. As an instance may Scotch furnace 53 ft. high and using f coke per ton of iron produced from . By adding 18 ft. to the height it of fuel was reduced to 28 cwts. in Sweden was the first to suggest roably the principal cause of the n using hot blast. The heat which d by the combustion of the fuel in e is contained in the carbonic oxide d in the accompanying nitrogen, eat that is conveyed by the blast is ad with the development of any gas- ets, and does not therefore increase f the gases in the furnace. Now, as ture of the gases is inversely as it follows that the temperature of e must be higher when using hot the rate of reduction corresponding. Further, the rapidity of the upward ll be diminished, and the more thor- be the reducing action of the car- e. It has been shown that increas- ht of the furnace beyond a certain erves to raise the zone of reduction, ot cause further saving of fuel. The limit of temperature of the blast is hen the amount of fuel consumed in e is so far replaced by the heat in that the carbonic oxide formed is ent to do the work of reduction. has never been reached in practice; nificant circumstance has been no- e rate of saving for a given number decreases as the temperature of the sed.—From the above it will be evi- the ultimate practical economy of ble in blast furnaces depends on a conditions. In the Cleveland dis- and, where the furnaces have attain- dimensions and the blast is heated 60° F., the lowest consumption of n of No. 3 pig (see Iron) is about while at the Wrba furnace in Aus- is but 36 ft. high, and where the e of blast is 752° F., the consump-

tion of charcoal is but 13·20 cwts. per ton of iron. The daily production of furnaces is dependent on the same conditions as determine the consumption of fuel, and also on the rate of driving of the furnace, *i. e.*, the amount of blast in a given time. The extremes are small charcoal furnaces yielding but 4 to 5 tons per day, and large furnaces yielding 80 tons per day. The absolute amount of heat produced in the blast furnace, the amount absorbed in work done, and the amount lost by radiation and in the gases, have been calculated by a number of authorities. The following is Bell's estimate expressed in cwt. heat units per ton of iron produced:

HEAT PRODUCTION.

Oxidation of carbon.....	81,536 units.	
Contributed by blast.....	11,919 "	
		98,455

HEAT ABSORPTION

Evaporation of water in coke.....	312 units.	
Reduction of iron.....	33,108 "	
Carbon impregnation.....	1,440 "	
Expulsion of CO <sub>2</sub> from limestone.....	5,054 "	
Decomposition of this CO <sub>2</sub> .....	5,348 "	
" " water in blast.....	2,720 "	
Phosphorus, sulphur, and silicon re- duced.....	4,174 "	
Fusion of pig iron.....	6,600 "	
" " slag.....	16,720 "	
		75,376

HEAT LOSS.

Transmission through walls of furnace.	3,658 units.	
Carried off in tuyere water.....	1,818 "	
" " gases.....	8,860 "	
Expansion of blast, loss from hearth, &c.	3,743 "	
		18,079
		98,455

—Occasionally ores occur which contain the proper proportion of earthy matters to form a fusible slag (self-fluxing ores). When this is not the case, the substances in deficiency must be added; and this may often be advantageously accomplished by mixing ores of different characters. In the large majority of cases, limestone is added as flux, since most ores contain silica and alumina, which with the lime form a fusible slag. It is a matter of great importance that the composition of the ores and fluxes should be accurately determined, in order that a slag (cinder) may be formed of the desired fusibility. Blast-furnace slags are usually double silicates of alumina and lime, in which the latter is often partially replaced by magnesia, oxide of manganese, and (when the reduction is incomplete) by protoxide of iron. The fusibility increases with the amount of silica, up to about 60 per cent. of the latter, and decreases with the amount of lime. Basic slags are white and stony in character, and require a very high temperature for fusion. The conditions in the furnace producing such a slag are therefore favorable to the complete reduction of the ore and the formation of a highly carburetted siliconized iron. Basic slags also take up sulphur in considerable quantities. White iron is generally accompanied with a more acid cinder, which sometimes contains

considerable oxide of iron. When this is the case, it is called a scouring cinder. The following analyses show the composition of several varieties of blast-furnace slags:

ELEMENTS.	1	2	3	4	5
Silica.....	35.48	43.07	27.65	42.17	61.06
Alumina.....	15.18	14.55	24.69	13.59	5.88
Lime.....	82.72	25.92	40.00	33.02	19.81
Ferrous oxide.....	0.76	2.53	0.73	1.23	3.29
Manganese oxide.....	1.62	1.37	0.35	0.27	2.63
Magnesia.....	7.44	6.87	3.55	5.81	7.12
Sulphide of calcium.....	2.22	1.90	1.95	0.64	.....
Alkalies.....	1.92	1.84	1.45	.....	.....
Phosphoric acid.....	0.15	.....	0.26	.....	.....
Total.....	100.54	100.85	100.62	99.23	99.29

Nos. 1 and 2 are from raw coal, used at Dol-lais, Wales, the first making gray, the second white iron; 3, coke, at Clarence, England, making gray iron from Cleveland ores; 4, anthracite, at Boonton, N. J., making gray forge iron; 5, charcoal iron, at Gosberg, Sweden. Slags are classified, according to the ratio which the oxygen of the silica bears to the oxygen of the bases, as tri-, bi-, mono-, and subsilicates. According to Bodemann, the most fusible silicate of lime and alumina is a bisilicate of the following composition: silica 56 per cent., lime 30, alumina 14. Blast-furnace slag is almost entirely a waste product, and one that is very difficult to dispose of. Acres of valuable land are often sacrificed as a dumping ground for it. Many attempts have been made to utilize it, and with considerable success. Building brick, paving stone, hydraulic cement, sand for mortar, &c., have been successfully made; but no regular manufacture has yet been introduced that can work up even a minute fraction of the ever-increasing slag production of the world.—WROUGHT IRON is either made directly from the ore or from pig iron. In the former case the process is one of reduction of the iron from its oxide; in the latter it is one of oxidation of the carbon, silicon, &c., of the pig iron. Although the iron produced in low furnaces and bloomeries is usually of great purity, yet owing to the small production and the waste of iron, and the necessity of rich ores and charcoal, the direct process has almost entirely disappeared from civilized countries, as it is not able to compete commercially with the indirect production of wrought iron from pig. (See BLOOMERY.) The conversion of pig into wrought iron is effected either in a hearth similar to a bloomery or in a reverberatory furnace. The nature of the process is the same in both cases, and consists in the oxidation of the silicon, manganese, carbon, phosphorus, sulphur, &c., in the pig iron, by the oxygen of the air, and also by that of oxide of iron. The latter is generally added as such, but is always formed in the process itself. The oxygen in the solid form is the most active, since it can be intimately incorporated with the iron, while the oxygen of the air merely acts on the surface of contact.

The order in which the foreign substances in the pig iron are removed is that in which they are named above; or, more especially, all these substances are oxidized coincidentally, but the rate of oxidation is in the order given. The iron is also promptly oxidized, and forms with the silica resulting from the oxidation of the silicon a basic iron silicate, or cinder, which reacts on the carbon and silicon remaining, converting them into oxides, while an equivalent amount of metallic iron is reduced. Iron thus serves as a carrier of oxygen to the non-metallic elements. This interchange of elements continues until the iron is nearly or quite decarburized. Manganese, if present in the pig iron, may replace the iron in the cinder, but it does not act in the same manner as a carrier of oxygen. The hearth process, now almost exclusively confined to the mountainous region of southern Europe, Sweden, and South Wales, was previous to the latter part of the last century the method universally employed for the conversion of pig iron. The process is a very simple one. The iron is melted with charcoal and exposed while molten to the direct action of a blast of air from one or two inclined tuyeres in the side of the hearth. The iron gradually loses carbon, silicon, phosphorus, &c., and is converted into a pasty lump or bloom which is hammered into slabs. The process in its essential features is the same everywhere, but owing to slight variations in construction of hearth or in the details of manipulations it has received a great variety of names. In Sweden there are three methods employed, the Walloon, the Franche-Comté, and the Lancashire. The latter, which is the one most generally used and most economical of fuel, will be briefly described. The hearth is quadrangular, and formed of cast-iron plates. The tuyere side is slightly inclined inward, the opposite side and the back are inclined outward, and the front is vertical. The bottom plate is cooled by running water. The blast is supplied by one or two tuyeres at a temperature of 210° to 330° F., and at a pressure of 1 to 1½ lb. per square inch. The waste heat from the hearth is used to heat the blast and also the pig iron previous to charging. The manipulation consists in piling up the already heated pig iron to the amount of 200 to 350 lbs. on the burning charcoal, and melting down. As the molten metal drops past the blast it is partially oxidized, and the oxide thus formed, together with the rich basic cinder remaining from the previous operations, act with the blast in decarburizing the iron. The imperfectly refined iron, which sinks to the bottom, is broken up with an iron bar and brought repeatedly before the tuyere, until the iron is rendered thoroughly soft and malleable. Finally, a high heat is given, and the iron is collected in a mass or bloom in the bottom of the hearth. It is then taken out and forged under a trip-hammer to a prismatic shape. The process lasts about 1½ to



The yield of blooms is about 87 per cent per pig iron, and the consumption of iron is about one ton to a ton of blooms. The iron is usually heated in a gas furnace and forged in a hammer. All the Swedish bar iron used for conversion into steel is made in Sweden, except that from Dannemora, made by the more expensive Walloon process. The latter consumes three tons of pig iron to a ton of blooms, with a yield of about 80 per cent. Formerly the process of refining iron previous to its conversion into steel was extensively employed, but this practice is falling into disuse. In Sweden, the process consists in exposing the molten pig iron to a rectangular hearth to blasts of air from two or three tuyeres on each side. The process is in all respects similar to that described, but is interrupted before the carbon is removed, and while the metal is still molten. The metal is cast out on an iron plate, where it is rolled into plates about 3 in. thick. Gray iron is refined in the refining or running-out process, the change that is effected consisting in the removal of the greater part of the silicon and a little of the carbon, resulting in refined or "fine" metal which is cast into wrought iron than the gray pig.—Puddling consists in heating iron on the bed of a reverberatory furnace heated by flame, in which it acts actively in an oxidizing atmosphere, until it has become malleable. The process was first successfully introduced by Henry Cort in England in 1784. Although others, notably the Earl of Cranage in 1766 and Peter Onofrey in 1783, had plainly indicated in their patents the essential operations of the process, yet to Cort belongs the credit of having made the process a practical one. For some time puddling was done on a sand bottom, which made the operation tedious, and caused great loss of iron by the formation of an excess of cinder. In 1818 Samuel B. Percey introduced iron bottoms, by the use of which the production of the furnace was greatly increased, and the waste of iron lessened. When a puddling furnace is used, the iron is covered with a thick layer of cineraceous slag, and exposed for some time to an oxidizing atmosphere, so as to form a refractory lining. The essential operations in a puddling furnace are the fireplace, the hearth, and the flue. The fireplace is from one third to two thirds the size of the hearth. The heat of the fire is effected by a high blast of air, and often there is a blast under the hearth. The fuel is either bituminous coal or anthracite used as fuel. The hearth is generally rectangular or oval. It is formed of a bottom of cast iron, and ends of firebrick and the flue bridges. The

side castings are hollow, as are also the bridges, to allow of a circulation of air for cooling. There are recesses in the side castings, in which is put the fix or fettling, which is either rich iron ore or roasted cinder. The waste heat passing off in the flue is usually utilized to heat steam boilers. Fig. 5 shows a vertical and horizontal section of a puddling furnace with steam boiler. Sometimes puddling furnaces are built of double the usual size, with a working door on each side. In these the charge is twice the usual amount, and two puddlers work together. There is a great variety of puddling furnaces, built mainly with a view to economize fuel or to better regulate the combustion. Gas furnaces have never come into very general use for puddling. The pig iron used for puddling is mostly the lighter gray

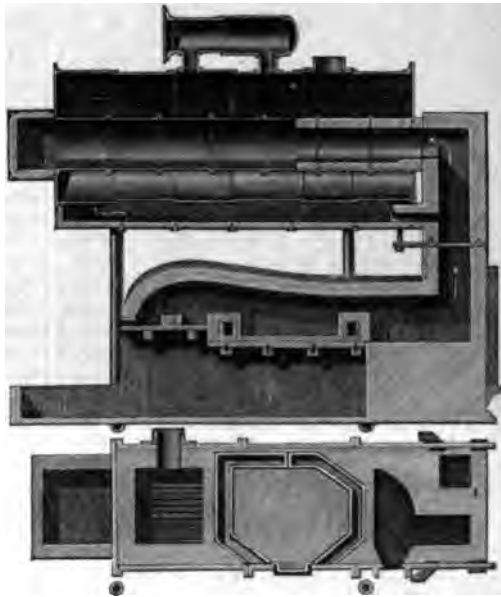

FIG. 5.

iron and white iron. The highly graphitic varieties are apt to be rich in silicon, which makes a large amount of fluid cinder, prolongs the operation, and causes great loss of iron. Gray iron requires a high temperature for fusion, but becomes thinly fluid, while white iron is sluggish when melted. The former therefore generally yields an iron of better quality, as it can be more thoroughly worked. The puddling process may be divided into four stages: 1, melting down the charge; 2, incorporation of the fettling; 3, boiling; and 4, uniting the soft iron to balls. When the charge is completely melted, it is stirred to render it uniform. The temperature is then somewhat lowered in order to allow the cinder which has formed on the surface and the oxide of iron of the fettling to be thoroughly incorporated with the iron. The temperature is then raised again,

and the mass of metal begins to "boil" from the escape of carbonic oxide, which burns with a blue flame on the surface. Finally the ebullition becomes less rapid, and little bright points of soft iron appear. The iron is then said to "come to nature." The stirring or rabbling is continued incessantly, to prevent the formation of lumps of imperfectly decarburized iron. When the operation is complete, the puddler forms a number of balls of the pasty iron, of about 60 to 80 lbs. each. As soon as the balls are formed, the damper is lowered in order to prevent the waste of iron by burning. During the whole course of the puddling the working door remains closed, and the rabbling tools are introduced through a small notch in the lower side of the door. When the balls are ready for removal, the door is opened and the balls are taken singly to the hammer or squeezer. The duration of the process is from  $1\frac{1}{4}$  to  $1\frac{1}{2}$  hour, the loss of iron 10 to 15 per cent., and the consumption of fuel from 16 to 30 cwts., according to character of fuel, size of charge, &c. Sometimes the term puddling is restricted to the working of white or nearly white iron in a furnace without fettling, and the term boiling is applied to the process described above. Such boiled iron is, other things being equal, superior to puddled iron. As the oxidation of the carbon and silicon is mainly effected by the oxide of iron of the fettling, there should be a gain of malleable iron over the pig iron charged, instead of a loss; since for every 18 parts of carbon removed from the pig iron 56 parts of iron are reduced from the oxide, and for every 42 parts of silicon removed there are also 56 parts of iron reduced. In the ordinary puddling furnace, however, with the strongly oxidizing atmosphere, the loss of iron more than compensates for this gain. Siemens has succeeded, in his gas furnaces, in obtaining a yield of wrought iron equal to the weight of pig charged; but Danks, in his rotary puddler, described below, has obtained nearly the theoretical amount of gain.—The quality of the wrought iron produced by puddling depends on the composition of the pig iron used, and on the care and thoroughness of working. The removal of silicon and carbon is easily effected by good working; but phosphorus and sulphur are never completely removed. According to Parry, 75 to 80 per cent. of phosphorus and 80 per cent. of sulphur is ordinarily eliminated. The manner of removal of phosphorus is somewhat doubtful. Percy thinks it is mainly in the form of phosphide of iron, which is more fusible than the iron, and is hence carried off with the cinder. It has, however, been noticed that the more basic the cinder, the more phosphorus it contains; which renders it probable that phosphorus is present in the cinder in the form of phosphoric acid. Sulphur is said to be principally removed in the latter part of the process, which is consequently prolonged when highly sulphur-

ous pig iron is puddled. This prolongation of the operation tends to make a highly fibrous iron, probably owing to the fact (see *Iron*) that the cinder becomes very basic and more infusible, and is hence not so readily expelled by rolling or hammering. The purer the pig iron treated, that is, the less sulphur and phosphorus it contains, the shorter may the operation be, and the more granular and crystalline the product. Puddled steel is made in the same way as wrought iron, but from pure pig iron, containing not too much silicon. The operation is stopped before all the carbon is oxidized, and a steely product is obtained. The presence of manganese is here an advantage; since, as has been before mentioned, oxide of manganese in the cinder does not oxidize the carbon of the pig iron. Tap or puddling cinder is composed mainly of silica and oxides of iron; it may be considered as a tribasic silicate of ferrous oxide, containing also, at times, ferric and magnetic oxide. Phosphoric acid and sulphur are also generally present. Such cinder is used either raw or roasted in the blast furnace, yielding when in large quantity an inferior quality of iron, known as cinder pig; or it is used after roasting as fettling for the puddling furnace. The following analysis is of tap cinder made from common white iron: silica, 7.71; ferrous oxide, 66.32; ferric oxide, 8.27; manganese oxide, 1.29; alumina, 1.63; lime, 3.91; magnesia, 0.34; sulphur, 1.78; phosphoric acid, 8.07; total, 99.32.—There have been proposed from time to time a great number of fluxes and purifying agents for use in the puddling process; they are mainly directed against sulphur and phosphorus, particularly the latter. The following are a few of the substances proposed: oxide of manganese, common salt, iodide of potassium, nitre, litharge, copperas, chloride of calcium, lime, and fluoride of calcium. Manganese generally exerts a favorable influence in all iron and steel processes. Its action is not well understood, except so far as it hinders the decarburization of pig iron when it replaces iron in cinder. It is not probable that it affects either sulphur or phosphorus in the puddling. The volatilization of sulphur and phosphorus as chlorides has long been a favorite theory; but there is no proof that chloride of sodium or any other chloride acts in this way. The oxidation of phosphorus in pig iron takes place readily; and, if the cinder present is sufficiently basic, the phosphoric acid will remain combined; if not, the phosphorus will recombine with the iron. (See Bessemer process, under *STEEL*.) A highly basic iron cinder, as above mentioned, retains a large amount of phosphoric acid, but if instead of oxide of iron a stronger base is substituted, the phosphoric acid will be still more firmly held in combination. The alkalis and alkaline earths have proved to be valuable dephosphorizers; and it is probable that salt, nitre, and chloride of calcium act, in this respect, solely by virtue of their respective bases.

Henderson used a mixture of fluoride of calcium or fluor spar and titaniferous iron ore for the purification of pig iron, with good effect. It is impossible to say whether the fluorine exerts any direct action on the phosphorus, or whether the effect is due simply to the lime present in a highly fusible compound.—When the balls of soft iron are ready in the puddling furnace, they are taken directly to the hammer or squeezer. The trip hammers formerly employed are now generally replaced by steam hammers, which are more efficient and manageable. Squeezers are now very generally used for the next treatment of the puddled ball. The form generally used in the United States is Burden's rotary squeezer. Fig. 6 shows a horizontal action, different in construction, but on the same principle as the Burden squeezer. The revolving corrugated cylinder is eccentric to the frame in which it turns, and the ball in

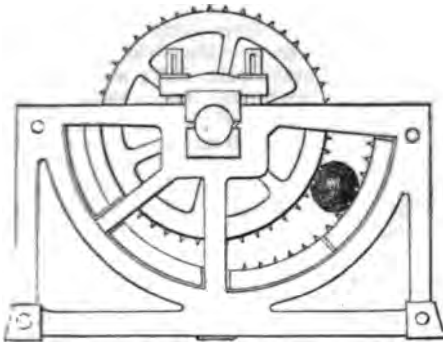

FIG. 6.

its passage is considerably condensed, while a large part of its cinder is expelled. From the hammer or squeezer, the bloom is taken while still hot to the rolls, where it is passed through a number of grooves, and formed into a slab or bar, called puddled or muck bar. This is still rough, and must be reheated and again rolled before it is ready for the market. The muck bar is generally broken up a length of two or three feet, made into a pile, and raised to a welding heat in a reverberatory or gas furnace. This white-hot pile is put through another set of rolls and gradually reduced in size until it forms merchant bar iron. The more iron is worked in this way within certain limits, the more homogeneous it becomes. Fig. 7 shows a merchant

obtained which will combine the properties of all the varieties used. Thus it is customary, in making piles for rails, to put a granular iron on the top and a fibrous iron in the body, so that the finished rail shall have a hard wearing surface and a tough web and flange. Smooth

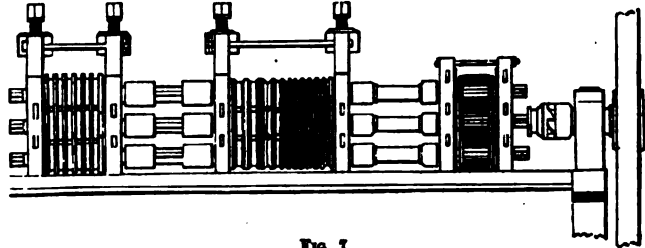

FIG. 7.

rolls are used for making plates and sheet iron. These rolls are provided with a mechanism by which they can be approximated after each pass of the metal. The limits of dimensions within which iron may be worked are very great. Sheet iron has been rolled out to the thinness of the finest paper, and armor plates have been made over a foot in thickness and weighing 88 tons.—The operation of puddling is extremely laborious, requiring great muscular strength and endurance. Many attempts have been made to substitute machine for hand labor in this process, with but partial success. The mechanical puddlers, so called, are mostly contrivances by which the rabble can be moved about in the furnace with merely the guidance of the workman. These machines, although they have worked well, have never come into general use. Another similar contrivance is the revolving rabble. This is extremely simple and requires no expensive machinery; it is said to give good results. Richardson's process consisted in blowing air through a hollow rabble, which was moved about the hearth. The process of oxidation here, as in the Bessemer process, proceeded rapidly; the iron soon came to nature, and the manual labor was confined to the operation of balling. Notwithstanding its apparent success, this process is nowhere in use at present. Attention was early directed to the construction of rotary or oscillating puddling furnaces; but the insuperable difficulty encountered was the formation of a lining that would stand the scouring effect of the metal. This difficulty has been overcome by Mr. Samuel Danks of Cincinnati, who has constructed and introduced the first practical and efficient rotary puddler. It consists of a revolving chamber, fire grate, and movable head piece communicating with the fue. The puddling chamber, 5 to 6 ft. in diameter and 3 to 4 ft. long, is made of two end pieces banded with wrought iron, and provided with detachable rings on the part most exposed to the fire. They rest on carrying rollers, permitting free rotation. The two ends are con-

ected by a series of stave plates to form a cylinder. These have hollow ribs running longitudinally, which serve the double purpose of holding the fettling and keeping it cool. The cylinder is open at both ends; one butts against the ring that is fastened to the bridge plate, and the other, which serves as a doorway, against the movable head piece. The chamber is made to revolve by a special engine attached to it by means of a toothed wheel. The fireplace is large, and is provided with blast under the grate and over the fire, by means of which the heat and character of the flame are easily regulated. Fig. 8 shows a vertical section through the fireplace chamber and head piece. The chamber is lined in the following manner: The initial lining is composed of a mixture of pulverized ore and pure lime, worked with water to the consistency of a thick paste. The inner surface of the chamber is completely covered with this mortar in a layer projecting about one inch over the hollow ribs. After

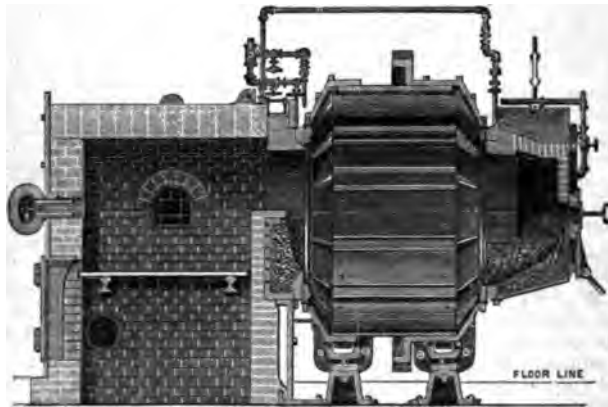

FIG. 8.

this has become hard, the furnace is ready for the fettling. About one fifth of the whole quantity of iron ore required is thrown into the furnace in the form of powder. The furnace is then heated up and made to revolve slowly until the ore is completely melted. The apparatus is then stopped, and that part of the ore which has not been consumed in glazing the initial lining forms a pool in the bottom of the chamber, into which are put a number of lumps of ore of such a size that they project 2 to 6 in. above the surface. This is allowed to set, and then another lot of pulverized ore is put in, which is melted in the same way, and a pool collected on another part of the surface, into which lumps are put as before. About 2 to 2½ tons of ore are required to fettle a 700-lb. rotary furnace. The iron may be either charged in the solid form or run in molten from a cupola. When in the solid form, it has been found advantageous to have it granulated or otherwise finely divided, in order to hasten the melting. A quantity of hammer or roll cinder

is added with each charge, as is usual in puddling. When the iron is thoroughly melted the furnace is made to revolve once or twice a minute for the first five or ten minutes. A stream of water is then injected through a stopper hole along and just above the line of contact between the floating cinder and the inner surface of the vessel, on the descent side. The cinder is thus partially solidified and carried down with the molten iron, intimately mixed with it. When the iron begins to thicken under this treatment, the rotation is stopped and the heat raised until the cinder melts thoroughly and floats on top of the iron, when it is tapped off. The furnace is again put into motion at the rate of eight revolutions a minute, which causes the charge to be dashed about violently in the furnace. When the iron begins to come to temperature, the velocity of the apparatus is reduced to two or three revolutions per minute, and the ball speedily forms. The movable

piece is pushed to one side and the ball is removed in one minute. Special machinery is needed to work these large blooms, which in the furnaces hitherto constructed weigh 700 lbs. The yield of puddled bar is usually about 10 per cent. more than the weight of the pig charge, which is due to the reduction of the iron of the set. Owing to the thorough mixing of the iron, and the intimate contact of every part of the pig iron with the flange, the product is much more uniform and pure than that made by hand puddling. The successful introduction of Danks's furnace, a novel rotary puddler, has been

vented, which, though they may differ in mechanism from Danks's puddler, are yet operated in the same manner. In the rotary puddler the chamber is egg-shaped and the flame from the fire, instead of passing through, returns and goes out at the top through which it came.—Pig iron may be completely decarburized by heating in an oxidizing atmosphere, at a temperature below that of fusion. The removal of the carbon is effected gradually and slowly from the surface to the centre. This process is used extensively in making the so-called "malleable castings" (iron), also often malleable iron. Only articles of less than an inch in thickness are so treated, on account of the length of time required for conversion. White iron, which is best adapted for the purpose, is cast in molds and the articles thus formed are packed in a bed of iron and exposed to a red heat for four or six days. When cold they are taken out and are found to be tough and malleable. The iron from which they were made was

stable quality, and the conversion has been uniformly effected. The following analyses by Dr. R. W. Davenport show the progress of carburization:

ELEMENTS.	Original casting.	After annealing.	After second annealing.
Iron	0.445	0.488	0.449
Carbon	0.815	0.827	0.815
Manganese	0.529	0.535	0.525
Phosphorus	0.059	0.067	0.081
Silica	8.480	1.510	0.100

These analyses likewise show that the process is simply one of decarburization, and that the other elements present are not materially affected. Dr. Davenport noticed in a casting  $\frac{1}{2}$  in. thick, which had been converted to the depth  $\frac{1}{4}$  in., that the remaining  $\frac{1}{4}$  in. was darker in color than the original iron used, and analyses showed that it contained graphitic carbon. The separation of carbon from combination may therefore possibly be the first step in the process of conversion.—Within the last 20 years there have been a great number of attempts to make wrought iron and steel direct from the ore without the use of the blast furnace. These direct processes differ from the bloomery process, in which the same result is accomplished, by the reduction of the ore at a temperature below fusion, and the formation of iron sponge. The sponge thus formed contains nearly all the iron in the metallic state besides the earthy ingredients of the ore unaltered. To remove the earthy matters and consolidate the iron, it is worked up as a bloom in a reverberatory or gas furnace, or in a bloomery hearth, and then hammered or rolled in the usual way. The process of reduction or sponge making is very simple. The ore is either mixed with the fuel (preferably charcoal) in a cylinder or cupola furnace and heated to redness, or is exposed to a current of hot carbonic oxide gas. When reduction is ended, the sponge, which oxidizes readily owing to its porous condition, should be cooled in a reducing atmosphere before removal. If the process of reduction has been sufficiently prolonged, and the sponge fully cooled before removal, the product should contain at least 90 per cent. of iron in the metallic state. A great loss of iron has hitherto been experienced in working up this sponge, especially when made from poor ores containing considerable silica. In balling the iron in a puddling furnace, the loss of iron is excessive, owing to its porous condition. This has been the principal cause of the failure of nearly all the modern direct methods for making wrought iron. Chenot's process, which 20 years ago seemed to be successfully established as a metallurgical and economical process, and which furnished a large amount of iron and steel of excellent quality, is now abandoned. The same fate has befallen Yates's, Renton's, and other processes which promised

success. A new application of iron sponge has been found in steel making in the open-hearth regenerative furnace; and it is now probable that iron sponge will find an economic application. In the Martin process for making steel or homogeneous iron (see STEEL), wrought-iron scrap is added to a bath of molten pig iron until the percentage of carbon remaining, in consequence of this addition, is very low, or, with the aid of an oxidizing flame, even perfectly removed. Iron sponge added in this way to a pig-iron bath loses iron to the extent merely of saturating the silica it contains in the formation of a cinder. In very pure ores this loss is consequently very small. It is in this way that Mr. Thomas S. Blair of Pittsburgh successfully utilizes the sponge made by his process, which is one of great simplicity, on the principle of Chenot's, with certain improvements in apparatus. His reduction cylinders are 40 ft. high and 8 ft. in internal diameter. The upper half is exposed to a bright red heat from burning gas on the outside, and the lower half is provided with a water jacket for cooling the reduced product. Into the top of the cylinder is inserted a thimble of cast iron 6 ft. long and 28 in. in diameter, leaving an annular space of 4 in. between it and the cylinder. Into this space are charged charcoal in small fragments and powder, and ore in pieces not larger than an egg. The carbonic oxide resulting from the reduction of the ore burns inside the thimble, and the gas from the producers outside the cylinder. The charge thus becomes rapidly heated through in this narrow space, and when it spreads over the whole diameter of the stack, 6 ft. from the top, it is all red hot. At the bottom of the stack there is a sleeve which when raised allows the already thoroughly cooled sponge and the charcoal charged in excess to run out. The sponge is drawn at regular intervals, and in the mean time the sleeve is luted with clay. No air gains access to the stack while drawing, as the column of finely divided iron and coal forms an effectual packing. The sponge is separated as far as practicable from the charcoal and compressed by hydraulic pressure into ingots, which are added directly or after previous heating to the bath of metal in a Siemens or other form of regenerative furnace. Owing to the great simplicity of the process, iron sponge is a much cheaper product than pig iron. Siemens has invented a number of sponge processes, which are all connected with the use of his regenerative furnace. None of them have ever come into general use. Since the introduction of Danks's puddler he has employed a rotary cylinder similar to this for the direct production of iron. The chamber is lined with a refractory material and heated on the regenerative principle. The ore is first melted, then the charcoal or coke is added, and the vessel rotated. Reduction takes place energetically, and a ball of soft iron is speedily formed. Siemens

## IRON MASK

small waste of iron and a great economy for this process. It may be regarded as a perfected form of the bloomery process.

**IRON MASK, Man in the,** a state prisoner of France in the reign of Louis XIV., who died in the Bastille, Nov. 19, 1703. Some critics have denied the existence of such a person, but late investigations have established it beyond question. The register kept by Dujunca, chief turnkey of the Bastille, proves that the prisoner was committed on Thursday, Sept. 18, 1698, having been brought thither from the island of Ste. Marguerite by Saint-Mars, who exchanged in that year the governorship of the state prison here for that of the Bastille. The removal was made with extraordinary precaution and secrecy. The prisoner was carried in a close litter, which preceded that of Saint-Mars, and was accompanied by a mounted guard. His face was covered with a black velvet mask, fastened with steel springs, which he was forbidden to remove on pain of instant death. He was not allowed to speak to any one except his governor, who watched him with jealous care and always kept a pair of pistols at hand to destroy him in case he made an effort to reveal himself. When in the Bastille he was attended at meals and at his toilet by Saint-Mars himself, who removed personally and examined or destroyed the linen which he had worn, lest he might make known his secret by means of some mark on it. At mass he was forbidden to speak or to show himself, and the invalides who stood by with loaded muskets had orders to shoot him if he made the attempt. After his death everything which had been used or worn by him was burned. He was buried in the cemetery of St. Paul.—Since the time of Voltaire, who first gave shape to the story of the mask, numerous attempts have been made to establish his identity. Writers have advanced various theories regarding him, some of which are: that he was the fruit of an intrigue between Anne of Austria, queen of Louis XIII., and the duke of Buckingham, born in 1626; the illegitimate son of the same queen by an unknown father, born in 1631; and a twin brother of Louis XIV., born a few hours after the king, and disposed of thus to avoid a disputed succession. But there is little evidence that any of these ever existed. Theories have also been put forth in regard to a number of real persons, among whom are the English duke of Monmouth, the reputed son of Charles II. and Lucy Walters; the count of Vermandois, an illegitimate son of Mlle. de la Vallière by Louis XIV.; the duke of Beaufort, prominent in the insurrection of the Fronde; Henry, son of Oliver Cromwell; Avedick, the Armenian patriarch, who was treacherously seized by De Ferriol, French ambassador at the Porte; Fouquet, marquis of Belle-Isle, minister of finance, and reputed rival of the king in the affections of Mlle. de la Vallière; and Ercole Mattioli, a secret agent of the duke of Mantua, who was arrested in 1679 for divulging one of the intrigues by which

## IRON MOUNTAIN

Louis XIV. sought to obtain possession of Canada. The claim of Mattioli to the distinction first advanced by M. Delort, and again by Lord Dover in 1826, is ably upheld by Marius Töpfer in "The Man with the Iron Mask" (Paris and London, 1869); but a late book by T. Jung, staff officer of the French army, entitled *La vérité sur la masque de fer* (Paris, 1878), makes it appear probable that Mattioli was never in the Bastille, but died at Ste. Marguerite in 1694. M. Jung, who has investigated the subject with minute care, shows that in 1691 the mask was spoken of as a prisoner of 20 years' standing, and then proves the following: that in October, 1681, Saint-Mars was transferred from Pignerol, a fortress on the borders of Savoy of the donjon of which he had had command for nearly 16 years, to Exiles, a fort on the frontier of Piedmont, and that he then took with him, in a litter strictly guarded, two prisoners; that on or previous to Jan. 5, 1687, one of these prisoners died, and that in April following Saint-Mars was transferred to Ste. Marguerite, and took with him a single prisoner who was carefully guarded and watched. By a chain of strong circumstantial evidence he connects the mask with the latter prisoner, and with the survivor of the two removed in 1688 from Pignerol to Exiles. He endeavors next to prove his identity with the chevalier de Kiffenbach, or d'Harmonies, who was arrested with others in March, 1678, at Péronne, charged with complicity in a plot to murder the king and sent to the Bastille. In 1674 a prisoner was transferred from the Bastille to Pignerol, but the evidence is scarcely strong enough to establish his identity with the prisoner of 1674, and it is still less certain that the one of 1674 was of the pair transferred to Exiles. But M. Jung has not fully proved his case, he confined future research to very narrow limits.

**IRON MOUNTAIN,** a remarkable deposit of specular iron ore on the S. E. border of Vernon county, Missouri, about 40 m. S. W. of Genevieve, the nearest point on the Missouri river. The locality is connected with St. Louis by rail. It is described by Dr. Litton in the second annual report of the geological survey of Missouri (1855), and by Prof. Raphael Pelly and Dr. Adolf Schmidt in the volume "Iron Ores and Coal Fields" of the geological survey (1873). The later account is based on more extensive and minute investigations, with the advantage of exposure by continued mining operations, is the most accurate. The iron mountain deposit is in the azoic rocks, which reach their maximum surface development in the region of the northern part of Madison, Iron, and Washington counties, constituting portions of the skeleton of the Ozark range, and appearing as knobs to 1,600 ft. above sea level, and as ridges to 1,000 ft. above the valleys at their base. The knobs form an archipelago of granite

islands in the lower Silurian strata of the and gritstone, which surround and them. These azoic crystalline rocks, been apparently above the level of the before the upper Silurian period, at ve been exposed to the action of at-ric agency for enormous periods, and his long-continued influence have under-markable changes. The gradual remo-he soluble constituents has left impo-riudary deposits in the Silurian strata flint, crystalline quartz, iron sulphuret, &c., and in the pre-Silurian rocks of e. The destructive action of atm-sph-erencies is developed both in the disin-and decomposition of large bodies s *en masse*, and in the formation and ent gradual disintegration of polygonal on the surface. In Iron mountain the is characteristically the case, the por-f which the hill (now 250 ft. high, and z about 500 acres) largely consisted, been entirely changed to clay. The lation of insoluble residuum from this osition and denudation has left a re-le surface deposit of iron ore, covering le of the hill in a mantle of ore detri-ciated with clay. The internal struc-the hill is indicated by the mining ex-as at and near the summit, and on the lled Little Iron mountain. It appears ist of deposits of most irregular form, s magnetic observation has seemed to zones extending N. N. E., being nearly se of the ridge of porphyry of the spur h Iron mountain is the southwestern tion. At the summit an immense mass ore is exposed; and the decomposed y adjoining it is traversed in all direc-y veins of various sizes and irregular forming a network of ore and rock. Iron mountain, a western continuation main hill, contains similar irregular d masses of ore, the smaller of which tly show crystals of apatite. At or : surface the apatite has been removed, the impressions only of the crystals, tly lined with delicate drusy quartz: n such seams, the surface ore shows osphorus. All the ores of this region racterized by great purity. Those of ountain are in general very rich and iform, nearly free from sulphur both surface and in depth, and carrying a proportion of phosphorus, which rarely 0.12 per cent. The ore is specular, ng over 90 per cent. (sometimes 97 per f peroxide of iron. Porphyry is en- it in large masses which can be easily d, apatite occasionally in small crystals, rtz in drusy aggregations resulting from ion into small cavities or fissures. All ountain ore is magnetic, some of it so, with distinct polarity, though the part of it acts but slightly on the The amount of ore in this deposit is

beyond calculation. The main body has a thickness of at least 50 ft., and continues indefinitely in depth. Some distance beyond the base of the mountain an artesian well, sunk to the depth of 152 ft., passed through iron ore and clay 16 ft., sandstone 84 ft., dolomite  $7\frac{1}{2}$  in., gray sandstone  $7\frac{1}{2}$  in., "hard blue rock" 87 ft., "pure iron ore" 5 ft., porphyry 7 ft., iron ore 50 ft.—Pilot Knob, in Iron co., 6 m. S. of Iron mountain, is a conical hill nearly circular, about 600 ft. high and a mile in diameter at the base, composed chiefly of porphyry, porphyry conglomerates, and beds of hard specular iron ore. The top is conglomerate 140 ft. thick, consisting of more or less angular pebbles of porphyry cemented with iron ore, and containing frequent layers and bodies of ore. The lowest layer of the conglomerate is in some places workable as iron ore, the matrix consisting mainly of finely divided specular oxide, with clay. Below this lies the ore bed proper, 46 ft. thick, and divided into two beds, about 81 ft. above the lower foot wall, by a persistent slate seam 10 in. to 13 ft. thick. The upper bed is distinctly stratified flag ore, and considerably leaner than the lower, which presents a very compact and hard stratified peroxide. Under this ore bed is a series of porphyries. The maximum superficial extent of the ore bed appears to be about 200,000 square yards. It dips S. W. about 18°. The ore differs in quality from most of the other specular ores in the state. It is steely gray with a tint of sky-blue, very faint lustre, crystalline to granular structure, lamellar and jointed, and very brittle. The streak is uniformly dark red. The fine ore from the conglomerate has polaric magnetism, and all the Pilot Knob ores are slightly attracted by a magnet, when they are ground fine. Those from the beds immediately above and below the slate seam, however, do not disturb an ordinary compass needle.—At Cedar hill, Shepherd mountain, and other localities, similar deposits of magnetic specular iron ore occur. Dr. Schmidt holds that these specular ore deposits have been formed by infiltration from chalybeate waters. At Iron mountain he believes such waters to have deposited oxide of iron in numerous large and small fissures in the porphyries. At Pilot Knob he believes the iron ore beds to have been formed by gradual replacement of the constituents of the porphyry with ore, effected by solutions similar to those which caused Iron mountain and other deposits. This view is supported by chemical as well as geological considerations.—The Iron mountain company in 1871 shipped 262,477 tons of ore; in 1872, 371,474 tons, of which 143,431 tons were consumed in Missouri. In 1873 there were 16 furnaces employing the ores of this region, 7 using charcoal and 9 stone coal, able to produce in a year of ten months about 176,000 tons of iron. The production of 1872 was 126,652 tons, from 211,177 tons of ore, indicating a yield of about 60 per cent. of iron

from the ore. These specular oxides of the azoic rocks of Missouri are proving immensely important, not only to the western states, but also to the general iron industry of the country. The demand for the ores is large, on account of their richness and purity, which render them suitable for admixture with magnetites, &c., of other localities, and adapt them especially for the manufacture of pig iron for use in the Bessemer process, and of wrought iron by the direct process.

**IRON ORES.** The term iron ore is limited to oxides of iron, either as such or in combination with water or carbonic acid. Other compounds of iron, as for example the sulphide,

are not adapted for iron making. The term is further limited to deposits of sufficient purity and richness to render smelting profitable. These factors differ in different localities. Both the ferric and magnetic oxides occur in nature, sometimes nearly pure; they are called respectively hematite (red or anhydrous hematite) and magnetite. Ferric oxide also occurs in combination with water in various definite proportions; these compounds are called hydrous or brown hematites. Ferrous oxide is a component of many minerals, but only the ferrous carbonate is important as an ore of iron; it is known as spathic ore. Mineralogically iron ores may be grouped as follows:

ORES.	Formula.	Crystalline form.	Hardness.	Specific gravity.	Color of powder.	Perc. metal & iron.	Water.	Carbon.
<i>Ferric Oxide—Red Hematite.</i>								
HEMATITE	Fe <sub>2</sub> O <sub>3</sub>	Hexagonal	5-5-5	4-5-5-3	Cherry red to reddish brown	70-80		
<i>Ferric Oxide Hydrated—Brown Hematite.</i>								
Limonite	Fe <sub>2</sub> O <sub>3</sub> .2H <sub>2</sub> O	Massive	5-5-5	3-6-4	Yellowish brown to rusty yellow	52-54	25-28	
Xanthosiderite	Fe <sub>2</sub> O <sub>3</sub> .2H <sub>2</sub> O	Massive or fibrous	2-5		Ochre yellow	37-14	15-27	
Limonite	2Fe <sub>2</sub> O <sub>3</sub> .3H <sub>2</sub> O	Massive or earthy	5-5-5	3-6-4	Yellowish brown	20-30	14-18	
Göthite	Fe <sub>2</sub> O <sub>3</sub> .H <sub>2</sub> O	Orthorhombic	5-5-5	4-4-4	Brownish to ochre yellow	63-68	10-11	
Turgite	2Fe <sub>2</sub> O <sub>3</sub> .H <sub>2</sub> O	Massive	5-6	3-5-3-7	Reddish	64-28	5-28	
<i>Ferrous Carbonate—Spathic Ore.</i>								
SIDERITE	FeO.CO <sub>2</sub>	Hexagonal	3-5-4-5	3-7-3-9	White	45-27		5-13
<i>Magnetic Oxide—Magnetite.</i>								
MAGNETITE	Fe <sub>3</sub> O <sub>4</sub>	Isometric	5-5-6-5	4-9-5-2	Black	72-41		

Iron ores rarely occur in masses of mineralogical purity. The hydrous hematites are so closely related in their formation, occurrence, and physical appearance, that their distinction is sometimes impossible without chemical analysis, but generally the groups are readily distinguishable. The color of the powder, or streak, is very characteristic. Turgite here forms an exception to the rule; but it is easily recognized on heating, since it decrepitates and gives off water. Nearly all the iron ores contain earthy substances. These are commonly silica, alumina, lime, magnesia, &c.; silica usually predominating. These substances are removed in the cinder on smelting. Manganese accompanies iron in nearly all its ores, but for the most part in small quantities; the spathic ores contain the largest proportion. Under favorable conditions the manganese is reduced in the furnace and unites with the iron; usually, however, the greater part goes into the cinder. Sulphur is found in many ores, either in the form of sulphuric acid or as iron pyrites. According to the conditions of the smelting, the sulphur may enter either the iron or the cinder. Phosphorus, in the form of phosphoric acid, is present in most iron ores, either combined with the oxide of iron, or mechanically disseminated as apatite (calcic phosphate). It is the most dreaded of all the impurities of iron ores, since no method has been discovered of eliminating it in the blast furnace; nearly the total amount

of phosphorus in the ore goes into the iron. Titanium, as titanio acid, is present in many ores, especially magnetites. It renders the ores very difficult to smelt in the blast furnace; it is generally mainly removed in the cinder, but occasionally some of it unites with the pig iron. Chromium in small amount is not an unusual ingredient of iron ores; on smelting it probably passes mainly into the pig iron. Zinc is very commonly present in minute amounts; it is completely volatilized, and forms incrustations of white oxide around the furnaces. A brief description of the leading varieties of iron ore deposits, and their distribution, particularly in the United States, is all that will be attempted in this article.—1. *Hematite.* The term hematite (Gr. *αἷμα*, blood) is properly applied to the sesquioxide only, since this has a red powder; but Theophrastus speaks of *ἀμαρινῆς ξασθῆς*, or yellow hematite—probably an ochreous limonite. The ferric or sesquioxide occurs in several varieties. The specular ore has a crystalline structure, often forming beautiful splendid rhombohedral crystals. The famous mines on the island of Elba, worked before the beginning of the Christian era, furnish this variety in great purity. Sometimes the structure is foliated or micaceous, giving the ore a grossy appearance and feel; it is then called micaceous hematite. The more common varieties are the compact, columnar, and fibrous. It occurs also in concretions or botryoidal masses. Its color



is brownish red to iron black (red hematite). Occasionally it is earthy in character (red ochre). An argillaceous variety is known as clay ironstone, or argillaceous hematite. It is also often oölitic in character. All the varieties have the red streak in common. Hematite is found with the iron partially replaced by titanium, giving rise to various mineral species, such as menacannite and ilmenite. They have the general formula  $(\text{Ti, Fe, Mn, Mg})_2\text{O}_3$ , and contain from 3.5 to 59 per cent. of titanate acid. The hematite ores are as a rule of great purity, and from them is made a large proportion of the finer varieties of iron and steel. Nearly all the Bessemer pig iron in England and America is made from red hematite. "It occurs in rocks of all ages. The specular variety is mostly confined to crystalline or metamorphic rocks, but is also a result of igneous action about some volcanoes, as at Vesuvius. Many of the geological formations contain the argillaceous variety or clay ironstone, which is mostly a marsh formation, or the deposit over the bottom of shallow, stagnant water; but this kind of clay ironstone (that giving a red powder) is less common than the corresponding variety of limonite or siderite. The beds that occur in metamorphic rocks are sometimes of very great thickness, and, like those of magnetite in the same situation, have resulted from the alteration of stratified beds of ore, originally of marsh origin, which were formed at the same time with the enclosing rocks, and underwent metamorphism, or a change to the crystalline condition, at the same time." (Dana.) The hematite ores are widely distributed. Immense beds occur in Chili, and it is said in other South American states. The mines of Norway, Sweden, Lorraine, Switzerland, Saxony, Bohemia, and the Hartz also contain this ore. Unusually pure varieties are found in the mountain limestone of the carboniferous system in Cumberland and North Lancashire, England; and remarkably fine fibrous hematite is mined in Wales. At Bona, Algeria, there are extensive deposits of pure hematite, which is exported to France, England, and the United States for the manufacture of Bessemer steel. In the United States there are immense deposits of specular ore in the azoic rocks of the Marquette region, south of Lake Superior. These deposits probably consist chiefly of martite, which is sesquioxide of iron crystallizing in isometric forms, and supposed to be pseudomorphous after magnetite. According to this hypothesis, the Marquette ore beds were once all magnetite in composition, and have been changed to sesquioxide by the addition of oxygen. Some of these deposits present masses of absolutely pure ferric oxide; the majority, however, are more or less silicious, containing streaks and masses of jasper. The amount of sulphur and phosphorus is small, and the ores are consequently well adapted for the manufacture of steel. They furnish a large proportion of the Bessemer pig iron of the

United States. Missouri, which is one of the richest states in iron ores on the North American continent, contains specular ore in porphyry and in sandstone, as well as in disturbed and drifted deposits, and also strata and drifted deposits of compact and earthy red hematites, supposed to be in many cases the product of an alteration of the specular ores. The most famous deposits are those of Iron mountain and Pilot Knob. At Iron mountain, which is the largest ore deposit in Missouri, a hill of decomposed porphyry 250 ft. high is traversed by numerous ore seams, and cut in two by an enormous vein of specular ore from 40 to 60 ft. thick, besides being covered with surface ore in rounded boulders and fragments of variable size, in a stratum usually from 1 to 5 ft. thick. At Pilot Knob the ore is not in veins, but forms a regular bed in the porphyry of blue conglomerate. Shepherd mountain, Cedar hill, and other localities show similar deposits. The Missouri specular deposits in sandstone belong to the lower Silurian formation, and seem to have been originally formed in lenticular shape. The red hematites of the carboniferous formation of Missouri extend over large areas, as beds impregnating or replacing the ferruginous sandstone. All the Missouri specular iron is more or less magnetic, and in some cases it possesses polarity. Specular ores and massive or earthy and oölitic red hematites occur in the great azoic region of northern New York, in St. Lawrence, Clinton, and other counties. The Sterling, Parish, and other mines are famous. The Rossie hematites are now brought in considerable quantity to the Hudson river, for smelting with the magnetites of Lake Champlain. It is said that these hematites are so nearly pure as to permit the use of a considerable portion of them in the manufacture of Bessemer pig. In North and South Carolina a micaceous ferric oxide in schistose rocks, called itabirite or specular schist, occurs. It is found also in great beds in Canada. In some parts it is a rich ore of iron, and in others passes into ordinary chloritic schists. The Laurentian system in Canada contains beds of hematites, or oligist iron ore, in large irregular masses, as on Lake Nipissing, arranged in the planes of stratification. Similar ore occurs in small beds in the Potsdam sandstone. Specular ores occur in Maryland, Virginia, and other southern states, but do not yet constitute so important a source of iron production as the brown hematites, magnetites, and argillaceous carbonates. Maine and New Hampshire also present red hematite deposits, the largest of which is on the Aroostook river in the former state. The finest iron ore of this variety yet discovered west of the Missouri river is the deposit of red hematite near Rawlins, Wyoming territory. It is massive and very pure, and has been mined to a considerable extent and shipped to Salt Lake, where it has been charged in the lead-smelting furnaces, as a flux for the production of

an iron slag.—2. *Hydrous or Brown Hematite* (brown ore, bog ore, ochre, lake ore, marsh ore). The brown hematites belong to the most recent iron formations, and occur in great abundance. They constitute a series, in which the physical characters vary as the proportion of water diminishes, passing from earthy varieties having a yellowish streak to compact masses, with brown streak inclining to red. Turgite, which has the lowest amount of water, and is therefore nearest to red hematite, has already a red streak. The usual condition of hydration is that of limonite, which may be regarded as the typical brown hematite. The other varieties enumerated are exceptional. This ore occurs in a great variety of conditions, as earthy or ochreous masses, or in concretionary, stalactitic, or hard, compact, mammillary, and botryoidal aggregations. It has often a distinct fossiliferous character, and is associated with vegetable and animal remains. All the varieties yield water when heated, and all except turgite give a yellowish or brownish streak. Brown hematites differ widely as regards purity. Usually they contain considerable silica and phosphoric and sometimes sulphuric acid, and are consequently rarely employed exclusively for the finer varieties of iron and steel. They however supply a large proportion of the iron that is used for castings. "Limonite occurs in secondary or more recent deposits, in beds associated at times with barite, siderite, calcite, aragonite, and quartz, and often with ores of manganese; also as a modern marsh deposit. It is in all cases a result of the alteration of other ores, through exposure to moisture, air, and carbonic or organic acids, and is derived largely from the change of pyrite, siderite, magnetite, and various mineral species (such as mica, hornblende, and augite), which contain iron in the protoxide state. It consequently occupies, as a bog ore, marshy places over most countries of the globe, into which it has been borne by streamlets from the hills around; and in the more compact form it occurs in stalactites as well as in tuberoso and other concretionary forms, frequently making beds in the rocks which contain the minerals that have been altered into it. In moist places, where a sluggish streamlet flows into a marsh or pool, a rust-yellow or brownish yellow deposit often covers the bottom, and an iridescent film the surface of the water; the deposit is a growing bed of bog ore. The iron is transported in solution as a protoxide carbonate in carbonated waters, a sulphate, or as a salt of an organic acid. The limonite beds of the Green mountain region were shown by Percival to be altered beds of pyritiferous micaceous and argillaceous schist; and the same is held by Lesley as true also of the other beds of the Atlantic border, from New England and New York, through Pennsylvania (Mt. Alto region and others), to Tennessee and Alabama." (Dana.) Brown hematite is the most universally dif-

fused of all the ores of iron, and furnishes a large proportion of the iron of the world. In the United States it is distributed very widely and abundantly. Large deposits occur in New England, particularly in the neighborhood of Salisbury and Kent, Conn., and in Columbia and Dutchess counties, N. Y. The ores of these deposits are highly prized. Similar deposits of limonite are traced in a zone extending from the Hudson river to Alabama, along the line of the north flank of the South mountain, Blue Ridge, and Smoky mountain range, and also in the lower Silurian limestone valleys of Pennsylvania and Virginia, Nittany valley, Kishicoquillus, &c.; and again, under similar geological conditions, in East Tennessee, where the deposits near Embreeville are estimated by Lesley, Maynard, and others to contain many millions of tons of excellent ore. Western North Carolina and northwestern Georgia contain portions of the same zone, which ends in the magnificent deposits of Alabama. The siderite clay ironstones of the carboniferous and other rocks frequently furnish by oxidation deposits of brown hematite. This is the case particularly near the outcrop, but sometimes also throughout large deposits. The lignites of New Mexico, Colorado, and Montana are accompanied by ores of this character. The same is the case in the Appalachian region, for instance at Brady's Bend, Pennsylvania, in West Virginia, and elsewhere, and among the carboniferous iron ore deposits of Ohio, Indiana, Kentucky, &c. Large deposits of limonite occur in dolomite, associated with zinc ores, in Arkansas. Texas is also abundantly supplied with this ore. Brown hematite (bog ore and ochre) is found in large quantities in Canada, particularly in the St. Lawrence valley, where it overlies superficial deposits of clay and sand. The distribution of brown iron ores in other countries is so nearly universal that the localities need not be named. It may be remarked that the extensive deposits of Styria and Carinthia in Austria, and of Nassau on the Rhine, are celebrated for their purity and freedom from phosphorus—an element which, by reason of the usual organic origin of such deposits, is most likely to be found in them. The universality of this ore naturally follows from the fact that it is the ultimate result of the chemical metamorphosis of all other kinds of iron ore; so that wherever any ore of iron is exposed to oxidizing agencies and moisture, some form of limonite or hydrated ferric oxide of iron is certain to occur. The term limonite is derived from the Greek *λειμων*, moist grassy land, and refers to that variety which is known as bog ore or marsh ore. Famous ochreous deposits occur at Brandon, Vt. At Pointe du Lac and St. Ann, Montmorenci, Canada, are remarkable localities of the ochre, and at the latter place it is seen in the process of formation. The deposit varies from 4 to 15 ft. in thickness, and covers an area of four acres.—

*limonite Ore, or Siderite.* This ore is never as pure ferrous carbonate, part of the being invariably replaced by manganese, or magnesia. The percentage of iron in the table above is therefore theoretical is never perfectly attained. The ore is crystallized, massive, and concretionary in the latter form it is called sphaeroidite. It is for many purposes the most valuable of iron, owing to its general freedom from injurious ingredients, its easy reduction, and the presence of manganese (from 1 per cent. of oxide, exceptionally as high as 10 per cent.), which always enhances its value.

It is not very extensively distributed in the United States, but a few localities contain it in large quantities. It is almost the only material used in the preparation of spiegeleisen. (See IRON.) It is carbonate also forms the basis of the most valuable blackband ores, and of most of the clay ironstones, which are very extensively distributed. The ferrous carbonate is in ores intimately associated with argillaceous, silicious, and often carbonaceous matter. It frequently contains also sulphur as iron pyrites, and phosphorus as calcic phosphate. These ores are therefore much less pure than the limonite ore properly so called, and yield a much inferior character. The carbonaceous ores, when heated, lose their carbonic acid, and their ferrous oxide is converted into hematite. They are always calcined before being melted. The carboniferous blackbands usually contain from 15 to 20 per cent. of carbon, and may be roasted without the addition of fuel. On roasting they lose half their weight. Sphaeroidite becomes brown or black on exposure, owing to a portion of the iron and its passing into hematite; and by a subsequent loss of water it passes into red hematite. The occurrence of limonite ore is limited principally to the line states and the older sedimentary rocks. The most extensive and characteristic occurrence is being in the Devonian formation. The most noted localities are Siegen, Rhenish Prussia; Kamsdorf and Stahlberg in Thuringia; Ansbach in Westphalia; the Erzberg near Eisenerz in Styria, in the Devonian; and the Erzberg near Hüttenberg in Carinthia. It also has deposits in the Brendon in Somersetshire, and at Exmoor, South Devon, and Walscott in Devonshire; also at Durham. A remarkable series of beds of impure or earthy carbonate is found in different members of the lias formation.

The Cleveland hills, North Riding of Yorkshire, England. The main deposit is in the middle, showing a workable seam from 8 to 13 feet; it is believed to extend throughout the length of Cleveland proper. In this region of the world the manufacture of iron has reached its highest stage of development than in any other part of the world. The principal deposit of limonite in the United States is at Roxbury, Massachusetts, in a vein of quartz, traversing gneiss.

The clay ironstones are met with in both the carboniferous and tertiary (brown coal) formations. In England, Scotland, Westphalia, and other regions, the blackband ore (carbonaceous carbonate) forms the basis of an extensive industry. This ore, as found in Westphalia, contains an extraordinary amount of phosphoric acid, in some layers as much as 80 to 60 per cent., and in others 20 to 25 per cent. The blackband ores are of subordinate importance in the United States, though they have been found in the coal regions of western Pennsylvania. Earthy carbonates occur extensively in Pennsylvania, West Virginia, Ohio, &c.—4. *Magnetite.* Magnetic iron ore occurs generally in large masses, but with distinctly crystalline structure. It also occurs in the form of sand, concentrated by fluvial or tidal action from the debris of rocks containing it. It is readily recognized by its black color and streak, and by its being attracted by the magnet. It derives its name from the Thessalian district of Magnesia, bordering on Macedonia, or, according to Pliny, from Magnes, who first discovered it. There is a magnesian variety in which part of the ferrous oxide is replaced by magnesia, and a titaniferous variety in which a part of the iron is replaced by titanium. This variety bears the same relation to magnetite as iserine to hematite. The amount of titanic acid varies through wide limits. Magnetic ore is often found in a state of almost absolute purity; more generally it is associated with apatite (calcic phosphate), iron pyrites and other sulphides, quartz, and earthy ingredients. It supplies a large amount of the finest iron and steel of commerce. The iron industry of Sweden is based almost entirely on magnetic ores. "Magnetite is mostly confined to crystalline rocks, and is most abundant in metamorphic rocks, though found also in grains in eruptive rocks. In the azoic system, the beds are of immense extent, and occur under the same conditions as those of hematite. It is an ingredient of most of the massive variety of corundum called emery. By deoxidation through organic matter it is changed to protoxide, which may become a carbonate; by oxidation it becomes hematite." (Dana.) The principal European occurrences of magnetic ore are at Arendal in Norway; Dalarna, Westmanland, Wermland, Dannemora, Utö, and Smaland in Sweden; in Finland, and in the Ural. In the United States there are vast beds in the azoic of the Adirondack region, Warren, Essex, and Clinton counties, in northern New York; also in northern New Jersey, in Morris, Sussex, Warren, and Passaic counties, where it is found in beds conformable with the azoic gneiss, and also intimately disseminated in the gneissic strata. In eastern Pennsylvania there are several localities, the most noted being Cornwall in Lebanon co. In Canada it is found at Hull, Grenville, Madoc, &c. In North Carolina, at Greensboro, there is an extensive titaniferous belt of magnetites. Large deposits are known in Sierra co., Cali-



available either for mining purposes or the manufacture of charcoal iron. Passing westward, in Arkansas and Missouri is reached that wonderful range of red oxide of iron, which, in mountains rising hundreds of feet above the surface, or in beds beneath the soil, culminates at Lake Superior in deposits of ore which excite the wonder of all beholders; and returning thence to the Atlantic slope, in the Adirondacks of New York, is a vast undeveloped region, watered by rivers whose beds are of iron, and traversed by mountains whose foundations are laid upon the same material; while in and among the coal beds themselves are found scattered deposits of hematite and fossiliferous ores, which, by their close proximity to the coal, have inaugurated the iron industry of our day. From these vast treasures the world may draw its supply for centuries to come, and with these the inquirer may rest contented, without further question; for all the coal of the rest of the world might be deposited within this iron rim, and its square miles would not occupy one quarter of the coal area of the United States."—The table on the preceding page gives analyses of various ores from different localities, indicated by numbers as follows: A. *Hematites*. 1. Whitehaven, Cumberland, England. 2. Iron mountain, Missouri; specular ore from vein. (The phosphoric acid is the average of four determinations in as many samples, varying from 0.252 to 0.081 per cent.) 3. Pilot Knob, Missouri; specular ore from main ore bed. B. *Hydrous Hematites*. 4. Lake ore, Sweden. (Phosphoric acid varies from 0.051 to 1.213 per cent.) 5. Katahdin furnace, Piscataquis co., Me., resulting from the decomposition of iron pyrites. 6. Silicious ore, York co., Pa. 7. Pennsylvania furnace ore-bank, Centre co., Pa. C. *Carbonates*. I. Spathic ore. 8. Mäsnar Stahlberg, Prussia. 9. Calcined spathic ore from Altenberg, Styria, used for Bessemer process at Neuberg. 10. Brendon hill, Somersetshire, England. II. Earthy carbonates. 11. Gubbin ironstone, Dudley, S. Staffordshire, England. 12. Sphaerosiderite from Ahaus, Prussia. 13. Eston, Cleveland, England; main seam. 14. Carbonate ore from Fayette co., Pa. III. Blackband. 15. Shelton, N. Staffordshire, England. 16. Westphalian blackband, low grade. 17. Best Westphalian, roasted. D. *Magnetites*. 18. Danne-mora ore, Sweden. 19. Granrot ore, Sweden. 20. Lake Champlain, "new bed" ore, unusually free from apatite. 21. A sample from New Hope mine, Morris co., N. J. (The ores in northern New Jersey are very variable in regard to silica and phosphoric acid. The former varies from 2 to 40 per cent., the latter from 0 to 3 per cent. Low percentages of both silica and phosphoric acid, and freedom from sulphur, are usual.) 22. Titaniferous, from Green-boro, N. C. The following table shows the amount of sulphur and phosphorus contained in most of the Swedish and in some of the Prussian ores:

LOCALITIES AND ORES.	Sulphur, per cent.	Phosphorus, per ct.
Rastelp, Sweden, magnetite.....	0.011	0.0006
Pershyttan, " " .....	0.007	0.0130
Lerberg, " " .....	trace.	0.0018
Marna, " " .....	.....	0.0070
Hillang, " " .....	0.02	0.0050
Prague, Byberg, and Nyberg, Sweden, magnetite .....	0.061	0.0170
Färola, Sweden, magnetite .....	0.06	0.0100
Nartorp, " " .....	0.07	0.0130
Stenebo, " " .....	0.09	0.0800
Danne-mora, " " .....	0.087	0.0040
Near Wiesbaden, Prussia, red hematite....	trace.	0.210
" Coblenz, " " .....	"	0.210
" Wiesbaden, " brown " .....	0.08	0.150
" " " " .....	trace.	0.210
Limburg, " spathic ore .....	0.60	0.017
Oberlahn, " " .....	0.23	0.013
Werbenbach, " " .....	0.564	0.010
Westphalia, " blackband .....	0.090	0.240
Rhine Province, " brown hematite. ....	.....	0.090
Westphalia, " " .....	.....	0.043

—*Treatment of Ores.* Iron ores are generally used in the blast furnace in the condition in which they are mined, but sometimes they are submitted to a preliminary treatment. The carbonate ores are invariably roasted before smelting. This drives off the carbonic acid; the ferrous is converted into magnetic oxide; and the ore is rendered not only richer but much more porous, and thereby more readily reduced. Ores containing much sulphur are also roasted with access of air, and the greater part of the sulphur is driven off as sulphurous acid. Heavy compact ores are occasionally roasted to render them friable. Roasting may be effected in open heaps or within brick walls by piling the ore and fuel (wood or brush) in layers, and allowing it to burn out. This method is far less thorough and efficient than roasting in shaft furnaces. In the latter case the fuel (small coal) and ore may be charged alternately, or gas (from the blast furnace or suitable generators) may be used. The operation is continuous. Brown hematites often occur mixed largely with clay and other earthy matters; they are then submitted to a dressing or concentrating process by washing, in which the lighter clay is washed off and the heavier ore remains.—Forge and mill cinders, produced in puddling and heating iron, are very rich in iron, containing from 40 to 75 per cent. Although, strictly speaking, they are not ores of iron, yet they are used for reduction in the blast furnace. Their use in large quantity is attended with disadvantage, owing to the facility with which they melt and escape reduction. Puddling cinder, moreover, contains the greater part of the impurities of the iron from which it is made, and yields therefore inferior iron. Roasting renders the cinder more infusible, and also effects a partial purification.

**IRONS, William Josiah**, an English clergyman and author, born at Hoddesden, Hertfordshire, Sept. 12, 1812. He graduated at Queen's college, Oxford, in 1833, was some time a curate in the suburbs of London, afterward vicar of Barkway, Hertfordshire, and of Brompton, Middlesex, and in 1860 was made prebendary of St.

Paul's, London. In 1870 he was chosen Bampton lecturer, and the same year became rector of Wadingham, Lincolnshire, and rural dean. Dr. Irons has published a number of works, the most important of which are: "The Whole Doctrine of Final Causes" (1836); "Parochial Lectures" (three series, 1837-'47); "The Theory of Development examined" (1846); "Sermons for the People" (2 vols., 1859); "The Bible and its Interpreters, its Miracles and Prophecies;" "The Idea of the National Church" (1861), in the volume of "Replies to Essays and Reviews;" and "Christianity as taught by St. Paul" (Bampton lectures, 1870).

**IRONTON**, a city and the county seat of Lawrence co., Ohio, on the Ohio river, 142 m. above Cincinnati, and 100 m. S. by E. of Columbus; pop. in 1860, 3,691; in 1870, 5,686. It is built above the highest floods, at the foot of lofty hills, in the centre of the "Hanging Rock" iron region, embracing a portion of S. Ohio and N. E. Kentucky, of which it is the principal business point. Its iron trade amounts to about \$7,000,000 a year, and is rapidly increasing. The Iron railroad, 13 m. long, connects it with the N. part of the county. It is lighted with gas, supplied with water by the Holly system, and contains four blast furnaces, two rolling mills, a nail factory, a machine shop, a stove and hollow ware foundery, two boiler works, a hoe factory, two saw and planing mills, a boat-building establishment, a tannery, two breweries, two national banks, several graded public schools including a high school, a tri-weekly, a semi-weekly, and three weekly (one German) newspapers, and 15 churches. Ironton was laid out in 1849 by the Ohio iron and coal company, and was incorporated as a city in 1865.

**IROQUOIS**, or Six Nations, a confederation of Indians formerly occupying central New York, and exercising controlling influence over all surrounding tribes. They consisted when first known to the French of five nations: the Agnégue (called Maquis or Mohawks by their Algonquin neighbors), the Oneidas, Onondagas, Cayugas, and Senecas. Lakes or rivers bearing these names still mark the places of their residence. As a league they called themselves Hode-no-sau-nee or Hotinonsionni, meaning "they form a cabin." Of this cabin the fire was in the centre at Onondaga, and the Mohawk was the door. Each tribe had its name as a collection of individuals, and a symbolical name as a body corporate: thus the Mohawk tribe was the She Bear. According to their own tradition, they resided on the St. Lawrence as far down as Gaspé, but were driven back south of Lake Ontario by the Algonquin tribes. From this it may be inferred that those found by Cartier at Montreal in 1534 were really Iroquois. Soon afterward the Susquehannas, a kindred tribe, nearly exterminated the Mohawks. When Champlain began to settle Canada he found the Iroquois at war with all the Canada Indians, from the Hurons on Lake Huron to the Micmacs

in the gulf of St. Lawrence. In May, 1609, Champlain with some Hurons and Montagnais defeated an Iroquois force on Lake Champlain. In 1615 he joined the Hurons in an expedition against a town not far from Onondaga. But the Iroquois made a firm peace with the Dutch, and, obtaining firearms, invaded Canada in 1621. They also made war on the Mohegans, and killed the Dutch commander at Albany, who had joined their enemies. When the French recovered Canada in 1632 they found the Iroquois dominant. In 1639 they destroyed a town of the Dinondadies; in 1642 they cut off all communication between the Hurons and the French, defeated a large party, and captured a Jesuit missionary. They made peace in 1645, but renewed the war in 1646, killing Father Jogues and Piskaret, a great Montagnais chief. They then beset the French and their allies with large forces, compelling the Hurons to abandon some towns. Others were taken by storm in 1648-'9, and numbers of the Hurons perished with their missionaries. One whole division of the Hurons submitted and were incorporated among the Senecas. The Iroquois then subdued the Dinondadies and the Neutral nation. In 1651 they nearly annihilated the Attikamegues and besieged Three Rivers, killing the French governor of the town. They then absorbed many of the fugitive Hurons who had taken refuge with the French; but being pressed by the Éries and Susquehannas, they made peace with the French, who began a settlement at Onondaga in 1655. They also renewed their alliance with the Dutch. While French missionaries were laboring to convert them, they crushed the Éries, Tiogas, and other tribes, and carried their operations from the Abenakis on the east to the Illinois on the west and the Susquehannas on the south. They soon made war on the French and defied New England. Garakonthie, the Onondaga chief, restored peace with the French in 1663, although the Mohawks and Oneidas kept up the war till 1666, when the French twice invaded the Mohawk country. Then for a time French missions were renewed in their country. They subdued the Susquehannas in 1673 after a long war, and attacked the Shawnees and Mohegans. The English as masters of New York began to use the Iroquois to carry out their designs; they sent them against the Illinois, Miamis, and Ottawas, in order to subdue those tribes and control the fur trade. The French under De la Barre and Denonville invaded the Iroquois cantons in 1684 and 1697. Though peace was made in 1688, the Iroquois the next year attacked and destroyed Lachine in Canada, killing 200, which led the French to retaliate by destroying Schenectady in 1690. The Iroquois took part in English operations against Canada in 1690 and 1691, but the French in 1693 and 1696 ravaged the Mohawk and Onondaga territory. This war was very destructive to the league, which lost 1,500 out of 2,800 fighting men, and became averse to further

hostilities. Their next operations were against southern tribes, the Conoys, Tuteloes, Choc-taws, and Catawbias; but they took in the kindred Tuscaroras as a sixth nation, though without sachems. The French gave up all claim to the Iroquois in 1713, gathering their converts in villages on the St. Lawrence, where they still exist at Caughnawaga, Lake of the Two Mountains, and St. Regis. In the wars between England and France, which deprived the latter of Canada, the Iroquois were generally neutral, although, influenced by Sir William Johnson, they joined in the campaign against Dieskan, in which the Mohawks lost their chief Hendrick, and also served against Niagara. Alarmed at the progress made by the English, the Iroquois joined Pontiac and slaughtered many of them at Beaver Creek, Venango, Fort Pitt, and on the Niagara. Johnson finally renewed treaties with them in 1764 and 1766, and in 1768 by the treaty of Fort Stanwix obtained, for £10,460 7s. 8d., a grant of all lands not within a line which whites were not to pass, running from the mouth of the Tennessee to the Delaware. English authority being now supreme, vigorous attempts were made to convert them to Christianity, the previous efforts having met with little success. The Episcopal church made an enduring conquest in the Mohawk tribe. Yet the Iroquois were not all peaceful. A part of the western Iroquois were in arms in 1774, and fought against the whites at the battle of Point Pleasant, one of the fiercest in border history. When the American revolution began, the Iroquois led by the Johnsons adhered to the crown, while the French Iroquois in Canada inclined to the cause of the United States. Led by Brant, the Iroquois defeated several parties of troops and massacred the people at Wyoming and Cherry Valley. Col. Butler retaliated by destroying Unadilla and Oghkwaga, and Gen. Sullivan in 1779 ravaged their western cantons; but Brant in turn scourged the frontiers and punished the Oneidas, who were friendly to the Americans. The close of the war left the Iroquois at the mercy of the exasperated Americans, and nearly all emigrated except the Oneidas and Tuscaroras, settling on Grand river, Canada. By the treaty of Fort Stanwix, Oct. 23, 1784, the United States confirmed the Oneidas and Tuscaroras in their lands, and guaranteed to the other tribes the lands in their actual possession, on their ceding to the general government all W. of a line beginning on Lake Ontario at the mouth of Oyonwayea creek, running S. to the mouth of Buffalo creek, and thence to the N. line of Pennsylvania, which it followed W. and S. to the Ohio. This was confirmed by the treaties of 1789, 1790, and 1794. New York in 1785 and 1788 purchased the lands of the Oneidas, Tuscaroras, Onondagas, and Cayugas, except a reservation for each. The Mohawks had removed to Canada; the Cayugas broke up in 1795, some joining the Senecas, some going to Canada, and some

to the west. In 1826 and 1839 all the Seneca land except the Tonawanda reservation was sold, it is asserted, by persons holding no power in the tribe. In 1840, 430 Oneidas and 500 Senecas emigrated to Canada. In 1820 some Oneidas settled at Green bay, where they purchased lands. A party of several tribes was lured beyond the Missouri in 1846, but nearly all perished. Some Senecas who had joined the Shawnees were more fortunate. The war of 1812 arrayed the English and American Iroquois against each other; but they have since been at peace.—While the league subsisted, each tribe was divided into families, those of the Bear, Wolf, and Tortoise in all the tribes, and others in some only. Each family had certain sachemships hereditary in the female line. These sachems formed the ruling body of the league, Onondaga being the central point or council fire, and the Atotarho or Sagochiendagueta, the head Onondaga sachem, being the chief of the league. No one could marry in his own tribe; the children belonged to the mother's tribe. Their cosmogony was that of the Hurons, and they worshipped Agreskoi by offerings of flesh, tobacco, and human sacrifice. They honored genii or spirits, especially those of maize, pumpkins, and beans. After the labors of the French missionaries, God, under the name Niio (*Dieu*) or Hawenniio (He is the master), seems to have been the object of worship among the so-called pagan party. They interred the dead temporarily, and every tenth year collected all the remains in one long grave lined with furs, adding kettles, arms, &c. Prisoners were either adopted or tortured and put to death at the stake. The men wore a breech cloth, the women a short petticoat, and both wore moccasins, leggins, and in colder weather a fur mantle. The houses were of bark laid over an arched arbor-like frame. In their greatest prosperity they numbered not more than 15,000, and they are now, according to the official American and Canadian reports of 1873, 13,660, distributed as follows: 7,034 in Canada, viz., 759 Mohawks on Quinté bay, 2,992 of the Six Nations on Grand river, 633 Oneidas on the Thames, 1,491 Caughnawagas at Sault St. Louis, 911 at St. Regis, and about 250 at the lake of the Two Mountains; 6,626 in the United States, viz., 5,141 Senecas, Onondagas, Oneidas, Cayugas, Tuscaroras, and St. Regis in New York, 1,279 Oneidas at Green bay, and 206 Senecas in the Quapaw agency. The most eminent men of the nation were Garakonthié, the friend of the French, Dekanisora, Tawerahe, Kryn or the Great Mohawk, Hendrick, Cornplanter, Farmer's Brother, Brant, Red Jacket, Ganeodiyo, the prophet and reformer of the heathen band, Dr. Wilson, Col. Ely S. Parker, who served on Grant's staff and became commissioner of Indian affairs, and Cusick, a Tuscarora, who wrote a curious account of early Iroquois traditional history. The missions of various bodies have made most of the Iroquois Christians; the Mohawks and Oneidas

are Episcopalians; the villages near Montreal are Catholics; Baptists, Congregationalists, and Methodists have also made converts. The language of the tribes was first reduced to grammatical form by the Jesuit Bruyas, who also made a dictionary of the "Radical Words of the Mohawk Language" (New York, 1862); an Onondaga dictionary by an unknown French author was printed in New York in 1860; and a sketch of Iroquois grammar by the Rev. Mr. Cuq in his *Études philologiques sur quelques langues sauvages* (Montreal, 1866). A very full grammar and dictionary by the Rev. Mr. Marcoux remains unpublished. "The Book of Common Prayer" has been several times printed in Mohawk, and prayer books and devotional treatises in the Caughnawaga dialect; and some portions of the Bible in Mohawk and Seneca.—The special works on the tribe are Cusick's "Sketches of Ancient History of the Six Nations" (Tuscarora, 1826); Colden's "History of the Five Nations" (New York, 1727; reprinted, 1866; London, 1747, 1755); Morgan's "League of the Iroquois" (Rochester, 1851); Schoolcraft's "Notes on the Iroquois" (New York, 1846); "The Iroquois, or the Bright Side of Indian Character," by Minnie Myrtle (Anna C. Johnson) (New York, 1855); Stone's "Life of Brant" (2 vols. 8vo, 1838, 1864) and "Life of Red Jacket" (1841, 1866); and Williams, "Life of Tehoraguanegen, alias Thomas Williams" (1859).

**IROQUOIS**, an E. county of Illinois, bordering on Indiana and drained by the Kankakee river; area, 750 sq. m.; pop. in 1870, 25,782. It has a level surface, much of which is prairie, and the soil is generally fertile. The county is traversed by the Chicago branch of the Illinois Central railroad, and by the Toledo, Peoria, and Warsaw, the Gilman, Clinton, and Springfield, and the Chicago, Danville, and Vincennes lines. The chief productions in 1870 were 67,640 bushels of wheat, 23,250 of rye, 799,810 of Indian corn, 430,746 of oats, 27,293 of flax seed, 87,127 of potatoes, 54,495 lbs. of wool, 30,194 of flax, 358,672 of butter, and 63,947 tons of hay. There were 12,716 horses, 10,845 milch cows, 21,135 other cattle, 14,986 sheep, and 21,764 swine; 7 manufactories of saddlery and harness, 1 of cooperage, 1 distillery, and 6 flour mills. Capital, Middleport.

**IRRAWADDY**, *Irawadi*, or *Airavati* ("great river," or "elephantine river"), the principal stream in India E. of the Brahmoputra. It rises on the confines of Thibet and Burmah, at the E. extremity of the Snowy range of the Himalaya, about lat. 28° N., lon. 98° E., flows S. across the territory of Burmah, which it divides into two nearly equal parts, and traverses the state of Pegu in British Burmah, entering the bay of Bengal and the gulf of Martaban by several mouths which form an extensive delta. Its whole length is 1,060 m. It separates 140 m. below the S. frontier of Burmah into two branches, the eastern of which is named the Rangoon or Siriam from

the principal cities on its banks, and falls into the gulf of Martaban, while the western, called the Bassein, enters the bay of Bengal near Cape Negrals. The delta is formed by numerous offsets from both these branches. The Irrawaddy has two striking deviations from its general southerly course: one just below the mouth of the Tapan, about lat. 24° 15', where it makes a bold curve in the shape of the letter S; and the other at Amarpura, where it turns sharply W., and, after receiving the waters of its largest tributary, the Khyen-Dwen, flows successively S., S. W., and again S. The principal cities and towns on its banks are Bhamo (a trading town having a considerable traffic with China), Amarpura and Ava, former capitals, Mandalay, the present capital of Burmah, Pagan, Maloon, Prome, Bassein, and Rangoon. From above the junction of the Khyen-Dwen to Maloon the Irrawaddy spreads itself over a channel reaching during the inundation from June to September to a width of 4 or 5 m. It is then restricted between steep and hilly banks, and does not expand again considerably until it has passed Prome. It is navigable to Ava at all seasons by boats drawing 3 ft. of water, and during the rains vessels of 200 tons can ascend to Bhamo, a distance of 800 m. from the sea. Two steam navigation companies run steamers on the Irrawaddy, making 60 trips a year. Klaproth and the Chinese geographers consider the Irrawaddy a continuation of the Saopo of Thibet; but the latter river is now generally admitted, though not positively ascertained, to be identical with the Brahmoputra.

**IRRIGATION**, the watering of lands by currents distributed over or near the surface, and also by temporarily flooding them. It is one of the oldest of arts, was practised by the ancient Egyptians, Arabians, Assyrians, Babylonians, and Chinese, and has always formed a part of the agriculture of the countries bordering on the Mediterranean. The valley of Mareb in Yemen, Arabia, was irrigated by waters distributed from a vast reservoir made by a dam 2 m. long and 120 ft. high, constructed by an Adite monarch of Saba, probably long before the times of Solomon. This dam was built of enormous blocks of hewn stone, and must have been a work of no mean engineering skill, as it stood and restrained the current of a large stream of 70 tributaries for about 2,000 years, when it burst with desolating effect. The canal of the Pharaohs, connecting ancient Pelusium with the Red sea, was constructed for purposes of irrigation. The plains of Oman in Arabia are watered by subterranean canals supplied by reservoirs in the mountains, and a vegetation of rare luxuriance, consisting of most of the fruits and grains of Persia and India, is produced in consequence. The plains of Assyria and Babylonia were covered with an immense system of canals, some of them hundreds of miles in length, intended partly for irrigation and part-



for navigation; and their ruins are among the interesting antiquities of those countries. Into some of these canals the water was raised by machines which consisted of rude buckets worked by oxen, in much the same manner still practised on the banks of the Tigris and Euphrates. Among the ancient Egyptians irrigation was performed with water flowing directly from the Nile, or raised out of it, or, as was often the case, from wells. The most ancient machine was the sweep, or bucket suspended from a balanced pole, such as was generally used many years ago in this country, and still in some parts at the present time. Afterward the chain of pots, or *sabiya*, was used, it also was by the Assyrians and Babylonians. The present water is raised from the Nile by means of Persian wheels, which differ from the chain of pots by the vessels being hung upon the periphery of a large wheel, and so adjusted as to tip over and empty their contents into a trough when they arrive at a certain height, instead of being placed upon an endless chain or rope.—In the agriculture of Italy, France, and Spain great attention is paid to irrigation. The Romans during several centuries constructed extensive works, which are still in use. The water is carried not only over the grass lands and the rice fields, but between the ridges in the grain fields and through the meadows round the roots of the vines. The distribution of it is controlled by a regular system. The state itself claims the waters of all the rivers of Lombardy; and in the Venetian territories all the springs and collections of rain water belong to the government. The use of the waters of the rivers is rented out at a certain price by the hour or half hour, or for so many days at certain seasons of the year. Persons are entitled to make canals through the lands of others lying between them and the river, on paying for the damage thus caused. The channels for leading the water into the fields and the parallel channels alternating with them, placed at about 6 in. lower elevation for conveying the water away, are laid out with great regularity, at distances usually of about 100 ft. between them. In summer the water is allowed to flow through them for several hours about once a week, but the flow is steadily kept up from October to April, except at the time of cutting the grass. In northern Italy lands that can be irrigated rent for one third more than the same class of lands not thus improved. On the American continent, the ancient inhabitants of Peru were found by their Spanish conquerors in the use of the most costly works constructed for irrigating their lands. Prescott says: "Canals and aqueducts were seen crossing the low lands in all directions, and spreading over the country like a net network, diffusing fertility and beauty around them." In the article *AQUEDUCT* the wonderful magnitude of some of these works has been noticed. The Aztecs of Mexico also made use of similar means to counteract the

natural dryness of their atmosphere; and in the beautiful gardens of Iztapalapan, watered by canals and aqueducts, and moistened by the spray of fountains, was exhibited to the astonished Spaniards a perfection of horticulture at that time unknown in their own country.—Irrigation on a large scale and by the Italian method was attempted in England in the 16th century, on the estate of Babraham in Cambridgeshire; but the system was not fairly established as an important branch of agriculture until the commencement of the present century. Of late years what are called water meadows have become a common feature in some of the best cultivated counties, especially in Wilts, Devon, Somerset, and Gloucester, and also in the southern part of Scotland. Some peculiar methods have been introduced, as that of irrigating with currents of liquid manure; and the sewerage of Edinburgh is distributed on the same principle with the most beneficial results over the meadows that lie below the level of the city. The grass grown upon the meadows thus watered has to be cut about once a month from April to November, and it is described as remarkably tender and succulent, admirably adapted as a milk-producing food for cows. With some exceptions the general practice is not to leave the water standing upon the lands; but taking it from a running stream (which should be tapped if practicable far enough above the meadow for the water to flow in from the bottom of the current, where it is most charged with sediment), it is conveyed in a main channel around the further margin of the meadow, and numerous side branches lead off in nearly parallel lines into its central portions, each tapering to a point. These are commonly interlocked by others proceeding in the opposite direction from the main channel, on the lower side of its circuit, as it passes back to the river. The second set, being at a lower level than the first, serve as drains, conveying the water that overflows from the first to the main channel, which in the latter part of its course is no longer a feeder but a drain. The water is allowed to flow through this system as often as may be desirable, care being taken that it shall not lie at rest at any time, the effect of which is found to be a tendency to cause the growth of a coarse grass. This method is called *bed-work irrigation*, from the ground being laid out in nearly regular beds by the channels. It is applicable only to tolerably level land. By another method, called *catch work*, irrigation is conveniently applied to uneven ground. One set of channels follow the contour lines of the ground, each retaining its own level. These are crossed nearly at right angles by numerous other small channels, which are fed at their upper ends by the main gutter, and the water is directed by stops of clods of earth into the level side channels, which are filled as may be desired. The laying out of the work and management of the operation, so as to distribute the water uniform-

ly, in the proper quantities, and at the right times, require good judgment, close attention, and much experience. The irrigating season in England is the colder portion of the year, commencing in October or November, and terminating in March or April. The letting the water on or off during frosty weather is to be avoided, as a crust of ice may root out the grass as it thaws. As nearly as may be, with reference to this danger, the water is allowed to flow through the channels for two or three weeks at a time, and is then drawn completely off, so that the ground may become as thoroughly dry as possible. In this condition it is left for five or six days, when if there is no fear of freezing the operation is repeated; and so on through the winter. When the grass begins to vegetate, the periods of irrigation should be shortened, and cease entirely when it is sufficiently forward to make good pasture. The effect of this practice is often very striking; the grass is brought forward very early in the spring. After feeding off one crop or mowing the grass, the land is sometimes again irrigated for a short time to great advantage. A second crop is ready to be cut by the time the first has ripened on the dry meadows. Three or four crops of grass are thus obtained in each season.—But the perfection of irrigation is when it is combined with thorough under-draining. The water flowing in brings with it in solution and suspension various mineral and organic substances suitable for the food of plants. By evaporation and by various chemical reactions the soluble ingredients may be set free, when they become entangled with the other foreign matters in the grass and in the soil beneath, both of which act as filters. Thus the finely comminuted sediments and the soluble salts are equally distributed among the rootlets, and these are refreshed by the new supplies furnished by each repetition of the process. By the drains the excess of moisture is soon removed, stagnation, so injurious to vegetation, is prevented, and the elements that feed the plants below the surface are kept in a similar condition of healthy renewal with those of the air circulating among the branches and adding to the vegetable growth by assimilation going on through the leaves. The benefits derived from the process vary of course with the quality of the ingredients brought in by the water, according as these are more or less suited to the requirements of the soil and of the crop. The hard water, charged with carbonate of lime, which it has gathered in flowing through a limestone region, brings a valuable fertilizing ingredient to silicious soils deficient in lime; and the clayey sediment washed out of alluvial bottoms is spread with the most beneficial effect over loose sandy soils. Sometimes organic liquid manures, such as the drainage of farmyards and leachings of compost heaps, are supplied to the soil by being mingled with the water used in irrigating; but the principal object of irrigation is to supply mois-

ture, as it is always easy to add manure in a solid form.—Much attention is now given to the subject of irrigation in that portion of the United States lying between the Mississippi river and the Rocky mountains; so that a vast region, some of which was long known as the Great American desert, bids fair in time to be for the most part brought under fair cultivation. The Mormons in Utah by means of irrigation render their barren country fertile. The general plan with them, and also in California, is to lead the water in canals from the rivers or the mountains, and allow it to flow over the fields, either through small channels made in the soil, or over the even surface.

**IRVINE**, a parliamentary borough and seaport of Ayrshire, Scotland, on both banks of the river of the same name, 1 m. above its entrance into the Firth of Clyde, 20 m. S. W. of Glasgow; pop. in 1871, 6,866. It has a female academy, ship yards, and some manufactories of book muslins, jacanets, and checks. The harbor, having become shallow from sand bars, now admits only vessels of about 100 tons.

**IRVINE, William**, an American soldier, born near Enniskillen, Ireland, about 1742, died in Philadelphia, July 20, 1804. He graduated at Dublin university, studied medicine and surgery, and was appointed surgeon on board a ship of war, serving during a part of the war of 1756-'63 between Great Britain and France. On the declaration of peace he emigrated to America, and in 1764 settled in Carlisle, Pa. At the opening of the revolution he took part with the colonics. He was a member of the provincial convention assembled July 18, 1774, until he was appointed by congress, Jan. 19, 1776, colonel of the 6th battalion of the Pennsylvania line, and was ordered to join the army in Canada. He was made prisoner at the battle of Three Rivers in June of the same year, and was released on parole, Aug. 3, but was not exchanged until April, 1778. In July, 1778, he was a member of the court martial which tried Gen. Charles Lee. On May 12, 1779, he was promoted to the rank of brigadier general, and was assigned to the command of the 2d brigade of the Pennsylvania line. In the unsuccessful attack of Gen. Wayne at Bull's Ferry, July 21 and 22, 1780, he commanded his brigade. In the autumn of 1781 he was ordered to Fort Pitt, to take command of the troops on the western frontier, where he remained till Oct. 1, 1783. In 1785 he was appointed agent for the state under an act for directing the mode of distributing the donation lands promised to the troops of the commonwealth." He became a member of congress in 1787, and was selected, with Messrs. Gilman and Kain, one of the commissioners for settling the accounts of the United States with the several states. He was a member of the convention for revising the constitution of Pennsylvania, and again from 1793 to 1795 a member of congress. In 1794 he was assigned to the command of the Pennsylva-

nia troops for quelling the "whiskey insurrection," and took an active part in all the most important movements. In March, 1801, he was appointed superintendent of military stores at Philadelphia. He was president of the state society of the Cincinnati at his death.

IRVING, Edward, a Scottish preacher, born at Annan, Dumfriesshire, Aug. 4, 1792, died in Glasgow, Dec. 8, 1894. He graduated at the university of Edinburgh in 1809, in his 19th year was appointed mathematical teacher in an academy at Haddington, and in 1813 rector of an academy at Kirkcaldy, where he remained seven years, pursuing at the same time the studies required of a candidate for the ministry of the church of Scotland. He was licensed to preach by the presbytery of Annan in 1815, but received no invitation to settle as a pastor, and continued to teach till 1818, when he went to Edinburgh. In 1819 he became Dr. Chalmers's assistant in Glasgow, where he continued three years, when he resigned, having been called to the charge of the Caledonian church, Hatton Garden, London, a small remnant of a congregation in connection with the church of Scotland. He was ordained by the presbytery of Annan, and entered upon his ministry in 1822. Within a few months of his settlement there crowds pressed to his weekly services. The nobility, members of parliament, judges and barristers, physicians, clergymen, dissenters, and noted beauties besieged the doors, attracted no less by the eloquence and power than by the plain-spoken originality of the preacher. With a view to break up the routine habit of mind, which he conceived destroyed the effect of preaching generally, he adopted a style of discourse different from the usual form of sermon, which he called "orations." A series of these, entitled "Orations for the Oracles of God," which were preached in 1823, he published in the same year in a volume with another series entitled "An Argument for Judgment to Come, in Nine Parts." This was the first of his published writings. In 1824 the foundations of a new church in Regent square were laid, which was intended to more fully accommodate his thronging audiences. In this year he was called upon to deliver a missionary discourse, the sentiments of which were so contrary to the views of the London missionary society for which he preached, as to occasion much dissatisfaction. This discourse was published about a year after its delivery, much enlarged, under the title "For Missionaries after the Apostolic School, a Series of Orations, in Four Parts: Part I., the Doctrine." The other three parts never appeared. In 1825 he delivered a course of lectures, afterward published, entitled "Babylon and Infidelity Foredoomed." On Christmas day of the same year he first began to make known his convictions in relation to the second and personal advent of the Lord Jesus Christ, and the nearness of that great event.

In 1826 he fell in with a Spanish work entitled "The Coming of Messiah in Majesty and Glory, by Juan Josafat ben Ezra," which purported to be written by a Christian Jew, but was in reality the work of Lacunza, a South American Jesuit. He undertook the translation of this work, which confirmed his attention to the subject of Messianic prophecy, and from this time it became a leading thought with him. He wrote an introduction, which occupies half of an octavo volume, and which is regarded as one of his best works. The book appeared in 1827. About the same time his attention was called by the death of one of his children to the subject of infant baptism, which resulted in a series of "Homilies on the Sacraments," of which only the first volume, on baptism, was published (12mo, 1828). From this he was led to enter more fully into the great doctrine of the incarnation, to the exposition of which he devoted much labor, both in preaching and in controversial writings; affirming the perfect oneness of Christ with us in all the attributes of manhood, including its infirmities and liability to temptation. On this account he was charged with asserting the sinfulness of Christ's human nature. What he really taught was, that Jesus Christ took from his mother human nature, such as it was in Adam after the fall, though in him without actual sin. It is asserted that his teaching on this subject was the origin of a revival of a similar strain of teaching in a portion of the English church. In 1828 he visited Scotland, and preached to thronging congregations in the principal places. At Kirkcaldy, his old home, the crowded galleries of the old church fell, and about 85 persons were killed. At this time he opposed the abolition of the test act, advocated by Chalmers, and in 1829 published a book entitled "Church and State," arguing for an organic connection between the two. In 1830 he was tried by the London presbytery for heretical views of the incarnation. He resisted the authority of the presbytery, on the ground of irregularity in the trial, and left them, appealing to the church of Scotland. In this he was sustained by his own church with great unanimity. All this time the interest in the study of prophecy was kept alive by Irving and his friends, and took practical form in a series of conferences of those interested which were held at Albury park, Surrey, under the patronage of Henry Drummond, Esq., and by the publication of a quarterly periodical entitled "The Morning Watch," to which Irving was a copious contributor. In the spring of 1830 reports came to London of some remarkable phenomena in the neighborhood of Port Glasgow in Scotland, consisting of what appeared to be supernatural utterances, *i. e.*, words spoken under the impulse of a supernatural power, partly in the vernacular and partly in forms of language that were not known, and in connection with them the healing of the sick. When this report was

received, some of the persons associated with Mr. Irving in the study of prophecy, and in the hope of the second coming of Christ, deemed it proper to investigate the matter. Accordingly, several gentlemen residing in London made a journey to Glasgow to inquire into the nature of these phenomena. After a careful scrutiny these persons were satisfied that it was in reality a revival of the "spiritual gifts" common in the first ages of the church, and specially referred to in St. Paul's epistle to the Corinthians. Soon after the same phenomena appeared in London, at first in private meetings of members of the established church, and afterward in Irving's congregation. A full account of these "spiritual gifts" was given by Irving himself in "Fraser's Magazine" in 1830. The consequence of his course in this matter was the loss of his great popularity, and an opposition in his own congregation. His writings were censured by the general assembly of 1831, and in 1832 this opposition resulted in his expulsion by the trustees from the building which had been erected for his use, after a hearing before the London presbytery. His adherents, numbering about 800 communicants, met at first in a hall in Gray's Inn road. They resolved to build, and money was collected for the purpose, but were forbidden by utterances which they regarded as divine; and after some months they hired a house in Newman street, with a hall which had been used by West the artist as a picture gallery, the house being taken for a parsonage. Irving was now (March, 1833) arraigned before the presbytery of Annan in Scotland upon a charge of heresy and irregularity, and deposed. His defences are among his best oratorical efforts. The portion of the congregation that adhered to him retained at first the Presbyterian order of worship and constitution of membership; but this was early modified through the agency of the prophetic utterances which abounded among them. Attention had been directed to the restoration of apostles and prophets as the most fundamental constituent of the church; and some time in 1832, at a meeting for prayer held in a private house, it is asserted, one of those present was declared in the word of prophecy to be an apostle, and exhorted to the exercise of his office, in conveying "the Holy Ghost by the laying on of hands." When Mr. Irving had been deposed in Scotland he ceased, in obedience to what he believed to be a spiritual utterance, from fulfilling priestly functions, confining himself to the work of a preacher or deacon until he should receive a new ordination from the spirit. On April 5, 1833, he believed that this supernatural ordination was conferred, when by the hands of the apostle he was constituted "angel," or chief pastor or bishop of the church. Wilks says ("Life of Edward Irving," London, 1854): "It seems to be generally supposed that Irving appointed the apostles, not that he was appointed by

them." The facts are the reverse of this. The movement did not begin in his church, nor as the result of his teaching, although he at an early period gave his adhesion to it. That he held a prominent position in the movement is manifest, but the form which it took was not the result of any plan or theory of his, nor was it fully and finally developed until some years after his death. Not long after these events his health failed. In the autumn of 1834 he set out, in obedience as he supposed to the word of the Holy Spirit, on a journey to Scotland, where he died. His personal characteristics were striking. He was at least six feet high; his limbs were well proportioned; black hair clustered in profusion over his lofty forehead, and descended in curls upon his massive shoulders; his eyes were dark and piercing, though affected by a squint; on his lips sat the firmness of a ruler and trembled the sensibility of a poet. He associated and lived in the world without restraint, joining in the forms and fashions of a mixed society, and was remarkable at the same time for blamelessness of life. His morals were untainted, his conscientiousness exact. A collection of his "Sermons, Lectures, and Occasional Discourses" was published in 1828 (3 vols. 8vo, London). Since his decease two series of his works have been published under the editorship of his nephew, the Rev. G. Carlyle: the one entitled "The Collected Writings of Edward Irving" (5 vols., London, 1864-'5); the other, "The Prophetic Works of Edward Irving" (2 vols., London, 1867-'70). Mrs. Oliphant's memoir of him (1862) is very complete, and in the main accurate; and a review of it in the "New Englander" for July and October, 1863, supplements it in a very satisfactory manner.—The church in Newman street became the centre of a widely extended community, which began very rapidly to spread throughout the British isles. In the next two years after Irving's death additional persons were called to be apostles, until the number of twelve had been completed, when they were as a whole set apart, or separated to the work to which they had been called, and gradually the organization of the church was perfected. The constitution of this body claims to be the perfect development of that which was established in the beginning of the Christian church. Its characteristic feature is the fourfold ministry of "apostles, prophets, evangelists, and pastors and teachers," referred to by St. Paul in chapter iv. of his Epistle to the Ephesians. Within this fourfold classification are comprehended the three orders of the church catholic, bishops, priests, and deacons. The collective apostolate is the head of the episcopate, and holds the relation of centre of unity to the whole church. The body declines any name but that of the "Catholic Apostolic Church," holding this not exclusively of all other churches, but as the only name by which the church should consent to be known. The

claims all sectarian aims. It assumes to be the work of the Holy Spirit, the blessing of the entire Christian world throughout the world. It does not profess to be a new system, but is content with bearing witness to the truth and strengthening all to maintain the truth. It recognizes the baptized as members of the one and each several Christian community to the measure of the truth it holds. Its system of teaching, worship, and sacraments is founded upon the doctrine of the one God, or the true and real manhood of Jesus Christ, and its application to means of sacraments and ordinances. The Lord, and all ministries on earth are performed by which his presence is made in the church. The worship is conveyed by means of a ritual which embodies the rituals in use in all different parts of the church, Greek, Roman, and others. It makes use of material emblems as far as they are significant of spiritual truths. Architecture, music, and painting, of divers colors, incense, lights, all employed as symbols of spiritual truths. Numbers and means admit, the worship conducted with all the magnificence and importance justifies, while it is also adapted to very narrow circumstances. The eucharist is celebrated every day. Daily morning and evening worship maintained. All the members pay their increase, which are applied to the support of the priesthood, besides offerings for other purposes. The great object of the church is the glorification of the Lord Jesus Christ, when in Christ shall be raised, and they looking for him shall undergo the resurrection of their bodies which is spoken of by Paul in 1 Cor. xv. About the year 1846 the movement began to spread into other parts of the world, especially Germany. There are now many churches, which collectively represent the unity of the whole church. The first churches and congregations in the United States (1874), including these, is between 100 and 200. In north Germany there are nearly 100 in Switzerland six or eight; and there are many congregations in other countries. There are no published statistics which show the number of ministers or people obtained; they amount to several millions. In the United States there is only one organized church; this is in New York. There are four smaller congregations connected with it in Connecticut and New Jersey. In Canada there are four churches.—The works throw but little light on the principles of the church as such. Some of the works relating to it are: "The Liturgy of the Divine Offices of the Church;" "The Liturgy of the Church" (1 vol. and 2 parts. London, 1851); "Chronicle of Ceremonies which have taken place in the

Church of Christ, principally in England, between the Years 1826 and 1852" (London, 1852); "Defence of John Canfield Sterling, Presbyterian," &c. (New York, 1852); "A Letter from David Morris Fackler to the Right Rev. G. W. Doane, Bishop of New Jersey" (New York, 1852); "The Permanency of the Apostolic Office as distinct from that of Bishops, with Reasons for believing that it is now revived in the Church, by a Presbyterian of the Protestant Episcopal Church" (New York, 1852); "The True Constitution of the Church and its Restoration," by the Rev. William Watson Andrews (New York, 1854); "The True Apostolic Succession, a Letter to Rev. Francis Vinton," by John S. Davenport (New York, 1858); "Edward Irving and the Catholic Apostolic Church," by the same (1863); "The Purpose of God in Creation and Redemption," the most complete exposition of the principles of the movement (Edinburgh, 1865); and "Christian Unity and its Recovery," by John S. Davenport (1866).

**IRVING, Theodore**, an American clergyman, nephew of Washington Irving, born in New York, May 9, 1809. At the age of 19 he joined his uncle in Spain, and resided for three years in Madrid, Paris, and London, attending lectures, and devoting himself to the study of modern languages. He was appointed professor of history and belles-lettres in Geneva (now Hobart) college, New York, in 1836, which post he occupied for 12 years. In 1848 he was chosen to be professor in the same department in the free academy (now college of the city) of New York, but resigned in May, 1852. Two years later he entered the ministry of the Episcopal church, and became rector of Christ's church, Bay Ridge, L. I.; was for many years rector of St. Andrew's and afterward of Ascension parish, Staten Island; and is now (1874) rector of St. John's school for young ladies, New York city. He has published "Conquest of Florida by Hernando de Soto" (1835; new ed., 1857), and devotional works entitled "The Fountain of Living Waters" (1854; 4th ed., 1855), "Tiny Footfall" (1869), and "More than Conqueror" (1873).

**IRVING, Washington**, an American author, born in New York, April 3, 1783, died at Sunnyside, near Tarrytown, N. Y., Nov. 28, 1859. He was the youngest son of William Irving, who was descended from an ancient family in the Orkneys; his mother was English. Washington Irving left school in his 16th year, and began the study of law. But his passion was for literature, and in 1802 he commenced in the "Morning Chronicle" a series of papers on dramatic and social subjects and local occurrences, under the signature of "Jonathan Oldstyle." In 1804, being threatened with consumption, he visited Europe, spending several months in the south of France and Italy. At Rome in 1805 he became intimate with Washington Allston, and under his tuition made a serious attempt to become a painter, but was

satisfied at the end of three days that his talent was not for art. He next visited Switzerland, the Netherlands, Paris, and London, and returned home in March, 1806, to resume his law studies; but he never practised. With his brother William and James K. Paulding he started a serial entitled "Salmagundi, or the Whim-Whams and Opinions of Launcelot Langstaff, Esq., and others," which appeared at irregular intervals in small 18mo, published by an eccentric bookseller named David Longworth. The first number was issued on Jan. 24, 1807. Its local allusions, personal hits, and constant vein of humor gave it immediate success, and it reached the 20th number. It is understood that the poetical epistles were contributed by William Irving, and the prose papers about equally by himself and his two associates. "Salmagundi" found favor also on the other side of the Atlantic. In 1809 appeared "A History of New York, from the Beginning of the World to the End of the Dutch Dynasty, &c., by Diedrich Knickerbocker." This was begun by Peter and Washington Irving as a burlesque on a hand-book of the city of New York which had just been published; but Peter soon sailed for Europe, and Washington elaborated the work and extended it to two volumes. Previous to its appearance an advertisement was inserted in the "Evening Post" inquiring for "a small elderly gentleman dressed in an old black coat and cocked hat, by the name of Knickerbocker," who was said to have disappeared from the Columbian hotel in Mulberry street, and left behind "a very curious kind of a written book." The work was accepted by many respectable but somewhat stupid readers as a veritable history, and Goller, a German editor, gravely cites it in illustration of a historical passage. Some of the descendants of the old Dutch families were seriously offended by its burlesque of their ancestors, and Irving finally found it necessary to insert an apologetic preface. In 1810 he wrote a sketch of Thomas Campbell for a Philadelphia edition of his poems, and in 1813-'14 edited the "Analectic Magazine" in Philadelphia, to which he contributed several biographies of American naval commanders. In 1814 he became aide-de-camp and military secretary to Gov. Tompkins, and in 1815 sailed for Europe, having meanwhile become a silent partner in the mercantile business of two of his brothers. In London he was intimate with many of the literary men of the day, especially Procter and Campbell, and by the latter was introduced to Scott at Abbotsford. Irving's house soon became bankrupt, and he was compelled to write for a living. His rambles about England and Scotland had given him much of the material for the "Sketch Book," which was sent home in fragments and published in pamphlet numbers during 1818. Several of the sketches were copied in the London "Literary Gazette," and Irving offered the work for republication to Murray and Constable, by each of whom it

was declined, in spite of Scott's warm recommendation. He then put the first volume to press at his own expense (1820), but the failure of the publisher stopped its issue. In this crisis Scott arrived in London and prevailed upon Murray to purchase the manuscript for £200, which price he doubled when the book proved successful. The "Sketch Book" contained "Rip Van Winkle" and the "Legend of Sleepy Hollow," which are perhaps the most widely celebrated, and are certainly the most strikingly original, of all his creations. He spent the winter of 1820 in Paris, and in 1821 wrote "Bracebridge Hall, or the Humorists" (2 vols., London, 1822), producing 120 pages of it in ten days. Murray paid 1,000 guineas for the copyright, without seeing the manuscript. Irving passed the next winter in Dresden, returned to Paris in 1823, and in 1824 published his "Tales of a Traveller" (2 vols., London, for which Murray paid £1,500. This work met with severe criticism on both sides of the Atlantic. In 1826 Alexander H. Everett, United States minister to Spain, commissioned Irving to translate the documents relative to Columbus which had just been collected by Navarrete. With this material at command he wrote his "History of the Life and Voyages of Christopher Columbus" (4 vols., London, 1828), for which he received 3,000 guineas from the publisher and one of the 50-guinea gold medals offered by George IV. for historical composition. This history gained immediate popularity, and was highly praised by the reviewers, more than restoring the favor which its author seemed to have lost by his preceding work. After a tour in the south of Spain he published his "Chronicles of the Conquest of Granada" (2 vols., London, 1829), for which Murray paid £2,000, losing money by it. The "Voyages of the Companions of Columbus" appeared in 1831, and in 1832 the "Alhambra" (2 vols., London), a portion of which was written in the old Moorish palace, where Irving spent three months. In July, 1829, he had returned to London, having been appointed secretary of the American legation there. In 1831 the university of Oxford conferred upon him the degree of LL. D. The recall of the minister deprived him of his office, and in May, 1832, he returned to New York, where a public dinner, at which Chancellor Kent presided, was given in his honor. In the summer of the same year he accompanied Commissioner Ellsworth in the removal of the Indian tribes across the Mississippi, and the result was his "Tour on the Prairies" (1835), which, together with "Abbotsford and Newstead Abbey" (1835) and "Legends of the Conquest of Spain" (1835), forms the "Crayon Miscellany." "Astoria" (2 vols., Philadelphia, 1836), which professes to give the early history of the fur station of that name in Oregon, was written from the author's remembrance of visits in his youth to the station of the northwest fur company at Montreal, and from documents fur-

by John Jacob Astor. The "Adventures of Captain Bonneville, U. S. A., in the Mountains and the Far West," was published in 1837 (2 vols., Philadelphia), and in 1849 Irving contributed to the "Knicker-Magazine" a series of articles which were collected in a volume entitled "The Roost" (New York, 1855). In 1855 he wrote a life of Margaret Miller Davidson to accompany her posthumous works. He was appointed States minister to Spain from 1842 and on his return prepared for publication in a separate form his biography of Oliver Goldsmith (New York, 1849), which was originally published in a Paris edition of Goldsmith's works and also published in London as "Mahomet and his Works" (2 vols., New York, 1850), compiled from materials collected in Madrid. In 1850, at the suggestion of Mr. G. P. Putnam, he revised his entire works, which were published in 15 uniform volumes, with a large sale. Irving's last, longest, and most elaborate work, "The Life of Washington" (5 vols., New York, 1855), occupied the remainder of his life, the volume appearing only three months before his death.—From the time when the "Book" was published Irving had a large circle of appreciative readers, which has since been enlarged. In the department of pure fiction he was the earliest classic writer of the age, and in the opinion of many he remains the first. The remarkable clearness and freshness of his English, the freshness of many of his ideas, and the genial spirit in which he wrote, all seem to have secured for his works a permanent active circulation. During his lifetime 600,000 volumes were sold in America; since his death the sale has averaged 30,000 a year. On account of the death of a young lady to whom he was betrothed, Matilda Hoffman, he never married. Several years before his death he resided on the east bank of the Hudson, near Tarrytown, in an old Dutch mansion which he christened "Sunnyside." This place is the scene of "Legend of Sleepy Hollow," and Irwin House was the original of the castle of van Tassel. In private life Irving was even-tempered, hospitable, genial, and conversant with an almost feminine delicacy of manners and conversation. He was a member of the Episcopal church. He died of a disease of the heart, and was buried in the graveyard at Tarrytown, the funeral procession passing through the famous "Hollow." His "Life and Letters" (New York, 1861-7) was edited by his nephew Pierre M. Irving, who also compiled and edited his "Spanish Papers, and Miscellaneous Writings" (3 vols., 1866).

IRWIN, a S. county of Georgia, bounded by the Altamaha river, and traversed by the Altamaha river, about 1,000 sq. m.; pop. in 1870, 2,900, of whom 296 were colored. It has a level face and a sandy soil, which is not

very fertile except in the S. E. part. Pine forests occupy a large portion of the land. The Brunswick and Albany railroad touches the S. W. corner. The chief productions in 1870 were 27,875 bushels of Indian corn, 15,165 of oats, 23,220 of sweet potatoes, 16,510 lbs. of wool, and 153 bales of cotton. There were 257 horses, 9,021 cattle, 7,872 sheep, and 7,458 swine. Capital, Irwinville.

**ISAAC** (Heb. *Yitzhak*, will laugh, whose birth caused laughter), the second patriarch of the Hebrews, son of Abraham and Sarah, younger brother of Ishmael, and father of Jacob and Esau by Rebekah. The narrative of his life is contained in Genesis, according to which he was born when his father was 100 years old, was circumcised on the 8th day of his life, was about to be sacrificed by his father on Mt. Moriah, but was saved by divine interposition, lived partly as a nomad, partly as an agriculturist, in the southern region of Canaan and in Philistia, and died blind at the age of 180, after bestowing his chief blessing on his younger son Jacob, who, by the advice of his mother, had disguised himself to resemble Esau.

**ISAAC I., Comnenus**, a Byzantine emperor, died in 1061. He was the son of Manuel Comnenus, prefect of the East, but early lost his father, and was brought up by the emperor Basil II. He married the daughter of the captive king of Bulgaria, and was living privately in Paphlagonia when in 1057 a conspiracy raised him to the throne in the place of Michael VI. He repulsed the Hungarians in 1059, but was a weak and incompetent ruler, and the same year abdicated and retired to a monastery, where he remained till his death. He left no son, but the family of Comneni, after an interval of 20 years, occupied the Byzantine throne for a century.

**ISAAC II., Angelus**, a Byzantine emperor, born in 1154, put to death in 1204. A descendant of the Comneni through his grandmother, he held various offices under the emperor Manuel I. He fell under the displeasure of Andronicus Comnenus, who ordered him to be put to death; but a popular revolution delivered him and placed him upon the throne in 1185. He made himself detested by his vices and incapacity, and was dethroned by his brother Alexis III. in 1195, and deprived of his sight. When the crusaders took Constantinople in 1203, they restored Isaac to the throne; but he was again dethroned and put to death by Alexis Ducas in the following year.

**ISABELLA**, a central county of the southern peninsula of Michigan, intersected by Chippewa river; area, 576 sq. m.; pop. in 1870, 4,113. The surface is nearly level, and mostly covered with forests, principally of pine and sugar maple. The Flint and Pere Marquette railroad crosses the N. E. corner. The chief productions in 1870 were 27,786 bushels of wheat, 18,984 of Indian corn, 21,382 of oats, 39,001 of potatoes, 87,854 lbs. of butter, and 4,268 tons of hay. There were 568 horses, 867 milch

cows, 1,532 other cattle, 1,911 sheep, and 1,375 swine. Capital, Mt. Pleasant.

• **ISABELLA I.**, the Catholic, queen of Castile and Leon, born in Madrigal, Old Castile, April 23, 1451, died Nov. 26, 1504. She was the daughter of John II. of Castile by his second wife, Isabella of Portugal, and was therefore descended through both parents from the famous John of Gaunt, duke of Lancaster. She was little more than three years old when her father died, leaving his crown to Henry, the offspring of his first marriage with Maria of Aragon. Until her 12th year Isabella lived with her mother in retirement in the small town of Arevalo. On the birth of the princess Juana, Henry removed his sister to court, the better to prevent the formation of a party for securing the succession to her instead of Juana. Remote as seemed her chances of a crown, with her elder brother on the throne, an heir to his body, and another brother living, Isabella was yet thought a fit match for the first princes of Europe. "Her hand was first solicited," says Prescott, "for that very Ferdinand who was destined to be her future husband, though not till after the intervention of many inauspicious circumstances." She was next, at the age of 11, betrothed to his brother Carlos, aged 40. This unequal union was prevented by the death of Carlos by poison, and in 1464 Henry promised her hand to Alfonso of Portugal. Isabella opposed this summary disposition of her person, saying that "the infants of Castile could not be given in marriage without the consent of the nobles of the realm." An insurrection, headed by the marquis of Villena and his uncle, the archbishop of Toledo, had been stirred up partly by the belief of many nobles that the princess Juana (often known as *la Beltraneja*), to whom the king had caused the oath of fealty to be taken, was the offspring of an amour between the queen and the royal favorite Beltran de la Cueva. The confederates proclaimed the transfer of the sceptre from Henry to his brother Alfonso, and collected an army to support their cause. Henry sought to detach the chief conspirators by marrying Isabella to the brother of the marquis of Villena, the profligate Don Pedro Giron, grand master of the order of Calatrava. The princess vowed to plunge a dagger into Don Pedro's heart rather than submit to such dishonor, but the grand master died suddenly on his journey to the nuptials. Two years later (1468) Alfonso died, and the insurgents offered the crown to Isabella. She refused it, but expressed her willingness to succeed her brother; and an accommodation was soon effected with Henry, by the terms of which the queen was to be divorced, and Isabella was recognized as heir to Castile and Leon, with the right to choose her own husband, subject to the king's approval. Isabella's claim to the succession was soon afterward solemnly ratified by the cortes. Henry paid little regard to the terms of this agreement,

and made another effort to force her to marry the king of Portugal. Policy and affection inclined her to the suit of Ferdinand, prince of Aragon, and, incensed at her brother's threats of imprisonment, she resolved to take matters into her own hands, and returned the Aragonese envoy a favorable answer. Ferdinand signed the marriage contract at Cervera, Jan. 7, 1469, guaranteeing to his consort all the essential rights of sovereignty in Castile and Leon. Henry at once despatched a force to seize his sister's person, but Isabella escaped to Valladolid, and sent word to Ferdinand to hasten the marriage. The young prince, unable to procure an escort, as his father was then at war with the insurgent Catalans and utterly bankrupt, travelled in the disguise of a servant with six companions to Osma, escaping the troops of Henry posted to cut off his progress, and thence journeyed in more fitting state to Valladolid, where the marriage ceremony took place, Oct. 19, 1469. Henry now declared Isabella to have forfeited all the advantages guaranteed by the previous treaty, and proclaimed Juana his lawful successor. The kingdom became divided by two hostile factions, Henry receiving the countenance of France, but Isabella gradually winning the affections and allegiance of the Castilians by her virtues and sagacity. At length, on Dec. 11, 1474, the king died, and two days later Isabella was proclaimed queen at Segovia. Most of the nobles swore allegiance, but the party of Juana was still powerful, and it was not until after a war with Alfonso of Portugal, who had been affianced to Juana, that the queen's authority was fully recognized. From this time her career was brilliant. She applied herself to reform the laws and internal administration of the realm, to encourage literature and the arts, and to modify the stern and crafty measures of her husband. Though the life and soul of the war against the Moors, in which she personally took part, even wearing armor, which is still preserved at Madrid, she was opposed to the cruelty which was then the established policy toward that people; and if she decreed the expulsion of the Jews from Castile, and gave a reluctant consent to the introduction of the inquisition, it was from a conviction that the safety of the Catholic faith demanded this sacrifice of her private feelings. The encouragement of Christopher Columbus is the deed by which she is best known to posterity; the squadron with which he discovered America was equipped at her expense. She opposed the reduction of the Indians to slavery, and when a cargo of these captives was sent by Columbus to Spain, she ordered them to be transported back to their own country. With the aid of Cardinal Ximenes she reformed the religious orders, establishing thereby as firm a discipline in the church as she had already introduced into the state. Neither wealth nor station ever shielded criminals from her displeasure, and the sword of justice fell with



equal certainty upon the nobility, the clergy, and the common offender. The masculine intellect, the feminine charms, and the rare virtues of Isabella have been a favorite theme for historians of all subsequent times, and the affection in which all her subjects held her person is still cherished throughout Spain for her memory. The sudden deaths of Don Carlos, Don Pedro Giron, and her brother Alfonso, so opportunely for her interests, left no stain of suspicion upon her. For Ferdinand she always entertained the warmest affection, which was not always faithfully returned. Her genuine piety colored every action of her life. In person she was equally beautiful as in character. She had a clear complexion, light blue eyes, and auburn hair. She had five children: Isabella, married to Emanuel of Portugal; Juan, a virtuous prince, who died in 1497, aged 20; Juana, who married Philip, archduke of Austria, and was the mother of the emperor Charles V.; Maria, who espoused Emanuel after the death of her sister; and Catharine, the wife of Henry VIII. of England. (See FERDINAND V.)

**ISABELLA II.** (MARIA ISABEL LUISA), ex-queen of Spain, born in Madrid, Oct. 10, 1830. She is the eldest daughter of Ferdinand VII. and his fourth wife, Maria Christina. The question of her succession to the throne caused in Spain a bloody civil war. Her father, having no son, repealed (March 29, 1830) the Salic law, introduced into Spain by Philip V., and named the expected offspring of his fourth marriage to succeed him, thus excluding his brother Don Carlos, who was then heir presumptive by virtue of that law. Ferdinand dying Sept. 29, 1833, Isabella, then only three years old, was proclaimed queen. Don Carlos took up arms, supported by a large body of adherents, known as Carlists. The contest gradually assumed the worst form of civil war, the clergy taking sides with Don Carlos, while the queen's party was identified with that of the *exaltados*, liberals, or constitutionalists; the queen mother, who had taken the title of regent, having guaranteed a constitution to Spain. The young queen was supported by the majority of the people, and in 1834 it was almost unanimously agreed by the legislative cortes that Don Carlos and his descendants should be forever excluded from the Spanish throne; a decree which was confirmed by the constituent cortes in 1836. Peace was virtually concluded at the end of August, 1839, at Vergara, by the convention between the Carlist general Maroto and Gen. Espartero, the most successful of the constitutionalist commanders, and Don Carlos fled to France. During the course of the struggle the queen regent vacillated between the two parties of *moderados*, or conservatives, and *exaltados*, or liberals. The ministry of Mendizabal modified the constitution, enlarged the electoral law, and introduced other reforms; but the juntas, still dissatisfied, demanded the constitution of 1812, which was

finally extorted by the insurrection of Madrid, June 18, 1837. The great insurrections of Barcelona and of Madrid in 1839 caused the flight of the queen mother into France (October, 1840). Espartero now became head of the government, and on May 8, 1841, was declared regent, but was finally compelled by an insurrection of the friends of Christina and the radicals to abdicate; the cortes, by advancing the majority of the queen 11 months, placed her on the throne, Nov. 10, 1843. Gen. Narvaez, who had placed himself at the head of the insurrection, became chief of the cabinet in 1844, and in the following year the constitution was modified in a reactionary sense. On Oct. 10, 1846, under the influence of Louis Philippe, she was married to her cousin, Don Francisco de Asis, and at the same time her sister Maria Ferdinanda Luisa was married to the duke of Montpensier. This alliance gave rise to sinister comments, and resulted in domestic unhappiness and in injurious reports in regard to the conjugal fitness of the king and the conjugal fidelity of the queen. Isabella established alliances with Austria and Prussia, and in 1849 sent an army to aid the pope. An attempted assassination of the queen in 1852 was turned to account by the conservatives, who procured the dissolution of the cortes and the adoption of repressive measures. Several liberal generals having been banished, on June 28, 1854, Gens. O'Donnell and Dulce headed a military and civil insurrection in Madrid, and succeeded in reestablishing a liberal government. The queen mother fled again to France, and the queen proclaimed an amnesty, opened a new cortes, and legalized the sale of church property. In 1856 an attempted *coup d'état* by O'Donnell, and the suppression of revolts in the south of Spain, gave the queen more power, and reestablished the constitution of 1845. This induced the most reactionary measures, which in turn brought about a year later the fall of the Narvaez cabinet and the formation of a more liberal ministry (October, 1857). A war with Morocco, undertaken by O'Donnell, was successfully terminated in April, 1860. The intervention in Mexican affairs jointly with the French, and under the lead of Prim, in 1861-'2, was speedily cut short by that general. Wasteful enterprises in Santo Domingo and against Peru and Chili proved entirely fruitless. In 1865 Isabella was compelled by the resignation of her ministers to give her sanction to the bill repealing the law of 1861, by which the republic of Dominica was incorporated with the monarchy; and in the same year she ordered the sale of all the crown property, with the exception of the royal residences and entailed estates, for the benefit of the nation. In 1866, under the influence of the priests and a new Narvaez cabinet, she abolished freedom of the press and placed public instruction in the hands of the clergy. Insurrections, instigated and partly led by Prim, broke out in that and the

following year in various parts of the country, but failed for want of organization. Gonzalez Bravo, the successor of Narvaez at the head of the cabinet, carried reaction still further, until in September, 1868, a revolt began at Cadiz which speedily spread over all Spain, and resulted in the queen's flight to France, with her children, her lover Marfori, and her chaplain Claret. (See PRIM, and SERRANO.) Napoleon III. put at her disposal the castle at Pau, whence she issued a proclamation to the Spanish people, protesting against the revolution. On Sept. 29, 1868, her deposition was declared at Madrid, and on Nov. 6 she took up her residence in Paris, where she has since remained, with the exception of an interval spent at Geneva during the Franco-German war. On June 25, 1870, she abdicated her claim to the throne of Spain in favor of her son, Alfonso Francisco de Asis Fernando, &c. (born Nov. 28, 1857), prince of Asturias, who assumed the title of Alfonso XII.

**ISABELLA OF ENGLAND.** See EDWARD II. and III.

**ISABELLA OF VALOIS.** See ELIZABETH OF VALOIS.

**ISABEY. I.** Jean Baptiste, a French miniature painter, born in Nancy, April 11, 1767, died April 18, 1855. He studied historical painting under David, but commenced his career by making portraits in crayons. About 1800 he determined to apply the principles of high art to miniature painting, and in 1802 his reputation was established by an extensive work, representing the first consul reviewing his troops in the court of the Tuileries; and thenceforth he remained at the very head of this branch of his art. Napoleon I., with whom he had been intimate in his youth, appointed him his miniature painter in ordinary, and the members of the Bonaparte family and the marshals and great dignitaries of the empire sat to him, besides many sovereigns and statesmen of Europe, of whom he painted a greater number than any contemporary. His *Table des maréchaux*, on a large slab of porcelain, representing Napoleon surrounded by his most famous generals, is a good specimen of his large portrait pieces. His picture of one of the conferences at Vienna, whither he had followed Maria Louisa on the abdication of Napoleon in 1814, is valuable from the number of historic portraits it embraces. **II.** Eugène Louis Gabriel, a French marine and landscape painter, son of the preceding, born in Paris, July 22, 1804. He studied art under his father. His "Battle of the Texel" (1839) is in Versailles, and his "Embarking of Ruyter" (1851) in the Luxembourg. His later works include "The Alchemist" (1865) and "The Temptation of St. Anthony" (1869).

**ISÆUS**, one of the ten Attic orators, born at Chaleis, flourished in the first half of the 4th century B. C. He went at an early age to Athens, was instructed in oratory by Lysias and Isocrates, composed judicial orations for others, and founded a school of rhetoric in

which Demosthenes is said to have studied. In antiquity 64 orations were ascribed to him, of which 11 are extant, all relating to disputed inheritances. The best separate edition is that by Schömann (8vo, Greifswald, 1831). There is an English translation by Sir William Jones (London, 1794).

**ISAIAH**, the first of the great Hebrew prophets, son of Amoz, flourished under Kings Uzziah, Jotham, Ahaz, and Hezekiah, from about 760 to 700 B. C. Ahaz was consoled by his prophecies when King Rezin of Damascus and Pekah of Israel warred against Judah. But his chief activity falls in the reign of Hezekiah, during the invasion of Sennacherib, king of Assyria. (See HEBREWS, vol. viii., p. 589.) The leading themes of his prophecies are denunciations of vice and oppression, announcements of impending ruin, and the promise of regeneration and a universal reign of justice. The eloquent style and sublimity of thought of the main portions of the book of Isaiah give him the highest rank among the prophets. The last 27 chapters, which differ in diction and topics, treating of the victories of Cyrus, the fall of Babylon, and the return of the Jews to Jerusalem, are generally considered by critics to be by some author of the time of the captivity, whose name is unknown, and who is often designated as the second Isaiah. Some other chapters (xiii., xxxiv., xxxv., &c.) are also regarded as productions of unknown authorship. Among the best commentators are Lowth (London, 1775), Gesenius (3 vols., Leipsic, 1820-31), Hitzig (2 vols., Heidelberg, 1833), J. A. Alexander (2 vols., New York, 1846-7), Barnes (3 vols., 1848), Drechsler (3 vols., completed by Delitzsch and Hahn, 1857), Knobel (3d ed., 1861), Delitzsch (1866), and Ewald (2d ed., 1867).

**ISANTI**, an E. county of Minnesota, intersected by St. Francis or Rum river; area, 450 sq. m.; pop. in 1870, 2,035. The surface is somewhat diversified. Timber is found along the river banks. The chief productions in 1870 were 16,025 bushels of wheat, 2,523 of oats, 8,699 of Indian corn, 11,860 of oats, 11,544 of potatoes, 58,331 lbs. of butter, and 5,432 tons of hay. There were 225 horses, 660 milk cows, 1,149 other cattle, 975 sheep, and 335 swine. Capital, Cambridge.

**ISAR** (anc. *Iarvus*), a river of Germany, a tributary of the S. or right bank of the Danube, about 200 m. long. It rises in Tyrol about 6 m. N. E. of Innsbruck, passes for about 50 m. through a wild and partly uninhabited Alpine region, until it reaches with tremendous velocity the Bavarian town of Tölz, 25 m. S. of Munich; it falls into the Danube 2 m. below Deggendorf. Besides Munich, the lower waters Landshut, Landau, and other towns, but is not navigable excepting downward from Tölz, and then only for rafts. It contains many large bogs and forms numerous islands; its many affluents from Ammer, Wörn, and other lakes; and a mountain lake east of Tölz, which is said to have once been far beyond Tölz.

le of Upper Bavaria was formerly that of the Isar.

**St. Gémeuse**, a French patroness of art in Toulouse about 1450, died there in 1500. She belonged to a distinguished family according to some authorities to that of the counts of Toulouse. She was never married and devoted her wealth to the promotion of poetry by restoring the floral games academy of Toulouse. She annually made large amounts to the endowment of the best poetical contributions, and her name continues to derive from her legacy an income of over 10,000 francs for the promotion of the floral games.

**Isauria**, in ancient geography, a district of Asia Minor, bounded by Phrygia, Lycaonia, and Pisidia, containing few towns, and known to the ancients chiefly by the marauding habits of the Isauri, who dwelt in its mountainous recesses. The Romans sent an army against them in 78 B. C. under Servilius, who induced them to submission and gained the surname of Isauricus. As they continued their depredations, the Romans tried with little success to check them by confining them within a series of fortresses. In the 3d century the Isaurians and Cilicians united themselves into a nation, and one of their chiefs, Trebellianus, assumed the title of Roman emperor (264), conquered and put to death. They were formidable to the Byzantine emperors, of their race, Zeno (474-'91) and Leo (457-'41), rose to the Byzantine throne. The Isaurians of Isauria was Isaura, at the foot of the Taurus, a strong and rich city, whose inhabitants destroyed it and themselves by fire in 1073, as they could no longer resist the siege of the Seljuks, shortly after the death of Alexander the Great. It was rebuilt, and again destroyed by the Seljuks.

**Ischia** (anc. *Enaria* and *Inarime*), an island in the Mediterranean, at the N. entrance

of the bay of Naples; area, 26 sq. m.; pop. about 25,000. Its coasts are steep and rocky. Near its centre is the volcano of Epomeo, 2,500 ft. above the sea; its last eruption was in 1801. There are also 12 smaller volcanoes. The intervening valleys are of extraordinary fertility, producing corn, wine, and fruits in abundance. Its warm baths, the most celebrated of which are those of Casamicciola and Lacco, are much frequented, and, with its salubrious climate and luxuriant vegetation, make it a favorite resort in every season of the year. The chief town, Ischia, has about 6,300 inhabitants, and is the seat of a Catholic bishop. Its castle, a picturesque structure, stands on a high isolated rock of volcanic tufa and ashes, which rises out of the sea opposite the island of Vivara, and is connected with the mainland by a mole. It was built by Alfonso I. of Aragon in the 12th century.

**ISCHL**, or *Ischl*, a fashionable watering place in Upper Austria, on the river Traun, in the centre of five or six valleys, surrounded by picturesque mountains, 27 m. E. S. E. of Salzburg; pop. in 1869, 7,126. In the vicinity are extensive salt works, established in 1822. It contains several churches and schools, and sulphur, mud, and saline vapor baths. A suspension bridge crosses the Traun, at the junction of the Ischl. It is a favorite resort of the Austrian nobility and of the present emperor.

**ISEHEM**, a town of Belgium, in the province of West Flanders, 7 m. N. N. W. of Courtray; pop. in 1867, 7,955. It has important manufactories of cotton, linen, hats, thread, ribbon, and soap, breweries, and tanneries, and a large trade in cattle.

**ISELIN**, *Henri Frédéric*, a French sculptor, born at Clairegoutte, Haute-Saône, about 1825. He exhibited various works in 1849, and has since produced busts of Murat and others for the museum of Versailles, "Observation," an allegorical bust, "The Genius of Fire," and "Eury-

pylus" for the new Louvre, and other busts and statues.

**ISÈRE**, a S. E. department of France, in Dauphiny, bounded W. and N. by the Rhône, which separates it from the departments of Loire, Rhône, and Ain, and on the E. and S. bordering on Savoie, Hautes-Alpes, and Drôme; area, 3,200 sq. m.; pop. in 1872, 575,784. It is named from the river Isère (anc. *Isara*), which flows through it generally S. W. from Savoie, passes Grenoble, and falls into the



Castle of Ischia.

Rhône near Valence, Drôme, after a course of 180 m., for more than 80 of which it is navigable. The surface of the department in the south is very mountainous, but in the centre and north it frequently expands into extensive plains. There are at least 20 mountain peaks, the lowest over 6,000 ft. high, and the most elevated, belonging to the Pelvoux group, on the border of Hautes-Alpes, over 13,000 ft. The soil of the lowlands is in general very fertile. Agriculture is in an advanced state. The quantity of wine made annually averages over 5,000,000 gallons; that made in the valley of the Rhône has been long celebrated. The production of silk is an important branch of industry. There are mines of iron, copper, lead, and coal; and gold, silver, platinum, zinc, and antimony are found. The staple manufactures are hardware, linens, and cotton yarn. The department is divided into the arrondissements of Grenoble, Saint-Marcellin, La Tour-du-Pin, and Vienne. Capital, Grenoble.

**ISERLOHN**, a town of Prussia, in the province of Westphalia, 15 m. W. of Arnsberg; pop. in 1871, 15,763. It is remarkable for its manufactures of iron, steel, bronze, needles, &c. The manufacture of iron was in operation there in the middle ages. That of brass dates from the 18th century. The other manufactures are silks, velvet, broadcloth, ribbons, leather, and paper. The country around Iserlohn is diversified with picturesque ruins, rocks, glens, and valleys. In the vicinity of the town is the celebrated Felsenmeer (sea of rocks), and a remarkable sounding cave containing fossil bones.

**ISERNIA** (anc. *Æcernia*), a town of southern Italy, in the province and 24 m. W. of the city of Campobasso, at the foot of the Apennines, and near the source of the Volturno; pop. about 7,500. It is surrounded by a modern wall, founded on the massive remains of an ancient one. In the middle is a fine fountain, with six rows of arches supported on columns of white marble; this, as well as the manufactories of the town, is fed by an ancient aqueduct hewn in the rock for a long distance and at a great depth. Isernia is the seat of a bishop, has cloth and earthenware manufactories and paper mills, and an extensive trade. Until 1780 it was crowded during the September fair with pilgrims to the shrine of Sts. Cosma and Damiano, who were supposed to have extraordinary healing powers, and to whom offerings were made of red wax models of the parts of the body affected by disease; these finally became so scandalous that the government suppressed the practice. In 1805 the town suffered severely from an earthquake.

**ISHMAEL**, son of Abraham and Hagar, born in Mamre. After the birth of a son to Sarah, she persuaded Abraham to banish Hagar and Ishmael, and from that time Ishmael dwelt as a hunter in the wilderness of Paran. His 12 sons became the heads of 12 tribes dwelling in the Arabian desert between Egypt and the Eu-

phrates, under the name of Ishmaelites or Hagarites.—In the 10th century A. D. the name of Ishmaelites or Ismaelians was assumed by a Mohammedan secret society in Syria and Persia. (See ASSASSINS.)

**ISIDORE MERCATOR**, also called PECCATOR and PSEUDO-ISIDORE, the supposed author of the false decretals. (See CANON LAW, and DECRETALS.)

**ISIDORUS**. I. Of Charax, a geographer in the early part of the 1st century. He was the author of a work in which the Greek and Roman world and the Parthian empire were described. There are several quotations in Pliny from this treatise, the extant fragments of which have been repeatedly published in modern times among the remains of the *Geographici Minores*. The best edition is that of Miller (Paris, 1839). II. Of Seville, a saint of the Latin church, born in Cartagena, Spain, died April 4, 636. He succeeded to the see of Seville about 600, and was esteemed the most eloquent orator, the profoundest scholar, and the ablest prelate of his age. In 619 he presided at the second council of Seville, and in 633 at the great council of Toledo. He wrote on science, art, history, and theology; the most curious and important of his works is *Originum sive Etymologiarum Libri XX.*, an encyclopædia of all the arts and sciences then known. The best complete edition of his works is that of F. Arevali (Rome, 1797–1803). The fragments of his treatise *De Fide Catholica contra Judæos*, after the Paris and Vienna MSS., are given by Karl Weinhold in vol. vi. of the *Bibliothek der ältesten deutschen Literaturdenkmäler* (Paderborn, 1874).

**ISINGLASS** (perhaps from *icing glass*; Ger. *Hausenblase*, sturgeon's bladder, *isinglass*), a kind of edible gelatine, which consists of the dried air bags, sounds, or swimming bladders of fishes. It was known to the ancients by the name of *ichthyocolla* or fish glue, and is often alluded to by Dioscorides and Pliny. In different parts of the world it is obtained from different fishes, and the isinglass of commerce is consequently of various qualities. The best is found among the varieties imported from Russia, particularly that which is brought to St. Petersburg from Astrakhan, and said to be obtained from the sturgeon called the beluga (*acipenser huso*) of the Caspian sea and the rivers which flow into it, a species which attains a length of 25 ft. According to some authorities, the sound is cut open, washed, and then exposed to the air, the inner silvery membrane outward. This membrane is then stripped off, placed in damp cloths, and kneaded in the hands. Taken out and dried, it forms the leaf isinglass; folded like sheets of paper, it is the book isinglass; wound in the form of a horse shoe or lyre around three pegs, it forms the varieties known as long or short staple. According to Martin, the inner membrane is removed by beating and rubbing, and the thicker membrane is preserved. The isinglass

called *Samovey* is brought from *Taganrog*. The leaf, book, and short staple from this place are all of inferior quality. The varieties from the Ural and Siberia are better. The Brazilian isinglass, imported from *Pará* and *Maranhão*, is obtained in various forms distinguished as pipe, lump, and honeycomb. It appears to be the product of different kinds of fish, and to be prepared with little care. It is largely used in brewing establishments for fining the liquors; and though it is too impure for domestic uses, it is largely employed to adulterate the better kinds. Its presence may be detected by the isinglass failing to dissolve readily and completely in hot water, and by its forming with this an opalescent and milky jelly in which may be observed the insoluble shreds common to the Brazilian article. Its smell also is often disagreeable, while that of the pure Russian isinglass is as inoffensive as the odor of seaweed, which it somewhat resembles. The isinglass of New York and New England is obtained from the sounds of the codfish (*morrhua vulgaris*) and of the common hake (*phycis Americanus*). They are macerated in water, and afterward rolled out in long strips a few inches wide. The quality of this isinglass is poor, its solution not readily obtained, and its color dark. It is used for the same purposes as the Brazilian. Other varieties are produced in other maritime countries.—All isinglass has to undergo a process of refining before it is fit for making jellies, blanc-mange, &c. The best beluga leaf is imported in circular sheets, the most perfect of which are sometimes 2 ft. in circumference, and weigh from 8 to 16 oz., in some instances reaching even 4 lbs. These are carefully picked over, and all the discolored parts are cut away and put aside for uses of less importance. The assorted leaf is then passed through successive pairs of iron rollers, until it is converted into thin ribbons of uniform width, which are afterward by other machinery slit into fine shreds. Inferior sheet gelatine is sometimes introduced between two sheets of isinglass before rolling, and thus incorporated with it. Isinglass, being a nearly pure gelatine, should have little or no color; and being commonly prepared without exposure to high degrees of heat, it should be tougher and more elastic than the other forms of this substance. It therefore makes a most adhesive cement. For this purpose it is swollen with cold water and then placed in diluted alcohol. The vessel containing it is then put into cold water, which is to be heated to boiling. The jelly forms the cement, which may be kept from mouldiness and other change by the addition of a few drops of any essential oil. It is known as the "diamond cement," and is also the adhesive substance of court plaster. Gum ammoniac is sometimes introduced, especially by the Turks, who use the cement for fastening precious stones, mending broken porcelain, glass, &c. Isinglass has also been used for the window lights of vessels, being

covered with a transparent varnish which is not affected by moist air. Hence, sheets of mica prepared for similar uses, as in the doors of stoves, are popularly called isinglass. (See *MICA*.)—Besides the methods already stated of detecting fraudulent mixtures with isinglass, the microscope may be used to render the different textures apparent. The ash of isinglass seldom exceeds  $\frac{1}{4}$  of 1 per cent., and is red; that of gelatine is white, and in quantity not less than 8 per cent.

**ISIS**, the principal goddess of the Egyptians, the wife of *Osiris*, and the mother of *Horus*, with whom she formed the most popular triad in Egyptian mythology. (See *OSIRIS*.) She was adored as the great benefactress of Egypt, who had instructed her people in the art of cultivating wheat and barley, which were always carried in her festal processions. In Greece, where her worship was introduced at a very early period, she was occasionally addressed as *Pelagia*, the queen of the sea. From Greece her worship passed into Italy, and was established in the first century B. C. at Rome, where it became popular. In 48 B. C. the triumvirs, in order to ingratiate themselves with the people, commanded a temple of *Isis* and *Serapis* to be founded, and publicly sanctioned their worship. The principal Roman temple of *Isis* stood in the *Campus Martius*, and hence the goddess was often called *Isis Campensis*. The Romans identified with her a native goddess of the Gauls, Sicilians, and Germans. The priests of *Isis* wore linen garments, and her votaries in the public processions wore masks representing the heads of dogs. In works of art she usually appears with the figure and face of *Juno*, arrayed in a long tunic, wearing a wreath of lotus flowers, and in her right hand a *sistrum*.

**ISLA**, *José Francisco de*, a Spanish author, born in Segovia in 1703, died in Bologna in 1781. He early became famous as a Jesuit preacher and a satirical poet. His first works were directed against an extravagant religious festival at Salamanca in 1727, and a royal pageant at Pampeluna in 1746; but he managed his sarcasm so adroitly that the authorities of the latter city at first regarded his effusion as complimentary, though subsequently he left the city, and probably was expelled. His published sermons (1729-'54) show a marked improvement upon the prevailing tone of the itinerant friars, and he reformed this effectively by his celebrated romance *Historia del famoso predicador Fray Gerundio de Campazas*. The first volume, printed without his knowledge in 1758, was eagerly bought up; the derisive epithet of *Fray Gerundio*, henceforward applied to vulgar preachers, put an end to their vocation; but the government was obliged to withdraw the license for its publication in obedience to the clamors of the clergy. The inquisition condemned the book in 1760, but did not molest the author, who was protected by his increasing popularity. The violent ex-

pulsion of his order in 1767, requiring his sudden departure, gave a shock to his health from which he never recovered, and he spent the rest of his life in Bologna. The manuscript of his second volume having reached London, Baretti published it in English (1772); and complete Spanish editions soon appeared at Bayonne and elsewhere, Isla's friend Francisco Lobon de Salazar, a priest at Villagarcia, in whose house he had written the work, appearing as the author in the earliest and in some of the later editions to elude the censorship. In 1813 the work was published in Madrid in 4 vols.; and though again interdicted next year, it continued to have a large circulation. Ticknor finds in its plan some resemblance to "Don Quixote," and in its execution he compares it to Rabelais. Isla's works also include *Cicero*, a satirical poem in 16 cantos. Permission to print it was denied, and the manuscript was presented in 1844 to the library of the Athenæum of Boston, Mass., together with some of Isla's autograph letters. His letters to his sisters and brother-in-law, *Cartas familiares*, were published posthumously in 6 vols., 1785-'6.—See *Vida de J. F. de Isla*, by J. I. de Salas (Madrid, 1803).

**ISLAM**, an Arabic word, signifying full submission to God. It is used by Mohammedans to designate their religion, and also the whole body of believers, or those who accept the formula of faith: "There is no God but Allah, and Mohammed is his prophet." This formula or profession of faith is understood to include five essential articles of religion: 1, the acknowledgment of the divine unity and of the mission of Mohammed; 2, observance of prayer; 3, almsgiving; 4, keeping the fast of Ramadan; 5, the pilgrimage to Mecca. The Shi'as, or adherents of Ali, who are dominant in Persia, add to the declaration of faith, "Ali is the vicar of God." But the Sunnis, or orthodox Mohammedans, who form the majority of the church of Islam, reject this.

**ISLAND**, a N. W. county of Washington territory, bounded S. and S. W. by Admiralty inlet, and W. by Rosario strait; area, 200 sq. m.; pop. in 1870, 626. It comprises Hat, Camano, and Whitby islands, the last being 60 m. long, of irregular width, and noted for its fertile soil and salubrious climate. The chief productions in 1870 were 3,271 bushels of wheat, 4,856 of oats, 13,069 of barley, 15,043 of potatoes, 9,297 lbs. of wool, 11,395 of butter, and 1,942 tons of hay. There were 214 horses, 433 milch cows, 579 other cattle, 3,099 sheep, and 1,108 swine; 1 flour mill, 1 saw mill, and 3 establishments for building and repairing ships. Capital, Coupeville.

**ISLAY**, or *Isla*, an island of Scotland, the southernmost of the Hebrides, 15 m. from the coast of Argyleshire, to which it belongs; length 24 m., breadth 17 m.; area, 154,000 acres, of which 20,000 are cultivated; pop. in 1871, 8,143. The surface of the E. part is

hilly and mostly wooded, but the remainder is generally level. Some of its summits are 1,500 ft. high. It contains several small lakes and rivers, which abound with salmon and trout. Loch Finlaggan, near its centre, is about 3 m. in circumference. In this lake is an islet where the Macdonalds, the "lords of the isle," once resided, and where the ruins of their castle still are. The climate is moist, but tolerably healthy. The soil of the lowlands is very fertile and well cultivated. The staple manufacture is whiskey, which is of superior quality, and of which over 400,000 gallons are made yearly. Lead and copper mines have been opened. In 1843 the island was purchased as an investment by the late Mr. Morison of London for \$2,225,000. Chief town, Bowmore.

**ISLE OF FRANCE**. See **MAURITIA**.

**ISLE OF MAN**. See **MAN**.

**ISLE OF PINES**. See **PINES**.

**ISLE OF WIGHT, England**. See **WIGHT**.

**ISLE OF WIGHT**, a S. E. county of Virginia, bounded N. E. by the estuary of James river, and S. W. by the Blackwater; area, 400 sq. m.; pop. in 1870, 8,320, of whom 3,446 were colored. The surface is generally level and divided between swamps, pine forests, and farming lands. The soil is thin and sandy. The Norfolk and Petersburg and Seaboard and Roanoke railroads cross the county. The chief productions in 1870 were 160,733 bushels of Indian corn, 17,823 of oats, 17,957 of Irish and 30,411 of sweet potatoes, and 1,312 tons of hay. There were 829 horses, 1,226 milch cows, 2,237 other cattle, 1,510 sheep, 11,433 swine, and 6 saw mills. Capital, Smithfield.

**ISLE ROYALE**, an island in Lake Superior, forming part of Keweenaw co., Michigan, 55 m. N. W. of Keweenaw point, 15 m. from the Canada shore, intersected by the 46th parallel and the 89th meridian; length from N. E. to S. W. about 45 m., greatest breadth 9 m.; area, 225 sq. m. It has no permanent population. The shores are generally rocky and broken, with several deep inlets. A large number of rocky islets are clustered about it, especially off the N. E. and S. W. extremities. Much of the island is covered with trees, and a longitudinal ridge rises at some points more than 700 ft. above the lake. Extensive veins of native copper have recently been discovered on this island, many of which have been worked by some ancient people, whose stone hammers and copper knives and other tools are found in great numbers in the pits. Some of the excavations on the N. side extend continuously more than two miles, and are connected by underground drains, one of which was cut through rock for a distance of 60 ft., and had been covered throughout with large timbers, now broken and decayed. The stone hammers weigh from 10 to 30 lbs., some of them having a groove for a handle, and the copper tools have been hardened by fire. The miners exhibited great skill in tracing the veins, and followed the deposits of sheet-like copper, re-

ecting the nuggets. Some copper arrowheads have been found on the island, and a wide wooden bowl 3 ft. in diameter. At an indentation which forms a good harbor on the west side, where a stream 40 ft. wide has cut a passage through the rocks and forms a considerable cataract, the apparent site of an ancient town has been discovered. It was on an elevated slope overlooking the lake. No human remains have been found. At least one generation of immense forest trees has grown over all the mines. One is now worked by a New York company. A few deer frequent the land, and it is overrun with rabbits.

**ISLES OF SHOALS**, a group of islets in the Atlantic ocean, 10 m. S. E. of Portsmouth, N. H.; pop. in 1850, 181; in 1860, 152; in 1870, 14. Their names are Appledore or Hog island, Haley's or Smutty Nose, Malaga, Cedar, Duck, Gosport or Star, White, Seavey's, and Londoner's. Malaga is permanently connected with Haley's by a breakwater, and at low water Cedar is also connected with Haley's, and Seavey's with White. Star, White, Seavey's, and Londoner's islands form part of Rockingham co., N. H., and constitute the town of Gosport; the others belong to York co., Me. The three largest are Appledore, containing about 400 acres; Star, 150 acres; and Haley's, which with Cedar and Malaga comprises 100 acres. On White island, the westernmost except Londoner's, is a lighthouse (lat. 43° 58' N., lon. 70° 37' 20" W.), with a revolving light 87 ft. above sea level, and visible 5 m. The islands consist of rugged ledges, and contain little vegetation. A steamer runs daily from Portsmouth in summer, accommodating the numerous visitors who resort either to enjoy the sea air and the facilities for boating and fishing. On Appledore there is a large hotel, with the private residence of the proprietors. Star island contained nearly

all the inhabitants, and had a church, a school, a monument to Capt. John Smith, erected in 1864, and the ruins of an old fort; but in 1872 a company bought out the inhabitants, and have built a large hotel for the accommodation of summer visitors. Haley's island has a wharf, a public house, and a few buildings.—The islands are believed to have been discovered by Champlain in 1605. They were first visited by Capt. John

Smith in 1614, who called them Smith's islands, but the name was not retained. They were early visited by fishermen, and the fish-

eries have been the chief support of the inhabitants. During the revolution most of the inhabitants, who for more than a century had numbered from 300 to 400, removed to the mainland.—Mrs. Celia Thaxter, who resides on Appledore, and whose father was for six years keeper of the lighthouse on White island, has published a volume descriptive of the islands ("Among the Isles of Shoals," Boston, 1873), and a number of poems illustrative of them.

**ISLINGTON.** See LONDON.

**ISMAELIANS.** See ASSASSINS.

**ISMAIL**, or *Ismail-Tutchkov*, a town of Roumania, in Moldavia, situated on the Kilia, the N. arm of the Danube, 86 m. E. by S. of Galatz and 185 m. S. S. E. of Jassy; pop. in 1866, 20,869. It contains the remains of a fine Turkish palace, and many Greek and Armenian churches, and is an important seat of trade between Russia and Turkey. The new town of Tutchkov was added to it about 1880. Its commerce has been checked by the increasing business of Galatz, Braila, and Sulina, though the exports of grain, wool, tallow, and hides continue to be of some importance.—Ismail enjoyed great military and commercial prominence under the Turks, and contained 20 mosques and many khans, bazaars, and fine houses. The Russians took it in 1770, and stormed it again in 1790 under Suvaroff, when they lost 20,000 men, and put the Turkish garrison of 30,000 to the sword and nearly reduced the place to ashes. Having been partially rebuilt, the Russians again captured it in 1809. In 1812 it was formally ceded to Russia by the treaty of peace of Bucharest, and it was the strongest fortress of the Russian province of Bessarabia till 1856, when by the terms of the treaty of Paris the fortifications were razed and Ismail was restored to Turkey together with other parts of S. Bessarabia. It became a free port (tobacco and war material excepted) Jan. 1, 1873.



Ismailia.

**ISMAILIA**, a town of Lower Egypt, on the N. shore of Lake Timsah, on the Suez canal, and on the railroads leading from Alexandria

and Cairo to Suez; pop. in 1870, about 4,000. It was founded in 1863, to serve as a central seat for the administration of the work on the Suez canal, which had been simultaneously begun at Suez and Port Said. It was named after the khedive. In consequence of its favorable situation it seems destined to become a place of great commercial importance.

**ISMAIL PASHA**, or **Ismail I.**, khedive of Egypt, born in Cairo in 1830. He is a son of Ibrahim Pasha, and his mother was a Circassian woman. He was educated in Paris, and returning to Egypt soon after his father's death, Nov. 9, 1848, he became a determined opponent of the new viceroy Abbas Pasha. The latter accused him in 1853 of complicity in the assassination of one of his favorites, but the charge was not substantiated. Abbas suddenly died next year, and was succeeded by Said Pasha, who employed his nephew Ismail abroad and at home, placed him at the head of the administration during his visit to Europe in 1862, and made him general-in-chief of the army, in which capacity he distinguished himself by restoring tranquillity in the territory of Soodan. On the death of Said, Jan. 18, 1863, he succeeded him as fifth viceroy of Egypt, and acquired an enormous fortune through the production of cotton during the American civil war. The difficulties with M. de Lesseps in regard to the Suez canal were settled in 1864, and Ismail became thenceforward the most active promoter of the enterprise. While residing occasionally in his superb palace at Ermighian on the Bosphorus, he lived, as in Cairo, in a truly oriental style of magnificence, lavished large sums of money upon Turkish officials, and so ingratiated himself with the sultan and his court that he secured in 1866 the long coveted privilege of a direct line of succession for his dynasty, which makes the eldest of his three sons, Hussein, his heir apparent. In the same year he voluntarily increased his tribute to the sultan, with whom he cooperated at the same time, with 30,000 Egyptian troops, against the Cretans. New and important prerogatives were consequently granted to him in 1867, together with the titles of highness and khedive; but Ismail was not satisfied with these, and put forward the most extraordinary pretensions, threatening to withdraw his army from Crete, and even to seize that island, in case of non-compliance. The intervention of foreign powers caused him to abate his pretensions, and for a time appeased the exasperated sultan. But the viceroy, not content to extend his sway over the upper Nile (1868) and over the White Nile through Sir Samuel Baker (1869), continued to make foreign loans for the increase of his army and navy, proposed the denaturalization of the Suez canal, invited the potentates of Europe to attend its opening (Nov. 17, 1869), and acted as a completely independent sovereign to such an extent that after the closing of these festivities the sultan's long cherished design of curbing his vassal's

ambition was immediately carried out. Ismail was commanded to reduce his army to 30,000 men, to recall his order for the construction of ironclads and breech-loaders in Europe, and to discontinue the contraction of loans in foreign markets; and he was threatened with instant deposition in case of disobedience. Disappointed in the hope of support from Russia and other powers, the khedive reluctantly postponed his schemes and submitted to the sultan's will (Dec. 9). When, despite this agreement, he made another attempt to conclude a foreign loan in 1870, Abdul Aziz put an end to it by publicly denouncing the illegality of the proceeding. Within the next few years their relations were apparently smoother, owing to the altered condition of the balance of power in Europe consequent upon the Franco-German war and other events, and also to the khedive's increasing wealth and judicious manner of dispensing it in Constantinople. He obtained not only a confirmation of all previous prerogatives (June 9, 1873), but new concessions which give him absolute control over the organization and extension of his army, and the right of making loans and commercial treaties. He is still restricted in the acquisition of ironclads, in the intercourse with foreign powers, and in some other respects, but otherwise is an absolute sovereign; and he is acting as such in extending his authority in various parts of Abyssinia and on all the borders of the Nile. Early in 1874 he achieved an important victory over the sultan of Darfour, and sent in the same year another expedition up the Nile under Capt. Gordon, ostensibly for the suppression of the slave trade. At the same time he is bringing the rude tribes in his outlying dominions under the influence of civilization by drawing military cordons round those ill-defined regions, and by building public roads and promoting agriculture. His successful aggressive policy became however in 1874 a fresh source of uneasiness for the sultan, though he had the latter's sanction for taking military possession of the Suez canal, which compelled M. de Lesseps, with whom differences had arisen, to submit to the decision of the international tonnage commission. Like nearly all rulers of Egypt from time immemorial, the khedive holds the whole land in fee simple, as it were, and his subjects work it on his account and on his own terms. Through his enterprise and activity immense progress has been made in industrial development and the execution of public works of all kinds; and the whole business of the country being under his control, his wealth is incalculable, while the mass of his subjects, and particularly the fellahs or peasantry, remain in a condition of serfdom and pauperism. He has embellished Cairo and Alexandria, and introduced the gay fashionable life of Paris; employs many foreigners in the army, navy, and other branches of service; is a munificent patron of archaeological, geographical, and ethnological research-



es; has established a library in the ministry of education, rich in oriental works; and has enabled Rohlf's to explore the Libyan desert. The clear complexion which he has inherited from his Circassian mother gives Ismail rather the appearance of an Englishman than of an oriental. He is of medium stature, inclined to the obesity of his family, with small gray eyes and a shrewd expression of countenance.

**ISMID**, or **Iakimid** (anc. *Nicomedia*) a town of Turkey in Asia, in the vilayet of Khodavendighiar, at the bottom of the gulf of Ismid, 50 m. S. E. of Scutari; pop. about 8,000. It is beautifully situated, but the interior of the town is wretched, and but few relics remain of Nicomedia. Greek and Armenian prelates and a Turkish pasha reside here, and there is a small community of Armenians converted to Protestantism. The port is accessible to the largest ships. Silk and pottery are manufactured. Tokölyi, the leader of the Hungarian Protestants against Leopold I., died in Ismid, and is buried there. (See *NICOMEDIA*.)

**ESWARD**, **Maximil**, a French revolutionist, born in Grasse, Provence, Feb. 16, 1751, died there in 1830. In the legislative assembly in 1791 he gained notoriety for his eloquence and boldness, contributed to the insurrection of Aug. 10, 1792, and was reelected to the convention. He then joined the Girondists, voted for the death of Louis XVI., was instrumental in establishing the committee of public safety, opposed the Montagnards, and was prosecuted. His Herculean strength enabled him to escape the officers who came to arrest him in June, 1793, and he took refuge with a friend. He reappeared in the assembly after the fall of Robespierre, and subsequently became a member of the council of 500, to which he belonged for one year. Thenceforth he devoted himself to literary and philosophical pursuits, and gradually became religious. Among his publications is a lyric poem of some merit, *Dithyrambe sur l'immortalité de l'âme*, dedicated to Pope Pius VII.

**ISOCRATES**, an Athenian orator, born in 436 B. C., died in 338. His father, Theodorus, was a rich musical instrument maker of Athens, and gave his son the best education attainable in the city. Tisias, Gorgias, Theramenes, and Socrates were his teachers. His natural timidity and weak voice precluded public speaking, and he devoted himself to lecturing on rhetoric. He first taught in the island of Chios; but his success there was not very great, and he was chiefly engaged in regulating the political constitution of the island. He then returned to Athens, where he soon had 100 pupils at a charge of 1,000 drachmæ each. He also derived a considerable revenue from writing orations. Plutarch says that Nicocles, king of Cyprus, gave him 20 talents for his oration *Πρός Νικοκλέα*. He was never willing to take part in public affairs, and, when appointed trierarch in 355, excused himself on account of illness. This refusal, considering

his ample means, occasioned much ill will against him. In 362, from policy, he accepted the office, and although it was the most expensive which a private citizen could undertake, he filled it with great liberality and splendor. Isocrates taught principally political oratory. The most eminent statesmen, orators, philosophers, and historians of the time were educated in his school, and he always selected practical subjects, proposing to them chiefly the political events of his own time as a study. His orations, though written to be delivered in his school, were copied and recited in all the countries inhabited by Greeks. In his *Areopagiticus* he urges Athens to adopt, as her only safeguard, the ancient democracy of Solon. In his *Panegyricus* he is equally warm in his exhortations to all the Greeks to unite against the barbarians. In his "Philip," an oration addressed to the king of Macedon, he entreats the king to unite with the Greeks, and lead them against the Persians. But Isocrates was not a practical statesman, and he was unconsciously urging Philip to become the ruler of the Grecian states, an object which the king was then secretly planning. His *Panathenæicus*, a eulogy on Athens, was written when he was 94 years of age. After the victory of the Macedonians over his countrymen at Chæronea, he was unwilling to survive the destruction of their liberties, and destroyed himself. The writings of Isocrates were all carefully studied and elaborated; he is said to have taken over ten years to write his *Panegyricus*. They are remarkable for their flow of elegance and melody, the precisely turned sentences and periods making the style almost monotonous. Of 28 genuine orations of his, 21 have come down to us, 8 of which were written for judicial cases, and were intended to serve as models for forensic writing. Besides these, there are titles and fragments of 27 others, and also 10 letters, some of which are undoubtedly spurious. His works have been translated into English by Sadlier, Dinsdale, and Gillies, and also into French, but unsuccessfully. The best text is Bekker's.

**ISOMERISM** (Gr. *ισος*, equal, and *μέρος*, part), a term used in chemistry to express the relation existing between those substances which, while they possess the same ultimate composition, exhibit essentially different chemical and physical properties. The term isomeric is often applied indiscriminately to several classes of bodies which will here be separately considered. Strictly speaking, it ought perhaps now to be confined to those cases in which the elements composing the dissimilar substances are both quantitatively and qualitatively the same. Difference of properties can here be readily explained by admitting that the elements of the different bodies are arranged or grouped in different ways. Thus both formiate of ethyle and acetate of methyle—very different substances—have the ultimate composition expressed by the formula  $C_2H_5O_2$ , sometimes

written  $C_6H_{12}O_4$ . They are however proximately composed of

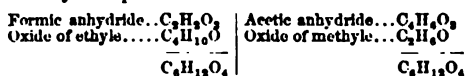

That such compounds really contain different proximate constituents is proved by the fact that they afford different products when decomposed under similar conditions. Hence they are regarded as distinct chemical substances, and not as modifications of one and the same body. The different grouping of the elements of these compounds has been compared to that of letters in words like *ate, eat, tea, &c.*, on the arrangement of which the meaning of the word is entirely dependent. All bodies which are thus isomeric with each other, all that have absolutely the same ultimate composition, must of course possess identical equivalent weights. Such substances are often called metameric (Gr. *μετά*, indicating change or alteration), in contradistinction to polymeric substances (Gr. *πολύς*, many), which are composed of similar elements united in the same relative proportion in each case, but in different absolute quantities; the equivalent weights in which these substances combine with other bodies being unlike. This distinguishes them from members of the preceding class, in which both the relative and absolute number of equivalents are the same. Very many polymeric substances are known, whole series of organic compounds being formed of them. As an example, olefiant gas and cetene both contain 85.7 per cent. of carbon and 14.3 per cent. of hydrogen. If nothing were known of their chemical comportment, the empirical formula  $CH_2$  would be applicable to both; but by studying their properties it has been found that 2C and 4H have united to form olefiant gas, the rational formula of which is therefore  $C_2H_4$ , and its combining equivalent 28; while 16C and 32H have united to form cetene, which has consequently the rational formula  $C_{16}H_{32}$ , and the equivalent number 224. Between these two bodies there are 14 others polymeric with them and with each other. Differences like this have been compared to those between words like *ma, mamma, tar, tartar, &c.*, which contain the same letters arranged in the same way, but in different quantities. The arrangement of the elements in polymeric substances is not however of necessity the same; thus, the ether of wood spirit is polymeric with common alcohol; yet the rational formula of the former is  $CH_4O$ ; of the latter,  $C_2H_6O$ .—Until a comparatively recent period it was the prevalent opinion among chemists that bodies of similar composition must of necessity possess similar properties. Any observations tending to throw doubt upon the correctness of this belief were considered erroneous. Even the discovery, by Wöhler and Liebig, that cyanic and fulminic acids are of like percentage composition although they pos-

sess very different properties, was attributed to errors of observation, and generally discredited. Faraday's investigation of several isomeric hydrocarbons in 1825 first proved the fallacy of this supposed law. Its exceptions, being now more carefully observed, were found to be very numerous. In 1830 Berzelius proposed that they should be classified as isomeric substances. It was however soon perceived that the doctrine of isomerism could not with propriety be employed to explain the cause of all the differences which had been observed; least of all, to explain those which occur among the elements themselves—bodies which, from his inability to decompose them, the chemist is forced to regard as simple. In 1840 Berzelius suggested that these peculiarities might depend upon some absolute difference of quality in the different varieties of a substance, and not upon any dissimilarity in the arrangement or number of its molecules. He proposed the term allotropism (Gr. *ἀλλότροπος*, of a different nature) to express this idea, which has ever since steadily gained favor, although directly opposed to the doctrine of the immutability of matter, one of the principal tenets on which the chemistry of the first half of the present century was based. Allotropism is of special interest from the fact that several of the most common and best known elements may occur in two or more allotropic states. Thus, pure charcoal (*lamp-black*), graphite, and the diamond are essentially identical chemical substances. The element phosphorus, as it commonly occurs, is a soft, waxy, yellowish white, exceedingly inflammable, and very poisonous substance, with a strong odor and taste, luminous in the dark, and readily soluble in bisulphide of carbon. It may easily be transformed, however, into another allotropic state, in which it is of a dark red, nearly black, color; is hard, brittle, and devoid of taste or smell, and, so far as is known, of poisonous properties; is not luminous, and is completely insoluble in bisulphide of carbon. It differs moreover from ordinary phosphorus in specific gravity, and entirely in its affinity for other substances. Indeed, it is not known that it is itself combustible; for it may be heated without undergoing change to about 500° F., at which temperature it is reconverted into ordinary phosphorus. These two conditions of phosphorus are so utterly unlike in all their properties, excepting the weight of their equivalent, that were it not in the power of chemists to prove their identity by converting them one into the other, they would without hesitation be considered distinct elements. Similar instances occur among gases. For example, ordinary oxygen gas may be converted into an allotropic modification called ozone, which possesses properties entirely different from those of the original oxygen. Chlorine gas also, according to Prof. J. W. Draper of New York, after exposure to strong sunlight, possesses the power of combining with hydrogen even in the dark, and exhibits other properties unlike those

ine which has been kept from the light. other elements are known to be capable of existing in two or more allotropic states; a considerable number of compound bodies under different modifications, which, it is unlikely, may yet be found to depend upon the allotropic state of one or more of their elements. Indeed, these instances are so common that some chemists have been led to believe that most if not all of the elements may exist in distinct allotropic states. It has not, however, been well ascertained to how great an extent the peculiar state of an element influences the properties of the compounds it forms by uniting with other bodies. Lavoisier, the discoverer of ozone, was confident that it exists, as such, chemically combined with all oxides. Other chemists have referred to the similar varieties of certain compounds of iron, arsenic, &c., to the allotropic states of the elements. Berzelius long ago pointed out that the different states of sulphide of mercury, iodide of mercury, &c., were probably attributed to a similar cause. Berthollet advanced the opinion that the allotropic modifications of sulphur are intimately connected with, if not directly dependent upon, the electrical relation which this substance bears to the elements with which it is or has been combined. When separated, by agents which exert a violent action upon it, from those combinations in which it acts as an electro-positive element, as in sulphurous acid, it is amorphous and soluble in bisulphide of carbon and other solvents. On the contrary, when obtained from compounds in which it plays the part of an electro-negative element, as in sulphide of hydrogen, it is susceptible of crystallization, and is soluble in bisulphide of carbon. Berthelot also states that the modifications of selenium exhibit a similar comportment, and has suggested that the different states of phosphorus may in like manner respectively be electro-negative (ordinary phosphorus) and electro-positive (red phosphorus) conditions. It is worthy of remark that these views, which are of prime importance in their bearing upon the theory of substances, are almost identically the same with those concerning chlorine published some years since by Prof. Draper. Although the accuracy of the observations of both these chemists has been called in question by others, it cannot as yet be admitted that their views have been disproved; they still deserve the most careful consideration. The application of the term allotropic to the modifications between some of the phenomena of allotropism and those exhibited by substances when in the so-called nascent state (as is used in reference to the well established case of iron) many bodies can be made to combine with other substances with much greater facility than when they escape from some combination than at any other time) as is remarked by several chemists. In connection with this view is the theory

of chemical polarity advanced by Brodie ("Philosophical Transactions," 1850, p. 759), who assumes that under certain conditions, as at the moment when a body enters into combination, a chemical difference exists between the particles of which the body is composed; so that these particles are to one another in a peculiar relation which is expressed by the terms positive and negative (+ and -). Several of the phenomena of allotropism may be explained by this theory. Thus, ozone may be regarded as polarized (active) oxygen, while ordinary oxygen is that in which the positive and negative particles are combined, and in the quiescent state. In like manner ordinary white and red phosphorus represent respectively polarized and indifferent conditions. It is customary to speak of the different allotropic states of a substance as if each were something absolute, and not liable to any variation. But there are numerous facts which go to prove that this is not always the case, and that the peculiar characteristics of the allotropic conditions of several bodies are themselves subject to certain variations. In support of this view may be instanced the great diversity of properties exhibited by different specimens of graphite and the various kinds of coke allied to it, or by the different sorts of sulphur.—In addition to the several classes of phenomena already alluded to, the peculiarities of which are strongly marked, there is another class of analogous facts which deserves mention. Many well known substances exhibit differences in hardness, color, specific gravity, solubility, &c., according to the circumstances in which they have been produced. Thus, carbonate of lime, when precipitated from a cold solution of a salt of lime, is readily soluble in an aqueous solution of chloride of ammonium; on the other hand, when in the form of marble it is scarcely at all soluble in this menstruum. Red oxide of mercury, which has been prepared by precipitation in the wet way, is decomposed with much greater facility when heated than that obtained by exposing nitrate of mercury to a high temperature. These differences, though subject to considerable variations, are rarely strongly marked. Since they do not affect to any great extent the chemical behavior of the substance, they are not classed as allotropic conditions, but are supposed to depend upon different states of aggregation of the substance. Some of these variations are probably more intimately connected with allotropism than has heretofore been admitted; thus, the dissimilar properties exhibited by different specimens of silicic acid would now be attributed by most chemists to the known allotropism of its components. But most differences of this sort are so slight that they cannot be regarded as being dependent upon allotropism; they seem rather to be allied to those variations to which, as already stated, even the allotropic conditions of substances are themselves liable. It would appear indeed as if every substance, in each of

its allotropic conditions, must have a point of maximum activity, at which point its properties are normal, subject however, like everything else in nature, to perturbations by which its peculiar properties may be somewhat changed. In compound bodies it is not always easy to distinguish between allotropism and isomerism properly so called; indeed, both may occur at once, *i. e.*, both the arrangement and quality of the elements of two or more substances of the same ultimate composition may be unlike. There is also a large class of bodies to which the general term isomeric is still applied, some of which may be allotropic, while many are probably polymeric. As examples may be mentioned the numerous metallic oxides which undergo changes when heated. The very remarkable circumstance noticed in this connection, that these bodies while undergoing change give off a quantity of heat which they must have previously possessed in a combined or latent form, has led some chemists to seek for an explanation of all the phenomena of allotropism by assuming that heat is a material constituent of substances, capable of modifying their properties according as it is combined with them in greater or less quantity. This is however entirely matter of conjecture, and, in view of our limited knowledge respecting the true nature of heat, can hardly be admitted. Nor has the direct influence of heat been proved in all the cases of allotropism which have been studied. That it is nevertheless intimately connected in some way with these phenomena is evident. This is of special interest in view of the changes which heat is known to effect in the ordinary conditions of matter; the solid, liquid, and gaseous forms, which all substances are supposed to be capable of assuming, being unquestionably dependent upon the temperature to which they are exposed. These conditions must not however become confounded with those dependent on allotropism, which are essentially different. Other chemists have regarded allotropic modifications as dependent upon different states of aggregation of the hypothetical atoms of which, as they suppose, all bodies are formed. In their eyes, the chemical peculiarities of charcoal depend upon its amorphous state; those of the diamond are different because it is crystalline, and those of graphite unlike those of the diamond because its crystals belong to another system. They would call the ordinary state of phosphorus crystalline, the other condition amorphous, and refer all difference of properties to this difference of form. Diversity of crystalline structure, or its entire absence, is however evidently only one of the many differences of properties incidental to allotropism; in many cases it must be regarded as a consequence of the latter, by no means as its cause. At all events, the cases of allotropism which occur among gases cannot be explained by this theory. Others, without paying special attention to crystalline form, have supposed that all cases of isomerism, taken

in its widest meaning, depend upon variations in the grouping of the molecules of bodies. They even refer the instances which have here been classed under allotropism to differences in the arrangement of the particles of matter of which the elements themselves are composed. But few, however, now hold this opinion, the doctrine of allotropism being generally admitted. Although the mere term allotropism conveys no definite idea of the different conditions of matter which it indicates, and is, strictly speaking, nothing more than a convenient name for a class of phenomena as yet inexplicable, the fact which it denotes, that an element can exhibit the properties of two different substances, is of preëminent importance. Important contributions to our knowledge of isomerism have been made in modern times by Butlerow, Kekulé, Erlenmeyer, and Gibbs. (See ALLOTROPISM.)

**ISOMETRIC PROJECTION** (Gr. *ισος*, equal and *μετρον*, measure), a species of drawing, used chiefly by engineers, in which the perspective plane of the paper must be imagined as making equal angles with the three principal dimensions of the figure, and the eye at an infinite distance. Thus lines in the three principal directions will be drawn on the same scale, and that scale the same for all parts of each line.

**ISOMORPHISM** (Gr. *ισος*, equal, and *μορφή*, form), in chemistry, the property possessed by certain bodies of replacing each other in compounds without causing in these an essential change of crystalline form. The bodies that thus replace each other possess themselves similar forms, and are said to be isomorphous. Familiar examples of this mutual replacement in minerals are of the protoxides of iron and manganese, and of lime and magnesia. Chlorine, bromine, and iodine possess this relation toward each other; also arsenic and phosphorus, and the acids of these elements. The term, as proposed by Mitscherlich, strictly signifies similarity of form; it is now applied to substances which are not only similar in their crystalline form, but are analogous in their chemical composition. The study of isomorphism has greatly facilitated the classification of compounds and the determination of atomic weights.

**ISOPODS**, a group of 14-footed crustaceans, so called because their thoracic feet, the three anterior in one series and the four posterior in another, are nearly equal; the branches are six pairs and abdominal. Some inhabit the sea, where they are generally parasitic on other animals; others are terrestrial, living in dark and damp places, like the wood lice and cow bug. The eyes are sessile or not placed upon stalks, and the head is distinct from the segment bearing the first pair of feet.

**ISOTHERMAL LINES.** See CLIMATE.

**ISPAHAN**, or *Istahan* (anc. *Aspadana*), a city of Persia, of which it was formerly the capital, in the province of Irak-Ajemi, 210 m. S. of Teheran, in lat. 32° 39' N., lon. 51° 44' E.; pop. probably not more than 60,000. It stands in

the midst of a broad plain watered by the river Zeinderud, which rises in the hill districts W. of the city, and flows eastward, finally disappearing in the desert. For miles around the city stretch groves, orchards, corn fields, vineyards, and shady avenues, interspersed with the ruins of deserted towns and palaces. On approaching the city from the south, travellers cross the river by three beautiful and massive bridges, which lead into spacious gardens watered by canals, and surrounded by numerous pleasure houses. A broad shaded avenue leads from one of these bridges to the great bazaar of Shah Abbas, an enormous length of building vaulted above to exclude heat but admit air and light. Hundreds of unoccupied shops line the sides of this once crowded mart of commerce, after traversing which for nearly two miles the traveller enters the great square of Ispahan, the magnificent Maidan Shah, an oblong open space of upward of 40 acres. In

paintings by native artists, representing the achievements of Nadir Shah and other Persian conquerors. The college of Hussein, a brilliantly colored tile-covered structure, the shah's mosque, and the three-storied Ali gate, which is the highest edifice in the city, are among the finest buildings. Ispahan was formerly distinguished for the excellence of its manufactures, which consisted of all kinds of woven fabrics, from the most costly gold brocade to the most ordinary calico or coarse cotton; of gold and silver trinkets, paper, pen cases, ornamental book covers, firearms, swords, glass, and earthenware. These goods were sent to nearly all parts of Asia, Ispahan being a central emporium on the great line of traffic between Afghanistan, India, and China on the east, and Turkey, Egypt, and the Mediterranean on the west. The trade of the city, however, has greatly diminished, and its manufactures are now comparatively inconsiderable. The wine

of Ispahan is thought not much inferior to that of Shiraz. The inhabitants are generally educated, so that almost every one can read and write, and even the shopkeepers and artisans are familiar with the works of the principal Persian poets. The merchants, who form a distinct class, are shrewd and enterprising.—On the S. side of the Zeinderud, which at Ispahan is said to resemble the Seine at Paris in magnitude, is the Armenian suburb of Julfa. This place was founded about 1603 by Shah Abbas, who transported



Court of the Grand Mosque, Ispahan.

to it all the inhabitants of the Armenian town of Julfa on the Araxes, and gave them full toleration for their religion, and valuable privileges as merchants. This colony prospered for more than a century, and once contained 30,000 people and 24 churches. It has now greatly decayed, and has not more than 3,000 inhabitants, and the Armenians are forbidden any of the outward observances of their faith.—Ispahan is mentioned by historians as early as the 3d century. By the caliphs of Bagdad it was made the capital of their Persian provinces. Tamerlane captured it in 1387, massacred 70,000 of the inhabitants, and nearly ruined the city. It recovered at the beginning of the 17th century, and was the favorite abode of the monarchs of the Sufi dynasty. It was visited in 1673 by the French traveller Charlin, who resided there four years, and who describes it as a great city 24 m. in circuit, with 160 mosques, 48 colleges, 1,800 caravansaries,

the centre of two sides of this square are superb mosques, and in the centre of the other sides are great gates leading to the bazaars and to the royal mosque. Around the rest of the square are stately edifices of uniform architecture, once used as apartments for the nobility and officers of the Persian court, but now ruinous and desolate. In the S. part of the city is an extensive pleasure ground, called the Tehabar Bagh, consisting of eight gardens or "paradises," watered by canals, basins, and fountains, adorned with palaces, and enclosed by lofty walls. The most sumptuous of these palaces is the Tehehel Situn, or "Forty Columns." The columns from which the name is derived are in the principal hall, and are inlaid with mirrors so as to resemble pillars of glass. The walls and roof are decorated with the same fragile material, interspersed with flowers of gold. Behind this hall are many fine apartments, one of which is embellished with large

278 public baths, and a population of 600,000. Other authors state the population at upward of 1,000,000. There are said to have been 1,400 villages in the vicinity of the city at the height of its prosperity. But in 1722 it was taken by the Afghans after a siege of eight months, and its buildings were defaced and people massacred in frightful numbers. This catastrophe nearly destroyed the city. The seat of government was removed first to Shiraz, and afterward to Teheran. Although the traveller rides for miles through deserted streets, ruined buildings, and silent squares, Ispahan is still the most stately and beautiful city of Persia; but the traces of its original splendor are fast disappearing.

**ISRAEL.** See JACOB.

**ISRAELITES.** See HEBREWS.

**ISRAELS, Josef,** a Dutch painter, born in Groningen in 1824. He studied in Amsterdam and Paris, and resides at the Hague. His best known works are "The Tranquil House," in a private collection in Brussels; "The Shipwrecked," "The Cradle," and "The Mother," all in London; "The True Support," in possession of the count of Flanders, brother of Leopold II.; and "The Children of the Sea," in the gallery of the queen of Holland. One of his genre pictures brought 7,150 florins at the public sale of Baron van Reede van Oudtshorn's collection at Amsterdam in 1874.

**ISSAQUENA,** a W. county of Mississippi, bounded W. by the Mississippi river and S. E. by the Yazoo, which is navigable by steamboats; area, 720 sq. m.; pop. in 1870, 6,887, of whom 6,146 were colored. It is drained by Big Sunflower river, Deer creek, and Steel's bayou, and has a low and level surface, portions of which are often inundated. The soil is rich. The chief productions in 1870 were 82,825 bushels of Indian corn, 5,105 of sweet potatoes, and 15,821 bales of cotton. There were 562 horses, 931 mules and asses, 619 milch cows, 1,559 other cattle, and 1,675 swine. Capital, Tallulah.

**ISSOIRE,** a town of Auvergne, France, in the department of Puy de-Dôme, at the confluence of the Crouze and the Allier, 81 m. W. S. W. of Lyons; pop. in 1866, 6,294. It has a fine church of the 11th century, a college, copper works, and an active trade.

**ISSOUDUN,** a town of Berry, France, in the department of Indre, on the river Théols and on the railway from Orleans to Limoges, 22 m. S. W. of Bourges; pop. in 1866, 14,261. It contains the ruins of a castle built in the 12th century, and has four churches, a theatre, manufactories of cloth and faience, and an important trade in corn and wine.

**ISSUE.** I. In law, used in deeds and wills to signify descendants. When employed in a deed, the term has a definite meaning. It is always construed to be a word of purchase, designating persons in being, and vesting in each of them an original interest. It cannot be a word of limitation, for that would confer on issue, whether in being or not, derivative interests

devolved upon them through descent from the original taker; and such estates of inheritance can be created in deeds only by the word heirs. We have used the word purchase in its technical sense. In law, all estates are acquired either by purchase or by descent; and it therefore follows that all estates not acquired by descent or by inheritance are acquired by purchase.—The construction of the word issue in wills has involved much uncertainty and difficulty; for it is a term of the most extensive import. It may embrace all descendants to the remotest degree, or may be limited to immediate descendants, or confined to some particular class of descendants living at a given time. Of the rules of construction established by the discussion of this perhaps most vexed question in the whole range of legal learning, it must suffice to state only the most general. In a will, issue may be regarded as a word either of limitation or of purchase. If real estate be devised either directly to, or by way of executed trust for, a "person and his issue," the word is here taken to be one of limitation; and it confers on the devisee an estate tail. Yet if it clearly appear from any expressions in the will that the testator did not intend to give such an estate, or that by issue he meant children, or any particular class of descendants, then the word will be construed as a word of purchase; and it will then comprise all who can claim as descendants from him to whose issue the bequest is made.—The different phrases which express default of issue have been the subjects of frequent and very nice construction. The failure of issue may be what is called a definite failure, when the will fixes a definite time for such failure, as if the devisee die "without issue living at the time of his death;" or it may be indefinite, when no period is fixed, but the contingency continues so long as the devisee has any descendants. A limitation over after a definite failure of issue is good; but not upon an indefinite failure, for the contingency is too remote. In the case therefore of a devise to A in fee, with remainder to another upon A's death without issue, the limitation over is void, and A's estate in fee is reduced to an estate tail. This is the general rule of the common law, though in the United States the courts seek to evade its authority, and often avail themselves of slight circumstances to support the executory devise. They have done so when the limitation was to the brother of A if the latter died without children; or to "survivors" when either of several devisees should die "without issue alive," or "without lawful issue." In many of the states much of the difficulty is obviated by express statutory enactments. The American cases generally follow the English common law rule in regard to limitations over upon the bequest of chattels; and, by confining the expression "without issue" to issue living at the death of the first taker, support executory devises. II. In pleading, the point or matter in contest between the parties to a

suit. When in the course of their alternate pleadings the parties have reached a specific matter which one of them affirms but the other denies, they are said to be at issue, or, in the ancient language of the law, *ad exitum*, or at the end of their pleadings. An issue may be either of law or of fact. When a defendant demurs to the plaintiff's allegation, that is, denies its sufficiency as matter of law to support the plaintiff's action, he is said to tender an issue in law, and the other party is compelled to accept it. But if the defendant traverse the plaintiff's fact and propose to refer the matter disputed to some mode of trial, he tenders an issue of fact. The plaintiff may demur to the traverse or may join issue; indeed, he must do so when the issue is well tendered. An issue of fact is properly framed upon a direct negation or denial of an averment. As the object is to reach the precise and essential subject for decision, the pleadings should develop some matter either of law or fact which, when decided, shall dispose of the whole controversy. They must therefore be directed not merely to the production of an issue, but to the production of one which is material. For issue joined upon an immaterial point, that is, a point not decisive of the right of the case, is fatally defective, and judgment upon any verdict found will be arrested by the court. Further, as in respect to any single subject of suit the decision of one material point may decide the action, it has become a rule that the pleadings shall tend not only to materiality, but also to singleness in the issue; in other words, no plea may allege several distinct matters, when any one of these would singly support the action. Finally, this single material issue must be so particular in its character as to point out distinctly the nature of the matter in controversy. Upon the declaration the parties may join general or special issue; issues joined on later pleadings in the suit are called simply issues without other description. The general issue denies all the material allegations in the declaration, or rather it enables the defendant to demand proof of all of them. A special issue, properly speaking, is the denial of one of several substantive facts which are essential to the right of action. A traverse of one essential point is plainly as complete a denial of the plaintiff's right of recovery, as the traverse of his whole declaration by a general issue could be. The legislation both in England and the United States has for some time been in the direction of requiring the specific fact in controversy to be put plainly in issue by the pleadings.—Feigned issues are sometimes framed in chancery for the purpose of submitting disputed questions of fact to the ordinary modes of trial at law. Thus, if it be contested whether A is the heir of B, the fact will be sent to be tried in a law court upon a fictitious suit. For example, one party may declare that he wagered with another that B was the heir of A; he then avers that he is so, and demands the wager. The defendant ad-

mits the wager, but avers in reply that B is not the heir of A. Upon these allegations issue is joined, and the fact is decided in the usual modes. Feigned issues may also be employed by suitors in courts of law for determining a single point expeditiously.

**ISSUS**, an ancient town of Cilicia, in Asia Minor, at the head of the gulf of Issus, celebrated for the battle fought near it in 333 B. C., in which Alexander the Great defeated Darius. Its exact site is uncertain. The battle also between the army of Septimius Severus and Niger (A. D. 194) was fought near Issus.

**ISTAPA**, or **Istapam**, a port on the Pacific coast of Guatemala, in Central America, in lat. 18° 58' N., lon. 90° 43' W., at the mouth of the river Michatoyat. Alvarado here built the vessels in which he sailed against Pizarro and Almagro in Peru, in 1533. It remained the only port of Guatemala on that side of the continent till 1853, when it was abandoned for a point called San José, 12 m. N., which was supposed to have fewer disadvantages. Both Istapa and San José, however, are entirely open to the sea, and vessels are unable to approach nearer than 1½ m. from the shore, where they are obliged to anchor on a bottom of shifting sands, prepared to stand out to sea at a moment's warning.

**ISTEE**. See **DANUBE**.

**ISTHMIAN GAMES**, one of the four great national festivals of Greece, celebrated on the isthmus of Corinth in April or May of every alternate year, in the second and fourth years of each Olympiad. The story of their origin is as follows: Athamas, king of Orchomenus, had by his second wife Ino a son named Melicertes, whom together with his mother he pursued in a fit of madness. In order to escape from him they jumped into the sea. Ino was changed into a sea goddess, and the body of Melicertes was washed ashore and buried by his uncle Sisyphus, who was directed by the nereids to pay him heroic honors under the name of Palæmon. Sisyphus accordingly established the Isthmian games in honor of Neptune and Palæmon. The games, however, fell into disuse, and were for a time entirely interrupted, till Theseus organized them anew in honor of Neptune. In the 6th century B. C. they became Pan-Hellenic festivals. Until the overthrow of Corinth by Mummius (146 B. C.), the games were conducted by the Corinthians, though the Athenians held the places of honor, the *προεδρία* or front seats. The privilege was then given to the people of Sicyon. After the rebuilding of Corinth by Cæsar, they were again managed by that city, but the people of Sicyon had the exclusive right to sit as judges. They continued regularly till Christianity began to spread, when they fell into decay, but were still celebrated under Constantine and Julian. The Isthmian games, like the Olympic, consisted of all kinds of athletic sports, wrestling, boxing, gymnastics of every sort, racing on foot and in chariots, and also con-

tests in music and poetry. The Romans added to them gladiatorial shows and fights of wild beasts, which were continued to the time of the final decay of the festival. The prize was a simple garland of pine leaves. Solon, in his legislation, ordered the sum of 100 drachmæ to be paid to any one who took a prize at the Isthmian games, and 500 to any one taking an Olympic prize.

**ISTRIA** (anc. *Histria*), a peninsula and margraviate of Austria, on the N. E. coast of the Adriatic; area, including the Quarnero islands, 1,907 sq. m.; pop. about 255,000. It now forms, conjointly with the circle of Görz and the city of Trieste, the Littoral province, but has its own diet. Nearly all the inhabitants are Roman Catholics. It is in general mountainous, particularly toward the north, where the surface is occupied by offsets of the Julian Alps. The highest elevation is Monte Maggiore, about 4,500 ft. The coasts are irregular and indented by numerous good harbors. The soil is not remarkably fertile, but excellent olives, and grain, wine, lemons, and silk, are produced. Sheep and cattle are extensively reared in the mountainous districts, and the coast fisheries and salt works employ a considerable number of the inhabitants. The chief towns are Capo d'Istria, Pirano, Isola, Rovigno, Pola, Dignano, and Pisino. The people of the towns are mostly Italians, and those of the rural districts of Slavic origin.—In remote antiquity the Istrians were an Illyrian tribe, and were engaged in piratical enterprises, but prior to the second Punic war were reduced to submission by Roman consuls. They were again reduced by the consul Claudius Marcellus (183 B. C.) and the consul C. Claudius Pulcher (177 B. C.), and did not again revolt. Under Augustus Istria was incorporated with upper Italy. The most flourishing period of its ancient history was while the Roman government was fixed at Ravenna. It formed a separate margraviate in the 10th century, and was subject successively to the dukes of Carinthia and of Dalmatia. The Italian part of Istria was held by the Venetians from the 13th century till 1797, the eastern part being incorporated with Carinthia and subject to the house of Austria. Both portions were ceded to Napoleon I., and reconquered by Austria in 1813.

**ISTURIZ, Francisco Xavier de**, a Spanish statesman, born in Cadiz in 1790, died in April, 1871. After the fall of Joseph Bonaparte and the restoration of Ferdinand VII., those in Cadiz who were discontented with the rule of the latter were accustomed to meet in the house of the brothers Isturiz, which was known as the *casa Otomana*. This was the headquarters of the movement led by Riego (Jan. 1, 1820), "which made an anarchy of three years succeed a despotism of six." Xavier de Isturiz went to Madrid, where he aided in establishing liberal clubs; and having thereby placed himself in opposition to Arguelles and Martinez de la Rosa, who represented the moderate con-

stitutionalists, he excited public opinion against them, especially after his election to the cortes in 1822. In 1823, while president of this body, he voted for the suspension of the royal power. Condemned to death after the restoration, he fled to London, where he was a partner in the mercantile house of Zulueta. Pardoned by the amnesty of the queen regent Maria Christina in 1834, he returned to Spain, where he at once engaged in democratic agitation and provoked the rising of the national guard, whose object was the overthrow of the minister Toreno, but which was suppressed by Quesada. Shortly afterward his friend Mendizabal became prime minister, and made Isturiz his most intimate adviser. In November, 1834, he was appointed president of the chamber of *procuradores*, a sort of state council. The chamber proved too liberal, which caused a quarrel and a duel between Isturiz and Mendizabal. After the fall of the latter in 1836, Isturiz was appointed minister of foreign affairs and president of the council, but soon grew unpopular with all parties. The tumults of August, 1836, which resulted in the proclamation of the constitution of 1812, compelled him to take refuge a second time in England, whence he went to France. Having returned to Spain in 1838, he was elected to the cortes, and was its president in 1839. He negotiated the marriages of the young queen and her sister. In 1848 and again in 1850 he was sent as minister to England, and in 1856 to Russia. On Jan. 5, 1858, he became president of the Spanish senate, and 10 days after minister of foreign affairs and president of the council, but was soon superseded. The same year he was again sent as minister to England. He signed, in conjunction with M. de Flahault and Earl Russell, the convention of Oct. 31, 1861, relative to Mexico. From March, 1863, to October, 1864, he was minister to France.

**ITACOLUMITE** (from Itacolumi, a mountain of Brazil), a granular silicious rock, of laminated structure, found with talcose slates and more or less intermixed with talc or with mica. It is distinguished by its peculiar flexibility, sheets of it bending back and forth as if jointed within. It is of particular interest from its occurrence at the localities in the gold regions where diamonds are found. It is met with in Brazil, the Ural mountains, and in Georgia and North and South Carolina. In the last named state Mr. Oscar Lieber has observed the passage of the itacolumite into a true sandstone or a conglomerate, proving its sedimentary origin.

**ITALIC RACES AND LANGUAGES.** In one sense all the various races that occupied the Italian peninsula in ancient times belong to the Italic group; in a more exact classification, only those races and languages are comprised in this division whose characteristics show that they form a distinct branch of the Aryas or Indo-European family. In the former sense we find that Liguria in upper Italy was inhabited by an ancient people called the Ligures



of whose origin nothing authentic is recorded, and of whose language no one is extant. Several modern writers maintained the Celtic origin or affinity of the Gauls, while others have denied that any connection with the Indo-European Gauls of upper Italy, according to the traditions followed by Livy, immigrated into Italy under Tarquinius Priscus, and they are called the Veneti. The inhabitants of Venetia, in the west, and the Carni in the east, were described by Polybius as a different people from the Gauls their neighbors, and as using a different language. Herodotus represents the Veneti as an Illyrian tribe, but it seems that the name was given indiscriminately to all the tribes of the N. and E. coasts of the Adriatic. Modern scholars are inclined to regard the Veneti as related to the Illyrians, and the Sabellians as the ancestors of the present Albanians. No good reason for referring their neighbors to the same stock; but the more probably Celtic. The Etruscans, as Livy describes as once great and powerful, and occupying the whole tract between the Alps and the sea, were of little importance in historical times, and there are no good reasons to deduce their ethnological origin from the affinity of the Etruscans also to the Sabellians. It has been established, and they have been classed as Semites, Indo-European, or Mongolians; but it is probable that it will some day be determined, as the possession of a sufficient number of words of their language to lead finally to a determination, while the linguistic material of other nations consists only in proper names and a few words scattered through the languages of the Greeks and Romans. The portion of the S. E. of Italy seem to have been composed of several tribes or nations, among which were the Messapians, the Peucetians. Niebuhr considers the Peucetians etymologically connected with the Apulians. The Apulians properly so called by a branch of the great Oscan or Umbrian, and not of the Sabellian race. The neighbors of the Peucetians, were the Lucanians, whose first appearance in history coincided with the Apulians. The Peucetians, however, retained a separate nation until a comparatively late period. On the southern peninsula were the Messapians or Lucanians, and the Salentines. Both represented in ancient tradition as descended from the Greeks, as it seems that they were closely related to the Hellenic races, as they adopted the manners and arts of the Greeks. Modern authorities consider the Lucanians and Messapians as of the same race, and the Salentines as still remaining of the Messapian race. The opinion of their Hellenic origin, as their language has differed from Greek to no more than the Macedonian and other languages of the oldest tribes of Italy

are described by ancient writers as belonging to the Pelasgic race. (See PELASGIANS.) A large portion of central Italy was occupied from an early period by a people whom the Greeks called Opicans and the Latins Oscans, and whom many identify with the Ausonians of the Greeks and the Auruncans of the Romans. The Volsci and their neighbors the Æqui also were probably of Oscan race. It is believed that the Latini or inhabitants of Latium were composed of two distinct races, the one more closely related to the Greek or Pelasgic stock, the other to the Italic race proper; but when the Latin people first appeared in history, these two elements were certainly blended into one, and they and their language are always regarded by Roman writers as an organic whole. The oldest form of the Latin bore a close resemblance to the extant monuments of the Oscan language. It is difficult to determine the precise relation which the primitive Oscans bore to the Sabines or Sabellians, but there are strong reasons for supposing that both nations were members of the same family or race. It seems certain that the immigration of the Sabellians cannot be carried back to a very remote age. When first mentioned they had not been long established in central Italy, and their extension further south took place soon after the establishment of Greek colonies in the south of the peninsula. The original territory of the Sabines was the central Apennines, whence they descended and pressed upon an Oscan race whom they expelled from the valleys about Reate. The Sabines gradually extended as far as the region still known as La Sabina, and separate colonies of Sabines established themselves to the east and west of their early abode. The most celebrated of these were the Samnites and the Piceni or Picentes. The Sabine descent of the Peligni is clearly attested, and the close connection of these with the Marsi, Marucini, and Vestini renders it probable that these four nations were of the same ethnic origin. The Frentani, Hirpini, and Lucanians are also usually described as separate Samnite colonies, and the Bruttians seem to have been a mixed population, made up of Lucanian conquerors and Enotrian serfs. But though the Sabellian race reached thus from the neighborhood of Ancona to the southern extremity of Bruttium, it appears to have been a race of conquering warriors who rapidly blended with the Oscan population whom they subdued. The most ancient people of Italy, on the unanimous testimony of ancient authors, were the Umbrians, who at a very early period were a great and powerful nation in the northern half of central Italy. According to Xenodotus of Træzen, the Sabines themselves were a branch of the Umbrians. Philological research has clearly established that the Umbrian language was quite distinct from the Etruscan, and closely related to the Oscan as spoken by the Sabellian tribes, and also to the old Latin. This

seems to warrant the now generally received opinion that the Umbrians, Oscans, and Latins, or at least the most important element of them, as well as the Sabines and their descendants, were branches of one race, or form a distinct and independent group of races belonging to the Aryan or Indo-European family.—LANGUAGES. The Italic group of languages is divided into two distinct classes, the Umbro-Samnite or Umbro-Oscan and the Latin. Oscan and Umbrian bear about the same relation to Latin as the Ionic bears to the Doric dialect in Greek, and the differences between Oscan and Umbrian are no greater than those between Sicilian and Spartan Doric. The most ancient if not the only extant Umbrian record of importance is the celebrated Iguvine or Eugubian inscription on seven bronze plates found in 1444 at Gubbio, the ancient Iguvium in Umbria. It is now in the town hall of Gubbio. The Oscan, Samnite, or Sabellian language is preserved only in a few inscriptions. The *Cippus Abellanus*, which dates from shortly after the second Punic war, contains a treaty of alliance between the citizens of Abella and the neighboring town of Nola, where it is now preserved. The *Tabula Bantina* is a bronze tablet found in 1790 at Oppido, 8 m. from Banzi, an ancient town of Apulia. This tablet furnished the starting point for the study of these languages, as it contains an inscription in both Latin and Oscan. Another bronze tablet was recently discovered at Agnone, in northern Samnium, which contains a dedication of various sacred offerings. The Oscan language prevailed extensively in Campania, and numerous inscriptions have come to light at Herculaneum and Pompeii, several of which have been copied and translated, and all of them are published from time to time in the official reports of the progress of the excavations. The language of the Latins was spoken before the emigration of the Samnites by the Ausonians in Campania, by the Itali proper in Lucania and Bruttium, and probably also by the Sicilians in the eastern portion of Sicily. In Latium proper it was developed, through the influence of the Etruscans and Umbro-Samnites, into the Latin language, which became the prevailing speech of Italy and was finally known as the Roman language (*lingua Romana*), and gave rise to the modern dialects now described as the Romance languages. (See LATIN LANGUAGE AND LITERATURE, and ROMANCE LANGUAGES.)—For the Umbrian language, see Grotefend, *Rudimenta Linguae Umbrae* (Hanover, 1835-'9); Aufrecht and Kirchhoff, *Die umbriſchen Sprachdenkmäler erläutert* (Berlin, 1849-'51); and Huschke, *Die iguvinischen Tafeln*, containing a grammar and glossary (Leipzig, 1859). For the Oscan language, see Grotefend, *Rudimenta Linguae Oscanae* (Hanover, 1839); Mommsen, *Oskische Studien* (Berlin, 1845); Kirchhoff, *Das Stadtrecht von Bantia* (Berlin, 1853); Huschke, *Die oskischen und sabellischen Sprachdenkmäler* (Elberfeld, 1856), which contains also a

grammar and glossary of the language. For comparative purposes, see Mommsen, *Die un-teritalischen Dialecte* (Leipzig, 1850); Corssen, *De Volscorum Lingua* (Naumburg, 1850), and several articles in Kuhn's *Zeitschrift für vergleichende Sprachwissenschaft*; and *Corpus Inscriptionum Latinarum Consilio et Auctoritate Academiae Litterarum Regiae Borussiae edita* (Berlin, 1869 *et seq.*).

ITALY, a kingdom of southern Europe, comprising the Italian peninsula and the islands of Sardinia and Sicily, between lat. 36° 38' and 46° 40' N., and lon. 6° 30' and 18° 33' E. The island of Corsica and the district of Nice (which encloses the independent principality of Monaco) belong geographically to Italy, but politically to France; the republic of San Marino is also included in Italy geographically, but is an independent state. The origin of the name Italy is differently explained by ancient writers. According to Timæus and Varro, it is derived from *itabē*, calf or ox, meaning a country in which cattle abound; while Thucydides and Dionysius of Halicarnassus assume the existence of a mythical king named Italus, to whom the country owes its name. The kingdom is bounded N. W. by France, N. by Switzerland and Austria, N. E. by Austria, E. by the Adriatic and the Ionian sea, and S. and W. by the Mediterranean. The total area of the kingdom was officially estimated in the work *Italia Economica* (Rome, 1873) at 114,409 sq. m., while other official publications of the Italian government give 114,850 and 114,372 sq. m.; the population, according to the first complete census, taken Dec. 31, 1871, amounted to 28,801,154. Italy has been until recently merely a geographical and ethnographical division of Europe, but not a political unit. During the middle ages it was divided into independent commonwealths, republican and monarchical, which were constantly changing in name, number, and extent. The treaty of Vienna (1815) divided the Italian territory into the kingdoms of Sardinia and the Two Sicilies, the States of the Church, the grand duchy of Tuscany, the duchies of Parma, Lucca, and Modena, the Lombardo-Venetian kingdom (which was united with Austria), the republic of San Marino, and the principality of Monaco. Lucca ceased to be an independent state in 1847; the king of Sardinia in 1859 and 1860 annexed Lombardy, Parma, Modena, Tuscany, a part of the Papal States, and the Two Sicilies, and in February, 1861, assumed the title king of Italy. In 1866 Venetia was incorporated with Italy, and in 1870 the remainder of the Papal States. The kingdom is at present (1874) divided into 69 provinces, which are again subdivided into districts (*circondarii*) and communes. The names of the principal old divisions are still in common use, though they have no longer any political significance. The following table exhibits the area, number of districts, number of communes, and population of the provinces and large historic divisions, ancient and modern:



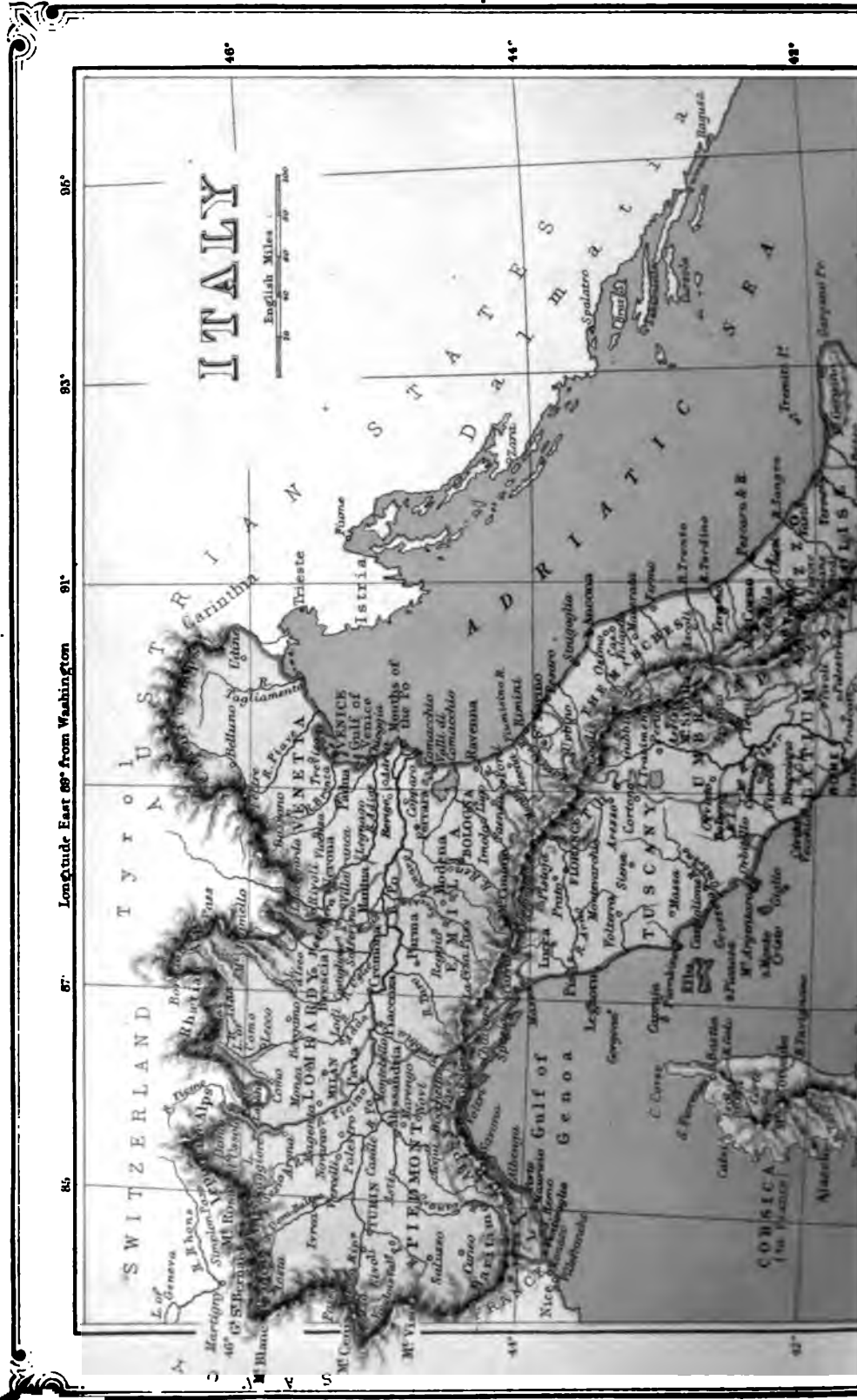

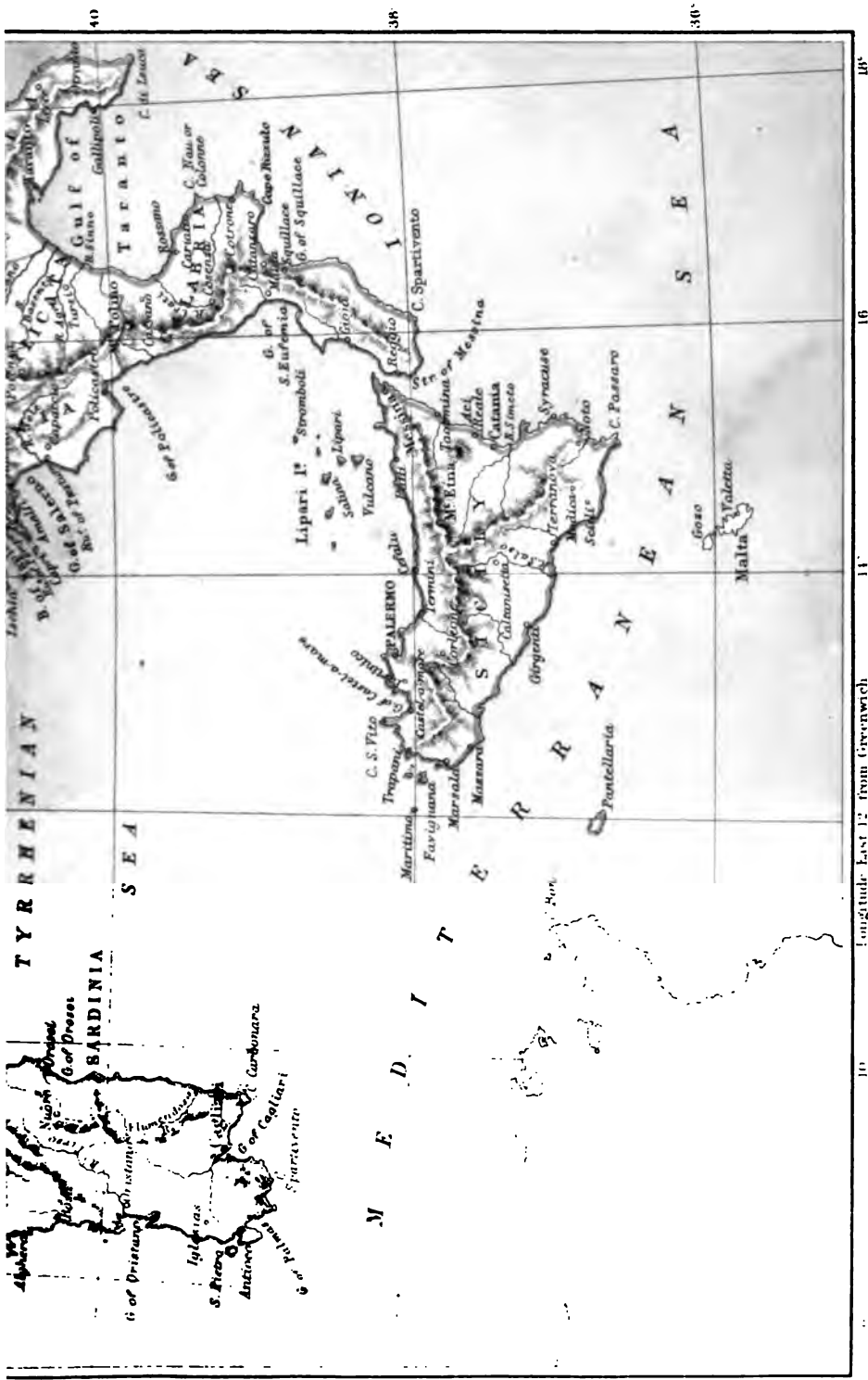

Longitude East 12 from Greenwich



NAMES OF PROVINCES AND LARGE DIVISIONS.	Area.	Dis-tricts.	Com-munes.	Pop. in 1872.	NAMES OF PROVINCES AND LARGE DIVISIONS.	Area.	Dis-tricts.	Com-munes.	Pop. in 1872.					
<b>PIEMONTE.</b>					<b>CAMPANIA.</b>									
Alessandria.....	1,952	6	344	683,861	Avellino.....	1,409	3	123	375,691					
Cuneo.....	2,755	4	263	618,232	Benevento.....	688	3	73	232,008					
Intra.....	2,526	6	438	624,935	Caserta.....	2,307	5	185	697,403					
Novara.....	4,008	5	442	972,956	Naples.....	412	4	69	907,732					
Total.....	11,301	21	1,487	2,899,564	Salerno.....	2,136	4	159	541,733					
<b>LIIGURIA.</b>					<b>APULLIA.</b>									
Genoa.....	1,539	5	210	716,759	Bari.....	2,293	3	53	694,540					
Imperia.....	467	2	107	127,033	Foggia.....	2,953	3	59	322,753					
Total.....	2,006	7	317	843,792	Lecco.....	3,293	4	130	439,564					
<b>LOMBARDY.</b>					<b>BASILICATA.</b>									
Bergamo.....	1,088	3	306	363,152	Potenza.....	4,122	4	124	510,543					
Brescia.....	1,644	5	283	456,023	<b>CALABRIA.</b>									
Como.....	1,050	3	518	477,642	Catanzaro.....	2,307	4	152	412,226					
Cremona.....	632	3	133	300,565	Cosenza.....	2,841	4	151	449,463					
Lecco.....	962	11	67	288,942	Reggio.....	1,515	3	107	333,603					
Lodi.....	1,155	5	318	1,099,794	Total.....	6,663	11	410	1,306,392					
Mantua.....	1,292	4	263	445,435	<b>SICILY.</b>									
Milano.....	1,262	1	78	111,241	Caltanissetta.....	1,455	3	28	290,666					
Total.....	9,085	35	1,963	3,460,824	Catania.....	1,979	4	64	495,415					
<b>VENETIA.</b>					<b>SARDINIA.</b>									
Verona.....	1,271	7	66	175,232	Cagliari.....	5,207	4	255	308,203					
Trento.....	735	3	103	364,439	Sassari.....	4,142	5	110	243,452					
Padua.....	651	8	68	200,335	Total.....	9,399	9	365	696,690					
Vicenza.....	941	8	96	332,533	Total Italy.....	114,469	254	8,882	26,801,154					
Treviso.....	2,515	17	180	431,586	—The length of the coast line of Italy, exclu-									
Udine.....	859	7	51	337,533	sive of the islands (for the description of which									
Venezia.....	1,061	11	113	367,437	the reader is referred to the respective articles),									
Rovigo.....	1,016	10	123	363,161	is upward of 2,000 m. The western portion									
Total.....	9,060	76	795	2,642,507	of the coast of the gulf of Genoa is called Ri-									
<b>EMILIA.</b>					viera di Ponente, shore of the setting sun; it									
Bologna.....	1,391	3	58	439,232	is lofty and precipitous, and extends from									
Parma.....	1,010	3	16	215,369	the mouth of the Roja at Ventimiglia to Genoa.									
Modena.....	719	3	40	234,090	From Genoa to Spezia is the Riviera di Levante,									
Reggio.....	966	3	45	273,231	shore of the rising sun, offering less of alpine									
Piacenza.....	1,251	3	50	264,351	characteristics, but still bold and mountainous.									
Ravenna.....	905	2	48	225,775	From the mouth of the Arno to that of the									
Ferrara.....	742	3	21	221,115	Tiber, the coast in Tuscany is occasionally bold,									
Cesena.....	877	2	45	240,635	but for the most part low and swampy, with									
Total.....	7,921	22	323	2,113,828	several bays toward the south. In the former									
<b>MARCHES.</b>					Papal States it is almost everywhere low and									
Ancona.....	736	1	51	262,349	marshy, scarcely raised above the sea level in									
Senigallia.....	809	2	71	203,004	the neighborhood of Ostia, and S. of the Tiber									
Osimo.....	1,057	2	54	236,994	presents the same dull level aspect, broken only									
Urbino.....	1,144	2	73	213,072	by the headland and large projecting moles of									
Total.....	3,746	7	249	915,419	Porto d'Anzio. The Neapolitan coast along									
<b>UMBRIA.</b>					the Tyrrhenian sea is for the most part bold									
Perugia.....	3,270	6	173	549,601	and rocky, and scooped out into broad and deep									
<b>TUSCANY.</b>					bays, whose shores are dotted with historic ci-									
Arezzo.....	1,278	1	41	234,645	ties and towns. The part washed by the Ionian									
Florence.....	2,263	4	78	766,324	sea, from the straits of Messina to Cape Riz-									
Livorno.....	1,707	1	20	107,457	zuto, is faced by steep rocks backed by alpine									
Pistoia.....	126	2	5	118,851	heights. Beyond Taranto, and almost through-									
Siena.....	575	1	22	230,399										
Arezzo e Carrara.....	687	3	35	161,944										
Arezzo.....	1,180	2	40	265,959										
Arezzo.....	1,465	2	37	206,446										
Total.....	9,287	16	278	2,142,525										
<b>LATINUM.</b>					<b>VENETO AND MOLISE.</b>									
Rome.....	4,601	5	227	836,704	Belluno.....	2,510	4	127	332,734					
<b>VENETO AND MOLISE.</b>					<b>VENETO AND MOLISE.</b>									
Trento.....	1,778	3	134	364,208	Trieste.....	1,105	3	121	339,986					
Verona.....	1,294	2	74	246,004	Udine.....	1,284	2	74	246,004					
Total.....	6,677	12	456	1,382,932	Total.....	6,677	12	456	1,382,932					

out the whole peninsula of Otranto, the shore is low and sandy; and at the bottom of the gulf of Taranto lies the only marshy district along the coast of the Ionian sea. From Cape Santa Maria di Leuca the shore is only broken by the spur on which stand Mts. Gargano and Sant' Angelo, and the gulfs of Manfredonia and Venice. From the river Tronto the shore is flat and sandy as far as Ancona, between the promontories of Monte Ciriaca and Monte Conero. Thence northward to Rimini the coast rises gradually, to subside rapidly beyond that city into a series of sandy islands, lagoons, and pestilential marshes, extending almost to the mouth of the Isonzo. The principal harbors along this vast line of coast are: on the west, Genoa, Spezia, Leghorn, Civit  Vecchia, Gaeta, Naples, and Reggio; on the south, Taranto; on the east, Brindisi, Bari, Ancona, Rimini, Chioggia, and Venice. The most important islands along the coast are Elba, Ischia, and Capri on the west.—The surface of the peninsula is divided by its mountain ranges into a wonderful diversity of sublime alpine scenery, upland valleys, broad plains, pestilential lowland and marsh, and numerous lakes surrounded by every charm of nature. Between the steep northern wall of the Alps and the ridges of the Apennines, to the west and south, stretches the great Lombard plain, the most fertile region in Europe, watered by the Po and the Adige, the two largest rivers of Italy. From Bologna and Imola, on the S. extremity of this plain, to the straits of Messina, the remainder of the peninsula is divided by the Apennines into a broad mountainous belt, marked by lofty peaks clad with forests to their summits, by numberless valleys between the parallel ranges or their interlocking spurs, and by rolling uplands and plains available for all the purposes of husbandry. Between the central ridges and the seashore lie wide bands of marshy and pestilential country, and several plains which, though far inferior in extent and fertility to that of Lombardy, possess considerable importance. These are, on the W. side, Campagna di Roma with the Pontine Marshes, and the Campagna Felice near Naples; on the E. side, the Apulian plain, anciently one of the chief seats of Grecian civilization, now almost a desert and thinly populated (the plain of Basilicata), extending in the south along the shore of the Ionian sea, on which formerly flourished the Greek cities of Sybaris and Heraclea.—The great mountain systems are the Alps and the Apennines, including the Sub-Apennine ranges. The former begin on the axis of the Ligurian chain, not far from the source of the Bormida, and sweep round in an irregular semi-elliptic curve along the frontiers of France, Switzerland, and Austria, to the western declivities of the Carnic Alps. The latter from Monte Appio in the Maritime Alps stretch N. E. and E. around the gulf of Genoa, and from Monte Cimone on the confines of Emilia and Tuscany extend to the straits of Messina. (See ALPS, and APENNINES.) The Sub-Apennines lie wholly W. of the main chain, to which they do not appear geologically to belong, and, under the appellations of Tuscan, Roman, and Neapolitan Sub-Apennines, extend to Mt. Vesuvius in the south, and terminate at Punta della Campanella opposite the island of Capri; they embrace a great part of the plain of the Arno and the Campagna di Roma. Of the innumerable valleys of the sub-Alpine region, the most renowned are the Val di Clusone, once the refuge of the Waldenses, that of the Dora Susina above Turin, the Val d'Aosta, and the Valtellina, with such as are formed by the other affluents of the Po and those of the Ticino, the Adige, and the Piave, as well as by the rivers that empty into the great lakes. Along the Apennines are the Val d'Arno, those of the Tiber, Volturno, &c., and the beautiful upland valleys of the centre and south.—Italy has but two rivers of importance, viz., the Po and the Adige. The former, with a length of about 400 m., waters, with its tributaries (the Ticino, Adda, Oglio, and Mincio on the N. bank, the Tanaro, Trebbia, Taro, Secchia, and Panaro on the S. bank), a plain extending over 300 m. in length and 170 in breadth. The Adige, descending from the Alps, flows in a semicircle to the east, falling into the Adriatic at no great distance from the Po; it is navigable only to a short distance above Verona. Nearly all the other rivers are mere mountain torrents, having a short course and no considerable depth; hence they afford very limited facilities to commerce. The most noted of them are the Brenta, Piave, and Togliamento in the north, the Arno and Tiber in the centre, and the Garigliano, Volturno, and Silaro (Sele) in the south. The mouths of most small rivers of S. Italy are surrounded with swamps, the noxious gases of which generate malaria and render the surrounding districts almost uninhabitable. Nine principal canals, chiefly for the purposes of irrigation, were constructed during the middle ages in Lombardy and Venetia. The finest of these, the Naviglio Grande or Ticinello, between the Ticino and Milan, was begun in 1179; it is 28 m. long and navigable for vessels of large size. Piedmont is intersected by about 250 canals. This system was perfected at an early period, and proved extremely beneficial to agriculture. The most extensive lakes, several of which are celebrated for the picturesqueness of their surrounding scenery, belong to upper Italy. Lago Maggiore, 40 m. long, has a depth of about 2,500 ft.; its surface is about 700 ft. above the level of the sea; it is fed chiefly by the river Ticino. The lake of Lugano belongs mainly to Switzerland. The lake of Como, 35 m. long, and of great depth, is fed by the river Adda and a large number of smaller streams. Lake Iseo, 18 m. long, is chiefly supplied by the Oglio. Lake Garda, which belongs partly to Tyrol, is 33 m. long, and of sufficient depth to carry vessels of the greatest draught. Besides these, there are the lake of Bientina in Tuscany, the lake of



a (Trasimeno) in Umbria, and the lakes of a and Bracciano in the province of Rome. offers a rich and in many respects an unexplored field to the geologist. Granophyre, and gneiss are found at both northern and southern extremities, as well as the centre. Monte Corvo and other in the Abruzzi are of compact quartz, also covers large tracts in Calabria. nonte on the straits of Messina consists exclusively of primitive rocks. The of the Apennines is composed of lime-chalk, and sandstone, through which at points throughout their whole extent of serpentine have erupted, or have njected between the strata. This rock an important component of the Ligurian ines. Commencing near Savona, and g itself for a considerable space inland as Voltaggio, and toward the sea to , it forms many detached groups of hills, ases to be prominent only at Orbetello, province of Grosseto. It also rises in masses near Bobbio and Fornovo, and n Sassuolo and Modena in the basin of rdy. The great dislocations and cons- of strata in the Ligurian chain are ted to the eruption of this rock. Gneiss, late, clay slate, talc slate, and limestone ogether the lowest stratified series tilt- by the serpentine; above them lies an lage of argillaceous slates, marly sand- and slates, sandstones, and limestones; uppermost are marly limestones and a ne called in the country *macigno*, with sions of marine plants. Upon these are y deposits in horizontal stratification, ted extent and in detached spots, on the ranean side, but forming in Piedmont mbardy a continuous zone on the north- pe of the chain from Ceva to Fornovo. *macigno* is the prevailing stratified rock orthern Apennines; it contains subordi- ds of limestone, but no metallic veins or s, and is supposed to extend southward is Cortona. In this part of the chain are ve tracts of crystallized limestone, which southward along the shore of the Medi- an, forming the brocatello marble of the hill of San Giuliano near Pisa, and ed hills at Piombino, Civit  Vecchia, pe Circello. The Alpi Appuane, at the rn end of the Ligurian Apennines and ing the Carrara marbles, are composed ling to Hoffmann) of Jura limestone, the line state of which is due to the heat poraneous with the eruption of the line. Eastward and southward from s, the Apennines are chiefly composed stone; it forms the Apennines of Tus- Romagna, Fabriano, Foligno, and the i, extending through the provinces of a and Bari to the extremity of Otranto. hout the northern portion of the Lom- lain limestone is the prevailing rock. this limestone, and almost coextensive

with it, is chalk with its accompanying rocks; it stretches along the coast of Genoa and into Parma, crosses Modena and Tuscany, forms to the south a long narrow belt along the E. side of the limestone, and after some partial breaks reaches Cape di Leuca, where its white cliffs form a landmark. In the north of the Neapolitan territory a large oval tract of chalk is enclosed by the limestone. Above chalk and limestone are tertiary sandstones, travertine, and marl, occupying a considerable portion of Tuscany and of central Piedmont, but stretch- ing chiefly in a narrow belt along the E. coast from near Rimini to Monte Gargano; thence the same band spreads out and is continued to the gulf of Taranto. On the coast of Tuscany and in the Roman territory, particularly in the Pontine Marshes, are found partial tracts form- ed by immense diluvial and alluvial deposits, and covering the preceding strata; but it is in the plains of Lombardy, on the N. W. shore of the Adriatic, and filling the greater part of the basin of the Po, that these deposits are most conspicuous. Besides these formations, there are in Italy four distinct volcanic districts, dis- tributed from the head of the gulf of Venice to Sicily. The first is that of the Euganean hills, extending from near Padua to Este, and separated from the Alps by the Paduan plain. The next and largest district is in the Ro- man territory, where it forms three remark- able groups, the Monti Albani, with Monte Ca- vo (anc. *Mons Albanus*); the Monti Cimini, stretching from the Tiber to Civit  Vecchia; and on the road from Siena to Rome a group to which belong the lofty volcanic mass of Ra- dicofani, and 4 m. away Monte Amiato, 5,794 ft. above the sea. The lakes of Bolsena, Brac- ciano, Vico, Albano, and Nemi are in this dis- trict, all or most of them the craters of extinct volcanoes. At the foot of Monte Amiato is a hot crystal spring, holding in solution a con- siderable amount of sulphur and carbonate of lime, of which advantage is taken to form casts. The water is allowed to fall in broken showers upon moulds, and the calcareous de- posit hardens into cameos and intaglios of ex- quisite beauty. The Terra di Lavoro or Cam- pania Felice (now province of Caserta) in Naples is the third district, subdivided into several marked groups: the Roccamonfina group to the north of the Campanian plains; the Phle- græan Fields, embracing the country around Baja and Pozzuoli, together with the neigh- boring islands, and the lakes Averno, Lucrino, Fusaro, and Anagno; and Mt. Vesuvius. The last volcanic district is in Apulia, having for its centre the huge mass of Monte Volture, and for its highest peak the Pizzuto di Melfi, 4,857 ft. In the widest crater are two small lakes. The pools of Ampsanctus (Le Mofete) are in this district, in a wooded valley south of Tri- gento; they emit carbonic acid and sulphuret- ted hydrogen.—The mineral wealth of Italy has been famed from remote times. In the C l di Tenda are mines of lead and silver, considered

as a prolongation of those of Argentière in the French department of Hautes-Alpes, or of those of Pezey in Savoy. Piedmont is rich in metals; the Val d'Anzasca is renowned for its auriferous pyrites, the Val di Macagnaga for its beds of auriferous schists, and the Val d'Aosta for copper pyrites. In the serpentine rocks bordering the gulf of Genoa are rich ores of copper, not sufficiently appreciated in the country; while the mountains of Modena are filled to their very summits with ores of iron, lead, and silver, and most valuable deposits of copper. The Apuan Alps adjacent to the Modena chain, and forming the northern frontier of Tuscany, are traversed by veins of quicksilver, magnetic iron ore, and argentiferous copper and lead ores. The silver was worked by the ancients, as the numerous remains in the neighborhood attest. On the seashore are the ruins of the Etruscan city of Luna, which had for its emblem a crescent, the symbol of silver dedicated to Diana. All through the middle ages the most violent contests raged between the local lords and the city of Lucca for the possession of these mines; the latter remained mistress of them, and coined their silver into money. They were afterward opened afresh by the Medici; and the Bottino mines are still worked and productive. The central and southern districts of Tuscany are equally favored with metalliferous deposits, among which the mines of Terricio and Castellina in the centre, and those of Monte Catini near Volterra, deserve special mention. The latter, known even to the Etruscans, were reopened not many years ago, and now yield enormous profits. Further off are the mines of Campiglia, from which the Etruscans drew the greater part of their bronze. During the middle ages also various mines of iron, lead, copper, silver, alum, and sulphur were worked with great success in Massa Maritima, hence called *Massa Metallifera* to distinguish it from Massa Carrara. All over the face of the country, now covered with marsh and ravaged by fever, ancient pits and ruins of old founderies are counted by the hundred. This same region, in the districts between Massa and Monte Catini, contains the famous *soffioni* or vapor vents, utilized for the extraction of boracic acid. The districts of Siena and Grosseto also have silver and copper mines; and in southern Tuscany, besides these, are veins of quicksilver at Selvina, Pian Castagnajo, and Castellazzero, and lodes of antimony at Montanto and Pereta. All these districts are on the W. flank of the Apennines, or rather on a littoral chain which is a continuation of that skirting the coast of Genoa; hence it has been denominated the metalliferous chain. The former States of the Church are poor in metallic deposits; but the Calabrias possess iron lodes and ancient silver mines. The most important product of the Italian mines is sulphur, which is found in the island of Sicily and exported in large quantities. Sea salt is likewise an im-

portant article of export. The average annual produce of the most important mineral productions is as follows: salt, 440,000 tons; sulphur (1864), 198,000; coal (1862-'6), 49,500; raw iron, 27,500; lead (1862-'6), 4,500; raw copper (1862-'6), 550; zinc (1865), 88; mercury, 25; silver (1865), 7; gold (1864), 482 lbs. —Fossil remains of uncommon interest are found in various parts of the peninsula. Besides the great abundance of fossil shells in Lombardy and Piedmont, the soil covering the marine deposits is filled with bones of the mastodon, elephant, rhinoceros, and other large quadrupeds. But it is in the neighborhood of Parma and Piacenza, and particularly in the basins forming the upper Val d'Arno, that the most extraordinary discoveries have been made. The skeleton of a whale 20 ft. long was found in the marl at Arquato in the former district; while in the latter, among the lacustrine deposits left in the very centre of the Apennines, are enormous quantities of bones of great quadrupeds of extinct species and belonging to warm climates. Skeletons of the elephant, rhinoceros, mastodon, and hippopotamus are so abundant that the valley is like a vast cemetery, and the peasants were formerly in the habit of enclosing their gaggles with legs and thigh bones of elephants. —There is no part of Italy not possessed of a soil naturally fertile, or capable of being made productive by labor and artificial means. The vast plains of Piedmont and Lombardy have a soil equalled in fertility only by that of Campania Felice, while the remainder of the peninsula, being of calcareous and volcanic formation, is almost everywhere susceptible of tillage. The Apennines in many places are cultivated in terraces to their very summits. Even in the most wintry district of the centre, only the highest peaks are naked; the inferior ranges are covered with forests, the pine tree highest up, the oak beneath, and the chestnut near the plain or valley; while lower still the fig tree and olive flourish. The soil yields abundant harvests everywhere in these central valleys, or affords rich and perennial pastures. The unproductive plains of the former kingdom of Naples were once under high cultivation, and the home of a numerous people. The vast marshes on the east and west anciently fed a large population; parts of them have been reclaimed in recent times, and the present government of Italy has manifested the intention of restoring the remainder to agricultural use. In the volcanic districts the tufa and lava form a soil favorable to husbandry. —The climate of Italy is generally considered the most genial and wholesome in all Europe, but proportionately to the number of inhabitants the mortality is greater there than in any other European country. In summer the burning heat, unrelieved by refreshing showers, withers all vegetation, parches the ground, and imparts to the landscape a gloomy brownish tint. In many places a subterranean heat periodically ends

forth noxious gases. The lagoons and marshes which border the coast generate poisonous miasmata. Besides all this, legions of noxious insects fill the air and infest the dwellings. Nevertheless, there are districts in Italy which in regard to salubrioness compare favorably with any in the world. In respect to its climate it may be divided into four regions. Of these the first comprises upper Italy, N. of the Apennines, between lat.  $46^{\circ} 40'$  and  $48^{\circ} 30' N.$  There the temperature in winter is sometimes as low as  $10^{\circ} F.$ ; the snow remains on the ground from 10 to 14 days; the lagoons on the Adriatic are frequently covered with ice; and though the mulberry tree and rice are raised to perfection, the more tender fruits of a southern climate ripen only in sheltered localities. Night frosts begin as early as November, and continue until March or April. Even in the summer months piercing cold N. winds are not uncommon. The second region, extending from lat.  $48^{\circ} 30'$  to  $41^{\circ} 30' N.$ , is that of the olive tree and orange. Frost and snow appear regularly only in the higher mountain districts, but occasionally snow may be seen even in the valleys and plains. The third region extends over  $2\frac{1}{2}$  degrees of latitude, comprising nearly the whole continental portion of the former kingdom of Naples. There the thermometer seldom falls below  $26^{\circ} F.$ ; snow is very rarely seen except on the highest mountains, and never remains; aloes and other semi-tropical plants thrive even in unprotected localities. In the fourth region, comprising the southernmost part of the peninsula, as well as Sicily, the thermometer scarcely ever falls below the freezing point of water; snow and ice are unknown except on the summit of Mt. Etna; tropical fruits, dates, sugar cane, and the cotton plant thrive in the open air; aloes are so common that they are planted for hedge rows; a serene sky of the deepest blue spans the earth and bracing sea breezes temper the heat. But at the same time this portion of Italy often suffers from the common drawbacks of tropical regions, droughts and hot winds (siroccos), equally obnoxious to human and vegetable life. Earthquakes and volcanic eruptions, causing sometimes an appalling loss of life, occur frequently in lower Italy and Sicily. The mean annual temperature is as follows: Milan,  $55.4^{\circ}$ ; Rome,  $59^{\circ}$ ; and Naples,  $61^{\circ}$ .—The vegetable productions of Italy partake of its semi-tropical character. At Bordighera, on the Riviera di Ponente, are found groups of indigenous palm trees. In the basin of the Po the mulberry tree abounds, and great crops of rice are raised. Thence southward the same contrasts of climate and vegetation strike the traveller, as he proceeds from the bare shore into the interior, or leaves the central ridge and its valleys for the coast. In the coldest uplands of the Abruzzi there often occur heavy falls of snow as late as June; while 40 m. to the south the olive, fig tree, and orange thrive luxuriantly. In Calabria the

shores are lined with groves of orange and citron trees, the gardens are filled with the date palm, the fields are divided by hedges of aloes and pomegranate, and in the fields the sugar cane and cotton plant are cultivated. The forests of evergreen oak and arbutus which form a feature of the landscape have an undergrowth of oleander and cistus. On the uplands a short distance from the coast the forests are of oak and chestnut, and higher up still, in the table lands of Pollino and the Sila, the country is covered with firs and pines, which afford grateful shade and rich pasture in midsummer to the large herds of cattle. On the shores of the Adriatic, exposed to the N. E. winds, is found a vegetation entirely different. Italy is above all an agricultural country. It produces all kinds of cereals, but wheat is used principally as a breadstuff by the wealthy, and maize by the poor. The latter also consume great quantities of pulse and chestnuts. The potato is beginning to be extensively cultivated in upper Italy. Vegetables of all sorts are raised in great abundance. The most luscious fruits ripen spontaneously, such as oranges, lemons, citrons, figs, almonds, carob beans, and dates. The sugar cane, though extensively cultivated in lower Italy and Sicily, is inferior in quality to that of the West Indies. The cotton plant has been raised successfully in Calabria and Sicily since 1862. The culture of tobacco has always been limited, and its manufacture and sale are now a monopoly of the government. Hemp and flax are grown for home consumption. Saffron, safflower, and capers are exported. Silk is the most important product, and its value is yearly increasing with the foreign trade of Italy. The olive is indigenous to almost every part of the peninsula, and its culture, like that of silk, is constantly increasing in importance. The attention of Italian economists and agriculturists has been lately turned to the improved cultivation of the grape, and large quantities of wine are exported from every part of the kingdom. The wines of lower Italy and Sicily equal in body and flavor the best wines of Spain and Portugal; but those of upper and central Italy, from want of careful preparation, are not in such general demand. The Italian government is endeavoring to introduce improved methods of agriculture. About 85 per cent. of the area is productive, and 13 per cent. unproductive soil. The former may again be divided into 48 per cent. of arable and wine land, 25 per cent. of meadows and pastures, 5 per cent. of olive and chestnut forests, and 22 per cent. of woodland. The average annual yield of the principal agricultural products is estimated as follows:

Wheat.....	105,650,000 bushels.
Indian corn.....	48,000,000 "
Barley and oats.....	22,150,000 "
Rye.....	7,950,000 "
Rice.....	4,500,000 "
Other grain.....	18,450,000 "
Total grain.....	<u>207,700,000</u> "

Potatoes.....	27,250,000 bushels.
Hemp.....	111,100,000 pounds.
Flax.....	80,100,000 "
Cotton.....	22,000,000 "
Tobacco.....	7,200,000 "
Olive oil.....	42,250,000 gallons.
Wine.....	500,000,000 "

—The animal kingdom is not represented by many species in Italy. The domestic animals common to all Europe, including horses, cattle, sheep, swine, goats, asses, and mules, are raised. Animal food being not as extensively used as in more northern countries, but little attention is paid to the improvement of breeds. Swine are principally raised in Parma and the N. E. provinces of the late Papal States, where the manufacture of sausages is carried on upon a large scale. The dairy products of Parma, especially cheese, are largely exported to foreign countries. The number of horses, mules, and asses in 1872 was reported to be 1,500,000; of cattle, 3,700,000; of buffaloes, 40,000; of sheep, 8,800,000; of goats, 2,200,000; of swine, 3,900,000. The coast fishery employs a great amount of tonnage and capital. Tunny and anchovies are caught in immense numbers, and the latter are exported to all parts of the world. Oysters are obtained from beds in the Adriatic, but are poor in quality. The sea furnishes also a great variety of smaller shell fish, which are used as food by the lower classes, or as delicacies by the wealthy.—The increase of the population of Italy since 1861, when a census was taken in the countries at that time forming part of the kingdom, has been about 0.72 per cent. annually. Of the 3,382 communes into which the kingdom is divided, 1 (Naples) had in 1872 a population of more than 400,000, 4 (Rome, Palermo, Turin, and Milan) above 200,000, 5 above 100,000, 12 above 50,000, 25 above 30,000, and 22 above 25,000. The Italians now constitute a compact nationality, although they are descended from a number of different races who have successively obtained the mastery of the country. The Gallic (Celtic) and Roman elements have become the principal ingredients of Italian nationality, but few traces of the character of the aboriginal population being now discernible. In upper Italy the Germanic element has contributed its share; even the name of Lombardy is derived from that of a German tribe. In southern Italy and Sicily the Arab element enters into the mixture of national characteristics. In 1872 the population of other than Italian nationalities was estimated at about 330,000. Of these, 140,000 were French (chiefly in the circles of Aosta, Pinerolo, and Susa, in the province of Turin), 58,000 Albanians (in south Italy), 35,000 Jews, 30,000 Slovans (in the province of Udine), 25,000 Germans (chiefly in a few mountain valleys of the provinces of Novara and Turin, and in the provinces of Vicenza and Verona), 21,000 Greeks, and 7,000 Catalonians (in the town of Alghero and its vicinity in Sardinia). Only the written language is the same in all parts of Italy, while

the vernacular of the common people consists of various dialects, almost as unlike each as different tongues. It is in Tuscany that the Italian language is spoken in its utmost purity and delicacy, the Roman pronunciation and accent are most admired; hence to speak Italian with perfect grace one must use the *lingua Toscana e la bocca Romana*. The Venetian has generally a fine exterior. He is slender, slim than stout, but strong and active, with a dark complexion, an expressive countenance, sparkling eyes, black hair, and a gray beard, which combine to render the native of Italy prepossessing. A great proportion of the Italians retain many of the characteristics of the Roman conquerors of the world. The decline of the Italian military greatness was followed by eminence in letters. Italy was long the foremost nation of Europe in literature and science, and she has given birth to some of the greatest men of modern times. There are numerous high schools, academies, lyceums, and universities, and the last century, during the middle ages a world-wide reputation, though they are now eclipsed by some of the German seats of learning. The number of universities in 1873 was 22, of which 17 were royal, 4 (Ferrara, Perugia, Camerino, and Urbino) provincial, 1 (the Sapienza in Rome) papal. The 17 royal universities had in 1873 the following number of professors and students:

UNIVERSITIES.	Professors.	Students.	UNIVERSITIES.	Professors.
Bologna.....	54	577	Catania.....	9
Naples.....	73	...	Genoa.....	46
Padua.....	65	1,121	Macerata.....	20
Palermo.....	56	306	Messina.....	36
Pavia.....	45	718	Modena.....	43
Pisa.....	66	508	Parma.....	47
Rome.....	51	684	Sassari.....	31
Turin.....	69	1,408	Siena.....	33
Cagliari.....	30	88		
			Total....	736

The theological faculty has been abolished in all these universities. Bologna, Catania, Ferrara, Genoa, Messina, Naples, Padua, Palermo, Pisa, Rome, and Turin have four faculties each; Cagliari, Modena, and Parma three; the others two. The institutions of secondary instruction in 1870 comprised 353 gymnasiums (104 royal) and 272 technical schools, and more advanced pupils 142 lyceums and 6 industrial and technical special schools. Elementary education is to be compulsory, and the attendance at the primary schools is far from being satisfactory. In 1873 there were 34,213 public and 9,167 private elementary schools, together 43,380; the number of pupils was 1,745,467. Immense literary treasures are stored in public libraries. The principal of these are the Vatican and the Medicean at Rome; the Borbonica and Brancacciana at Naples; the university library at Bologna; the Ambrosian at Milan; the library of St. Mark at Venice; the royal library

rin; and the libraries at Florence, Brescia, Parma, and Parma. Literary and scientific ties have been numerous in Italy ever since the 14th century, but only a few of them retained their vitality. Among them the *Accademia della Crusca* at Florence, the royal academy at Milan, and the academy of sciences at Turin, are the most prominent. Museums, cabinets of art, and picture galleries are found almost everywhere, rendering Italy the Mecca of artists. Observatories exist in Pisa, Bologna, Padua, Milan, Florence, Naples, and Palermo. The number of charitable institutions of various kinds is enormous. The Roman Catholic religion is recognized as the religion of the state, but all others are tolerated. The civil and political rights of the citizens are independent of their profession of religion. The Roman Catholic church has 7 archbishops, 217 bishops, and 8 abbots with quasi-episcopal jurisdiction. The pope, though no longer recognized as a sovereign, continues to enjoy extensive prerogatives, which are regulated by the law of May 18, 1870. His person is sacred and inviolable; the government renders to him the honors of a sovereign, and guarantees to him a yearly pension of 3,225,000 lire (\$622,500). The number of Catholic priests is about 100,000. Convents and monasteries of Italy were suppressed in 1866, and in 1873 this law was extended to the city and province of Rome.—The industry and commerce of Italy have greatly declined since the middle ages, when the republics of upper Italy were the commercial centres of the continent, and held the position which during the 17th century was held by the Netherlands, and which since the 18th century has been held by Great Britain. Since the establishment of the kingdom of Italy a new impulse has been given to the development of industry in Tuscany and in the northern provinces. About 18 per cent of the total population derive their support from industrial pursuits. The number of chambers of commerce and industry in 1873 was 71. In point of ship building Italy occupies a prominent place among the maritime states of Europe; it is most extensively developed in Liguria. Musical instruments are manufactured in all the large cities. The silk manufactures of Italy are the most important in Europe, and are one of the great sources of national wealth; the number of spindles employed in silk spinning is about 3,000,000. Of other manufactures, those of earthenware, paper goods, glass, artificial flowers, and macaroni and other fine pastes, are of special importance. The principal articles of export are: from Piedmont, oil, oranges, wine, corals, silk, fish, wood, hides; from Tuscany, oil, fish, straw goods, marble, salt meat; from Naples and Sicily, oil, sulphur, sumach, almonds, wine, grain, licorice, alcohol, wool, skins, silk; from Parma, silk, cattle, grain, cheese, wine; from Modena, wine, silk, fruit, marble,

oil; from the former Papal States, grain, wool, oil, beeswax, silk, cattle. The total value of the commercial movement of Italy from 1869 to 1873 was as follows:

	1869.	1870.	1871.	1872.
Imports	\$180,000,000	\$171,000,000	\$184,000,000	\$232,000,000
Exports	158,000,000	144,000,000	202,000,000	225,000,000

The value of the Italian transit trade amounted in 1870 to \$1,780,000. The shipping of Italy, owing to its favorable situation, is of great importance. The number of merchant vessels belonging to the kingdom in 1873 was 19,600 (118 steamers), and there were also about 12,800 fishing boats. The seafaring population in 1870 included 180,800 adult males. The number of entries in the Italian ports in 1870 was 90,001 loaded vessels, tonnage 8,347,506, and 28,723 vessels in ballast, tonnage 1,863,346; of these, 78,868 loaded vessels, tonnage 4,939,948, and 25,941 vessels in ballast, tonnage 988,317, belonged to the coast navigation. The aggregate length of railroads in operation in 1873 was 4,148 m.; aggregate length of telegraph lines, 12,009 m.; aggregate length of wires, 87,218 m. The number of large moneyed institutions is considerable, the most important of which is the national bank of the kingdom of Italy, at Rome, founded in 1849, a bank of issue, with a capital of \$40,000,000, having establishments in Florence, Genoa, Milan, Naples, Palermo, Rome, Turin, and Venice.—The constitution of Italy is based on the fundamental statute of Sardinia of March 4, 1848. The kingdom is a representative monarchy, hereditary in the male line of the royal house of Savoy. The king attains his majority when 18 years old, and must belong to the Roman Catholic church. On entering upon the government he must in the presence of both chambers take an oath to support the constitution. He exercises the legislative power conjointly with a national parliament consisting of a senate and a chamber of deputies. The senate is composed of the princes of the royal family who are of age, and an unlimited number of members appointed by the king for life. The senators must be 40 years of age or over, and belong to certain classes of citizens, as archbishops, bishops, deputies, ministers, other high officers of the state, generals, admirals, members of the provincial councils or of the Turin academy of science, persons who have distinguished themselves in behalf of the country, or who for three successive years have paid 3,000 lire of direct taxes. In 1873 the senate had 817 members. The members of the chamber of deputies are elected by a majority of all citizens who are 25 years of age and pay a certain amount of taxes (in most provinces 40 lire) or of rent. Some classes of the population, as members of the academies, of the chambers of commerce and industry, professors, state officers, physicians, lawyers, &c., have the right of voting in virtue of their educational

qualification, without regard to their property. The kingdom is divided into 508 electoral colleges, each of which elects a deputy for the term of five years. No election is valid unless at least one third of the inscribed voters appear at the polls. The average number of inhabitants for every electoral college was 52,955. The aggregate number of electors enrolled on the roll list of 1870 was 528,932, being 1.97 per cent. of the total population. The number who took part in the election was 238,448, or 45.8 per cent. of those enrolled. All voters 30 years old or over are eligible as deputies. The chambers are convoked annually, and their sittings are public. All citizens are equal before the law, and have equal rights and duties. The constitution of the provinces and communes is based upon the law of March 20, 1865. For local administration, each province has a provincial council elected by the communes for a term of five years, and a provincial deputation which is convoked by the provincial councils. The affairs of a commune are administered by a communal council elected for five years, and by a municipal *giunta* elected by the municipal council. The chief of the communal administration is the *sindaco*, who is appointed by the king for a term of three years from among the members of the communal council. The ministry, which is responsible to the chambers, consists of nine sections: foreign affairs, interior, justice and public worship, finances, war, navy, public instruction, public works, and agriculture and commerce. At the head of each of the provinces is a prefect, who is assisted by a prefectural council. At the head of each circle, except the one in which the prefect resides, there is a sub-prefect (or district commissioner in the divisions exceptionally termed districts); the prefect attends to the duties of the sub-prefect in his own circle. For the administration of justice there are 4 courts of cassation (in Turin, Florence, Naples, and Palermo), 24 courts of appeal, 97 courts of assize, 162 civil and correctional tribunals, and 1,903 pretorships.—By the new law on the reorganization of the army which was presented to the chambers on Dec. 20, 1872, the liability to military service is made universal, the exceptions formerly allowed being reduced to an insignificant number. The annual contingent is to be 100,000 men, of whom from 75,000 to 80,000 are to be taken for the first class, whose term of service is three years (for the cavalry five years); the remainder enter the second class, to which the former belong after the expiration of their active service. The time of service in the second class is 19 years; in the second and first classes together, 22 years. The actual strength of the army in March, 1873, was as follows: standing army, on the peace footing (men actually under arms), 183,205; men on unlimited furlough, 358,370; total on war footing, 541,575; to which must be added provincial troops 202,081, making the total armed forces in time of war 743,656.

The national guard (corresponding to the man landsturm), which was first organized in 1848, may be called upon for the defence of the monarchy, and for the preservation of order at home. To it all citizens from their 21st to their 55th year, except who are in the army. The standing army is divided into six *corps d'armée*, each consisting of three divisions and each division into two brigades, four or six battalions of *glieri* or riflemen, two regiments of artillery and from six to nine companies of artillerists. The provincial militia is divided into divisions and companies, and when fully organized is to comprise 960 companies of infantry of riflemen, and 10 of sappers. The national guard consists exclusively of infantry divided into battalions, of which there were 343 organized in 1873. The navy in 1872 consisted of 59 steamers, 22 of which were ironclads, 17 transports; total, 76 vessels, carrying 11,200 sailors and 1,271 officers, including 1 admiral, 5 vice admirals, 11 admirals, and 102 captains.—The finances of the kingdom have from its first year been in an unsatisfactory condition. In every year the expenditures have considerably exceeded the revenue, as this table of budgets shows:

	Revenue.	Expenditure.	Deficit.
1861.....	\$94,700,000	\$153,000,000	\$58,300,000
1862.....	102,400,000	162,100,000	59,700,000
1863.....	117,700,000	187,400,000	69,700,000
1864.....	124,700,000	174,100,000	49,400,000
1865.....	122,100,000	168,400,000	46,300,000
1866.....	128,200,000	175,500,000	47,300,000
1867.....	153,000,000	194,900,000	41,900,000
1868.....	152,700,000	198,700,000	46,000,000
1869.....	155,400,000	191,100,000	35,700,000
1870.....	183,500,000	214,600,000	31,100,000
1871.....	220,400,000	248,700,000	28,300,000
1872.....	250,800,000	288,500,000	37,700,000
1873.....	252,000,000	297,000,000	45,000,000

The alarming deficits were but slightly covered by augmented revenue; the larger portions of them had to be met partly by loans and partly by the sale of state property and monopoly. Thus in 1867 the sum of \$116,000,000 was levied on church property; in 1868 the monopoly on tobacco was made over to a foreign company in consideration of a loan of \$700,000; and in 1864 the state railways were sold for \$38,600,000. As a result of these operations a very heavy public debt has accumulated, amounting at the end of 1873 to a nominal capital of \$1,741,900,000. The charges on account of the public debt, consisting of interest, management, and sinking fund, were estimated at \$146,000,000, an amount representing more than one half of the ordinary revenue of the kingdom.—The history of Italy is closely connected with that of the Roman state. Among the earliest inhabitants of the country we find the Etruscans, the Umbrians, the Oscans, the Sicels, the Volsci, the Æqui, the Sabines, the Peligni, the Marsi, the

ini, Hernici, Enotrians, Daunians or Japygians, Peucetians, Messapians, and various other tribes, besides various colonies in the southern part or Magna Græcia. The name Italy, however, which is the Greek appellation of Hesperia or Magna Græcia, was originally applied only to the peninsula stretching southward from the gulf of that name, and gradually extended to more northern parts, until the time of Augustus, when it received its full meaning, embracing the provinces of Liguria, Cisalpine, Venetia, and Istria, in the north; Umbria, Picenum, Samnium, and Campania, in the centre or Italy; and Apulia, Calabria, Lucania, and Bruttium, in the south or Magna Græcia. The whole country was also called Enotria, Italia, Tyrrhenia, and Japygia, by various names of the whole, and Saturnia, because of the worship of Saturn, as is said to have once reigned there. Augustus divided Italy into 11 regions, the division prevailed during the latter part of the history of the Roman empire. The downfall of the western division of the Italian peninsula has been the subject of a political history which in its general character resembles that of Germany, being marked by shifting of boundaries and contesting interests, relieved by temporary successes and failures, and by the brilliant development of literature, commerce, and the fine arts. The emperor Augustus (A. D. 476), having deposed the last West Roman emperor, Romulus Augustulus (A. D. 476), he took the title of king of Italy; but in 493 he was overthrown by Theodoric the Great, king of the Goths, and for a time the entire peninsula was united under Gothic dominion. Justinian, emperor of the East, sent the general Belisarius and Narses to reconquer it for the emperor Justinian about the middle of the 6th century, and it was ruled by a series of viceroys (exarchs). In 568 the Lombards (Longobards) invaded Italy and established a powerful kingdom, the name of which has been preserved to this day for a large portion of its territory. They introduced feudal institutions, and thus completed the transition of Italy from the ancient Roman political and social life to those of the Middle Ages. Venice, founded by fugitives from the barbarian invasions of the 5th century, and the exarchate of Ravenna, reduced to a shadowy remnant of the late Papal States; Rome, the seat of the pope, and the cities of the coast districts of lower Italy, such as Amalfi and Gaëta, maintained their independence after having for some time been in a nominal relation of vassalage to the empire. During the latter half of the 8th century, the Lombards threatening the empire, Pepin, king of the Franks, came to the aid of the pope, having been invited by the pope. Pepin, having conquered the exarchate, ceded it to the head of the papacy. Charlemagne, following up the policy of his father, subjected the Lombard

kingdom (774) and annexed it to the Frankish empire. On Christmas day, 800, Charlemagne was crowned by Pope Leo III. Roman emperor, and thus the occidental empire was re-established. Practically that title, which was eagerly coveted for many centuries by the rulers of Germany, was a pretext for territorial conquests in Italy. When in 843 the empire of Charlemagne was divided among his grandsons, the Italian provinces fell to the share of Lothaire, but the rule of the Carolingians lasted scarcely for a generation. During a period of anarchy and civil war Guy of Spoleto, Berenger of Friuli, Hugh of Provence, Berenger of Ivrea, and Lothaire, son of Hugh, successively obtained an uncertain mastership. Lothaire having been poisoned in 950 by Berenger, his widow Adelaide appealed to Otho I., king of Germany, who married her, conquered Lombardy (951), and in another campaign obtained the imperial crown. In lower Italy, the duchy of Benevento and the republics of Naples, Gaëta, and Amalfi, though undisturbed by the strifes in the northern and central divisions of the peninsula, had for a long time to contend against the Saracens, who had conquered Sicily in 827, and invaded lower Italy during the latter half of the century. Their attacks having at last been definitely repulsed, lower Italy once more returned under Byzantine rule, and remained so for nearly a century more, while the greater portion of the peninsula was held in subjection by Germany. For 60 years the German dominion was comparatively undisturbed. From the year 1000 the hatred of the Italians against the foreign rulers, diligently fostered by the clergy, manifested itself in frequent local insurrections and civil wars; but during the 11th century the German kings succeeded in maintaining their authority. In lower Italy the Byzantine rule was gradually overturned by the Normans, who, having conquered Apulia and Calabria, also wrested the islands of Sicily and Malta from the Arabs. This new realm, consolidated by Robert Guiscard (1057-'85) and the two Rogers (1085-1154), became a strong point of support for the popes in their contests with the German sovereigns. Their power increased so rapidly that Henry IV., the successor of the mightiest of all the German rulers over Italy (Henry III.), was compelled to humble himself before Gregory VII. (1077). The Lombard kingdom thenceforward gradually resolved itself into several prosperous municipalities, some of which became powerful commonwealths, able to contend successfully even against the mighty Swabian (Hohenstaufen) dynasty of Germany. Milan, Venice, Pisa, and Genoa became the centres of the movement for national independence. Milan formed the league of the Lombard municipalities, which, allied with the popes, opposed the exertions of the Hohenstaufen to erect Italy into a hereditary kingdom for their own dynasty. The national party subsequent-

ly assumed the name of Guelphs (from the Bavarian dynasty of the Welfs, the most powerful opponents of the imperial rule in Germany), while the partisans of the emperors were known under the name of Ghibellines (a corrupt form of Waiblingen, one of the seats of the Swabian or Hohenstaufen dynasty). A long continued struggle ended in the victory of the Guelphs, the emperor Frederick I. being compelled to recognize the autonomy of the cities belonging to the league. As an offset to these reverses he obtained the kingdom of the Two Sicilies by the marriage of his son with the daughter of the last Norman king. When, by internal dissensions and bloody civil wars, the power of the free cities in upper Italy seemed to be exhausted, Frederick II. made another effort to obtain complete mastery; but his successes were only temporary, and the German dynasty was completely overthrown in upper Italy (1254), while the kingdom of the Two Sicilies was wrested from them by Charles of Anjou. In the mean time municipal liberty in the free cities of upper and central Italy had been gradually subverted by petty dynasties, and the second half of the 13th century witnessed a long series of fierce party struggles, the designations of Guelphs and Ghibellines being kept up, the former by the popular or democratic party, the latter by the aristocratic. The aristocracy was defeated in Venice, Genoa, and in Florence, whence all noblemen were banished (1282); but soon afterward the victorious popular party was torn into hostile factions, and, though still able to frustrate the efforts of the German emperor Henry VII., who attempted to regain the dominion of Italy (1312), they succumbed in the different states to petty tyrants. Thus Pisa fell under the rule of Ugucione della Faggiola (1314), and Lucca under that of Castruccio Castracani (1316); Padua became a principality under the Carrara dynasty (1318), Alessandria, Tortona, and Cremona under the Viscontis, Mantua under the Gonzagas (1328), and Ferrara under the Estes. The Polenta family ruled in Ravenna, the Scala family in Verona, the Pepoli family in Bologna. Genoa expelled the leading families of the Guelph and Ghibelline parties, and elected its first doge, Simone Boccanegra (1339). In Rome the democratic party, led by Cola di Rienzi, was successful for a brief time (1347). Besides all the miseries engendered by these feuds and dissensions, armies of robbers, consisting of discharged soldiers, plundered the country, a terrible famine (1347) decimated the population, and a plague, the most horrible of which we have any account, mowed down two thirds of the inhabitants of the peninsula. Yet in the midst of these afflictions, science, literature, and the fine arts flourished as they had never done before, and the very plague which made Italy a vast cemetery furnished the dark background on which Boccaccio drew the light fantastical pictures of his *Decamerone*. In lower Italy, Charles of

Anjou, having lost the island of Sicily in a popular outbreak (the Sicilian vesper 30, 1282), consolidated his dynasty in the country and enjoyed comparative stability. In 1382 Queen Joanna was dethroned and assassinated. The usurper, Charles III., shared her fate in 1386, and he maintained himself for 28 years. Toward the latter half of the 14th century and the beginning of the 15th five states were predominant: the Papal States, Florence, Milan, and Naples, while the smaller states gradually declined to utter insignificance. From the latter half of the 14th century the Visconti dynasty threatened all the other ruling princes, and gradually subjected them to their rule. Having become extinct they were succeeded by the Sforza. In Florence the Medici family rose by their wealth and prudence to supreme power. In Sicily, under a strong oligarchical government, the king conquered Padua, Verona, and a portion of Dalmatia, established colonial settlements in the Grecian archipelago and on the shores of the Black sea, and remained victorious in many struggles with the Turks and Naples. Its former powerful rival Genoa, after a feud of centuries, been compelled to acknowledge the superior power of Naples. About the beginning of the 16th century became the theatre of desolating wars between the rival French and Austrian dynasties. A struggle was opened in 1494 by the invasion of Charles VIII. of France to conquer Naples, after many vicissitudes French had finally crushed by the defeat of Pavia (1525). From that time Italy enjoyed comparative stability for over 150 years, during which territorial and political relations became more consolidated. In Florence the Medici obtained hereditary power; the prince of Montferrat fell to the Gonzagas of Mantua (1536); Parma and Piacenza to the family, descendants of Pope Paul III. and Naples were secured to Spain by the emperor Charles V.; in the extreme North of Italy the ducal house of Savoy became predominant in Piedmont. Venice, whose naval and commercial supremacy had declined after the discovery of the passage around the cape of Good Hope, lost the island of Candia in 1669, but conquered the Peloponnesus, which it had formerly held. New troubles and changes were caused by the wars of France and Austria in the 17th and 18th centuries. In 1706-7 Austria conquered Milan, Mantua, and Montferrat, and ceded the last to Piedmont; by the Treaty of Utrecht (1713) she obtained Sardinia in place of Sicily, but in 1720 exchanged the former for Sicily, which had been given to France. The Farnese family having become extinct in Parma and Piacenza were given to the Austrian prince Charles in 1731, but fell to France in 1738, when Charles ascended the throne of Naples. In Tuscany the Medici family came extinct in 1737, and was suc-



is Stephen of Lorraine, husband of the Austrian empress Maria Theresa. Parma and Modena were conquered by the Spanish prince, and were conferred upon him as a hereditary duchy by the peace of Aix-la-Chapelle. Thus about the middle of the 18th century a large portion of Italy had lost its independence, being subject to the dynasties of France, Bourbon, and Savoy. The republics of Genoa and Venice were mere shadows of what they had been. The political and social life of the country became a settled apathy, seemingly hopeless decay, down to the time of the French revolution. In 1792 a French army invaded Savoy, which was annexed to France in 1796. In 1797 Bonaparte ceded Venice to Austria, and erected Mantua, a portion of Parma, and Modena into the Cisalpine republic; Genoa was formed into the Ligurian republic, and the Papal States into the Roman republic. Naples, having sided with Austria, was invaded by the French, the king Ferdinand expelled, and his kingdom formed into the Neapolitan republic (1799). During Bonaparte's campaign in Egypt the allied Austrians and Russians reconquered upper Italy, and the British, Russians, and Turks lower Italy; but a brief campaign Bonaparte restored the French supremacy (1800). By the peace of Campo Formio the duke of Parma obtained Tuscany; the designation of the kingdom of Etruria and Parma fell to France. In 1802 the Cisalpine was changed into the Italian republic, with the presidency of Bonaparte, and in 1805 the kingdom of Italy, administered by Napoleon's stepson Eugène Beauharnais. Guastalla was annexed to the new kingdom, and Modena and Lucca were given in fief to Napoleon's sister, Elisa Bacciochi. By the peace of Campo Formio, Venice, Istria, and Dalmatia were added to the Italian kingdom, the area of which comprised 35,400 sq. m., with a population of 5,657,000. In the following year Guastalla, the Ligurian republic, Parma, and Piacenza were completely annexed to France, and Naples was once more made a kingdom by Joseph Bonaparte, who was succeeded by Napoleon in 1808. In that year the Etrurian kingdom and the Papal States were added to the kingdom, but Istria and Dalmatia were separated from Italy, and united to the new Illyrian kingdom, while a portion of the Tyrol was added to Italy. The last effort of Austria to retain its former power having been frustrated by the duke Charles's successive defeats in Italy (April, 1809), the supremacy of Napoleon in Italy remained undisturbed until his power was broken by the Russian campaign in 1812, the successful rising of Germany. Murat, king of Naples, made common cause with Austria (1811, 1814), and the French army was expelled from Italy, while Napoleon fell. Murat's reign was to have been confirmed in the possession of Naples for the support lent to the emperor of his benefactor, was dethroned by a

counter-revolutionary movement, and in an attempt to reconquer his kingdom died by sentence of a court martial (1815). Under the new territorial arrangements of the congress of Vienna, the king of Sardinia was reinstated in his former possessions, to which Genoa was added; Lombardy and Venetia were given to Austria, and united into a kingdom; Modena, Mirandola, Reggio, Massa, and Carrara were transferred to the dynasty of Hapsburg-Este; in Tuscany the Hapsburg-Lorraine dynasty was restored; Parma, Piacenza, and Guastalla fell to the empress Maria Louisa, wife of Napoleon; Lucca to the Bourbon princess Maria Louisa; the Papal States and the kingdom of the Two Sicilies were restored to their former rulers; and Malta, Gozzo, and Comino remained in the hands of England. The republic of San Marino and the petty principality of Monaco had been undisturbed through all these chaotic changes.—The wishes of the advocates of national unity, independence, and constitutional liberty having been baffled by the simple restoration of the ante-revolutionary institutions, dissatisfaction and hatred of the foreign rulers engendered conspiracies and secret societies (carbonari), whose extent and power increased in the same ratio as the restrictive measures adopted against the people. In 1820 and 1821 revolutionary outbreaks occurred in Naples and Sardinia, and the rulers of these states were compelled to promise measures of reform; but the congress of Laybach ordered the suppression of these movements, and the complete subjugation of the revolutionary party by the Austrian armies was followed by a long period of reaction and vindictive persecution. The government of Tuscany was at that time comparatively liberal, and continued so until Sardinia assumed the lead of the national aspirations of Italy in 1848. In February, 1831, new popular risings took place in Parma, Modena, and the Papal States, but were again suppressed by Austrian armies. In the following year the Romagna made another effort to throw off the papal rule, in consequence of which an Austrian army crossed the frontier, while a French army, in spite of the protest of the pope, occupied Ancona, and held it till 1838. The political state of Italy remained apparently tranquil, but violent outbreaks from time to time proved the existence of strong dissatisfaction, which was fostered by secret organizations, such as the *Giovine Italia* (young Italy), and by men like Mazzini, who began his career as a political agitator as early as 1831. A new era seemed to dawn upon Italy when Pope Gregory XVI. died and was succeeded by Pius IX. (June, 1846). Pius inaugurated a series of moderately liberal reforms, and was hailed as the political saviour of his country. Tuscany and Sardinia followed the example set by the pope, and a customs union was effected between the three states (1847). Partial liberty of the press and popular representation were conceded or promised. About that time the principality of Lucca was

united with Tuscany, and the reigning family of the former, after the death of Maria Louisa, obtained the duchy of Parma, according to the stipulations of the treaty of Vienna. Sicily rose in January, 1848, against the king of Naples, and declared its independence. The king, in order to reconcile his subjects, gave them a liberal constitution, which was soon broken. In upper Italy the French revolution of February became the signal for a popular rising against the Austrian rule. Radetzky, the commander of the Austrian army, was compelled to relinquish Lombardy and fall back on Verona. The king of Sardinia, Charles Albert, took the lead in the struggle, occupied Lombardy, and seemed in a fair way to conquer Venice; but two brilliant victories of Radetzky turned the scale against the popular cause, and the Austrian rule was reestablished. Venice, however, held out; Rome (whence the pope had fled, Nov. 24) and the duchies were republicanized; and, encouraged by the reverses of the Austrians in Hungary, the king of Sardinia once more ventured to measure swords with Radetzky. But in a brief campaign (March, 1849) he was utterly routed, and the very existence of the Sardinian kingdom seemed to depend upon the good will of the Austrian general. The duchies were restored to their former rulers, and guarded by Austrian troops. Rome, after an obstinate defence under Garibaldi and others, was restored to the pope by a French army of occupation. Venice surrendered in August, 1849. While in Naples, Modena, and the Papal States severe reactionary measures followed the overthrow of the popular movement, the new king of Sardinia, Victor Emanuel, fostered liberal institutions, and the Austrian government sought to reconcile the people of Lombardy and Venetia by conferring upon them some material benefits, such as the construction of railroads, the improvement of the port of Venice, reforms in the tariff and the postal system, &c. But all these efforts proved unavailing to overcome the antipathies of the people, and on Feb. 6, 1853, an insurrection broke out at Milan which was suppressed without great effort. In 1857 an unsuccessful attempt to overthrow the king of Naples was made by a small band of republicans, led by Col. Pisacane; and about the same time a republican insurrection occurred at Genoa. The fact that Pisacane had made his attempt on board a Sardinian steamer which he had forcibly taken possession of, and which was afterward seized by the Neapolitan government, gave rise to an acrimonious correspondence between Sardinia and Naples; and in 1858 a war seemed imminent, but was averted by timely intercession. In consequence of Orsini's attempt on the life of the French emperor (Jan. 14, 1858), a special law against all "suspected individuals" was enacted in Sardinia, and this fact was considered as a significant symptom of the intimate relations existing between that kingdom and France.

Austria at that time began to suspect intentions of her neighbors, and by a liberal measures and promises endeavored to strengthen her foothold in Lombardy (1858). Simultaneously she tried to form an Italian league; but, though Modena and Parma were willing to enter into all her projects, the duchess regent of Parma, whose husband had been assassinated in 1854, and the grand duke of Tuscany declined. In August, 1858, it became known that Austria had ceded to Russia a locality suitable for a navy yard at Villafranca, and that Russia sought to purchase the principality of Montenegro and applied to the king of Naples for permission of a naval depot at Brindisi, the king became general that a triple alliance between Austria, the soul of which was the Sardinian minister Cavour, was on the point of being concluded. This opinion obtained further confirmation when Prince Napoleon sought a matrimonial alliance with the daughter of the king of Sardinia. On New Year's day, 1859, a despatch spoken by Napoleon III. to the Austrian ambassador dispelled all doubts in regard to his hostile intentions. While the preparatory war on both sides were going on, the king of Italy became assured that it was a change of foreign supremacy, but not of liberation and national organization, which the French emperor intended to accomplish. Dreading the approach of a revolution, the king of Naples set free many political prisoners. On April 21 the Austrian general Gyulai sent an ultimatum to the king of Sardinia, and crossed the Ticino in three columns, April 26-29. The duke of Parma, the duchess of Parma, and the grand duke of Tuscany, unable to make head against the popular rising, quitted their states; the king of Modena taking his political prisoner with him, and transferring them to the dungeons of the Austrian fortress of Verona. For nearly a month no open hostilities occurred, the Austrians contenting themselves with mauling the rich district of Lomellina. The left wing having been defeated near Palestro (May 20), and the enemy being on the point of outflanking their right wing at Palestro, May 31 and June 1, they recrossed the Ticino and were routed in an open battle near Magenta (June 4). In consequence of this defeat was the relinquishment of the Austrians of Milan and the eastern portion of Lombardy, which in the meantime had been invaded by Garibaldi. In order to risk a defence of the lines of the Adda and Oglio rivers, they retreated to the line of the Mincio. There, in the great battle of Solferino, they were defeated (June 24), but under circumstances which made it appear doubtful whether the French would be able successfully to contend with them on the ground of their quadrilateral of fortresses. Considerable uncertainty, as well as the threatened attitude of Prussia, the French emperor's

l a truce, which was immediately by a personal interview between the rors (July 11) at Villafranca. There minaries of a peace were arranged, Lombardy, exclusive of the imporresses of Mantua and Peschiera, was Sardinia, which had to pay for this a sum of \$42,000,000. Venetia was l to Austria. The restoration of the ke of Tuscany and the duke of Mos stipulated for, the question about ing left open. A promise was held taly of the formation of an Italian tion under the honorary presidency pe. Intense discontent arose in Italy se stipulations became known. The the duchies and likewise of the Ro- re insurrection in the other provinces apal States had been quelled by the y troops, principally at Perugia, June d in their protestations against the n of their former rulers. They sol- nsferred their allegiance to the king ia, but he thought best still to refuse n proffered to him, and to substitute uoncompagni for the prince of Cari- whom the regency was subsequently The peace was signed at Zürich in ce with the original stipulations, of ca, Nov. 10. The final settlement of s of the duchies was to be effected by an congress, the meeting of which ed to take place in January, 1860. iver, was delayed or prevented by nt diplomatic developments. A few fore the time fixed upon for the meet- e congress, a pamphlet entitled "The l the Congress" was published in ich, though bearing the name of M. éronnière as author, was generally un- to have been written by the French or under his direction. Its leading doc- that the revolted Papal States should eed to return to their allegiance, and ope must be restricted as a temporal to a very small territory and to uthority. This was followed by a let- the emperor to the pope, in which r was vainly urged to sacrifice the provinces, and a promise was held n that the possession of the remain- ld be guaranteed to him by the ap- g congress. In February the French nt demanded, and on March 24 the government granted, the cession to f Savoy and Nice as an indemnity for ses incurred in the recent war against The insurrection which broke out on April 4 was destined to lead step that unity of Italy so long the dream triots. The Sardinian prime minister t first outwardly condemned the insur- and made some show of opposing the h Garibaldi and his volunteers were : to take in it. But the latter em- : Genoa on May 5 with his followers

on board a Sardinian steamer, landed at Mar- sala on the 11th, and on the 14th assumed the dictatorship of the island in the name of Victor Emanuel. On Aug. 8 the latter was there proclaimed king of Italy; on the 19th Garibaldi landed at Reggio, and on the 27th was proclaimed dictator of the Two Sicilies. Cavour now threw off the mask; Admiral Persano and his fleet cooperated with Garibaldi in the south, and the Sardinian armies, which had been wresting from the pope one after another of his provinces, received orders to proceed to Naples. The victories gained by Garibaldi at Cajazzo and on the Volturno, the flight of Francis II. to Gaëta, and the subsequent surrender of that stronghold, Feb. 13, 1861, removed the last real obstacles toward national unity. Time, it was then said, would soon restore Venice to Italy, and the shadow of sovereignty still left to the pope was felt by all to be merely a question for diplomacy to settle. On Feb. 18 the first Italian parliament assembled at Turin, and on the 26th the deputies decreed to Victor Emanuel the title of king of Italy. The decree was promulgated on March 17, and the title officially recognized by England on the 30th, by France on June 15; and the other powers, after some delay and hesitation, acknowledged the accomplished fact of Italian nationality. Cavour, dying in June, 1861, was succeeded as prime minister by Ricasoli. Garibaldi, abetted by some of the most ardent votaries of unity, feeling aggrieved by the cession to France of Nice and Savoy, by the presence in Rome of French troops, and by the keeping up in that city of the papal sovereignty, published a proclamation in August, 1862, calling on the people to resist foreign oppressors, landed in Calabria on the 24th, and was defeated and taken prisoner by the government troops on the 28th at Aspromonte. The French occupation of Rome continued to embarrass Italian statesmen, amid all the financial and social problems which demanded of them an immediate practical solution. On Sept. 15, 1864, a treaty was concluded with France stipulating for the evacuation of Rome within a specified time, and providing for the transfer of the seat of government from Turin to Florence. The announcement of this latter measure caused serious disturbances in Turin, and these were followed by another Garibaldian rising in Lombardy, which was suppressed by the government. On May 13, 1865, the king of Italy took up his residence in Florence, the minister of finance having previously demanded of parliament permission to raise a loan of \$88,000,000. Meanwhile the king and his ministers sought to enter into negotiations with the pope relating to the nomination of bishops, and a peaceful adjustment of the reciprocal claims of the holy see and the new national government; but Signor Vegezzi, who had been accredited as special envoy from Victor Emanuel to the pope, failed to bring about a conciliation. Early in 1866 negotiations were

opened with Prussia aiming at an alliance which should eventually compel Austria to give up Venetia. On April 8 a conditional treaty of alliance was concluded with Prussia, and the most active preparations were made for war. The king and Gen. Lamarmora joined the army on June 17; on the 20th war was declared; the Italian army crossed the Mincio June 23, and on the following day was defeated with great loss at Custoza; Garibaldi and his volunteers were also beaten by the Austrians at Monte Suello in Tyrol, July 3; and on the 20th the Italian fleet under Persano was defeated with great loss at Lissa in the Adriatic, by the Austrian admiral Tegetthoff. But in the mean while the war in its general aspects had been decided against Austria by the battle of Sadowa (July 3), and Francis Joseph, in order to conciliate Italy, had vainly renounced his Italian possessions. (See AUSTRIA, vol. ii., p. 150.) By the peace concluded Oct. 3, Venetia was ceded to the kingdom of Italy, and the king made his public entry into Venice Nov. 7. At this time the friendly relations existing between Italy and France were imperilled by the attack made on Rome by volunteers under Garibaldi. France had withdrawn her troops from the Roman territory, leaving temporary garrisons in Rome and Civit  Vecchia; but at the same time she encouraged the pope to raise an army for the defence of Rome, allowed a legion to be recruited on her soil for that purpose, and permitted her own soldiers to enlist in the pontifical service. To this legion were soon added bodies of volunteers from every Catholic country, even Lower Canada furnishing a contingent. The advance of Garibaldi, only apparently opposed by the cabinet under Rattazzi, was condemned by a proclamation of the new ministry under Menabrea, Oct. 27, 1867, and government troops were sent forward into the papal territory to control his movements; and on the 28th a body of French troops embarked at Civit  Vecchia, which defeated the Garibaldian forces at Mentana, Nov. 3. In the preceding month of May the financial situation had become so critical, that the king in a message to parliament gave up his own share of the civil list, and proposed the sale of church lands and the reduction of the public expenditure. A few days afterward French capitalists advanced \$86,000,000 for the proposed sale, and in August a bill was passed legalizing the sale. These and similar measures, inaugurated chiefly under the Lanza cabinet, helped to maintain the national credit; but the political situation consequent upon the presence of French troops and other foreign soldiers in Rome continued to become more and more embarrassing. There were frequent risings and disturbances throughout the country, and the general uneasiness, increased by the presence and appeals of Mazzini, at length induced the king, in September, 1870, to address a letter to the pope announcing that the occupation of Rome by Italian troops was indispensable to the public tran-

quillity. At the beginning of the Franco-German war the French emperor had withdrawn his last soldier from Italy (Aug. 21); on Sept. 12 the government troops took possession of Viterbo, and on the 20th, after a brief resistance, they entered Rome. This event was notified to the European courts by a circular of Oct. 18. In the beginning of December the Italian parliament met and declared Rome the capital of Italy. On the 26th of that month the Mont Cenis tunnel was completed, and hailed as inaugurating an era of great commercial prosperity for the peninsula. On May 13, 1871, the Italian parliament, still sitting at Florence, passed the act known as the bill of the papal guarantees, which defined the situation of the sovereign pontiff and regulated the relations of church and state. The pope was to remain in possession of the Vatican and its dependencies, known as the "Leonine City," and of the Lateran and Castel Gandolfo. On July 2 Victor Emanuel made his solemn entry into Rome, and took up his residence at the Quirinal. The opening of the Mont Cenis tunnel to traffic was celebrated at Turin on Sept. 17. On Nov. 27 the king opened the first Italian parliament held in Rome, and at the close of his inaugural discourse announced that the tunneling of Mont St. Gothard would be speedily undertaken. During 1872 Italy enjoyed comparative political and social tranquillity, and was only visited by a fearful eruption of Mount Vesuvius, beginning April 24, lasting a week, and causing great destruction of life and property, and by autumnal inundations in the basin of the Po, which left 80,000 persons dependent upon public charity. The debates of the parliament in May were rendered memorable by an attempt of the government to introduce a bill granting privileges to the heads of religious corporations in Rome, and by the vehement opposition offered to it by the party of the left, headed by Prince Emanuele Ruspoli. The debates were attended by popular demonstrations, rioting, and bloodshed. On Oct. 29 the Jesuits were expelled from the Roman college and the three other houses occupied by them in Rome; and on the same day the first scientific congress held in Rome met in the capitol under the presidency of Count Mamiani. (See VICTOR EMANUEL.)—The most important historical works on Italy are: Guicciardini, *Storia d'Italia* (10 vols., Pisa, 1819-'29; English translation by A. P. Goddard, 10 vols., London, 1763); Muratori, *Annali d'Italia* (18 vols., Milan, 1741-'49); Botta, *Storia d'Italia dal 1789 al 1814* (Paris, 1824), and *Storia d'Italia dal 1400 al 1814* (Paris, 1832); Gualterio, *Gli ultimi rivolgimenti italiani* (6 vols., Palermo, 1869); Lebrecht, *Geschichte von Italien* (1778-'87); Leo, *Geschichte der italienischen Staaten* (1829-'32); Renmont, *Beitrag zur italienischen Geschichte* (1853-'7); Fantin des Odoards, *Histoire d'Italie* (1802-'3); Sismondi, *Histoire des r publiques italiennes* (16 vols., Paris, 1807-'18; later eds. in 10 and 8 vols.;

bridged in English, 1 vol., London, 1882); Wrightson, "History of Italy from the French Revolution to 1850" (London, 1855); Arrivabene, "Italy under King Victor Emanuel" (2 vols., London, 1862). The principal travellers a Italy who have given accounts of their tours are Montaigne, Evelyn, Gray, Smollett, Dr. Moore, Goethe, Joseph Forsyth, Mme. de Staël ("Corinne"), J. O. Eustace, Henry Matthews, Lady Morgan, Miss Eaton, W. S. Rose, Hans Christian Andersen ("The Improvisatore"), Mrs. Kemble, William Spalding, and George S. Lillard. See also Fulchiron, *Voyage dans l'Italie méridionale, centrale et septentrionale* (7 vols., Paris, 1847-'58); H. Alford, "Letters from Abroad" (2d ed., London, 1865); and Sabine, *Voyage en Italie* (2 vols., Paris, 1866; English translation by J. Durand, 2 vols., New York, 1869; 1 vol., 1874).

**ITALY, Language and Literature of.** The term Italian language is applied in literary history to what is at present the universal vehicle of official communication, religious instruction, pistolar correspondence, and general literature throughout Italy. But it is only in Tuscany and parts of the adjacent provinces that this is the household speech of even the educated classes. In Piedmont, Lombardy, the Venetian and Ligurian territories, in a great part of the former States of the Church, and in the Neapolitan provinces, as well as in Sicily and Sardinia, all alike employ local dialects in ordinary oral intercourse. Persons of even moderate culture are, indeed, able everywhere to use Tuscan freely, though always with local peculiarities of pronunciation and expression; but the vernacular is the habitual medium of thought, and, as Biondelli emphatically states, the written productions of non-Tuscan authors are translations. The parentage and formation of this Tuscan or Italian constitute a much discussed and most interesting linguistic problem. According to Giuseppe Miceli, ancient Italy most probably had a common language of many dialects, which were divided into two main branches, the dialects of Etruria and Umbria, represented chiefly by the Iguvian, and the Sabine, Samnitan, and Oscan, which included the Marsican, Volscian, and Hernician. Greek was spoken in the south, in Magna Græcia. The Latin was the dialect used by the mixture of Pelasgian Siculi and Osci from the Abruzzi, who together formed the historical Latini on the lowlands about the Tiber. Their idiom became in time the official language of the Roman republic and empire. This supremacy of the Latin, apart from any intrinsic excellence of its own, may have contributed to the neglect and debasement of the cognate dialects. In this debasement the Latin itself must have shared during the occupation of Italy by the barbarians. Whether the local dialects recovered their old popular ascendancy while the governmental language of Rome was in disfavor with the conquerors, is a matter of con-

jecture. It is certain that the Oscan became extinct in the 1st century B. C., and that the Etruscan continued to be spoken under the republic and the empire down to the middle of the 2d century A. D., as attested by Aulus Gellius. But in Cisalpine Gaul and along the shores of the Adriatic, as far at least as Ancona, the Celtic was spoken at the epoch of the Gothic domination, and contributed, according to O. M. Toselli, more elements to the Italian than did the Latin itself. Thus many of these local dialects survived through the middle ages, were modified by the influence and literature of the church, and are more or less faithfully represented by the vernacular idioms of modern Italy. The common roots of all of them are traced to an Indo-European stem; but the formation and growth of the modern Italian has not been conclusively shown to be derived from any known parentage, as the pedigree of English is carried back to Anglo-Saxon and Norman French. Three theories have been advanced on this subject. The first asserts the Italian to have anciently coexisted with the Latin; the latter being the language of the learned, of public oratory, and of legal documents, while the former, as the *Romana rustica*, was the language of the common people and of ordinary conversation, and maintained its ground after the other had died with the aristocracy. Such is the theory of Leonardo Bruni, Cardinal Bembo, Saverio Quadrio, and others. The second maintains that the primitive dialects lived in spite of neglect and proscription, and, modified by time, concurred with the Latin to form the basis of modern Italian. This hypothesis has the authority of Muratori, Fontanini, Tiraboschi, Denina, Ginguené, and Sismondi. A third theory, which is that of Maffei, affirms that Italian is merely a corrupt Latin, without any admixture of foreign tongues. But no facts are adduced to support this theory of a gradual change of Latin into modern Italian speech. Latin died like Measo-Gothic, and, in Italy at least, left no lineal descendant, though the present speech of Rome, as it is nearest in lineage, is probably nearest also in character of all the modern Italian dialects to the vernacular language of old Rome at her best period. Medieval Latin, it is true, became corrupt, and was often mixed with words borrowed from the vulgar idioms; but it still remained essentially Latin, and as yet no well authenticated remains have been found of a transitional stage from the old classical to the modern Italo-Romance dialects. When the modern Tuscan was first used in literary composition in the 13th century, it was in idiom, grammar, and structure what it is to-day. The writers of that age used the familiar speech of their firesides; and Italian was full-grown, ripe, and perfect when the first native poet embodied his inspiration in it. If we trace it up chronologically, we find that Isidore of Seville in the 7th century mentions the *lingua Italica* as distinct from the Latin. Ciampi

finds that it was in use in the 5th century; and in 960 Gouzo attests its use among the educated classes, while Wittekind mentions its being spoken under the name of *lingua Romana* by the emperor Otho I. (936-'73). Pope Gregory V. (996-'9) delivered his instructions to the people in the same. It was spoken at the court of the emperor Frederick II. (1212-'50) as the *lingua Siciliana*, of which the oldest authentic specimen is a rude song by Ciullo d'Alcamo (about 1195). The Siennese idiom of Folcachiero is more chaste, but somewhat later in date. Thus, already in the 13th century the Italian language had attained its regular forms in the north, centre, and south of Italy. While other modern European languages, with the exception of the Icelandic, were still in their infancy, Dante (1265-1321) did most of all in developing and consolidating the native elements, legitimating the exotic accessions, and polishing the whole language. In the 14th century the language was still further perfected by Petrarch and Boccaccio. To the latter part of the 15th century and the beginning of the 16th belong the works of artists and scientific men like Leonardo da Vinci, who enriched the language with a new terminology, and those of Machiavelli, the father of Italian prose. Pietro Bembo, Giovanni Rucellai, Jacopo Sannazaro, Trissino, Ariosto, Tasso, Guarini, and others followed, raising it in refinement and melody above all other European languages. Angelo Beolco di Ruzzante, a Paduan (1502-'42), wrote six comedies, in which each person speaks his native dialect; a method analogous to the use of Prakrit in Indian dramas. Benedetto Varchi, a Florentine (1502-'65), reformed the orthography and established the grammar. Grazzini with Leonardo Salviati founded, in the *accademia della Crusca* at Florence, a tribunal of the language (1582). The influence of French on European languages during the 17th century began to be exerted on the Italian, especially on its syntax. Algarotti was the chief fosterer of this influence. But Monti and Perticari strenuously and successfully resisted this denationalization, and restored to their cherished tongue the direction imparted to it in the 14th century.—The following details relate to the *illustre favella* of Dante, unless a dialect be mentioned. The comparative harmony of intonation of the Italian and Spanish languages is a matter of individual preference. We place the Italian first with respect to music, but prefer the Spanish as to the *numerus* or euphony of speech. Only five Italian words end in consonants (three liquids), viz.: *il, in, con, non, per*. By dropping *e* and *o* after liquids only, other words are made to end in them, thus: *parlarono, or parlaron*; dropping *n*, *parlaro*; also *parlar*, which is also the infinitive (from *parlare*) or the negative imperative. Too many words end in *i* (plural from *e, o*, and from *a* masculine, and second person singular of verbs); for instance: *Sapete, amici miei, che tutti i celebri poeti italiani*

*sieno stati colmi di allori ed onori, nei secoli passati*. The sound of *h* exists only in the *lingua toscana*. The Spanish has only one rough sibilant, *ch* (as in our *church*), whereas the Italian has this, written *ce, ci*, as well as the sound of our *sh* (in *ship*), written *ce, ci*; moreover, *ge, gi* (as in English *gem*), the double consonants *ts* and *dz* (both written *z*), of which the former supplants the melting sound of the Latin *tia, tie, tio*, as in *tristezza, pazienza, razione* (for *tristitia, patientia, ratio*), &c. *Oppi, fuggire, uccidere*, and the like, exaggerate the harshness by a preceding sound of *d* and *t*. The ratio of initial and medial consonants to the vowels is as two to one in Latin, while they are about equal in number in Italian. Besides the above mentioned sounds, there are *b, d, f, l, m, n, p, q, r*, as in English; *c* like *k* in the same positions as in English, and *g* hard (written *ch, gh*, before *e, i*); *j* medial sound, like our *y* in *yes*, but as final it is a long *i*; *r* always rolling; *t* always hard (in old writings also like *z*); *s* as in English *sun, rose*, never as in *vision, mission*, the *i* retaining its distinct sound, as in *ri-si-o-ne*. The letters *k, x, z*, and *y* are not used, and *ph, th* are represented by *f, t*, as in *filosofia, teatro*. *H* only occurs in *ho, hai, ha, hanno* (Latin *habeo, habes, habet, habent*, which Metastasio wrote *ò, di, d, àno*), and combined in *ch, gh*. The *l* and *n mouillés* of the French are written with *gli* and *gn*. The vowels sound as in the words *futher, pat; fête, pet; marine, pin; note, not; too, put*. The Italian accent is strongly marked, and affects one of the four last syllables of words; hence its adaptability to pentameter and hexameter verse, and its singularly musical prosody. Rhyme is only accessory. The mark (') is only used for the sake of instruction; the sign of the grave accent is written on the finals of abbreviated words, such as *città, mercè, di, virtù, cù* (for *cittade, mercede, die, virtude, Lat. quod*), &c.—In richness of augmentatives and diminutives, both of endearment and aversion, the Spanish is equal and the Karaitic (in Greenland) superior to the Italian. The definite article is more multiform than in the cognate languages. This is due to its contraction with prepositions and also with *non*, thus: *del, dalla, al, nella, coi, pel, frai, sugli, nol, &c.* There are two forms of the masculine: *il, lo*, plural *i, gli*. The auxiliary verbs are due to the influence of the Teutonic tongues, though faint traces of a similar use of *esse* and *habere* may be found in ancient low Latin. Conciseness of expression is obtained by the following means: *a*, by using the infinitive of a verb as a substantive, thus: *il parlar tezzoso*, genteel speech; *b*, by joining pronouns, when regimens, to the imperative, infinitive, or gerund, thus: *datemelo*, give it to me; *il pensarne mi consola*, the very thought of it consoles me; *raccontandoglielo*, in telling it to him, &c.; *c*, by dropping the final *e* or *o* after liquids, mostly before words commencing with consonants (see above); *d*, by dropping final vowels or syllables before both consonants

vowels, with or without the sign of the strophe, even of initial vowels, as in the wing from Dante:

Quando l' udi' nomar se stesso il padre (mio),

Lo vo' con voi dalla mia donna dire

*io udi, voglio*). The construction is direct, inversion frequent, and the whole phraseology freer, bolder, and more variable than in Latin. On the other hand, some terminations are fatiguingly long, unless the writer be master of his style, and ornaments of speech often profuse. The poetic idiom differs more from the prosaic than in any other living language of Europe, not only on account of great changes in the alteration, addition, and omission of sounds, but also by a multitude of exclusive poetic words.—The area of the Italian language comprehends the whole peninsula and islands of Sicily, Sardinia, Corsica, &c.; the whole canton of Ticino, and parts of the Grisons, Valais; south Tyrol, some cities of Istria and Dalmatia, and partly the Ionian islands. The idiom of Mediterranean navigators, a jargon known as the *lingua franca*, are often in the Levant. Many of the dialects differ as much from the cultivated Italian as Spanish, and some even more. This is owing to the ancient local varieties of *Romana rustica* and of others, as well as the tongues of foreign invaders. While the words have many significations, as for instance *cassa*, which has 25 in Milanese, other objects have very many names devoid of any of any kind, as for instance turkey (*cagris gallopavo*), which has about 20 provincial names. Dante (*De Vulgaribus*) speaks of 14 dialects, one class on the west, the other on the east of the Apennines. The dialects on the north approach the Provençal language. K. L. Fernow (*Römische Studien*, Leipzig, 1808) distinguishes in the Toscana dialect, though considered as the most homogeneous, 8 sub-dialects. Dante's classification has been somewhat modified. In the "North American Review" for October, 1832, 17 principal dialects are noticed. All the varieties amount to nearly 1,000. There are many speaking communities in the north of Italy, viz., the *sette* and the *tredecim comuni*; the speaking villages in Calabria; and Albanian (Skipetar) settlements in both Sicilies. The Toscano had the principal part in forming the *volgare nobile*, all great writers of the 13th and 14th centuries having been Tuscans. Giavelli's *Discorso* asserts that the idiom of Dante, Boccaccio, and Petrarch, or *la lingua d'antina*, is the genuine Italian. Other Italian rebels against this autoeracy; and the dialects of *la Crusca* have often been unrecognized. The Florentine and Siennese emasculation of utterance of the *c*, *ch*, *g*, and *gh*, is especially unpleasant to an unspoiled ear; but is in part compensated by a great regularity and uniformity in the pronunciation of the

vowels, for which there are fixed and acknowledged standards in Tuscany, while elsewhere there seem to exist no authoritative rules for vowel sounds. In the suburbs of Rome there are at least three *patois*. In Tuscany the sub-dialects of Siena, Pisa, Arezzo, Leghorn, Lucca, Fucecchio, and Volterra are worthy of mention. The Bolognese drops many medial and final vowels, as for instance: *Açeti vâ st' nostr mond; o prest o tard al bôd murir* (for *Così va questo nostro mondo, al bisogno, &c.*). Those of Norcia and Spoleto, on the contrary, have lost many consonants. The Perugin, Loretan, and Camerinese are among the most noticeable in the old papal legations. The Venetian softens consonants effeminately, thus: *Lasciate dar un baso a boccolotto* (for *Lasciate dar un bacio, &c.*). The Paduan, a transition from this to the Lombard, is one of the least intelligible. The high Lombardic and the Tanzi Milanese drop final vowels, and often medials; they share with the Piedmontese and Genoese in the use of the French vowels *eu, u*, the nasals *an, in, on*, and also of French *j*. These, however, are wanting in the low Lombardic, the Mantuan, and Cremonese. The Bergamasch is the rudest of all, from contractions, thus: *Za Giove l'hiva fatt el grand decret; Da collocat o gatt la su in di stali, insom col cà* (for *Già Giove aveva fatto il gran decreto; Di collocar il gatto fra le stelle, insieme col cane*). The Piedmontese also contracts much, and has many almost French sounds, thus: *bagne, mangé (besoin, manger), &c.* The Genoese approaches the Provençal, but has some rough sounds; it often uses *r* for *l*. The Neapolitan transposes many sounds, and rejects many syllables, but is very rich in literature. There are several forms of *patois* in the city of Naples. The dialects of the Abruzzi, Apulia, Calabria, &c., are very rude. The Sicilian is very mild and graceful, has many Arabic words (from the 9th century), and vestiges of Greek, Punic, Norman, French, and Spanish domination. In the Sardinian dialects there occur many Greek, Latin, French, and Catalan words intact, and many roots without known filiation. (See *Nou dictionariu universali sardu-italianu, compilau de su sacerdotu benefisau Vissentu Porru, &c., Casteggio, 1832.*) The Corsican is more akin to the Tuscan than to the idioms of the isles of the gulf of Genoa. In the Friulic there are many Slavic and old French words. This and the Tyrolese most differ from the *favella illustre*. The study of the Italian dialects is now receiving much attention, and the recent labors of Ascoli and Caix, as well as various contributions of Mussafia, and the earlier essays of Biondelli and others, deserve special notice. The linguistic interest of these dialects is great; but though several of them have been reduced to writing, and many lyrical, satirical, humorous, and dramatic compositions of merit have been published in them, yet in no case are these productions sufficiently numerous and comprehensive to constitute a body of litera-

ture; they are rather dilettantisms than serious efforts.—Italian, though practically wordy, is not necessarily periphrastic and diffuse. Davanzati boasts that his translation of Tacitus is more concise than the original. Nor is it by any means so deficient in the power of self-development as is generally supposed. Giuliani has shown that the unlettered Tuscan peasants are very happy in the enrichment of their speech; the use of the privative *s* is extending, and it is often employed with new and striking effect; and new words are not merely introduced from abroad, but freshly formed from Latin or provincial roots. The involution of periods is by no means an inherent defect in the language. Villari, in his life of Savonarola, employs a style of remarkable clearness, logical exactness, and directness, which, if not Tuscan, is, at least according to general principles of criticism, something better than Tuscan; and the *Spagna* of De Amicis is a specimen of light, lively, fluent, and correct composition, of which the literature of our day cannot boast many examples. One of the points which first strike a foreigner who seeks to become acquainted, through the native medium, with the new life which pulsates in united Italy, and especially with the physical character of the country and the material interests of the people, is the poverty of the language of common speech in descriptive terms and epithets. As he advances in a knowledge of Italian general literature, he will find the written dialect almost equally inadequate to express sensations, images, and thoughts which every hour brings to the lips of an American. For the absence of a descriptive and picturesque nomenclature in conversational language, and in poetry and other imaginative compositions, there are several reasons. First, the culture of Italy is to a great extent fashioned after classic models, and of course its tongue partakes of the poverty of the Latin in the material vocabulary; in the next place, the Italian literature known to foreigners belongs chiefly to a period anterior to the development of the sense of landscape beauty and the love of nature in modern life; and finally, in England and America, and in a less degree in northern continental Europe, the diffusion and importance of physical science, of foreign commerce, and of agricultural and mechanical art, have made the vocabularies of all industries a part of the common speech of all classes, and have consequently entered far more largely into the diction of social life, of poetry, and of all belles-lettres literature, than they have done in Italy.—The helps to the study of the Italian language are very insufficient. Pesavento has lately published a valuable comparative view of the structure of Latin and Italian, under the title *Metodo comparativo*; but few good practical Italian grammars, and only one or two tolerable bilingual dictionaries of Italian and other modern languages, exist; and many hand-dictionaries with Italian explanations are very deficient in fullness and incorrect in definition, in the department of which we have just spoken. These defects are beginning to be felt by the Italian people. Carena's *Prontuario* and Palma's *Vocabolario dell'agricoltura* supply many a term not found in general handbooks; and a series of technical dictionaries now in preparation under the patronage of the government, of which Canevazzi's excellent *Vocabolario dell'agricoltura* is the first, will soon bring Italian lexicography, at least in the material department, to a level with that of the other European tongues.—LITERATURE. The example of the emperor Otho I. and Pope Gregory V., before mentioned, while it attested the universal prevalence in the peninsula of the Italian or *lingua comune*, contributed also not a little to its being further used and cultivated by all classes in church and state. Thenceforward it became the language of the palace and the pulpit, of deliberative assemblies and law courts, and of all commercial and legal transactions. The Provençal troubadours, who were to be found everywhere in the 12th century from Sicily to the Alps, were superseded by sweeter and better singers in the native tongue of Italy; and the romantic exploits of chivalry and the annals of the courts of love were written in the popular idiom. Thus the growth and polish of the Italian language were the work of religion and patriotism. Frederick II. made it the language of his court at Palermo (1212), of the schools he founded in that and other cities, and of the university of Naples (1224), which owed to him its existence. He, his sons Enzo and Manfred, and his secretary Pietro delle Vigne, wrote verses in it. A sonnet of Pietro's is the earliest known specimen of the kind, but several written by the Sicilian Giacompo da Lentino (about 1250) manifest a much greater perfection. Frederick's literary tastes excited emulation in the cities of central and northern Italy. Guido Guinicelli, who died in 1276 and is called by Dante "the father of me and of my betters," advanced this poetic form to still higher perfection, as is evidenced by his canzone styled "The Gentle Heart" in Dante Rossetti's "Early Italian Poets" (now entitled "Dante and his Circle"). Contemporary with or immediately succeeding him were Guido Ghislieri, Fabricio, and Onesto; Guittone d'Arezzo, in Tuscany (died 1294), whose forty letters to a friend furnish the earliest specimens of the epistolary style in Italian; other Tuscans, among them Bonagiunta da Lucca, Gallo Pisano, and Brunetto Fiorentino; the Neapolitan chronicler Matteo Spinelli, who wrote the earliest Italian prose work of importance, a history of events from 1247 to 1268; and the Florentine historian Ricordano Malespini (died 1281), the genuineness of whose works has been questioned by recent critics. Brunetto Latini (died in 1294), the teacher of Dante, author of the cyclopædic work *Il Tesoro* and the collection of didactic rhymes called the *Tesoretto*, also belongs to this time;



and finally Guido Cavalcanti (died 1300), the friend of Dante, who surpassed all his predecessors in the learning and polish of his philosophic poems, and did much in preparing the way for the great writers who followed him. These authors, of whom little but the names is now familiar to the ordinary student, brought Italian literature to the beginning of its most brilliant and most glorious period, in which Dante (1265-1321) was the great master spirit. Brought up, like all the scholars of his age, in the familiar use of mediæval Latin, his two earlier works (*De Monarchia* and *De Vulgari Eloquentia*) were written in that tongue. But he soon forsook it for the Italian, which he cherished as the main instrument of that national unity which was a dream of his life. His earliest poem, the *Vita nuova*, was written about 1294; the rest were produced in the following order: the *De Monarchia*, the *Convito*, the *De Vulgari Eloquentia*, and finally his crowning masterpiece, beside which all his previous works become insignificant, the *Divina Commedia* (probably 1300-20), comprising the *Inferno*, *Purgatorio*, and *Paradiso*. It would be impossible to exaggerate the influence of Dante upon the literature of Italy. Though he did not positively re-create the language in which he wrote, he displayed for the first time, and with a power that has not since been equalled, all its capabilities, and its fitness for the highest form of epic poetry and the expression of the noblest thought. The *Divina Commedia*, one of the greatest poetical creations of any age, had an incalculable effect on the scholarship, the taste, and the literary products not only of Dante's own time, but of all succeeding periods. It was as much the basis and foundation as the master work of Italian literature. Chairs for the exposition of the *Divina Commedia* were established in the 14th century in many Italian universities, Boccaccio being appointed to the first, that of Florence, in 1373; and from that time it has never ceased to exercise a paramount influence over Italian writers. Francesco Stabile, called Cecco d'Ascoli, a contemporary of Dante, was almost the only writer who ever endeavored to detract from the poet's fame. His satire, the *Acerba*, a witty but ill-grounded attack, had little permanence. Dante had barely completed his great work when Petrarch and Boccaccio came to share and confirm his literary supremacy, and to form with him that great triumvirate which gave to the 14th century its glory in Italian literary history. Petrarch (1304-74), distinctively the poet of love, was still more, like Dante, the poet of a united Italy. His chief celebrity consists in his being the father of Italian lyric poetry; in this he outstripped all his predecessors, and has been surpassed by no poet of his country. He sang all the passions, hopes, and memories of love, and lamented all the divisions and miseries of Italy. He, like Dante, preached to his countrymen mutual forgiveness, peace, and

union. His compositions, embracing sonnets, songs, and "triumphs," abound in favorite quotations. And yet his principal philosophical treatises, like his first poem, *Africa*, are in Latin, and afford evidence of his great learning, just philosophical thought, and perfect mastery of the language. But great as is the praise due to Petrarch for the intrinsic excellences of his writings, he deserves still more for his lofty patriotic purpose, and the great services rendered in promoting the revival of sound learning. Giovanni Boccaccio (1313-75), the third in this great literary triumvirate, was the ardent admirer and sentimental biographer of Dante, the warm friend of Petrarch, and had the good fortune of being the protégé of the accomplished and luckless queen Joanna I., granddaughter of Robert of Anjou, king of Naples. Like Frederick II., Robert had been the munificent protector of Italian art and literature, and like him cherished the Tuscan dialect, in which he left several compositions. Boccaccio's *Teseide* was written in *ottava rima*, which was known in Sicily before him, and which he perfected. This and a prose romance were his earliest compositions. Several works in Latin followed. In 1353 appeared his *Decamerone*, or "Ten Days' Entertainment," so called because each of the seven ladies and three young men introduced into it relates a story each day, thus producing 100 stories in 10 days. This work is regarded as the purest specimen of prose of which the Italian language could boast until that day; but its graces of composition too often adorn the most licentious descriptions. Boccaccio's stories must not be confounded with the *Cento novelle antiche*, "A Hundred Ancient Tales," which are partly written from the *Decamerone*, and partly from older popular stories, but all free from indelicacy, and narrated with great simplicity. Franco Sacchetti of Florence (died about 1500) emulated the style of Boccaccio, and composed in a pure and elegant diction 300 tales, of which 258 are still extant, published in the beginning of the 18th century. Another Florentine, Ser Giovanni, left the *Pecorone*, a collection of 50 similar stories. The *Storia fiorentina* of Dino Compagni, embracing the annals of Florence from 1280 to 1312, is considered by modern critics as of doubtful authenticity. Of the work of Giovanni Villani, which embodied the history of Florence from its foundation till a few years before the author's death in 1348, only that part is considered trustworthy which treats of the author's own time. This work was continued by Giovanni's brother, Matteo, down to 1363, and to 1365 by Filippo, Matteo's son, who also wrote biographies of illustrious Florentines. Of ascetic works in the Italian language, the first known example is the *Specchio della vera penitenza* of Giacomo Passavanti (died in 1357), which is comparable for purity and grace of diction with the *Decamerone*. Passavanti's was followed by similar treatises

of equal excellence, written by Domenico Cavalcanti of Pisa, Bartolommeo da San Concordio, and Agnolo Pandolfini.—Most of the men who flourished in the 14th and 15th centuries were not distinguished like Dante and Petrarch for creative genius, but delighted rather in reproducing and commenting on the authors of antiquity. The printing press, invented in Germany, was most usefully employed in Venice, Bologna, and Rome, in multiplying copies of the ancient authors, corrected by learned scholars. To the passion for discovering and publishing new manuscripts was joined that of finding and interpreting ancient monuments, medals, inscriptions, and sculptures. Only the first steps toward a new civilization had been taken by Petrarch and Boccaccio. The introduction of the mariner's needle by Flavio Gioja had opened the ocean to the Europeans; the travels of Marco Polo had awakened that curiosity concerning the way to the East Indies which led Columbus to the discovery of the new world; the Arabic numerals had been substituted in Italy for the Roman; academies were established to nurture the love of letters, and courts became an asylum for the most distinguished men; and the popes in Rome, the Medici in Florence, the houses of the Visconti and the Sforzas in Milan, and of the Gonzagas and Estes in Mantua and Ferrara, became protectors of literature and the arts. Pope Nicholas V. is especially distinguished for the encouragement which he gave to every branch of learning. It was under his liberal protection that Francesco Filelfo translated the Iliad and the Odyssey into Latin verse. His example was followed by numerous courts in Italy; hundreds of authors found employment and support; and the advantages of literature were to some degree extended among the people. Alfonso of Aragon, king of Naples, is eminent among these Mæcenas-like patrons. Montefeltro of Urbino, the house of Bentivoglio in Bologna, Filippo Maria Visconti, and Francesco Sforza vied with the Medici and the house of Este in protecting letters and giving an asylum to those exiled Greeks who brought to Italy their learning and advanced culture. Lodovico Sforza, surnamed il Moro, invited to his court in Lombardy many learned men, painters, and architects, among whom were Leonardo da Vinci and Bramante, patronized the university of Pavia, granting it many privileges, and opened schools in Milan, to which most renowned professors gave distinction. Gian Francesco Gonzaga, marquis of Mantua, invited Vittorino da Feltrè to instruct his sons, and the school which he opened was frequented by young men from Greece, Germany, and France. The example of the houses of Este and Gonzaga was imitated by the dukes of Savoy, who in the beginning of the 15th century founded the university of Turin. But the most illustrious of the patrons of letters was Cosmo de' Medici, who rose to preëminence among the noble families of Europe. He found-

ed one library in Venice (the Laurentian) and three in Florence, and established the first academy for the study and promulgation of the Platonic philosophy. Pico della Mirandola and Cristoforo Landino exercised the happiest influence in advancing and creating a popular esteem for knowledge, and especially in exciting the Florentine youth to an enthusiasm for it. The former was almost unrivalled in erudition, being profoundly versed in numerous languages, in metaphysics, and in mathematics. Lorenzo de' Medici (died in 1492) greatly and variously increased the glory which his grandfather had acquired in the culture of learning. But the taste for Latin composition again became predominant, and Italian was at this period hardly used at all in writing; it was even disdained for legal documents, and its development was arrested by a boundless reverence for antiquity. But Lorenzo the Magnificent may be considered the reviver of Italian literature, and was even called its father. Most esteemed for his virtues and manners, he enriched libraries, aided in founding a Platonic academy in Florence, reopened the university of Pisa, collected numerous remains of antiquity, promoted the study of the popular poetry, and wrote himself many admired pieces for the improvement of the public taste. His *Nencia da Barberino* is the first example of Italian rustic poetry, and his *Compagnia del Mantelaccio* seems to have given the first idea of Italian satire in *terza rima*. Under him Florence became a new Athens. Angelo Poliziano (1454-'94) enjoyed the friendship of Lorenzo, attained to great erudition, and was an elegant writer both in Italian and Latin. His most celebrated works are the *Giocosa* and the *Orfeo* (the first regular and consistent Italian drama), which were imitated even by Ariosto and Tasso. Contemporary poets of less note were Burchiello, Girolamo Benivieni, and Giusto de' Conti. To the various kinds of composition which have thus far appeared must now be added some epics. Of the brothers Bernardo, Luca, and Luigi Pulci, only the last (1481-'87) achieved lasting eminence in poetry. His *Morgante Maggiore*, burlesque and fantastic, opens the brilliant Italian series of romantic poems of chivalry. It belongs to the circle of legends concerning Charlemagne and his paladins, but degrades the primitive simple faith in them by persiflage. The *Mambriano* of Cieco da Ferrara deserves to be mentioned and compared with the *Morgante*. The best of the romantic poems of the 15th century is the *Orlando innamorato* of Boiardo, which introduced materials so beautiful and so vast as to induce Ariosto to follow in the same path. To sustain the marvels of his subject, he employed magicians and fairies in connection with the classic divinities, and beneath the veil of poetry he represented the most useful truths of philosophy. The *Orlando innamorato* was left incomplete, and the original has become rare even in Italy, on account of its rude and an-

tique diction. Its tone is much modified in the elegant version of it by Francesco Berni, which has enjoyed the most general favor. The prose literature was enriched by the writings of two artists: Leone Battista Alberti, the author of a dialogue *Della famiglia*, containing philosophical precepts for domestic life and the education of children, and of treatises on painting and architecture which gained him the name of the Italian Vitruvius; and the renowned Leonardo da Vinci (1452-1519), at once painter, sculptor, architect, mathematician, musician, the best extemporaneous poet of his time, and the author of a *Trattato della pittura*, which reveals both his scientific and artistic knowledge, and is a classical authority on the use of terms pertaining to the arts and sciences. Numerous historians also belong to this age. Pandolfo Collenuccio was the first to write an esteemed history of the kingdom of Naples, revived and corrected the taste for comedy, founded the first museum of natural history in Europe, and wrote dialogues after the manner of Lucian, and the solemn *Iano alla morte*. Historians of travels were the Genoese Giorgio Interiano and the Venetian Cadamosto, who give the oldest narratives of the Portuguese discoveries, and the Florentine Amerigo Vespucci. Aldo Manuzio (Aldus Manutius) rendered signal services to letters, and gained a European repute by the care and taste with which he published the classics. —The 16th century, the *cinquecento* of the Italians, is known as in many respects the golden age of Italian literature and art. Leo X. was on the papal throne what his father Lorenzo the Magnificent had been in Tuscany, the munificent patron of artists and men of letters; and the other sovereigns of Italy vied with the popes in this liberal patronage. But if the writers patronized by them, and breathing the atmosphere of their courts, gave evidence of improved taste and more exquisite perfection of form, they manifested also not a little of servility. The native literature of the two preceding centuries had sprung up and flourished amid free institutions, and was the expression of the popular mind and heart. Men of letters in the 16th century were for the most part the hirelings of princes, and literature became a courtly exercise. In poetry Ariosto (1474-1533) stands preëminent. The protégé of the dukes of Ferrara, he aims at describing in his romantic epic, *Orlando furioso*, the origin of the house of Este. Tasso praises him for fertility of invention and propriety of treatment. Ariosto wrote also satires on the rulers and politics of the age, and two comedies, for the performance of which a theatre was constructed by the poet's patrons. A number of other writers, carried away by his success, attempted epic compositions, among which are Alamanni's *Girone il cortese* and *Atarchide*, Valvasone's *Angeleide*, which is thought to have suggested to Milton the conception of the "Paradise Lost," Tris-

sino's (1478-1550) *Italia liberata dai Goti*, a poor imitation of Homer, Brusantini's *Angolica innamorata*, the *Guerino meschino* of Tullia d'Arragona, and the *Amadigi* of the Bergamese Bernardo Tasso. But nearest in excellence to Ariosto comes Bernardo's son, Torquato Tasso (1544-'95), who aimed at combining in his *Gerusalemme liberata* the epic grandeur of Virgil with the lighter graces of the romantic muse. His *Rinaldo* and *Aminta* are also full of poetic beauty. The success of Ariosto in comedy had awakened zeal for dramatic composition. Trissino produced *Sofonisba*, the first Italian tragedy of high merit, and Rucellai his *Rosmunda* and *Oreste*, represented at the expense of Leo X. Superior in merit to these are the tragedies *Tullia* by Martelli, *Canace* by Sperone Speroni, *Torrismondo* by Torquato Tasso, and *Edipo* by Andrea dell'Anguillara, all moulded on the Greek drama. In comedy the Italian authors of this century were the servile imitators of Plautus and Terence. In high comedy (*commedia erudita*) the best examples are the *Calandra* of Cardinal Bibbiena, the *Cassaria* and *Suppositi* of Ariosto, and the *Madrugola* and *Clizia* of Machiavelli. To the Florentines belongs the invention of the opera, *Daphne*, the first ever written, having been represented in 1597; the words were from the pen of Rinuccini, and the music from that of Peri. The melodramas of the Modenese Orazio Vecchio are considered by Muratori as the beginning of modern opera. In pastoral poetry, besides the *Aminta* of Tasso, this age boasts of Guarini's *Pastor fido* and Sannazzaro's *Arcadia*. The chief didactic poems are the *Api* of Giovanni Rucellai, the *Navigazione* of Bernardino Balbi, the *Coltivazione* of Alamanni, and the *Caccia* of Valvasone. A school of burlesque poetry arose about 1520, named *genere bernese* after Berni, whose *Orlando innamorato* unites grace, elegance, and originality. In satire the first place belongs to Ariosto, after whom may be mentioned Ercole Bentivoglio and Filippo Nerli. Luigi Alamanni, like Pietro Aretino, whose versatile talent led him to write on many subjects, is chiefly known for his indelicacy. Macaronic poetry owed its invention or its happiest improvement to Teofilo Folengo (died in 1544), known as Merlino Cocajo. Angelo di Costanzo's sonnets are models of perfection, which Michel Angelo nobly emulated, while Bembo aimed like them at popularizing the language of Dante among the learned. Annibale Caro gained great praise for his translation of Virgil and his original compositions. Bernardo Davanzati's version of Tacitus is thought to surpass the original in conciseness and energy; he also wrote a history of the reformation in England. To Vittoria Colonna (1490-1547), among the women of this century, Ariosto awarded the palm of poetical excellence. An important place in the literature is held by political writers, foremost among whom was Machiavelli (1469-1527). A dramatist and historian of Florence, he is

chiefly known as a profound and philosophical statesman by his discourses on Livy, his dialogues on the art of war, and especially by his *Principe*, a manual of government, which was constantly in the hands of such sovereigns as Charles V. and Sixtus V., and the real intent and character of which has been long in dispute. His style is marked by simplicity, strength, thought, and a rare but felicitous use of ornament. Other political writings were the *Ragione di stato* of Botero, and the *Repubblica fiorentina* of Giannotti. Nearer to Machiavelli in merit was Paruta (1540-'98), the author of *Discorsi politici*, and of a treatise *Della perfezione della vita civile*. The most renowned of Italian historians is Guicciardini (1482-1540), whose work, embracing the period from 1490 to 1534, is esteemed for impartiality, but is diffuse and tedious. Paolo Giovio wrote in Latin a partisan history of his own time. Historians of Florence were Nardi, Varchi, Nerli, Segni, Capponi, and Scipione Ammirato; the *Storie fiorentine* of the last extends from the foundation of the city to 1574. Historians of Venice were Bembo (1470-1547), Paruta, and Contarini; of Genoa, Giustiniani, Bonfadio, and Foglietta; of Ferrara, Cinzio and Falletti; and of Naples, Costanzo, Porzio (*La congiurazione dei baroni*, &c.), and Sunmonte. General histories were written by Giambullari and Adriani. The splendor of the fine arts in this century gave occasion for historians of art, the principal of whom was Vasari (1512-'74), whose lives of the most excellent painters, sculptors, and architects of Italy are written with naturalness and grace, and contain interesting notices of prominent Italian works of art. The autobiography of the Florentine goldsmith Benvenuto Cellini, one of the liveliest books in the literature, not only recounts his own fortunes, but gives curious notices of the courts of Rome, Florence, and France. He wrote also valuable treatises on jewelry and sculpture. Works on painting were written by Bernardino Campi of Cremona, Lomazzo of Milan, and Armenino of Faenza. Vignola and Palladio gained distinction as writers on architecture, and Marchi by a treatise on military architecture. Philosophy now began to assume an independence of the scholastics, and Girolamo Cardan and Giordano Bruno ventured upon the boldest speculations. Mathematics were cultivated by Tartaglia, Carlan, and others. The *Instituzione di tutta la vita dell'uomo* of Alessandro Piccolomini treats of education, marriage, the government of a family, and the chief end of man. The *Cortigiano* of Castiglione (1478-1529) has rare literary merits, making courtesy the theme of many learned and weighty reflections. Numerous novelists now flourished, among whom Bandoello holds the first rank, his *Novelle* being chiefly founded on real and common events. The novels of the monk Firenzuola and the *Cine* of Iasen are both elegant and indelicate. Vettori and Salviati commented on the older

poets, and the latter was engaged in compiling the *Vocabolario della Crusca*, then the most important philological work in the language. All words not used by the great Florentine authors were excluded from it; even Tasso was not admitted as an authority.—In the 17th century the natural sciences especially flourished. Under able patrons, the principal of whom was Grand Duke Ferdinand of Tuscany, the Italian universities attained unprecedented celebrity. Scientific academies were founded in Rome, Florence, Bologna, and Naples; the Florentine *accademia del Cimento* embraced the most illustrious savants of the time, and published important accounts of its researches. Preëminent among philosophers was Galileo (1564-1642), who was denounced as an innovator, and maintained the Copernican system only at his peril. His *Dialoghi* and other works are written with elegance, his style and taste having been formed by reading Ariosto. His most noted pupils were Viviani, Torricelli, and Castelli; and contemporary physicists were Borelli, Malpighi, Bellini, and Francesco Redi. The learned and philosophical juriconsult Vincenzo Gravina attracted scholars from all parts of Europe to his lectures in Rome on public law, contained in his *Origine del diritto civile* and other publications. The greatest historians were Sarpi, Davila, Bentivoglio, and Pallavicini. Sarpi (died in 1623), the defender of the republic of Venice in its contest with the holy see, wrote an anti-papal and spirited history of the council of Trent, which was replied to by Pallavicini in a work on the same subject. Davila, after 16 years' residence in France, narrated the civil wars of that country in a work esteemed for its truthfulness, and in respect of style one of the best Italian histories. Bentivoglio, the papal nuncio in Flanders, wrote of the Flemish wars of his time, many of the heroes of which he knew personally. Balducci, Dati, and Scamozzi were historians of the fine arts, and Cinelli and Boccacini of literature, while Bianchi treated important historical problems as to migrations, colonies, voyages, and the origin of monarchies and republics. Montecuccoli, the military antagonist of Turenne, acquired distinction as an author by his aphorisms on the art of war. The Jesuit Bartoli wrote the history of his society, and the sermons of the Jesuit Segneri were unrivalled in eloquence. Pietro della Valle (died in 1652) described his travels (*Viaggi*) in Turkey, Persia, and India. The first Italian literary journal, the *Giornale de' letterati*, was established in Rome in 1668. A want of naturalness and truthfulness marked the poetry of the age; external delineations, trifling details, conceits, and plays upon words were the leading objects of the poets. At their head was Marini of Naples (died in 1625), who was admired not only in Italy but in France and Spain, and originated the poetical school of the Marinists, by which only his faults were imitated. Among his contemporaries and suc-

rs were Chiabrera, Guidi, Tassoni, and hetti. The foundation of the academy of dians in Rome in 1690 by Crescimbeni Gravina introduced an affectation of pas-sentiments and habits in place of Mari-. Menzini, Zappi, Maggi, Lemena, Salva-tosa, and Bracciolini wrote satirical, ero-nd facetious verses. Throughout the 17th 18th centuries the opera was the favorite in exhibition. It had long been produced theatrical and musical splendor, when of Venice (died in 1750), and especially assi, called Metastasio (died in 1782), wrote atic plays having remarkable poetical mer-. When early in the 18th century the war ie Spanish succession raged in Italy, and kingdom of Naples fell beneath the scelf of the infante Don Carlos, and afterward erdinand III., literature and the sciences cultivated with renewed vigor. Naples ced Giannone, distinguished in the de-nent of history, Capasso in literature, Ci-in medicine, Mazocchi in archæology, Ge-si in political economy, one Gagliani in tecture, and another in domestic economy philology. Filangieri rivalled Montesquieu e philosophy of legislation; Pagano wrote e criminal law; Poli distinguished himself e positive sciences; Maffei both in his-and poetry. The university of Bologna now in its splendor, its academy of sci- taking the name of "The Institute." gli, Stratico, Cesarotti, Foscarini, the iers Gozzi, Morelli, Pompei, Lorenzi, Maz-elli, and Serassi made the city of Venice rious; but political jealousy prevented the re of the economical and legislative sci- there, which under Beccaria and others making great progress in other parts of . In Tuscany, the famous French ency-cædia was republished. In the cities of ardy flourished Scopoli, Fontana, Tissot, anzani, Bertola, Villa, Natali, Volta, Scar-amburini, Parini, Beccaria, Verri, Landri-Maria Agnesi, Carli, and others, devoted erature, art, science, and the development olitical and ethical principles. Bodoni l the art of typography to an admirable nce. Prominent among the patrons of ture was Victor Amadeus II. of Savoy. Italian drama had as yet attained to excel- only in the opera, and lacked superior dies and comedies. It received an impulse e 17th century from the French theatre, elli of Bologna (died in 1727) being the who attempted to naturalize not only the ture of French tragedy but the Alexan-verse. The *Merope* of Maffei was the best dy produced in the early part of the 18th ry. A greater influence was exerted upon ge and upon literature by Alfieri (1749- ), the head of an important school of dy. Hostile alike to the operatic lightness e Italian drama and to the formal and licated intrigues of the French, he went i opposite extreme, demanding in tragedy

both the utmost intensity of passion and the utmost simplicity of treatment. He was the poet of energetic action and profound thought and feeling, as Metastasio was of love. Abandoning the customs of the court of Louis XIV., he revived the simple sublimity of the Greek stage, which had been the object of his favor-ite studies, and which was removed alike from French effeminacy and Spanish extravagance. A reformation in the Italian comedy was mean-time effected by Goldoni (1707-'98), the only genuine comic poet that Italy can boast, who sought in imitation of Molière to substitute for the *commedia dell' arte* a natural comedy of manners. In his efforts to give to the stage a more human and real character by ridding it of the traditional masks of the harlequin, pantaloon, and other stock characters, he had to contend especially against Chiari and Carlo Gozzi. The example of Kotzebue and Iffland gave rise to a lachrymose school of dramatic composition, maintained by Avelloni, Guazet-ti, Greppi, and especially by Federici. The most illustrious historians were Muratori (died in 1750), Maffei, Denina, Mazzuchelli, Tiraboschi, and Lanzi (died in 1810). The *Annali d' Italia*, *Verona illustrata*, *Revoluzioni d' Italia*, *Scrit-tori d' Italia*, *Storia della letteratura d' Italia*, and the *Storia pittorica d' Italia* were respec-tively their best works. The writings of Mu-ratori and Tiraboschi still maintain their repu-tation both for erudition and criticism. In archæology, the names of Fabretti, Gori, Maz-zocchi, Martorelli, Passeri, and Carli were dis-tinguished. Campanella continued the philo-sophical movement of Bruno in opposition to scholasticism, and Vico (1668-1744) founded the new science of the philosophy of history; his *Scienza nuova* is a view of general history, founded on the idea of Divine Providence and the essential elements of the common nature of man. Gasparo Gozzi, Algarotti, Buonafede, Vanetti, Tartarotti, and Alessandro Verri also added to the glory of the literature by abandon-ing the pedantic style that had been in vogue and introducing an acquaintance with foreign ideas and productions. Baretti con-tributed to the revival of good taste by ridicu-ling the Arcadians. Parini (1729-'99) excelled in satirical poetry, his *Giorno* being as remark-able for elegance as for severity upon the effeminate life of the wealthy Milanese nobles. Among the works of Cesarotti was a translation of Ossian, esteemed in many re-spects among the happiest productions in the language, and which Alfieri confessed to have been of service to him in the composition of his tragedies.—The political and military move-ments in Europe of the last decade of the 18th century occasioned a regeneration not only of the literature but of the national spirit of the Italians. The early part of the 19th century rivals the age of Leo X., presenting Canova, Longhi, Cicognara, Appiani, and Beltrami in the fine arts; Monti, Foscolo, Pindemonte (partly contemporary with whom was Alfie-

ri) in literature; and Volta, Melchiorre Gioja, Romagnosi, Scarpa, Spallanzani, and Oriani in the sciences. The author who doubtless exerted the greatest influence on the regeneration of poetry was Vincenzo Monti (1754-1828), who in the contest between the classic and the romantic tendencies favored the former, and in the contest between the Gallicists, or imitators of the French literature and idioms, and the purists, who made Petrarch, Dante, and the other old Italian masters their models, sided with the latter. His poems, as *Bascilliana* and *Feroniade*, his tragedies, as *Galeotto Manfredi*, his elegy *Mascheroniana*, the *Proposta*, in which he disputed the restrictions which the Della Crusicans had fastened upon the language, and his translation of the *Iliad*, alike display an admirable and nervous style. Two works of Monti deserve special mention, his *Bascilliana* and *Prometeo*. The former, in which the spirit of Basseville, a French revolutionist, is condemned to travel through France under the guidance of an angel, witnessing the suffering resulting from the adoption of the principles he advocated, is in many respects an imitation of the *Divina Commedia*. It is filled with remarkable poetical descriptions, presented with intense dramatic vividness. The *Prometeo* (1797) is also a close imitation of Dante, and is in effect an apotheosis of Napoleon as the impersonation of might and virtue. Pindemonte also made a light and graceful version of the *Odyssey*, and in his original poems especially lamented the desolation of his country. Ugo Foscolo (1777-1827) belongs to the school of Alfieri. His *Ultime lettere di Jacopo Ortis*, a political and passionate romance in imitation of Goethe's *Werther*, is supposed to describe his own troubled life. He wrote the lyric *I sepolcri*, and other works in prose and verse, remarkable both for power and beauty. Mezzanotte celebrated in verse the struggle of the modern Greeks for liberty, regarding it not only as a political but as a religious conflict between Christianity and Islamism. The lyrical poems of Leopardi (died in 1837) are highly esteemed. Among the epic and didactic poets were Botta, Ricci, Bagnoli, Arici, Grossi, Sestini, Pananti, and Lorenzi. Antonio Cesari (died in 1828) was the chief of the Trecentists, a school which carried its love of the Italian authors of the 14th century to affectation. Stratico published a dictionary containing only the words used by the Marinist authors. Prati, Aleardi, and the versatile priest, dramatist, and journalist Dall' Ongaro (died in 1873), are among the best Italian lyric poets of our time. The conte Giraud, a Roman by birth but of French parentage, revived Italian comedy at the beginning of the century, and aimed at imitating both Goldoni and Molière. He did not try however to reproduce anything like the *Tartuffe* or the *Misanthrope*, but took as his model the *Bourgeois gentilhomme* and other low comedies of the French master. To this class belong the numerous dramas of Giraud, chief among which is *L'Ajo*

*nell'imbarazzo*; this and *Il prognosticante fanatico*, *La capricciosa confusa*, and *Don Isidario*, are his best comedies; the others belong to the low amusing type introduced by Eugène Scribe. Less amusing than Giraud, but superior to him in every other respect, is Alberto Nota, who has equalled Goldoni in dramatic excellence, and surpassed him as a writer. In 1808 his *I primi passi al mal costume* was played in Turin, and in 1813 he brought out his *Filosofo celibe*, which greatly heightened his reputation. Both are elegant in their diction and full of wit. In 1826 he produced *La fiera*, his best work. From 1826 to 1847 Italian comedy had no representatives. At the close of Charles Albert's reign appeared Paolo Ferrari, Gherardi del Testa, and Giacometti. Ferrari obtained a great reputation by three principal comedies, *Goldoni e le sue dieci commedie*, *La Satira e Parini*, and *La Prosa*. Other productions of Ferrari, such as *La bottega del cappellaio* and *Il ballo in provincia*, still maintain their place on the comic stage; but since 1860 his dramatic compositions are all inferior to these. Gherardi del Testa before 1859 had written farces like *Il beretto bianco* and *Il sogno di un brillante*, and graceful comedies like *Il sistema di Giorgio* and *Un arcentura ai bagni*, which had shown him the equal of Giraud for invention, and his superior for style. Since 1859 he has much increased his reputation for excellent light comedies. Giacometti remains far beneath these two authors. Among his numerous productions three have been favorably mentioned by critics, *La donna*, *La donna in seconde nozze*, and *Il fisiognomista*, this last being a poor imitation of Giraud's *Prognosticante fanatico*. Other dramatic compositions of the ante-unitarian period are Sabbatini's *Tusconi*, and Teobaldo Cicconi's *Pecorelle smarrite*; Cromwell, *La notte di San Bartolommeo*, and *Luigia della Valliera*, by Pietro Corelli; *Cuore ed arte*, by Caterino de' Medici Fortis; and the tragedies *Gaspara Stampa* by Casabianca, *Piccola Donati* by Marengo, *Camma* and *Tentazione* (1856) by Montanelli, the last having great merit not only as a play but as a poem. According to some critics, Giovanni Battista Niccolini is the first tragic writer of Italy in this century; he is less remarkable for regularity of plot than for simplicity of dramatic action. *Filippo Strozzi* and *Arnaldo da Breccia* are his masterpieces. Among the writers of historical and national dramas is also to be mentioned Revere; and among Italy's eminent actors are Modena, Salvini, Rossi, Marchioneri, and Signora Ristori.—Among the historical writers of the earlier part of the present century, two, Vincenzo Coco (died in 1823) and Carlo Botta (died in 1837), deserve a special mention. Coco left two works, *La rivoluzione di Napoli* and *Platone in Italia*, which prove him to be a profound thinker of the school of Vico. His narrative of events in the kingdom of Naples concludes with the wholesale exe-

cations of 1799, which he himself had witnessed. Carlo Botta, whose chief work is a history of the American war of independence, is inferior to Coco for deep philosophical insight, but superior for artistic literary forms. Italian critics, however, reproach him with stiffness and pomposity in his *Storia dell' indipendenza degli Stati Uniti*; but they admit that his continuation of Guicciardini's history of Italy is written with more simplicity and naturalness, though lacking proportion in some of its principal parts, as well as accuracy in statement of facts and political impartiality. Colletta, in his *Storia del reame di Napoli*, produced a classical work which completes Coco's. His history begins with the inauguration at Naples of the Bourbon dynasty in 1784, and ends with the year 1825. His work is conspicuous for its powerful grouping of facts, and for energy of thought and diction. Vacani was a historian of the Peninsular war. Amari wrote the history of the Arabs in Sicily and of the Sicilian vespers, illustrating obscure periods in an age of national glory. Cesare Cantù began his career as a historical writer by *Ragionamenti sulla storia Lombarda del secolo XVII*. In 1837 appeared his great work, *Storia universale*, which has passed through several editions and been translated into German and French. His reputation was still further heightened by his *Storia degli Italiani, Il tempo de' Francesi, Gli eretici d'Italia, La storia di cento anni*, and his latest work, *L'Indipendenza italiana*, embracing exclusively Italian independence during the French, German, and national periods of the present century (vols. i. and ii., Turin, 1874). Cantù is also the author of histories of the Latin, Greek, and Italian literatures, of the city of Como, and of Italian contemporary poetry; of several novels, educational works, and religious lyrics. Cantù is a firm Catholic in his religious belief; but the Neapolitan Ranieri and the journalist and historian Bianchi Bovini are decidedly adverse to Catholicism. The latter is the author of a history of the popes, a biography of Fra Paolo Sarpi, a history of the Hebrews, and a monograph on Pope Joan. Cesare Balbo wrote historical meditations, a life of Dante, and a summary of the history of Italy. Balbo, Gino Capponi, the author of a history of Florence, and Carlo Troja belong like Cantù to the Guelphic school of publicists, who would fain see the popes at the head of Italy. Francini wrote an accurate and authoritative statistical work on Switzerland (1847-'51). La Farina is the author of a history of Italy from the most ancient to recent times; Federico Sclopis, of a history of Italian legislation (completed in 1857); Luigi Zeni, of an excellent compendium of Italian history; Romanin, of a learned history of Venice, written in opposition to that of Daru, and of a work on the Venetian inquisitors; Carlo Gemelli, of a history of the Belgian revolution of 1830; Giuseppe Rubini, of a history of Russia from 862 to 1725; Canetta, of a history of Amadeus II. of Savoy; Canales, of a history of the Crimean war; Gallenga, of a general history of Piedmont; Angelo Brofferio, of a history of Piedmont from 1814 to 1849, and of other works interesting from their patriotic spirit as well as literary merit; Anelli, of a history of Italy from 1814 to 1850; Carlo Cattaneo, of a history of the insurrection at Milan in 1848 (he was a member of the committee that directed the operations against the Austrians, and a participant in the struggle), and of the *Archivio triennale*, an elaborate and most careful and valuable collection of authentic documents relative to the events that occurred in Italy from 1848 to 1850; Federico Torre, of a history of the French expedition to Rome in 1849. Ferrari, in a work on republican federation, treated the question under what form of government Italy ought to be reorganized. L. C. Farini wrote a history of the Papal States from 1814 to 1850; Gualterio and Vecchio of the events in Italy in 1848-'9. Among the latest writers on mediæval Italian history are Atto Vanucci and Pasquale Villari. The latter is known as the biographer of Savonarola, and a life of Machiavelli by him is now (1874) in the press. On social science the most recent publications are Minghetti's *Economia pubblica* and *Opuscoli letterarj e economici*, containing a series of letters on religious liberty; Cibrario's *Economia politica del medio evo* and *Della schiavitù e del servaggio*; Zamboni's *Gli Esellini* and *Dante e gli schiavi*; and Celestino Bianchi's history of Italian diplomacy. Among ecclesiastical writers are the Benedictine Tosti, who wrote a history of the church; the Jesuits Luigi Taparelli d'Azeglio (the brother of Massimo), author of remarkable works on natural right and international law, and one of the founders of the *Civiltà Cattolica*; Pianciani, distinguished as a chemist and physicist; Secchi, as an astronomer and a writer on solar physics; Passaglia and Perronc, as authors of standard works on theology; and Abbate Lambruschini, as a writer on education; and the Theatine Ventura, celebrated alike as a pulpit orator and philosophical writer. The taste which prevailed in the first half of the 19th century for illustrating the national antiquities has even increased of late years. In the former period were produced Inghirami's *Monumenti etruschi*, Delfico's *Origini italiane*, Fanucci's *Storia dei Veneziani, Genovesi e Pisani*, Manno's *Storia di Sardegna*, Bras's *Malta illustrata*, and Pompeo Litte's *Famiglie celebri d'Italia*. Visconti (1751-1818) made himself a name in classical archeology, and Sestini in numismatics, the latter making his medals serve in illustrating geographical questions. Angelo Mai, De' Rossi, Borghesi, Gestaldi, Canestrini, Foresi, and others are the representative archeologists of the latter period. De' Rossi's chief works are *La Roma sotterranea cristiana* (1864) and *Inscriptiones Christianae Urbis Romae* (1857-'61). Toward the close of the 18th

and in the early part of the 19th century the natural sciences were advanced by four illustrious savants, who were nearly contemporary, Volta, Galvani, Scarpa, and Spallanzani. The discussions of Galvani and Volta concerning their new discoveries in electricity divided the scientific men of Europe into two factions, and the poets followed their example. Scarpa, a learned disciple of Morgagni, reduced anatomy to a positive science. Spallanzani wrote on physics and physiology in a style worthy of one who declared philosophy itself imperfect unless its principles were elegantly expressed. Astronomical science was represented by Piazzani, Oriani, Cagnoli, and Plana; medical science by Rasori; natural science by Genè; geography by Balbi; and jurisprudence by Cannignani and Nicolini of Naples. Later De Vico and Donati obtained a reputation as astronomical discoverers, and Pianciani as a physicist. Later still Schiapparelli, Cuppocci, and De Gasparis rendered great service to astronomy; and among living scientists Secchi and Respighi occupy an eminent place. With them must be mentioned the geographers Marmocchi and De Luca, the naturalists Simonda and De Filippi, the chemist Piria, the physicists Melloni, Marianini, and Matteucci, and the historian of science Libri. Ranalli has also published a history of the fine arts; and a rich source of information in ancient and modern political and natural history and geography of Italy is found in a series now publishing under the general title of *L'Italia*, of which 20 volumes are already issued (1874).—In general literature during the first half of the century Gioja and Romagnosi treated philosophical questions and the economical and political sciences, the *Filosofia della statistica* being the principal work of the former, and the *Generi del diritto penale* of the latter. Manzoni (1784–1873) produced new models of lyric verse, and examples of historical dramas and novels in his *Adelechi*, *Il conte di Carmagnola*, and *I promessi sposi*. To the modified classical school of Monti belong the dramas of Silvio Pellico (1789–1854), chiefly known by his *Francesca da Rimini* and *Le mie prigioni*, and those of Niccolini, often founded on the history of his country, and strongly marked by patriotic feeling. The example of Sir Walter Scott in the production of historical romances had many followers in Italy. *I promessi sposi* of Manzoni (1827) was succeeded by the *Monaca di Monza*, *Luisa Strozzi*, and *Il conte Ugolino della Gherardesca* of Rosini; the *Margherita Pusterla* of Cesare Cantù; the *Marco Visconti* of Grossi; the *Ettore Fieramosca* and *Nicolò de' Lapi* of Massimo d'Azeglio (1798–1866); and the *Battaglia di Benevento*, *Assedio di Firenze*, *Isabella Orsini*, and *Beatrice Cenci* of Guerrazzi (died in 1873). Italy received with enthusiasm these romantic delineations from her ancient history. The romance entitled *Famiglia* (1850), by Bersezio, is one of the best late Italian novels. The *Dr. Antonio* of Ruffini is esteemed for its pictures of Italian scenery. Accomplished women

have taken a considerable part in recent Italian literature. The *Morte di Adone* of Teresa Bandellini was followed by the learned philosophical and religious poems of Diodata Saluzzo, with which she intermingled slight lyrical pieces. Cecilia de Luna Folliero wrote on the education of girls and the moral influence of music. Giustina Rinier Michiel celebrated in song the festive days and memorable events of Venice. Isabella Teotochi Albrizzi wrote a graceful and truthful biography of Canova. The work of the Signora Ferucci on the education of girls received the encomiums of Gioberti and other distinguished thinkers. Other female authors are Lucrezia Marinella, Sabina Rasori, Silvia Curtoni Verza, Costanza Mocheni, and Leonora Fonseca Pimentel.—In philosophy, the names of Gioja and Romagnosi were succeeded by that of Pasquale Borelli (Lallebasche), the author of an introduction to philosophy, and of works on the nature and genesis of thought, in which he opposed the empiricism of Romagnosi. Cardinal Gerùl (1718–1802) was the author of numerous remarkable works on philosophy, theology, and mathematical and physical science. Pasquale Galuppi (1770–1846), in elaborate works, combated the philosophical tendencies of the 18th century by doctrines founded on the philosophy of the fathers of the church. He was a student of the German philosophers, and one of his most interesting works was on the changes of modern philosophy from Descartes to Kant. Contemporary philosophy has had a large number of representatives in Italy. Foremost in celebrity was Gioberti (1801–52), whose philosophical theory was so constructed as to suit itself to the national aspirations of Italy; he is also known as the author of *Del primato morale e civile degli Italiani*, *Il Gesù moderno*, and *Del rinnovamento civile d'Italia*. Next to Gioberti were Cardinal Rosmini-Serbati (died in 1855), whose ontological theory has met with even less favor than Gioberti's, and Mamiani, the author of *Rinnovamento dell'antica filosofia italiana*. Ausonio Franchi is diametrically opposed to all these philosophers. He places the criterion of truth in the individual reason and feeling, both corresponding to the two most intellectual spheres of the mind, philosophy and religion. According to him, the philosophy of Italy is scholasticism, which is the negation of reason, and its religion Catholicism, the negation of liberty. Thus he is antagonistic to Tommaseo, the representative of the spiritualist and religious schools. Greek philosophy is represented by Centofanti, and philosophical skepticism by Giuseppe Ferrari, the author of *Filosofia della rivoluzione* and *Corso di lezioni sugli scrittori politici italiani* (1862–3); and Hegelianism by the Neapolitan Vera. To the school of Franchi belong Alfonso Testa and Carlo Cattaneo. The *Calcolo di probabilità dei sentimenti umani* (1855) of Mastriani is an attempt to found philosophy on a physiological basis. Giordani may be considered as the founder of



ool of aesthetical criticism in modern He contributed effectually to put down ary "Gallomania" which had so long d there. The articles published by him *biblioteca Italiana* of Milan, his aestheties on sculptors, painters, and authors, panegyrics on Napoleon, Canova, &c., with a vast collection of letters, are the highest estimation by his country-icognara, Pindemonte, Foscolo, Perlasilio Puotti, Mamiani, Giudici, Arcaninalli, and Giuliani have also distinguished themselves in this department of lit—Besides the contemporary authors orks have gained such permanence as required special mention in this article, hers are gradually taking their places asting literature of Italy, or rendering ves conspicuous by timely and popular

Such are most of those named in the g list of living authors. Leading poets anni Prati (one of the most prominent of Italian political lyrics), Frullani, Tivucchi, and Zanella; De Spuches, Parother Sicilians; Barattani, Mercantini, nd De' Marchi. Female poets are Franutti, Alinda Brunamonte, Emilia Fua, Musio-Salvo, and others. Historians otti (Savoy), La Lumia (Sicily), Giudici *dei comuni italiani*), Celesia (Genoa), iso (Milan). Novelists are Nievo, Arriatati, Bezio, De Amicis, and Signora Tegubernatis.—The principal historians in literature are Tiraboschi (1772-'83), é (1811-'19), Maffei (2d ed., 1834), li (1845), Emiliano Giudici (1851), Mal-355), Lombardi (of the 18th century, ), Ugoni (of the second half of the tury, new edition, 1856-'9), and Levati rst quarter of the 19th century, 1831). Sismondi's *Littérature du midi de e* (4 vols., Paris, 1813), translated by e (1823); Hallam's "Literature of Eu-nd W. Roscoe's "Life of Lorenzo de'

For more recent literature, see espedée Roux's *Histoire de la littérature oraine en Italie* (Paris, 1874); and for philosophy, Botta's "Historical Sketch" weg's "History of Philosophy," trans-G. S. Morris (New York, 1874).

**Wines of.** From time immemorial s been noted as a wine-growing coun-at the present day, next to the cereals, the most important production of her he amount annually made has been v-estimated, but is probably as much as 000 gallons, of which but a small pro-is of good quality or fit for export. The n, Massic, Cæcuban, and other growths in ancient times, are now known only escriptions of them found in old Latin no means of identifying them with wines being accessible. For many s succeeding the overthrow of the Ro-pire vinification was practised after the imitative methods; and although vines

were grown and wine was made in every province of the country, it was exclusively a local product, intended for home consumption. This state of things may be said to have practically extended into the present century. Forty years ago Italian wines of high grade were scarcely known to the inhabitants of the country, and still less to foreigners. Now they have an established reputation, and by the close of the century are not unlikely to become formidable rivals of the best growths of France and Germany. This is due in great measure to the formation of œnological societies, which have encouraged the practice of wine making after improved methods, and to the general development of the national life since the union of the Italian people under one government. Grape culture in many parts of Italy, and notably in Lombardy and Venetia, is practised on a different system from that prevalent in the chief wine-producing countries. The vines, instead of being closely pruned and attached to low stakes fastened in the ground, are allowed to run up the trunks of trees, planted in rows for that purpose. The maple, trimmed to the form of a pollard, is the tree most commonly employed, and its branches, stripped of the greater part of their foliage, form the support of the head of the vine. The shoots of the latter, when they have attained a sufficient growth, are twisted into a rope and then tied to a similar rope from an adjoining tree. Rows of trees thus festooned with vines, loaded in the vintage season with full clusters of grapes, present a peculiarly attractive appearance, and form one of the most picturesque features of the country; but the grapes never attain that perfection, even in the climate of Italy, which is necessary to produce wines of the first class.

In fact, it has been proved from experiments made under government direction during the vintage of 1873, that the must obtained from vines thus trained usually contains one third less saccharine matter than that from vines trained on the low system, as practised in the best wine-growing countries. The result is a thin, acid wine, which cannot be kept for any considerable period. In certain parts of Italy this method of cultivation is so intimately connected with the general system of agriculture, that no immediate change is probable or perhaps possible. This is especially the case in the level country, and it is consequently in the hilly and mountainous districts that Italian viticulture will be the soonest developed.—Twenty-five years ago the wines of Piedmont first became known to any considerable extent outside of the country; but their name had scarcely been established in the London market when the grape disease, which for a time almost paralyzed vinification throughout Europe, attacked the vines of northern Italy. The district of Asti, long celebrated for the superior quality of its wines, was only partially affected by the disease, and continued to produce abundantly while the rest of the country was suf-

fering from its effects. The reputation which the Asti wines thus acquired has continued to the present day, and is founded in no small degree upon superior skill in manipulation. Hence it is customary to designate the Barbera, Barolo, Nebbiolo, Brachetto, Grignolino, and all other varieties of wines which are the common produce of Piedmont, as wines of Asti, and to sell them as such. As a rule these wines are full-bodied and somewhat rough, but are capable of being greatly improved by increased carefulness and skill. Attention has recently been called to the admirable sites presented by the valleys and mountain slopes bordering on Switzerland, and no portion of Piedmont gives better promise of viticultural development. Upward of two centuries ago the Valtellina, then a dependency of the Swiss canton of the Grisons, yielded wine which found a ready market both in Switzerland and Germany; and it is believed that the Val di Sesia, the Val d'Aosta, and in fact the whole adjoining Alpine district of Piedmont, can in a few years be made equally productive.—The plains of Lombardy and Venetia yield an immense amount of wine, although, owing to the system of culture above described, which prevails there, the quality is poor. It contains very little sugar or alcohol, much acid, and no aromatic properties. But here, as in Piedmont, the Alpine district, bordering on Switzerland and Tyrol, presents unsurpassed facilities to the intelligent wine grower. "In many of these valleys viticulture might attain the highest perfection if it were directed to quality, and if selected vines were grown in closed vineyards with that care and attention which are bestowed upon this branch of production on the Rhine and in France. Here wines might be produced which would be unsurpassed by any other wines in the world. Here there is an equable temperature, and a sufficiency of those precipitations of moisture during nights of calm radiation from the neighboring hills. Here is rain at the proper time, and plenty of the direct rays of the sun come in the warmth of August, when the vine is most in need of it. Indeed, here are all the conditions for producing not only a sweet wine such as is common in climates which have only sun and heat, but for the production of those flavored wines which are the privilege of those parts of the world where the so-called great wines are grown." (Thudicum and Dupré, "Treatise on Wine.") The indolence characteristic of the Italian race has hitherto prevented the development of this favored region; but under the present improved conditions of the national life, and in view of the increasing demand for wines of high grade, its future seems full of promise.—In Tuscany wine making may be said to have been brought to a higher degree of perfection than in other parts of Italy, mainly because for many years it has been conducted by persons of means and superior intelligence. The former grand-ducal government

encouraged it, and the nobles made their vineyards an important source of income, selling their wine at retail from their cellars by the flask. This has a capacity of three quarts, and is not stoppered in the usual manner. A film of oil is deposited on the surface of the wine at the neck of the flask, and answers the double purpose of keeping off the air and of allowing the escape of any bubbles of carbonic acid that may arise in case of after fermentation. The oil may be flung out, or soaked out with tow, previous to using the wine. The most famous wine of Tuscany was for many years the Montepulciano, once designated the "king of wines;" but latterly the product of the vineyards of Chianti, near Siena, made from a peculiar grape, has obtained the supremacy, and almost every good flask of wine sold in the country now goes by that name. It is full-flavored and astringent, with an alcoholic strength equal to about 20 per cent. of proof spirit. The wines of Artimino, a former grand-ducal estate, and of Carmignano, are also of good quality. To these may be added the verdea, or green wine, so called from its color, produced at Arcetri, near Florence, and the Trebbiano, described as a "gold-colored sirup, made from grapes passulated on the vine by torsion of the stalk."—The best known wines of the former Papal States are those of Orvieto and the muscats of Albano and Montefiascone, all of good repute. The southern portion of the Italian peninsula yields a large amount of spirituous wines, many of which reach foreign markets in a highly fortified condition. Those of Gallipoli and Taranto have been known to reach the ordinary strength of cognac. *Lachrymæ Christi*, the most noted growth of this part of Italy, is a name liberally bestowed on all sweet red wines made there, although the genuine is grown only on the slopes of Mt. Vesuvius. It has a wide reputation, but is rarely met with in perfect condition. The Capri wine, both red and white, is also celebrated, but, like the *Lachrymæ Christi*, is too often a spurious or factitious product.—Sicily, once fruitful in wine and oil, now produces but a single variety which is exported in large quantities; this is the Marsala, an amber-colored or brown wine, which derives its name from the seaport Marsala, whence it is shipped to various parts of Europe and America. It is generally strongly brandied before leaving the island, and much of it is transformed into imitation sherry. Red wines are also grown in Sicily, which, owing to their low price, are exported to various parts of Italy and to America. The total quantity of wine produced has been estimated as high as 200,000 pipes, of which less than a fifth part is believed to be fit for exportation. The island of Sardinia produces a considerable amount of red and white wines of fair quality; but the art of wine making is very imperfectly understood there, and the quantity produced is far below the capacity of the soil.

**ITARD, Jean Marie Gaspard**, a French surgeon, born at Oraison, Provence, in 1775, died in Paris, July 5, 1838. At 18 he was appointed by the revolutionary committee surgeon of the military hospital of Toulon, although he had never read a medical book or seen a surgical operation. He devoted himself to study, and two years later was made a surgeon of the second class at the hospital of Val de Grâce. In 1799 he was appointed physician of the institution for deaf mutes, where he became known by his efforts to instruct a young man found wild in the forests of Aveyron. (See IDIOCY.) In 1801 Itard published a memoir giving the results of a year's effort in instructing him, and in 1807 another giving the final results. He next gave his attention to the training of deaf mutes in articulation, in which he succeeded almost as well as Pereira. In 1821 he published an elaborate work, in 2 vols. 8vo, on the diseases of the ear and of the sense of hearing. He also wrote a treatise on pneumothorax.

**ITASCA**, a N. county of Minnesota, bounded N. by Rainy lake and Rainy Lake river, separating it from British America, and drained by several tributaries of that stream, and by the Mississippi; area, about 9,600 sq. m.; pop. in 1870, 96. Its surface is uneven and diversified by many small lakes.

**ITASCA, Lake of**, a small body of water in Minnesota, on the N. W. border of Cass co., being one of the uppermost of the multitude of lakes which form the sources of the Mississippi river. It lies in lat. 47° 10' N., lon. 95° W., near the summit of the Hauteurs de Terre, the watershed between the Red river of the North and the streams flowing to the gulf of Mexico, 1,575 ft. above the level of the sea. It is a beautiful sheet of water, surrounded by hills, and its shores are clad with pines. It was discovered by Schoolcraft, July 13, 1832. The remotest source of the Mississippi is a small rivulet rising among the hills a few miles S. of this lake, and falling into it after forming a number of little basins. The stream issues from the N. end of the lake 10 or 12 ft. wide, and 12 or 18 in. deep.

**ITAWAMBA**, a N. E. county of Mississippi, bordering on Alabama, and drained by Tombigbee river; area, about 600 sq. m.; pop. in 1870, 7,812, of whom 986 were colored. It has a level or undulating surface, almost without timber. The soil is a dark, rich loam, containing much lime. The chief productions in 1870 were 7,053 bushels of wheat, 122,363 of Indian corn, 24,942 of sweet potatoes, and 1,865 bales of cotton. There were 1,420 horses, 2,235 milch cows, 3,915 other cattle, 6,130 sheep, and 9,734 swine. Capital, Fulton.

**ITCH**, or **Scabies**, a parasitic disease of the skin. There is no doubt that the true character of scabies was known among the ancient Greeks and Romans, but the animal was supposed to be a louse. Avenzoar in the 12th century alluded to its parasitic nature; and Aldro-

vandus about 1600 gives a good description of the animal, but says it has no legs. Mofet at the same time says it is identical with the mite inhabiting cheese. Occasionally after this we find mention of this parasite in the writings of the great medical fathers, but it was generally forgotten when the grand scientific hoax was played in 1812 by the medical student Gales in Paris, who was cunning enough to substitute a cheese acarus concealed beneath his nail, and thus deceived the judges on the prize offered to the discoverer of the cause of this disease. The Corsican Renucci finally established its reality, taught by the old women of his birthplace, and Raspail gave the first scientific description of the animal in 1839. Since then the best observers of its habits have been Bourguignon, Eichstedt, Schinzinger, and Hebra.—The *sarcoptes hominis*, or *acarus scabiei*, presents three forms. The mature female is discernible by the unaided eye, as a white speck  $\frac{1}{8}$  of an inch long by  $\frac{1}{16}$  of an inch broad. It is white, and resembles in shape a tortoise shell, with an arched back and flat belly. On the back are seen bristles or hairs, and little spines. The skin is tough, and shows irregular transverse parallel rings.

There are four pairs of legs, two of which are situated in front and project beyond the anterior, the others toward the posterior end of the body.

The two anterior pairs of feet are provided with sucking disks, and with hairs or bristles armed at their extremities with minute claws; the two posterior pairs of feet have no sucking disks, but only long bristles and small claws. The head is bluntly conical, somewhat retractile, and situated between the anterior feet. The mouth consists of a double upper and under lip, between which play the jaws armed with teeth, moving in a horizontal direction up and down, like the blades of scissors over each other, and resembling the claws of a lobster. Eyes are wanting. The male is only half the size of the female, of a blackish color and flattened form. It has sucking disks instead of bristles upon the fourth pair of feet. In other respects it resembles the female. The young, when first hatched, have but three pairs of legs, and in them no distinction of sex is noticeable. In order to become mature they undergo three separate stages of torpidity, before each of which the body is fat and large in comparison with the extremities. During these they burrow into the skin. By the first process they acquire the wanting pair of legs. When mature the female digs a shallow burrow, and after impregnation ceases to creep over the outer skin, but pene-

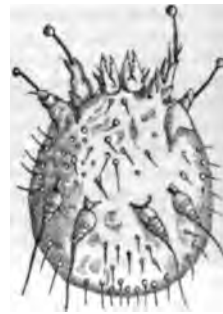

*Acarus scabiei*, magnified.

trates deeper and deeper, forming the long holes or "galleries" so well known. The male never enters these galleries where the eggs are found, but digs himself a shallow cell, or seeks new fields for his rambles. The female as she goes on her oblique and downward course deposits her eggs in the gallery, one after the other. The young acarus is hatched about the eighth day, and then emerges from its birth-place to go through the process above described, leaving behind it its broken shell. All stages of development may be seen in these burrows, from the amorphous form in which the eggs are deposited to the perfect young before they break their prison walls. The mother never leaves her hole, and sometimes wanders along for 4 in. beneath the surface; 50 eggs and broken shells are sometimes counted in such burrows. The whole time required for the young to reach maturity after impregnation is estimated at six weeks.—Infection is produced by the transfer of males and young from one host to another. The *sarcoptes* loves warmth, and on this account has been called a nocturnal animal, though improperly, for its wanderings are caused by the warmth imparted to the body of its host by lying in a warm bed, by sleeping with another, or by dancing in the evening; and thus it is that they are conveyed from one person to another. It may happen that the female may be scratched out of her burrow, and thus be transplanted to another part of the same host, or to the body of another. Scabies is seldom if ever caught by handling patients, however freely this may be done, from the fact that such examinations take place in cool rooms, when the parasites are quiet. Their favorite lurking places are the tender skin between the fingers, and folds of the axillæ; and on infants we find them distributed over the whole surface of the body. They have been cultivated also on the face and scalp, and may inhabit any part of the body. In persons who suffer from cold hands and feet we often find these parts entirely free from them, while the rest of the body may be covered with the eruption; and the same love of heat is exemplified by the immediate relief which a patient, wrought up to frenzy by the itching of a general scabies at night, finds by jumping out of bed into the cold atmosphere of winter. In order to bore through the epidermis, beneath which it seldom penetrates, the acarus supports itself on its anterior end by means of its hinder legs, and works away with its lobster-like claws. It takes generally 20 or 30 minutes to penetrate the outer layer, but when this has been pierced the progress is more rapid. The poorer in nutriment they find the epidermis the deeper they penetrate, and the greater is the exudation, which lifts up the animal, and causes the white color of the burrow. The young brood seems to require the tender and last formed epidermal layers for its food, and therefore bores further and causes more itching. The long bur-

rows of the females, which cause the real disease, run an irregular course, and become smaller by age as the exudation is absorbed. The entrances generally remain open for the exit of the young and admission of air. The third or fourth week after inoculation a papular eruption appears; subsequently excoriations, vesicles, pustules, and deposition of pigment show themselves, which are merely the results of scratching, and have no other connection with the parasite than that they are caused by the itching which the animal excites. The same results precisely would follow the same amount of scratching from any other cause.—A peculiar form, known as the Norway itch, consists of conical crusts, sometimes an inch thick, raised on the surface of the skin. This variety affects even the face and nails. Its common occurrence in Norway and rarity elsewhere, only half a dozen cases having been observed in other countries, has led to the supposition that the disease is owing to some other acarus; but Hebra has shown that the crusts consist of dried epithelium and dead acari, and in the few cases in which they have been found present the live animals were identical with the ordinary *sarcoptes*. This variety leads often to serious complications, as immobility and great swelling of the limbs. Sometimes a circumscribed part of the body is thus affected, while elsewhere it presents the usual appearances of itch. No satisfactory explanation has yet been offered of its cause, but it yields to treatment as well as the simple sort.—Scabies is found all over the world. In Germany, where the old system of apprenticeship and its attendant wanderings through the land is kept up, and where barracks are filled with dirty soldiery, the disease is borne from one part of the land to another, and thus never dies out. In America it is now comparatively rare, though it occasionally runs through asylums and schools, and thus finds its way into good society. As to treatment, the chief indication is of course to destroy the parasite and its eggs. Little can be said here about the many plans of the present dermatologists; and it is almost unnecessary to say that the use of internal remedies is absurd. Several methods have been advised, called "quick cures," which require but a few hours for their application; but in many cases they fail, and produce an artificial inflammation of the skin. Of course, if any animal or a single egg remain, the disease is not cured. Hundreds of remedies are advised, but the essential agent in its treatment is sulphur. This, in the form of lotions or ointment, and combined with the proper use of baths and potash soaps to soften the skin, will almost always cure in two or three days. But after the death of the animals and their embryos, much may still remain to be done to remove the eczema, papules, and pustules which they have indirectly caused, and which are to be treated as simple cases of the same disease.

**I**A, a village in the town of the same name, the capital of Tompkins co., New York, situated on both sides of the Cayuga inlet,  $1\frac{1}{2}$  m. N. and S. of the head or S. end of Cayuga lake, and 17 m. W. by S. of Albany; pop. in 1870, 1,107. The village is situated partly on a fine plain, partly on the slope of a range of hills which bound it on all sides to the north. The court house, jail, and office are good brick or stone buildings. There are 10 or 12 beautiful cascades in or near the village. It is the terminus of the Cayuga and Seneca of the Delaware, Lackawanna, and Western railroad, and of the Ithaca and Athens, Ithaca and Seneca, Ithaca and Cortland, and the Cayuga Lake railroads; while by means of a daily line of steamboats on the lake between Ithaca and Cayuga bridge, it is connected with the New York Central railroad. It is a place of commercial activity, and an important center for the transshipment of Scranton, Lackawanna and Lehigh Valley coal. The principal manufactures are of paper, bent work, agricultural implements, calendar clocks, glass, engines, and boats. There are two banks with an aggregate capital of \$500,000. The village is the seat of Cornell University. (See CORNELL UNIVERSITY.) Graded schools are in process of organization, and there are several private schools, a preparatory school, a public library, one daily and two weekly newspapers, and 12 churches. **I**A (mod. Gr. *Thiaki*), the sixth in size of the Cycladic islands, 2 m. E. of Cephalonia, to which it forms an eparchy, and 17 m. W. of the mainland of Greece; length 15 m., breadth 4 m.; area, 38 sq. m.; pop. 9,873. It is nearly divided by the harbor of Porto Molo on the E. coast. The surface is mountainous, a limestone range, with many craggy peaks, running the whole length of the island. The soil is light and shallow; nearly one third of the surface is cultivated and yields grain, currants, and olives, and with good wine and honey are the principal agricultural products. The people are engaged in maritime trade. The climate is temperate for its salubrity. The capital and chief city, Ithaca, is built on a harbor of the Porto Molo. The island is divided into four districts: Aëto, Anoge, and Exoge. Ithaca is generally believed to be the island of that celebrated in the Homeric poems as the home of Ulysses. On the sides and summit of Aëto, which rises 1,200 ft. above the level of the foot of Porto Molo, are some Cyclops' caves which the islanders call the Castle of Ulysses. At the foot of a white cliff on the east there is a perennial spring, traditionally regarded as the famous fountain of Ulysses; and it is believed that the precipice is the one to which the poet refers when he tells Ulysses as challenging Eumæus "to leap over the great rock" if he lies.—*Wiegmann, Ithaca, der Peloponnes und Ithaca*, 1869).

**ITTENBACH**, Franz, a German painter, born at Königswinter, near Bonn, in 1813. He studied in Düsseldorf under Schadow, and in Rome, and became known as one of the best religious painters of the Düsseldorf school, and as a successful imitator of the Italian masters. His "Holy Family in Egypt" was purchased in 1868 for the national gallery at Berlin.

**ITURBIDE**, Agustín de, emperor of Mexico, born at Valladolid (now Morelia), Sept. 27, 1783, executed near Padilla, July 19, 1824. His parents were from Pamplona, Spain, and settled in New Spain shortly before his birth. He studied at the seminary of his native town until the death of his father, when at the age of 15 years he assumed the direction of the paternal estates. In the same year (1798) he became lieutenant in a militia infantry regiment of Valladolid. In 1805 he joined the army at Jalapa. On his return in 1809 he aided in repressing a revolutionary movement, which was followed on Sept. 16, 1810, by the revolution planned by the priest Hidalgo, who offered to make Iturbide lieutenant general. He declined from a conviction that the plan was not feasible, and Hidalgo sought to secure his neutrality, granting him a safe-conduct for himself and family, and promising that his hacienda should be protected from pillage and fire. But this proposal also was rejected, and Iturbide took the field "in the service of the Mexicans, the king of Spain, and the Spaniards," siding with the latter in rigor toward the insurgents. He gained great distinction in the battle of Cruces, and was made a captain in the southern army; but ill health compelled him to go to the city of Mexico, and he was sent to Michoacan as second in command under Garcia Conde. Here he again aided in quenching the revolutionary fire, rekindled by Albino Garcia, whom he captured; and he was soon afterward made colonel. From that time till the end of 1815 he took part in all the engagements of the royal troops, directed for the most part against José Maria Morelos, who after the execution of Hidalgo succeeded him as leader of the insurgent forces. The year 1816 found him in command of the provinces of Guanajuato and Michoacan, and of the northern army, by which they were then occupied; but he had incurred the displeasure of some leading citizens, and grave accusations were preferred against him, which led to his dismissal, although he was acquitted of the most serious charge, that of complicity with the revolutionists. On returning to private life, Iturbide set seriously to maturing his long cherished project of independence, and events soon opened a way to the accomplishment of his design. The news of the Spanish constitution, proclaimed in the peninsula in 1820, filled Mexican soldiers with the desire of freeing their country. The movement soon became general, and Iturbide, seeing that the time for action had come, secured the command of the southern army, about to march against Guerrero,

who was then at Acapulco at the head of the remaining rebel forces. On Nov. 16, 1820, he set out from the capital, and to lull the suspicions of the government simulated some encounters with Guerrero, to whom he in reality communicated his project; and having concerted with him relative to future operations, he informed the viceroy that the rebellion was entirely at an end. This intelligence restored confidence among merchants, and a convoy was despatched to Acapulco with \$525,000, which money Iturbide seized, promising to refund it to its owners. With these resources at his disposal, and secret agents in all parts of the country, he promulgated on Feb. 24, 1821, his plan of independence, known in history as the "plan of Iguala," from the name of the town where it was put forth. The principal bases of the plan were "religion, union of Spaniards and Mexicans, and independence; Ferdinand VII., or in case of his refusal, such other member of a reigning family as the congress soon to be organized might choose, to be called to the new empire." His next step was to inform the viceroy of what had taken place; and the latter immediately organized an army to crush the revolution in its infancy. But this measure came too late; public opinion was everywhere in favor of the plan of Iguala, and its author began his march toward the capital with comparatively little opposition, his forces increasing daily. Meantime the newly appointed viceroy, Don Juan de O'Donoju, arrived from Spain, and finding the suppression of the new order of things to be impossible, he concluded with Iturbide, at Cordova, Aug. 24, 1821, a treaty in accordance with the plan of Iguala, except in the clause relating to the election of emperor, who, in case of the refusal of Ferdinand VII. and of some other princes enumerated, should be "any one designated by the cortes." On Sept. 27 Iturbide made his entry into the capital amid the acclamations of the people. The *junta gubernativa* prescribed in the plan of Iguala was at once organized, and Iturbide, who at Iguala had prudently refused the title of lieutenant general, and accepted that of first chief of the army, was formally installed in office. Peace was soon established; the few Spanish troops in garrison at important stations became discouraged; the only stronghold left to the Spanish government was the fortress of San Juan de Ulua off Vera Cruz; and the peninsula of Yucatan, with the province of Chiapas, and several towns in Guatemala, declared their independence and were ultimately united to the Mexican empire. Such of the Spanish residents as desired to leave the country were permitted to do so without restraint; which liberal measure, with numerous others emanating from the new government, served to increase its short-lived popularity. But Iturbide, who had been so successful in organizing and carrying out a bloodless revolution, was unable to establish a government upon a solid basis. A regency, composed of three members, according to the plan, was appointed: Iturbide was proclaimed generalissimo of the land and marine forces, and president of the regency, with an annual salary of \$120,000, an immediate donation of \$1,000,000, 20 square leagues of land in Texas, and the title of serene highness. Before long signs of discord between Iturbide and the junta became visible. The treasury was depleted, and nearly all sources of revenue were cut off, while the national expenses were greatly enhanced; the army was without discipline; and public opinion was divided between republicanism and the new form of government. Iturbide hastened the convocation of the first congress, in the hope of immediate relief; but that body obstinately refused to grant him money for the troops, and even declared the command of the army to be incompatible with the executive power. But the generalissimo had 16,000 men at his disposal in the capital; and through the agency of his partisans, who knew his popularity with the military, he was proclaimed emperor on the night of May 18, 1822. On the 21st the proclamation was confirmed by congress, which declared the crown hereditary in his family, fixed the civil list at \$1,500,000 annually, created an order of knighthood and other accessories of a monarchy, established the imperial household with the customary pomp, and ordered money to be coined with his effigy. He was crowned on July 21. But the symptoms of anarchy had not disappeared; the friends of liberal institutions either fled or temporized; and a conspiracy organized in Valladolid led to the arrest of several persons suspected of participating therein, and among them 15 deputies. This act, together with the arbitrary seizure by the government of \$1,300,000 deposited at Perote and Jalapa, exasperated the people; and the emperor, harassed by the continued opposition of the congress, dissolved that body by decree on Oct. 31. But Santa Anna proclaimed the republic at Vera Cruz on Dec. 2; the *junta instituyente*, which had succeeded the congress, was unable to establish order; defection became general among the army officers, and the republican troops were fast advancing to the capital. Iturbide in despair hastily reassembled the congress, and tendered his abdication; but that body, not recognizing the abdication, annulled the election of the emperor, and decreed that he should at once leave the country and "fix his residence in Italy," granting him a yearly pension of \$25,000, and declaring null the plan of Iguala and the treaty of Cordova. On May 11, 1823, Iturbide set sail for Leghorn, whither he arrived on Aug. 2. But, impelled by an insane desire for the recovery of his crown, he proceeded to England, and on May 11, 1824, embarked for Mexico. During the year a new government had been formed, with a republican constitution, and Iturbide had no influential friends left in the country. The government, apprised of his movements, declared him

and an outlaw, in case he should at and under any title whatsoever, set upon Mexican territory, and that by one he should be regarded as a public enemy of the state." Iturbide arrived at Sotomayor on July 14, unaware of the severe attack against him, and landed in his company with his secretary Beneski; he was apprehended by the military commander who retained him a prisoner at Pacing the decision of the congress of 1823. That body, in spite of entreaties, promises, and protestations of innocence, which he referred to the presence of his wife and children on board the vessel, sentenced him to immediate execution. He was shot on the evening of the 15th, after assuring the multitude that his death was not treasonable, and exhorting them to religion, patriotism, and obedience to the government. The congress of Mexico decided that his family should reside in Colombia, and that upon them a yearly pension of \$10,000 should be granted, but as there was no ship for a Colombian vessel, his wife was permitted to go to Mexico. She lived for many years in Mexico, and then went to Bayonne in France. Angel de Iturbide, the eldest son of Manuel, died in the city of Mexico in 1825, leaving a son who had been adopted by Manuel as heir to the throne; and the emperor's younger son died in Paris in 1826, where he had earned a precarious living as keeper of a public house.

See PETEN.

ITZA, a powerful Indian family of Central America, who at the time of the conquest inhabited the islands and shores of Lake Itza or Guatemala. They spoke a dialect of the Yucatec language, and were probably of the same race as the Itzaes of Yucatan. In 1420, one of the powerful *caneks* migrated southward with his followers after many wanderings fixed his abode on the island of Tayasal, in the lake of Chulpeten. He built a considerable city, and the population increased so rapidly that, according to the chroniclers, they numbered 25,000. The island, besides a large population, was fertile. Cortes reached the Itzaes in his march from Mexico to the Gulf of Mexico in 1523, and has left us an account of the chief and his insular capital. They received the Spaniards kindly, and elevated the rank of a god a lame horse which he carried with him. Its image, cut in stone, was found in the temple of Tayasal when it was destroyed in 1698. Their country being rich in the precious metals, and remote from the sea, the Itzaes were suffered to remain independent and isolated long after the conquest of Yucatan and the principal parts of Central America. Until 1698 they bravely defended themselves against the invaders; but in that year they were

finally subdued by Manuel de Ursula, governor of Yucatan, whose troops spent a whole day, says Villagutierre, in destroying the temples of the city alone. Numbers of the Itzaes fled eastward and were confounded among other tribes; the descendants of those who remained, though subject to Guatemala, and nominally Catholics, have made little change from the condition of their forefathers.

IVAN, czars. See RUSSIA.

IVANOFF, Alexander Andreyevitch, a Russian painter, born in St. Petersburg in 1801, died there, July 15, 1858. He studied in that city, and became known in 1832 by his "Christ and Magdalen," and subsequently by a colossal painting representing "Christ appearing before the People," executed in Rome, where he lived for about 20 years.

IVES, Levi Silliman, an American bishop, born in Meriden, Conn., Sept. 16, 1797, died in New York, Oct. 13, 1867. He was brought up on a farm in Turin, Lewis co., N. Y., to which his father had removed. When 15 years old he was sent to the academy at Lowville, where his studies were interrupted nearly a year by his service in the war with England, under Gen. Pike. He entered Hamilton college in the summer of 1816 to prepare for the ministry of the Presbyterian church; but from impaired health he left college before the close of his senior year. Having changed his religious views, he joined the Protestant Episcopal church in 1819, studied theology in New York, and received deacon's orders in August, 1822. His first services were rendered at Batavia, N. Y., then a missionary station. Thence he went the next year to the charge of Trinity church, Philadelphia, and was ordained to the priesthood. In 1827 he took charge of Christ church, Lancaster, Pa.; at the end of the year he became assistant minister of Christ church, New York, and about six months after was made rector of St. Luke's church in the same city. He served in this place till September, 1831, when he was consecrated bishop of North Carolina. To promote the cause of education in the church, he established an institution at Valle Crucis, among the mountains of that state, which finally exposed him to great pecuniary loss. Soon after his settlement in his diocese he prepared a catechism for slaves, which was successfully introduced under his own supervision on some of the large plantations. He published a volume of discourses on the "Apostles' Doctrine and Fellowship," and another on the "Obedience of Faith" (New York, 1849). During the excitement in the Episcopal church caused by the Oxford tracts, he sided strongly with the tractarian movement; and though his diocese was eminently high church, his language and acts touching this movement excited distrust, and the result was alienation. In December, 1852, he visited Rome, and was there admitted into the Roman Catholic church. He was consequently deposed from his bishopric, Oct. 14, 1853, and

published "The Trials of a Mind in its Progress to Catholicism" (London and Boston, 1854). After his return he became professor of rhetoric in St. Joseph's theological seminary at Fordham, and lecturer on rhetoric and the English language in the convents of the Sacred Heart and the sisters of charity. His last years were devoted to establishing the protectories for destitute Roman Catholic children at West Chester, N. Y., and to teaching in Manhattanville college, New York, which he aided in founding.

**IVORY**, the osseous substance which composes the tusk of the elephant, and which is a peculiar modification of dentine. In commerce it is customary to include in the term the tusks of the hippopotamus, the walrus, the narwhal, and some other animals; but according to Owen and other high authorities it can only be strictly applied to the peculiar reticulated modification in the elephant's tusk, although this is analogous to the substance (dentine) which forms the main part of all teeth. The appearance given by a cross section of any portion of an elephant's tusk, of circular lines intersecting each other so as to form lozenge-shaped figures with curved boundaries, distinguishes true ivory from all other bony substances, and from all other tooth substances, whether dentine or not. The principal supplies of ivory are derived from the W. and E. coasts of Africa, the Cape of Good Hope, Ceylon, India, and the countries eastward of the straits of Malacca. The best comes from Africa, and is of a finer texture and less liable to turn yellow than that brought from India. Prof. Owen says: "The African elephant, as is well known, is a distinct species from the Asiatic one; and some of the Asiatic elephants of the larger islands of the Indian archipelago, as those of Sumatra, if not specifically distinct from the elephants of continental Asia, form at all events a strongly marked variety;" and he remarks that in the Asiatic elephants tusks of a size which gives them the value of ivory in commerce are peculiar to the males, while in the African elephants both males and females afford good-sized tusks, although the males have the largest. The best tusks are nearly straight, and in section nearly circular. One of the largest has been found to measure 8½ in. on its longer and 7 in. on its shorter diameter. They are hollow for about half their length, and a line is traced from the termination of the cavity to the tip of the tusk, which marks in the solid ivory the former extension of the cavity. Upon the outside they are coated with a rind one tenth to one fifth of an inch thick, the color of which in the African varieties may be one of numerous transparent tints of orange, brown, or almost black, and in the Asiatic an opaque fawn or stone color. It conceals the quality of the ivory within, which may be partially exposed at the worn tip, but is finally ascertained only on the introduction of the saw by which the tusk is cut up for use. Even in the interior it is often found to be of variable character.

opaque patches appearing in the transparent quality, and the white being sometimes marked in rings alternately light and dark colored. In the larger teeth the grain is often coarse in the outer portion, and becomes fine within; and some varieties are of chalky consistency like bone, and present dark brown spots. The qualities are so variable, that when exact matches are required of several articles it is important to cut them from the same tusk. The chemical composition of ivory is said to differ considerably in the animals of different countries; but this probably depends upon the age of the animal and the part of the tusk from which the specimen is taken, although the kind of food will exercise an influence. The following analysis, taken from the *Dictionnaire universel*, may be assumed as its average composition: animal matter, dried, 24.00; water, 11.15; phosphate of lime, 64.00; carbonate of lime, 0.10. By very long exposure under favoring circumstances the animal matter becomes dissipated, rendering the texture brittle. This was the condition of some ancient ivory carvings found by Layard in the ruins of Nineveh. To restore their tenacity Prof. Owen recommended boiling them in a solution of gelatine. The experiment proved perfectly successful, and the ivory thus regained its original strength and solidity. A remarkable source of ivory, which has long supplied the Russian markets, is the tusks of fossil mammoths found in the banks of the rivers of northern Siberia. This fossil ivory is of similar quality to that of living animals, and some of the tusks are of immense size. Holtzapffel says he has seen tusks which were 10 ft. long and weighed 186 lbs. They were solid from their tips to within 6 in. of the larger end, and the ivory was of fine grain and sound texture.—The uses of ivory are very numerous. It is exquisitely smooth in working, altogether devoid of the harsh meagre character of bone, and is in all respects the most suitable material for ornamental turning, as it is capable of receiving the most delicate lines and cutting. The artists of Greece and Rome carved from the tusks of the elephant statues and various works of art, among which those of Phidias are especially famous. The size of some of the statues has led to the opinion that the ancients obtained larger tusks than those of modern times, or that they had a method of softening and flattening out the material, or built it up in plates around a central core. (See Quatremère de Quincy's *Le Jupiter olympien, ou l'art de la sculpture antique*, Paris, 1813.) Ivory was a favorite material for sculpture also in the middle ages, and many beautiful specimens then executed are preserved in museums and private collections. Dieppe in Normandy has been for two centuries the chief seat of this branch of art in modern times. The Chinese possess extraordinary skill in working ivory, carving out of a solid block a number of hollow balls one within another,



all curiously ornamented with various devices. Their chessmen are unequalled in ingenious workmanship. Ivory is largely used for the handles of knives, and for the keys of pianofortes and other musical instruments. Its fine texture and smooth surface recommend it for plates for miniatures; and it is used for a great variety of toys, and of mathematical and other instruments. For drawing scales the material is not found so suitable as box or lance wood, for its dimensions change as it absorbs and gives out atmospheric moisture. Billiard balls are liable to the same difficulty; and as the shrinkage or expansion is greater in the direction of the width of the tusks than in that of their length, the two diameters of the balls are sometimes found to differ materially after they have been made a short time. For this reason they are sometimes roughly shaped and then kept for months in the room in which they are to be used, to acquire the form due to its usual condition as to moisture, when they are finished. Veneers are cut out of the blocks either in straight longitudinal slips, or, by the method first practised by the Russians upon cylindrical blocks of wood, in a spiral sheet, as if this were unrolled from the cylinder submitted to the operation. In the London exhibition of 1851 a veneer of this kind was exhibited in the United States department, a foot wide and 40 ft. long. In Paris they have been cut in strips of 30 by 150 in.; and a pianoforte has been entirely covered with this material. Ivory may be made flexible by immersion in a solution of phosphoric acid of specific gravity 1.13 till it becomes translucent. It hardens on exposure to dry air, but assumes its flexibility when placed in hot water.—Ivory may be dyed black by soaking it in a solution of nitrate of silver and exposing it to the sunlight, or better by boiling for some time in a decoction of logwood and then steeping in a solution of red sulphate or red acetate of iron; blue by immersion in a solution of sulphate of indigo containing potash; green by dipping the blue ivory in a solution of nitro-muriate of tin, and then in a hot decoction of fustic; yellow by first soaking the ivory in a mordant of nitro-muriate of tin and then in a hot decoction of fustic, or better by steeping it for 24 hours in a solution of neutral chromate of potash, and then immersing it in a boiling hot solution of acetate of lead; red by first saturating it with the tin mordant, and then immersing it in a decoction of Brazil wood or cochineal, or a mixture of both. Lac dye will produce a scarlet, and this immersed in a solution of potash will become a cherry red. Violet is produced by mordanting with tin and then treating with a decoction of logwood; if this is placed a short time in a weak solution of nitro-muriatic acid, it will be changed to a beautiful purple red. Ivory may also be dyed with any of the aniline colors.—The imports of ivory, hippopotamus teeth, and narwhal teeth into Great Britain from 1861 to 1871 varied

from 9,290 cwt. to 14,599 cwt. a year.—Various substitutes for ivory have been introduced. The best known is that called vegetable ivory, an albuminous substance formed from a milky fluid in the fruit of a species of palm common in Peru and New Granada, the *phytelephas macrocarpa*. It corresponds to the meat of the coconut, the fruit of another species of palm. When the nuts are perfectly ripe and dry, the kernels are hard like ivory and very white. It answers very well for many small articles instead of the genuine ivory, but is more liable to tarnish, and does not wear so well when exposed to friction. The French preparation known as Pinson's artificial ivory is a compound of gelatine and alumina. Slabs or tablets of gelatine or glue are immersed for some time in a solution of alumina in acetic or sulphuric acid. The alumina separates and becomes incorporated with the glue, and the plates are then removed, dried, and finally polished. Another preparation of artificial ivory is made by working together bone or ivory dust with an equal portion of albumen or gelatine to form a paste, and then rolling this into sheets, and hardening them by drying. Sulphate of barytes finely powdered is used to advantage with one half its quantity of albumen. Tablets thus prepared are used in photography to receive positive pictures.—**IVORY BLACK**, prepared by calcining the shavings and dust of ivory, is ground and levigated on a porphyry slab to produce the beautiful velvety material which is the chief ingredient of the ink used in copperplate printing. (See **BONE BLACK**.)

**IVORY, James**, a Scottish mathematician, born in Dundee in 1765, died near London, Sept 21, 1842. He completed his professional course in theology at the university of St. Andrews in 1786, after which he was a teacher in the academy of Dundee for three years. He was afterward for 15 years superintendent of a flax-spinning factory at Douglstown. Meantime he pursued his mathematical studies, and became known by remarkable memoirs read before the royal society of Edinburgh. In 1804 he was appointed professor of mathematics in the royal military college, then at Marlow, Buckinghamshire. He retired with a pension in 1819, and from that time prosecuted his favorite studies in the vicinity of London. He was a member of the principal learned societies of England and Germany, and in 1831 received an annual pension of £300. His principal writings are papers in the "Transactions" of the royal societies of Edinburgh and London. Three of these were on the attractions of the spheroids, and contained a process of analysis which was acknowledged by Laplace to be superior to his own.

**IVORY COAST**, a part of the coast of Upper Guinea, W. Africa, between the Grain coast and the Gold coast, extending from Cape Palmas to the Assinie river. The coast is low, marshy, and unhealthy, but the country back of it rises into table lands of vast extent and

great fertility. It is drained by a few small rivers, the principal of which are the Lahu, Tabetah, and Cavally. There are a number of small native towns on the coast, among which are Grand Lahu, Jack Lahu, Jack-Jack, and Grand Ivorytown, which has a considerable trade in gold dust, palm oil, and ivory. The French trading station of Grand Bassam has been abandoned since 1870.

**IVREA** (anc. *Eporedia*), a town of Italy, in the province and 30 m. N. E. of the city of Turin; pop. about 10,000. It is walled and fortified, and beautifully situated at the foot of the Alps, at the entrance of the Val d'Aosta, and on the river Dora Baltea, on the opposite side of which is one of the two suburbs. The Gothic cathedral is believed to occupy the site of a temple of Apollo, and several of the parish churches are very old. It is the see of a bishop, and contains an episcopal seminary and various schools. Woollens, cottons, silks, vermicelli, and other articles are manufactured, and there are dye and tile works.—*Eporedia* was a considerable town of Cisalpine Gaul, and the strength of its strategical position, commanding two great passes of the Alps, gave it importance. Ivrea was a marquisate under Charlemagne, which in the 13th century was united with Savoy.

**IVRY-LA-BATAILLE**, a village of France, in the department of Eure and on the river Eure, about 40 m. W. of Paris; pop. about 1,200. It contains the ruins of an ancient castle and renowned manufactories of wind instruments. It passed through many vicissitudes during the wars with England, and Dunois captured it in 1449 and destroyed the fortifications. It is most celebrated for the decisive victory gained on the adjoining plain by Henry IV., March 14, 1590, over the forces of the league under the duke of Mayenne. The obelisk on the site of the battle, pulled down in 1793, was restored by Napoleon in 1809.

**IVRY-SUR-SEINE**, a village of France, on the left bank of the Seine, about a mile from the southern *enceinte* of Paris; pop. in 1866, 10,199. It is pleasantly situated, contains a fine parish church, a terrace of an old palace, a renowned *maison de santé* for lunatics, and extensive wine vaults in natural caves cut in the rocks. There are many handsome villas around it. Vast quantities of wine bottles and many other articles are manufactured here. The fort of Ivry figured conspicuously during the siege of Paris in 1870-'71.

**IVY**, a common name, from the Anglo-Saxon, for species of the genus *hedera* (Celtic *hedra*, a cord) of the *araliaceæ*, a family which is closely related to the *umbellifera*, but different in the structure of its fruit, which has always more than two carpels. The genus *hedera* consists of evergreen climbing shrubs, with simple leaves and the flowers in umbels. Its most familiar representative is the common or English ivy, *H. helix*, a plant which contributes largely to the English landscape, and

around which are clustered so much of poetry and legend. This is found all over Britain, in western and southern Europe, western Asia, and northern Africa, but scarcely at all in central Europe. In its wild state the slender lower branches spread upon the ground, while



English Ivy (*Hedera helix*).

the main stems climb upon trees, buildings, and other supports to a great height, by means of aerial rootlets. The leaves are three- to five-lobed, and of a pleasing dark green color. The plant rarely flowers until it has reached the summit of the support upon which it climbs; it then throws out from the main stem short flowering branches, upon which the leaves are not lobed, like those upon the other stems, but nearly oval; each branch terminates in a sort of panicle of numerous small umbels of yellowish green flowers; these open in early autumn; they are fragrant, and very attractive to bees; the berries, which are black, ripen the following spring. The ivy climbs to the tops of the tallest trees and surmounts the highest buildings; the largest specimens in England have trunks 10 to 11½ in. in diameter; it is a very long-lived plant. Ivy formerly enjoyed some medicinal reputation, but it is scarcely used at present; the berries, which to man are emetic and cathartic, are readily eaten by various birds; in warm climates it exudes an aromatic, resinous matter, said to possess stimulant properties. In England the ivy naturally clothes ruins, old trees, and rocky places, and thus forms a prominent feature in the landscape; but besides this it is largely used in gardening, it being employed to cover buildings, to form evergreen walls, and to make screens to hide unsightly objects. In this country ivy cannot be considered as certainly hardy north of Philadelphia; in the sheltered streets of cities like New York it has sometimes attained a large size, to be destroyed by an unusually severe winter; it is not only the severity of the winters at its northern limit

makes it difficult of cultivation, but the rays of the sun in the latter part of winter have an injurious effect upon it; hence it is best upon the northern sides of buildings. In Virginia the plant flourishes luxuriantly and some fine specimens may be found upon the old mansions of that state. Modern gardening ivy has been introduced as a climbing plant; it is grown with its stems in pots, and as these take root at every joint it forms a mat of its peculiar dark green foliage which is readily produced; it is used in the borders and broad edgings to flower beds cut in the lawn as well as to form beds by itself; its dark green contrasted with the light green grass produces a fine effect. In the United States, however, the great use of ivy is for indoor decoration, for which purpose it is well adapted. It is made to run over window sashes, over the arch of folding doors, along the walls, around picture frames, or wherever it may be desired. It is also used to form a screen, either for windows or for use in various parts of the room; a trellis of the desired kind is fixed to a platform, upon which the plants stand in pots or in a suitable box. The propagation is the easiest, and for after only care and patience are required. Cuttings may be rooted in the usual way in a branch several feet long may be made to strike root by surrounding its lower end several inches with a ball of sphagnum moss which is to be tied on. The ball is placed in a jar or other convenient receptacle in which it can be kept constantly moist; when roots have formed, it may then be set in a pot of earth. Ivy requires a rich soil, and it is growing an abundance of water. The principal care it needs, besides proper watering, is the washing of the foliage; dust settles upon the leaves, and must be removed from time to time by means of a damp cloth.

It is sometimes attacked by a scale which upon its first appearance should be removed by a blunt knife or other mechanical means. In summer most of the interior decorations are taken outdoors to a partly shaded spot, but those which are very large remain in place and receive proper care of light, water, and cleanliness.—The English presents many varieties, differing in color and form of the leaf, depth of green, and fruit, &c.; notable among these are the ivy with the foliage beautifully marked with red, or veined with white and yellow, as gold and silver ivies, all of which are beautiful, but in this country can only be kept under glass. What is known as the climbing ivy is propagated from the flowering stems, which ultimately forms climbing stems. The ivy, so called, is really a native of the Canary Islands (*H. Canariense*), and has much larger leaves than the common. These two are all varieties recognized by the late Berthold in an elaborate memoir ("Journal of Botany" vol. ii.) on the genus; and while the

catalogues and works on gardening enumerate scores of species, they are believed to be all reducible to these two. Mr. Shirley Hibbard in 1869, in a communication to the Linnæan society, and later in a work entitled "Ivy, its History and Characteristics" (London, 1873),



Variegated-leaved Ivy.

ignoring all former names, has attempted to arrange the garden forms of ivy, and impose a nomenclature which is not likely to be generally adopted.—Among other plants to which the name ivy has been applied are German ivy, a climbing composite (see GERMAN IVY); Colosseum ivy (*Linaria cymbalaria*), a small creeping toad flax; ground ivy (*Nepeta Glechoma*), a prostrate European labiate, which is not rare as a weed in the older portions of this country, and which before the introduction of hops was used in England to give bitterness to beer, and is also called alehoof; American ivy, more generally known as the Virginia creeper (*Ampelopsis quinquefolia*), which, though a deciduous plant, occupies much the same place in our vegetation that the ivy does in Europe; and poison ivy, a name which with several others is applied to the well known *Rhus Toxicodendron*, for which see ΣΥΜΑΧΗ.

**IXION**, a mythical Thessalian prince, king of the Lapithæ, and father of Pirithous. When Deioneus, whose daughter Dia he had espoused, demanded of him the customary bridal gifts, Ixion treacherously invited him to a banquet, and then had him cast into a fiery pit. None would hold intercourse with the murderer, or purify him, till Jupiter at length performed the necessary rite, and made him his guest. But Ixion presumed to make love to Juno, whereupon Jupiter made a phantom resembling her, by which Ixion became the progenitor of the centaurs. For his impiety he was chained by Mercury to a wheel which revolved perpetually in the air.

**IXTLILXOCHITL**, *Fernando de Alva*, an Indian historian, descended in a direct line from the kings of Tezcuco in Mexico, born about 1568, died about 1648. He was interpreter of the native languages to the viceroys of Mexico, and assiduously collected the ancient MSS. and traditions of his country, which he embodied in a

series of memoirs or "Relations." His most important work is a "History of the Chichimecas," which, with most of his other writings, was first printed from the MSS. in Mexico by Lord Kingsborough ("Mexican Antiquities," vol. ix.). His works evince a disposition to overestimate the power and policy of the Tezcucan kings, but are nevertheless interesting, and on the whole trustworthy.

**IZABAL**, a seaport of Guatemala, in the department and 123 m. N. E. of the city of Guatemala, on the S. shore of Lake Dulce; pop. about 600. It is a miserable place of about 150 houses, and owes its importance to its being the sole Atlantic port for the trade of the capital. The water being very shallow on the bar at the mouth of the river leading from the gulf to the sea, only vessels of light draught can go up to the town. Large vessels go to Balize, and the merchandise is transmitted by coasting craft to Izabal.

**IZALCO**, a volcano of the republic and 36 m. N. W. of the city of San Salvador, in lat. 13° 15' N., lon. 89° 44' W. It is one of the most curious volcanoes, and except Jorullo in Mexico the only one in the world that has risen from the level of the plain within the memory of man. A priest of Sonsonate, an eye-witness of its origin, related to Mr. Stephens the history and progress of its formation. In 1798, after a series of destructive earthquakes, dust and pebbles were observed rising from a fissure in the plain; soon after lava was upheaved, and this, together with large stones and other substances, gradually accumulated around the orifice until the vast isolated cone as it now stands was formed. It is contiguous to another mountain sufficiently elevated to afford from its crest a distinct view of the burning crater of the volcano; and the lurid flames and never-ending shower of incandescent stones issuing from it are clearly visible from Sonsonate, near by. Izalco is supposed to have had its origin from a deviation of the subterranean fire which animated the neighboring system of extinct volcanoes clustered around the great peak of Santa Ana. The eruptions, though incessant, are somewhat intermittent in regard to violence, and have often been disastrous to the adjacent town of Izalco. Dense columns of smoke are constantly emitted, and detonations like the rumblings of distant thunder are regularly repeated at intervals of from 5 to 15 minutes. Vegetation is of course impossible on the brown arid flanks of the mountain, down which streams of liquid fire are occasionally seen to roll, offering a spectacle of terrific grandeur, especially by night. Its height at present is estimated at about 6,000 ft.; and,

though some 40 m. from the coast, it serves as a convenient landmark for mariners, among whom it is sometimes designated *el faro del Salvador*.

**IZALCO**, a town of San Salvador, Central America, situated near the base of the preceding volcano, 36 m. N. W. of the city of San Salvador; pop. 5,000, chiefly Indians. It was once the centre of the most important cacao district in all America, and still preserves many evidences of past importance. Its fine large church was nearly destroyed by the earthquake of Dec. 8, 1859. The country around it is remarkably fertile and well watered.

**IZARD**, a N. county of Arkansas, drained by White river, which is here navigable; area, 864 sq. m.; pop. in 1870, 6,806, of whom 183 were colored. It has an uneven surface and a fertile soil. The chief productions in 1870 were 20,076 bushels of wheat, 303,242 of Indian corn, 17,358 of oats, 11,107 of Irish potatoes, 13,435 of sweet potatoes, 24,975 lbs. of tobacco, 92,686 of butter, 10,496 gallons of molasses, and 1,568 bales of cotton. There were 2,293 horses, 2,501 milch cows, 1,333 working oxen, 3,281 other cattle, 4,413 sheep, and 17,276 swine. Capital, Mount Olive.

**IZARD**, Ralph, an American statesman, born near Charleston, S. C., in 1742, died at South Bay, May 30, 1804. He was educated at Cambridge, England, inherited an ample fortune, and in 1771 settled in London, from whence the troubled condition of American politics induced him in 1774 to retire to the continent. He subsequently endeavored to impress upon the British ministry the ill-advised nature of the course they were pursuing, but without effect. In 1780 he returned to the United States, where he was instrumental in procuring the appointment of Gen. Greene to the command of the southern army. He also pledged his whole estate as security for funds needed in the purchase of ships of war in Europe. In 1781 he entered the continental congress; and upon the adoption of the federal constitution he was elected a United States senator from South Carolina. The "Correspondence of Ralph Izard from 1774 to 1804, with a Short Memoir," was published by his daughter (Boston, 1844).

**IZTACIHUATL**, a volcano of Mexico, 15,705 ft. above the sea, not far from that of Popocatepetl, near the city of Puebla. It is sometimes called the Sierra Nevada, its top being almost always covered with snow. Its name is aboriginal Mexican, from *istac*, white, and *cihuatl*, woman, suggested by its fancied resemblance to a woman in a white dress. It has not been active since the conquest.

th letter of most European alphabets; a spurious counterpart of the letter also called the consonant of that ling that function of the original it precedes another vowel. This, the case only where it sounds like *r* in some European languages it superfetation of other legitimate representative of sounds which *z* in common with that of its prot is in German miscalled *Jot* (pronounced *iära*). The following are the which it is uttered in various languages consonant *I* in Italian, German, other Teutonic languages, in Luth, Magyar, &c., where the Czechs the Spaniards and English *y*, before instance: Ital. *ajuto* or *aiuto*, aid; oke, *ja*, yes; Lusat. and Pol. *jeden* (en), one; Magyar *jég*, ice, &c. 2. and Portuguese *J*, a lingui-dental weak and sonorous counterpart of *j*, like the sound of *s* and *z* in the ds *pleasure*, *grazier*, and rendered ination *zh* in English. This sound en with *g* before *e* and *i* in Portuguese. It exists in Russian, Polish Slavic languages, in Persian, but not in Sanskrit, Greek, Lat-Arabic, Ethiopian, Irish, German, other languages. 3. The English represents the preceding intimate with that of *d*, equivalent to *dzh*; *dj* in French and *dsch* in German is of oriental names. This consonant is also written in English with *g* and *y*, in Italian with *g* before *e* exists in many eastern languages, sh, but is unknown in the ancient Hebrew, Ethiopic, and Irish, as German, French, and most other European languages. 4. In Spanish it is sounded man *ch*, as in *jóven*, young, and t to *g* before *e* and *i*, and to *x* in so that Mexico is also written *México*.—The use of the tailed or elongated *I* introduced by Dutch printers, and called *I hollandais* by French printers the same relation to *I* that the to *V*. (See *I*.)

large wading bird of the stork order in South America and Africa, of *Mycteria* (Linn.). The bill is about half long, and strong, resembling stork except that it is bent a little the point. It is a large bird, measured 5 and 6 ft. in length; the wings ample, with the second and third t; tail moderate and broad; tarsi than the middle toe, and covered

with reticulated scales; the toes are long, united at their bases, with most of the hind toe resting on the ground. Only two species are described by Gray, of which the best known is the American jabiru (*M. Americana*, Linn.); in this the bill is black, the head and about two thirds of the neck bare and blackish, and the lower part of the neck bright red; there are a few white feathers on the hind head, and the rest of the plumage is white. It inhabits Brazil and Guiana, frequenting swamps, seeking for fish and reptiles; it rises slowly to a great height, supporting itself for a very long time. The nest is made on lofty trees, and the eggs are generally two; the young are fed with fish; the flesh of the young is tender and tolerably



Jabiru (*Mycteria Senegalensis*).

good eating. The African species (*M. Senegalensis*, Shaw) is an equally large bird, generally white, with head, neck, and scapulars black; it has two pendent wattles at the base of the bill.

**JABLONSKI**, Paul Ernst, a German orientalist, born in Berlin in 1698, died in Frankfort-on-the-Oder, Sept. 18, 1757. He was professor of theology at the university of Frankfort, and head minister of the Calvinistic church in that city. He published at least 50 different works on oriental philology, history, divinity, and antiquities, the most important of which is his *Pantheon Aegyptiorum, sive de Diis eorum Commentarius, cum Prolegomenis de Religione et Theologia Aegyptiorum* (3 vols., 1750-'52).

**JACAMAR**, a diurnal fissirostral bird of the kingfisher family, and subfamily *galbulina*, comprising the two genera *galbula* (Möhr.) and *jacamerops* (Cuv.) The plumage is brilliant, green predominating, and the habitat is tropical South America and some of the West Indian islands. In the genus *galbula* the bill is

long, slender, straight, pointed, and four-sided; the wings are moderate and rounded, with the fourth quill longest; tail elongated and graduated; tarsi very short, slender, and nearly covered with feathers; the toes two before and two behind, the inner hind one very small (in



Jacamar (*Galbula viridis*).

some species wanting), and the outer anterior one the longest. About ten species are described, inhabiting the moist forests, and leading a solitary life; they perch on naked branches, whence they dart in pursuit of insects, in the manner of the bee-eaters; some species are said to feed on fish and their fry. The nest is a hole in a tree or a river bank, with a small entrance, and the eggs are usually three in number. The green jacamar (*G. viridis*, Lath.) is about the size of a lark, of a brilliant glossy green, with white chin and rufous abdomen; the paradise jacamar (*G. paradisea*, Linn.), with the same metallic green color, has a violet-brown head, and white throat, front neck, and under wing coverts. In *jacamerops* the bill is shorter, broader, and more curved, more like that of the bee-eaters. The species are few, inhabiting tropical South America, with habits similar to those of the preceding genus. The great jacamar (*J. grandis*, Gmel.) is about 11 in. long, of a coppery green above, and beneath ferruginous.

**JACANA**, a wading bird of the family *palamedidae*, and subfamily *parrinae*, of which the principal genus is *purra* (Linn.), found in the warmer parts of America, Asia, and Africa. The bill is long, slender, straight at the base, and vaulted at the tip; the base of the bill has a large, naked, dilated plate, standing up in front of the forehead; wings long, the third quill the longest; tail very short, partly concealed by the coverts; tarsi long, naked, and slender, with transverse scales. The most remarkable peculiarity is the great length of the toes, four in number, entirely separated, and all armed with long, straight, and sharp claws; that of the hind toe in the common species is

so acute and long as to obtain for the bird the name of "surgeon;" in some the naked plates about the bill descend toward the neck. These birds frequent marshes, the sides of rivers, and ponds, in pairs or in small flocks; they are shy, when alarmed diving or skulking among the reeds; by the length of their toes they are enabled to walk upon the floating leaves of water plants, in search of aquatic insects, buds, and seeds; they are quarrelsome and noisy, striking each other with their spurred wings; the flight is rapid, straight, and not very elevated; they wade into the water as far as the knees, but do not swim, as their feet are not webbed; they are monogamous, the females making a nest among the reeds, and depositing four or five eggs. More than a dozen species are described, of which the best known are the chestnut jacana (*P. jacana*, Linn.), black with a red mantle, with the primaries green, a native of South America; the Indian jacana (*P. Indica*, Lath.), blackish with blue and violet reflections, bronzed green mantle, rump and tail sanguine red, anterior quills green, and a white stripe behind the eye; and the African jacana (*P. Africana*, Gmel.), with wings unarmed, and forehead not carunculated and greenish black. They are about 10 in. long. The genus *Hydrophasianus* (Wagl.) has very long wings, with the shafts of the first three quills prolonged, and the ends of the fourth to the seventh lengthened, narrowed, and falcated; the tail narrowed, with the four central feathers much prolonged and the lateral ones short and graduated; the base of the bill and head entirely covered with feathers. To this genus belongs the Chinese jacana (*H. Sinensis*, Gmel.), which is the only



Chestnut Jacana (*Purra jacana*).

species described by Gray; the habits are the same as in the preceding genus. The general color is brown, with the head, throat, front part of the neck, and wing coverts white; hind neck with golden silky plumes; the long tail feathers black.

**JACHMANN, Edward Karl Emanuel**, a German naval officer, born in Dantzic, March 2, 1822. He rose from the most inferior station to be one of the directors in 1857-'9 of the newly established Prussian admiralty, and commander of an expedition to China in 1862. In March, 1864, he defeated the Danes at Jasmund on the island of Rügen. In 1867 he became chief of the ministry of marine, and in 1868 vice admiral, and contributed greatly to the organization and efficiency of the service. During the Franco-German war (1870-'71) he was commander-in-chief of the Baltic fleet; and on Dec. 31, 1871, he was placed at the head of the imperial navy.

**JACK**, a N. W. county of Texas, intersected by the W. fork of Trinity river; area, 870 sq. m.; pop. in 1870, 694, of whom 72 were colored. It lies chiefly in the "cross timbers," and has great diversity of surface and soil. Stock raising is the chief industry, though there is some excellent farming land. The chief productions in 1870 were 6,750 bushels of Indian corn, 3,620 of oats, and 176 tons of hay. The value of live stock was \$15,925. Capital, Jackshoro.

**JACKAL**, a species of wild dog, living in troops in the warmer parts of Asia and Africa, generally placed in the genus *canis* of authors, but raised to a genus of its own (*scalius*) by Hamilton Smith. These animals live under great varieties of climate, in the moist jungles of Asia, the dry deserts of northern Africa, in forest and plain, and wherever the warmth is sufficient; like other dogs, they are voracious, feeding with avidity even on decomposing matter, and in this way, with the hyena and vulture, are of considerable advantage to man in hot climates. They are generally harmless, but make night hideous by their dismal howlings; they dwell in burrows which they excavate themselves, and in caves; they are said to disinter dead bodies, and occasionally when pressed by hunger to attack man. Though exceedingly timid, they are easily tamed, and rarely snarl at the hand which caresses them; this character gives great probability to the opinion that the jackal has mingled its blood in many of the races of our domestic dog, though perhaps not to the assertion of Pallas that it is the chief original of this useful animal. The organization of the jackal does not differ from that of the dog, and the habits of digging, living and hunting in troops, and feeding on carcases are the same in both in the wild state; the former, at least in some of the species, possesses a disagreeable odor from which the latter is free. The pupil of the eye is round, as in the diurnal canines; the nostrils open on the end of the muzzle; the ears are pointed, with a tubercle on the external edge; the tongue is very soft, and the upper lip and sides of face provided with bristly whiskers; the feet are four-toed, with a rudiment of a fifth on the anterior on the inner side, and the nails are short and thick; the dentition, habits, movements, and

instincts are those of the dog; the hair is thick, the tail being nearly as bushy as that of a fox. The jackal is often seen in attendance on the lion, and has been supposed to run down animals for him, contented with a small share for itself; but it follows for the sake of the



Common Jackal (*Canis aureus*).

pickings and stealings in the train of the lion, who perhaps is often led to his prey by the howlings of a troop of jackals hunting for themselves. The common jackal or jungle koola of India (*canis aureus*, Linn.) is of the size of a small dog, reddish gray above, darkest on the back, and lighter beneath; the tail is bushy and dark at the end. It inhabits the warmer parts of S. Asia, N. Africa, and S. E. Europe. The African jackal or dieb (*C. anthus*, F. Cuv.) is of a yellowish gray above, lighter beneath; the tail yellow, with a longitudinal black line at the base, and some black hairs at the tip. It is found in Egypt, Nubia, Senegal, and other parts of Africa. The average height of the jackal is about 15 in., the length of the body 14 in., and of the tail about 10 in. The above species have been known to breed together, producing five young after a gestation of about 60 days; and they will also intermix with domesticated dogs; in fact, the agency of the jackal in the production of the southern dogs can no more be doubted than that of the wolf in the case of the northern, and the crossings of these jackal dogs and wolf dogs, either by accident or design, would explain satisfactorily a great number of our domestic varieties. (See Dog.)

**JACKDAW**, a European coriostrial bird of the crow family, and genus *corvus* (*C. monedula*, Linn.). The form is more compact and graceful than that of any other British corvine bird; of about the size of the domestic pigeon, with large head, short neck, ovate body, and moderate wings, tail, and feet; the bill is shorter than the head, stout and conical, slightly arched, and sharp-edged; the gape almost straight;

the plumage full and soft; the tail straight, of 12 broad, rounded feathers; claws arched and strong. The length is about 15 in., the bill  $1\frac{1}{4}$ , and the alar extent 30 in.; the female is slightly smaller. The bill and feet are black, irides grayish white, upper and fore part of the head



Jackdaw (*Corvus monedula*)

black with bluish purple reflections; grayish black about the eyes and throat; back and sides of neck bluish gray; rest of plumage grayish black, approaching leaden gray on the under parts; wings and tail black, the latter with the primaries glossed with green, and the secondaries with purple. In rare instances, individuals have been found variegated with white. It is a very active, impertinent, playful, and loquacious bird, altogether the most agreeable and sociable of the crows. The flight is rapid, very irregular, and generally accompanied with frequent cries. It dwells in ruined buildings, towers, steeples, and retreats in high rocks, and is often found in the heart of large cities; it nestles in the same places, and occasionally in chimneys, making a large nest, and laying about five bluish white eggs with brown or pale purple spots at the larger end,  $1\frac{1}{4}$  by 1 in.; the eggs are laid in May, and the young are abroad by the end of June. Sallying from their retreats at early dawn, they betake themselves to the fields in search of worms, larvae, and insects, walking about gracefully, but frequently quarrelling; they also eat mollusks, crustacea, fishes, and even carrion; when feeding, they are very vigilant; they pick up food from the streets with the rooks and pigeons, and possess the corvine propensity to carry to their nests all kinds of objects which can serve for their structures, and to steal shining articles of value; they may be taught many tricks, and to pronounce words. They inhabit Great Britain and most parts of the European continent; species in Asia are very nearly allied to this, both in appearance and habits.

**JACKSON**, the name of 20 counties in the United States. I. A W. county of West Vir-

ginia, separated from Ohio by the Ohio river, and drained by Sandy and Big Mill creeks; area, 480 sq. m.; pop. in 1870, 10,300, of whom 58 were colored. It has a diversified surface; the soil near the rivers is fertile, and elsewhere well adapted to grazing. The chief productions in 1870 were 59,845 bushels of wheat, 272,044 of Indian corn, 48,524 of oats, 50,397 of potatoes, 96,265 lbs. of tobacco, 29,830 of wool, 87,052 of butter, and 2,934 tons of hay. There were 2,558 horses, 2,289 milch cows, 3,644 other cattle, 13,610 sheep, and 8,821 swine; 2 manufactories of woollen goods, 1 of boats, 7 of cooperage, 3 flour mills, and 7 saw mills. Capital, Ripley. II. A S. W. county of North Carolina, bordering on South Carolina, and drained by head waters of the Tennessee and Savannah rivers; area, about 730 sq. m.; pop. in 1870, 6,683, of whom 274 were colored. The Blue Ridge occupies its S. E. frontier, and the surface is generally mountainous. Since the census a portion has been taken to form Swain co. The chief productions in 1870 were 18,560 bushels of wheat, 9,167 of rye, 156,050 of Indian corn, 10,668 of oats, 13,235 of Irish and 7,116 of sweet potatoes, 11,697 lbs. of tobacco, 10,634 of wool, 64,032 of butter, and 11,571 of honey. There were 1,022 horses, 2,136 milch cows, 3,422 other cattle, 5,028 sheep, and 8,152 swine. Capital, Webster. III. A N. county of Georgia, drained by the head waters of Oconee river; area, 433 sq. m.; pop. in 1870, 11,181, of whom 3,719 were colored. It is a hilly and not very fertile district, abounding in granite and quartz, and containing some iron ore. The chief productions in 1870 were 85,200 bushels of wheat, 218,780 of Indian corn, 25,990 of oats, 10,436 of sweet potatoes, 56,115 lbs. of butter, and 1,825 bales of cotton. There were 1,143 horses, 663 mules and asses, 1,904 milch cows, 3,023 other cattle, 6,379 sheep, and 8,141 swine. Capital, Jefferson. IV. A N. W. county of Florida, bordering on Georgia, and separated from Alabama on the E. by the Chattahoochee river, which unites with the Flint to form the Appalachicola on the S. E. border; area, 1,040 sq. m.; pop. in 1870, 9,528, of whom 5,596 were colored. It is intersected by the Chipola river, and has a level surface, partly covered with pine forests. The soil near the streams is very fertile. The chief productions in 1870 were 150,780 bushels of Indian corn, 26,005 of sweet potatoes, 27,973 gallons of molasses, 39,280 lbs. of rice, and 3,391 bales of cotton. There were 440 horses, 516 mules and asses, 1,974 milch cows, 4,340 other cattle, 1,439 sheep, and 6,097 swine. Capital, Marianna. V. A N. E. county of Alabama, bordering on Tennessee, and intersected by Tennessee river; area estimated at 975 sq. m.; pop. in 1870, 19,410, of whom 3,060 were colored. It is mountainous, and the soil, drained by numerous streams, is generally fertile. The Nashville and Chattanooga and Jasper branch, and the Memphis and Charleston railroads traverse



it. The chief productions in 1870 were 50,925 bushels of wheat, 506,777 of Indian corn, 26,952 of oats, 11,107 lbs. of tobacco, 16,809 of wool, 121,075 of butter, 24,547 of honey, and 2,389 bales of cotton. There were 3,541 horses, 3,737 milch cows, 2,062 working oxen, 6,145 other cattle, 9,745 sheep, and 25,887 swine; 3 flour mills, 6 tanning and currying establishments, and 6 saw mills. Capital, Bellefonte. VI. A S. E. county of Mississippi, bordering on Alabama and the gulf of Mexico, and intersected by Pascagoula river; area, 1,175 sq. m.; pop. in 1870, 4,362, of whom 1,194 were colored. The soil is sandy and not fertile, and pine forests cover a large part of the surface. The New Orleans, Mobile, and Texas railroad crosses it. The chief productions in 1870 were 5,377 bushels of Indian corn, 9,460 of sweet potatoes, 11,058 lbs. of wool, and 18,970 of rice. The value of live stock was \$57,790. Capital, Americus. VII. A N. parish of Louisiana, drained by branches of Washita and Little rivers; area, 550 sq. m.; pop. in 1870, 7,646, of whom 3,443 were colored. It has a moderately uneven surface, and a soil generally of good quality. The chief productions in 1870 were 132,224 bushels of Indian corn, 29,608 of sweet potatoes, and 4,097 bales of cotton. There were 912 horses, 729 mules and asses, 1,955 milch cows, 5,764 other cattle, 3,192 sheep, and 12,370 swine. Capital, Vernon. VIII. A S. county of Texas, bordering on Lavaca bay, and drained by Lavaca river and other streams; area, 852 sq. m.; pop. in 1870, 2,278, of whom 1,164 were colored. The surface is level and occupied chiefly by prairies, although there are undulating timber lands near the rivers. The soil is fertile and suited to sugar cane. The chief productions in 1870 were 36,125 bushels of Indian corn, 6,770 of sweet potatoes, and 595 bales of cotton. There were 956 horses, 708 milch cows, 13,846 other cattle, 977 sheep, and 2,694 swine. Capital, Texana. IX. A N. E. county of Arkansas, bounded W. by Black and White rivers; area, about 600 sq. m.; pop. in 1870, 7,268, of whom 1,612 were colored. It has a level surface, covered in many places with valuable ash and cypress timber, and a fertile soil. The Cairo and Fulton railroad passes through it. The chief productions in 1870 were 115,215 bushels of Indian corn, 50,395 lbs. of butter, and 8,996 bales of cotton. There were 890 horses, 1,386 milch cows, 2,853 other cattle, and 7,042 swine. Capital, Jacksonport. X. A N. county of Tennessee, bordering on Kentucky, and intersected by Cumberland river; area, 666 sq. m.; pop. in 1870, 12,583, of whom 767 were colored. The surface is much diversified. The chief productions in 1870 were 33,046 bushels of wheat, 530,276 of Indian corn, 54,314 of oats, 713,578 lbs. of tobacco, 26,311 of wool, 88,542 of butter, and 4,213 tons of hay. There were 2,984 horses, 2,780 milch cows, 2,040 working oxen, 3,751 other cattle, 15,323 sheep, and 29,120 swine. Capital, Gainesborough. XI. A

S. E. central county of Kentucky, drained by the sources of Rock Castle river and by an affluent of the Kentucky; area, about 425 sq. m.; pop. in 1870, 4,547, of whom 51 were colored. The surface is hilly. The chief productions in 1870 were 4,537 bushels of wheat, 137,181 of Indian corn, 14,361 of oats, 11,141 of potatoes, and 51,540 lbs. of butter. There were 774 horses, 1,124 milch cows, 1,579 other cattle, 5,730 sheep, and 6,748 swine. Capital, McKee. XII. A S. county of Ohio, drained by Little Scioto river; area, 400 sq. m.; pop. in 1870, 21,759. It is rich in coal, iron, marble, and salt. The surface is hilly, and the soil fertile. The Marietta and Cincinnati railroad and Portsmouth branch pass through it. The chief productions in 1870 were 90,127 bushels of wheat, 469,920 of Indian corn, 119,534 of oats, 53,637 of potatoes, 69,162 lbs. of wool, 390,898 of butter, and 15,879 tons of hay. There were 4,294 horses, 4,490 milch cows, 9,698 other cattle, 24,439 sheep, and 11,693 swine; 4 manufactories of charcoal, 13 of pig iron, 1 of woollen goods, 5 flour mills, and 7 saw mills. Capital, Jackson. XIII. A S. county of Indiana, drained by the E. fork of White river; area, 544 sq. m.; pop. in 1870, 18,974. It has a level or undulating surface, and contains beds of iron ore. The soils are of various qualities, some parts of the country being very fertile. The Ohio and Mississippi, and the Jeffersonville, Madison, and Indianapolis railroads pass through it. The chief productions in 1870 were 191,477 bushels of wheat, 861,520 of Indian corn, 143,737 of oats, 65,894 of potatoes, 47,648 lbs. of wool, 259,181 of butter, and 8,307 tons of hay. There were 5,842 horses, 944 mules and asses, 4,821 milch cows, 6,918 other cattle, 18,604 sheep, and 34,738 swine; 13 carriage factories, 2 woollen factories, 9 tanneries, 8 currying establishments, 5 flour mills, 2 planing mills, and 24 saw mills. Capital, Brownstown. XIV. A S. W. county of Illinois, separated from Missouri by the Mississippi river, and drained by Big Muddy river; area, 576 sq. m.; pop. in 1870, 19,634. It contains extensive coal beds and several salt springs. The surface is uneven, and diversified by prairies and timber lands. The Illinois Central, the Grand Tower and Carbondale, and the Carbondale and Shawneetown railroads traverse it. The chief productions in 1870 were 329,926 bushels of wheat, 611,951 of Indian corn, 149,931 of oats, 68,481 of potatoes, 61,717 lbs. of tobacco, 20,326 of wool, 167,834 of butter, 134 bales of cotton, and 4,353 tons of hay. There were 4,429 horses, 1,034 mules and asses, 3,280 milch cows, 4,631 other cattle, 9,011 sheep, and 26,438 swine; 2 manufactories of boxes, 3 of brick, 1 of cars, 1 of iron castings, 8 of tin, copper, and sheet-iron ware, 1 of patterns and models, 1 of sash, doors, and blinds, 1 woollen factory, 1 railroad repair shop, 4 flour mills, and 9 saw mills. Capital, Murphysborough. XV. A S. county of Michigan, drained by the head waters of Grand, Kalamazoo, and Raisin rivers; area,

720 sq. m.; pop. in 1870, 36,047. The surface is undulating and diversified by many small lakes. The soil is a good sandy loam. It contains bituminous coal, iron, limestone, and sandstone. The Michigan Central railroad and the Jackson, Lansing, and Saginaw, the Grand River Valley, and the Air-Line divisions of the same, the Jackson branch of the Michigan Southern railroad, the Fort Wayne, Jackson, and Saginaw, and the Detroit, Hillsdale, and Indiana railroads traverse it. The chief productions in 1870 were 825,505 bushels of wheat, 759,146 of Indian corn, 239,021 of oats, 62,546 of barley, 401,558 of potatoes, 616,238 lbs. of wool, 1,021,831 of butter, 32,955 of cheese, and 62,090 tons of hay. There were 10,201 horses, 8,946 milch cows, 10,623 other cattle, 130,289 sheep, and 15,879 swine; 6 manufactories of agricultural implements, 4 of boots and shoes, 6 of brick, 14 of carriages, 13 of clothing, 8 of cooperage, 1 of drain pipe, 1 of drugs and chemicals, 6 of furniture, 5 of iron castings, 2 of curried leather, 1 of morocco, 1 of engines and boilers, 9 of saddlery and harness, 5 of sash, doors, and blinds, 2 of stone and earthenware, 7 of tin, copper, and sheet-iron ware, 3 planing mills, 4 saw mills, and 11 flour mills. Capital, Jackson. XVI. A S. W. county of Minnesota, bordering on Iowa, intersected by the Des Moines river, and drained by the Changuska, an affluent of the Blue Earth; area, 720 sq. m.; pop. in 1870, 1,825. It contains several lakes, the largest of which is Heron lake. The surface is undulating and the soil fertile. The Sioux City and St. Paul railroad crosses the N. W. part. The chief productions in 1870 were 24,150 bushels of wheat, 6,405 of Indian corn, 24,366 of oats, 7,637 of potatoes, 35,510 lbs. of butter, and 4,263 tons of hay. There were 237 horses, 469 milch cows, 740 other cattle, 413 sheep, and 251 swine. Capital, Jackson. XVII. An E. county of Iowa, separated from Illinois by the Mississippi river; area, 628 sq. m.; pop. in 1870, 22,619. It contains valuable mines of lead and iron, is well watered, fertile, and well timbered, and has an uneven surface. The Sabula, Ackley, and Dakota railroad skirts the S. border, and the Maquoketa branch of the Davenport and St. Paul line terminates in it. The chief productions in 1870 were 429,515 bushels of wheat, 1,485,250 of Indian corn, 807,511 of oats, 168,701 of potatoes, 42,060 lbs. of wool, 724,366 of butter, 77,750 of cheese, and 33,742 tons of hay. There were 8,043 horses, 9,991 milch cows, 16,554 other cattle, 10,672 sheep, and 34,667 swine; 24 manufactories of carriages, 8 of furniture, 24 of cooperage, 12 of saddlery and harness, 4 of woollen goods, 1 pork-packing establishment, 2 breweries, 14 saw mills, and 9 flour mills. Capital, Bellevue. XVIII. A W. county of Missouri, bordering on Kansas, and bounded N. by the Missouri river, which receives the Kansas at its N. W. extremity; area, 525 sq. m.; pop. in 1870, 55,041, of whom 5,223 were colored. The surface is moderately uneven. Lime-

stone is the principal rock. The soil is well watered and very fertile. The Pacific railroad of Missouri crosses it, and several other lines terminate at Kansas City within its limits. The chief productions in 1870 were 312,084 bushels of wheat, 1,504,489 of Indian corn, 173,229 of oats, 91,419 of potatoes, 70,312 lbs. of tobacco, 237,623 of butter, and 2,373 tons of hay. There were 6,961 horses, 1,703 mules and asses, 5,294 milch cows, 9,162 other cattle, 11,016 sheep, and 30,227 swine; 9 manufactories of boots and shoes, 7 of brick, 24 of carriages, 23 of clothing, 4 of confectionery, 17 of furniture, 1 of hosiery, 3 of iron castings, 1 of machinery, 9 of marble and stone work, 17 of saddlery and harness, 4 of sash, doors, and blinds, 1 of scales, 25 of tin, copper, and sheet-iron ware, 4 of tobacco and snuff, 14 of cigars, 7 of upholstery, 5 breweries, 14 flour mills, 4 saw mills, 4 establishments for packing beef, and 4 for packing pork. Capital, Independence. XIX. A N. E. county of Kansas, drained by Grasshopper river, Soldier creek, and other affluents of the Kansas; area, 556 sq. m.; pop. in 1870, 6,053. The surface is diversified, the soil fertile. The Central branch of the Union Pacific railroad passes through it. The chief productions in 1870 were 51,568 bushels of wheat, 486,940 of Indian corn, 137,894 of oats, 52,497 of potatoes, 145,696 lbs. of butter, and 16,273 tons of hay. There were 3,484 horses, 3,349 milch cows, 5,826 other cattle, 2,857 sheep, and 4,622 swine. Capital, Holton. XX. A S. county of Oregon, bounded S. by California, and traversed by the Cascade mountains; area, 11,000 sq. m.; pop. in 1870, 4,778, of whom 634 were Chinese. Rogue river drains the W. portion; E. of the Cascade range are numerous lakes, containing the head waters of Klamath river. The soil in the west is fertile; much of the E. portion is desert. The surface is much diversified, and there is a great variety of climate. Water power is abundant. Gold has been found on Jackson creek. The chief productions in 1870 were 15,226 bushels of wheat, 6,000 of Indian corn, 47,600 of oats, 8,020 of barley, and 1,814 tons of hay. There were 1,404 horses, 1,007 milch cows, 2,509 other cattle, 2,108 sheep, and 5,772 swine; 2 flour mills, and 1 woollen factory. Capital, Jacksonville.

**JACKSON**, a city and the county seat of Jackson co., Michigan, on both banks of Grand river, near its source, 74 m. W. of Detroit and 36 m. S. by E. of Lansing; pop. in 1850, 2,363; in 1860, 4,799; in 1870, 11,447, of whom 2,448 were foreigners. It is lighted with gas, and has paved streets, water works on the Holly system, and an efficient police force. There are two fine hotels and many excellent business structures. Several of the churches are handsome edifices, and the two union school houses are large and well arranged. An iron bridge has recently been built across the river. The Michigan state penitentiary, the buildings and walls of which are of stone, is situated here.

It occupies an enclosed area of eight acres. The main building is 500 ft. long, 57 broad, and 44 high. The city derives its chief importance from its position at the intersection of six railroads, viz.: the Michigan Central (main line); the Jackson branch of the Lake Shore and Michigan Southern; the Fort Wayne, Jackson, and Saginaw; and the Jackson, Lansing, and Saginaw, the Grand River Valley, and the Air-Line divisions of the Michigan Central. The last named company has lately erected here the finest passenger depot in the state; the building is of brick and stone, 294 ft. by 40, and is finely fitted up. The company has also extensive machine shops and other structures here. In the N. part of the city are two mines of bituminous coal, and a third 2 or 3 m. beyond the city limits, which yield a valuable product. The river furnishes good water power, and there are manufactories of chemicals, bricks, drain pipe, fire bricks, agricultural implements, wagons, and furniture, foundries, machine shops, a large rolling mill and nut, bolt, and spike factory, breweries, flour mills, planing mills, potteries, &c. The value of manufactures in 1872 was about \$3,000,000. The sales of merchandise amounted to \$3,280,500. There are four banks with an aggregate capital of \$350,000. Besides the union schools there are eight ward school houses. The schools are graded, and in 1872 included two high, five grammar, and seven primary schools, with 40 teachers and 2,000 pupils. There are also a business college, a German Lutheran school, a young men's library of 2,500 volumes, two daily and two weekly newspapers, and 13 churches. Jackson became a city in 1857.

**JACKSON.** I. A town of Hinds co., Mississippi, capital of the state, on the W. bank of Pearl river, at the intersection of the New Orleans, Jackson, and Great Northern and the Vicksburg and Meridian railroads, 183 m. by rail N. of New Orleans, and 45 m. E. of Vicksburg; lat. 32° 28' N., lon. 90° 8' W.; pop. in 1850, 1,881; in 1860, 3,191; in 1870, 4,284, of whom 1,964 were colored; in 1874, about 6,000. It is regularly built on undulating ground. The principal public buildings are the state house, executive mansion, state lunatic asylum, the state institutions for the deaf and dumb and the blind, and the city hall, in which the United States courts and the courts for the first judicial district of the county are held. The state penitentiary, a large and handsome edifice, was nearly destroyed during the civil war, but it is soon to be rebuilt. The state house is an elegant building, erected at a cost of \$600,000, and in it the sessions of the supreme court of the state are held. Considerable quantities of cotton are shipped from Jackson, and there are two foundries, a sash and blind factory, about 60 stores, several hotels, two banks, several public and private schools, three weekly newspapers (one of which also issues a daily edition during the session of

the legislature), and ten churches. The state library contains 15,000 volumes. Jackson was occupied by the federal forces on May 14, 1863, when the railroad depots, bridges, arsenals, workshops, storehouses, and many residences were destroyed; and on two subsequent occasions during the war it was in the possession of the Union troops. II. A town of East Feliciana parish, Louisiana, 30 m. N. of Baton Rouge; pop. in 1870, 984, of whom 218 were colored. It is the seat of the state asylum for the insane, founded in 1848, and of Centenary college, under the charge of the Methodists, founded in 1825, and having in 1872 4 professors, 88 students, and a library of 2,000 volumes. A weekly newspaper is published. III. A city and the capital of Madison co., Tennessee, on the Forked Deer river, at the intersection of the Mobile and Ohio and the Mississippi Central railroads, 117 m. W. S. W. of Nashville and 72 m. N. E. of Memphis; pop. in 1850, 1,006; in 1860, 2,407; in 1870 4,119, of whom 1,500 were colored; in 1874 estimated by local authorities at 10,000. It is pleasantly situated in the midst of a fertile region, and has a large and growing trade, more than 20,000 bales of cotton having been shipped from this point in 1873-'4. The city contains three planing mills, a foundry, two soda water manufactories, a brewery, a cooperage establishment, and the machine shops of the Mobile and Ohio railroad. A cotton factory is to be erected, and the shops of the Mississippi Central railroad are soon to be established here. There are a national and a savings bank, a daily and two weekly newspapers, a monthly periodical, two public and several other schools, including a female institute under the management of the Memphis Methodist Episcopal conference, and 11 churches. Jackson is the seat of West Tennessee college, which in 1871-'2 had 4 professors and 152 students.

**JACKSON, Andrew**, seventh president of the United States, born in the Waxhaw settlement, N. C., March 15, 1767, died at the "Hermitage," near Nashville, Tenn., June 8, 1845. His parents, who were Scotch-Irish, emigrated from Carrickfergus, Ireland, in 1765, and settled on Twelve-mile creek, a branch of the Catawba river. They had been very poor at home, the father tilling a few acres, while his wife, Elizabeth Hutchinson, belonged to a hard-working and scantily paid family of linen weavers. Mr. Jackson never owned any land in America, and after his death, early in the spring of 1767, his widow removed to Waxhaw creek, where her relatives resided. It was in the house of her brother-in-law, George McKemey, that the future president was born, a few days after the death of his father. Shortly afterward Mrs. Jackson removed to the house of another brother-in-law, Mr. Crawford, whose house-keeper she became, because of the illness of his wife. Little is known of Andrew's childhood. He is described as a frolicsome, mischievous, generous, brave, and resolute boy, passion-

many of our athletic sports in which he was engaged in the latter part of his life. He was not allowed to work and his education was interrupted through it. His mother wanted to train him for the pulpit. At an early age he took to arms and was a witness of the defeat of Butler at Hanging Rock in 1780. He had previously seen the dead and wounded of the Waxhaw militia after the massacre by Tarleton, and had assisted his mother and his brother Robert in ministering to the wants of the distressed Americans. The two brothers were active whigs and were captured by the enemy in 1781. The British commander ordered Andrew to clean his boots, and on the boy's refusal struck him on the head and arm with his sword, inflicting serious wounds. Robert, who displayed equal spirit, was knocked down and disabled. Imprisoned at Camden, Jackson was an eye-witness of the defeat of Gen. Greene at Hobkirk's Hill. While the brothers were suffering in the stocks, in prison, their mother effected their exchange, and took them back to Waxhaw, where Robert died; and it was many months before Andrew's health was restored. His mother then proceeded to Charleston to aid the imprisoned Americans, and soon died of ship fever. Left utterly destitute, Jackson had to labor hard for subsistence. He worked for a time in a sailer's shop kept by one of his relatives, and taught school. Before he had completed his 17th year he commenced the study of law at Salisbury, N. C. in the office of Mr. Spence McKay. He did not neglect his studies altogether, but paid more attention to horse racing, foot racing, cock fighting, and similar amusements common at that time, than to the law. Finishing his studies in the office of Col. Stokes, he was licensed to practise before he had reached the age of 20. In 1788 he was appointed solicitor or public prosecutor of the western district of North Carolina, embracing what is now the state of Tennessee. He arrived at Nashville in the autumn, and entered immediately upon an active career. His practice was large. He had to travel much, making 22 journeys in seven years between Nashville and Jonesborough, 250 m., always at the risk of his life, owing to the numbers and hostility of the Indians. In the summer of 1791 he married Mrs. Rachel Robards, a daughter of Col. John Donelson of Virginia, one of the founders of Tennessee. Her first husband was Mr. Lewis Robards of Kentucky. Mr. and Mrs. Robards were boarding with Mrs. Donelson, then a widow, when Jackson arrived at Nashville, and took up his residence in the same family. In 1793 Mr. Robards applied to the legislature of Virginia for an act preliminary to a divorce, stating that his wife was living in adultery with Andrew Jackson. The act was passed, under the plea a jury was summoned in Dec. 1794, and the court of Meigs co., Ky., declared the marriage between Lewis Robards and Rachel Robards dissolved. Jackson and

Mrs. Robards believed the act passed by the legislature was itself a divorce, and they were married at Natchez two years before the action of the court. At the suggestion of their friend Judge Overton, who also was surprised to learn that the act of the legislature had not divorced Capt. Robards, they procured a license in January, 1794, and had the ceremony performed again. When Gen. Jackson had become the chief of a great party, the circumstances of this marriage led to very serious misrepresentations. Mr. Robards was prone to jealousy without cause, and Jackson was not the first man of whom he was jealous. His statement to the legislature of Virginia is believed to have been wholly unfounded. His relatives all sided with his wife, and never supposed her to be guilty of even an act of impropriety. In all his relations with women Jackson's conduct was singularly pure. Thomas H. Benton, who knew the parties intimately many years, says: "There was an innate, unvarying, self-acting delicacy in his intercourse with the female sex, including all womankind; and on that point my personal observation (and my opportunities for observation were both large and various) enables me to join in the declaration of the belief expressed by his earliest friend and most intimate associate, the late Judge Overton of Tennessee. The Roman general won an immortality of honor by one act of continence; what praise is due to Jackson, whose whole life was continent! I repeat, if he had been born in the time of Cromwell, he would have been a Puritan. Nothing could exceed his kindness and affection to Mrs. Jackson, always increasing in proportion as his elevation and culminating fortunes drew cruel attacks upon her." Jackson became district attorney of Tennessee when that country was made a federal territory; and when the territory became a state, in 1796, he was a man of some wealth, owning much land. He was chosen one of the five members from Davidson co. of the convention which met at Knoxville, Jan. 11, 1796, to make a constitution for the new state, and he was appointed on the committee which drafted that instrument. In the autumn of 1796 he was elected to represent the state in the popular branch of congress. He entered the house Dec. 5, 1796, when Washington was on the eve of retirement. Jackson belonged to the republican (afterward democratic) party, then forming under the lead of Thomas Jefferson, who had just been elected vice president. He was one of the twelve representatives who voted against the adoption of an address to President Washington, in reply to his last annual address to congress, as he could not conscientiously approve of all the acts of the administration. His first speech was made on Dec. 29, in support of claims for services against the Indians. He pushed the question with his usual earnestness, speaking more than once, and succeeding in his purpose. During the session he voted in favor of laying taxes

on slaves, of completing three frigates, against buying peace of the Algerines, against a large appropriation for furnishing the president's house, and against the removal of the restriction confining the expenditure of public money to the specific objects for which each sum was appropriated. His course was highly approved by his constituents; and he was made a member of the senate, in which he took his seat Nov. 22, 1797. Nothing is known of his senatorial career. So far as appears, he never made a remark or cast a vote as a senator. In April, 1798, he returned to Tennessee on leave, and resigned his seat. He was elected a justice of the supreme court of Tennessee by the legislature, at a salary of \$600 a year, and held courts in various parts of the state. None of his decisions remain. While he was on the bench he was involved in a quarrel with Gov. Sevier, which came to a crisis in 1801, when Jackson was elected a major general of militia over Sevier. Jackson suspected Sevier of having been engaged in certain land frauds. An informal duel at Knoxville, in 1804, was prevented at the last moment by the interference of friends. In 1798 he had sold lands to a Philadelphian, and on the basis of the notes he received bought goods for the Tennessee market; but the failure of the Philadelphian threw him into difficulties, and in order to clear them off he resigned his judgeship, July 24, 1804, sold a large amount of property, and relieved himself from debt. He removed to what subsequently became known as the "Hermitage," with his slaves, and dwelt in a log house. He extended his business, being chief of the trading firm of Jackson, Coffee, and Hutchings, and raised cotton, corn, wheat, horses, cows, and mules. He had a cotton gin, then a rarity. The firm traded to New Orleans, and built boats for other traders; but it lost much money, and came to an end. Jackson was an exact and judicious business man, and succeeded in all undertakings managed by himself. His commercial failure grew out of the proceedings of the firm during his absence. In the opening days of 1806 commenced a quarrel which led to a duel between Gen. Jackson and Charles Dickinson, and to the latter's death. Mr. Dickinson had previously used disparaging words of Mrs. Jackson, which he had explained away; but he repeated them, whereupon Jackson remonstrated with his father-in-law, Mr. Ervin, saying: "I wish no quarrel with him; he is used by my enemies in Nashville, who are urging him on to pick a quarrel with me. Advise him to stop in time." Becoming involved in a quarrel with a Mr. Swann relative to the terms of a horse race, Jackson found the name of Dickinson offensively introduced into the letters written by Swann, which drew from him certain characteristic comments, and these were carried to their subject, as was the intention of their writer. Dickinson, on Jan. 10, just before starting for New Orleans in a flat-boat, wrote to Jackson,

charging him with equivocations, falsehood, and cowardice. During his absence the controversy between Jackson and Swann was continued, and led to a tavern fight, begun by the former. Dickinson returned to Nashville on May 20, and on the 21st he published a severe attack on Jackson, provoked in part by the language of the latter in the Swann quarrel. Jackson challenged him, and the parties met on the banks of the Red river, in Logan co., Ky., early in the morning of May 30. The place is a long day's journey from Nashville, and the duellists had to leave their homes early on the 29th. Dickinson was accompanied by a number of his associates, as he was very popular, and stood high in the society of Nashville. His second was Dr. Catlet, and Jackson's was Gen. Overton. The distance was eight paces, and Overton won the right to give the word. Dickinson fired at the word, breaking a rib, and raking the breast bone; but Jackson gave no sign of being hit, and his antagonist, who had made sure of killing him, exclaimed: "Good God! have I missed him?" Jackson then fired, and Dickinson fell mortally wounded. He died that night, not even knowing that his ball had hit Jackson, with whom it was a point of pride not to let him know that his aim had been effectual. His reason for concealing his wound, as he once said to a friend, was, "that as Dickinson considered himself the best shot in the world, and was certain of killing him at the first fire, he did not want him to have the gratification even of knowing that he had touched him." But, according to Mr. Parton, his "wound proved to be more severe and troublesome than was at first anticipated. It was nearly a month before he could move about without inconvenience, and when the wound healed, it healed falsely; that is, some of the viscera were slightly displaced, and so remained." This duel made Jackson unpopular in Tennessee, until his military exploits had withdrawn public attention from it. In 1805, when Aaron Burr made his first visit to the west, he twice became the guest of Jackson. The western people were anxious for a war with Spain, and Burr was popular with them, because he was believed to represent and support their opinions. Jackson was of the war party. After Burr's return to the east he and Jackson corresponded, the latter even making out the lists of officers for two regiments which the former suggested might be raised in Tennessee. Burr arrived at the Hermitage in September, 1806, and was warmly received; and at the instance of his host a public ball was given in his honor at Nashville, though rumors adverse to him and his doings were then current. Jackson, in military costume, led Burr into the room, and introduced him. In November Burr sent an order to Jackson for boats and provisions, which was fulfilled. A week later (Nov. 10) Jackson received intelligence that led him to doubt Burr's integrity; he directed that no

further engagements should be made with Burr, and wrote to him, demanding to know the truth. He also wrote a warning letter to Governor Claiborne of Orleans territory, and another to President Jefferson, tendering the services of his militia division to the general government. Burr arrived at Nashville Dec. 14, and sought Jackson, whom he assured of the falsity of the charges against him. They had a pecuniary settlement, and Burr departed, taking but two of the eight boats for which he had contracted. Shortly after his departure the president's proclamation denouncing him arrived, and he was burned in effigy. On Jan. 1, 1807, Gen. Jackson received orders from the government at Washington to hold his command in readiness to act. The revolutionary veterans in Nashville tendered their services to Jackson, who accepted them. He exerted himself with his usual energy; but his active loyalty did not save him from the suspicion that he was leagued with Burr. Summoned to Richmond as a witness in the trial of Burr, he acted as one of Burr's most zealous partisans. "There he harangued the crowd in the capitol square," says Mr. Parton, "defending Burr, and angrily denouncing Jefferson as a persecutor. There are those living (1859) who heard him do this. He made himself so conspicuous as Burr's champion at Richmond, that Mr. Madison, the secretary of state, took deep offence at it, and remembered it to Jackson's disadvantage five years later when he was president of the United States, with a war on his hands. For the same reason, I presume, it was that Jackson was not called upon to give testimony upon the trial." Jackson at this time belonged to that portion of the democratic party which sought to have Mr. Monroe nominated as President Jefferson's successor, the president himself preferring Mr. Madison. For some years he held no office, living at the Hermitage, and devoting himself to agriculture. His life was not altogether quiet, however, as, besides lesser disputes, he had an animated quarrel with Mr. Dinsmore, agent of the Choctaw Indians.—When, in 1812, war was declared against England, Gen. Jackson promptly tendered his services, and those of 2,500 men of his division of Tennessee militia, to the national government, and the offer was as promptly accepted; but it was not until Oct. 21 that the government requested Gov. Blount to send 1,500 men to New Orleans. Jackson appointed Dec. 10 for the meeting of the troops at Nashville. A force of infantry and cavalry, 2,070 strong, was organized, and on Jan. 7, 1813, the infantry embarked, while the cavalry marched across the country. On Feb. 15 the little army assembled at Natchez, where it remained by direction of Gen. Wilkinson. At the close of March Jackson received an order from the secretary of war to dismiss his corps, but he conducted his force back to Tennessee before disbanding it. It was on this march that the soldiers gave him the name of "Hick-

ory," because of his toughness, and in time this was changed into "Old Hickory." He tendered his corps for an invasion of Canada, but no answer came from Washington, and on May 22, at Nashville, the men were dismissed. Government allowed his transportation draft to be protested, and his private fortune would have been irretrievably ruined had not his friend Col. Benton made "an appeal from the justice to the fears of the administration." When the administration found that the state of Tennessee would be lost to it if this scandalous act were persisted in, justice was done. In 1813 Jackson's friend William (afterward Gen.) Carroll became involved in a quarrel with Mr. Jesse Benton, a brother of Col. T. H. Benton, and challenged him. Carroll asked Jackson to be his second, which he declined, until Carroll told him there was a conspiracy "to run him (Carroll) out of the country," when he resolved to interfere. At first he was successful in his remonstrances with Benton, but the latter finally resolved that the duel should go on. Jackson acted as Carroll's second. Benton sent an offensive account of the affair to his brother, who was then serving Jackson so well at Washington. Other enemies of Jackson sent him similar accounts. This led to an angry correspondence between Gen. Jackson and Col. Benton, and the latter made use of the harshest language in speaking of the former, all of which was reported to the general, who threatened to horsewhip the colonel the first time they should meet. On Sept. 4 Jackson, accompanied by Col. Coffee, met the Bentons in the streets of Nashville. Bidding him defend himself, and avowing his purpose, Jackson advanced upon Col. Benton, who sought to draw a pistol, but was anticipated by his antagonist, who drew one and aimed at him. Benton retreated, and Jackson followed him, until they reached the back door of the city hotel, when Jesse Benton fired at Jackson, shattering his left shoulder, the pistol being charged with two balls and a slug. Jackson fell; and Coffee, who entered on hearing the report, fired at Col. Benton, but missed his aim. He was then about to strike down the colonel, when the latter stumbled down a staircase. Meantime Mr. S. Hays, a nephew of Mrs. Jackson, who knew that it was Jesse Benton that fired at the general, volunteered in his relative's aid, and a fierce conflict ensued between him and Jesse, he making use of a sword case first, and then of a dirk, and throwing him down. Benton was wounded in several places, and would have been killed had not a bystander caught Hays's hand. Nothing but Jackson's own resolution prevented the loss of his left arm, as all the doctors but one recommended amputation.—The massacre of Fort Mims by the Creek Indians, Aug. 30, 1813, created an extraordinary excitement throughout the southwest. Jackson addressed the volunteers, and appointed Fort St. Stephen as the rendezvous for all who would arm themselves to

take part in a war of Indian extermination. On Sept. 25 the legislature of Tennessee called 3,500 volunteers into the field, besides the 1,500 that were in the national service. Jackson, though too feeble to leave his bed, issued addresses, and aided in the organization of the troops. Still suffering from his wounds, he was at Fayetteville with his division on Oct. 7. On the 11th his force moved, and is said to have marched 82 m. in six hours, in the hope of meeting the Indians. Operations were delayed by a defective commissariat. On Nov. 3 Col. Coffee, who had been sent out with a cavalry force, defeated the Creeks at the town of Tallushatchee, inflicting heavy loss, and destroying the place. On Nov. 9 Jackson defeated the Creeks at Talladega, where hundreds of them were killed or wounded. The want of food prevented these victories from being very useful. The troops were starving and mutinous. A misunderstanding as to the term of service of the volunteers occurred between them and their commander. With fewer than 1,000 newly raised men, besides Indians, he entered the enemy's country in January, 1814. He defeated the Indians at Emuckfau and Enotochopco, Jan. 22 and 24, and these were among the severest reverses they ever experienced. The details of the battle showed much skill on the side of the victors, Jackson's energy and bravery being very conspicuous. The troops were then dismissed, but a new force was speedily formed, composed in part of regulars. In February Jackson was at the head of 5,000 men. The Creeks made a final stand at Tohopeka, or the Horseshoe, a peninsula in the Tallapoosa river; and their position was very strong, though defended by inadequate numbers. Jackson arrived before this post, March 27, 1814, with 2,000 troops, and attacked it the same day. It was taken, and of its 900 defenders 750 were killed or drowned, the victors losing 201 men. This victory ended not merely the Creek war, but the power of the Indian race in North America. Jackson's victories settled for ever the long quarrel between the white man and the red man. Weathersford, the principal Creek chief, surrendered to him, and was protected. Some of the Indians fled to Florida, but most of them obeyed Jackson's order to retire to the north. In the summer of 1814 Gen. Jackson and Col. Hawkins made with them the treaty of Fort Jackson, the terms of which were as moderate as regard for the peace and safety of the white settlers allowed. The chiefs gave Jackson three miles square of land, and President Madison was desirous that he should be allowed to accept the gift, in which view congress could never be brought to concur.—Gen. Jackson had now obtained a national reputation, and on May 31 his appointment as a major general in the United States army was officially announced. Thus in the national service, he became the acknowledged military leader of the southwestern part of the

Union, various circumstances having placed him in a position to which six other generals had claims. The English were preparing a grand attack on the southwest, and in July, 1814, Jackson left his home for Mobile, against which the first blow of the enemy was to be delivered. Florida was then a Spanish province, but the English used it as if it were their own; and from Pensacola, the best harbor on the gulf, they organized expeditions against the United States, and aided the Indians. It was now the rendezvous of their forces, and the Spaniards had neither the power nor the disposition to prevent this abuse of neutral territory. The headquarters of the British commander were in the house of the Spanish governor, Manriquez. When Jackson arrived at Mobile, he found but a small force at his command, yet he resolved to seize Pensacola. He wrote to the secretary of war, asking permission to attack that place, but the secretary's reply reached him only at the end of six months. He opened a correspondence with Manriquez, which led to no change of conduct on the part of the Spaniards, Col. Nichols, the English commander, continuing his preparations at Pensacola for an attack on Mobile. Assuming the responsibility, as was his custom both in politics and in war, Jackson determined to act without orders. He gave direction that the Tennessee levies should march upon Mobile. The call he made upon his old comrades was so well obeyed, that men paid large sums for the privilege of filling vacancies in the corps that had been mustered into the service. Meantime he threw a small force into Fort Bowyer, on Mobile point, commanded by Major Lawrence. This fort, which was incomplete, was assailed, Sept. 15, by a British fleet, aided by a combined force of Indians and marines. The enemy were repulsed, losing one of their ships and 72 men. A mutiny in the ranks of the Tennessee troops delayed the arrival of the force under Gen. Coffee, and it was not till Oct. 26 that Jackson found himself at their head, his entire force consisting of 4,000 men, 1,000 of whom were regulars and 1,500 mounted volunteers. He hung six of the mutineers, and his conduct was the subject of much hostile discussion at a later period. He marched immediately upon Pensacola, at the head of 3,000 men. Negotiations failing, he seized the town by force, Nov. 6; and the British blew up the fort that commanded the mouth of the harbor, their seven vessels leaving the bay. On Nov. 11 Jackson was again at Mobile, where he remained till the 22d to meet an expected attack, and whence he sent a force that expelled Nichols and his Indians from Florida. He sent the mass of his troops to New Orleans, and reached that place himself Dec. 2, 1814. The city was miserably defended, and had the English moved with ordinary rapidity it must have fallen into their hands. Jackson immediately prepared to meet the enemy. On Dec. 14 a powerful British naval force captured five

American gunboats and a schooner, which gave the enemy command of the route to New Orleans, had they known how to use it. The next day Jackson declared martial law, having already called out the whole of the state militia. The forces under his orders consisted of Tennessee, Kentucky, Louisiana, and Mississippi militia, a few regulars, Baratarians privateersmen, and a battalion of colored men. The vanguard of the British army, under Gen. Keane, was landed on Dec. 16, and marched to within 9 m. of New Orleans on the morning of the 23d. Jackson heard of their arrival before 2 P. M., assembled a motley force 2,181 strong, of whom only about 1,800 were engaged, and, aided by Lieut. Henley in the schooner Carolina, attacked the enemy. A very hot action was fought, with decided advantage to the Americans, as it prevented the enemy's advance upon the city; and the victory might have been made complete had not large British reinforcements arrived during the night. New Orleans was really saved on the night of Dec. 23, as the enemy were made over-cautious by the result of that battle. Jackson fell back to a canal 4 m. from the city, where his famous line was constructed, and provided against attacks from other directions. Sir E. Pakenham arrived on the 25th, and made new arrangements in the British army. The Carolina was destroyed by his batteries that evening. He attacked Jackson on the 28th, and was repulsed. On Jan. 1, 1815, another attack was made, principally with artillery, and again the enemy were signally beaten. These results were owing to the skilful manner in which Jackson managed the resources at his command, and to the enthusiasm with which he had inspired his inexperienced troops. He caused the invaders to be constantly harassed by night attacks. On Jan. 1 he was reinforced by the arrival of 2,250 Kentucky militia, mostly unarmed, the arms that had been ordered from Pittsburgh to New Orleans having failed to reach that place. Reinforced on Jan. 6, the entire British army, including seamen and marines, probably consisted of 14,000 effective men; but British authorities place it as low as 8,000, and greatly exaggerate Jackson's numbers, placing them as high as 25,000. His line on the left bank of the Mississippi was about a mile long, with 12 guns, and was defended by only 3,200 men, while 800 more were distributed in positions hard by. It was a strong position; the cannon were well served by Lieut. (afterward Gen.) Armstrong, and by the Baratarians; and so slippery was the soil that, according to Major Latour, an eye-witness, a man unincumbered and unopposed would have found it difficult to mount the breastwork at leisure and carefully. Its weakness was, that it was commanded from the right bank, where were American batteries, manned by seamen, and supported by Kentucky militia. The English enlarged the Villere canal, and prepared to

throw a force upon the right bank of the river, to storm the American position there before commencing their attack on Jackson's line. Col. Thornton was despatched, at the head of two regiments and 600 marines and seamen, across the river, on the night of the 7th; but delays were experienced, and it was not until the event of the campaign had been decided on the left bank that he was able to advance. Meantime, on the left bank the British columns were directed against the American line; but they were received with a severe fire and beaten back, Gen. Pakenham being killed, Gen. Gibbs mortally wounded, and Gen. Keane severely wounded. The attack was repeated, but with no success. The weight and precision of the American fire were irresistible. A small British force succeeded in carrying a battery near the river, after losing three fourths of its number, but abandoned it. One regiment, the 93d highlanders, distinguished for its services in many parts of the world, lost more than half its men, having been brought to a point where it could do no good, but where it could be most effectually operated upon by the Americans. The British troops never behaved better, but they were badly handled; and it is the evidence of one of their own officers that Sir E. Pakenham's impatience in giving the signal of attack too soon, instead of waiting for the development of Thornton's movement, was the cause of his severe loss. The merit of Jackson consisted mainly in the fact that he adapted his means of defence most shrewdly to the character of his own forces no less than to that of the enemy. His opponents have never hesitated to admit his merits in the strongest language. The number of the British engaged on the left bank is variously stated, the lowest figure on the British side being 5,195. On the right bank Col. Thornton's attack was entirely successful, owing to one of Gen. Morgan's aids having directed a retreat that was rapidly converted into a flight. The seamen, under Capt. Patterson and Lieut. Henley, who served a heavy battery on the right bank, though compelled to abandon it, spiked their guns and threw their ammunition into the river. Their success on that side gave the British virtual command of the left bank and of New Orleans; but they had been so roughly handled before Jackson's line that they had no heart to pursue the signal advantage they had gained over his lieutenant. Gen. Lambert, who had succeeded to the command of the British army, proposed an armistice. Jackson consented, on condition that while hostilities should be suspended on the left bank, they should not be so on the right bank, and that neither party should send reinforcements there. Gen. Lambert ordered Col. Thornton to return to the left bank, and the British gave up their solitary advantage. The enemy's loss on the left bank was about 2,000 in killed, wounded, and prisoners; the American



men, 7 killed and 6 wounded. On the right flank neither party suffered much, but even here the loss was mostly on the side of the enemy. Jackson watched the enemy until the 8th, when they retreated, abandoning their guns, and leaving 80 wounded men to the care of the Americans. Jackson was involved in much trouble by the conduct of many civilians during the campaign, who forgot that a dictatorship alone could save the state, which the enemy, had they been victorious, would possibly have tried to retain, in spite of the treaty of Ghent, on the ground that the treaty of 1803, by which France had ceded Louisiana to the United States, was void, because she had no claim to the territory. A Frenchman, M. Louaillier, a member of the legislature of Louisiana, was conspicuous among the general's enemies, and Jackson had him arrested on March 1. Judge Hall, of the United States district court, granted Louaillier's petition for a writ of *habeas corpus*, and was himself arrested and imprisoned, and then banished from the city. On March 13 martial law was abrogated by Jackson's order, and Hall returned. Jackson was then arrested on a charge of contempt of court, and fined \$1,000. He refused the offers that were made from all sides to pay the fine, and paid it himself, protecting the court, which could not have stood a moment against his opposition. After his retirement from public life some of his friends requested congress to refund the amount. After considerable opposition, the bill refunding the money, principal and interest, was passed in February, 1844.—The brilliant successes of the Louisiana campaign made Jackson very popular throughout the country. He was appointed commander-in-chief of the southern division of the United States in April, 1815, and received the thanks of congress. Even at that early day he was thought of as a candidate for the presidency, and his political prospects were not injured when it was known that he advised President Monroe to pursue a liberal course toward the federalists, whose political importance had vanished, and to select his cabinet without regard to party. Toward the close of 1817 a war with the Seminoles was commenced, and Jackson was ordered to take the field in person. He formed a large force, consisting of regular troops, militia from Tennessee and Georgia, and Creek Indians. He was successful, and without much fighting. He seized the Spanish fort of St. Mark's, where he found a Scotchman named Arbuthnot; and at the Indian town of Suwanee he captured one Ambrister, a native of the Bahamas. These British subjects were tried before courts martial, and condemned on the charges of having stirred up the Indians against the United States, and of applying them with the means of war; and they were executed. The court softened Ambrister's sentence to whipping and imprisonment, but Gen. Jackson hung him nevertheless. Two Indian chiefs, one of them the prophet

Francis, were promptly hanged by his orders. He then marched upon Pensacola, and, in spite of the remonstrances of the Spaniards, seized it. These proceedings created great sensation. The execution of Arbuthnot and Ambrister was the cause of much irritation in England, and Lord Castlereagh, secretary of state for foreign affairs, told Mr. Rush, the American minister, that he could have had war with the United States merely by holding up his hand. The administration of President Monroe was divided on the subject. J. Q. Adams, secretary of state, ably defended the course of Jackson in his correspondence with the Spanish minister, who had demanded an apology and an indemnity for the seizure of the two places in Florida, and in the cabinet against Mr. Calhoun, secretary of war, who was in favor of putting him on his trial; which last fact was unknown to Jackson, who believed that Calhoun had acted with Adams, and that Mr. Crawford, secretary of the treasury, was his enemy. In congress his conduct was the subject of vehement debates, but resolutions of censure and condemnation were rejected by the house of representatives, and the senate did not come to any decision on the question. The report made to the senate, by Mr. Lacock of Pennsylvania, was very full and very severe, but was never acted upon. So offensive was it to Jackson that, it is said, he threatened to cut off the ears of certain senators. His anger was caused by his belief that he had acted in strict conformity to the wishes of the administration; and it is by no means certain that he did not. In 1819 he made a visit to the north, proceeding as far as New York, and was everywhere well received. The government of New York city employed Vanderlyn to paint his portrait. When Spain ceded Florida to the United States, Jackson was appointed governor of that territory, March 10, 1821, and took possession of it July 18. He held the office only a few months, but during that time he had a dispute with Col. Callava, late Spanish governor of Florida, relative to certain judicial papers which the latter was endeavoring to carry out of the country. Callava was imprisoned, but released on the seizure of the papers. Judge Fremontin granted him a *habeas corpus*, which Gov. Jackson disregarded, and summoned the judge before him. The judge did not obey the summons, and the governor's course was condemned by some members of congress, in debate; but they failed to obtain a formal censure. President Monroe offered the post of minister to Mexico to Gen. Jackson, which he would not accept.—In 1828 the Tennessee legislature elected him a United States senator, and nominated him for the presidency. "At first," says Mr. Tucker, "this nomination afforded matter of jest and merriment rather than of serious animadversion in other states, since, unquestionable as were Gen. Jackson's military qualifications, he was not thought to possess the information, or respect

for the civil authority, or temper, deemed requisite in the office of president; and very few believed that the favor which his military successes had produced for him in his own state would find much support in other parts of the Union." But in the ensuing presidential election of 1824 Jackson received 99 electoral votes, 84 being cast for John Quincy Adams, 41 for William H. Crawford, and 37 for Henry Clay. No candidate having received a majority, the choice devolved upon the house of representatives, and Adams was elected. Jackson then apparently retired from public life; but the entire opposition to the administration of Adams supported him for the presidency in 1828, and he was elected, receiving 178 electoral votes, while only 83 were cast for Adams. The contest which thus resulted was among the most bitter in American history. Jackson's whole public career was severely assailed, and his private life was not spared. The circumstances of his marriage were grossly misrepresented, and it is said with fatal effect on Mrs. Jackson, who died only a few days after it was known that her husband had been chosen president. Assuming the presidential office, March 4, 1829, he commenced a course of vigorous government, which he maintained for eight years. Mr. Calhoun, who had been vice president under Adams, and re-elected when Jackson was chosen president, headed an influential section of the democratic party, and expected to succeed his chief, who had avowed his intention not to be a candidate for re-election. The president was personally alienated from Calhoun on being informed that he had been his enemy in the Monroe cabinet at the time of the Seminole war, and became politically hostile in consequence of Calhoun's assertion of the doctrine of nullification. The democratic party, outside of South Carolina, supported the president; and in 1831 a new cabinet was appointed. Mr. Ingham, secretary of the treasury, and a friend of Calhoun, made way for Mr. McLane; Mr. Branch, another friend of Calhoun, left the navy department, which was taken by Mr. Woodbury; and Mr. Berrien, attorney general, was succeeded by Mr. Taney. Mr. Van Buren gave up the state department to Mr. Livingston, and was appointed minister to England; and Mr. Eaton retired from the war department, which was taken by Gen. Cass. Scandal attributed these changes, and the rupture that had preceded them, to the influence of Mrs. Eaton, wife of the secretary of war, with whom the wives of the Calhoun leaders, as well as many other ladies, refused to associate. Her husband was an old and intimate friend of the president, who zealously espoused Mrs. Eaton's side of the quarrel. When the question of Mr. Van Buren's confirmation came before the senate, in 1832, it was decided in the negative by the casting vote of Calhoun. When congress in 1832 rechartered the bank of the United States, President Jackson vetoed the bill, July 10. His course relative

to appointments gave much offence, as numerous removals were made on political grounds alone, and the vacancies were filled by the selection of ardent partisans; and this proceeding was the more censured, because the president had advised Monroe to disregard party in making appointments to office. The followers of Calhoun had now become "nullifiers," and threatened open resistance to the government. They demanded the reduction of duties to the extent of the disavowal of the protective principle, threatening that South Carolina would nullify the revenue laws if they should not be repealed. A state convention of South Carolina was held at Columbia in 1832, which took measures for resisting the tariff laws. Jackson was opposed to a high tariff, and was ready to continue his constitutional exertions in behalf of such modifications of existing laws as would leave no reasonable ground for complaint on the part of South Carolina; but while the tariff laws endured, he was determined that they should be rigidly enforced; and he early let it be understood that he would show no quarter to active disunionists. The presidential election of 1832 came on while the troubles concerning the United States bank, nullification, and removals from office were at their height. Jackson had reconsidered his intention not to be a candidate, and was formally nominated, Van Buren being the democratic candidate for vice president. His chief opponent was Mr. Clay, who represented the interests of the friends of the national bank and of protection. Mr. Wirt was nominated for the presidency by the anti-masonic party. The contest, though vigorous, was less personal than that of 1828. When the election was over, it was found that Jackson had been supported by every state but seven, Clay receiving the votes of six states, and Wirt those of Vermont only. The nullification crisis occurred in the interval between the decision of the contest of 1832 and Jackson's second inauguration. The president issued his proclamation against the nullifiers on Dec. 10, 1832; and the "force bill," to enable him to maintain the supremacy of the laws, was passed. Fortunately, a compromise was effected, under the lead and influence of Clay, by which the tariff was essentially modified, and an excuse for not proceeding to extremities was afforded to South Carolina. Jackson's second term of service was even a more exciting period than his first. The "bank war" was renewed with vigor. He recommended in his annual message of 1833 that the stock in the bank owned by the government should be sold; and though the house of representatives had declared in favor of continuing the deposits of the public money in the bank, the president resolved upon their removal. This was effected on Sept. 22, 1833, when an order was issued by Mr. Taney, secretary of the treasury, directing the collectors to cease making deposits in the bank, as no removal of money actually on deposit was con-

templated by the president. The measure was the president's own. He called a cabinet council on Sept. 10, at which he read a paper in support of it, but found few of his advisers ready to agree with him. Mr. McLane having been appointed to the state department, Mr. Duane was placed at the head of the treasury, for the purpose of executing the intention of the president; but as he refused to act, he was summarily dismissed, and Mr. Taney, who succeeded him, carried out the measure, whereupon the senate refused to confirm his appointment. The senate also rejected four of the persons appointed government directors, and insisted upon its rejection when they were a second time nominated. That body made a call upon the president for a copy of the paper read to the cabinet on Sept. 10, 1833; but he refused to furnish it. A formidable combination against the president was effected in the senate, headed by Calhoun, Clay, and Webster, and a resolution condemning his course was adopted by a vote of 26 to 20. The president sent in a protest, which the senate voted a breach of its privileges. The house of representatives sustained the president. A panic existed for some time, and the opposition was supported by a powerful popular party. The gold currency was revived, and gradually confidence was restored; and in 1837, just before the expiration of his public life, the censure passed upon President Jackson was expunged by the senate, 24 to 19. The foreign diplomacy of President Jackson was very successful. Useful commercial treaties were made with several countries, and were renewed with others. Indemnities for spoiliations on American commerce were obtained from France, Spain, Naples, and Portugal, and the most amicable relations were sustained with England. During his second term the national debt was extinguished, the Cherokees were removed from Georgia and the Creeks from Florida, the original number of the states was doubled by the admission of Arkansas and Michigan into the Union, and the gold currency was greatly increased. On the other side, the agitation of the slavery question was then renewed with more vigor than ever before, and the Seminole war was recommenced. He issued a farewell address to his countrymen, and on March 4, 1837, retired from public life. Leaving Washington on the 6th, he returned to the Hermitage, where he resided until his death, ever taking a lively interest in politics, and especially in the welfare of his party. The immediate occasion of his death was dropsy, but throughout most of his life he had suffered severely from various diseases; and some of those actions of his which have been most warmly condemned were largely owing to the irritation of illness. He was a thoroughly honest man, as straightforward in action as his thoughts were unsophisticated. His charities were frequent and unostentatious; and in his last days he made an open profes-

sion of those religious sentiments which he had always entertained. His chief intellectual gifts were energy and intuitive judgment. In private life at the Hermitage he is described by Benton as a careful farmer, overlooking everything himself, seeing that the fields and fences were in good order, the stock well attended, and the servants comfortably provided for. "But he needed some excitement beyond that which a farming life can afford, and found it for some years in the animating sports of the turf. . . . His temper was placable as well as irascible, and his reconciliations were cordial and sincere."—The following are the most noted biographies of Andrew Jackson, and works relating to his career: "Life of Andrew Jackson, Major General in the Service of the United States," by John Henry Eaton (Philadelphia, 1824; 1st ed. about 1818); "Life of Andrew Jackson, President of the United States of America," by William Cobbett, M. P. (New York, 1834); "A Narrative of Events in the South of France, and of the Attack on New Orleans, in 1814 and 1815," by Capt. John Henry Cooke (London, 1835); "The Campaign of the British Army at Washington and New Orleans, in the years 1814 and 1815," by the author of "The Subaltern" (London, 1837); "Life of Andrew Jackson, Private, Military, and Civil," by Amos Kendall (New York, 1844); "Thirty Years' View, or a History of the Workings of the United States Government for 30 Years, from 1820 to 1850," by Thomas H. Benton (2 vols., New York, 1854-'6); "Jackson and New Orleans," by Alexander Walker (New York, 1856); and "Life of Andrew Jackson," by James Parton (3 vols., New York, 1860).

**JACKSON. I. Charles**, an American jurist, born in Newburyport, Mass., May 31, 1775, died in Boston, Dec. 13, 1855. He was the son of Jonathan Jackson, a merchant greatly respected for his virtues and intelligence. He graduated at Harvard college in 1793, studied law three years with Theophilus Parsons, then of Newburyport, established himself there as a lawyer, and rose rapidly into practice. In 1803 he removed to Boston, and for ten years was a leading member of the Suffolk bar. He entered into partnership with Judge Samuel Hubbard, and the business of their office became more lucrative probably than that of any other in New England had been up to that time. In 1813 he was chosen a judge of the supreme court of Massachusetts, which office he resigned at the end of ten years on account of ill health. He was an influential member of the convention of 1820 for amending the state constitution. In 1832 he was appointed one of the commissioners to revise the general statutes of the state, and drew up the second part of the "Revised Statutes." In 1828 he published a "Treatise on the Pleadings and Practice in Real Actions." **II. James**, an American physician, brother of the preceding, born in Newburyport, Oct. 8, 1777, died in Boston, Aug. 27, 1867. He graduated at Harvard col-

lege in 1796, and in December, 1797, became a pupil of Dr. Edward Augustus Holyoke of Salem, with whom he studied nearly two years. He then went to London, where he was a "dresser" in St. Thomas's hospital, and attended lectures at that and at Guy's hospital. After his return he practised in Boston. In 1810, in connection with Dr. John C. Warren, he brought before the community a proposition for establishing a hospital in Boston. The result was the organization of the asylum for the insane at Somerville, and afterward of the Massachusetts general hospital in Boston, of which Dr. Jackson was the first physician. In 1810 he was chosen professor of clinical medicine in Harvard college, and two years afterward professor of theory and practice. In 1835 he resigned his place as physician to the hospital and his office in the medical school. He was several times chosen president of the Massachusetts medical society. His principal publications are: "On the Brunonian System" (1809); "Remarks on the Medical Effects of Dentition," in the "New England Medical and Surgical Journal" (1812); various articles in the "Transactions of the Massachusetts Medical Society," including some reports drawn up principally or entirely by him, viz.: "On Cow Pox and Small Pox," "On Spotted Fever," and "On Spasmodic Cholera;" "Enlogy on Dr. John Warren" (1815); "Syllabus of Lectures" (1816), and "Text Book of Lectures" (1825-7), for the use of the medical class; a memoir of his son James Jackson, jr. (1835); "Letters to a Young Physician" (1855); and "Another Letter to a Young Physician" (1861).

III. **Patrick Tracy**, an American merchant, brother of the preceding, born in Newburyport, Aug. 14, 1780, died in Beverly, Sept. 12, 1847. At the age of 15 he was apprenticed to William Bartlett, a merchant of Newburyport, and subsequently established himself in Boston in the India trade, in which he acquired a handsome fortune. In 1812, at the invitation of his brother-in-law, Francis C. Lowell of Boston, who had recently examined the process of the cotton manufacture in England, he engaged in a project to introduce the power loom, then newly invented, and the mode of constructing which was kept secret, into the United States. As the war between the United States and England prevented communication with the latter country, they were forced to invent a power loom themselves, and, after repeated failures, succeeded in the latter part of 1812 in producing a model from which a machine was constructed by Paul Moody. In 1813 they built their first mill at Waltham, near Boston, which is said to have been the first in the world that combined all the operations for converting the raw cotton into finished cloth. In 1821 Mr. Jackson made large purchases of land on the Merrimack river near the Pawtucket canal, on which a number of mills were constructed by the Merrimack manufacturing company, organized under his auspices. This settlement formed the

germ of the city of Lowell. After superintending the formation of another company in the same place, he procured in 1830 a charter for a railroad between Lowell and Boston, the construction of which he directed until its completion in 1835. It was then probably the finest work of the kind in the country. Pecuniary reverses having overtaken him in 1837, he assumed the charge of the locks and canals company of Lowell, and subsequently of the Great Falls manufacturing company at Somersworth, N. H., managing both with complete success. He labored zealously to promote the moral and intellectual improvement of the operatives in his mills.—See memoir of P. T. Jackson, by John A. Lowell, in Hunt's "Lives of American Merchants" (New York, 1856-'8).

**JACKSON, Charles Thomas**, an American physician, born in Plymouth, Mass., June 21, 1808. He devoted much attention to science in his youth, studied medicine under Drs. James Jackson and Walter Channing, and received the degree of M. D. from Harvard university in 1829. In 1827 and 1829 he made, in company with Francis Alger of Boston, a mineralogical and geological survey of Nova Scotia, an account of which was published by them, together with a geological map of the province, in the "Memoirs of the American Academy of Arts and Sciences." In the autumn of 1829 he went to Europe, where he remained three years, studying in Paris. In 1831 he made a pedestrian tour through Switzerland, Piedmont, Lombardy, Tyrol, Bavaria, and Austria. He afterward visited the principal cities of Italy, and made a geological tour of Sicily and of Auvergne in France. In October, 1832, he embarked for New York in the packet ship Sully, taking with him an electro-magnet, two galvanic batteries, and other philosophical apparatus. During the voyage a discussion arose among the passengers, of whom Prof. S. F. B. Morse was one, on the subject of electro-magnetic experiments, and their applicability to telegraphic use. Dr. Jackson asserts that during this discussion he pointed out the possibility of correspondence by means of electricity, and suggested several ways of accomplishing it. His plan as then developed in conversation, he declares, embraced the essential and peculiar features of the American telegraph patented in 1840 by Prof. Morse. Dr. Jackson also asserts that in the spring of 1834 he constructed and successfully worked, and exhibited to Francis Alger and other friends, a telegraph combining the peculiar features of that which he had invented on board the Sully, though he did not think it could be profitably brought into public use till the invention of the sustaining battery by Daniell in 1837 furnished the means of obtaining a long continued voltaic current of uniform strength. A controversy arose in 1837 between Morse and Jackson upon their respective claims, the evidence in regard to which was printed for the use of the court and counsel in subsequent trials of telegraph cases. In

Jackson settled in Boston, and entered practice of medicine, but in a few years abandoned it to devote himself to mineralogy, and geology. In 1836 he was appointed geologist of Maine, and surveyed that state; and at the same time as commissioned by Massachusetts to survey her public lands in Maine. In 1839 he was appointed geologist of Rhode Island, and of New Hampshire. His surveys of three states occupied respectively one and three years, and his reports to the states were published by them, with the plan while he drew up a plan for a survey of the state of New York, which was adopted. In 1844 he explored the open wilderness on the southern shore of Lake Superior, and made known its resources. In 1845 he again visited the north and opened mines of copper and mountains of iron ore, which were worked by his assistants, and are now being wrought. In 1847 Dr. Jackson was appointed to superintend a geological survey of the public lands of the United States in and he was thus engaged for two years, on a change of administration at the close of the superintendence was transferred to another. His report of these labors was published in 1850, in 1 vol. 8vo. Dr. Jackson was one of the claimants of the discovery of anæsthetics. His claims are substantiated: In 1834 he discovered that an application of chloroform, when made by a drop on a nerve, renders it insensible to pain, and that if a piece of lint saturated with ether and of one part of chloroform and one part of alcohol is inserted into the cavity of a painful tooth, it allays the pain at once, and repeated applications completely destroy the sensibility of the nerves. Having experimented with exhilarating gases of nitrous oxide, he resumed in 1837 his experiments with that gas in order to test its anæsthetic effects of different modes of application; but the only new result he was able to satisfy himself that the temporary insensibility which it sometimes produces is greater or less degree to partial asphyxiation, but previous to the winter of 1841-2, having received some perfectly pure ether, he tried its effects upon himself by ministering it with a mixture of air, and inhaled it to such an extent as to lose all consciousness, without suffering any dangerous or disagreeable consequence. It had hitherto attended the inhalation of sulphuric ether unmingled with air. In the winter of 1841-2 he was enabled to obtain relief from the very severe pain occasioned by the accidental inhalation of sulphuric ether. The relief he experienced led him to think that a surgical operation could be performed on a patient under the full influence of sulphuric ether, without giving him any pain. Jackson's claims to the discovery

of anæsthetics, disputed by Dr. W. T. G. Morton and Dr. Horace Wells, gave rise to a long controversy. In 1852 a memorial was presented to congress, signed by 143 physicians of Boston and its vicinity, ascribing the discovery exclusively to Dr. Jackson. About the same time the question was investigated by a committee of the French academy of sciences, and on their report the academy decreed a prize of 2,500 francs to Dr. Jackson, and another of 2,500 francs to Dr. Morton. M. Elie de Beaumont remarked in a letter to Dr. Jackson, dated May 17, 1852: "In point of fact, the academy of sciences decreed one of the Montyon prizes of 2,500 francs to you for the discovery of etherization, and it has decreed a prize of 2,500 francs to M. Morton for the application of this discovery to surgical operations." Dr. Jackson has received orders and decorations from the governments of France, Sweden, Prussia, Turkey, and Sardinia. His scientific discoveries have been very numerous. Besides the geological reports above mentioned, he has furnished many scientific communications to the "American Journal of Science and Arts," to the French *Comptes rendus*, and to the *Bulletin de la société géologique de France*. He has also published the results of chemical researches on the cotton plant, the tobacco plant, on Indian corn, and on 88 varieties of American grapes in the United States patent office reports, and a "Manual of Etherization, with a History of the Discovery" (1868).

**JACKSON, John**, an English painter, born at Lastingham, Yorkshire, in 1778, died in London, June 1, 1831. He was assisted in his youth by Sir George Beaumont, and acquired reputation as a portrait painter. He was remarkable for rapidity, having on one occasion for a wager painted the portraits of five gentlemen in a single day, for each of which he received 25 guineas. He was a royal academician, and painted many of his associates.

**JACKSON, Samuel**, an American physician, born in Philadelphia in 1787, died there, April 5, 1872. He was for 28 years professor of the institutes of medicine in the university of Pennsylvania, and occupied for a long time a leading position as a physician and surgeon. He was also popular as a lecturer, and distinguished as a writer. His most important work is "The Principles of Medicine" (Philadelphia, 1832).

**JACKSON, Thomas**, an English clergyman, born at Sancton, Yorkshire, Dec. 12, 1783, died in Richmond, March 11, 1873. He was early apprenticed to a carpenter, but entered the itinerant ministry of the Wesleyan connection in 1804. After 20 years of labor in this profession in Lincolnshire, Lancashire, Yorkshire, and London, in 1824 he was chosen by the British conference "connectional editor" of the Wesleyan church. He continued his editorial service for 19 years, when he was appointed tutor in the Richmond theological institution. This post he held till 1861, when he re-

tired on account of Age. Among his chief literary labors are: "Centenary of Methodism" (1839); "Library of Christian Biography" (12 vols., 1837-'50); "Life of Charles Wesley and Contemporary Events" (2 vols. 8vo, 1841); "Journal of Rev. Charles Wesley" (2 vols., 1849); "Lives of Early Methodists" (3 vols. 12mo, 1849); "Duties of Christianity" (1857); "Providence of God viewed in the Light of Scripture" (1862); and "Curiosities of Pulpit Literature" (1868). He also wrote the preface to the 11th edition of the complete works of John Wesley (15 vols. 12mo, 1856-'7).

**JACKSON, Thomas Jonathan**, an American soldier, born at Clarksburg, Va., Jan. 21, 1824, died at Guinea's station, near Fredericksburg, May 10, 1863. He graduated at West Point in 1846, and served in the war with Mexico, in which he was successively brevetted as captain and major for gallant and meritorious conduct at Contreras, Churubusco, and Chapultepec. He subsequently served on garrison duty in the fortifications in New York harbor, and in Florida during the Seminole war. In February, 1852, he resigned his commission in the army, and was chosen professor of natural and experimental philosophy and instructor in artillery tactics in the Virginia military academy at Lexington. He also became a deacon in the Presbyterian church, and was somewhat noted for his extreme shyness and eccentricities of habit; he was indeed rather a laughing-stock for the students of the academy. On the opening of the civil war he entered the confederate service with the rank of major, and was placed in command at Harper's Ferry. From this moment his demeanor underwent a sudden change. He had before hesitated to lead in prayer at the meetings of his church, and was wont to take his food only in measured quantities. He now seemed inspired with the genius of command, and bore without a thought the extremest hardships of a soldier's life. He was soon made a brigadier general, and took a prominent part in the first battle of Bull Run (July 21, 1861). Here, at a moment when the day was apparently lost, his brigade made so firm a stand that some one cried out, "Here is Jackson, standing like a stone wall;" and thenceforth "Stonewall Jackson" became his sobriquet. In the spring of 1862 Jackson was in command in the Shenandoah valley, where by his celerity and skill he foiled greatly superior Union forces under Banks, Fremont, Shields, and McDowell. (See **CROSS KEYS**.) At the commencement of the seven days' battles on the peninsula he joined the army of Lee, and his command took a leading part in the battle of Cold Harbor (June 27), and a less important one in that of Malvern Hill (July 1). In the ensuing operations against Gen. Pope, Jackson's corps was first sent northward, and fought the indecisive action at Cedar Mountain (Aug. 9). Not long after, having been made a major general, he was placed in immediate command of nearly half of Lee's army, with

which he made a rapid march and gained Pope's rear, whence resulted the second battle of Bull Run (Aug. 29, 30), fought almost on the same ground as the former one. In the Antietam campaign, which immediately followed, Jackson, by a rapid movement, captured a Union force of about 11,000 men at Harper's Ferry (Sept. 15), and then by a forced march rejoined Lee, and took a leading part in the battle of Antietam (Sept. 17). His corps was actively engaged at the battle of Fredericksburg (Dec. 13), and he was made lieutenant general. At Chancellorville (May 2, 1863), at the head of nearly two thirds of the confederate force, he made a march of 13 miles, mostly by forest roads, and turned Hooker's right, upon which he fell by surprise, driving it in rout upon the main body. The engagement being apparently over, he rode into the woods to reconnoitre, having with him only a small escort. Returning, his companions were mistaken for Union scouts and fired upon by his own men. Several of the escort were killed, and Jackson received three balls, one through each hand, and another which shattered his left shoulder. He was placed upon a litter; but one of the bearers stumbled, and he fell to the ground, striking upon his broken shoulder. He was at length carried to the rear, where his arm was amputated. But pneumonia soon set in, which was the immediate cause of his death. Stonewall Jackson is considered by the confederates to have been their most brilliant commander, at least of forces actually engaged in the field. His life has been written by M. Adlay (New York, 1863) and John Esten Cooke (New York, 1866).

**JACKSON, William**, an English composer, born in Exeter in 1730, died in 1803. He pursued his musical studies in London, under Traven, and in 1777 became organist of Exeter cathedral. He is celebrated in England for his songs, canzonets, and trios, which display remarkable tenderness and grace. As a composer of instrumental music he was less successful. He wrote "Thirty Letters on Various Subjects," and "Four Ages, together with Essays." He was also a painter.

**JACKSONVILLE**. **L.** The county seat of Duval co., Florida, port of entry of the district of St. John's, and the largest city of the state, situated on the right bank of St. John's river, 23 m. from its mouth, and at the terminus of the Jacksonville, Pensacola, and Mobile railroad, 155 m. E. of Tallahassee, and 125 m. S. S. W. of Savannah; pop. in 1850, 1,045; in 1860, 2,118; in 1870, 6,912, of whom 3,998 were colored. The population in 1874, including the suburbs, was estimated by local authorities at 12,000. The city is regularly laid out, with streets crossing each other at right angles and shaded with trees. On the N. W. side is a picturesque bluff, covered with fine residences, and commanding a beautiful view of the river. There are several suburban villages, which are connected with the city by ferry. The com-

of Jacksonville is important. The chief is the cutting and shipping of lumber. There are several large saw mills, and the shipment amount to about 50,000,000 feet of cotton, sugar, fruit, fish, and early vegetables are also shipped to northern and southern ports. The value of the foreign commerce for the year ending June 30, 1873, was \$1,000,000, chiefly exports. The entrances were 100 steamers of 8,456 tons, and the clearances 40 of 6,455 tons. In the coastwise trade there were 100 steamers of 69,128 tons and 345 sailing vessels of 66,962 tons; 101 steamers of 69,439 tons, and 100 sailing vessels of 76,089 tons. There were 1,442 tons and 20 sailing vessels of 2 tons belonging to the port. A semi-line of steamers runs to Savannah and New York, and the river steamers furnish daily communication with St. Augustine *via* Tocoi and St. John's railroad and with Palatka, and weekly with Enterprise, 205 m. above Jacksonville. The city is much resorted to by tourists on account of its mild and salubrious climate. It is governed by a mayor and a board of eight aldermen, and contains a branch of Freedmen's savings bank and trust company, 9 hotels, 2 public schools (one white and one colored), a Catholic female seminary, private schools, 2 tri-weekly and 4 newspapers, and 10 churches, viz.: 3 (2 colored), 1 Episcopal, 4 Methodist (2 colored), and 2 Presbyterian. Of the Methodist and Presbyterian churches, one belongs to the northern and one to the southern branch. The Roman Catholic church, burned during the civil war, is nearly rebuilt. A session of the United States circuit and district courts for the Northern District of Florida is held here annually. II. Jacksonville is the capital of Morgan county, Illinois, near Mauvaiseterre creek, an affluent of the Illinois river, 30 m. W. by S. of Springfield, 200 m. S. S. W. of Chicago; pop. in 1850, 745; in 1860, 5,528; in 1870, 9,203, of which 2,098 were foreigners. It is pleasantly situated in the midst of an undulating and fertile prairie at the intersection of the Jacksonville and Chicago and Alton railroad, the Toledo, Wabash, and Western, the Pekin, and Jacksonville, and the Jacksonville, Northwestern, and Southeastern railroads. The streets are wide and adorned with trees; the houses are partly of wood and partly of brick, and surrounded with flower gardens and shrubbery. The principal manufactures are a woollen mill, a machine shop, flour mills, two planing mills, two soap works, an iron foundry, gas works, and a distillery. There are two national banks, with \$1,000,000 capital, and a savings bank. Jacksonville is the seat of the state institution for the education of the deaf and dumb; of the state institution for the education of the blind; of a state hospital for the insane; of the state institution for the education of feeble-minded children;

and of a private insane asylum. Illinois college (Congregational), organized in 1830, in 1874 had 18 professors and instructors, 150 students (50 collegiate), and a library of 10,000 volumes. Illinois female college (Methodist), organized in 1847, had 10 instructors, 172 students (81 collegiate), and a library of 2,000 volumes. Jacksonville female academy had 11 instructors and 218 students (128 collegiate). There are another female college, an academy and commercial college combined, an orphan asylum, seven public school houses with a system of graded schools, including a high school, a daily and three weekly newspapers, a free reading room, a free public library of 1,600 volumes, and 20 churches.

**JACHEL**, a seaport town of Hayti, at the head of a bay of the same name, on the S. coast, 80 m. S. W. of Port-au-Prince; pop. about 6,000. It is divided into the upper and lower town, the former being commonly called Belair; the streets are very narrow in the lower town, and the houses in both are chiefly of wood. The harbor is commodious, and has good anchoring ground for vessels of any size, but is exposed to the S. winds and to a heavy sea setting in toward the shore. It is well frequented by shipping, mostly from the United States, and is a station for the West India mail steamers. The climate is hot and unhealthy.

**JACOB**, the third and last of the Hebrew patriarchs, son of Isaac and Rebekah, and younger twin brother of Esau. Even in his mother's womb he and Esau struggled together, and he was called Jacob (*Ya'akov*, heel-holder) because his hand took hold on his brother's heel at their birth. Esau was a hunter and the favorite of Isaac, but Rebekah loved the gentler Jacob. In his youth Jacob purchased his elder brother's birthright for some bread and pottage of lentiles, which he gave to Esau when he was famishing. At the instigation of his mother he obtained by fraud from his blind father the blessing of the first born. Obligated to flee from his brother's wrath, he went at the command of his father to take a wife from the daughters of Laban, his mother's brother. On his way he saw in a dream the vision of a ladder reaching to heaven, which established him in the belief that he was the heir of the promise made to Abraham. He served seven years for the love of Laban's daughter Rachel, and was then disappointed by finding in his veiled bride her elder sister Leah. He served another seven years for Rachel, and six years longer for a herd, which he greatly increased by an artifice, and then departed with his wives, children, and possessions for the land of Canaan. On his way he met and was reconciled with Esau, immediately preceding which "there wrestled a man with him until the breaking of the day. And when he saw that he prevailed not against him, he touched the hollow of his thigh, and the hollow of Jacob's thigh was out of joint, as he wrestled with him. . . . And he said, Thy name shall

no more be called Jacob, but Israel; for as a prince hast thou power with God and with men, and hast prevailed." He tarried successively at Succoth, Shechem, and Bethel, where the Abrahamic covenant was renewed to him. While journeying toward the residence of his father at Mamre, Rachel died in giving birth to Benjamin. Among his domestic troubles was the loss of his favorite son Joseph, sold by his brethren and carried to Egypt, where he became the highest officer at court. In a famine which followed, Joseph established his father and brethren in Egypt under his protection, and Israel lived 17 years in the land of Goshen, where he died at the age of 147. At his own command he was buried with Abraham and Isaac near Mamre. He was the father of Reuben, Simeon, Levi, Judah, Issachar, and Zebulun by Leah; of Joseph and Benjamin by Rachel; of Dan and Naphthali by Bilhah, Rachel's handmaid; and of Gad and Asher by Zilpah, Leah's handmaid; also of a daughter, Dinah, by Leah. These 12 sons became the heads of the 12 tribes of Israel, and before his death he assembled them and gave them his parting words.

**JACOBÆAN LILY** (*amaryllis formosissima*), a bulbous-rooted plant from tropical America. Its large bulb is covered with a dark skin and has a long flattened neck; planted out in the flower border in May, it throws up its flower stalks before the leaves appear; a bulb usually produces but one, sometimes two flower stalks, each of which produces a large irregular flower, of a most brilliant dark crimson color, which appears two-lipped from the bending down of three of the divisions of the perianth (petals),



Jacobæan Lily (*Amaryllis formosissima*).

which at the base are involute around the lower part of the deflexed stamens and style. After the flowers open the leaves appear, which should be allowed to grow until the approach of frost, when the bulbs are to be taken up, and kept in a dry place, secure from frost, un-

til the following spring. The plant may also be cultivated in pots in the manner given for the hyacinth.—The original genus *amaryllis* has been much subdivided by botanists, some of whom place the plant in question in the genus *Sprekelia*.

**JACOB, Bibliophile.** See LACROIX, PAUL.

**JACOBI, Abraham**, an American physician, born at Hartum, Westphalia, May 6, 1830. He graduated at the university of Bonn in 1851, and was a political prisoner for nearly two years, after which he went to London, and in the autumn of 1853 to New York. Here he acquired reputation in obstetrics and diseases of women and children, and was professor at the New York medical college from 1860 to 1869, and subsequently at the college of physicians and surgeons. He has published "Dentition and its Derangements" (New York, 1862), "The Raising and Education of Abandoned Children in Europe" (1870), &c.; and he was one of the authors of "Contributions to Midwifery," &c. (1859), and from 1868 to 1871 an editor of the "American Journal of Obstetrics and Diseases of Women and Children."

**JACOBI. I. Friedrich Heinrich**, a German philosopher, born in Düsseldorf, Jan. 23, 1744, died in Munich, March 10, 1819. In his 16th year he was sent to Geneva to complete his mercantile apprenticeship, and during a residence there of three years studied mathematics, medicine, and philosophy. On his return to Düsseldorf he was placed at the head of his father's mercantile establishment, and soon after married; but in 1770 he renounced commerce, being appointed councillor of finance for the duchies of Berg and Julich. This office allowed him to indulge his tastes for literature and philosophy, and he was soon associated or in correspondence with Wieland, Goethe, Herder, Lessing, Hamann, Lavater, Richter, Kant, Fichte, Reinhold, and other leading thinkers. His country seat at Pempelfort, near Düsseldorf, was after Weimar and the university towns the most remarkable literary centre in Germany. On the French invasion in 1794 he took refuge in the north of Germany, and passed ten years in Wandsbeck, Hamburg, and Eutin, engaged in literary and philosophical studies, till in 1804 he was called to Munich as a member of the newly formed academy of sciences, of which he became president in 1807. He resigned in 1813, but the title and salary were continued to him till his death. In youth Jacobi had been led to singularly intense religious and philosophical meditations. At the age of eight the idea of eternity struck him so clearly and forcibly that he fell fainting with a shriek. The thought of annihilation and the perspective of an infinite duration long weighed equally upon his mind as terrible and insupportable conceptions. The perusal of Kant's tractate on the proofs for the being of a God produced on him the most violent palpitations of the heart. He at length was able to check this susceptibility, but even in 1787 he affirmed



of that, if he should yield to it, a few ve shocks would kill him. His first vere the philosophical romances *Woldensburg*, 1779) and *Eduard Allwill's mmlung* (Königsberg, 1781), the former h reveals his ethical system, making r a matter of instinctive sentiment, intuition, or divine impulse. It was is purpose to develop any connected and his philosophical writings are all The first was *Ueber die Lehre des Spi- n Briefen an Mendelssohn* (Breslau, n which he assails Spinozism as a type rmal, rationalistic, demonstration-seek- ems. His doctrine is more fully devel- his dialogue entitled *David Hume über uben, oder Idealismus und Realismus* i, 1787). His relation to the Kantian philosophy appeared in his essay *Ueber ernehmen des Kriticismus, die Vernunft tande zu bringen* (1802). His principal besides those already mentioned, are *reiben an Fichte* (Hamburg, 1799), and *n göttlichen Dingen und ihrer Offen-* (Leipsic, 1811), which occasioned a ersy with Schelling. His collected were published at Leipsic (6 vols., l), to which his letters were added (2 325-'7). II. **Johann Georg**, a German other of the preceding, born in Düssel- ec. 2, 1740, died in Freiburg, Baden, 1814. After studying theology and e at Göttingen, he was appointed in fessor of philosophy and eloquence at ecame soon after intimately associated leim, in 1769 received a canonry at tadt, and devoted himself to poetry 1784 he became professor of belles- at Freiburg. His poems are marked ly by grace and purity of diction. His e works were published at Zürich (7 807-'22). III. **Maximilian**, a German n. son of F. H. Jacobi, born in Düssel- pril 10, 1775, died at Siegburg, near ay 18, 1858. He studied at Jena, en, Edinburgh, and Erfurt, was for a istant in a London hospital, and after- irector of an insane asylum at Salz- He early embraced the views of Pinel e on the subject of non-restraint, and to introduce them throughout Ger- About 1820 he was selected to take d of the insane hospital at Siegburg. He d several essays on the treatment of ne, and a work on "Construction and ment of Lunatic Hospitals" (1834), and equent contributor to the *Allgemeine ift für Psychiatrie*. On the 50th any of his doctorate (1857) a festival was his honor, attended by distinguished m England and France as well as from art of Germany. At this festival an ion was organized called the Jacobi ion, for the improvement of physicians, nurses, and attendants in the care of ne.

**JACOBI. L. Karl Gustav Jakob**, a German mathematician, born in Potsdam, Dec. 10, 1804, died in Berlin, Feb. 18, 1851. In 1825, on the recommendation of Hegel, he was sent to Königsberg as instructor in mathematics, and in 1827 was appointed professor of mathematics there. In 1842 he made a journey to England, but on his return was obliged by ill health to resign his professorship, and after visiting Italy resided in Berlin. His importance in the history of mathematics is chiefly due to his discoveries in the theory of elliptic functions, and his principal work is the *Fundamenta Nova Theoria Functionum Ellipticarum* (Königsberg, 1829), besides which he wrote many special memoirs. Under him, Bessel, and Neumann, the university of Königsberg enjoyed a reputation as a school of mathematics surpassed by none in Europe. II. **Moritz Hermann**, a German savant resident in Russia, brother of the preceding, born in Potsdam, Sept. 21, 1801, died in St. Petersburg, March 10, 1874. At the age of 28 he went to Russia to seek his fortune, and soon attracted attention by his researches in physics. In 1830 he constructed a short electric telegraph in St. Petersburg, and in 1832 one of 18 miles between two of the imperial residences, on which he made many experiments, and the important discovery that the earth could be used to complete the electric circuit. In 1837, simultaneously with Thomas Spencer of Liverpool, he invented the process of electrotyping; and in 1840 he published *Die Galvanoplastik*, which gained him admittance into the imperial academy of St. Petersburg. He soon after proposed to the czar the formation of a regiment of galvanic sappers, to be trained in the management of electricity. An immense battery was constructed for him, and he received the title of colonel in the galvanic regiment. He published many memoirs on the applications of electro-magnetism in the collections of the academy of St. Petersburg.

**JACOBINS**, the most celebrated of the clubs of the first French revolution. Its origin is traced to a society established a few days after the opening of the states general at Versailles, in May, 1789, by the deputies from Brittany, called the *club Breton*. On the removal of the constituent assembly from Versailles to Paris, this club established itself there in the old convent of Dominican friars of St. James, or Jacobins, in the rue St. Honoré, admitted any citizen who was presented by four members, and assumed the name of *société des amis de la constitution*, but was also, from its place of meeting, styled Jacobins. It soon became very numerous, not only deputies, but all who aspired to political influence, seeking admission to it. Every political question and every motion was here debated before being presented to the national assembly; the most popular orators participated in the debates, and were anxious to secure the favor of the majority; the club became the controlling power of the

revolution. Extreme opinions gaining the ascendancy in it, its original founders abandoned it, and established the *société de 1789* or *des Feuillants*, where more moderate notions were entertained. The only result was to make the Jacobins more radical and boisterous. They extended their influence all over France, 1,200 branch societies being established previous to 1791, and this number increasing in the following years. All the affiliated societies obeyed orders from the headquarters in Paris. The *Journal de la société des amis de la constitution* was added to the ordinary means of correspondence in May, 1791, and conveyed revolutionary principles to every corner of the kingdom. The Jacobins were foremost in the insurrectionary movements of June 20 and Aug. 10, 1792; they originated the revolutionary *commune de Paris*, which became a formidable power, and changed their former name to *les amis de la liberté et de l'égalité*. From this time they ruled supreme, and for a while the convention itself was but their tool. Robespierre was indebted for his political supremacy to the popularity he had secured among them. The revolution of the 9th Thermidor, which overthrew him, was a fatal blow to the Jacobins; the terror they had inspired gradually vanished; the reactionary affiliation styled *la jeunesse dorée* went in force to attack their headquarters, and the convention issued decrees for the suspension of their meetings and the closing of their hall (November, 1794). The scattered remains of the party attempted to regain influence by establishing the *club du manger*, and then the *club de la rue du Bac*, but in vain.

**JACOBITES.** I. A Christian sect in the East, particularly in Syria and Mesopotamia. They derive their name from Jacobus Baradaeus, bishop of Edessa, who in the 6th century established a permanent ecclesiastical organization among the Monophysites, or those who maintained that the divine and human natures in Jesus Christ were so united as to form only one nature. At the death of Baradaeus in 578, this sect was very numerous in Syria, Mesopotamia, Armenia, Egypt, Nubia, and Abyssinia. The Egyptian Jacobites in the course of ages separated from their Asiatic brethren, and formed the Coptic church. (See *Copt.*) At the head of the Jacobites is a patriarch, who now resides in a monastery near Mardin. Next to the patriarch is the *mphrian*, who was formerly the head of the eastern branch of the Jacobites and had power equal to that of the patriarch. At present he has the jurisdiction of a bishop, retaining of his former prerogatives only the title. He resides in a monastery near Mosul. Formerly there were under the jurisdiction of the patriarch 20 metropolitans and 103 bishops; but this number has been reduced to 8 metropolitans and 3 bishops. The Jacobites are reported to number about 34,000 families. In their church service they use the Syriac language, which is no longer understood

by the people. Those Jacobites who have joined the Roman Catholic communion are called United Syrians. They have a patriarch who has the title of patriarch of Antioch, 4 archbishops, and 8 bishops. The entire population connected with the church is estimated at 30,000. II. A party in Great Britain so called from Lat. *Jacobus*, James, who after the revolution of 1688 adhered to the cause of the dethroned King James II. and his descendants. They were numerous and powerful in Scotland, and for more than half a century continued to conspire for the restoration of the exiled house of Stuart. They rose in unsuccessful revolt in 1715, and again in 1745. Their final extinction as a party may be dated from the death of the pretender Charles Edward in 1788, though they had long before ceased to be formidable to the established government.

**JACOBS.** I. Christian Friedrich Wilhelm, a German author, born in Gotha, Oct. 6, 1764, died there, March 30, 1847. He was for many years in charge of the library and numismatic cabinet at Gotha, and from 1831 to 1842 of all the art collections in that town. He published over 50 volumes, the principal of which are his editions and translations of the classics and his *Elementarbuch der griechischen Sprache* (4 vols., Jena, 1805). II. Paul Emil, a German painter, son of the preceding, born in Gotha in 1802, died Jan. 6, 1866. From 1818 to 1825 he studied in the academy at Munich, where he acquired reputation by his paintings of "The Flight into the Wilderness" and "Adam and Eve finding the Dead Body of Abel." He went to Rome in 1825, where he produced several pictures in the manner of Raphael, among which are the "Resurrection of Lazarus" and the "Rape of Proserpine." In 1830 he returned to Germany, and in 1830 went to St. Petersburg, where he remained till 1834, painting "General Diebitsch in the Camp at Adrianople," and an altarpiece. Returning to Germany, he decorated in fresco a hall in the royal castle at Hanover. In 1840 he went to Gotha, where he became court painter to the grand duke, and produced several successful paintings, among the best of which is "The Sultan and Scheherazade." His "Judith and Holofernes" and "Samson and Delilah" received prizes in Philadelphia in 1850.

**JACOBS,** Jacques Albert Michel, known also as Jacobs Jacobs, a Belgian painter, born in Antwerp in 1812. He studied in Antwerp, travelled in the East, and produced many marine pieces, landscapes, and views of towns. His "Shipwreck of the Florida" and "View of Constantinople" are at Munich.

**JACOBS,** Pierre François, a Belgian painter, born in Brussels about 1780, died in Rome in 1808. He repeatedly won prizes while a student at the academy of Brussels, and became famous by his picture of "The Head of Pompey presented to Cæsar," executed in Rome.

**JACOBSON,** William, an English bishop, born in Norfolk in 1803. He graduated at Lincoln

college, Oxford, in 1827. In 1829 he was elected fellow of Exeter college, and in 1832 was chosen vice principal of Magdalen hall, which post he occupied till 1848, when he was appointed regius professor of divinity in the university. At the same time he became canon of Christ church and rector of Ewelme, and received the degree of D. D. He was also select preacher and public orator for several years, and edited a number of valuable works for the university press. In 1865 he was made bishop of Chester. He has edited *Patres Apostolici* 2 vols. with notes, apparatus, &c., 1840; 3d ed., 1847, "Nowell's Catechism" (1844), the "Collected Works of Bishop Sanderson" (6 vols., 1854), &c., and published two volumes of sermons (1840, 1846).

**JACOBY, Johann**, a German publicist of Jewish descent, born in Königsberg, May 1, 1805. He studied medicine at Königsberg, Berlin, and Heidelberg, and became a distinguished physician in his native city. At the same time he came forward as a politician, and was under arrest in 1841-'3 for having keenly criticized the government in a pamphlet entitled *Vier Fragen*; and other publications resulted in his being sentenced in 1845 to a long term of imprisonment, but he was acquitted on appeal to a superior court. In 1848 he was prominent in the provisional parliament of Frankfurt, and subsequently in the Prussian national assembly as the chief leader of the democratic party. After sitting in the second Prussian chamber during its brief existence in the early part of 1849, he succeeded the historian Kaumer in the German parliament at Frankfurt, soon retiring with that assembly to Stuttgart. Once more accused of treason, he surrendered himself to the authorities at Königsberg, but was acquitted, Dec. 8, 1849. In the same year he declined a seat in the Prussian first chamber, and in 1862 one in the chamber of deputies, but occupied one in the latter in 1864-'5. His sympathy with democracy and socialism, and his opposition to monarchy as the promoter of German nationality, caused him to be arrested in 1866 for obnoxious passages in one of his electoral addresses, and for allusions in the biography of Heinrich Simon which he had published in 1865; and as he continued his agitations after the outbreak of the war with France, he was again placed for some time under arrest in 1870. The next year he declined a reelection by the radicals. Elected a member of the imperial Reichstag in 1874, he renounced his seat, declaring in a letter to his constituents his conviction of the impossibility of transforming a military state into a popular state in a parliamentary way. His writings, some of which are medical, include *Die Grundsätze der preussischen Demokratie* (Berlin, 1859).

**JACOBY, Ludwig Sigismund**, an American clergyman, born in Alt Strelitz, Mecklenburg, Oct. 21, 1811. His parents were Jews, but he was baptized when 21 years old, and joined the Lu-

theran church. A few years later he emigrated to America, and became a member of the Methodist Episcopal church. About 1840 he entered the ministry, and in 1841 was stationed at St. Louis. In 1844 he was presiding elder of the first German district of the far west. In 1849 he returned to Germany to establish a mission of the Methodist church there. Chiefly through his instrumentality, missions were founded in Germany and in Switzerland, and a publishing house and a theological seminary were established at Bremen. For many years he edited and published religious and educational works, and acted as a professor in the theological seminary. To him was intrusted the superintendence of all the missions of his church in Germany and Switzerland, until his return to America in 1872. In 1874 he was pastor of a church in St. Louis, Mo. He has prepared a "Concordance of the Bible," and a "History of Methodism in the Whole World down to 1869."

**JACOTOT, Joseph**, a French educator, born in Dijon, March 4, 1770, died in Paris, July 30, 1840. When scarcely 19 he became professor of Latin and Greek literature at Dijon. He enlisted in 1792, was elected captain of artillery, participated in the campaign of Belgium, and was called to Paris to assist in the central board for the manufacture and improvement of gunpowder. He afterward returned to Dijon, where he was successively professor of mathematics and of Roman law. During the hundred days he was elected to the chamber of deputies, favored the cause of Napoleon, and was consequently compelled to leave France. He took refuge in Belgium, where he first made a living by private teaching; in 1818 he was appointed lecturer on the French language and literature in the university of Louvain, and a little later director of the military school of Belgium. He now brought forward his new system of intellectual emancipation, designed to enable every one to learn without a teacher. In 1830 he returned to his native country, lived seven years in Valenciennes, and then went to Paris, where he spent his last years in comparative obscurity. He published *Enseignement universel: Langue maternelle* (Louvain, 1822); *Langue étrangère* (1823); *Musique, dessin et peinture* (1824); *Mathématiques* (1828); *Droit et philosophie panécstiques* (Paris, 1837); and numerous articles in the *Journal de l'émancipation intellectuelle*, which he had established for the diffusion of his doctrine.

**JACQUAND, Claudius**, a French painter, born in Lyons in 1805. He early became known by historical and genre pictures, and settled in Paris in 1838, where he married a daughter of Count de Forbin-Janson. Among his principal works are "Charlemagne crowned as King of Italy," "The Chapter of Rhodes," and others in the museum of Versailles. His fine picture of "The Mayor of Boulogne refusing the Capitulation of Henry VIII." is in the town hall of that city; and another of his most remarkable works, representing "St. Bonaven-

tura declining a Cardinal's Hat," is in the Luxembourg. His latest productions include "Dante at Rome" and "Guy of Arezzo and his Pupils" (1868).

**JACQUARD, Joseph Marie**, a French mechanician, born in Lyons, July 7, 1752, died at Oullins, Aug. 7, 1834. His parents were weavers, and his father, having become the proprietor of a loom, was enabled to give him a few months' schooling, the only education he ever received. When 12 years old he was apprenticed to a bookbinder, and subsequently in succession to a cutler and a type-founder, in which occupations he produced a variety of models and inventions. At about the age of 20 he succeeded, upon the death of his father, to a small workshop containing two looms, and commenced business as a weaver. Absorbed in plans for improving looms, and in a variety of other mechanical schemes, he neglected his business, and not only exhausted his father's savings, but was obliged to sell his workshop and fixtures to pay his debts. He married the daughter of an armorer, hoping with the aid of her dowry to retrieve his fortunes; but was disappointed, and finally obliged to seek employment with a lime burner in Bresse, while his wife gained a scanty living for herself and her son in Lyons by making straw bonnets. From about 1777 to 1792 there is no account of his life. In the latter year he embraced the cause of the revolution, but in 1793 was one of the defenders of Lyons against the army of the convention. After the reduction of the city he fled with his son, a boy of 15; and both were soon after enrolled in the army of the Rhine. They fought side by side in several engagements; but after the death of his son in battle Jacquard returned to Lyons, and joined his wife in straw weaving. When Lyons began to recover from the effects of the siege, he found employment with a wealthy and intelligent silk manufacturer, who encouraged his schemes for the improvement of pattern-weaving machinery. With a view of substituting mechanical action for that of a numerous class of workmen, who by the very nature of their employment were doomed to a premature death, he produced in 1800 the first model of his apparatus for superseding the use of draw-boys in weaving figured goods, the idea of which had occurred to him, it is said, as early as 1790. In addition to economy of labor, the apparatus greatly simplified the weaving of rich designs, and could be readily applied at slight expense to any loom. He exhibited his invention in the exposition of national industry in 1801, and obtained a bronze medal. Not long after he produced a machine for weaving nets without the use of a shuttle, which came under the notice of the prefect of police, before whom the inventor was summoned to appear. Subsequently he and his machine were conveyed to Paris and underwent an examination by Napoleon and Carnot, the latter of whom asked Jacquard if he was

the man who pretended to do the impossible, *i. e.*, to tie a knot in a stretched string. No satisfactory did the explanation prove that Jacquard received a gold medal, and was commissioned to examine and repair the machines and models in the *conservatoire des arts et métiers*, among which was a loom invented by Vaucanson, which is said to have suggested to him the principal improvements embraced in his own. This, however, is believed to be erroneous. In 1804 he returned to Lyons to find himself assailed with abuse and open violence by those whom the introduction of his apparatus had temporarily thrown out of employment. He was denounced as the man who was reducing families to ruin and starvation; his house was entered by a mob, who broke one of his looms in pieces; and on several occasions he barely escaped from their rage with his life. These scenes, however, soon gave place to a general acquiescence in the invention, which was purchased by government in accordance with an imperial decree, dated Berlin, Oct. 27, 1806, and made public property. Such was the increased production of woven fabrics in Lyons, and its consequent rapid growth, that Jacquard came to be as highly esteemed as he had formerly been detested. Although strongly urged to settle in England, he preferred to devote himself to perfecting his invention in his native city, where he lived until the death of his wife. He passed his latter years in the neighboring village of Oullins. During his life he received the cross of the legion of honor, and in 1840 a statue of him was erected in Lyons. (See WEAVING.)

**JACQUELINE OF BAVARIA**, countess of Hainaut, Holland, Zealand, and Friesland, born in 1400, died in 1436. She was the only daughter and heir of William VI. of Bavaria, count of Holland and Hainaut, and of Margaret of Burgundy. At the age of five years she was, by a treaty between her father and Charles VI. of France, betrothed to Prince John, brother of the dauphin, himself a child. In 1418, upon the death of his brother, John became dauphin, but continued to reside with his father-in-law. In 1417 he returned to France, but three days after his arrival there was killed by poison. The same year Jacqueline succeeded to her father's estates and dignities. Henry V. of England solicited her hand for his brother the duke of Bedford, but she married her cousin german John IV., duke of Brabant, a boy in his 16th year. She soon left him, and lived at first at Valenciennes with her mother. In 1420 she went to England, where Henry V. welcomed her and gave her a pension of £100 a month, and Humphrey duke of Gloucester, the king's brother, sought to marry her, treating her marriage with the duke of Brabant as invalid. Their marriage was delayed by King Henry, lest it should interrupt his friendly relations with the duke of Burgundy, who supported the cause of his cousin John of Brabant. After the death of Henry V. the antipope Bene-

III. annulled her former marriage, and in she married Gloucester, who at once deeded her estates, and entered Hainaut with rith 5,000 troops to reclaim them. A nge passed between the dukes of Glou- and Burgundy, and they agreed to settle ispute by single combat. Both withdrew troops, and Gloucester returned to Eng- leaving Jacqueline, at the entreaty of the ns, in Mons. The duel was forbidden by ope, and the duke of Brabant resuming ar, Jacqueline was treacherously given r the citizens to her enemies. She was oned in Ghent, but escaped in male attire rseback by night, and fled to Holland, e she was welcomed, and sustained against urgundians in a war of two years. In 1426 rke of Brabant died, and she resumed itle of duchess of Gloucester; but Glou- helped her little, and at length she made ity with the duke of Burgundy, making her heir and guardian of her fortresses, reed not to marry without his consent, irtually disavowing her marriage with ester, who soon publicly married Eleanor am. In disregard of this treaty Jacque- arried in 1432 a private gentleman named is of Borselen, governor of Zealand. The of Burgundy arrested and imprisoned len, and Jacqueline purchased his libera- y surrendering to Burgundy all her es- reserving to herself only a small annuity. ied three years later without issue.

**QUEMART, Albert**, a French author, born ris in 1808. At an early age he became k in the ministry of finance, and in 1865 ade chief of bureau in the custom-house tment. He was prominently connected the universal exposition of 1867. His s include *Histoire antique, industrielle et erciale de la porcelaine* (Lyons, 1861-'2), *Histoire de la céramique* (Paris, 1872); sh translation by Mrs. Bury Palliser, "History of Ceramic Art," with 1,000 ations, (London, 1873).—His son JULES INAND, born in 1837, excels as an engi- and has prepared many designs for some father's works.

**QUEMONT, Victor**, a French traveller and alist, born in Paris, Aug. 8, 1801, died in ay, Dec. 7, 1832. After studying botany Adrien de Jussieu, he visited North ica and Hayti. While in Hayti he ed a scientific voyage to the East Indies, aying his project before the directors of useum of natural history, received the ntment of naturalist and traveller to that ation. Returning to France, and after- visiting England, he was elected fellow e Asiatic society, and finally sailed from in August, 1828. He arrived at Calcutta i, 1829, and, having acquired some knowl- of Indian languages, started on his trav- rland, Nov. 20. After visiting some of nglish provinces, he explored the Hima- ountains toward Thibet, and penetrated

as far as Chinese Tartary. Returning, he was invited by Gen. Allard to the kingdom of La- hore, where Runjeet Singh received him with marked favor, and offered him the vicereignty of Cashmere, but Jacquemont preferred to con- tinue his travels. He died of a disease con- tracted in his ramblings through the pestilen- tial forests of Salsette island. His *Correspon- dance* with his friends and relatives (2 vols. 8vo, Paris, 1834) is one of the most attractive and original books of travel ever published; and the diary of his *Voyage dans l'Inde pendant les années 1828 à 1832* (6 vols. 4to), published at the expense of the French government, em- bodies a large amount of valuable zoölogical and botanical observations.

**JACQUERIE**, a French servile insurrection of the 14th century, called after its leader, Guil- laume Caillet, or Charlet, of Clermont, who assumed the name Jacques Bonhomme, which the barons had long derisively applied to the peasants on account of their meek submission to oppression. Smarting under the insolence and rapacity of the nobles and driven to de- spair by the burdens and vicissitudes of the war with England, and particularly by the disas- trous battle of Poitiers, the peasants rose in the vicinity of Beauvais, May 21, 1358, and the insurgents in various parts of the country speedily numbered more than 100,000, com- prising besides the poor peasantry some of the well-to-do middle classes. They destroyed over 200 castles and mansions, and spread ter- ror far and wide. The duchess of Orleans and 300 other ladies sought refuge in Meaux. Here the insurgents were overwhelmed early in June by the troops of the nobles, who massa- cred their force of 9,000 men, and put to death the mayor of Meaux, who had enabled them to enter the town. The peasants never recov- ered from this disaster. Many of them surren- dered, and Jacques Bonhomme and his com- panions were treacherously tortured and slain by Charles the Bad, king of Navarre, who routed the rest of their followers. The insur- rection, though lasting barely three weeks, was attended with great horrors, upward of 20,000 peasants being killed, and for a long time they continued to be persecuted.—See *L'Histoire véritable de Jacques Bonhomme*, by A. Thierry (published in the *Censeur européen*, Paris, 1820); *La Jacquerie, scènes féodales*, by Prosper Mérimée (1828); and *Histoire de la Jacquerie*, by Siméon Luce (1860).

**JACQUES CARTIER**, a county of Quebec, Can- ada, occupying the W. portion of Montreal island; area, 87½ sq. m.; pop. in 1871, 11,179, of whom 9,766 were of French descent. It is mostly level, with a fertile and well cultivated soil. It is traversed by the Grand Trunk rail- way. Capital, Pointe Claire.

**JACQUIER, Nicolas**, a French orthopedist, born at Troyes in 1790, died at Ervy, department of Aube, Oct. 13, 1859. He graduated at Paris in 1813, and became military surgeon in the campaigns of 1814. Subsequently he resided

at Ervy, and acquired fame in orthopedics by his work *De l'emploi des moyens mécaniques et gymnastiques dans le traitement des difformités du système osseux* (4 vols., Paris, 1831-'5), substituting pressure for extension, and by other kindred writings.

**JACQUIN, Nicolas Joseph von**, baron, an Austrian botanist, born in Leyden, Feb. 16, 1727, died in Vienna, Oct. 24, 1817. He was descended from a French family who had emigrated to Holland, was a friend of Gronovius, and completed his studies in Paris under Jussieu, and in Vienna, where he settled. In 1753 the emperor Francis I. commissioned him to lay out the garden at Schönbrunn; and from 1754 to 1759 he travelled in the West Indies and South America to collect new plants for it and for the imperial garden at Vienna. After his return he became professor in a provincial town, and subsequently he was professor of botany and chemistry at the university of Vienna, and was raised to the nobility in 1806. He discovered about 50 new genera of plants, some of which bear his name. His principal works are: *Selectarum Stirpium Americanarum Historia* (fol., with 183 colored plates, Vienna, 1763 and 1781, and Mannheim, 1788); *Hortus Botanicus Vindobonensis* (fol., 1771, with 300 plates); *Flora Austriaca* (fol., 1773-'7, with 500 plates); *Plantarum rariorum Horti Cæsarei Schönbrunnensis Descriptiones et Icones* (9 vols. fol., 1797-1804); and *Genitalia Asclepiadearum Controversa*, published in 1811 in his 84th year.—His son JOSEPH FRANZ (1767-1839) was professor of botany and chemistry, and director of the botanical garden at Vienna, and the author of a manual of medical chemistry which had several editions.

**JADE**, or *Jahde*, a small navigable river of Germany, in the grand duchy of Oldenburg, which falls into Jade bay S. W. of the mouth of the Weser. This bay, which covers an area of 74 sq. m., was formed in 1511 by a tempest which inundated five parishes. A tract of land adjacent to the mouth of the Jade was purchased by Prussia from Oldenburg in 1853 for the purpose of constructing a war port, which in 1869 was opened in the presence of the king of Prussia. (See WILHELMSHAVEN.) The "Territory of Jade," which had an area of 1,31 sq. m. and in 1871 a population of 3,789, was administered by the Prussian admiralty till March 23, 1873, when it was incorporated with the Aurich district of the province of Hanover.

**JADE NEPHRITE**, a mineral of variable composition, chiefly consisting of silica, magnesia, and lime, used as an ornamental stone, for which it is adapted by its close texture and susceptibility of taking a fine polish. It is tough, translucent, of about the hardness of quartz, specific gravity 3, and of bluish, light green, or flesh color. It fuses with great difficulty into a white enamel. It is found with the metamorphic slates and limestones.

**JADIN, Louis Emmanuel**, a French composer, born at Versailles, Sept. 21, 1768, died in Paris

in July, 1853. He received instruction in music from his father and brother, and in 1802 became a professor at the Paris conservatory, and in 1814 governor of the king's musical pages. His compositions are very numerous, including 39 operas and operettas, many pieces for military orchestra, a great variety of chamber music for reed and stringed instruments, and compositions for piano alone. The whole number of his works was 74. Though popular in their day, they have fallen into oblivion.

**JADIN, Louis Godefroy**, a French painter, born in Paris in 1805. He first produced genre and historical pictures, but his reputation rests on his hunting pieces. His numerous representations of packs of hounds are celebrated.

**JAELL, Alfred**, a German pianist, born in Trieste, March 5, 1832. His father was a violinist, and gave him his first instruction. At 11 years of age he was able to undertake a concert tour, appearing first in Italy and afterward in France. In 1848 he came to America, and during a residence of several years in the United States obtained much reputation. Returning to Europe, he passed his time in concert giving in Germany, Russia, France, and Holland, and was appointed pianist to the king of Hanover. His compositions for piano number about 140, and are of considerable merit, consisting mainly of operatic transcriptions. Although he possesses great executive power and brilliancy, he is esteemed a player of the second order.

**JAEN**. I. A province of Spain, in Andalusia, bordering on New Castile, Murcia, Granada, and Cordova; area, 5,184 sq. m.; pop. in 1870, 392,100. The N. part is entirely filled with the ridges of the Sierra Morena; the central is an irregular valley, in which several streams unite to form the Guadalquivir. The soil is fertile, but little cultivated. The province produces grain, wine, fruits, oil, honey, and various minerals, and abounds in cattle and fine horses; silkworms are bred there. The trade, however, is not extensive. Among the principal towns are Andujar, Alcalá la Real, Baylen, and Ubeda. II. A fortified city, capital of the province, on the river Jaen, 40 m. N. of Granada; pop. about 23,000. The new town stretches beyond the walls into the plain along the river. It has two cathedrals, the principal of which occupies the site of a Moorish mosque which was demolished in 1492. A new *plaza de toros* was built in 1847. Jaen has been a bishopric since the 13th century, when the Moors were expelled from the city. The place is poor notwithstanding its fertile environs. In 1808 it was sacked by the French.

**JAFFA**, or *Yafa* (anc. *Joppa*; in the Hebrew Scriptures, *Japho*), a town and port of Palestine, 35 m. N. W. of Jerusalem; pop. about 10,000, of whom 4,500 are Moslems, 3,000 Christians, and about 500 foreigners and Jews. It is picturesquely situated on a little rounded hill, dipping on the west into the Mediterranean, and surrounded on the land side by orchards; the oranges are the finest of Syria. The town

looks well from a distance, is a labyrinth of alleys and dilapidated lanes and streets. Lines of Austrian, French, and Russian consulates ply between Jaffa and European and Egyptian ports. English and Egyptian steamers and a considerable number of sailing vessels come occasionally. The present harbor consists of a strip of water nearly 100 yards wide, enclosed by a reef of rocks forming a kind of breakwater, which affords shelter to small vessels. Jaffa, being the port for Jerusalem, and of the whole south as far as Gaza, is a place of great importance. The chief exports are oils, soap, raisins, cotton, wool, colorings, and lemons; imports, manufactures, rice, coffee, tea, and sugar. There are several insignificant mosques and convents, and the town still retains

some of its ancient fortifications; but it is now chiefly celebrated as a landing place of European pilgrims on their way to Jerusalem.— Tradition gives to Jaffa an antediluvian existence. Among the maritime towns allotted to the tribe of Dan we find the name of Japho. It was the port at which the cedar and pine from Lebanon for the building of the temple of Solomon were landed. Jonah embarked thence for Tarshish. Peter the apostle resided in the house of "Simon the tanner." A house reputed to be the place where he had the vision is still pointed out to pilgrims. The town suffered much in the wars of the Asmoneans, and at the outbreak of the war with the Romans it was burned by Cestius Gallus and 8,000 of the inhabitants were slain. It was an important station during the crusades, and was finally taken by the Mohammedans from



Jaffa.

Christians at the end of the 12th century. In 1799, when a large garrison were massacred at his command, the French suffered terribly there from the effects of the plague. It was taken by Mehemet Ali in 1832, and retaken by the Turks in 1840.

In 1866 a small colony of Americans was established to establish a settlement there, but on account of internal discord, and most of them returned home. They were succeeded by a small man colony, which is yearly increasing.

**JAFFNAPATAM, or Jaffna.** I. A peninsular island of Ceylon, on the N. W. coast, of an irregular shape; area, 700 sq. m.; pop. about 100,000. It is traversed by two long and narrow lagoons, and the surface of the peninsula is broken by a single hill. Large fields of paddy and breccia have been elevated on the shore in consequence of the gradual subsidence of the W. coast, and have formed

shallow estuaries which contain large deposits of excellent salt. A still more abundant production is the palmyra, 200 trees to an acre being below the ordinary rate, and the number of palms is estimated at nearly 7,000,000, supplying food for nearly one fourth of the population. Water is scarce, but skilful irrigation favors the rice crops, and many fruits are raised in gardens formed of artificial mould. The sheep reared on the dry plains of the district are the finest of Ceylon, and cattle abound. The staple product is tobacco. The first crop of it needs high preparation, but three subsequent crops are obtained without additional manuring. It is chiefly sent to Travancore for account of the rajah of that place. II. A town, capital of the district, on the W. shore of the peninsula, in lat. 9° 47' N. and lon. 80° 9' E., about 200 m. N. of Colombo; pop. about 8,000. It is protected by a fort, the best in Ceylon,

consisting of a pentagon built of blocks of white coral and surrounded by a moat. The streets are broad and shaded by surca trees; the houses are of only one story, but are spacious and have fine verandas, and most of them stand detached in enclosed gardens. There are many fine buildings, including a church in the shape of a Greek cross and a mansion for the English commanding officer. The whole place resembles a Dutch town in its apparent cleanliness, and is singularly rich in flowers. Tamils and Moors reside in the native part of the town, and are intelligent and laborious tradesmen. Cotton cloth, jewelry, and cocoonut oil are manufactured, and there is much trade carried on in the bazaars.

**JAGELLON**, a Polish royal family, founded by Jagello or Jagiello, a pagan grand duke of Lithuania, who embraced Christianity and became king of Poland under the name of Ladislas II., consequent upon his marriage in 1386 with the Polish queen Hedvig, a daughter of Louis the Great, king of Hungary and Poland. He reigned till his death in 1434, and his dynasty, one of the best Poland ever had, expired with Sigismund Augustus in 1572; but the female line was perpetuated, through the marriage of the sister of Sigismund Augustus with Sigismund III., until the abdication of John II. Casimir, son of the latter (1668). Jagello's son Ladislas III. became king of Hungary under the name of Vladislas I., and a few other members of the family subsequently ruled over that country and over Bohemia, while intermarriage with the houses of Brandenburg, Saxony, and Brunswick established an extensive relationship between the Jagellons and many other dynasties. (See HUNGARY, LADISLAS II., LITHUANIA, and POLAND.)

**JAGEMANN, Karoline**, a German actress, born in Weimar in 1778, died in Dresden in 1847. She was a daughter of Christian Joseph Jagemann (1735-1804), a translator of Italian works into German, and brother of the painter Ferdinand Jagemann (1780-1820). Her father having become librarian to the duchess Amalie of Weimar, the latter had her carefully educated. Her great beauty and histrionic and vocal talents secured her success in opera as well as in the drama, and made her a favorite of Goethe, and particularly of the grand duke Charles Augustus, who presented her with the domain of Heigendorf and raised her to the nobility under that name.

**JÄGER, Gustav**, a German painter, born in Leipsic, July 12, 1808, died there, April 29, 1871. He studied in Dresden, Munich, and Rome, assisted his former master Schnorr in fresco paintings in Munich, and executed many works of the kind in that city and in Weimar. In 1847 he became director of the Leipsic academy of fine arts. His productions include "The Death of Moses," "The Interment of Christ," and an altarpiece for the new church in Lengsfeld.

**JAGIELLO.** See JAGELLON.

**JAGUAR** (*Felis onca*, Linn.), the largest of the American carnivora; from its size, strength, and ferocity it is often called the South American tiger. It inhabits the warmer part of America, from Paraguay as far north as Red river in Louisiana; it is considerably larger than the cougar, and but little inferior to the tiger. There is considerable variation in the size and markings, the height at the shoulder ranging from 2½ to 2¾ ft., and the ground color from brownish to ashy yellow; the sides are marked with open circles of black, enclosing a light area with one or more dark spots; these markings, however, vary much in different animals, and even on the two sides of the same animal; there are no distinct stripes, and the lower parts



Jaguar (*Felis onca*).

are white; the tail reaches the ground, being shorter than in the leopard and panther. The jaguar lives solitary in thick forests, especially in the neighborhood of large rivers, but is occasionally driven by hunger into the cultivated districts; it is an excellent climber and swimmer, preying upon living animals and fish; its strength is such that it kills and drags off an ox or a horse with ease; its favorite mode of attack is to leap upon the victim's back, and by placing one paw on the head and the other on the muzzle to break the neck by a single effort; it is said to stand in shallow water and throw out fish on the shore with its paws; according to Humboldt, it is very fond of turtles, digging up the eggs, devouring the young, and clearing out the flesh of the larger ones with great skill; it rarely attacks man unless pursued or pressed by hunger, and then is very formidable. Jaguars are now comparatively rare, but Humboldt states in his "Personal Narrative" that 2,000 skins were exported annually from Buenos Ayres alone, in which vicinity their depredations were formerly very extensive; their skins are handsome, and are esteemed for robes. It is occasionally seen in menageries, and, when taken young, is susceptible of partial subjec-



It is sometimes called ounce (Port. *onça*), properly pertaining to an Asiatic species (See OUNCE.)

**DE.** See JADE.

**V. Friedrich Ludwig**, a German patriot, at Lanz, Prussia, Aug. 11, 1778, died in rg, Baden, Oct. 15, 1852. In 1809 he Berlin, became a teacher at the Kōl- gymnasium, and published *Deutsches hum*, in the style of his friend Fichte's *An die deutsche Nation*. From patriot- ives he established gymnasia where men were fitted to endure the fatigues r. From these gymnasia, which spread rmany, is derived the *Turnkunst* or of physical culture. In 1813 Jahn re- the command of a battalion of volun- with which he entered Paris. After the he returned to Berlin, where he deliv- series of lectures distinguished for bold ility, and continued to labor for his sia, which for a time were encouraged ernment. But when it was found that ed at establishing a united Germany, at his *Turner* schools were political eral clubs, they were all closed in 1819, was imprisoned successively in Span- üstrin, and Colberg. Liberated after ars' confinement, he went to Freiburg, he was a professor for many years. there he received an invitation to be- professor of German literature at Cam- Mass., which he declined, saying that and hares love to live where they are unted." In 1848 he was a member of tional assembly at Frankfurt. A monu- o him, on the Haaseneide, near Berlin, rmally unveiled Aug. 2, 1872.

**V. Johann**, a German orientalist, born at z, Moravia, June 18, 1750, died in Vi- Aug. 16, 1816. From his youth he was d to the study of the eastern languages. r removed to Vienna, he was appointed or of dogmatic theology and of oriental ire in the imperial university; but in e was compelled to resign on account of erodox opinions, and was appointed can- he metropolitan church of St. Stephen. s the author of various philological and ical works, the most important of are his Chaldean, Arabic, Syrian, and r grammars; his *Introductio in Libros Veteris Testamenti* (1804; 3d ed., 1825; ted into English by Drs. Turner and ngham, New York, 1827); and his *Bi- Archæologie* (2 vols., 1797-1800; trans- y Prof. Upham, Andover, 1839).

**ŷ. Otto**, a German philologist, born in une 16, 1813, died in Göttingen, Sept. l. He studied in Kiel, Leipsic, Berlin, and Rome, and was successively profes- Kiel, Greifswald, and Leipsic till 1851, he was suspended on account of his sm in 1848-'9. In 1855 he was trans- to Bonn. He was eminent as an ex- r of classical archæology and philology.

Among his numerous works are valuable edi- tions of Latin classics, instructive works re- lating to ancient Greek and Roman art, and a celebrated biography of Mozart (4 vols., Leip- sic, 1856-'9; 2d revised ed., 1867). He wrote an essay on Goethe's *Iphigenia*, edited Goethe's letters to his Leipsic friends, and published *Ludwig Uhland* (1863), *Gesammelte Aufsätze über Musik* (1866), *Biographische Aufsätze* (1867), and *Aus der Alterthumwissenschaft* (Bonn, 1868).

**JAHB, Georges Henri Gottlieb**, a French physi- cian, born in Gotha, Germany, Jan. 30, 1801. After studying under Hahnemann, he took his degree of M. D. in Paris in 1840, and became a permanent resident of that city. Many of his numerous works have been published both in French and German, and translated into Eng- lish by Hempel and others. Among them are treatises on the homœopathic treatment of cholera, of nervous and mental diseases, diseases of the skin, &c., and a "Homœopathic Pharmacopœia."

**JAINS**, or **Jainas**, a religious sect of India; once dominant in the Deccan, now scattered over the whole peninsula. Their faith is a mix- ture of Brahmanism and Buddhism, and vari- ous accounts are given of its origin. Some suppose that it preceded the rise of Buddhism, but its history can hardly be traced to the 2d century A. D. On the Coromandel coast it was introduced in the 8th or 9th century, in the reign of Amoghversha, king of Tonda Mundalam. The compiler of the Jain Purânas of the Deccan is said to have written at the end of the 9th century. Hema Chandra, one of the greatest scribes of the Jains, flourished in the latter part of the 12th century, to which time also the composition of the Kalpa Sutra must be assigned. About 1174 the Jain faith became that of the ruling dynasty of western Marwar and the territory subject to the princes of Guzerat. Numerous temples, caves, and in- scriptions of ancient date are ascribed to the Jains, but it is scarcely possible to determine their age and nature. True Jaina caves occur at Khandagiri in Cuttack, and especially in the southern parts of India. A number of colossal figures, 30 to 40 ft. high, cut in the rocks of Gwalior Fort, are by some supposed to date from about the 10th or 12th century B. C., which is of course a matter of great doubt. Five Jain images in marble have been dug up at Ajmeer, with a Prakrit inscription and a date corresponding to A. D. 1182 on one of them. The principal seats of the Jains at present are the mountains Aboo and Girnar in Guzerat. At the latter place are the most ancient of their temples, some of them mag- nificent in structure; and at Mount Aboo is their most sacred shrine in Guzerat. The li- braries of Jessulmeer, Anhulwarra, Cambay, and other places contain thousands of volumes of Jain literature. The Oswal tribe, so called from Ossi, their first settlement, professing the Jain tenets, are one of the most influential

mercantile classes of India. The sect is said to be very numerous, and most of the officers of state and revenue are from the Jain laity.—The points in which the doctrines of the Jains differ from Brahmanism are, according to Wurm: 1, the rejection of the Vedas as an infallible guide of faith, and the substitution of their own religious literature, consisting of four Yogas, several Siddhantas, a number of Agamas, a few Angas and Upangas, and 24 Purānas, legends of the saints; 2, the adoration of 24 mortal saints, Tirthankaras, whose ascetic life raised them above the gods; and 3, the *ahimsā*, or prohibition against killing living beings. While in these respects there is an approach to Buddhism, there are others which remove the Jain religion from it. Atheism is not its starting point, but rather an attempt at monotheism. There is a god called Arugan or Jinan, from whom it is supposed that the Jains derive their name, and to whom 1,008 various appellations are given. His worship is believed to be that of the earth, the air, and the heavens. (See INDIA, RELIGIONS AND RELIGIOUS LITERATURE OF.) He is omniscient, and in his grace he communicates his thoughts to all creatures without the aid of their mind, word, or body. Nevertheless he is no creator, though himself uncreated and immortal. He says there is no god besides him; blessed are those who adore him; and all are rewarded according to their deeds. There is a hell, and there is a place where the gods dwell. Whoever is good and bad in an equal measure will be reborn as a human being; he who is rather bad than good will be an unreasoning animal; and he who is either predominantly bad or good will go accordingly either to the infernal or divine abode. Arugan has 24 attributes, which are ascribed to the 24 Tirthankaras as incarnations of divine apprehensions, and who are worshipped in images and at temples and feasts. There is no destruction and no renewing of the world; it is eternal and uncreated. Time is divided into *yugas*, each of which has an ascending or *utsarjini* and a descending or *avasarjini* period. There are also *manvantaras*, and the present Manu, Nābi Mākrajā, is sometimes called Brahmā. It was in his reign that the 24 Tirthankaras were born, and Vrishabha was the first. They attained unto knowledge and blessedness without the aid of a *guru*, and they are the true *śūdras* or equals of Arugan. Jain priests are either *śāhūs*, pious, or *yatis*, self-restrained, and *digambaras*, naked, or *śvētāmbaras*, clad in white. The Jains are opposed to the ancient system of castes, and allow it only as a distinction of occupations. It is said that there are about 50 families of Jain-Brahmans in Mysore, but on the whole it seems that the sect has found the largest number of votaries among the ancient Vaisyas. Jain priests never marry, but lead a *śāhū* or pure ascetic life. Widows never remarry. The men are generally well educated, but the women are kept in ignorance. Young widows, however, commonly de-

vote themselves to the priests, with whom they live, and from whom they learn to read the sacred books of their religion, whereby they become in fact like priestesses. The priests and strict Jains are scrupulously careful to avoid destruction of animal life. They move about with a cloth over their mouths to prevent insects from entering; they use constantly a small brush or broom to sweep aside all living creatures; and they never partake of stale food, lest in the interval since its cooking animalcules may have formed in it.—See Elliot, "On the Characteristics of the Population of India" (London, 1869), and Wurm, *Die Geschichte der Indischen Religion* (Basel, 1874).

**JAKOB, Ludwig Heinrich von**, a German author, born at Wettin, near Halle, Feb. 26, 1759; died at Lauchstädt, July 22, 1827. In 1780 he was appointed teacher at the gymnasium in Halle, and in 1791 professor of philosophy in the university. He was very popular as a lecturer on metaphysics, but after 1800 turned his attention especially to political economy. When the university of Halle was broken up by Napoleon, he went to Kharkov in Russia as professor of political sciences. He distinguished himself as member of a committee appointed to suggest reforms in the finances of the empire, and received various tokens of regard from Alexander I. He was soon after appointed chief reviser of the criminal laws, and received a place in the department of finance. In 1816 he returned to Halle as professor of political science. A fourth edition of his *Grundriss der allgemeinen Logik* appeared in 1800; of his *Grundriss der Erfahrungswissenschaften* in 1810; and a third edition of his *Lehrbuch der Nationalökonomie* in 1825. Prof. Jakob was the father of "Talvj," the wife of the late Prof. Edward Robinson.

**JAL, Auguste**, a French author, born in Lyons, April 12, 1795. He became known as the author of numerous works on art, and especially on maritime archaeology, including *Scènes de la vie maritime* (3 vols., Paris, 1832); *Archéologie navale* (2 vols., 1839); *Glossaire nautique*, which obtained the second Gobert prize (1848); and *La flotte de César* (1861). He published in 1864 *Dictionnaire critique de biographie et d'histoire*, with the view of revising errors and of filling up gaps in cyclopædias.

**JALABERT, Charles François**, a French painter, born in Nîmes in 1819. He studied under Paul Delaroche and in Italy, executing there his famous picture of "Virgil reading his Georgics to Mæcenas in presence of Horace and Varus," which he exhibited in 1847, and which is in the Luxembourg. His "St. Luke" (1852) is at Sèvres, and his "Annunciation" (1853) is in the ministry of state. He excels both as a religious and as a genre and landscape painter. His works include "The Farewell of Romeo and Juliet," "Raphael at work on the Madonna di San Sisto," "Christ walking on the Sea," "Villanelle" (a Roman landscape), and many female portraits.

**JALAP**, a well known purgative drug, first introduced into England from Mexico in 1609. The plant grows wild near the city of Jalapa, and was known to the Mexicans as *purga de Jalapa*; that city being the point of export, the drug retains its name, being known in the pharmacopœias as jalapa, and in commerce and popularly as jalap. The drug was in use for over two centuries before the plant which furnishes it was known; at one time it was supposed to be the root of a species of *mirabilis*, now common in our gardens as the four-o'clock, and this was called *M. Jalapa*, a name which it yet retains. The true jalap plant was first described by Nuttall in the "American Journal of Medical Sciences" for February, 1830; he determined it to belong to the convolvulus family, and gave it the name of *ipomœa Jalapa*. As botanists have taken different views of the genera of *convolvulaceæ*, this plant has been alternately called *ipomœa* and *convolvulus*, but



Jalap (*Exogonium purga*).

has apparently found a resting place in *exogonium*, a genus closely related to both of these, and is the *E. purga* of Bentham. The habit of the plant, with long twining stems, is much like that of some of our garden species of *ipomœa* or morning glory; but, as will be seen from the engraving, it differs in its salver-shaped corolla and protruding stamens; the flowers are purplish and ornamental; the root is perennial, and, according to the age of the plant, differs in size from that of a nut to that of an orange; it is somewhat pear-shaped or oval, externally brownish and white within. The plant is found in the elevated portions of Mexico, especially in the vicinity of Jalapa, at an altitude of about 6,000 ft. above the sea; it is quite hardy in England and on the continent of Europe, and might without doubt be cultivated in the southern portions of the United States; but as medicinal plants are affected in a marked degree by locality, experiment only could decide if the drug would be equally

valuable with that grown in its native habitat. The dried root is the drug of commerce, and it undergoes no other preparation than digging and drying; the smaller roots are dried entire; the largest are divided longitudinally or transversely, sometimes cut in slices, while those of intermediate size are gashed with vertical or crosswire incisions, evidently for the purpose of accelerating the drying. The dried roots are hard and heavy, and, if of good quality, show when broken an undulated resinous fracture, with concentric circles of yellowish gray and dark brown portions. A whitish, mealy fracture may indicate that the root was collected at an improper season, or that a spurious root has been substituted. Jalap has a heavy, rather sweetish odor, and an acrid disagreeable taste; it forms a yellowish gray powder, which is irritating when inhaled and produces sneezing and coughing. The roots are often worm-eaten, but as their activity depends upon a resin which the worms leave untouched, their value for making extract is not impaired, though if such roots were used for powdering the activity of the drug might be unduly increased.—Jalap when treated with alcohol yields about 17 per cent. of resin, which is found to consist of two distinct resins; one of these, to which the name of jalapine has been given, is hard and insoluble in ether; the other, jalapic acid, is soluble in ether, is soft, and has the peculiar odor of jalap. Besides these resins, the drug contains sugar, a brown extractive soluble in water, gum, starch, and other inert matters. In the powdering of this, as of other drugs, there is an abundant opportunity for adulteration, and those who purchase the ordinary powdered jalap of commerce get a large proportion of sawdust, old ship bread, and the like; and what is known as "overgrown jalap" or "male jalap," the root of *ipomœa Orizabensis*, a very feebly active purge, is often sold for grinding. Hassall found that nearly half the samples sold in London were thus adulterated. The extract of jalap is prepared by first exhausting the root with alcohol, and then with water; after distilling off the alcohol from the tincture, and evaporating the watery infusion, the two are mixed and evaporated to form an extract; this has all the medicinal properties of the root, and is employed in half the dose. The resin of jalap is obtained by exhausting the root with alcohol by percolation, distilling off the greater part of the alcohol, and dropping the concentrated tincture thus obtained into water, to precipitate the resin, which is afterward dried and powdered. This preparation is very active, and its dose is one fifth or less of that of the powdered drug. From its action as a hydrogogue the drug is especially adapted to the treatment of dropsy, and is commonly combined, when thus exhibited, with bitartrate of potassa. In the form of a powder and mixed with calomel, it has been a popular prescription in the United States in bilious fever and

congestion of the liver, the usual dose being about 10 grains of each, though in the southern states double this quantity is often given.

**JALAPA**, a town of Mexico, in the state of Vera Cruz, 140 m. E. of the city of Mexico; pop. about 10,000. It is situated on the slope of the Cerro Macuiltepec, 4,500 ft. above the sea, and many of the streets are very steep. The houses are substantially built, frequently of two stories. There are several churches and convents, one of the latter dating from the time of Cortes. The hospital of San Juan de Dios is one of the oldest Spanish structures in the country. There is a home for indigent females, and a number of public and private schools. Among the productions of the surrounding country is the *exogonium Jalapa* or jalap plant. The great staples are honey and wax, the latter being here elaborated to great perfection. The silkworm has been intro-



Jalapa.

duced with much success; and tobacco little inferior to the finest Cuban is extensively grown. There are numerous potteries, and several tanneries and cigar factories. Jalapa, with a mild and salubrious climate, far above the yellow fever region, is the favorite resort of the wealthy inhabitants of the coast.

**JALEY**, *Jean Louis Nicolas*, a French sculptor, born in Paris, Jan. 27, 1802, died there in 1866. He was a pupil of Pierre Cartillier, and obtained in 1827 the highest academical prize for his bust of Mucius Scaevola, enabling him to study six years in Italy. After his return to Paris he executed many works for the Versailles museum and the Luxembourg. Among his best statues are those representing "Puzor" and "Prayer." He succeeded David d'Angers in 1856 in the academy of fine arts, and shortly before his death he was employed upon statuary for the new palace of justice.

**JALISCO**, a maritime state of Mexico, bordering on Sinaloa, Durango, Zacatecas, Guanajuato,

Michoacan, Colima, and the Pacific; area, 48,967 sq. m.; pop. in 1869, 924,580. This state, which in colonial times was known as the kingdom of Nueva Galicia, is divided into the nine cantons of Guadalajara, Lagos, La Barca, Sayula, Etzatlan, Autlan, Tuscacuesco, Colotlan, and Tepic. Capital, Guadalajara. The face of the country is irregular, being traversed from S. to N. by the chain of the Sierra Madre, the principal mountains being those of Tapalpa and Tigre in Sayula, and in the south the Nevado and the Volcan de Colima, which last has an elevation of about 12,000 ft. above the sea. Deep and vast ravines abound in the mountainous portions. On either side of the Sierra Madre are beautiful valleys watered by numerous rivers, the largest of which, the Lerma or Rio Grande de Santiago, flows N. W. from Lake Chapala to the sea; but it rises in Lake Lerma in the state of Mex-

ico, and has a length of 600 m. There are numerous cascades in its course, many of which are very picturesque. Other rivers are the Verde, Lagos, Ameca, Ayquila, San Pedro, Tepic, Acaponeta, Jerez, and Cañas. Of the lakes, that of Chapala, 90 m. long and 10 to 25 m. wide, is the largest; Sayula and Magdalena, though smaller, are notable for the quantity of delicious fish which they contain; Meacaltitan, little inferior in size to Chapala, is rather an arm of the sea than a lake. The climate is in general cold in Lagos, La Barca, and Colotlan,

mild in Guadalajara and Etzatlan, and extremely hot and unhealthy in the coast region. The soil is fertile, the arboreal vegetation luxuriant, and the varieties of useful and precious timbers very great. Wheat and barley are abundantly produced, as are also maize, the beans called frijoles, capsicum, and garbanzos; and cotton, the sugar cane, cacao, and tobacco thrive well. The fruits include those of the torrid and temperate zones. Gold, silver, iron, mercury, and copper are found. Many of the gold and silver mines are now abandoned. Education is in a prosperous condition; there is a university in the capital, and schools in all the other towns.

**JAMAICA** (Indian *Xaimaca*, island of springs), one of the Greater Antilles, and the largest and richest of the British West India islands, in the Caribbean sea, 89 m. S. of Cuba, 118 W. S. W. of Hayti, and 570 N. by E. of the isthmus of Panama, between lat. 17° 45' and 18° 30' N., and lon. 76° 12' and 78° 30' W. Its maximum length, from Morant Point E. to

Vegetal W., is 145 m.; and its maximum, from Riobueno N. to Portland Point N. It has an area of 4,250 sq. m., or the Caicos and Turks islands (annexed to Jamaica by act of parliament in 1873), 9,000 sq. m. The population in 1871 was 237,000, of whom 13,101 were white, 101,346 were of color, and 391,707 black, the last being descended from liberated slaves and their descendants. Thousands of coolies have been imported from the East Indies and the West Indies. The coast is deeply indented in many parts, especially at the eastern end, and is fringed by from 50 to 60 bays and creeks, which afford more or less shelter to shipping, and 30 harbors. The principal ports are Spanish Town (the largest), at the head of a fine and deep bay, defended by two forts, but the bay is so narrow that it is considerably narrowed at the ends; Morant, on a bay of the same name, also a good port, but having a still narrower channel than Kingston, and being exposed to the S. and W. winds, here sometimes violent; Port Royal, on the extremity of the island bordering Kingston bay, with an arsenal and hospital, and being the port for British ships of war; Black River, on Bluefields bay, all of which are on the S. coast; and Montego bay, Spanish Town, Port Maria, and Annotto Bay, on Port Antonio, on the N. coast. All the ports here mentioned are free. S. E. of Spanish Town are the Morant keys, and due S., at a distance of some 40 m., are other keys, and the outer bank, little inferior in length and area, parallel to the island.—Although the surface is extremely irregular, only the E. portion of the island can be called mountainous. Small ridges of mountains from a common point in the west trend divergently eastward about the middle of the island, beyond which the middle ridge alone extends to the east, rising to an average elevation of 6,000 ft., and ramifying to such an extent as to cover almost the whole of this end, collectively designated as the Blue mountains, the culminating point attains a height of 8,000 ft. The middle range is remarkable for the edge-like form of its crest, exceeding three to four yards in width, and the sections of country it separates present very different aspects. That to the north, with the surface gradually rising from the coast, is fringed by low hills clothed with pimento and beautiful valleys watered by numerous streams; while to the south the mountains in many places reach down to the very sea, the frowning and inaccessible cliffs, by which shipping is more thoroughly sheltered than in the ports on the N. coast. The mountains, though numerous, are of inconsiderable extent and occupy little more than one tenth of the area of the island. The largest is the Blue Mountains, 30 m. long by 5 m. wide, rising on the S. side from a few miles E. of Spanish Town to some distance W. of Old Harbour. Other plains are those of Vere and Mile

Gully on the same side, mostly devoted to pasture grounds. To the north and east are the fertile plains of Thomas in the Vale and the Vale of Bath, both covered with sugar plantations. In the west are the plains of Savanah-la-Mar, Pedro, and others, chiefly swampy; but those of the northwest are dry and fertile, and bordered by low hills clothed with a luxuriant forest vegetation. Large caverns occur in various localities. The chief rivers are the Black and the Minho, both on the S. side; the former is navigable by small flat-bottomed craft and canoes some 30 m. from its mouth. Numerous other streams descend from the mountains to the sea on all sides, many of which form fine cascades; and not a few are utilized for irrigation and to furnish motive power for a large number of mills.—Limestone, containing numerous shells, is the predominant geological formation of the island, although quartz, rock spar, and micaceous schist occur in several directions. There are records of the Spaniards having in early times worked silver and copper mines; but mining is at present entirely neglected, although lead is known to exist in large quantities, with perhaps some iron and antimony ores.—The climate in the low regions is essentially tropical, the average temperature being 72° F., and the maximum 100°; but the sea breeze (called "the doctor") during the day, and the land breeze at night, temper to a considerable degree the excessive heat. In the elevated districts the thermometer ranges from 45° to 70°, and the atmosphere is mild and agreeable. In few parts of the world does so slight an elevation produce so great a modifying effect upon the heat as in Jamaica; at about 2,500 ft. above the sea, the fevers, dysenteries, and other maladies which usually prevail along the coast are unknown. The rainy seasons, comprising the months of April, May, September, October, and November, are usually preceded by the cessation of the day and night breezes, when the atmosphere becomes oppressive, and almost insupportable for Europeans. Heavy rain falls every day during these seasons, and is often accompanied by terrific thunder and lightning, and violent gusts of wind from the north. The annual rainfall is about 50 inches, though the average is becoming gradually less as the work of felling the forests advances. Yellow fever, smallpox, cholera, and typhus fever are particularly fatal on the coasts, and in the low grounds generally, the first returning every year. Hurricanes, in the summer months, between the rainy seasons, are of frequent occurrence, and commonly of great violence. Notwithstanding the absence of volcanoes, although there are some signs of their former existence, Jamaica has been visited several times by tremendous earthquakes, one of which, in 1692, extended over the whole island, rending the surface and swallowing up large numbers of people, and engulfing many of the houses of Port Royal with their inmates to a depth of 50

ft. in the sea. The buildings, still standing as they had sunk, were visible in clear weather as late as 1835. The town of Savana-la-Mar was also completely destroyed in 1780 by a hurricane, which swept most of the houses with their occupants into the sea.—The soil is not so fertile as that of most of the other West India islands. In the north a chalky marl is the prevailing character; while to the west and south the so-called Jamaica brick mould predominates, analogous to the warm yellow mould of Cuba, so favorable to the production of the sugar cane. Wherever this soil exists sugar plantations abound, but both labor and manure are essential to their productiveness. Next in importance to sugar culture is that of pimento, to which extensive tracts are devoted; the coffee yield is on the increase; cacao, arrowroot, indigo, ginger, and turmeric are likewise cultivated, but the last only in small quantities by the negroes for their own use. Maize yields abundant harvests twice and even thrice a year in all parts of the island; and Guinea corn is grown in several districts. Yams, cassava, batatas or sweet potatoes, and other articles designated as "ground fruit," are plentiful. In the higher districts grow calavances (a species of pea used by the negroes), and several species of European garden vegetables. The fruits include nearly all the tropical varieties, especially the plantain, which forms an important element of food for the colored classes. Of European fruits, the orange, lime, lemon, and vine were introduced by the Spaniards; but only the last thrives here. Repeated attempts to introduce cotton culture have proved unsuccessful, owing in part to the uncertainty of the seasons, but chiefly to the scarcity and the enhanced price of labor, which two circumstances render abortive all undertakings requiring the immediate application of a large number of hands. The cinchona tree, acclimated of late years, is now cultivated with much profit; and the same may be said of cinnamon. Among the most precious forest productions are the breadfruit tree, mahogany, cedar, ironwood, greenheart, and other cabinet woods; the principal palms are the cabbage palm and the coconut tree; the *lignumvite* or guaiacum abounds; the cotton tree attains immense proportions, and is used for making canoes; the bamboo grows wild and is cultivated; fustic, Brazil wood, logwood, and some kindred species are likewise plentiful. Guinea grass here grows with great luxuriance, and most of the grazing farms are covered with it. Numerous herds of cattle and droves of mules are reared; the latter and oxen are exclusively devoted to labor on the farms, for the horses, resembling the other hardy breeds of the West Indies, are mostly kept for saddle and harness use. Sheep and swine are numerous; and the various barnyard fowls and pigeons are very common. Of the many wild animals which once peopled the Jamaica forests, the agouti and some species of monkey alone remain, with

one or two varieties of rats, which are extremely numerous in every part of the island, and destructive of the sugar cane. There are several kinds of lizards, the largest of which, the iguana, is commonly eaten by the lower classes. Alligators abound in every stream. The land crab, here very common, coming down in myriads from the mountains to the seacoast in the autumn months, is esteemed as a delicacy. The wild birds include ringdoves, parrots, and others of brilliant plumage; and the rice bird visits the island every year in prodigious numbers.—The chief industries are agriculture and the manufacture of rum, cotton fabrics, candles, and other commodities. The chief trade of the island is with England. The staples of export are sugar, rum, coffee, spices, and dyestuffs. The total value of the imports in 1871 amounted to \$6,655,000, and that of the exports to \$6,245,000. The sugar exported in 1870 was 30,747 hogsheads, valued at \$2,461,040; rum, 260 puncheons, \$1,182,790; coffee, 7,671,564 lbs., \$1,189,950; pimento, 5,242,109 lbs., \$145,420. Next in order of importance among the exports stand ginger, rice, cotton manufactures, cocoanuts, cacao, and beeswax. Honey to the value of over \$90,000 was exported in 1870 to the United States and England. The number of vessels entered at all the ports of the island in 1870 was 509 (of which 353 were British), of 213,283 tons; the number of vessels cleared in the same year was 580 (386 being British), of 215,759 tons.—Jamaica is divided into three counties: Surrey on the east, Cornwall on the west, and Middlesex, occupying the central and by far the largest portion. The capital is now Kingston, having replaced as such the neighboring Spanish Town, with which it is connected by rail. The government is administered by a captain general appointed by the crown, and the legislative power is vested in a house of assembly composed of 47 members. The revenue of the island in 1871 amounted to \$2,175,000, and the expenditures to \$2,110,000. The cost of the colony to the mother country in 1867-'8 was \$724,750, an expense which, however, appears to diminish from year to year. The cost of the military station in 1872-'3 amounted to \$339,355, the number of troops being usually 2,000, exclusive of the insular militia, which latter is at present not very numerous. The public debt of the island in 1871 was \$388,000. Education has ever been a subject of interest in Jamaica, and the number of public schools is increased almost every year, the expenditure for this object falling little short of \$100,000 annually. The number of churches is approximately as follows: Church of England, 95; Wesleyan Methodist, 80; United Methodist free church, 18; Jamaica Baptist union, 60; Jamaica Wesleyan Methodist association, 12; London mission society, 17; Moravian mission, 15; Roman Catholic, 8; United Presbyterians, 30; American mission, 5; Jewish, 1. The number of Episcopalian is about 40,000; Wa-

leyana, 85,000; Jamaica Baptists, 80,000; the other sects being much inferior in numbers.—Jamaica was discovered on May 3, 1494, by Columbus, who named it St. Jago or Santiago, in honor of the patron saint of Spain. The first Spanish settlement was made by Juan de Esquivel in 1509; but the colony was captured Jan. 29, 1597, by an English squadron under Sir Anthony Shirley. After having been regained by the Spaniards, it was again wrested from them by the English under Admiral Penn and Gen. Venables, May 8, 1655; since which time it has belonged to England. The island was placed in 1661 under a governor and a council of 12 appointed by the crown; and Spain, by the treaty of Madrid, July 18, 1670, recognized the right of Great Britain to Jamaica. Four years later the population was augmented by the advent of 1,200 colonists from Surinam. In 1728 the constitution of Jamaica was passed. In 1745 a conspiracy of 900 slaves for the total destruction of the white inhabitants was discovered in time to prevent slaughter, and the conspirators were punished with much severity. A tribe of the Maroons (fugitive slaves), having been permitted to establish themselves in the northern part, rose in revolt in 1795, but were finally brought under subjection in the following year. In 1807 the slave trade was abolished, and the act for the emancipation of slaves was passed in 1838. After the latter event, the blacks, who had formerly been provided with lodgings and a piece of ground rent free, were compelled to pay rent, the enhanced rate of which as well as the means used for its collection caused great dissatisfaction among the African population, who now grew inattentive and unwilling to cultivate the land of the proprietors. Revolts were of frequent occurrence; and it is estimated that no fewer than 653 sugar and 456 coffee estates were abandoned and the works entirely suspended from 1833 to 1841. Affairs continued in this disturbed and unsettled state till October, 1865, when a general uprising of the natives occurred, in which the most fearful atrocities were perpetrated. The rebellion was suppressed with much bloodshed. A wealthy mulatto and Baptist preacher named Gordon was tried by court martial for complicity in the revolution, and promptly executed; and numbers were taken in flight, summarily tried and hanged, or shot by the pursuing troops. Governor Eyre was recalled, Dec. 11; and a commission was appointed to inquire into the cause of the disturbance. A charge of murder was brought by an association against the ex-governor and two military officers who had been stationed under him at the time of the outbreak; but the bill of indictment was immediately thrown out by the grand jury.—See "History of Jamaica, from its Discovery to the Present Time," by W. J. Gardner (London, 1873).

**JAMAICA**, a town of Queens co., New York, on Jamaica bay, an inlet on the S. side of Long

Island, including the village and county seat of the same name, on the South Side and Long Island railroads, about 10 m. E. of Brooklyn city hall; pop. of the town in 1870, 7,745; of the village, 8,791. The village was incorporated in 1814. It is lighted with gas, has a fire department, and is the residence of many persons doing business in New York. It contains a large town hall, several hotels, two academies, four weekly newspapers (one German), and six churches.

**JAMALICA**, a collection of ruins in Honduras, 20 m. N. of Comayagua. They consist of a series of rectangular tumuli faced with stones, and ascended by flights of steps, supporting the remains of what appear to have been ancient edifices. The principal tumulus stands on a broad terrace paved with stones, and is surrounded by smaller mounds regularly placed. The adjacent valley is full of remains, and many vases skillfully wrought and beautifully painted, besides various articles of sculpture well executed, are found in making excavations. Both ruins and vases resemble those found at Copan.

**JAMES**, a S. E. county of Tennessee, bordering on Georgia, and bounded N. W. by the Tennessee river, formed since the census of 1870; area, about 200 sq. m. The surface is somewhat mountainous; the soil is generally fertile. Coal and iron are found. The East Tennessee, Virginia, and Georgia railroad crosses it. The assessed value of property in 1871 was \$801,098. Capital, Ooltewah.

**JAMES I.**, king of Scotland, and third monarch of the Stuart dynasty, born in Dunfermline about 1394, assassinated in Perth, Feb. 21, 1437. He was the son of Robert III. and Annabella Drummond. He became heir to the crown on the murder of his brother, the duke of Rothesay. His education was intrusted to the bishop of St. Andrews; but in 1405 it was determined to send him to France, and on his way there the ship was taken by an English man-of-war. He was detained in captivity 19 years, chiefly in Windsor castle, but both Henry IV. and Henry V. treated him well. The former attended liberally to his education, and the latter took him with him in his French campaigns. In a political sense James's education was the consequence of circumstances, and he could not have passed his youth in a better school for a monarch; but he was detained too long from his kingdom to allow of his abilities and knowledge proving greatly useful to his subjects. He showed poetical powers of no mean order, and his writings are yet admired. "The King's Quhair," or "Book," was written while he resided in England; after his return to Scotland he was too actively engaged to devote much time to poetry. Robert III. dying in 1406, his captive son was proclaimed king, and his uncle the duke of Albany was made regent, holding the office until his death in 1419. But for Albany's intrigues James would have been sooner restored to his throne. Albany was succeeded by his son

Murdoch, who might have transferred the crown to his branch of the Stuart line had he possessed his father's talents and unscrupulousness. The Scotch were then the allies of the French, and Henry V. took James to France in 1417, agreeing to restore him to freedom if he should prevail upon those of his subjects who were in France to abstain from hostilities; but the Scotch refused to obey a king who was in durance. On the death of Henry V. the new government of England resolved to give James his freedom, on condition of his paying £40,000 as the cost of his maintenance in England. He married Joanna Beaufort, granddaughter of John of Gaunt through Catharine Swynford, and niece of Cardinal Beaufort, who, seen from his window during his captivity, had inspired the "Quhair." He reached Edinburgh in the spring of 1424, and immediately commenced that vigorous administration which had become necessary through the bad government of his predecessors. Many important legislative acts were adopted. He persecuted the Lollards, and proceeded with energy against the nobles, whose lawless conduct demanded punishment. Albany and two of his sons, and the earl of Lennox, were executed; and soon after other executions took place, of the most cruel nature, the victims being merely retainers, who believed they were bound to obey their feudal superiors. The family of Albany was popular, and their deaths made the king unpopular. James I. revived the connection of his kingdom with France, encouraged the clergy as a counterpoise to the nobility, legislated in favor of trade, labored for the restoration of order, provided for the administration of justice, and maintained the dignity of Scotland against the designs of England. An expedition against the islemen proved successful, and 300 robbers were executed. He stripped the earl of March of his earldom and property, which alarmed the nobility. A conspiracy was formed against him, the head of which was Sir Robert Graham, who was actuated partly by personal and partly by political motives. Not being well supported by his associates, he was baffled, imprisoned, and banished, and his estates were seized. In the highlands, whither he had fled, he formed his plans. His only associates of eminence were the earl of Athol and his grandson, Sir Robert Stewart, the latter being the king's chamberlain. Through the assistance of Stewart, Graham obtained access to the king's apartments, in the monastery of the Dominicans at Perth, and slew him with his own hands, but not until James had made a heroic resistance, though at last he begged his life of the assassin.

**JAMES II.**, king of Scotland, only son of the preceding and of Joanna Beaufort, born in 1430, killed in 1460. Being but a child when he became king, his mother was appointed to take charge of his person during his minority, and the earl of Douglas lieutenant general of the kingdom. The government was really in

the hands of Sir William Crichton, who had been made chancellor by James I.; and next to him was Sir Alexander Livingston, another of the late king's statesmen. These two were rivals, and their quarrels added to the troubles of the country. Archibald of Douglas died, and was succeeded by his son, Earl William, an arrogant youth, who allowed his followers great license; and he and his brother David were put to death by Crichton's orders. The power of Crichton and Livingston was finally ended through the successes of another earl of Douglas in 1446, the king having assumed supreme power in 1444. The internal condition of the country was very bad, through the feuds of the nobles; but Douglas upheld its dignity in the wars with England. A truce for nine years had been made with England, but in 1448 the English entered Scotland, and were defeated by Douglas, whose brother Ormond soon after won the battle of Sark. The truce was then renewed. The power of Douglas was now on the decline. The king, whose intellect matured early, was jealous of him, and, aided by Crichton and by Kennedy, archbishop of St. Andrews, he asserted his authority with extraordinary vigor, punishing many of the nobles and their adherents. In 1449 James married Mary, daughter of the duke of Gueldres. Douglas made a pilgrimage to Rome, and during his absence the king took measures for the curtailment of his power, but on his return he received marks of royal favor. He soon left the court, and lived as an independent sovereign in his own territories, perpetrating many acts of lawless cruelty, and setting the royal authority at defiance. Too powerful to be encountered openly, Douglas now became the object of conspiracy. A reconciliation was effected, and the earl visited Stirling castle, where, in spite of his safe-conduct, he was stabbed by James, and then slain by the royal attendants. In the wars that followed the king triumphed, though not without encountering great resistance, and the main branch of the Douglas family was destroyed. The king sought to improve the condition of the people, and the legislative measures of his reign were often as liberal as the character of the age would allow. The disputes between the houses of York and Lancaster in England, which had now openly commenced, affected Scotland. In 1459, in a treaty between James II. and Henry VI., the former agreed to support the Lancastrians, in consideration of receiving in return portions of the north of England, including Durham and Northumberland. James entered England at the head of 60,000 men, but his army committed such ravages that Henry prevailed upon him to withdraw. In 1460 he renewed the war, not with England, but with the Yorkists, and laid siege to the frontier fortress of Roxburgh, which the English had held since the defeat of David Bruce at Durham. While the king was examining a battery, one of the guns burst, and



a fragment struck him in the groin, causing immediate death. This event occasioned great grief, and the soldiers, listening to the appeal of his widow, persevered in the siege, carried Roxburgh by assault, and razed it to the ground.

**JAMES III.**, king of Scotland, son of the preceding and of Mary of Gueldres, born in 1458, murdered in 1488. He was crowned at Kelso monastery, and as his mother was a woman of vigorous capacity, it was hoped that his minority would not prove so disastrous as that of his father had been; but a variety of circumstances overclouded the fair beginning of this reign, and rendered it one of the most unfortunate in Scotch history. The triumph of the Yorkists in England was adverse to Scotch interests, as they were identified with those of the house of Lancaster. Henry VI. and his family took refuge in Scotland after the battle of Towton had confirmed Edward IV. in possession of the English crown. Edward showed a desire to be on friendly terms with Scotland, but the Scotch adhered to the Lancastrians. In 1462 the English king made a treaty with the earl of Ross and the lord of the isles, and the banished Douglasses, for the conquest and partition of Scotland. All of it north of the Forth was to be divided between Douglas, Ross, and the lord of the isles; and Douglas was to receive the old estates of his house in the south. The lord of the isles was to become Edward's vassal. This formidable treaty led to nothing. Ross alone acted under it. He called himself king of the Hebrides, and committed some depredations, but was soon assassinated. The Scotch nobility were now divided into two parties, the old lords and the young lords, the former favoring the house of Lancaster, while the other was desirous of peace with England, which implied abandonment of Henry VI. The peace party triumphed, the Scotch covenanting to give no assistance to Henry or his party. The queen mother died in 1463. The family of Boyd then rose to power, and the aristocratical struggles were renewed. Bishop Kennedy, the ablest Scotch statesman of that age, who had long been in the service of the crown, died in 1466. In 1469 James married the princess Margaret of Denmark, through which alliance the Orkney and Shetland islands became permanent possessions of Scotland. The Boyds fell the same year, their estates were annexed to the crown, and the Hamilton family rose. James III. has been represented as weak and vicious; but his foreign policy and internal legislation show that he had high capacity and sound views. Domestic peace and an alliance with England, the two things most desirable for Scotland, were his aims. For some time after he assumed power he was successful, but the warlike and illiterate aristocracy hated him for his love of peace and fondness for letters and art. The king's brothers, Albany and Mar, headed the aristocracy, but at first were not hostile to the monarch; but Cochrane, an architect, one of the king's favorites, caused a

breach between him and his brothers. Albany fled to France, and Mar lost his life, in what manner is not known. Troubles occurred with England, and Albany joined the enemies of his country, who promised to make him king of Scotland, for which he was to render homage. The Scotch aristocracy took advantage of the assemblage of a great feudal army against the English, seized the king and his favorites, and hung the latter, including Cochrane, who had been made earl of Mar, without trial. The king was placed in Edinburgh castle. Albany was reconciled to the king, and became lieutenant general. The struggle was repeatedly renewed, the king being often successful. The aristocracy, fearful of the result of the contest, prevailed upon the heir apparent, Prince James, then but 15 years old, to join them. In 1488 the royal party was defeated at the battle of Sauchieburn, near Bannockburn, and the king was killed in his flight by an unknown hand.

**JAMES IV.**, king of Scotland, son of the preceding and of Margaret of Denmark, born March 17, 1472, slain at the battle of Flodden, Sept. 9, 1513. He was crowned at Scone, June 26, 1488. His government was one of the most vigorous that Scotland ever knew. Unlike his predecessors, he determined to rule by the aid of the nobility, and not to seek their humiliation. Attempts at insurrection were put down. Aided by parliament, the king carried many measures for the improvement of the country, concerning trade and manufactures. When he found his power firmly established he withdrew his favor from the men who had acted with him against his father. Peace was made with England. The encroachments of Rome were restrained. Justice was regularly administered in the lowlands; and the king determined that the highlands should be made subject to law. He made several journeys thither and to the isles, successfully asserting the royal authority. The lord of the isles endeavored to resist, but was stripped of power and possessions. When Perkin Warbeck appeared, claiming to be the second son of Edward IV. of England, James supported him, and he is believed to have been an original party to the plot that brought him upon the stage. Warbeck visited Scotland in 1495, and was royally received. James gave him for a wife a daughter of the earl of Huntly, a near relative of his own. He invaded England; but this was injurious to Warbeck's plans, because of the hatred felt by the English for the Scotch. The latter returned home, but the war continued. Henry VII. renewed his offer to give the hand of his daughter Margaret to James, and in 1497 Warbeck left Scotland, when a seven years' truce was agreed upon. James now proceeded to complete his plans for the improvement of Scotland. Commerce and a navy received much of his attention, and prospered. He again visited the north, and enforced the law in the highlands. Learning was favored by him, and literature flourished. In

deference to the nobility, he married the princess Margaret of England, Aug. 8, 1503. The relations between France and Scotland became very close, which offended Henry VII. Printing was introduced into Scotland in 1507, by Walter Chapman, one of the king's servants. After the accession of Henry VIII. to the English throne troubles began, which ended in war in 1513, when James invaded England, and was defeated by the earl of Surrey at Flodden. The loss of the battle was due to the conduct of the king, who, from exaggerated notions of chivalry, gave up great advantages of position, for which he paid with his life. He showed eminent valor, but no generalship.

**JAMES V.**, king of Scotland, son of the preceding and of Margaret Tudor, born in Linlithgow, April 10, 1512, died in Falkland, Dec. 13, 1542. He was crowned at Scone, and his mother became regent. His minority was a period of great trouble, owing to the weakness of his mother, the rivalry of parties, the venality and violence of the aristocracy, and the attempts of the English to obtain ascendancy. In his 17th year he escaped from the Douglases, who then had possession of his person, and became king in fact. He showed much energy in repressing the troubles on the borders, where he sent several chiefs to the gallows, among them the famous John Armstrong. A rebellion in the Orkneys was promptly quelled; and the chiefs of the Western isles were induced to submit to the king's authority by his firm but conciliatory action. Other measures to promote tranquillity were adopted; but the nobles had become lawless and licentious during the regency, so that James met with great difficulties in his endeavors to restore peace at home, and some of their leaders were treated with severity. The clergy were much esteemed by him, and held the principal offices of state; facts of not a little consequence, as the reformation was then going forward, and Scotland was affected by it. The college of justice was established in 1532, supposed to have been modelled on the parliament of Paris, and suggested by the advice of Gavin Dunbar, archbishop of Glasgow, who had been the king's preceptor, and was now chancellor; its object was to remove the means of oppression from the hands of the nobles. James was courted by foreign powers. Henry VIII. wished him to marry his daughter Mary. Charles V. offered him his sister, the late queen of Hungary, or his niece, a princess of Denmark. Francis I. favored the English alliance, as he and Henry were at that time friends. Border hostilities made it difficult for England and Scotland to be allies. Henry encouraged Scotch rebels, and James aided the disaffected Irish. In 1533, under French mediation, a truce was made, which was converted into a treaty of peace the next year. Henry made James a knight of the garter, Francis conferred upon him the order of St. Michael, and the emperor that of the golden fleece. Charles made

another futile effort to marry him to one of his nieces, though James avowed his attachment to the cause of which the emperor was chief. He persecuted the reformers, burning some, while others were compelled to fly. Henry VIII. urged his nephew to side with him in his contest with Rome, and again offered him the hand of the princess Mary; but he failed, and the pope's attentions and exertions bound James to the papal cause. Paul III. addressed him as "defender of the faith," against which Henry remonstrated. James visited France in 1536, where he married Madeleine, only daughter of Francis I. She died soon after, whereupon James married the duchess of Longueville, a daughter of the duke of Guise, who had been sought by Henry VIII. These marriages caused the king to become still more attached to the party in Europe that was hostile to the reformation, and under the influence of Cardinal Beaton persecution raged, while Henry VIII. exerted himself to change the policy of Scotland. In 1540 James led a successful expedition to the Western isles. The Hebrides, the Orkney and Shetland isles, and portions of territory in Scotland that had belonged to rebellious barons, were annexed to the crown. The king paid much attention to industrial development, inviting skillful foreign artisans to settle in Scotland. Henry VIII. sought an interview with his nephew in 1541, going for that purpose to York; but James would not visit him. War followed, and James made great preparations to meet the English; but his feudal array could not be relied upon, the nobility being thoroughly discontented. At Fala Muir and Solway Moss they openly defied his commands, and would not resist the enemy. James fell into despair, and died in a few days. When the birth of his daughter Mary was announced to him, he said: "It [the crown] came with a lass, and it will go with a lass." These were among his last words.

**JAMES I.** of England, and **VI.** of Scotland, son of Henry, Lord Darnley, and Mary, queen of Scots, born in Edinburgh castle, June 12, 1566, died in the palace of Theobalds, March 27, 1625. His reign began in July, 1567, when his mother, queen regnant of Scotland, was dethroned, and power passed finally into the hands of the Protestant party. He resided at Stirling castle, under the guardianship of the earl of Mar, and his preceptor was the learned George Buchanan, who, on being reproached with having made the king a pedant, declared that it was the best he could make of him. During his minority the contest between kingmen and queensmen was bitterly waged, and the earls of Murray, Lennox, Mar, and Morton were successively regents. In 1571, on the overthrow of Morton, James assumed power, and the next year this assumption was confirmed by parliament. He early exhibited that fondness for masculine favorites which has left a cloud on his name. He was seized by some of the nobility in 1582, but recovered

his liberty and power, and banished his enemies. The latter returned in 1585, and forced the king to capitulate. He formed an alliance with Elizabeth in behalf of Protestantism, then threatened by the great Catholic powers, and wrote a book to prove that the pope was Antichrist. He sought, but ineffectually, to save his mother's life, when she had been sentenced to death in England. He adhered to England during the expedition of the armada, knowing that Philip II. would not conquer it for him. In 1589 he made a voyage to Denmark, and married Anne, second daughter of Frederick II. His reign was much disturbed by internal troubles caused by the nobles, the clergy, and the citizens of Edinburgh. His *Basilicon Doron*, intended for the instruction of his son Henry, was published in 1599. He endeavored to restore episcopacy, but with no success. On the death of Elizabeth, March 24, 1603, James was proclaimed king of England by the queen's council, in violation of the will of Henry VIII. His right, however, had been recognized by Elizabeth, and rested upon his descent from Henry VII. through his great-grandmother Margaret. He left Edinburgh April 5, and journeyed to London, his clumsy person and gross manners making a most unfavorable impression on his new subjects. Cecil monopolized power. Raleigh was tried and condemned for treason, and was kept for 18 years in prison. A disgraceful peace was made with Spain in 1604. Arbitrary sentiments prevailed at court, and the king had trouble with his parliaments. The gunpowder plot, in 1605, was caused by the disappointment of some Catholics, whom he had encouraged to hope for the mitigation of the penal laws under which they suffered. In 1612 two heretics were burned at Smithfield, the last executions of the kind in England. Henry, prince of Wales, died the same year, under suspicious circumstances. The princess Elizabeth, ancestress of the present English dynasty, was married to the elector palatine, Feb. 14, 1613. The "grand oyer of poisoning" took place in 1615-'16 (see *OVERBURY, SIR THOMAS*), ending in the disgrace of the earl of Somerset, who had been a royal favorite, though now superseded by George Villiers, first duke of Buckingham of that name. Raleigh was released, and allowed to make his voyage to Guiana, but was put to death on his return, to gratify the Spanish government. James's foreign policy was shameful, and the English felt the disgrace all the more because of the contrast it made with that of Elizabeth. When the thirty years' war broke out, though it involved the fate of his daughter and son-in-law, and they lost their dominions and became exiles and beggars, he would do nothing for them. A leading object with him was to conciliate Spain, and obtain the hand of a Spanish princess for his eldest son. Other means having failed, Buckingham, who now ruled both king and prince, persuaded Charles to go to Spain, to urge his suit for the infanta. This

journey led only to disappointment, Buckingham taking offence, and, it is said, causing the marriage to be broken off. Bacon, who was lord chancellor and a peer, was disgraced in 1621, on account of his corrupt acts. War was declared against Spain in 1624, and parliament was dissolved the same year. The hand of the princess Henrietta Maria, daughter of Henry IV. of France, was now sought for Charles, and an alliance with that country against the house of Austria was contemplated. A small force was sent to the continent, to help the Protestant cause, and this was followed by a larger one; but the first accomplished nothing, and of the second one half the men perished on board their ships, France and Holland not allowing them to land. Buckingham's favor with the king was now lost, but he had great influence over the prince of Wales; and the king falling sick, the duke and his mother were suspected of having poisoned him. His death was really caused by a tertian ague, acting on a constitution undermined by intemperance, chagrin, and mortification. The most remarkable event of James's reign was the authorized translation of the Bible into English, which was done under his patronage and by his direction. James was a man of considerable learning, but his scholarship was deformed by the most offensive pedantry, as his writings were by the grossest superstition, witches being the especial objects of his fear, hatred, and persecution.

**JAMES II.** of England, and VII. of Scotland, second surviving son of Charles I. and Henrietta Maria, born at the palace of St. James, Oct. 15, 1633, died at St. Germain, France, Sept. 16, 1701. He was called duke of York at once, but not by patent until 1643. He was about nine years old when the civil war broke out, and was an eye-witness of the battle of Edgehill, where he came near losing his life. He was present at the siege of Bristol in 1643. When Oxford was captured in 1646, James became prisoner to Fairfax. At a ceremonious visit of the chiefs of the parliamentary army, Cromwell was the only man who knelt to him. The prince was well treated, and allowed frequent interviews with his father, living most of the time in company with his brother Gloucester and sister Elizabeth, at St. James's, under the guardianship of the earl of Northumberland. He escaped in 1648, and fled to the Netherlands, whence, after a residence in Flanders, he went to Paris in 1649. The same year he accompanied his brother Charles to the island of Jersey, residing there four months. Returning to the continent, he visited Brussels, Rheenen, the Hague, and Breda. After the triumph of the enemies of the Stuarts in 1651, he entered the French service, distinguishing himself under Turenne. When, in 1655, the relations between England and France became close, James was forced to depart, and he entered the Spanish army, where he fought against the English and French. He was treat-

ed with much consideration by the Spaniards. He shared in the benefits of the restoration of his family to the British throne in 1660; and on Sept. 3 of that year he was married to Anne Hyde, daughter of the earl of Clarendon, to whom he had contracted himself the preceding November. She died in 1671, and James married in 1673 Maria Beatrice Eleonora, a princess of the house of Este of Modena, his junior by 25 years. He had become a Catholic while in exile, but did not avow his religion until some years after the restoration (1671). In the wars with Holland he distinguished himself in command of the English fleet. The passage of the test act in 1673 caused him to relinquish all his employments. He incurred great danger during the time of the popish plot, and when the parliamentary test was adopted in 1678, it was with difficulty that he maintained an exceptional privilege to retain his seat in the house of peers. An effort was made to exclude him from the succession, and Shaftesbury endeavored to prevail upon the grand jury of Middlesex to indict him. The commons passed the exclusion bill, but it was rejected by the peers; it had passed the commons in the preceding parliament, but through a dissolution failed to reach the upper house. James retired to Brussels in 1679, but returned when the king was attacked by illness. He was sent to Scotland, as head of the administration there, and treated the Covenanters with great cruelty. The Oxford parliament, which would have passed the exclusion bill, was dissolved at the commencement of 1681. A reaction now began. James soon returned to England, had much influence at court and in the country, and upheld all those severe measures by which the tory party sought to exterminate the whigs. When Charles II. died, Feb. 6, 1685, James succeeded him. His conduct was arbitrary from the beginning, and the parliament he called was the most servile in English history. Argyll's invasion of Scotland and Monmouth's invasion of England were subdued with little difficulty, and were followed by unparalleled punishments. He soon broke with his obsequious parliament, as he required the repeal of the test and habeas corpus acts, which were as dear to the tories as to all other of his subjects except the Catholics. He prorogued the parliament from time to time, and ultimately it was dissolved. He set himself systematically to work to effect two ends: the overthrow of the constitutional system of England, and the restoration of the Catholic religion. At first he attempted to use the established church against the dissenters; but finding the Episcopalians would not give him their aid, he sought to gain the dissenters. A great number of illegal measures were adopted. A new court of ecclesiastical commission was erected; a great standing army was created; the privileges of the universities were violated; the test act became a dead letter; corporations were modelled and remod-

elled, in the hope that a parliament might be packed that would give to the king's doing the forms of law. In less than three years the king had arrayed all his subjects against him, except the Catholics and a few of the dissenters, the greater part of the dissenting interest siding with the established church, and whigs and tories coalescing. All offices were in the hands of Catholics, or of Protestants ready to do the work of Catholics. The foreign policy of the country was made subservient to that of France, because the support of that country was necessary for the success of James's home policy. The pope and the governments of Spain and Germany were hostile to James's course, because they were alarmed at the encroachments of Louis XIV. Matters were brought to a crisis in June, 1688, by the opposition which the declaration of indulgence encountered. The archbishop of Canterbury and six bishops were sent to the tower, and tried on the charge of libel, for petitioning the king against the order that the declaration should be read in the churches. They were acquitted, but the excitement was without a parallel in English history of that century. On June 10 Queen Mary gave birth to a son, who was afterward known as the pretender (see JAMES FRANCIS EDWARD STUART), the popular opinion being that the queen's pregnancy was a sham, and that the child was spurious. This event hastened the revolution. Men had been restrained from action by the belief that, as James had no male children, the throne must soon pass to his eldest daughter, Mary, wife of William, prince of Orange, who was a Protestant; but the birth of his son dispelled their hopes, and on June 30, 1688, William was invited to invade England, the invitation being signed by the earls of Shrewsbury, Devonshire, and Dunby, Lord Lumley, Henry Sidney, Edward Russell, and Henry Compton, the suspended bishop of London. Though James was warned of what was going on, both by Louis XIV. and by others, he was taken entirely by surprise when William sailed from Holland with an army of 15,000 men. The invaders landed at Torbay, Nov. 5, and James was soon abandoned by nearly every one, including his daughter Anne. He fled from England, having previously sent away his wife and son, but was detained, and returned to London, much to the regret of his enemies. Every facility for flight being placed in his way, he fled a second time, and reached France. He was magnificently received by Louis XIV., who assigned him a large pension, and the palace of St. Germain as a residence. He went to Ireland in 1689, in which country the native population were attached to his cause. There he underwent many humiliations, and was defeated at the decisive battle of the Boyne, July 1, 1690. Returning to France, he resided there until his death. The battle of La Hogue, in 1692, proved fatal to his hope of a successful descent on England, though the idea was not abandoned. He was

he candidature for the crown of Poland in 1696, but would not accept it. The Ryswick in 1697, by giving peace to England, removed all prospect of it; but the ex-king and his family were to be the guests of Louis XIV. He declined, and on Sept. 2, 1701, he was seized with apoplexy, and died in two weeks.

**Epistle of**, one of the books of the testament canon, which has been ascribed to the son of Zebedee, to a pseudo-epistle which assumed the name to gain authority for the son of Alpheus, and to James the brother of the Lord. Luther doubted its origin, and called it an "epistle of straw," but recent Protestant theologians are in favor of its canonicity, without endeavoring to agree as to its author. The entire literature on the epistle is reviewed in *Zeitschrift und Kritiken*, January, 1874, by H. Schlegel, who believes that it was written by the brother of the Lord, whom he distinguishes from both the apostles of that name. He regards it as the oldest book of the testament, reflecting the sentiments of the religious portion of the Jewish people, Jesus himself and his brothers were addressed to the Jewish Christians of Asia Minor. In his doctrine, James places the greatest stress upon the necessity of a distinction from Paul and John, beyond the preachers of faith and love. His doctrine is consistent with theirs, except from another point of view, has been given by Neander, in his practical exposition of the epistle. Its style is highly eloquent and poetical.

**George Payne Rainsford**, an Englishman, born in London in 1801, died in Venice, 1860. He was educated at Greenock at the age of 15 was sent to France, where he passed several years. While a boy he had the habit of writing small pieces in verse, and became an anonymous contributor to the magazines. Strongly encouraged by Washington Irving, he produced a life of Edward the Black Prince, the book bearing his name. When but 17 years old he had written a collection of eastern tales which were published in 1832 under the title of "String of Pearls." His first novel, "Richelieu," written in 1829, was published in 1829, met with considerable success, and was followed by "Darnley" (1830), "Philip Augustus" (1830), "Henry Masterton" (1832), and "Mary Queen of Scots" (1834). The list of original descriptions published under his name amounts to more than 80, the latest being "The Cavalier" (1859). Among these are volumes of poetry, and many of history and biography, including the "History of Chivalry," "Lives of Charlemagne, Richard Cœur de Lion, Henry IV. of France, and Louis XIV." For some time he held the post of historiographer of England by the appointment of

William IV. About 1850 he removed to the United States, and in 1852 was appointed British consul in Norfolk, Va., where he remained until his appointment in 1858 as consul at Venice. Among the novels suggested by his experiences of American life and history are "Ticonderoga" (1854) and "The Old Dominion" (1856). "Adrian, or the Clouds of the Mind" (New York, 1852), he wrote jointly with Maunsell B. Field. A collected edition of his works has been published in London.

**JAMES. I. Henry**, an American philosopher, born in Albany, N. Y., June 3, 1811. He studied for some time in Union college and in the Presbyterian theological seminary at Princeton. During a tour in Europe he became interested in the views of Robert Sandeman, of whose "Letters on Theron and Aspasio" he prepared an edition with an original preface (New York, 1839). In 1840 he published a pamphlet entitled "Remarks on the Apostolic Gospels," in which he maintained the absolute divinity of Jesus Christ while denying the doctrine of the trinity. In another visit to Europe in 1843 he became acquainted with the works of Swedenborg, which have ever since exercised a marked influence upon his opinions and writings. In 1846 he published "What is the State?" a lecture delivered in Albany, and in 1847 "A Letter to a Swedenborgian," in which, while asserting the doctrines promulgated by Swedenborg, he argues against the ecclesiastical organization of the New Jerusalem church. In the winter of 1849-'50 he delivered in New York a course of public lectures, which were collected into a volume under the title of "Moralism and Christianity" (1852), and excited much attention. The leading idea of this volume is that there is a radical distinction between the moral and religious life of man; the former being mere obedience to the laws of human society, while the latter is the product of divine life and love flowing into the soul; consequently the one is outward, formal, and temporary, while the other is inward, spontaneous, and permanent. A second course of lectures delivered in 1851-'2, enforcing the same general views, was published, together with several articles written for magazines and reviews, in a volume entitled "Lectures and Miscellanies," in 1852. This was followed by "The Church of Christ not an Ecclesiasticism" (1854), "The Nature of Evil" (1855), "Christianity the Logic of Creation" (1857), "Substance and Shadow" (1866), and "The Secret of Swedenborg" (1869). In these works Mr. James advocates a body of religious philosophy and social doctrine which in its theological affinities is related to the teachings of Swedenborg, while its humanitarian tendencies accord with the aims of modern socialism. **II. Henry, jr.**, an American author, son of the preceding, born in New York, April 15, 1843. He was educated partly in New York and partly in Europe, where he has lived for several years, mostly in France

and Italy. He has become favorably known as a contributor of stories, sketches of travel, and literary and artistic criticisms to various reviews and other periodicals.

**JAMES, Sir Henry**, an English engineer, born at Rose-in-Vale, near St. Agnes, Cornwall, in 1803. He studied at Woolwich, and became lieutenant of engineers in 1825, director of the geological survey of Ireland in 1844, and of the admiralty engineering works at Portsmouth in 1846, chief of the ordnance survey of the United Kingdom in 1852, and of the topographical and statistical departments of the ministry in 1857, which last two offices he still holds (1874). He was knighted in 1860, and made major general in 1868. He invented a new photographic process to which he applied the name of photozincography, and by means of which he made facsimiles of the "Domesday Book" in 32 volumes, and of "National Manuscripts from William I. to Queen Anne" (2 vols. fol., 1865). His other works comprise "Ordnance Survey in Ireland" (1855), "in Scotland" (2 vols., 1861), and "in England and Wales" (2 vols., 1861); "On Photozincography and other Photographic Processes" (1862); "Account of the principal Triangulation of the United Kingdom" (1864); and "Record of the Expedition to Abyssinia" (1870).

**JAMES, John Angell**, an English clergyman, born at Blandford, June 6, 1785, died in Birmingham, Oct. 1, 1859. He was apprenticed to a draper, but was subsequently placed in the dissenting college at Gosport to be educated for the ministry. In 1804, while still a student, he temporarily supplied the pulpit of Carr's lane chapel, Birmingham, and was unanimously requested to become the pastor, which post he held till the end of his life. Soon after he was ordained he issued the "Sunday School Teacher's Guide," which has passed through many editions; and volumes, tracts, addresses, and sermons followed each other in rapid succession. A series of his works, including "The Anxious Inquirer," "The Church Member's Guide," "The Christian Father's Present to his Children," and "The Christian Professor addressed in a Series of Counsels," have been circulated by hundreds of thousands of copies, and translated into 10 or 12 languages. Among his numerous other writings may be mentioned "The Course of Faith," "Christian Hope," "The Family Monitor," and "The Church in Earnest." He possessed the love and respect of persons of all denominations, and his funeral was said to have been the largest ever known in Birmingham.—See "John Angell James: a Review of his History, Character, Eloquence, and Literary Labors," by John Campbell, D. D. (8vo, London, 1860), and his "Life and Letters," by R. W. Dale (1861).

**JAMES, Robert**, an English physician, born at Kinnerston, Staffordshire, in 1703, died in 1776. He was educated at St. John's college, Oxford, studied medicine, and after practising in Sheffield, Lichfield, and Birmingham, re-

moved to London. He is principally known as the inventor of the fever powder called "James's powder." He is the author of "A Medicinal Dictionary" (3 vols. fol., London, 1743-'5), in the preparation of which he was assisted by Dr. Samuel Johnson; of a posthumous publication entitled "Vindication of the Fever Powder;" and of treatises on the practice of physic, canine madness, &c. The preparation of his powder was kept a secret for many years, but it is now known to be composed of oxide of antimony and phosphate of lime, and is called antimonial powder.

**JAMES, Saint. I. The Elder**, one of the twelve apostles, son of the fisherman Zebedee and Salome, and brother of the evangelist John, died about A. D. 44. With his brother John he followed his father's occupation, and they seem to have been acquainted with Jesus, and to have recognized him as the Messiah, some time before their call to attend him. It was probably their zeal and boldness that gained them the appellation of Boanerges, or sons of thunder. They witnessed the transfiguration, the restoration to life of Jairus's daughter, the agony in the garden of Gethsemane, and the ascension. James preached as an apostle chiefly in the vicinity of Jerusalem. Under Herod Agrippa he suffered martyrdom by the sword, and, according to Clement of Alexandria, his accuser was so much affected by the boldness of his confession of faith that he at once professed himself a Christian, and was beheaded immediately after him. There is a tradition that he went to Spain, of which country he is the patron saint, and Santiago de Compostela claims the possession of his bones. The Gospel of St. James which was discovered in 1543 on a mountain in Granada, written upon lead, was declared by Pope Innocent XI. in 1682 to be spurious. **II. The Less**, one of the twelve apostles, son of Cleophas (or Alphaeus) and Mary, a sister of the Virgin Mary, died about A. D. 62. He was the cousin of Jesus, and was sometimes called his brother. The son of Alphaeus and the brother of the Lord are supposed by some critics to be two persons, and Neander pronounces the question the most difficult in the apostolic history. According to Clement of Alexandria, he was a priest and a Nazarite before he was an apostle. After the ascension he was appointed bishop of Jerusalem, and there, in the first apostolic council, he spoke against those who wished to make the law of Moses binding upon Christians. The progress of Christianity under him alarmed the Jews, and Ananus, a son of the high priest Annas, accomplished his death. The apocryphal "Gospel according to the Hebrews" states that he was first precipitated from a pinnacle of the temple, and afterward stoned. He was noted for the purity and holiness of his life, and held in the highest esteem by Jewish professors of the Christian faith.

**JAMES, Thomas**, an English clergyman, born in Newport, Isle of Wight, in 1871, died in

Oxford in August, 1629. He was educated at Winchester school and at New college, Oxford, of which he became fellow in 1593. In 1602 he was appointed the first librarian of the Bodleian library, a post which he occupied for nearly 20 years. In 1614 he became sub-dean of Wells, and not long after rector of Mongeham, Kent. He was author of a number of learned works, mostly controversial, the principal of which are: *Bellum Papale* (4to, 1600, 1678), and "A Treatise of the Corruption of Scriptures, Councils, and Fathers, by the Prelates, Pastors, and Pillars of the Church of Rome for the Maintenance of Popery" (4to, 1612, 1688; new ed. by the Rev. J. E. Cox, 1843). His "Catalogue of the Bodleian Library" (4to, 1605, 1620), and other writings, are highly esteemed by scholars.

**JAMES CITY**, a S. E. county of Virginia, bounded N. E. by York river, S. by James river, and W. by the Chickahominy; area, 184 sq. m.; pop. in 1870, 4,425, of whom 2,440 were colored. It has a rolling surface, well timbered with oak and pine. The chief productions in 1870 were 10,850 bushels of wheat, 64,128 of Indian corn, 8,238 of oats, 6,804 of Irish and 5,071 of sweet potatoes, and 11,809 lbs. of butter. There were 298 horses, 497 milch cows, 912 other cattle, and 2,485 swine; 1 flour mill, and 2 saw mills. Capital, Williamsburg.

**JAMES FRANCIS EDWARD STUART**, called the chevalier of St. George, a pretender to the throne of England, son of James II., born in London, June 10, 1688, died in Rome, Jan. 2, 1766. His legitimacy was suspected even before his birth, many believing that his mother, Queen Mary of Modena, was not really pregnant, but that it was intended to introduce fraudulently a pretended Roman Catholic heir. Though this charge has been disproved, it was one of the reasons why the infant prince was not proclaimed king immediately after the dethronement of his father in 1688. His childhood was passed at St. Germain, where Louis XIV. gave an asylum to the exiled family. On his father's death he was immediately acknowledged king of Great Britain by Louis XIV. under the title of James III. He was recognized also by the king of Spain, the pope, and the duke of Savoy. But no active measures were taken in his behalf till March, 1708, when he sailed from Dunkirk with a French fleet for the invasion of Scotland. The expedition returned without having effected a landing, and the prince now assumed the name of the chevalier of St. George and joined the French army in Flanders. He was present at the battle of Oudenarde in July, 1708; and in that of Malplaquet in September, 1709, he charged the English at the head of the French cavalry. Meantime the English parliament set a price of 100,000 crowns upon his head. In 1713 he was secretly favored by Bolingbroke and other ministers of Anne, and the queen herself regarded him with predilection; but he rejected their advice to renounce, or pretend to renounce, the

Roman Catholic faith. The sudden death of Anne arrested the designs of Bolingbroke and the Jacobites; and Bishop Atterbury, who vainly offered to head a procession to proclaim James at Charing Cross, is said to have exclaimed with indignation, "There is the best cause in Europe lost for want of a little spirit." The chevalier hastened to the court of Versailles, but Louis, unwilling to give England any pretext for rupture, ordered him to leave France, and he retired to Plombières, where he issued a manifesto which was published in England, asserting his right to the crown. At Commercy in Lorraine he was joined by Bolingbroke, who sought in his interest to incite the French government to war with England. This was prevented by the death of Louis XIV., and the hopes of the chevalier were languishing when, on Aug. 27, 1715, the earl of Mar invited the principal Jacobite gentlemen of Scotland to a great hunting match, took with them the oath of fidelity to James III., and raised the standard of rebellion in the highlands. Encouraged by vessels from France with arms and officers, Mar was soon at the head of 10,000 well equipped men, made himself master of Fifeshire, and marched to Dunblane. He at first fell back before the duke of Argyll, commander-in-chief of the English forces in Scotland, but being reinforced fought with him the doubtful battle of Dunblane (Nov. 13, 1715). On the same day in England the Jacobites were obliged to surrender Preston, with many prisoners, and news was received that Lord Lovat had delivered up the castle of Inverness, though hitherto professing to act in the interest of the chevalier. The clans soon began to forsake the standard of Mar, whose army dwindled to half its original number. Though the chevalier had been proclaimed in numerous places in England and Scotland, his partisans had gained no formidable successes. While his cause bore this gloomy aspect, he himself arrived at Peterhead, Dec. 22, 1715, passed incognito through Aberdeen, received Mar most cordially at Fetteresso, made his public entry into Dundee, and continued his progress to the royal palace of Scone. Though everywhere received with acclamation, he was disappointed to find, instead of a large and victorious army, only a discordant multitude, without money, arms, or ammunition. He had not the energy and courage to struggle with the difficulties of his position. The resolution to retreat was taken at a council on Jan. 29, and at Montrose he reembarked for the continent with every appearance of desertion and deceit. It has been asserted, however, that he yielded only to the argument that his followers would obtain better terms from the government in his absence than if he remained. After a voyage of seven days he landed at Gravelines, whence he proceeded to St. Germain. The triple alliance (1717) obliged him to leave France, and in the following year he was received with regal honors at Madrid,

and was one of the pretexts for Alberoni's preparations for an invasion of England. In 1719 he married the princess Sobieski of Poland; and in 1720 his eldest son, Charles Edward, the hero of the enterprise of 1745, was born at Rome. In 1722 he issued from Lucca a strange manifesto, proposing that if George would deliver to him the throne of his fathers, he would bestow upon George the title of king in his native dominions and invite all other states to confirm it. In 1725 his wife, with whom he had lived unhappily, retired to a convent, and during his latter years he led a quiet and pious life in Rome.—See J. H. Jesse, "Memoirs of the Pretenders and their Adherents."

**JAMESON, Anna**, a British authoress, born in Dublin, May 19, 1797, died in London, March 17, 1860. Her father, Mr. Murphy, was painter in ordinary to the princess Charlotte, and from him she derived her enthusiasm for art and intimate acquaintance with its technicalities. At the age of 27 she married Mr. Jameson, a barrister, who soon after received a government appointment in Canada. The marriage proved unhappy, and was soon practically if not legally dissolved. She then made a tour through France, Italy, and Germany, and in 1828 published anonymously her "Diary of an Ennuyée," a work recording her experiences of travel. She published in 1829 "Loves of the Poets" (2 vols. 8vo), a series of sketches showing the influence which women have exercised on poetic minds; in 1831, "Lives of Celebrated Female Sovereigns" (2 vols.); and in 1832, "Characteristics of Women" (2 vols.), containing disquisitions on the female characters in Shakespeare's plays. Her next work was "Beauties of the Court of Charles II.," consisting of letterpress illustrations of engravings from copies of the original pictures by Sir Peter Lely, made by her father at the desire of the princess Charlotte. It was followed by "Visits and Sketches at Home and Abroad," a collection of miscellanies, including a new edition of her "Diary of an Ennuyée." She subsequently visited Canada and a portion of the United States, recording her experiences in "Winter Studies and Summer Rambles in Canada" (3 vols., 1838), and in 1840 published a translation entitled "Pictures of the Social Life of Germany" (2 vols.), as represented in the dramas of her friend the duchess Amalie of Saxony. In 1840 the series of works on art, by which she gained her chief literary honors, properly commences with a translation of a work on the life and genius of Rubens by Dr. Waagen. It was followed by a "Handbook to the Public Galleries of Art in and near London" (2 vols., 1842), and a "Companion to the Private Galleries of Art in London" (1844). In 1845 appeared her "Memoirs of the Early Italian Painters, and of the Progress of Painting in Italy from Cimabue to Bassano" (2 vols. 18mo), containing 30 biographies, which cover a period of about three centuries. A new edition containing addition-

al biographies and other matter appeared in London in 1859. Her next publication, "Memoirs and Essays on Art, Literature, and Social Morals" (1846), contains a paper on the works and genius of Washington Allston. A more elaborate work than any of the preceding was her "Sacred and Legendary Art" (2 vols. 8vo, 1848), which, with the "Legends of the Monastic Orders" (1850), and "Legends of the Madonna" (1852), had employed her for many years. In this series she sought to trace the progress of sacred art, to explain the symbolical form in which the old masters clothed their ideas, and to indicate the purity and beauty of their conceptions. Her numerous skilful etchings from original pictures, illustrating her subject, combine to render the series a most valuable contribution to the history of art. Her remaining works are: a "Commonplace Book of Thoughts, Memories, Fancies, &c." (1854); "Sisters of Charity Abroad and at Home" (1855), the substance of a lecture; and "The History of our Lord as exemplified in Works of Art" (vol. i., 1860; vol. ii., chiefly by Lady Eastlake, 1864).

**JAMESON, Robert**, a Scottish naturalist, born in Leith, July 11, 1774, died April 17, 1854. He studied medicine in the university of Edinburgh, and after some mineralogical explorations in Scotland went in 1800 to Freiberg, and became a pupil of Werner, whose geological dogmas he adopted with enthusiasm. Returning to Edinburgh in 1804, he was soon after appointed professor of natural history in the university of that city, a position which he held until his death. For many years he was an active advocate of the Wernerian theory, but finally adopted and taught that of Hutton. His publications are purely scientific, and include manuals of instruction, and many contributions to scientific journals. His most elaborate works are his "System of Mineralogy" (8 vols., 1804-'8), and "External Characters of Minerals" (1805). In 1819 he established the "Edinburgh Philosophical Journal," of which for many years he was the sole editor. He is also the author of the articles on "Geology," "Mineralogy," and "Organic Remains" in the "Encyclopædia Britannica."

**JAMESONE, George**, a Scottish painter, born in Aberdeen in 1586, died in Edinburgh in 1644. He was a fellow pupil with Vandyke in the studio of Rubens, and is called by Walpole "the Vandyke of Scotland." Little is known of his career, save that it was prosperous. His pictures are found in many old family mansions in Scotland, and among his sitters was Charles I. on the occasion of his visit to Edinburgh in 1633. He occasionally painted history and landscape, and is said to have illuminated a manuscript on the life of Christ.

**JAMES RIVER**, the largest stream which has its whole course in the state of Virginia. It is formed near the W. border of the state, on the border of Alleghany and Botetourt cos., by the union of Jackson and Cowpasture rivers, and



thence flows S. E. and E. to the Blue Ridge, at the foot of which it receives Calfpasture river on the left. Breaking through the Blue Ridge about 15 m. N. E. of the Peaks of Otter, it resumes its S. E. course to Lynchburg, near which town it bends sharply to the N. E. On reaching the boundary between Albemarle and Buckingham cos., it takes an E. S. E. direction, which it retains with little variation until it reaches Richmond, where it turns nearly S. It is here obstructed by rapids, and embraces a number of small islands. Near the S. E. extremity of Henrico co. it again takes a S. E. course, after some tortuous deviations, and finally flows into the S. part of Chesapeake bay, through a broad estuary, at the mouth of which are Hampton roads. Willoughby point and Old Point Comfort are on either side of its embouchure. The river is 450 m. long, and navigable by vessels of 180 tons to Richmond, at the head of tide water, 150 m. from the sea, whence the James River and Kanawha canal, completed to Buchanan in Botetourt co., passes along its upper course. The principal tributaries of James river are the Appomattox on the right and the Chickahominy on the left. The most important towns on its banks are Richmond and Lynchburg.

**JAMESTOWN**, a village of Chautauqua co., New York, at the outlet of Chautauqua lake and on the Atlantic and Great Western, and the Dunkirk, Alleghany Valley, and Pittsburgh railroads, 55 m. S. S. W. of Buffalo; pop. in 1870, 5,336. It is connected by a daily line of steamers with Mayville, at the opposite end of the lake, and contains a piano factory, several sash and blind factories, two machine shops and founderies, an edge-tool factory, a large alpaca factory, woollen mills, three large chair factories, &c. There are three national banks, four hotels, a collegiate institute, two daily and two weekly newspapers, and eight churches. The lake is becoming a favorite summer resort. Eight hotels and many cottages have been erected on its shores, and four steamers and numerous yachts ply upon it.

**JAMESTOWN**, the first English settlement in the United States, situated within the present limits of James City co., Virginia, on a point of land projecting from the N. bank of James river, 32 m. above its mouth. The encroachments of the river have converted the promontory into an island, and a portion of the site of the settlement has been entirely swept away. A part of the old church tower, with some tombstones standing around it, is now the only relic of the ancient town. There is a private residence on the island. Jamestown was founded in 1607 by 105 colonists sent out by the London company under command of Christopher Newport. Capt. John Smith and Bartholomew Gosnold were prominent members of the expedition. Their fleet, consisting of three vessels, entered the Chesapeake April 26, and sailing up the James river, which they named in honor of the reigning king of Eng-

land, anchored off a beautiful promontory, where in May they began to build a town. During the first season of their arrival the colony was exposed to extreme want and danger, and it was only saved from speedy destruction by the energy of Capt. Smith and the good offices of Pocahontas. The first colonial assembly ever convened in America was held at Jamestown, June 29, 1619. On March 22, 1622, several hundred colonists were massacred by the Indians. (See VIRGINIA.) Nathaniel Bacon, during the rebellion which took its name from him, burned the town in 1676.

**JAMI** (ABDERRAHMAN BEN AHMED), a Persian poet, born A. D. 1414, died in 1492. He derived his surname Jami from Jam, the place of his birth in Khorasan. After excelling in other studies, he applied himself to the mystical doctrine of the Sufis under the celebrated sheik Saad ed-Din of Kasbgar, and was judged worthy to succeed that master in his school. His eloquence and amiable character, and the beauty of his poems, made him a favorite of the vizier Ali Shir, the sultans of Herat, Abu Said and Hussein Mirza, and also of the Ottoman sultans Mohammed II. and Bajazet II. He was equally esteemed by the common people, whom he instructed beneath the portico of the mosque of Herat in the principles of morals and religion. He is one of the best, most learned, and most voluminous of the Persian poets, and composed about 50 works in prose and verse, in Arabic and Persian. Among the more important of them are "Yusuf and Zuleika," translated into English by Thomas Law in the "Asiatic Miscellanies," and published in German with the original text by Rosenzweig (Vienna, 1824); the "Golden Chain," a satirical poem against two heretical sects, edited by F. Falconer (London, 1848); "Selman and Absal," edited by Falconer (London, 1850); the "Book of the Wisdom of Alexander;" *Beharistan* (the "Abode of Spring"); and the prose work, *Nasihat ul-ins* ("Breath of Man"), a history of mysticism.

**JAMIESON**, John, a Scottish clergyman, born in Glasgow, March 8, 1759, died in Edinburgh, July 12, 1838. He was the son of a Secession minister settled in Glasgow, and was educated at the university of that city. At the age of 20 he was licensed as a preacher, and in 1781 was ordained pastor of a small congregation in Forfar, where he remained 16 years on a salary of £50. During this time he published "Socinianism Unmasked" (1788), "The Sorrows of Slavery, a Poem" (1789), "Sermons on the Heart" (2 vols. 8vo, 1789-'90), and "A Vindication of the Doctrine of Scripture and of the Primitive Faith concerning the Deity of Christ" (2 vols. 8vo, 1794), in which the arguments of Priestley in his "History of Early Opinions" are ably combated. In 1797 he was settled over a congregation in Edinburgh, where he passed the remainder of his life. In 1802 appeared his "Use of Sacred History" (2 vols. 8vo), and in 1808-'9 his most important work,

"Etymological Dictionary of the Scottish Language" (2 vols. 4to), of which he published in 1818 an 8vo abridgment, followed in 1825 by a supplement to the large edition in 2 vols. 4to. Among his remaining works are: "Hermes Seythicus, or Radical Affinities of the Greek and Latin Languages to the Gothic" (8vo, 1814); "Historical Account of the Ancient Culdees of Iona" (4to, 1811); "Grammar of Rhetoric and Polite Literature" (12mo, 1818); editions of Barbour's "Bruce" and Harry the Minstrel's "Sir William Wallace;" and a number of occasional sermons and poems. He received the degree of D. D. from Princeton college, N. J., and during the last five years of his life enjoyed a literary pension of £100.

**JANAUSCHEK, Fanny**, a Bohemian tragic actress, born in Prague, July 20, 1830. Her talent was developed under the direction of Bendix at Cologne, and from 1848 to 1860 she was a favorite at the Frankfort theatre. Subsequently she appeared in Dresden and in other German cities. From 1867 to 1871 she performed in the United States in German, and after a visit to Germany reappeared here in 1873, performing successfully in English, and winning great applause by her tragic genius. In 1874 she went again to Germany, intending soon to return for a farewell tour.

**JANES, Edmund Stoner**, an American clergyman, born in Sheffield, Mass., April 27, 1807. His early life was mostly spent in Salisbury, Conn. From 1824 to 1830 he was employed in teaching, and occupied his leisure in the study of the law, intending to follow that profession; but he entered the ministry of the Methodist Episcopal church, and in 1830 joined the Philadelphia conference. From this time he devoted himself to the study of theology, and during the intervals of immediate pastoral labor he also read extensively in medicine. In May, 1840, he was appointed financial secretary of the American Bible society, and remained in this office till 1844, when he was elected bishop. During the 30 years of his episcopal labors Bishop Janes has been intrusted with some of the most grave and delicate duties connected with the affairs of the Methodist church, among which may be mentioned his appointment as delegate to the British Wesleyan conference in 1864, and the supervision and inspection of the Scandinavian, German, and Swiss missions in Europe from 1864 to 1868. In 1865 he visited England as delegate of the American Bible society to the British and foreign Bible society; and he also attended the French Wesleyan conference at Paris and the Irish conference at Cork. At Bremen he delivered before a large meeting an address on the death of President Lincoln, which was widely circulated in northern Europe, and had an important effect on public sentiment there at a critical period. His residence has long been in New York city.

**JANESVILLE**, a city and the county seat of Rock co., Wisconsin, in the S. part of the state,

situated on both sides of Rock river, and at the intersection of the Wisconsin division of the Chicago and Northwestern railroad with the Prairie du Chien division of the Chicago, Milwaukee, and St. Paul line, 85 m. S. E. of Madison and 71 m. W. S. W. of Milwaukee; pop. in 1860, 7,708; in 1870, 8,789. The ground on which the city is built rises gradually on either side to an elevation of nearly 100 ft. at the summit. The court house occupies a commanding position on the E. side of the river. An active trade is carried on by the railroads, and a large amount of capital is invested in manufactures, Rock river affording valuable water power. The principal establishments are flour mills, saw mills, machine shops, founderies, woollen factories, carriage factories, breweries, &c. There are two national banks, with a capital of \$225,000, and a savings bank. The city is the seat of the state institution for the education of the blind, supported by legislative appropriations, and open to pupils from Wisconsin free of charge except for clothing. This institution was founded in 1850, and in 1873 had 77 pupils. There are 14 public schools, including a high school, which in 1873 had 28 teachers and 1,150 pupils; a daily, a semi-weekly, and three weekly newspapers, and 11 churches. Janesville was founded about 1836, made the county seat in 1838, and incorporated as a city in 1853.

**JANET, Paul**, a French author, born in Paris in April, 1823. He is a follower of Comte, and has been professor at Bourges and Strasbourg, and at the lyceum of Louis-le-Grand, Paris. In 1864 he became professor of the history of philosophy at the Sorbonne, and a member of the academy of moral and political sciences, which institution awarded prizes to his *La famille* (Paris, 1855) and *Histoire de la philosophie dans l'antiquité et dans les temps modernes* (2 vols., 1858). Among his more recent works are *Histoire de la science politique* (1871), and *Problèmes du XIX<sup>e</sup> siècle* (1872).

**JANET-LANGE, Antoine Louis**, a French painter, born in Paris about 1818, died there in 1872. He studied under Collin, Ingres, and Horace Vernet, adopted the style of the latter, and became distinguished for historical and military pieces. Conjointly with Vernet he executed in 1843 designs illustrating the history of Napoleon I. One of his finest works represents "Nero contesting the Prize at the Chariot Race" (1855), and his subsequent productions include illustrations of Solferino (1861-'3) and "An Episode of the Siege of Puebla" (1868).

**JANIN, Jules Gabriel**, a French author, born of Jewish parents at St. Étienne, Dec. 11, 1804, died at Passy, June 20, 1874. He completed his classical studies at the college of Louis-le-Grand in Paris, studied law, and made a living as a private tutor; but he soon became one of the contributors to the *Figaro*, a sprightly opposition paper, and was also a regular writer for the royalist journal, the *Quotidienne*, until the accession of the Po-

so cabinet in August, 1829. A few weeks after he became a regular contributor to the *Journal des Débats*; and after writing political and miscellaneous articles, he took charge of the theatrical notices. His articles were less criticisms than short essays, written in a colloquial and gossiping style. Besides numerous prefaces, introductions, and articles in nearly every Parisian periodical which existed during his career, Janin published several novels, the first of which was *L'Âne mort et la femme guillotinée* (1829). Among his subsequent writings of the same class are *La confession* (1830), *Barnave* (1831), *Le chemin de travers* (1836), *Un cœur pour deux amours* (1837), *Religieuse de Toulouse* (1850), and *Les gâtés de Népétrea* (1851). He prepared an abridgment of Richardson's "Clarissa Harlowe," with *Essai sur la vie et les ouvrages de Samuel Richardson* (1846). Among his miscellaneous

works, exclusive of several illustrated publications to which he did little more than lend his name, are: *Contes fantastiques et contes littéraires* (1832); *Contes nouveaux* (1833); *Les catacombes* (1839); *Le voyage d'un homme heureux* (1840); *Les petits bonheurs* (1856); *Les symphonies de l'hiver* (1857), with drawings by Gavarni; and *Rachel et la tragédie*, a biographical and critical work, with photographic illustrations (1859). His *Histoire de la littérature dramatique en France* (4 vols., 1851-'6) is a selection of his weekly *feuilletons*, remodelled so as to present a sketch of the history of the French stage and dramatic artists during nearly a quarter of a century. In 1870 he succeeded Sainte-Beuve in the French academy. His latest work was *Paris et Versailles il y a cent ans* (1874).

**JANINA**, or **YANINA**, a city of Albania, European Turkey, capital of a vilayet of the same



Janina.

island (pop. 400,000, chiefly Greeks), on a small peninsula on the bank of the lake of Janina, 120 m. W. by N. of Larissa; pop. about 16,000, of whom 9,500 are Christians, 4,000 Mussulmans, and 2,500 Jews. The population has decreased about 10,000 since 1861, chiefly in consequence of emigration and military contention. The streets are narrow and crooked, most of the houses are poor. It is the seat of a Greek metropolitan, and contains 7 churches, 18 mosques, 2 synagogues, a Greek school, a library, and a hospital. Among the manufactures are gold lace and brocade, morocather, colored linen, and silk goods. The surrounding country yields grain, fruits, wine, tobacco, and timber in abundance, and is rich in mineral lands, sheep and goats constituting a principal source of wealth.—The site of Janina

and its lake answers to that of the city and lake of Eurœa in Epirus mentioned by Procopius. Justinian built a fortress at Eurœa, probably on the site now occupied by the citadel of Janina. In the later period of the Byzantine empire its territory was a field of contention between the Greeks and Wallach and Slavic settlers. In the latter part of the 11th century it was taken by the Normans, who defeated Alexis Comnennus under its walls. Toward the middle of the 15th century it fell into the hands of the Turks. At the beginning of the present century Janina enjoyed a high degree of prosperity, numbering about 40,000 inhabitants, possessing an extensive trade and a large annual fair, and ranking among the most accomplished and industrious of modern Greeks. But the despotic rule of Ali Pasha, governor of the city, led to

its ruin. When no longer able to defend the city, he set it on fire. (See ALI PASHA.) The mosques, the palaces, and the two academies for which Janina was celebrated, were all destroyed. Opposite the city is a small island with a fishing village and a church and monastery.—The lake of Janina is about 6 m. in length, and almost 3 m. in its greatest breadth, bounded N. E. by the Mitzikeli mountains (2,500 ft. high), and S. W. by a rocky mountain crowned with the ruins of an Epirote city, supposed to have been the ancient Dodona. The N. W. part of the lake is commonly called the lake of Lapsista, and the S. E. that of Janina. The middle resembles a marsh rather than a lake, and is traversed by two long channels which connect the two portions. The waters of both lakes are absorbed by subterranean channels; that which communicates with the river Kalamas (the Thyamis of the ancient Greeks) is in the lake of Lapsista. The lake of Janina abounds with pike, perch, carp, tench, eels, and other fish. Immense numbers of wild fowl breed in the covert of the lofty reeds upon its shores. It has been proposed to drain the lake by boring a tunnel 6 m. long through a limestone mountain.

**JANIZARIES**, a body of Turkish infantry now extinct. The name is derived from *yeniskeri*, or *yeni* and *askari*, "new troops." They were first assembled in 1329 by Sultan Orkhan, but were not regularly organized until 1362, when Amurath I., after conquering the southern Slavic kingdoms, claimed one fifth of the captives, including the able-bodied youth, to be converted to Islamism and educated as soldiers. This was done with extraordinary care, the recruits being distributed at first among the peasantry of Asia Minor, that they might become hardened by rural life and familiar with Mohammedanism. They manifested all the enthusiasm of proselytes; and as this spirit was warmly encouraged, and as privileges were granted them, they soon became a formidable means of defence. They were divided at first into 80, afterward into 162, and finally into 196 *ortas*, each numbering in Constantinople nominally 100 men, and elsewhere 200 or 300, in time of peace, but 500 in time of war. Besides the *aga*, or commander-in-chief of the whole body, six officers were attached to each *orta*, the chief being called the *orta-bashi*. The lowest officer was the cook, who also performed various other duties, and for whom the soldiers manifested great reverence. They never appeared without a wooden spoon in their turbans, and on extraordinary occasions always assembled around their soup kettles; their revolts were proclaimed by reversing these kettles, and to lose one of them in battle was looked upon as a disgrace equivalent to the loss of colors in other armies. Under Solyman the Magnificent they formed the best disciplined force in Europe. After his death, when the sultans ceased to lead their armies in person, the organization fell into decay. It

was no longer recruited exclusively from young Christian prisoners of war, or from levies on the Slavic provinces, but from any persons who could obtain appointments in it by intrigue, until finally it consisted in a great measure of menials and vagabonds, many of whom



Janizaries—Officers.

followed no military exercises and were permitted to engage in trade or mechanical and other occupations. But they still supplied something like an organization to the turbulent mob of the Turkish cities, and were long really formidable to society and government itself. They mutinied repeatedly against the sultans, and in some cases deposed them or put them to death. They frequently pillaged the cities which it was their duty to guard. In 1793 Selim III. attempted to form a better army by instituting the *nizam-jadid* or disciplined troops. This caused a revolt, the abdication and death of Selim (July 28, 1806), and terrible outrages in Constantinople (Nov. 14). Mahmoud II. was obliged on reaching the throne to pardon the janizaries; but, impressed with the danger of such troops, he quietly matured during several years a plan for ridding himself of them. Having gained over some of their officers and the Mohammedan priesthood, he resolved to exterminate them, and on May 23, 1826, published a decree ordering that 150 janizaries of every regiment should be formed into a regularly disciplined militia. This, as was expected, led to a revolt (June 15, 1826), the janizaries committing horrible excesses. The next day they assembled and reversed their kettles. But the mufti displaying the sacred standard of Mohammed, all the better class of the population joined the regular troops. Artillery had been long prepared in anticipation of this event, and great numbers of *gallopis*

or sailors, and *bostangis* or imperial private guards, were also ready for attacking the janizaries. "Burned alive in their barracks, cannonaded in the At Meidan, where they made their most desperate defence, massacred singly in the streets during three months, the remainder were condemned to exile." About 25,000 janizaries were thus killed, and they have never been reorganized.—See Macfarlane's "Constantinople in 1828," and *Précis historique de la destruction du corps des janizaires*, translated from the Turkish by Causin de Perceval (Paris, 1838).

**JAN MAYEN**, a volcanic island in the Arctic ocean, situated between Iceland and Spitzbergen, about 200 m. from the E. coast of Greenland. It contains the snow-clad volcano Beerenberg, nearly 7,000 ft. high, covered by large glaciers and frozen waterfalls. Another active volcano, the Esk (1,500 ft. high), was discovered by Scoresby in 1817. The island was discovered by the Dutch navigator Jan Mayen in 1611. It is not habitable, abounds in bears, foxes, and sea fowl, and is described by Lord Dufferin in his "Letters from High Latitudes."

**JANNEQUIN, Clément**, a French musician of the 16th century, popularly known as *Clemens von Papa*. The dates of his birth and death are uncertain; he lived in the reign of Francis I. His earlier compositions were for the Catholic and his later ones for the Reformed church. Most of them were for four voices. They were full of originality and invention, and many of them of great difficulty.

**JAN SAHIB**, a Hindoo poetess, born at Furruckabad in 1820. She received a superior education, and became proficient in letters, in music, and in the Persian language. She published in 1846 at Lucknow, where she resides, a collection of poems (*Diwan*), which are greatly admired by her countrymen.

**JANSENIUS (JANSEN), Cornelius**, a Dutch theologian, born at Akoî, near Leerdam, Oct. 28, 1585, died in Ypres, May 6, 1638. He studied theology at the university of Louvain, which unwaveringly adhered to the Augustinian system of Baius (died 1589); though 76 propositions of it had been condemned in 1567 by the see of Rome. After studying and teaching at Paris and Bayonne, he became in 1617 president of the Pulcheria college at Louvain, where he lectured on theology, and in 1630 professor of theology at the university. In 1635 he was made bishop of Ypres. The writings of Augustine against the Pelagians he read 30 times, and his other writings 10 times. Like Baius he adopted the Augustinian doctrine of grace in its strictest sense, and was therefore opposed to the theological views of the Jesuits, whom he prevented from lecturing at Louvain on philosophy. He believed that the Catholic church of his time had in this and in other points departed from the doctrines of the old church, and therefore in 1621 projected, with his friend Duvergier de Hauranne, abbot of St. Cyran, the plan of a

reformation, Jansenius taking the doctrine and St. Cyran the constitution and the religious life as their respective fields of labor. Irish clergymen of high standing and the heads of the French Oratorians favored this plan. In spite of the violent opposition of the Jesuits and the inquisition, he was sustained throughout his controversies by the Spanish government; and he confirmed his influence at Madrid by twice visiting that city (1624-'5). Jansenius commenced his work on the doctrine of Augustine in 1627, and had hardly finished it when he died. On his deathbed he recommended to his friends its publication, which the Jesuits and the papal nuncio at Cologne, anticipating the renewal of a violent controversy, strove to prevent. It appeared (8 vols. fol.), under the auspices of the university, and the editorial care of Liberus Froidmont and Kalen, in 1640, with the title *Augustinus, seu Doctrina Augustini de Humana Natura Sanitate, Aegritudine et Medicina, adversus Pelagianos et Massilienses*, and was soon reprinted at Paris (1641) and Rouen (1648). The work sets forth the Augustinian doctrine of irresistible grace and absolute election or rejection, mostly in the words of Augustine; it rejects the use of reason in religious questions, designates philosophy as the mother of all heresy, defends Baius, and accuses the Jesuits in general, and in particular Fonseca, Lessius, Molina, and others, of semi-Pelagianism. The Jesuits attacked the work as repeating the condemned propositions of Baius, and Urban VIII. in 1642 condemned it as heretical by the bull *In eminenti*, and placed it on the prohibitory index.—The name *Jansenists* is commonly applied to those Christians who, in France particularly, considered the opinions of Jansenius the true doctrine of the Catholic church, notwithstanding their condemnation by all the popes since 1642. In Holland, where they always maintained their hierarchical organization in spite of the censures of the Roman see, they called themselves the Old Episcopal or Old Catholic church, a designation which has recently been adopted also in some parts of Germany. The friends of Jansenius in the Netherlands, among whom were several bishops and nearly all the professors of the universities, submitted after some hesitation to the bull *In eminenti* in 1647. A greater resistance was made in France, where St. Cyran, Antoine Arnauld, his sister Angélique, the abbess of the Cistercian convent of Port Royal, Pascal, and a community of scholars who lived in the manner of the ancient anchorites in the vicinity of Port Royal des Champs (*messieurs de Port Royal des Champs*), took their stand in favor of Jansenius. When Innocent X. in 1653 denounced five propositions in the works of Jansenius as heretical, a majority of the Jansenists denied that these propositions had been understood by the author in the sense in which they were condemned. Alexander VII., however, in 1656 demanded of the French clergy

a declaration by which they should reject the condemned propositions as propositions of Jansenius. This raised the question, whether the pope's admitted infallibility in matters of faith extended also to historical facts. Louis XIV. lent his support to the execution of this as well as other measures of the popes against Jansenism, declaring at a national assembly of the French clergy in 1669 that he regarded it as his religious duty to exterminate Jansenism. Clement IX. in 1668 endeavored to put a stop to the controversy by a decree (*Pax Clementina*), which demanded merely a rejection of the five propositions, without ascribing them to Jansenius. (*La paix de Clément IX.*, Brussels, 1701. The author, who is not named on the title page, was Quesnel, who died in 1719.) But Clement XI. and Louis XIV. soon had recourse to severer measures; many Jansenists fled to the Netherlands, and Port Royal was suppressed in 1709. The controversy had broken out with new violence on the publication of Quesnel's celebrated work on the New Testament (*Le Nouveau Testament en français, avec des réflexions morales*). Clement XI., by the constitution *Unigenitus* (1713), condemned 101 propositions of this book as heretical, dangerous, or offensive to pious ears. A large portion of the French clergy and people, with the archbishop of Paris, the cardinal de Noailles, at their head, publicly resisted the constitution, and were therefore called Anticonstitutionalists. A papal decree of Sept. 2, 1718, threatened with excommunication all who would not submit unconditionally. Many yielded, among them Cardinal Noailles, but four bishops (those of Mirepoix, Montpellier, Boulogne, and Senes) appealed to an œcumenical council. Those who sustained this appeal, among whom were many opposed to Jansenism, were called Appellants. The parliament perseveringly resisted the decrees against Jansenism; the Sorbonne wavered, and when pressed generally submitted to the papal decrees. Some of the bishops continued to patronize it, and the general chapter of the Oratorians resolved in 1727 not to accept the bull *Unigenitus*. A popular saint, Francis of Paris, died with the appeal in his hand (1727), and the miracles and wild convulsions which were reported to have taken place at his grave made a deep impression on large classes of the people. But when the constitution by an act of royal sovereignty had been enforced as a law of the kingdom (1730), the resistance of the Jansenists was gradually overcome, and the Oratorians accepted the bull in 1746. New difficulties arose for a while when Beaumont, archbishop of Paris, in 1752, ordered the sacraments to be refused to all who had not accepted the constitution; but in 1756 peace was restored by means of a mild pastoral letter from Benedict XIV. The Jansenist party remained very strong among the French clergy, and most of the clerical deputies in the states general of 1789 belonged to it. After the res-

toration also it found many advocates among the clergy and laity, and since 1854 has had an organ in the religious press (*L'Observateur Catholique*). In Italy several bishops who were in favor of the reforms of Leopold I. of Tuscany and of Napoleon, as Ricci, bishop of Feltre, and Capece-Latro, archbishop of Taranto, were regarded as Jansenists.—While Jansenism remained in France a theological school, it became in the Netherlands an independent church. In 1704 Codde, the vicar apostolic of the archbishopric of Utrecht, was deposed by the pope for holding Jansenistic views, but the chapter refused to acknowledge the validity of this deposition. In 1723 the chapter chose an archbishop of Utrecht, who was consecrated by the bishop of Babylon, a French bishop *in partibus* who lived as a fugitive at Amsterdam. The pope was informed of the election, but answered by a condemnatory brief. The archbishop appealed from the condemnation of the pope to the next general council, a step which has since been taken by each of his successors. The next archbishop, Barchman Wuytiers, received letters of communion from many bishops, more than 100 of which are preserved in the archives of the church of Utrecht. After the death of the bishop of Babylon, Archbishop Meindaarts (elected in 1739) restored the archbishopric of Haarlem in 1742, and that of Deventer in 1758, in order to secure a succession of prelates. In 1856 the bishops of the Jansenist church jointly protested against the doctrine of the immaculate conception. They took an active interest in the rise and progress of the Old Catholic movement in Germany. By invitation the archbishop of Utrecht in 1872 administered the sacrament of confirmation in a number of Old Catholic congregations of Germany, and in 1873 the bishop of Deventer, the only surviving bishop of the Jansenist church, consecrated the first Old Catholic bishop in Germany. The Jansenist church in 1873 has 25 congregations and 25 pastors, all in the dioceses of Utrecht and Haarlem, the diocese of Deventer having no congregation. In 1874 the Jansenist church of Utrecht, numbering about 5,000 members, formally joined the Old Catholics.—See Leydecker, *Historia Jansenismi* (Utrecht, 1695); Lucchesini, *Historia Pœnœ Jansenismi* (3 vols., Rome, 1711); Tregelle, "The Jansenists" (London, 1851); and the Rev. J. M. Neale, "History of the so-called Jansenist Church of Holland" (Oxford, 1856).

**JANSSENS, Abraham**, a Flemish painter, born in Antwerp in 1569, died about 1631. He enjoyed the highest reputation in Antwerp; Rubens established himself there after his residence in Italy. In vigor of coloring he is scarcely inferior to Rubens.

**JANUARIUS, Saint** (Ital. *San Gennaro*), Christian martyr, patron saint of Naples, born in Naples, or according to some accounts in Benevento, April 21, 272, beheaded at Pozzuoli Sept. 19, 305. He was made bishop of Benevento about 303, just as the persecution under

a declaration by which they should reject the condemned propositions as propositions of Jansenius. This raised the question, whether the pope's admitted infallibility in matters of faith extended also to historical facts. Louis XIV. lent his support to the execution of this as well as other measures of the popes against Jansenism, declaring at a national assembly of the French clergy in 1660 that he regarded it as his religious duty to exterminate Jansenism. Clement IX. in 1668 endeavored to put a stop to the controversy by a decree (*Pax Clementina*), which demanded merely a rejection of the five propositions, without ascribing them to Jansenius. (*La paix de Clément IX.*, Brussels, 1701. The author, who is not named on the title page, was Quesnel, who died in 1719.) But Clement XI. and Louis XIV. soon had recourse to severer measures; many Jansenists fled to the Netherlands, and Port Royal was suppressed in 1703. The controversy had broken out with new violence on the publication of Quesnel's celebrated work on the New Testament (*Le Nouveau Testament en français, avec des réflexions morales*). Clement XI., by the constitution *Unigenitus* (1713), condemned 101 propositions of this book as heretical, dangerous, or offensive to pious ears. A large portion of the French clergy and people, with the archbishop of Paris, the cardinal de Noailles, at their head, publicly resisted the constitution, and were therefore called Anticonstitutionalists. A papal decree of Sept. 2, 1718, threatened with excommunication all who would not submit unconditionally. Many yielded, among them Cardinal Noailles, but four bishops (those of Mirepoix, Montpellier, Boulogne, and Senes) appealed to an œcumenical council. Those who sustained this appeal, among whom were many opposed to Jansenism, were called Appellants. The parliament perseveringly resisted the decrees against Jansenism; the Sorbonne wavered, and when pressed generally submitted to the papal decrees. Some of the bishops continued to patronize it, and the general chapter of the Oratorians resolved in 1727 not to accept the bull *Unigenitus*. A popular saint, Francis of Paris, died with the appeal in his hand (1727), and the miracles and wild convulsions which were reported to have taken place at his grave made a deep impression on large classes of the people. But when the constitution by an act of royal sovereignty had been enforced as a law of the kingdom (1730), the resistance of the Jansenists was gradually overcome, and the Oratorians accepted the bull in 1746. New difficulties arose for a while when Beaumont, archbishop of Paris, in 1752, ordered the sacraments to be refused to all who had not accepted the constitution; but in 1756 peace was restored by means of a mild pastoral letter from Benedict XIV. The Jansenist party remained very strong among the French clergy, and most of the clerical deputies in the states general of 1789 belonged to it. After the res-

toration also it found many advocates among the clergy and laity, and since 1854 has had an organ in the religious press (*L'Observateur Catholique*). In Italy several bishops who were in favor of the reforms of Leopold I. of Tuscany and of Napoleon, as Ricci, bishop of Pistoja, and Capece-Latro, archbishop of Taranto, were regarded as Jansenists.—While Jansenism remained in France a theological school, it became in the Netherlands an independent church. In 1704 Codde, the vicar apostolic of the archbishopric of Utrecht, was deposed by the pope for holding Jansenistic views, but the chapter refused to acknowledge the validity of this deposition. In 1723 the chapter chose an archbishop of Utrecht, who was consecrated by the bishop of Babylon, a French bishop *in partibus*, who lived as a fugitive at Amsterdam. The pope was informed of the election, but answered by a condemnatory brief. The archbishop appealed from the condemnation of the pope to the next general council, a step which has since been taken by each of his successors. The next archbishop, Barchman Wuytiers, received letters of communion from many bishops, more than 100 of which are preserved in the archives of the church of Utrecht. After the death of the bishop of Babylon, Archbishop Meindaarts (elected in 1739) restored the suffragan see of Haarlem in 1742, and that of Deventer in 1758, in order to secure a succession of prelates. In 1856 the bishops of the Jansenist church jointly protested against the doctrine of the immaculate conception. They took an active interest in the rise and progress of the Old Catholic movement in Germany. By invitation the archbishop of Utrecht in 1872 administered the sacrament of confirmation in a number of Old Catholic congregations of Germany, and in 1873 the bishop of Deventer, then the only surviving bishop of the Jansenists, consecrated the first Old Catholic bishop for Germany. The Jansenist church in 1873 had 25 congregations and 25 pastors, all in the dioceses of Utrecht and Haarlem, the diocese of Deventer having no congregation. In 1874 the Jansenist church of Utrecht, numbering about 5,000 members, formally joined the Old Catholics.—See Leydecker, *Historia Jansenismi* (Utrecht, 1695); Lucchesini, *Historia Polemica Jansenismi* (3 vols., Rome, 1711); Tregelles, "The Jansenists" (London, 1851); and the Rev. J. M. Neale, "History of the so-called Jansenist Church of Holland" (Oxford, 1864).

**JANSSENS, Abraham**, a Flemish painter, born in Antwerp in 1569, died about 1631. He enjoyed the highest reputation in Antwerp until Rubens established himself there after his residence in Italy. In vigor of coloring he is scarcely inferior to Rubens.

**JANUARIUS, Saint** (Ital. *San Gennaro*), a Christian martyr, patron saint of Naples, born in Naples, or according to some accounts in Benevento, April 21, 272, beheaded at Pozzuoli, Sept. 19, 305. He was made bishop of Benevento about 303, just as the persecution under







Diocletian began. During a visit which he made to the imprisoned confessors of the faith at Nola, he was arrested and taken before Timotheus, the governor of the province. This officer is said to have condemned him and his companions to be cast to the wild beasts in the amphitheatre at Pozzuoli; but as the animals refused to harm them, they were all beheaded. It is further related that Januarius was buried at Pozzuoli, but two small phials filled with his blood on the place of execution were afterward presented to Severus, bishop of Naples. To this latter city the remains of the martyr were transferred about the year 400; but in 817 they were carried off to Benevento by Sicon, prince of that city, and from Benevento they were conveyed in 1159 to Monte Vergine. On Jan. 13, 1497, they were once more brought back to Naples with great pomp. Many miracles are attributed by the early annalists to the exhibition of his relics on various occasions, as the staying of the plague and of eruptions of Vesuvius. It has long been customary in Naples to expose these relics to the public veneration on the saint's festival, Sept. 19, and also on the first Sunday in May and Dec. 16, as well as in seasons of national calamity. The relics are exposed amid great solemnity on the high altar of the cathedral, or in the church of Santa Chiara. Then takes place the celebrated liquefaction of the saint's blood. The two phials, containing what appears as a hard substance, and a glass case enclosing the head, are brought separately from the chapel in which they are preserved, the body itself reposing in the shrine beneath the high altar of the cathedral. As soon as the head is brought near the phials the blood is seen to become liquid, to bubble, rise in the bottles, and fall again; the alleged miracle lasting sometimes eight days. On such occasions popular enthusiasm is raised to its height. The nature of this phenomenon has been investigated by scientific men of various creeds and nations, and several hypotheses have been suggested to account for it. Roman Catholics regard it as a miracle, but it has never received the sanction of the church, such as is granted to miracles in the solemn processes of beatification and canonization.

**JANUARY** (Lat. *Januarius*), the first month of the year, consisting of 31 days. It is said to have been added with February by Numa to the Roman year, which previously had but ten months. It was named from the double-faced god Janus, to whom its first day, which looks back upon the past year and forward upon that to come, was sacred. It had originally but 29 days, but two additional days were given to it by Julius Caesar when he reformed the calendar. It was symbolized in Rome by a consul in consular robes, because those magistrates were installed in office on its first day. It corresponded in the Athenian calendar with the latter half of Poseideon and the first half of Gamelion. Among the Scandinavians it was called primitively month of Thor, and later

Ice month. The French revolutionary calendar merged it in parts of Nivose and of Pluviose. It was not uniformly the beginning of the year among Latin Christian nations until the 18th century.

**JANUS and JANA**, two divinities of ancient Rome. Their names are believed to be corruptions or abbreviations of Dianus and Diana, designating the sun and moon. Janus presided over the beginning of everything, and was therefore invoked on every occasion before all other deities. He opened the year and the seasons; he was the janitor of heaven, and on earth the guardian god of gates and doors; in time of war he went out to battle with the armies of Rome and aided them, while in time of peace he abode in his temple and watched over the city. At the dawn of every day the people addressed their supplications to him, and on the first day of every year sacrifices of cakes, barley, incense, and wine were offered in his honor on 12 altars. The worship of Janus is said to have been introduced into Rome by Romulus. Numa called the first month of the Roman year after him, and dedicated a covered passage near the Forum to him. This passage, frequently termed a temple, contained a statue of the god, and had two entrances, which were always kept open in time of war and closed in time of peace. They were closed only once during the republic, at the end of the first Punic war, and twice by Augustus. Janus was sometimes represented with two, and sometimes with four faces, and was accordingly styled *Bifrons* and *Quadrifrons*. In works of art he frequently has a staff or sceptre in his right hand and a key in his left.

**JAPAN** (called by the natives *Dai Nippon* or *Dai Nihon*), an empire consisting of a group of islands lying off the E. coast of Asia, between lat. 23° and 50° N., and lon. 122° and 153° E. The name Japan is a corruption of Marco Polo's term Zipangu, which represents the Chinese Shi-pen-kue, meaning "root of day" or "sunrise kingdom." The Japanese empire comprises the three most southerly islands of the Kuriles chain; Karafto or Saghalien S. of the 50th parallel, Yezo (Yesso), the main island, incorrectly called Nippon by Europeans; Shikoku (Sikok), Kiusiu (Kiusiu), and the Riu Kiu or Liu Kiu (Loo Choo) islands. Karafto is claimed by both Japan and Russia, and is jointly occupied by them. The entire number of islands composing Dai Nippon is officially stated to be nearly 4,000, though many of these are so small as to be hardly worthy of the name. The Japanese have no special name for the main island, and the foreign name Nippon is unwarrantable and confusing. It is about 800 m. long, and its area is about 80,000 sq. m. Yezo contains about 30,000, Shikoku about 7,000, and Kiusiu about 15,000 sq. m. Japan has been from ancient times divided into circuits similar to our terms eastern, middle, southern, and western states, and territories, a system of division still kept

up by the government, and taught in native geographies. *Kioto* (formerly Heian or Heian-jo, *Kioto* being a Chinese word signifying capital, of which the synonyme *miako* is used by the Japanese chiefly in poetry for *Kioto* or any great city, and not as a proper noun) was formerly the capital, and the divisions were named in reference to their direction from it. They were: the Gokinai, "five home provinces," surrounding *Kioto*; the Tokaido, "eastern-sea circuit," 15 provinces; the Tozando, "eastern mountain circuit," 8 provinces; the Hokurokudo, "northern land circuit," 7 provinces; the Sanindo, "mountain-back circuit," 15 provinces; the Sanyodo, "mountain-front circuit," 8 provinces; the Nankaido, "southern-sea circuit," 6 provinces; the Saikaido, "western-sea circuit," 9 provinces; the Hokkaido, "northern-sea circuit," 11 provinces; in all, 84 provinces, subdivided into 717 districts or shires. All these provinces, except the eleven of the Hokkaido (*Yezo*, *Kuriles*, *Karaffo*, &c.), and the seven into which *Oshiu* and *Dewa* have been divided since the late civil war, have each two names, one of purely native derivation, and the other composed of the Chinese word *shiu* added to the Chinese pronunciation of the character with which the native name is written; thus, *Nagato* is also called *Choshiu*, and *Satsuma*, *Sasshiu*. In many places the pedantic Chinese name has completely superseded the original Japanese in the mouths of the people; in a few both are used concurrently; while in some the original name is retained. Almost every Japanese word and name has also a Chinese synonyme or counterpart, which leads to endless confusion, and this is made greater by the names which foreigners continually misapply to mountains, rivers, and things in common use. For governmental purposes the empire is further divided into three *yu* or imperial cities, and 62 *ken* or prefectures. The most noted cities of Japan are *Tokio*, the capital (formerly called *Yedo*), *Kioto*, *Ozaka* (or *Osaka*), *Nagoya*, *Hiroshima*, *Saga*, *Kagoshima*, *Kanagawa*, and *Fukuoka*. These are cities of the first class, each reckoned to contain at least 100,000 inhabitants. *Nagasaki*, *Kumamoto*, *Fukui*, *Kurume*, *Yokohama*, *Gifu*, and *Yonezawa* rank in the second class, having more than 50,000. *Hakodate* (*Hakodadi*), *Matsumae*, *Niigata*, and *Hiogo* have from 20,000 to 50,000 each. There are probably 50 cities more, containing on an average more than 20,000. The population of Japan has never been properly ascertained, the Japanese method being merely to count the houses and average five persons to one house. Such a "census" was taken in 1804, and gave a population of 30,000,000. A hasty estimate was made by the department of education in 1872, and about 33,000,000 souls were reported. Foreign travellers and those who have long resided in Japan assign 20,000,000 as the highest and 15,000,000 as the lowest figures. *Shikoku*, *Kiushiu*, and the central provinces are thickly populated, especially along

the great roads. In the N. part of the main island the population is thin, and in the whole of *Yezo*, *Karaffo*, and the Japanese *Kuriles*, according to the native estimate, there are fewer than 60,000. In the *Riu Kiu* (*Loo Choo*) islands a population of 124,000 is claimed. *Tokio* (*Yedo*) contains 800,000, *Kioto* 567,334, and *Ozaka* 530,885 souls.—The coasts of Japan abound with promontories, and are much broken by bays and inlets; but there are many good harbors, of which the Japanese number 56 large and 290 smaller ones. There are many rocks along the coast, but the Japanese have excellent charts for the use of their junks and steamers, and the long continued work of foreign survey parties has reduced the danger of shipwreck by daylight to a minimum, while at night every great promontory on the coast is indicated by lighthouses or beacons of the most approved construction and equipment, which have been erected since 1869. The Japanese never give names to their straits or bays; all such names have been given by foreigners. Owing to the narrowness of the main island, and the smallness of the others, there are no very large rivers in Japan; most of them are mountain torrents, with short and rapid courses. *Kawa* or *gawa* is the native word for river. The *Tongawa* is the longest and widest, being 172 m. long. The *Yodogawa*, the outlet of *Lake Biwa*, flows past *Ozaka*. The *Kisogawa* flows into the bay of *Owari*. The *Tenrigawa* is the outlet of *Lake Suwa* in *Shinano*. The current of the *Oigawa* is very swift, and that of the *Fujikawa* is still more rapid. The *Samidagawa* flows past *Tokio*. The river called *Logo* by foreigners is properly named *Rokugo*. The chief lakes are *Biwa*, *Inawashiro*, *Sawa*, *Hakone*, and *Chiuzenji*. The three latter lie far above the level of the sea. *Lake Biwa*, or *Otsu*, is more than 60 m. long, and about 20 m. wide.—The most extensive plains are those of the *Kuanto* or plain of *Yedo*, *Echigo*, and the north of *Oshiu*. The provinces of *Mino*, *Mikawa*, and *Owari* are also very flat. The table land of *Shinano* lies about 2,500 ft. above the sea. The general trend of the mountain ranges is from N. to S., usually presenting a steep face to the E. and sloping on their W. side. The most noted peak is the volcanic cone *Fusiyama* (properly *Fujisan*, or *Fujinoyama*, "Rich Scholar peak"), 14,000 ft. high, in the province of *Suruga*, 70 m. S. W. of *Tokio*. Thousands of pilgrims ascend it annually. Its craters and hollows only are snow-covered in summer. *Hakuzan* or *Shiroyama*, in *Kaga*, is 9,000 ft. high. *Gassan*, *Mitake* in *Shinano*, the *Nikko* range, *Omine* in *Yamato*, and *Itteyama* in *Etchui*, are also well known. There are some active volcanoes, such as *Asamayama*, *Asoyama*, *Kirishima*, and *Yakeyama* in *Namba*. A perpetual pillar of steam rises from *Asamayama*; and in past times great destruction of life and property has been caused by eruptions of this and other volcanoes in Japan. The entire group of islands is volcanic, and earthquakes

are common, as many as 87 in one day having been counted. Scarcely a month passes without greater or less vibrations, and in some cases whole towns are destroyed by them. They are the frequent causes of fire in cities by overturning lights and braziers. An earthquake in Yedo in 1854 killed several thousand people, and threw down hundreds of houses. In general, however, the shocks are light, and the natives and resident foreigners care little about them. The houses are built with reference to resisting or neutralizing the shocks, mostly of timber, and their chief supports are set into sockets cut in round or waterworn stones. The roof is constructed of massive logs and beams covered with heavy tiles. The inertia of this mass secures stability, while the force of the shock is interrupted in its continuity, and greatly lessened by being broken at the sockets. Many temples, pagodas, and castles have thus withstood the shocks for centuries. The eastern half of the main island is most subject to earthquakes, and Shikoku and Kiushiu are far less so. Superstition attributes the cause of earthquakes to a huge catfish, whose head is under Oshiu and his tail under Kioto. His anger and struggles cause the seismic throes.—The surface of the whole empire is almost entirely a succession of hills and valleys. The soil is mainly diluvium and disintegrated lava, though every kind is known. It is in general fertile and well cultivated, but large tracts on the mainland and in Yezo lie uncultivated, being either not urgently needed, or, as in many cases, being useless from lack of scientific methods of improvement and fertilization. Japan could easily maintain double its present population. Rice land is made wherever possible, and after centuries of patient toil the largest part of the fertile land is laid out in the form of irrigated rice fields. In many places the mountain sides are terraced and tilled. The area under cultivation is not known, but is assessed at 31,620,000 *koku*. A *koku* is 5·13 bushels. Rice has hitherto been the standard of value. The amount which a given piece of land will produce is determined by threshing the rice grown on it and measuring the grain. The fertility of the soil varies greatly in different places, but rice land is worth five times more than arable land. Almost all agricultural labor is done by hand, and with the rudest tools.—The climate resembles that of our Atlantic seacoast states, though not so changeable as the latter. The meteorological records of one year (1864) in Yokohama were as follows, in monthly averages: January, 36·50°; February, 38·12°; March, 43·28°; April, 57·36°; May, 64·04°; June, 69·14°; July, 76·49°; August, 79·55°; September, 70·44°; October, 62·55°; November, 52·09°; December, 44·30°. Annual mean range of temperature, 58·02°. First frost, Nov. 26; first ice, Dec. 14. There were 205 fair, 61 cloudy, 92 rainy, and 8 snowy days. In 1864 71·44 inches of rain fell. The general

direction of the wind was N. in winter and autumn, and S. in summer. Rain and snow are rather more common on the W. coast than on the E. Rain falls abundantly in the spring and summer; June is considered the rainy month. In some years it rains constantly through September and October. Snow rarely remains on the ground longer than 24 hours in Tokio or S. of it. In the provinces N. of Kioto, on the W. coast, the snow lies for weeks at the depth of from 6 to 10 ft. Storms with thunder and lightning are much more rare than in the United States, but floods of rain and high winds are common. At least once if not oftener in the summer or early fall a cyclone or *tai-fun* (typhoon) visits the country, destroying life and property to an appalling extent. One which passed over Kobe July 4, 1871, dashed scores of junks and ships far up on land, demolishing houses, and killing more than 200 persons. In Fukui it blew down houses and damaged nearly every fence and roof in the city. Tidal waves after earthquakes are also to be looked for, and one on Dec. 22, 1855, destroyed part of the town of Shimoda, swept scores of the people into the sea, ruined the harbor by sweeping all the mud from the rocks, so that anchors were useless, and destroyed the Russian frigate Diana and a fleet of native junks.—Japan is rich in gold, silver, copper, lead, mercury, tin, coal, sulphur, and salt. Iron is also found in many of the provinces, but as it is in the form of magnetite oxide, the cost of smelting it is very great; hence Japan will not be able to produce enough native iron to supply her wants. The quality of Japanese iron, however, is very good, and often equal to the best Swedish. Tin is now more extensively mined than formerly, owing to the increasing use of tinned iron. Copper is so abundant that it was formerly of the same value as iron. Large quantities are still exported in the form of bars and blocks, old bells, idols, &c. Gold is obtained in many places, both by washing the earth and sands of rivers, and from the ore. Silver is extracted from its ores, but chiefly from argentiferous galena. Sado island, where most of the precious metals are mined, has a population of 3,000 native miners. The mines are worked under the supervision of two English miners, who have the most approved modern machinery. Many of the old mines throughout the country have been abandoned, but under an approved system of mining the mineral wealth of Japan will be increased. Blasting, introduced by Prof. Pumphelly, is now generally practised, and pumping, crushing, and washing are done by machinery. Graphite of excellent quality is mined in Satsuma, and used for pencils made by the natives. Bituminous coal of an inferior quality is dug in many places, but coal is largely mined in Yezo, Amakusa, Karatsu, and near Nagasaki, and sold for the use of steamers. Sulphur is abundant and of excellent quality. Petroleum is obtained in Echigo, Suruga, Yezo, and other

places, and used on the "Yankee lamps" now everywhere prevalent. Alum and green and blue vitriol are made by the natives. Granite, porphyry, obsidian, syenite, gneiss, freestone, and a great variety of the softer building stones are obtained in almost every province. Agates, carnelians, and jasper of great size and beauty are found. Small garnets are plentiful. Pearls are fished up along the coast, and the pearl fisheries may yet become a very important branch of industry. The rock crystals of Japan have long been celebrated for their great size and clearness. One at the Vienna exposition was a sphere, perfectly clear, and seven inches in diameter. The Japanese cut them into balls, and the native lapidaries are very skilful in their craft. Salt is produced by repeatedly saturating sand with salt water, drying it, and dissolving out the salt. Malachite and cinnabar are well known. Petrifications and fossils are often seen. Sulphurous, chalybeate, and mineral springs, the waters of which are variously impregnated, are very numerous throughout the empire.—There is perhaps no other country in the world of the same area that produces such a variety of conifers. They are everywhere abundant, the main roads are lined with them, and clipped hedges of *cryptomeria*, *retinosporu*, *biota*, &c., are very general. Around the temples, where they are never cut down, they attain the greatest size and grandeur. They are often trained to spread out over bamboo frames, and particular limbs are propped up and grow to a great length. Timber is very plentiful, cheap, and of great variety. The mulberry tree grows wild, but the young trees that are reared for the food of the silkworm are not allowed to grow more than 6 ft. high. The varnish tree (*rhus vernicifera*), from which the famed lacquer is made, also produces oil and vegetable tallow, like its near ally the *rhus succedanea*. Large quantities of camphor are exported, being obtained from the camphor trees which attain great age and size in Japan. The chief fruit trees are the apple, pear, plum, apricot, peach, chestnut, walnut, persimmon, pomegranate, fig, orange, lemon, and citron. The grape is the best fruit in Japan. Strawberries grow wild, but are nearly tasteless. Loquats and kumquats, as in China, are common. The persimmons are often as large as apples, and very sweet. The cherry tree blossoms, but bears no eatable fruit. The bamboo is found almost everywhere from Karafuto to Riu Kiu, and is put to an astonishing number of uses. The box tree, juniper, ivy, palm, elm, and a black wood like ebony are also found. The camellia grows wild, often 40 ft. high, and is cultivated everywhere for the beauty of its blossoms, an immense number of varieties being produced. Beans, peas, white and sweet potatoes, carrots, lettuce, beets, yams, tomatoes, ginger, egg plant, gourds, cucumbers, mushroom, lilies (the bulbs of which are eaten), bamboo (the young sprouts are eaten), spinach, leeks, radishes, garlic, capsicum,

endive, fennel, pumpkins, squashes, beets, turnips, and asparagus are the principal vegetables for the table. Many of these were introduced by the Dutch, and some by Com. Perry. The *daikon*, an enormous radish, often 30 in. long and 4 thick, is a staple article of food in both the fresh and pickled state. The food of the people is mainly vegetables and fish. Rice, millet, and buckwheat are eaten in great quantities; maize and barley are also raised. Rape for oil, hemp for cordage and cloth, cotton for clothing, indigo, and tobacco which is very mild, are cultivated. Many specimens of the American flora are now common in Japan.—The poverty of the Japanese fauna is well known, but, like the flora, it corresponds more closely to that of the American than to that of the Asiatic continent. In the woods and wicks are bears, wild boars, wolves, deer, badgers, foxes, ground squirrels, and hares. The monkeys are so numerous as to be troublesome at times. Weasels, martens, and moles are very common. Wild ducks and geese, pigeons, woodcocks, snipes, pheasants, teal, herons, and storks are among the birds used for food. The hawk, buzzard, crow, eagle, cormorant, gull, sparrow, red-billed magpie, and ortolan are numerous. The canary is now well domesticated in Japan, and the *unguis* or Japanese nightingale is noted for its music. Tame animals are now more numerous than formerly, owing to the increasing habit of eating meat. Venison, wild boar, and monkey meat have been eaten from ancient times; and beef, pork, and mutton, especially the first, are now eaten in all the large cities. Goats are found around Nagasaki, cows and bulls in every province, hogs in many places, and sheep in a few. The native horses are small and active. In Satsuma they are woolly, and in Tooa as small as Shetland ponies. Dogs are very numerous, but of gentle dispositions; and the highly prized variety of spaniel called *chia*, having a snub nose and silky fur, is supposed to be the original of the English variety called Prince Charles's spaniel. The cats are generally short-tailed; on the W. coast long-tailed cats are found, but most Japanese cats have tails from 1 to 3 in. long. Rabbits and guinea pigs are common pets. Among the domestic fowls, the turkey, peacock, goose, and swan are less common; but the bantam fowls, ordinary chickens, ducks, and pigeons are reared extensively for food. Fish is the staple animal food, and the great variety displayed in the markets, from river, lake, and sea, astonishes foreigners. The Japanese are especially fond of raw fish. A large proportion of the population are fishers. Many of the women are expert divers, often remaining for hours in the water; they can swim with bags full of heavy shell fish on their shoulders. Fishing is carried on with nets, hooks and lines, spears, bows and arrows, and with cormorants. Whales are pursued and killed whenever met with. Enormous squids with arms 25 ft. long, and crabs

whose outspread claws measure 14 ft. from tip to tip, are occasionally caught in the bay of Yedo. Sea otters and seals are shot in great numbers in Karafto and the Kuriles. The salamander is sometimes seen in the lakes and rivers. The reptiles and insects of Japan are varied and interesting.—The Japanese people are of middling size, in general active and vigorous; and in their mental characteristics they resemble Europeans more than the average Asiatic peoples. Their skins range through all colors from white to light brown, yellow copper color, dirty red, and almost black. The average hue is a pale copper on the body, and shades of yellowish brown in the face. The color depends greatly upon the degree of exposure; the ladies of the upper class, who rarely go out of the house, are often perfectly white and fair, while some of the coolies are almost as black as negroes. Their eyes are oblong, of a very dark brown, often deeply sunk in the head, and not so oblique as those of the Chinese. The upper lid toward the nose is folded so as to prevent the eyes from opening as widely as those of Caucasians. Their noses are flat, thick, short, depressed at the bridge, and round and open in front, instead of beneath. Their hair is not a true black, but of a very dark brown, sometimes distinctly red. Its blackness and coarseness are promoted by the universal practice of shaving the heads of the children from their birth. Usually it is made to appear very black and glossy with unguents and bandoline made from a mucilaginous plant. Some of the mountaineers, boatmen, and coolies are tall and muscular, but the average Japanese is flat-breasted, undersized, and weak in physique, compared with Caucasians. Both sexes have small hands and feet. The women are usually small and dumpy, though often very beautiful, and exceedingly neat in dress and coiffure. People of every age and sex bathe daily in hot water. In the public bath houses, so numerous in every street, the water is often intensely hot, which the bathers delight in, at the cost of half a cent. The heat of the water and the price of a bath are now regulated by government, which has also of late years prohibited the practice of promiscuous bathing. The married women, and those above 20 years of age, blacken their teeth with a mixture of galls and powdered iron, which forms a jet-like black, but is not more corrosive than common writing ink. The origin of this custom is now lost in obscurity. Formerly the emperor and court nobles blackened their teeth; they ceased to do so in 1868. The practice is now discouraged, and many women are forsaking it, following the example of the empress. Married women formerly shaved off their eyebrows, a custom now also falling into disuse. The Japanese maiden, wife, or widow may be distinguished by her coiffure. Among the men, the old percussion gun-hammer style of topknot or shaven scalp is rapidly giving way to the foreign style of hair dressing. In character, the people are lively and volatile, quick of apprehension, frank, liberal, and hospitable. They are peculiarly fond of military life, and make excellent soldiers and sailors. They learn rapidly, and show much aptitude for the acquisition of European knowledge. In the schools of America and Europe they have won the highest praise, and in some cases honors, which have not tended to decrease their natural vanity. Regard for truth and chastity, or reverence for human life, cannot be said to characterize the Japanese. The youth seems to be a model of all that is frank, noble, impulsive, obedient, grateful, and polite. The same individual as an official often appears the incarnation of deceit, meanness, ingratitude, and untruth, though always outwardly polite. The people are very industrious, but social and pleasure-loving, fond of feasts and frolics, and have frequent national and religious holidays. Music, dancing, and the theatre are the favorite amusements of all classes. Mountebanks, conjurers, jugglers, tumblers, and strolling players and musicians were formerly often seen in the streets, and were highly popular, but are now much less so. Japanese jugglers and acrobats have appeared in America and Europe, and have fully sustained the reputation of the people in these matters. Dancing consists almost entirely in posturing and quick movements of the body, our idea of moving about while dancing not being understood. Education, consisting in the arts of reading and writing the native syllabary, perusing the popular story books, and reckoning on the abacus, is very general, but not so much so as former accounts would lead one to suppose. The higher classes can read the Chinese and Japanese classics, which are now giving place to the study of foreign languages and books. The women are carefully educated in household duties, but in the lower classes receive very little instruction in book learning. In the higher classes the young ladies spend much time in making fancy work, and in being taught the various books relating to the duties of a wife, mother, and housekeeper. The "Woman's Great Study" is a large book containing minute details of woman's duty and culture. The three great duties of a woman are: 1, obedience to her parents when a child; 2, obedience to her husband, when a wife; 3, obedience to her eldest son, when a widow. Politeness is a national characteristic. A vast and minute system of etiquette is the life study of the higher classes, and among the lowest class mutual courtesy is strictly observed. The foreigner in Japan is surprised to hear the politest phrases and to see mutual forbearance among the commonest coolies. The Japanese make no distinction between politeness and morals. They say that cheating, lying, &c., are not polite. Politeness is goodness and virtue in their eyes. The rules that govern social intercourse are formed into a regular system, which is taught in schools.

Formerly the education of a Japanese was one half in books of etiquette, and one half reading and writing. In the school at Fukui in Echizen, over the foreign department of which the writer presided, the course of native studies required seven years. Five of these were devoted entirely to theoretical and practical study of etiquette, the reading of the lives of illustrious men and women, exhortations to duty, the classics of Confucius, the histories of Japan and China, and the composition of private and official letters. Such schools however existed only for the higher classes. Lower schools for teaching the rudiments of reading, writing, and reckoning also existed. Even the language is unique in its courtliness of expression, which is shown in its very structure. The people are in general neat and clean in their houses, persons, and dress. Tea is a universal beverage, and is served on all occasions in cups holding about half a gill, which are drained many times during the day. Every man and boy carries in his girdle a pipe with a tube of bamboo, and mouthpiece and tiny bowl of brass. The mild fine-cut tobacco is used, and smoking is general among men and women. The visitor is always served with tea, sweetmeats laid on white paper on a tray, and a little bowl with a live coal in it to light his pipe with. It is etiquette to carry away the remnants of the cake or candy folded up in the paper and put in the wide sleeve. Chop sticks take the place of the knife and fork. Meat, venison, poultry, game, and large vegetables are cut or sliced before being brought on the table. Food is eaten out of lacquered wooden bowls and porcelain cups. A feast is accompanied by music and dancing, and the last of the many courses is rice and tea. *Saké*, or rice beer, is served throughout the feast; it is kept in tall bottles, which are first set in boiling water to heat the saké, which is always drunk hot. The cups used at a feast are very small, and are passed around or thrown across to each other by the guests, and filled by pretty damsels in waiting. At a banquet any one can introduce himself to another person by offering the cup; if he drinks and returns the cup, the introduction is made and acquaintance begins. The ordinary dress of both sexes and all ranks is somewhat similar in form, differing chiefly in the colors, fineness, and value of the materials, those of the higher orders being of silk, and of the lower orders of hemp and cotton cloth; it consists of a number of loose wide gowns worn over each other, and fastened by a girdle. Every class of the people is distinguished by certain peculiarities of dress. On the back and breast of the outer garment of the higher classes a family or clan crest is woven or worked. The sleeves are very long and wide, and serve for pockets. The Japanese display very good taste in their dress, but the women wear brighter colors than the men, and border their robes with gay embroidery and gold. On occasions of ceremony, a hempen jacket, open at the sides and projecting in

wings at the shoulder, and wide trousers of the same material, together forming the *kimishimo*, are worn. The *hakama* or loose trousers, like a long kilt, are the distinguishing mark of the dress of a *samurai*. Within doors socks or foot mittens, having a special compartment for the great toe, are worn. For outdoor use, clogs, heavy blocks of wood, or straw soles, having a double thong which fits between the great and second toe and binds over the top and side of the foot, are worn. Straw sandals are used by farmers, coolies, and travellers. Usually neither men nor women wear head coverings, except broad screens to shed the rain and to keep off the sun. In cold weather a cloth cap, covering all but the eyes and nose, is worn. Rain coats made of oiled paper, and cloaks made of straw or pieces of matting, are common in rainy weather. Their umbrellas are very large, the frames of bamboo, and the covering of oiled paper. The fan is carried by both sexes. Hitherto the custom of wearing two swords, one above the other on the same side of the body, was the distinguishing mark of the *samurai*; the lower classes were allowed to carry one sword. These customs are now nearly obsolete. European dress is becoming common among all classes, and the government officials are required by law to wear it. Even the court costume has been laid aside for black coats, white neckties and gloves, black pantaloons, and boots. The houses of the Japanese are low, and built of a frame of wood, with wattling of reeds or bamboo, the interstices filled with mud and covered with white plaster. The eaves are very broad, and a veranda extends around the house. The windows and doors are frames of wood, covered with paper, and sliding in grooves. Most of the partitions consist of sliding paper doors, which can be removed in a moment and a great hall extemporized. Outer shutters or "rain doors" protect the paper doors at night and in stormy weather. Almost every house, rich or poor, has a garden attached, which is usually a miniature landscape. Fire-proof warehouses are made by coating a strong frame of timber and bamboo with layers of mud amounting to a foot in thickness. The walls, doors, and windows are all of the same thickness and material. The merchant stores his goods and families put their valuables in these. Should a fire occur near by, a mud paste is quickly made, and several candles are lighted within the warehouse to convert the oxygen of the air into carbonic acid gas. The doors and windows are then closed, and the mud smeared over the cracks, to prevent any draft. After a fire these warehouses stand unharmed, like islands in a sea of ashes. Fires are frequent and terribly destructive. One in Tokio, April 3, 1872, destroyed 5,117 houses and made over 20,000 people homeless. It is estimated that the entire space of the city is burned over every seven years.—Polygamy is not allowed in Japan, but concubinage is very prevalent.

The emperor is allowed 12 concubines, though he rarely has so many. Usually a man does not take a concubine unless his wife is unfruitful; if the former bears a child, it is treated as legitimate, and becomes the father's heir, unless a child is born to the true wife. Divorces are common. Seven causes for divorce are enumerated in the "Woman's Great Study," viz.: barrenness, disobedience to husband or mother-in-law, gossiping, lewdness, leprosy, jealousy, theft. Prostitution is legalized, and is not specially disreputable. In the large cities the *uyomachi* or prostitutes' quarter is the most beautiful part of the city. Children are no longer bred to the trade from their infancy, as formerly, but young girls may voluntarily choose to be courtesans, and bind themselves to the brothel-keepers for a term of years. They are taught music and several other accomplishments, and often marry well, being better educated than the mass of the women. In the afternoon, at the brothel, they dress, paint, and powder themselves, put on splendid robes, and toward evening sit in a semicircle, motionless and waiting for the choice of some passer-by. The front of the raised room in which they sit is open to the street, or separated only by latticework for visitors to look through. Prostitution is in the cities confined to particular quarters, and is under strict governmental inspection. Prostitutes must wear a certain kind of dress, and tie their girdles in front instead of behind. Suicide is very common in Japan, and the ancient style of committing *hara-kiri* (belly-cut) is still in vogue, though evidently becoming obsolete. During the year 1872 at least 20 public instances of ripping up the belly took place. A proposition made in the supreme council to abolish the custom was not adopted. —The agriculture of the Japanese is conducted with diligence and skill. Irrigation is judiciously applied, and manure of all kinds, especially human, is carefully collected, and used in the production of generally good harvests. The grain principally raised is rice, which is of a superior quality, and is now an article of export. Next to rice tea is the great object of cultivation. Since the opening of the country an immense number of new tea plantations have been set out. The teas of Uji and Suruga are considered the best. Coarse sugar is obtained from Satsuma and universally used by the people, but the process of sugar refining is not yet fully understood. The gardeners of Japan have attained the art of dwarfing as well as enlarging vegetable productions. In the miniature gardens and at the flower shows they exhibit full-grown trees of various kinds 2 and 3 ft. high. Pine trees 3 in., bamboo 2 in., and blossoming plum trees 6 in. high are common. The pine, bamboo, and plum are usually planted together in pots, and called *shochikubai*, a word compounded of the three names. Trees and plants are also trained to grow so as to resemble birds, tortoises, quadrupeds, men, ships,

mountains, &c. In ornamental gardening the Japanese possess wonderful skill, and every kind of landscape is represented in their gardens. —The Japanese are admirable workers in metals. Iron, copper, and brass are wrought in every part of the country, and the swords of Japan have long been famous. They are made of the finest iron, with an edge of steel. The ornaments upon their hilts and handles, made of copper, silver, or gold, with inlaid work of various metals, are not only curiosities, but works of high art, often representing national heroes, mythology, &c. In alloying and coloring metals they are famous experts. They are skilful in carving wood and metal, in die-sinking, and in the casting of metal statues used for idols, lanterns, cannon, &c. A copper statue of Buddha (Jap. *Dai Butsu*) at Kamakura is nearly 50 ft. in height, and is a fine work of art. Their bronzes, which embody the national art, and express in metal their legendary lore and symbolism, have won admirers in every land, being sought after for their chaste proportions, exquisite beauty, excellence of mechanism, and fineness of metal. Their lacquering in wood excels that of all other nations. At the Vienna exhibition in 1873, not only their bronze and lacquer work, but their wood and stone carvings, mosaics, basket work, tortoise shell, inlaid and ivory work, fans, silk flowers, toys, cut crystal, and leather, were greatly admired and highly praised. The manufacture of glass is still in its infancy in Japan, and only the simplest articles are made, and these of inferior glass. They make a great variety of cotton goods; in crapes, camlets, brocade, and figured silk for girdles, they excel. Paper, which is applied to manifold uses, even for napkins and handkerchiefs, is made from the paper mulberry (*Broussonetia papyrifera*), and is noted for its silkiness, lustre, toughness, and softness. It is very abundant, and of all qualities. Paper shops are exceedingly numerous. Kioto, Tokio, and Ozaka are the chief seats of manufactures. Kioto is noted for its damasks, satins, camlets, crapes, silk fabrics of every sort, lacquered articles, screens, fans, paints, grindstones, porcelain, and earthenware. At Tokio nearly every kind of manufacture is carried on. The people show the greatest eagerness and aptitude for imitating all kinds of European manufactures. In nearly every house of the samurai class is seen a map or globe, thermometer, barometer, Yankee clock, or lamp. Most of the intelligent natives who can afford them wear watches. Telescopes, microscopes, knives, and spoons are made by the natives from European models, at a cheap rate. In all the cities and large towns shops filled with foreign articles are found, where looking glasses, clocks, watches, spoons, notions, boots and shoes, condensed milk, beer, colored engravings, fancy soap, canned fruit, pickles, brushes and combs, panes of glass, wine and brandy, rugs, carpets, underclothing, &c., are sold. All these things



are rapidly changing the manners, customs, and household habits of the Japanese people. Very good iron and brass cannon, shot and shell, breech- and muzzle-loading rifles, gun-powder, percussion caps, and many other articles of war material, are now made by unassisted native workmen.—The internal trade of Japan is brisk and constant. The roads are good and kept in excellent order, and hotels, warehouses, and stables for the accommodation of man, beast, and baggage are abundant, and their terms reasonable. Many of the merchants become rich, but there are not as yet five millionaires of any class in Japan. In the open ports there are probably a few score merchants who may each be worth \$50,000, but this is a large sum in Japan. Goods are conveyed on land by pack horses, oxen, and coolies. The principal carriage of merchandise is by water; for although the Japanese junks cannot make long sea voyages, they are well fitted to navigate the rivers, to coast from port to port, and to cross from island to island. The shores of the Japanese group afford great facilities for a coasting trade, from the abundance of harbors and shelters for vessels of small size, and these facilities are energetically used by the people, who keep afloat a vast number of vessels, from fishing boats to junks of 300 tons. At present the great bulk of the coasting trade is done by the steamers of the Pacific mail steamship company. Japanese trading companies also own steamers, which ply regularly between the large ports. Scores of small river and lake steamers, owned and manned by Japanese, now ply on the inland waters and seacoast. On Lake Biwa alone there are seven steamers. Commerce is comparatively free from tolls and duties, though the government seems to have a chronic tendency to meddle with the merchants, and privileged corporations help to fetter and restrict commerce. The inland trade is assisted by great fairs held at Kioto and other cities. Until the summer of 1859, for more than two centuries, the foreign commerce had been limited to the Dutch and Chinese at Nagasaki. The Dutch had a small factory at Deshima, on which 12 or 13 merchants lived, closely watched by the Japanese, and allowed very little liberty. Two ships were annually sent from Batavia, with cargoes consisting chiefly of sugar, ivory, bar iron, tinned iron, fine chintzes, broadcloths, shal-loons, cloves, tortoise shell, drugs, spectacles, looking glasses, watches, various herbs and roots, and Dutch medicines. The writer in his travels through Japan has found two or three popular Dutch medicines advertised in Roman letters in nearly all the large towns and cities. The words in use among the natives for glass, tinned iron, table, Sunday, electricity, laudanum, and many other things, are corruptions of the Dutch names for the same. The chief articles of export by the Dutch were copper, camphor, lacquer ware, porcelain, and rice.

In 1854 American diplomacy succeeded in removing the barriers against foreign commerce, and many ports have since been opened to foreign residence and trade. The articles most in demand by the Japanese are tissues of all kinds, cotton prints, calicoes, flannels, cotton and woollen yarn, knit goods, chintz, velvet, woollens, blankets, glass ware, mirrors, drugs, ivory, cheap clocks, watches, petroleum and lamps, flour, rod iron, machinery, sugar, boots and shoes, hats, wine, spirits and beer, zinc, sail cloth, soap, leather, and tea lead. The most profitable exports are rice, silk, tea, camphor, vegetable oil and tallow, wax, lacquered ware, porcelain, sulphur, silkworms' eggs, and a variety of sundries that find a market in China. The value of the imports into Japan during the year 1872 amounted to \$26,184,441: of exports, \$24,294,532; total value of exports and imports, \$50,482,973. The local trade, imports and exports, between the open ports of Japan during 1871, was to the value of \$4,436,539; for 1872 it was valued at \$4,263,232. The declared value of imports in 1873 was 29,000,000 yens, or dollars, and the declared value of the exports, \$21,000,000. The total amount of duties collected, including for exports, imports, rent of warehouse, entrance and clearance fees, fines and penalties, and miscellaneous, was \$1,735,000. The value of cotton manufactures imported into Japan in 1871 was \$8,011,478, and in 1872 \$10,065,155. Of woollen manufactures, the value in 1871 was \$2,056,789, and in 1872 \$6,335,014. The export of raw silk in 1871 was \$8,416,712 in 1872 \$7,355,623; silkworms' eggs in 1871 \$2,184,688, in 1872 \$1,963,159; tea in 1871 \$4,651,292, in 1872 \$5,445,438; rice in 1873 \$2,988,548; copper in 1873 \$1,353,545. In 1872 the shipping returned at all the open ports was: British, 31 mail steamers, 351 ships, tonnage 204,077; American, 293 mail steamers, 69 ships, tonnage 683,401; other nations, 118 ships, tonnage 73,024. On the first opening of the ports to foreign commerce, the chief obstacle to profitable trade was the peculiar ideas of the Japanese government relating to currency. Little trouble is now experienced on this score, as the mint at Ozaka turns out gold and silver coins of satisfactory weight and fineness, which are graded in value according to the decimal system.—In science, the Japanese have particularly cultivated medicine, astronomy, and mathematics. The European system of medicine is now followed by nearly all the doctors of Japan, and dissection is openly practised in the great cities, and secretly in the smaller by private individuals. A great many Dutch books on therapeutics, medicine, and surgery have been translated of late years and diligently studied. The native doctors are highly respected by the foreign practitioners, and while they are very successful with local diseases, they do not hesitate to attempt very difficult cases, with average good success. Among their many inventions are acupuncture

and moxa (Jap. *mogusa*, burning grass), both of which, though now generally superseded, were long practised in Europe, into which they had been introduced from Japan. The Japanese people are troubled with a disease which is not known in other countries, called *kakke* (leg humor), which baffles the skill of both native and foreign physicians. Its diagnosis is as yet very obscure. It is especially prevalent in Tokio, and the summer of 1873 was noted for the mortality caused there by this disease. It begins in the feet; the legs swell, the patient has great difficulty in walking, and has to remain quiet; the legs continue to swell, and after headache, palpitation of the heart, and excruciating pains in the small intestines, death ensues. Their so-called "remarkable medical discovery," the *dosha* powder, which Titsingh asserted could restore flexibility to a stiffened human corpse, and cure disease in the living body, refresh the spirits, &c., is and always was a pious fraud. It is made of common quartz sand, drawn from certain bubbling springs in the provinces of Kii and Hitachi, by priests of the Buddhist Shin Gon sect, with long prayers to Buddha to give it efficacy. With this a few grains of mica are mixed. It is not now believed in except by the lowest and most ignorant people. In chemistry, botany, and astronomy, the Japanese have gained considerable knowledge by means of translations from the Dutch and English. In the fine arts they have made but little progress. Their music is very disagreeable to European ears, though the people take a passionate delight in it. The Japanese gamut is very rude, and most of the music is in the minor key. They have a considerable body of printed music, among which is a collection of very ancient classical pieces performed on public occasions. The bands for the army and navy are now trained by European instructors, in European style. The use of the *samisen* or three-stringed banjo is always a part of female education. The *koto* and the *biva* are the principal other stringed instruments. They have a large variety of wind instruments, and several kinds of drums and cymbals. In the arts of design and painting they show great taste, but only a resident in the country itself can fully appreciate their delineations. There are several distinct styles or schools of drawing and painting, easily recognized by a connoisseur. The style used on fans, battle-boards, story books, broadsides, caricatures, &c., is most popular and pleases the vulgar eye. Another style is used on the *kakemono* or hanging pictures and scrolls seen in every house; and still another on folding screens and pictorial scroll books. In this last style the coloring is very rich, and the details are minutely portrayed. In the second, the salient points are emphasized, but the pictures, while very suggestive, leave much to the imagination. The first named style combines the qualities of the second and third. Cultivated Japanese do not like foreign pictures, on ac-

count of their intense realism. Their delineations of birds, flowers, and fruits are exquisitely beautiful. Not only does their lacquered, porcelain, and inlaid work of all kinds show this, but the walls of the palaces in Kioto and Tokio, and the tombs at Nikko and Shiba, are renowned for the remarkable beauty and correctness of their carvings and paintings. They are not very successful in portraying the human form. They know little of the higher plastic art, and have scarcely a conception of that ideal human form which is such a passion with Europeans. Their best sculptured representations of sacred animals are fair specimens of clever chisel work rather than of ideals. Printers and booksellers are numerous, and keep the market well supplied with cheap books, many of them profusely illustrated with woodcuts. They print only on one side of the paper, using cut wooden blocks for type. Kioto was formerly the chief seat of the book trade, and was eminently the centre of literature, the fine arts, and religion. Tokio is now fast robbing it of all its glories, and becoming the manufacturing, fine-art, literary, and religious, as well as the political capital of the empire. All the people are fond of reading, and circulating libraries, carried on men's backs from house to house, are very common. Their dramas, of which the people are passionately fond, are nearly always founded on national history or tradition, or the exploits, lives, or adventures of Japanese heroes and gods. Many of them are designed to enforce and illustrate moral precepts. Their general tendency is elevating, patriotic, and decorous, though some of them are strongly tainted with the old national passion for revenge, and have horrible exhibitions of cruel punishments. The actor is most esteemed who can most frequently change parts in the same play. The female parts are usually taken by men or boys, though women are now becoming actresses. The best actors receive \$1,000 a season, which is a high salary in Japan. The theatrical stage is a turn-table, which can be turned and made to present a new scene in a moment. The scenes are perfectly true to Japanese life and fact, the actual scene of the play being always laid in Japan. The theatres as yet are very rude structures. The playing begins in the morning and lasts all day, the spectators bringing their food with them. The actors are looked upon as a very low class.—The two great religions of Japan are Shinto and Buppo, or Shintoism and Buddhism. Shinto is supposed to be the ancient religion of Japan. Buddhism was brought from Corea. The word *shinto* is Chinese. The Japanese name for the same is *kami no michi*, "the way of the gods." *Shin* means god; *to*, way, doctrine, cult. The essence of Shinto is ancestral worship and sacrifice to departed heroes. Mori says: "The Shintos believe in a past life, and they live in fear or reverence of the spirits of the dead." The number of Shinto deities is enormous, and variously estimated, but

the reputed divine ancestress of the mikado Ten Sho Dai Jin, or Ama Terasu o Migami, "great goddess of the celestial effulgence," or "the heavenly illuminating spirit," is the chief and supreme. The first name is Chinese, the second pure Japanese. The Shintoists have very obscure notions about the immortality of the soul, a supreme creator, or a future state of rewards and punishments. Their chief end, in opposition to the Buddhists, is happiness in this life. In its precepts Shinto lays great stress upon keeping the body pure with water and the heart by prayer to the *kami* or gods. Pilgrimages to sacred places and attendance upon the religious festivals are enjoined as duties. The Mecca of the Shintoists is the collection of temples in Ise, about 200 m. S. W. of Tokio, which are visited by the mikado, the recognized spiritual head of the Shinto system, hence called *tenno*, which means "heavenly king." The eating of flesh was formerly an abomination, but modern civilization, a knowledge of physiology, and experience of the taste of well cooked steaks, have overcome this prejudice, and the most devoted Shintoists now eat beef habitually. The great end and aim of Shintoism is obedience to the edicts of the government, as shown in the sermons of the lecturers and priests. The three great commandments, issued by the department of religion in 1872, intended to be the basis of a reformed Shinto and national religion, are as follows: "1. Thou shalt honor the gods and love thy country. 2. Thou shalt clearly understand the principles of heaven and the duty of man. 3. Thou shalt revere the emperor as thy sovereign, and obey the will of his court." In its higher forms Shinto is a cultured and intellectual deism; in its lower forms it consists in blind obedience to governmental and priestly dictates. The Shinto temples are called *miyas*, and are made of the pure wood called *hi no ki*, "sun wood." In a perfectly pure Shinto temple there is neither altar, image, nor picture. A mirror, the emblem of self-examination, and strips of white paper, symbols of purity of life, are always seen, but nothing else. Around or outside of the temple often hang votive tablets, pictures of horses and of ancient heroes, a stone lavatory, often a sculptured cow, or "two heavenly dogs." The sun is worshipped under the name of O Tenta Sama, "lord of the heavenly path;" and the moon under the title of O Tsuki Sama. The Shinto belief supposes the existence of an infinite number of spirits who exercise an influence over the affairs of the world, who are to be propitiated by prayers and the observance of certain rules of conduct, cleanliness of person, and purity and cheerfulness of heart. The inferior spirits, who are very numerous, are chiefly heroes canonized for their worthy deeds or illustrious qualities. The most prominent and popular of these minor deities is Hachiman, the god of war, who is an apotheosis of the 16th emperor of Japan. The worship paid to the spirits resi-

ding in the *miyas* is of a very simple character. The devotee approaches under the sacred gateways until within a short distance of the door. He then stops, flings a few coins in the box or on the floor, folds his hands in a posture of reverence, mutters his prayers, and departs. The Shinto priests are called *kannushi*, spiritual teachers. They form a high class of society, but have no ordination or special privileges. They marry and have families. They wear a peculiar costume when officiating. It is highly probable that Shinto never became a definite system of religion until after the introduction of Buddhism. Many of its legends and even titles are Chinese. Buddhism accepted its deities and caused them to be worshipped as Buddhist deities; and the two religions became gradually so mixed together, to the advantage of Buddhism and the loss of Shinto, that the existence of the latter has been little more than nominal during the past five or six centuries. On the accession of the mikado to his ancient supreme power, in 1868, a "purification" was begun, and all the Shinto temples throughout the empire were purged of Buddhist symbols, images, writings, &c.; the use of Chinese religious names, titles, and terms was discouraged, and that of pure Japanese encouraged, in the language of religion. But the attempts made by the government to proselyte all the people to the Shinto faith and to abolish Buddhism failed, and Buddhism is still, as it has been for more than ten centuries, the popular religion of Japan. It is said to have been introduced from Corea in the first century of the Christian era, but was not propagated extensively until the year 552, when the king of Hakkusai, a district of Corea, sent an embassy with a present of an image of Shaka (Buddha) and a set of Buddhist books of the sacred canon. Though at first violently opposed, it gradually made converts, until the son of the emperor, afterward regent of the empire, became a convert, after which the success of Buddhism in Japan was assured. Bands of zealous priests continued to pour into the empire, and, not content with their success in southern Japan, accompanied or followed in the wake of the conquering armies northward, who drove the aboriginal Ainos before them, or tranquillized and governed them. Long before the introduction of Christianity Buddhism was thoroughly established wherever the Japanese language was spoken, even in the Liu Kiu islands. In 1869 there were 168,000 Buddhist priests and 460,244 temples and monasteries. There were originally six sects which entered Japan. Now there are seven large and "orthodox" sects, with 30 subdivisions or offshoots, and 13 "irregular," "eclectic," or very small sects. Probably in no other country has there been a richer development of Buddhism than in Japan. Here the latest phases and developments of the wonderful doctrines of the Indian sage are found. Its effects on the civilization of Japan have been

as marked as those of Mohammedanism upon Turkey, or Christianity upon England. The chief deity in the Buddhist pantheon in Japan is Amida (Sanskrit Amitabha), and the essential part of the worship offered to Amida is the repetition of the prayer *Namu Amida Butsu*, "Save us, eternal Buddha." Next to the worship of Amida is that of Kuanon, the goddess of mercy. She is always addressed by those who are in sorrow or affliction of any kind. The most astonishing answers to prayers made to her are on record, and form the subject of a series of remarkable tableaux of life-size figures at the great temple of Asakusa in Tokio. There are 88 celebrated shrines to her honor, and pious pilgrims often make the tour of the empire, visiting and praying at every one of them. Yemma is the god of hell and the chief judge of the infernal regions. Jizo are six deities whose images are placed along the highways of the empire, and who are besought by those who suffer from the consequences of sin and lust. The *Go-hiaku-rakan*, or 500 original disciples of Shaka, are found in many temples devoted to their honor. Japan is a country of wayside shrines and images, and of temples without number. Some of the great temples in Kioto are enormous structures, capable of seating 5,000 persons, and some contain as many as 3,000 life-sized gilt images of sages, saints, and deities. Monasteries and nunneries are numerous, and were formerly well filled; but Buddhism has been so weakened by governmental fines and confiscations, and by the decay of belief incident to the study of foreign science, that it is slowly but surely decaying, and the number of its priests and nuns has greatly decreased. The Japanese Buddhist priests are called *bozu*, corrupted into the English word bonze, and are often very learned men. Sanskrit is their sacred language, but is little studied in Japan. A large body of Japanese, especially the higher classes, reject idol worship entirely, and found their rule of life on merely philosophical and abstract notions. They are followers of Confucius, and are called Ju-sha, or the school of philosophers. There is very little hostility between the various forms of religion in Japan, and many profess them all. The Ju-sha have no shrine or ritual, but they pay supreme homage to Confucius, to whose honor there is a temple built in Tokio, but they cannot be said to worship him. They religiously venerate their own ancestors. Indeed, the veneration, if not worship, of ancestors is common to all the religions of Japan. The Yamabushi sect of mountebank priests, once numerous, have been suppressed by the government since 1871. The authorities of the state are indifferent to mere doctrines, so long as the public peace is not disturbed. One reason why the several religions are tolerated by the government, and by each other, is because the divinity of the mikado (whom the officials call tenno, or heavenly king) is dogmatically taught and po-

litically insisted upon, and all people are commanded to obey and reverence him, as the descendant, representative, and vicegerent of the gods. The cause alleged before the foreign ministers of the persecution and punishment of the Christians of Urakami in 1868 and 1869 was, that they acknowledged Christ as the Lord of heaven, and that such a doctrine was a subversion of the dogma of the mikado's divinity, on which the government of Japan rests. In addition to those which have been described, the worship of Inari, the deified introducer of rice into Japan, and the patron of foxes, is common throughout the empire. Inari shrines and images of foxes, which are worshipped, are numerous everywhere, often alone, but usually attached to Shinto temples. Many superstitions in regard to the fox are popularly held. He deceives people, injures them, transforms himself into a beautiful woman, and lures men away by bewitching them or promising them sensual pleasure. He is also believed to enter the hearts of people and make them wicked and devilish. Sometimes he acts benevolently. Hence the people propitiate him, and worship Inari, who rules over the foxes, and whom they obey. The worship of the phallus, which must once have been very prevalent, judging from the immense number of phallic symbols and even shrines until lately seen in Japan, has now faded almost entirely away in the parts visited by foreigners, though it still lingers in the rural districts. The public sale of the phallic emblems, so very common in Yedo, Ozaka, Kioto, and other cities, prior to 1868, has been prohibited and entirely suppressed by the government.—The government of Japan consists of: 1, the emperor; 2, the *dai jo kuan* or supreme executive, consisting of the *dai jo dai jin*, or premier, and the *u dai jin* and *su dai jin*, right and left junior prime ministers; 3, the *sa in*, or left chamber of the council of state, consisting of seven *sangi* or high counsellors, and the *u in* or right chamber of the council of state, consisting of all the ministers and vice ministers who are heads of departments, nine in number. There are also the prefectures of the *fu* or imperial cities, the *ken* or districts, formerly provinces, and the emigration department having control of the Hokkaido, or territory north of the main island, which are under the *dai jo kuan*, or supreme government of Japan. The departments are as follows: 1, *guai mu sho*, foreign office; 2, *o kura sho*, treasury department, having nine bureaus or subdivisions; 3, *riku gun sho*, war department, with four bureaus; 4, *kai gun sho*, navy department, with ten bureaus; 5, *mom bu sho*, education department; 6, *ko bu sho*, public works department, with nine bureaus; 7, *kio bu sho*, department of religion; 8, *shi ho sho*, department of justice, two bureaus; 9, *ku nai sho*, department of the imperial household, three bureaus. At the present time (1874) Japan has legations and ministers resident in the United States,

England, France, Russia, Austria, Italy, and Prussia, and consuls in China and several other countries. It has a foreign debt of over \$30,000,000, a system of national banks based upon that of the national banks of the United States, custom houses with American inspectors, and paper money consisting of both government and national bank notes. There is a mint at Ozaka, built and equipped in modern style under English supervision. It coined in the year ending July 31, 1873, \$25,162,614, and in 1872 \$14,488,981 in gold, and from 1871 to 1873 \$10,213,598 in silver. All the old gold and silver coinage of the empire has been called in, and the new round milled coins substituted. The new copper coinage appeared in 1874. The money system of the Japanese is decimal, the units being the *yen*, equal to the American dollar, and the *sen*, equal to the cent. The national postal service is under the control of the treasury department, and is based mainly on the American system, and Japan now has postal treaties with the chief countries of the world. The national revenue in 1872 was \$65,831,362, of which \$59,363,625 was from land taxes. The disbursements for the same year were \$62,371,574. The customs duties amounted to \$1,191,171. The expenses for feudal commutations amounted to nearly \$24,000,000. The army is organized on the French model. The country is divided into six military districts, in which are camps and garrisons as follows: Tokio, 7,140; Sendai, 4,460; Nagoya, 4,260; Ozaka, 6,700; Hiroshima, 4,340; Kumamoto, 4,780; total, 31,680 soldiers, constituting the army on a peace footing. Of these troops, 8 regiments of infantry (6,456 men), 1 squadron of cavalry (96 men), and 2 regiments of artillery (1,444 men) constitute the *konoye*, or imperial guard. The main army is divided into 14 regiments of infantry, 3 regiments of cavalry, 18 companies of artillery, and 10 companies of engineers. The estimates for the army on a war footing are not yet (May, 1874) made, but 90,000 is usually regarded as the number of soldiers that could easily be sent into the field in an emergency. The navy is organized on the English model, and consists of 2 ironclads, 10 men-of-war, 8 gunboats, and 4 transports. On these are 1,514 sailors and officers; 298 boys are on school ships, training to be officers, and there are nine companies of marines. The education department has in Tokio a medical college with 8 German professors and 300 students. The imperial university, consisting of the three departments English, French, and German, has 25 foreign professors and 600 students. The national scheme of education provides for 8 universities, 32 high schools or academies, 256 grammar schools, and 55,000 primary schools. Foreign languages and learning are to be pursued only in the two higher schools, but the method of study in all is to be closely modelled on the foreign system. In 1874 this scheme was about one sixth fulfilled. Chinese learning is neg-

lected, and foreign science and languages take precedence. An immense number of foreign books, many of them of a high character, have been translated. The department of religion takes charge of the Shinto shrines, and propagates the dogmas of Shinto and the three commands of the government, the chief of which is, "Thou shalt revere the mikado, and obey the will of his court." There is a railway 14 m. long from Yokohama to Tokio, completed in October, 1872; the average traffic receipts per week in 1874 were nearly \$10,000. The road between Kobe and Ozaka was finished May 11, 1874. The route for a trunk line from Kioto to Tokio, and from Ozaka, *via* Kioto, to Tsuruga in Echizen, has been surveyed. A system of 18 lighthouses of the finest kind, with buoys, beacons, &c., under the care of trained Europeans, with native assistants, and costing over \$1,000,000, has robbed the coast of Japan of its former terrors to mariners. There is a telegraph line from Nagasaki to Tokio, with branches, and the capital of Japan communicates directly with San Francisco, *via* Asia and Europe. The railway, lighthouse, telegraph, and mining bureaus follow the English system, and have British assistants. In 1872 there were 224 foreigners employed in the service of the government, on salaries ranging from \$480 to \$16,000, and one at \$36,000 per annum. Of these, 119 were English, 50 French, and 26 American. In 1874 Americans held the highest offices given to foreigners, in the treasury, emigration, education, and state departments. While American and British citizens hold the paramount foreign influence in Japan, they are all, except one American in the state department, who holds a commission as officer of the second rank, and one English officer, in the strictest sense of the word employees, and have neither title, rank, nor commission, but render service by contract. The emigration department has engaged a staff of American officials, who have surveyed and explored a great part of Yezo, built roads, and introduced scientific agriculture, American stock, &c. In 1874 there were about 2,500 foreign residents in Japan, exclusive of soldiers and sailors, of whom 800 were in Tokio. Yokohama, once a wretched fishing village, is now a splendid city, with most of the institutions of civilized cities in Europe, having a foreign population of about 1,500, and a native population of 50,000. Kobe is a similar instance of rapid growth and transformation. The British residents in Japan are mainly commercial and diplomatic, the Americans mostly professional. In May, 1874, there were 31 male and 10 female American Protestants, 12 British, 3 Russian, and about 30 French Roman Catholic missionaries. Nearly the whole of the New Testament has been translated into Japanese, and several native Christian churches have been established. Since 1864 Japanese have been visiting foreign countries, and while several thousand have passed through Europe or America, about 400 have

ed, chiefly in England and the United States as students, during periods varying from six years. Among the reforms carried out by the mikado and his government are the abolition of the old life of seclusion, and the reform of the dress and public manners of European sovereigns; the elevation of the Eta or pariah class to citizenship; the abolition of the feudal system; the engagement of a native press; the establishment of a national post; the reorganization of the army and navy on European models; the abolition of the sale of obscene pictures and symbols; the adoption of foreign dress by Japanese officials; the abolition of the custom of wearing two swords; reform in the legal laws; the reformation of the penal system; the adoption of railways, telegraphs, steamships, steam lines of transports, arsenals, dockyards; a civil service of foreign emissaries; the abolition of the lunar and adoption of the solar calendar; the establishment of consulates in foreign countries; the colonization of Yezo; the annexation of the Riu Kiu and Choo islands; and the planning of an international system on the foreign model, in which science has a high place.—The history of Japan, like that of other ancient nations, has a mythological period. According to the holy books of Shinto: "In the beginning the world had no form, but was like unto a clear portion (the white) became earth, and the heavy portion (the yolk) became heaven, and became a god, or *kami*; he was the father of a line of spiritual beings, who pervaded the universe as it then was for millions of years, ending in a god and goddess Izanagi and Izanami (evidently the equivalents for the *ying* and *yang*, the male and female principles that pervade all creation). From their union sprang the islands of Japan, the mountains, seas, and other natural objects of the earth. Another legend is that Izanagi, taking his heavenly jewelled spear, stirred up the drops which fell from the point of the spear, and became an island, upon which the two gods descended and took up their abode. Subsequently a daughter was born whose body was so bright that she ascended to heaven and became the sun, and was called Ten Sho Dai Jin. Another daughter was born, the moon, O Tsuki Sama. These divinities are of no further importance in history, but are serving to make a line of ancestors for the reigning family. At the time when the legends of tradition, the genealogy merged with oral men, the country was found to be a barbarous land, and there is no attempt to show where these people came, though described as uncivilized, and living in the open fields. What seem to be the authentic annals of Japan begin about 660 B. C., though there is no native documentary proof of this, but the Japanese have no writings that antedate the 7th century. At the time when Jimmu

Tenno, who is called the first emperor, set out upon his career, the people of the country are said to have been hairy and uncivilized, living under the rule of a head man in each village. The Japanese have to this day a great contempt for the people of Yezo, who may be thus described, and they allege that similar tribes occupied the whole of the islands, and that they were gradually driven back by the armies of Jimmu. It is more likely that they were conquered and gradually amalgamated with their conquerors, by the intermarriage of these with native females, and that in this way, and by the effects of the warm climate of the south, they lost that hirsute appearance which is so characteristic of the people of Yezo, who are called Ainos. There are two strongly marked varieties of feature in Japan, which are strikingly portrayed in their own pictures; these are the broad flat face of the lower classes, and the high nose and oval face of the higher. The difference is so marked as to be some argument in favor of a previous mixing of two different races, the one of which had extended southward from the Kurile islands and Siberia, hairy and broad-featured, while the other had originated from the south, with Indian features and smooth skins. Jimmu, setting out from Hiuga, on the east side of the island of Kiushiu, gradually overran that island, the adjoining one of Shikoku, and the west half of the main island, as far as Mino. His capital was a place near Kioto, which was finally selected after several changes. He began the civilization of the people, and established laws and a settled government. For many centuries his posterity reigned on the throne he had founded, bearing the title of mikado, and claiming to rule by divine right and inheritance. They exercised the most absolute power. Women were not excluded from the succession, and in ancient Japanese history there were many famous empresses. Jingo Kogo, the empress regent, conquered Corea and gave birth to a son, who succeeded her. At his death he was deified, and is now the Japanese god of war. A social revolution in Japan followed the conquest of Corea. Learned Coreans brought over to Japan the works of Confucius and other Chinese books, and the language and literature of China became the study of the higher classes. In A. D. 552 a Corean prince presented the emperor with Buddhist idols and books. The doctrines of Buddhism won their way in spite of all opposition. On the accession to the throne of the empress Suiko, the first female sovereign, in 593, full toleration was declared to the Buddhist faith. Written codes and official grades were now formed; the empire was resurveyed, and the provincial boundaries were fixed more exactly. The invention of native syllabaries or alphabets (the *hiragana*, the script or running hand, and *katakana*, or square letters) to facilitate the reading, understanding, and pronunciation of Chinese, was the work of the famous priest Kobo,

who died in 835. The abdication of the emperors after short reigns began at this time or a little earlier to be a regular custom; after abdication they would become priests. Among other notable events in Japan, Yezo was invaded and completely subdued about the year 658, the art of brewing saké was invented in 693, and gold was discovered in 749, after which money was coined and came into general use. In 788 a people from the west, supposed to be Mongols, attempted the invasion of Japan, but were driven away, and their army and fleets nearly annihilated by the valor of the natives and the fury of the elements. For three or four centuries the history of the empire may be written in the successive rise to power of individuals of the great families of the nobles, whose names, such as Fujiwara, Taira, Minamoto, and Tachibana, fill the pages of the Japanese annals, and are venerated at the present day. The imperial power began to decay, and the throne finally became the toy of leaders and the prey of contending factions. The real origin of the decline of imperial power is found in the basis of the system of succession. The looseness of the marriage tie produced weakness in the social structure and in the government. The mikado was allowed 12 concubines and one wife, so as to insure offspring; but no law existed defining the constitution of a legal heirship, or the rights of an heir to the throne. The succession did not depend upon birth, but wholly upon the arbitrary will of the sovereign. Every member of the imperial family was, under these circumstances, left free to promote his ambitious designs upon the throne as best he could. The natural consequences of such a rude system of inheritance are obvious, and the pages of Japanese history for nearly four centuries reflect the story of turbulence, intrigue, and bloody strife, as the different clans in turn got possession of the throne; and at one time there were two emperors. From the civil custody of the courtiers, the throne finally became the bauble of the military class, like the throne of imperial Rome. Meanwhile the vassal princes took advantage of the weakness of the imperial government to strengthen their own power, adding to the national confusion. To remedy these evils, the court of the mikado created the office of *shogun*, or governor generalissimo, and appointed Yoritomo to it. This man, one of the most renowned heroes in Japanese history, was the son of a court noble of the Minamoto family by a peasant woman. After quelling the turbulence of the great vassals, and restoring the authority of the throne, he gradually concentrated in his own hands the real power of the government, without however depriving the mikado of his nominal rank, dignity, and religious supremacy. The office of shogun was made hereditary in the family of Yoritomo, but did not finally remain so. Abnegating official titles and rank, he nevertheless held the fulness of sovereignty. He

chose Kamakura, about 35 m. from Yedo, for his capital, and made the court of the first shogunate one of great magnificence and dignity. From this date, 1195, the shogun was regarded as the lord of the land, and the influence and power of the emperor became nominal. The Mongols having invaded China in 1260, and conquered the greater part of it, their leader Kublai Khan sent envoys to Japan in 1268, and again in 1271 and 1273. On their arrival at Kamakura the first envoys were insulted, and those who came later were arrested and put to death. In 1274 an expedition was sent by the Mongol conqueror, which was defeated. In 1281 an immense fleet and army were despatched to Japan, which when off the coast of Chikuzen, were destroyed in a storm and by Japanese valor. From that time Japan has not been molested by invaders. From 1331 to 1392 occurred the civil wars between the factions of the northern emperor and the southern emperor, both of whom claimed the throne. The period from 1334 to 1573 is known as the "epoch of war," and the country was ruled by 13 shoguns of the Ashikaga family. About this time there rose into notice three of the greatest names that adorn the pages of Japanese history; they are Nobunaga, Hideyoshi, and Iyeyasu. Nobunaga conceived the idea of bringing the whole empire under his sway; and reducing first the weak clans, he gradually overawed the great clans, but was killed by a traitor before he finished his work. Hideyoshi hastened to complete it, and succeeded in bringing the whole empire under his absolute rule. Nobunaga hated the Buddhist priesthood, and persecuted them with sword and fire. Hideyoshi likewise hated them, and both pretended to welcome the Jesuit missionaries, in order to offset them against the Buddhists and diminish their power. Hideyoshi is usually called by the Jesuit father Faxiba (correctly Hashiba), a name chosen by himself in a trivial mood, and made up of the first and last halves of two different men's names. He is also called Taiko Sama by foreigners, but this was merely the title of his office, and there have been many taikos. Hideyoshi was not only a great warrior, but a consummate statesman and legislator, and the "laws of Taiko" have been venerated for centuries. Aspiring to conquer the vast empire of China, he sent by the way of Corea in 1592 an army 160,000 strong. Corea submitted, being entirely unprepared, but further advance was stopped by the death of Hideyoshi, and the expedition returned. The country was now distracted by two parties, one led by the adherents of the infant son of Hideyoshi, the other by Tokugawa Iyeyasu. The latter triumphed, and founded the shogunate of Tokugawa, the family which ruled over Japan from 1603 till 1867, during which period the country enjoyed profound peace. He made Yedo, then a small town, his capital, and in a few years it became a great city. Iyeyasu is regarded as

the greatest character in Japanese history. His system of government was that under which Japan continued during the period of her seclusion from the rest of the world, which has been so well described by Kämpfer, Titsingh, and Klapproth, and which so long excited the wonder of other nations. It was a normal outgrowth of peculiar circumstances. Having no foreign enemies, the feudal condition of the country necessitated a dual government and two capitals: a divine emperor, the fountain of honors and titles, to be venerated; and a strong hand of power, the shogun, with castles, wealth, and armies to be feared. The one dwelt amid a semi-sacred nobility and a host of learned priests, in a quiet capital filled with temples and colleges; and the other, from his moated castle ruling the turbulent vassals and enforcing military authority in every part of the land, resided in a bustling capital filled with wealth, luxury, and all the circumstance of actual power. Though the shogun was the *de facto* ruler of Japan, the mikado was by no means the empty shadow that Kämpfer and his copyists make him to be. Title and rank in Japan have a significance even greater than in Europe, and all high ranks and titles had to be obtained from the mikado. He was the true sovereign of Japan, and the shogun was a usurper, and in no sense of the word a king or emperor. He was but a military governor, a commander-in-chief. Properly he was a senior baron, *primus inter pares*. His family was but a clan like the others, which had obtained its supremacy by the genius and labors of Ieyasu, and which held it by force and superior resources. Probably no greater diplomatic mistake was ever made in the history of the world than that of the foreign nations who made treaties with Japan, and accepted the seal of the shogun as surety, without having them ratified by the mikado. In fact, the foreign nations were content to make treaties with the lieutenant, or the mayor of the palace, through their ignorance of the facts, while the emperor's consent was actually withheld. The term *taikun* (or tycoon) means "great sovereign," and was an absurd title, to which the shogun had no right whatever, and which was invented to deceive foreigners. When the foreign ministers in Japan found out the true state of affairs, and that the mikado was and had always been *de jure* the true sovereign, they insisted upon and obtained his ratification of the treaties. The assumption of this title by the shogun helped to bring on the civil war of 1866-'9 which reduced his power to that of a daimio, and restored the emperor to his ancient power and rights. There never were two emperors in Japan, and the loose statements about a "secular" and an "ecclesiastical" emperor originated in deception.—The first European known to have written of Japan is Marco Polo, the Venetian traveller, who visited China, and in his narrative speaks of Zipangu, a modification of the Chinese name.

He gave such glowing accounts of the people and the wealth of the land, that Columbus seems evidently to have had the quest of that country in mind when he sailed westward, and on first landing in the Bahamas believed himself to be in Zipangu. After the circumnavigation of Africa by Vasco da Gama in 1497, the Portuguese rapidly extended their discoveries and conquests in southern Asia. In 1542 three Portuguese sailors arrived at Taneshima, and "breathed into the Japanese atmosphere the first breath of Christianity." About three years later a Portuguese adventurer, Fernam Mendez Pinto (whose name for a long time was a synonyme for liar, but whose veracity has been reestablished by modern criticism), while cruising with some companions of his own nation in the vessel of a Chinese pirate, was driven by foul weather into a harbor in one of the smaller Japan islands. He was well received, and carried back to the Portuguese settlements in China such reports of the riches and magnificence of Japan, that great numbers of traders and adventurers flocked thither, and an active commerce sprang up. Missionaries speedily followed the merchants, and in 1549 Japan was visited by the celebrated "apostle of the Indies," St. Francis Xavier. Both merchants and missionaries were favorably received, and while the one class found a ready and most profitable market for their goods, the other rapidly converted vast numbers of the natives to Christianity. Three of the most powerful nobles, the princes of Bungo, Harima, and Omura, were among the converts. In 1582 the Japanese Christians sent an embassy with letters and presents to Rome to do honor to the pope, and assure him of their submission to the church. In the two years which followed their return (1591-'2), it is said that 12,000 Japanese were converted and baptized. Tempted by the success of the Portuguese, the Dutch East India company in 1598 despatched five merchant vessels to Japan, one of which reached it in 1600. In 1609 other Dutch ships arrived, and were well received by the Japanese, who conceded to them a port on the island of Hirado (called by them Firando) for a factory or settlement, with considerable privileges. Before the arrival of the Dutch, who were then at war with Portugal, the Japanese government had become distrustful of the Portuguese, whose astonishing success made them haughty and disdainful of the feelings and prejudices of the natives. The effects of the missionaries' labors had scarcely been perceived during the anarchy into which the country was plunged, and Nobunaga had utilized the enthusiastic energy of the new converts in the suppression of their common enemy, the Buddhist priesthood. His successor Hideyoshi found the native Christians disobedient and unyielding under his rude and arbitrary orders. He is said to have asked a subject of the double kingdom of Spain and Portugal how his king had managed to possess



himself of half the world. The Spaniard's reply, "He sends priests to win the people; his troops are then sent to join the native Christians, and the conquest is easy," made a deep impression upon Hideyoshi. The vicious habits and inconsistent conduct of the Portuguese Christians, mostly sailors and traders, the wild and offensive behavior of the converts toward the sacred temples of the Shinto deities and of the popular religion of Buddha, and the performance of pretended miracles by the missionaries, added to his political jealousy, excited the displeasure of Hideyoshi, who issued an edict for the banishment of the missionaries. The edict was renewed by his successor in 1596, and in 1597 23 priests were put to death in one day in Nagasaki. The Christians on their part took no measures to pacify the government, but defied it and began to overthrow idols and pull down heathen temples. This led to dreadful persecutions in 1612 and 1614, when many of the Japanese converts were put to death, their churches and schools were destroyed, and their faith was declared infamous and rebellious. The Portuguese traders were no longer allowed free access to the country, but were confined to the island of Deshima, at Nagasaki. In 1622 a frightful massacre of Christians took place near Nagasaki, and horrible tortures, endured with heroic constancy, were inflicted on multitudes in the vain effort to make them recant. In 1637 it was discovered by the Japanese government that the native Christians, driven to despair by their persecution, had entered into a conspiracy with the Portuguese to overthrow the imperial throne. The persecutions were renewed with increased rigor. Edicts were issued banishing the Portuguese for ever from Japan, and prohibiting any Japanese or Japanese ship or boat from leaving the country, under the severest penalties. By the close of 1639 the Portuguese were entirely expelled, and their trade was transferred to the Dutch, who, as enemies to the Portuguese and to the Roman Catholic faith, were not involved by the Japanese in their condemnation. In 1640 the oppressed Christians rose in open rebellion in the island of Amakusa, crossed over to the mainland, seized the castle of Shimabara, and made a long and gallant stand against the shogun's army. The Christians were at length subdued by the superior military skill of their opponents, who brought to their aid artillery, which the Dutch lent them. The Christian stronghold was finally carried by storm, and all within its walls, to the number of 31,000, were put to the sword. In the next year the Dutch were ordered to quit their factory at Hirado, and take up their residence under very strict inspection on the island of Deshima. There they remained for more than two centuries in undisturbed monopoly of the entire European trade of Japan. The occasional efforts of the Russians and English to obtain intercourse with the secluded empire were resolutely repulsed, and led in one case to the im-

prisonment for two years in Japan of the Russian Capt. Golovnin and several of his companions. During all this time the governmental system inaugurated by Iyeyasu, and perfected by his grandson Iyemitsu, worked smoothly and gave the country peace and prosperity. Under this dual system, the emperor, called the mikado (illustrious gate, or sublime porte), lived in Kioto, surrounded by the *kyōgi* or imperial nobles related to him. He was the centre and fountain of titles, honor, and power. The shogun never aspired to be mikado, but from his capital Yedo ruled the country as lieutenant of the emperor. The word *shogun* means commander-in-chief, and when the "barbarians" (foreigners) entered Japan, after Com. Perry's treaty, the mikado commanded the shogun to expel them. The foolish stories told about the mikado, who was also called *dairi*, by Kämpfer and others, were mainly the superstitious beliefs of the vulgar lower classes, though all Japanese believed him to be of divine descent. The daimios, or territorial nobles, resided in Yedo, and were divided into four classes: 1, the *kokushū*, lords of provinces, princes; 2, the *kamon*, family doors, *i. e.*, relatives of the shogun's family; 3, the *tozama*, landed noblemen descended from those who assisted Iyeyasu; 4, the *fudai*, the vassals of original retainers of Iyeyasu. In 1865 there were 21 *kokushū*, 10 *kamon*, 80 *tozama*, and about 200 *fudai*. To be a daimio ("great name"), one must belong to one of these four classes, and have a revenue of not less than 58,000 bushels of rice. The annual revenue of the richest daimio was more than 5,400,000 bushels of rice. The shogun's revenue was over 40,000,000 bushels. Only the *fudai* daimios were eligible to office, or could take part in official business; and their power over the large daimios thus grew to be almost absolute. The source of the *de facto* power in Japan until 1868 lay in the two councils of state in Yedo, the members of which were called respectively *tsūji yori* and *waka doshi yori*, senior senators or elders and younger senators. The daimios were allowed to visit their palaces only at certain periods, and never permitted to take their wives and children out of the capital, they being kept as hostages. The daimios were always closely watched by the councils of state, by means of spies and informers, and were always kept poor by heavy contributions levied upon them, and by their luxurious habits fostered by the system under which they lived. They were so harassed by surveillance and restraint that they generally sought relief in abdication of their troublesome dignities as soon as they had sons of proper age to succeed them. To prevent opportunity for conspiracy, they were kept in constant motion, and the great princes rarely met alone with each other. A most cunningly devised and rigidly executed system of espionage held every one in dread and suspicion, from the most powerful daimio

meanest retainer. The ignoble quality of the nation became to a large extent a nationalistic, which still clings to Japanese

Every Japanese head of a family was responsible for the conduct of his children, servants, and guests. The whole nation was divided into groups of five family members of which was responsible for the conduct of the others. No one of the people could change his residence without obtaining a certificate of good conduct from his neighbors he was about to leave. One of the lower classes must also be allowed to reside at some temple, and have a wooden tablet or card officially certifying his name, rank, residence, and temple. The result of this organization, which in a great measure has reduced the crimes, is that a criminal has almost no chance of escape, and robberies and other heinous crimes are reduced to a minimum. The Japanese were formerly divided into eight classes: 1, the *kuge*, or Kioto nobility; 2, the court nobility; 3, the *hatamoto*, or warrior class, including the military literati; 4, the general name of *samurai*; 5, inferior officials, physicians, &c.; 6, farmers and untitled landholders; 7, artisans, merchants; 8, actors, beggars, &c. These were the *eta*, or tanners, skinners, and all workers in leather, who were the lowest of Japan, and were obliged to live in separate from the towns or villages; they were never allowed to touch any citizen, and were executed and bury criminals. No samurai could be prosecuted or punished for killing a commoner, or would any help be offered to a drowning man, or a drowning *eta*. By a decree of the present emperor, published in 1871, all the social distinctions of these people were removed, and they are now citizens of the empire. Prostitutes and brothel-keepers were considered to be on the same social level as beggars. The upper classes had the privilege of wearing swords, the others but one. About nine-tenths of the population of Japan are included in the four lower classes. The chief result of the recent changes in the government of Japan, and the social revolution of the whole people, are, first, the reverence for the imperial throne and the sovereign authority of the mikado; second, the influence of western civilization; and, third, the influence of the United States government. In 1852 the United States government, in response to complaints made to it that American sailors wrecked on the coast of Japan had been harshly treated by the authorities of that country, despatched an expedition under the command of Commodore M. C. Perry, who was instructed to demand protection for the American seamen wrecked on the coast, and if that failed to effect a treaty by which American ships would be allowed to enter one or more ports to obtain supplies and for purposes of trade. In February, 1854, Com. Perry, with a fleet of seven ships of war, entered the bay of Edo, and anchored within a few miles

of the city. During the previous year he had entered the same bay, and delivered to the Japanese a letter to the shogun from the president of the United States. The proceedings of Com. Perry were characterized, throughout the difficult task of dealing properly with the Japanese, by consummate tact and diplomatic skill, and were finally crowned with success. By a treaty dated at Kanagawa, the nearest large town, though really signed at Yokohama, then a mere fishing village, March 31, 1854, the ports of Shimoda and Hakodate (usually written Hakodadi) were opened as harbors of refuge, supply, trade, and consular residence. In September a British squadron, under the command of Rear Admiral Sir James Stirling, entered the harbor of Nagasaki, and concluded a treaty with Japan, by which Hakodate and Nagasaki were opened to foreign commerce. The Russians made a similar treaty and obtained similar privileges, and were followed by the Dutch. On June 17, 1857, a new treaty was negotiated at Shimoda with the Japanese government by Mr. Townsend Harris, United States consul general to Japan, by which the port of Nagasaki was also opened to American trade. In 1858, in spite of all opposition, Mr. Harris succeeded in reaching Yedo, where he concluded a still more favorable treaty. During the same year a British squadron conveyed Lord Elgin to Yedo, where on Aug. 26 a new treaty was concluded between Great Britain and Japan, by which the ports of Hakodate, Kanagawa, and Nagasaki were to be opened to British subjects after July 1, 1859; Niigata, or some other convenient port on the W. coast of the main island, after Jan. 1, 1860; and Hiogo after Jan. 1, 1863; and various other commercial privileges were granted to British merchants. At the present date, 1874, Japan has treaties with the United States, Great Britain, Russia, Holland, Prussia, Portugal, France, Spain, Switzerland, Italy, Austria, Greece, Denmark, Sweden and Norway, Hawaii, Peru, and China, which are similar in most respects. In 1860 a Japanese embassy, the first ever sent from the country, visited the United States, and another embassy visited Europe in 1861. The signing of the treaties by the shogun, who was wholly unprepared for the advent of the American commodore, caused an intense excitement throughout the country, general dissatisfaction, and deep indignation at the imperial court in Kioto. The sympathy of many daimios was excited and developed in behalf of the emperor, and the tide of power and influence began to set toward Kioto and away from Yedo. The shogun having died in 1858, the premier and regent at this time, an insolent and haughty man, disregarding the popular choice, selected the infant daimio of the province of Kii, and by execution and imprisonment suppressed all the leaders of the party who opposed his will. On March 23, 1860, the regent, who had despatched the embassy to the United States, was

assassinated in the public streets of Yedo in broad daylight. After his death the custom of the shogun making personal visits to the sovereign at Kioto was revived, thus showing where the supreme power lay. Influences from Kioto now became so strong that the families of the daimios, long held as hostages, were withdrawn, and the custom of the daimios visiting Yedo was abolished. From this period Kioto became superior to Yedo, and while the power of the mikado daily increased, that of the shogun decreased, until the Yedo government was despised and openly defied. The cry of all the conservative and "patriotic" Japanese now was, "Honor the mikado, and expel the barbarians." In July, 1863, while the shogun's government was engaged in trying to persuade the foreigners to close the ports and leave Japan, the forces of the daimio of Choshu (Nagato), acting upon orders from the imperial court of Kioto, fired on the ships of the United States, France, Great Britain, and the Netherlands. These treaty powers afterward sent their ships of war to Shimonoseki, the port at which the batteries were erected. A complete victory of the foreigners was the result, and an indemnity of 3,000,000 Mexican dollars was demanded and obtained. This victory opened the eyes of the anti-foreign party to the power and resources of the "outside barbarians." Choshu had acted in disobedience to the express command of the shogun, who had obtained a rescission of the order of the imperial court to "expel the barbarians." The shogun made an expedition against Choshu to punish him for his disobedience, and to suppress his province. He set out with a large but motley force, equipped in the old style of armor, and armed with bows and arrows, spears, and swords. The forces of Choshu were well drilled in foreign style, armed with rifles, and lightly and tightly clothed. A most decided and disastrous defeat of the shogun's army was the result. Defeat, mortification, and disease together carried off the shogun, Sept. 19, 1866, and he was succeeded by the new shogun, the last of his line, Hitotsubashi. Seven of the most influential daimios were summoned to Kioto, and one, the prince of Tosa, boldly proposed the abolition of the shogunate, and suggested the unification of the power of the nation in the hands of the emperor. The shogun accepted the situation, and tendered his resignation. This however did not seriously alter the form of government, and left the machinery of power in very much the same order as before, the mikado merely taking the authority of the shogunate to himself. In the winter of 1867-'8 the party in favor of an utter abolition of the shogunate, and a return to the ancient imperial system of government, formed a conspiracy and resolved on a bold *coup d'état*. Iwakura, now junior minister and chief of the embassy to the United States and Europe in 1872, was a prominent leader as well as instrument of

the conspiracy. They created a government, under which the highest offices were filled by the *kuge*, or court nobles of the imperial family, those next in order by daimios and courtiers, and those of the third grade by able men selected from the *samurai* or gentry. All the power was thus thrown into the hands of a clique, composed almost entirely of the men of the four clans of Satsuma, Choshu, Tosa, and Hizen. These proceedings aroused the indignation of the ex-shogun, and he withdrew from Kioto to Ozaka with his followers. Under their influence, and by their persuasion, he undertook to reënter Kioto, with the view of driving out his opponents and of punishing the conspirators. At Fushimi, near Kioto, his vanguard was fired on, and his army, numbering nearly 30,000 men, after three days' fighting, were defeated by the opposing force, chiefly from Satsuma and Choshu, and numbering but 6,500 men. The ex-shogun escaped to Yedo in an American steamer, and on his arrival, although surrounded by a large army and possessed of a splendid navy, he declared his intention never to oppose the mikado's will. A small party supported him in this resolve, but the daimios of the northeast entered the field against the imperial forces, and gallantly maintained the desperate struggle for six months. The commander of the ex-shogun's navy took the island of Yezo, and setting up an aristocratic republic held out against the imperial forces for many months, when, the greater part of the fleet being sunk and the forts silenced by the rain Stonewall, supported by a large land force, the imperialists obtained a complete victory and the submission of the enemy. The whole country was now at peace. A complete and marvellous change took place in the foreign policy of the mikado's party. Hitherto the court at Kioto had been the centre of the anti-foreign spirit, and the motive and grand object of the coalition that overthrew the power of the shogun was to centralize all power in the imperial throne, strengthen the empire, and then to sweep away the foreigners from the country. The immense superiority of foreign arms, war material and discipline first opened their eyes, and since all the treaties bore the signature of the shogun they were afraid lest the foreigners should aid him, and, regarding them as rebels, should seriously endanger their future course. In their extremity they invited the foreign representatives, then temporarily at Hiogo, to a conference and an imperial audience in the very heart of the old anti-foreign Kioto. The conversion of the court nobles was thorough and instantaneous. Many of them had never seen a foreigner. The men from the western nations were found to be neither wild beasts nor demons. From this point the mikado's government was known and recognized by all foreigners as the only and supreme government in Japan. In the spring of 1869 the four clans, Satsuma, Choshu, Tosa, and Hizen, addressed a memo-

rial to the throne, in which it was argued that the fiefs of the daimios ought not to be looked on as private property. Other clans supported the memorial. The imperial court, after consulting the general opinion, abolished the titles of court and territorial noble (*kuge* and *daimio*), and replaced them by that of "noble families" (*kuzasoku*). In the summer of 1871 the entire power of the empire was centred directly in Tokio (Yedo), which had received its new name in 1868. All public property throughout the empire came into possession of the imperial government, and the former daimios were given the alternative of travelling abroad or living in Tokio, one tenth of their former revenue being allowed them for support. In December, 1871, an embassy consisting of the ambassador and junior prime minister Iwakura, and the vice ambassador Kido, three ministers of the cabinet, and inferior officers and secretaries, numbering 49 persons in all, sailed from Yokohama to visit all the nations having treaties with Japan. They spent seven months in the United States, and about a year in Europe, reaching Japan on their return, by way of Suez, Sept. 13, 1873.—The principal writers on Japan are: Kämpfer, "History of Japan" (2 vols. fol., London, 1727); Golovnin, "Memoirs of Captivity in Japan," translated from the Russian (2d ed., 3 vols. 8vo, London, 1824); Meylan, *Japan voorgesteld in schetsen* (Amsterdam, 1830); Doeff, *Herinnerungen uit Japan* (Haarlem, 1833); Titsingh, *Annales des empereurs de Japon* (Paris, 1834); Siebold, *Nippon* (20 vols., Leyden, 1832-'57); Mrs. Busk, "Manners and Customs of the Japanese," compiled and translated from Siebold and other Dutch authorities (London, 1841); Charles Macfarlane, "Japan" (London, 1852); Richard Hildreth, "Japan as It Was and Is" (Boston, 1855); Francis L. Hawks, "Narrative of the Japan Expedition" (3 vols. 4to, Washington, 1856); Laurence Oliphant, "Narrative of Lord Elgin's Mission to China and Japan" (2 vols., London, 1859); Capt. Sherard Osborne, "A Cruise in Japanese Waters" (Edinburgh, 1859), and "Japanese Fragments" (London, 1861); Robert Fortune, "Visits to Japan and China" (London, 1863); Sir Rutherford Alcock, "The Capital of the Tycoon" (2 vols., London, 1863); Walter Dickson, "Japan, a Sketch of the History, Government, and Officers of the Empire" (Edinburgh, 1869); A. Berg, *Die preussische Expedition nach Ost-Asien* (4 vols., Berlin, 1854-'73, the first two volumes being devoted to Japan); Léon Pagès, *Histoire de la religion chrétienne au Japon* (2 vols., Paris, 1869); Aimé Humbert, *Le Japon illustré* (2 vols., Paris, 1870; English translation, London, 1873); Charles Lanman, "The Japanese in America" (New York, 1872); Bayard Taylor, "Japan," &c., compiled from Humbert, Alcock, and others (New York, 1872); *Das alte und das neue Japan*, by Steyer and Wagner, brought down to the present time by Ed. Hintze (Leipsic, 1873); A. Mori, "Edu-

cation in Japan" (New York, 1873); Mossman, "New Japan" (London, 1873); Adams, "History of Japan" (London, 1874 *et seq.*).

**JAPAN, Language and Literature of.** The Japanese language belongs to the polysyllabic branch of the Mongolian division. In a narrower sense, it has neither common descent with nor family relationship to the Chinese, and it is entirely different in its grammatical structure. Like other languages, it has undergone important changes, as may be seen upon comparison of the language as now spoken with that in the ancient books, which is only intelligible to those who make these books a special study. The native language is the same whether written or spoken, though the colloquial differs in several respects from the best literary style; the latter is more concise, and still retains some of the archaic forms of the verb and auxiliary words. The common colloquial abounds in interjectional and onomatopoeic words and particles, uses a more simple inflection of the verb, and makes a greater use of honorific and polite terms. The dialectical variations in different parts of the country consist mainly in the different pronunciation of some of the syllables, and in the use of provincialisms. The dialects of some of the more remote regions, as Satsuma, are not easily understood by the people of Tokio (Yedo); but these differences are not greater than are common in all the languages of Europe, and are by no means so great as in China.—The Japanese vocabulary has been greatly enlarged and enriched by the introduction of Chinese words, all taken from the Chinese written language, and not from the colloquial, which has never been spoken in Japan except by a few interpreters at Nagasaki. So extensively have these words been introduced, that for almost every native word the Japanese have an equivalent Chinese word. But in common usage the names of things, family relationships, and the words which express the wants, feelings, and concerns of every-day life, are for the most part native words; while the technical, philosophical, and scientific terms are Chinese. The Chinese words abound most in the higher class of literary composition, in letters, governmental documents, and philosophical works, as well as in the conversation of the higher and educated classes; while native words are more current in the literature intended for the common people, by whom, and especially by the women, the native tongue is spoken in its greatest purity. The grammatical structure of the language has not been affected by the introduction of Chinese words. The latter retain their integrity, undergoing no change or inflection of any kind, but are woven into a sentence by means of native words, or auxiliary words and particles, which indicate the cases of the nouns, form of the adjective, and moods and tenses of the verb. The Japanese have endeavored to preserve the Chinese sounds of the characters; but, as in transliterating these sounds they of necessity used their own syllables, the pronun-

ciation has in many cases been altered, but with no greater variation from the mandarin sounds of the characters than in many of the dialects of China. Unfortunately for the learner, three systems of pronunciation are used. One, called the *Go-on* (from that state in China which had the highest political influence at the time), was introduced when the Chinese language first became a subject of study by the Japanese, about A. D. 286. Another, called the *Kan-on*, was introduced in the 7th century; and another, called the *To-on*, in more recent times. The *Go-on* pronunciation is most current among the Buddhists and the common people, while the *Kan-on* is used mainly by the Confucianists, the government, and the literary classes. The Japanese have formed or invented many ideographs, after the manner of the Chinese, to designate things or words in their own language for which there were no equivalent characters in the Chinese. They also attach meanings to many of the characters different from the Chinese, and use them in a different way to suit the grammatical requirements of their native tongue. There are three general styles of literary composition in use. One is pure Chinese, in which none but Chinese characters are employed, and the grammatical construction is in accordance with the Chinese idiom. Frequently in this style marks or signs are used along the line of the characters to designate the order in which they should be read in translating the sentences into the Japanese language, or to suit the native idiom. Another, and the most common, is that in which the Chinese characters are used to a greater or less extent, mixed with native words written with their own letters, and where the structure and idiom are purely Japanese. Most of the literature intended for the unlearned and common reader is in this form. There is still another, written almost entirely in the native character, with little or no admixture of Chinese, intended for the use of women and children and uneducated persons. There is no reason to believe that the Japanese possessed letters or characters with which to write their own language previous to the time of the introduction of the study of Chinese into their country. The weight of evidence as well as of authorities is against the statement of some authors who advocate this opinion, and even produce an ancient alphabet, which however is too artificial in its form and structure to warrant the belief that it is anything more than the invention of some person of modern times. If they ever had an alphabet or syllabary more ancient than the present one, it has certainly not been used for many centuries, and there are no books now extant written in this character. It was after the Japanese had begun to study and read Chinese books that the syllabary now in use was formed, and when we may also believe they began to reduce their native language to writing. This syllabary was of gradual growth, and not the invention of any one

person. In their earliest writings the Chinese characters were used, in the same composition, in a double capacity: phonetically, to express merely Japanese syllabic sounds; and significatively, to express in the native language the idea contained in the character. As phonetics they were first used especially to write the names of persons, places, postpositions, and auxiliary words and particles. The characters were also first used in their entire form, unabbreviated; but being found too cumbersome and inconvenient, they were simplified in form, and rendered more easy to read and more expeditious in writing, in two ways: one, called *hira-kana*, by writing the whole character in a very abridged or contracted form and in a cursive style; the other, called *kata-kana*, by taking a part only of the character, consisting generally of two or three strokes, to express the sound of the whole. These two forms have no resemblance to each other. The *hira-kana* is the kind of letter commonly used, especially in books intended for the common people and the uneducated classes. The *kata-kana* has been little used, except in dictionaries to define the meaning of Chinese characters, or in scientific and philosophical works. In the *hira-kana* there are also several ways of writing the same letter, differing in being more or less contracted, as well as several different letters to express the same syllabic sound, making the acquisition of the written language extremely troublesome.—The Japanese letters are 48 in number. Each letter represents a syllabic sound, excepting the last or a sound, which is only used as a final consonant, and is not included by the Japanese in their syllabary, which they always speak of as containing 47 syllables. The syllabary or alphabet is called *iroha*, from the first three letters; and this is also the first word of a series forming three sentences in which the letters have been arranged to facilitate their acquisition. The *kata-kana* signs of the *iroha* are derived from Chinese characters, the latter, which are prefixed in the following table, being also used as capitals:

伊	イ	i	和	ワ	wa
呂	ロ	ro	加	カ	ka
半	ハ	ha, fa	與	ヨ	yo
仁	ニ	ni	多	タ	ta
侯	ホ	ho, fo	風	レ	re
反	ヘ	he, fe	曾	ソ	so
土	ト	to	用	ツ	tu, tsu
千	チ	ti, tsi, chi	子	子	ne
利	リ	ri	奈	ナ	na
奴	ヌ	nu	瓦	ラ	ra
施	ル	ru	牟	ム	mu, m
乎	フ	wo	フ	フ	n

字	ウ	u	阿	ア	a
井	井	i, wi, yi	薩	サ	sa
乃	ノ	no	幾	キ	ki
於	オ	o	弓	ユ	yu
久	ク	ku	女	メ	me
也	ヤ	ya	三	ミ	mi
末	マ	ma	之	シ	si, shi
介	ケ	ke	惠	エ	e, we, ye
不	フ	fu	比	ヒ	hi, fi
已	コ	ko	毛	モ	mo
江	エ	ye	世	セ	se
天	テ	te	須	ス	su

The following is the iroha in hira-kana, with the Chinese characters from which the Japanese are derived prefixed:

以	い	i	宇	う	u
呂	ろ	ro	爲	ゐ	i, wi, yi
波	は	ha, fa	乃	の	no
仁	に	ni	於	お	o
保	ほ	ho, fo	久	く	ku
反	へ	he, fe	也	や	ya
止	と	to	末	ま	ma
知	ち	ti, tsi, chi	計	け	ke
利	り	ri	不	ふ	fu
奴	ぬ	nu	已	こ	ko
留	る	ru	江	に	ye
遠	を	wo	天	て	te
和	わ	wa	安	あ	a
加	か	ka	左	さ	sa
與	よ	yo	幾	き	ki
太	た	ta	由	ゆ	yu
礼	れ	re	女	め	me
會	ろ	so	美	み	mi
門	つ	tu, tsu	之	し	si, shi
福	ね	ne	惠	ゑ	e, we, ye
奈	な	na	比	ひ	hi, fi
良	ら	ra	毛	も	mo
武	む	mu	世	せ	se
(ん)		n)	寸	す	su

In the transcription the sounds of the consonants are the same as in English, and the vowel sounds as in Italian (*a* as in *father*, *e* like *a* in *fate*, *i* as in *machine*, *u* like *oo* in *moon*), except in the syllables *tsu*, *su*, and *zsu*, where the *u* is a close sound, like the French *u*. The

syllabary consists in full of 72 syllabic sounds, including the final *n*; but excluding this, and several others which, though having different letters to represent them, are really the same sound, and are constantly interchanged with each other by the natives, the number of distinct syllabic sounds is reduced to 68. These are divided by the Japanese into 44 pure (*sei-on*), and 24 impure (*daku-on*) syllables. The latter are not included in the syllabary, and are as follows: *ba*, *pa*, euphonic changes of *ha*; *bo*, *po*, from *ho*; *be*, *pe*, from *he*; *do*, from *to*; *ji*, from *chi* or *shi*; *ga*, from *ka*; *da*, from *ta*; *zo*, from *so*; *dzu*, from *tsu* or *su*; *gu*, from *ku*; *ge*, from *ke*; *bu*, *pu*, from *fu*; *go*, from *ko*; *de*, from *te*; *za*, from *sa*; *yi*, from *ki*; *bi*, *pi*, from *hi*; *ze*, from *se*. The impure syllables are represented by the characters for the corresponding pure ones, with diacritical marks added; thus *ba* is written by the letter *ha* with two dots over the right shoulder, and *pa* by the same letter with a small circle in the same place. In analyzing the Japanese syllables, we find they have 5 vowel, *a, e, i, o, u*, and 19 consonantal sounds, *b, ch, d, f, g, h, j, k, m, n, p, r, s, sh, t, ts, w, y, z*. They have not the sounds of *l, qu, v, th, or x*, and the people find it very difficult to make them. All the syllables of the native words end in a vowel, except the future tense of the verb, which now ends in a final *n*, though anciently it was written with the character for *mu*, and there is reason to believe it was so pronounced. In all other cases the final *n* is only used in spelling Chinese words. The syllables commencing with the weak aspirates *h* and *f*, or with *y*, when preceded by another syllable, for the most part lose their consonants, and their vowels combine with the vowel of the preceding syllable, sometimes forming a diphthong; thus *a-hi* becomes *ai*, pronounced like the long English *i*; *a-fu* becomes *au*, pronounced like *ow* in *cow*. Sometimes the sound of the first vowel is reduplicated or lengthened; thus *nu-fu* becomes *nuu*, written *nû*; *i-hi* becomes *ii*; *yo-fu* becomes *yô*. In Chinese words, the vowel of the first syllable and the consonant of the second are often both elided in pronunciation; thus *chi-ya* is pronounced *cha*; *shi-yo*, *sho*. The syllable *tsu*, when preceding the consonants *k, s, p*, and *t*, is elided, and the consonant of the syllable following is doubled; thus *batsu-kun* is pronounced *bakkun*; *matsusugu*, *massugu*. *Ku*, when followed by a syllable beginning with *k*, loses its vowel; thus *baku-ka* is pronounced *bakka*; *koku-ka*, *kokka*.—The Japanese language has no article. The noun has no inflections; case, gender, and number are designated by words or particles either prefixed or affixed to the noun. The case is designated by postpositions, as follows: nominative, *wa* or *ga*, as *neko wa*, a cat; genitive, *no* or *ga*, as *neko no*, of a cat; dative, *ni*, *ye*, *ni oite*, as *neko ni*, to a cat; accusative, *wo*, as *neko wo*, a cat; vocative, *yo*, *ya*, *kana*, as *neko yo*, O cat; ablative, *kara*, *yori*, *de*, *nite*, *wo*

*motte*; as *neko de*, by a cat. The number is not designated except when it is emphatic. When the noun is used without any words to mark its number, it is to be taken in a generic or abstract sense; thus *kami* may mean one god or all the gods; *tsuki*, one month or many months. If the number is very great and indefinite, it is expressed by *sen*, 1,000, or *ban*, 10,000; thus, *ban-koku*, all countries; *bun-motsu*, everything. The plural is also designated by *su*, several, and *sho*, many or all. All these are Chinese. The plural is formed by duplicating the word, as *ware-ware*, we; *hitobito*, people; *tokoro-dokoro*, places; also by the words *domo*, *tachi*, *ra*, *nado*, *nazo*, and for Chinese words *shu* and *to*, following the noun. Gender is designated, when it must be expressed, by the words *otoko*, male, and *onna*, female; as *otoko no ko*, a male child, boy; *onna-gami*, a female divinity, goddess; also in Chinese words by *nan*, *niyo*; as *nan-shi*, a boy, *niyo-shi*, a girl. In the case of animals and birds the gender is designated by prefixing *me* and *o* (contractions of *mezu*, female, and *osu*, male), as *me-ushi*, a cow, *o-ushi*, a bull; *men-dori*, a hen, *o-tori*, a cock. By prefixing *ko* (a child), a class of diminutive nouns is formed; as *ko-bune*, a little boat; *ko-ushi*, a calf; *ko-ishi*, a pebble. Also *o* (a contraction of *okii*, great, big) is used as an amplifying prefix; as *o-bune*, a large boat, *o-kaze*, a tornado; *o-ame*, a storm of rain. Nouns expressing abstract qualities are formed by suffixing the particle *ai* (a contraction of *sama*, state, condition) to the root form of the adjective; as *shiro*, white, *shiro-ai*, the whiteness; *taka*, high, *taka-ai*, the height.—The root forms of verbs are also nouns; as *yorokobi*, joy; *urami*, hatred. The word *te*, hand, added to the roots of verbs, denotes the agent of the action expressed by the verb; as *kai-te*, the buyer, *uri-te*, the seller. Nouns are also formed by adding the word *kata*, side, mode, to the root form of verbs; as *shi-kata*, way of doing, *koshi-kata*, the past. The attributive form of the adjective is often treated as a noun. Many compound nouns are formed: 1, by joining together two nouns, as *kurasu-hibi*, a black snake (literally, crow-snake); 2, by an adjective and noun, as *shiro-gane*, white metal, silver; 3, by a noun and verb, as *asa-ne*, morning sleep; and 4, by a verb and a noun, as *hiki-ami*, a seine. The Chinese nouns are declined or take the postpositions in the same way as the native words.—The words classed or used as pronouns are numerous, and may be divided into personal, demonstrative, interrogative, reflexive, indefinite, and distributive. There are no relative pronouns; where in English a relative pronoun is used, in Japanese the person or thing is put in direct subjection to the verb, which acts as an attributive adjective; as *tegami wo kaku hito*, a man who writes letters (literally, letter-writing-man). In conversation as well as in books personal pronouns seem to be carefully avoided, in this respect agreeing with the cus-

tom of the Chinese. In books especially it is often difficult to distinguish the speaker, the person spoken of, and the person spoken to. This is indicated mainly by the style of language employed, which varies with the rank or social position of the person addressed or spoken of. Most of the words used as personal pronouns are such as express humility on the part of the speaker, and honor the person addressed.—The ancient Japanese cardinal numbers are: 一, *ito*, *h'ito*, one; 二, *ni*, two; 三, *san*, three; 四, *yo*, four; 五, *itsu*, five; 六, *mu*, *muyu*, six; 七, *nana*, seven; 八, *ya*, eight; 九, *yū*, *kokonotsu*, nine; 十, *to*, once ten; 百, *so*, termination of tens; 千, *mo*, hundred; 千, *so*, termination of hundreds; 十, *ai*, thousand; 十, *ai*, *yorozu*, ten thousand. With the exception of these, the Japanese use the Chinese numerals, as well as the Chinese systems of weights, measures, and notation of time. The adjective is not inflected to indicate either case, gender, number, or comparison. But in order to express its relation to other words as an attributive, predicative, or adverb, it takes as suffixes to its root form the syllables *i* or *ki*, *shi*, and *ku*; thus, the form *samu*, cold, as an attributive is *samui* or *samuki*; as a predicative, *samushi*; and as an adverb, *samuku*. In the colloquial the terminal syllable *i* is used also to express the predicative form; as *fuyu ga samui*, the winter is cold. The comparative degree is denoted by means of the words *gori*, from, and *nao*, more, yet; as *yubi wa kami yori shiroshi*, snow is whiter than paper, or *nao yoi*, better. The superlative is expressed by the aid of certain adverbs: *mototomo*, indeed; *itatte*, exceedingly; *goku* or *shigoku*, superlatively; *hanahada*, *ito*, very; *sei-ichi-no*, or *ichi-ban*, number one. Chinese words take the attributive adjective form by means of the auxiliary words *naru* and *na*, as *kon-kiu naru hito*, a poor man; or when qualifying another Chinese word, merely by preceding it, as *gwai koku*, a foreign country. Adjectives are formed from nouns by the use of the postposition *no*; as *uso no hanashi*, a false story; *ishi no iye*, a stone house; also by suffixing to them the word *rashii* or *rashiki*, like, or *gamaashii*; as *onna-rashii*, womanlike; *otoko-rashii*, manlike. They are formed from verbs by means of *shii* (a contraction of *shiki*, to spread); thus from *osore*, to fear, is formed *osoroshii*, fearful. Several forms of the verb act also as attributive adjectives, viz. the indicative present in *u* or *ru*, the preterite in *u*, *taru*, and *shi*, and the negative indicative in *nu*, *saru*, and negative preterite in *ji*. Many adjectives take the substantive verb *ari* as a suffix to the adverbial form, and are conjugated like a verb; thus *samuku*, the adverbial form of *samu*, and *ari*, to be, becomes *samubaru*, to be cold; preterite *samukatta*, was cold; future or dubitative, *samukarō*; negative present, *samukaradzu*, is not cold; negative preterite, *samukunakatta*, was not cold. In construction the attributive adjective, and also the adver-

n, always precede the noun and the ich they qualify.—The verb has no in- to express either number or person; polite language, by the use of certain or auxiliary words prefixed or joined not form, the personal relations of the y be distinguished, as well as by the d kind of verb used. The verb has e, intransitive, causative, passive, po- negative, and desiderative forms; for : transitive, *age*, to raise or lift up; ive, *agari*, to rise of itself or go up ion of the root *age* and substantive ); causative, *agesaseru*, to cause an- raise (by joining *saseru*, the causative *suru*, to do, to the root *age*); passive tial, *agerareru*, to be raised, or can be rom root *age* and passive of substan- ; *areru*, which is also a contraction of be, and *yeru*, to get, thus literally , get-to be-raised); negative, *agenu*, e (from *age* and *nu*, a contraction of t to be); desiderative, *agetai*, wish to m *age* and *tai*, desirous). The verbs ed into three conjugations, have past, and future tenses, and indicative, im- conditional, conjunctive, and concess- eds, and present participles. The ac- he verb becomes reciprocal by joining *au*, to meet, join, to the root; as *uchi*, , *uchi-au*, to strike each other. In id verbs, which are numerous, the ent takes the root form and is sub- to the last, expressing the manner in s action is performed; as *nusumi-toru*, y stealth; *tobi-oduro*, to jump down. ence the subject as well as the object erb always precedes it.—Besides the l form of the adjective, there is a large idverbs formed from nouns by the use ostpositions *ni* and *de*, or by duplica- word; as *nichi*, day, *nichi-nichi*, daily; ir, *toki-doki*, hourly or often. The rticle is frequently used adverbial- *ajimete*, at first; *kesshite*, positively. erb and an adverbial clause precede the ich they qualify. What are called ons in English should in the Japanese d as postpositions, since they always e word to which they are related; as *yukita*, has gone to Yedo. This rela- also frequently expressed in Japanese pound verb; as *ido ni tobi-komu*, to o a well. Copulative and disjunctive ions are numerous, but they are most- sed by the conjunctive, conditional, or e moods of the verb. There are a few ch as *soro*, *keri*, *shiku*, and *sari*, the nd tenses of which are used only as ions. The colloquial especially abounds erjectional, emotional, and onomato- ords, which, though impossible to de- ranslate, are very expressive and add d life to the language.—The most ac- Japanese grammar is that of J. J. n (English ed., Leyden, 1868).—LIT-

ERATURE. No means exist for determining the precise age of the most ancient monu- ments of Japanese literature, but there is little doubt that both prose and poetical composi- tions existed previous to the introduction of the Chinese method of writing. This is as- serted to have taken place in the 15th year of the mikado Ojin (A. D. 284) through the me- dium of a Korean named Ajiki, who gave some instruction to the heir apparent. The statement occurs in the *Nihongi*, one of the earliest historical works extant, which was composed about the year 720. The *Nihongi* contains so much that is evidently fabulous, especially in relation to the ages of the per- sonages mentioned in it, that it cannot be re- lied on for the accuracy of its dates; and there is very good reason to believe that the intro- duction of the Chinese language took place considerably later than is usually supposed. It is stated, on the other hand, that the Japanese possessed from ancient times an alphabet of their own, which they abandoned for the Chi- nese ideographic writing; but this assertion, absurd enough by itself, is denied by the best authorities. It follows therefore that the most ancient compositions, namely, the verses of poetry given in the *Kojiki* and *Nihongi*, and the *norito* or liturgies read at the festivals of the native Shinto gods, were handed down orally. It happens unfortunately that at the period when they came to be written down the Chinese character was preferred to the *kana*, only recently introduced, and the real text is often difficult to ascertain. I. STANDARD HISTORIES. Japanese bibliographers make history the first division of their literature. The most ancient historical work, which is at the same time the earliest written document extant, is the *Kojiki*, in three volumes, com- posed at the command of the mikado in A. D. 711-'12, by Yasumaro. It is said to have been preceded by two similar works which were composed respectively in 620 and 681, but neither of these has been preserved. The book called *Kujiki*, which purports to be the former of these, and the work therefore of the celebrated Shotoku Taishi and Soga no Umako, is a forgery of later date, as is shown by the fact that it contains passages from the *Kogoshitui*, a book composed in 808, and men- tions the mikado Saga (809-842). The *Kojiki* begins by relating the foundation of the heavens and earth, and the first volume is entirely oc- cupied by the events of the mythological pe- riod. The second and third volumes contain the history of the mikados from Jimmu Tenno down to the empress Suiko Tenno, whose reign ended in 628. It is written with Chinese characters, some of which represent whole Japanese words (*mana*), and others merely separate sounds of the syllabary (*kana*), and in general conformity with Japanese idiom. Old manuscripts of this work are extremely rare, and the earliest printed copy is dated *Kuanyei* (1624-'42). A most valuable com-



mentary on it was compiled by the learned Motoōri Norinaga toward the end of the 18th century, under the title of *Kōjikiiden*. The next most ancient work of the kind is the *Nihongi* or *Nihonshoki*, which was also composed at the command of the reigning mikado, and completed in 720, by a commission presided over by the prince Toneri Shinno. It differs very much from the *Kōjiki* in being composed in a purely Chinese idiom, and the poetry which occurs here and there is all that it contains of Japanese. This fact explains the abundance of Chinese philosophical notions which are found in it throughout, but notably at the very commencement, where the pure Japanese tradition of the creation is preceded by one of Chinese origin. Still this book has always been much more read than the *Kōjiki*, and all the ordinary histories are founded on it. The first two volumes contain the mythological period; the remaining bring the annals of the mikados down to the 11th year of the empress Jido Tenno (699). It is somewhat curious that, although the mythological part contains numerous references to "other documents," the remainder is a simple unsupported narration. The *Shoku Nihongi*, in 20 volumes, contains the history of the mikados from the first year of the reign of Mommu Tenno (672-686) down to the end of the 10th year of Kuammu Tenno (782-806), a period of 120 years. It was composed at the command of the mikado Kuammu, about the year 797, by Sugano no Mannichi, Fujiwara no Tsugunawa, and others. The *Nihon Kōki*, in 10 volumes, was composed in 841 by Fujiwara no Fuyutsugu, at the command of the mikado Nimnio (833-850), and contains an account of the events between the years 792 and 823. About one half of it has been lost. The *Shoku Nihon Kōki* was composed about 869 by Fujiwara no Yoshifusa, Harusumi, and Yoshinawa, at the command of the mikado Seiwa Tenno; it is in 20 books, and contains the history of Nimnio Tenno's reign. The *Montoku Jitsuroku* was composed about 879 by Fujiwara no Mototsune, Urabe no Yoshika, and Sugawara no Michizane, and contains the history of the reign of Montoku Tenno (850-858). The *Sandai Jitsuroku* was compiled about 901 by a number of persons, among whom was Michizane, by command of the reigning mikado Daigo Tenno; it consists of 20 volumes, and narrates the history of the reigns of Seiwa Tenno, Yozei Tenno, and Koko Tenno (858-876, 876-884, and 884-887). The above mentioned six works are called by the general name of the *Rikkokuashi*, or "Six National Records." They are all written in the Chinese idiom, and contain no passages in Japanese, with the exception of the speeches ascribed to the mikados, some of which are, however, evidently corrupt. Sugawara Michizane compiled a work based on these original histories called *Ruijin Kokushi*, in 200 books, which has never been printed, and the greater part of

which has been lost. Of the *Honcho Seiki*, another history which contained the latter part of the reign of Uda Tenno (887-897), composed by the priest Shinsai Hoshi, all but one book has been lost. This author lived about the middle of the 12th century. The *Fuso Riakki* is a history commencing with the reign of Daigo Tenno (897-930) and concluding with that of Go-Toba Tenno (1184-'98); but of the whole 14 books about one third has been lost. The *Nihon Kiriaku* is a history of the mikados from 884 to 1028, but the reigns of Koko Tenno and Uda Tenno are wanting. It is moreover uncertain who were the authors of these last two works, and to what period they belong. Hayashi Razan (1583-1657), in conjunction with his son Gaho or Shunsai, compiled a general history of Japan in 273 books entitled *Honcho Tsugan*, beginning with Jimmu Tenno and ending with the 34th year of Gyozei Tenno. A supplement to this work was completed in 1703 by the great-grandson of Razan; it is entitled *Kokushi Jitsuroku*, and forms 79 books. Both of these works exist only in manuscript. The next historical work was the *Dai-Nihonshi*, in 243 books, which are bound up in 100 volumes. The first 73 books contain the history of the mikados from Jimmu Tenno to Go-Komatsu Tenno (1393-1413); 12 are devoted to notices of their wives and concubines, 14 to the princes of the imperial blood, 6 to the princesses, 73 to biographies of high officials of the government under different reigns, 8 to the shoguns from Yoritomo to Ashikaga Yoshimitsu, 5 to the relatives of the shoguns, 22 to retainers of the shoguns, 5 to notices of scholars, 4 to poets, 1 to examples of filial piety, 1 to the samurai noted for their loyalty and courage, 1 to celebrated women, 1 to men who retired from the world, 1 to artists, 3 to rebels, 1 to traitors, and the last 12 to the relations of Japan with other Asiatic states, such as various Chinese kingdoms, down to the time of the Mongol and Ming dynasties, Corea, Mantchooria, southern India, and Loo Choo. It is written entirely in classical Chinese, and the composition is said to have been corrected by Chinese scholars who fled to Japan during the troubles in their own country in the 17th century. The list of works made use of in compiling it contains 663 titles. It was composed by a number of Japanese scholars engaged for that purpose by the second prince of Mito (1622-1700), who was in reality the founder of the movement which culminated in the revolution of 1868. By his express wish the empress Jingo Kogo was transferred from the list of sovereigns to that of the mikados' wives, and Prince Otomo was placed among the sovereigns. He further vindicated the cause of legitimacy by treating the mikados of the *nanchō* or "southern court" as the genuine sovereigns, and those of the *kyōtō* or "northern court" as usurpers. It was completed about 1715, but was first printed in 1851. The *Nihon Shunjiu* (in Chinese), is

50 books, by the Buddhist priest Nisaho, is a work compiled on the same principles, but in somewhat different form, the same materials as those which were used for the *Dai-Nihon-shi* having been worked up into a continuous narrative. It only exists in manuscript, and copies are extremely rare. Arai Hakuseki (1657-1725) was the author of two valuable historical works. One of these is the *Koshitsu*, in 5 volumes, published in 1716; it seeks to explain in a rationalistic manner the legends contained in the *Kojiki*, *Nihongi*, and *Kujiki*. The other is the *Tokushi Yoron*, in 12 volumes, completed in 1724; a most valuable philosophical view of the different changes which have taken place at various times in the distribution of the governing power in Japan. The latest historical works of importance are those of Rai Sanyo (1780-1838). The *Nihon-guishi*, in 22 volumes, was published by him in 1827, after 20 years of continuous labor. It commences with the rise of the Taira (Heike) and Minamoto (Genji) families in the 12th century, and ends with the establishment of the Tokugawa shogunate in the 17th century. The plan adopted is to narrate the history of each of the families which held the reins of power in succession after the decay of the authority of the mikados, a period which may be called that of the domination of the military class. Some of these families possessed not more than a fifth of the country at once, but others extended their sway over the whole. In the *Seiki*, published after his death, Rai depicts the history of Japan from the commencement of Jimmu Tenno's conquest in B. C. 667 (an uncertain date) down to the abdication of Goyozei Tenno in 1596, and discusses the character and conduct of each sovereign in turn. Both works are written in classical Chinese. A pupil of Rai's has also published a supplement to the *Nihon-guishi*, in which the annals of various prominent military families are presented. All three of these are extremely useful works, and have contributed not a little to the formation of the political opinions which were current in Japan until the year 1868. II. MISCELLANEOUS HISTORICAL WORKS. Most of these are by private authors, and are written either in hiragana, or in a mixture of Chinese characters and katakana or hiragana, and therefore in the Japanese idiom. The earliest of these is the *Okagami*, in 8 books, by Fujiwara no Tamchira, a court noble (*kuge*) who flourished in the middle of the 11th century. It contains notices of occurrences at the court between the years 850 and 1035. The *Mitzu-kagami*, in 3 books, by Nakayama Tadachika (1131-'95), deals with the period between the accession of the semi-mythical Jimmu Tenno and the reign of Nijunio Tenno (833-850). The *Masu-kagami*, in 10 books, by Ichijo Fuyuyoshi (1464-1514), narrates events which occurred at the court between 1184 and 1338. These three works are called by the general title of *Mitso-kagami*, or the "Three Mirrors." The

*Yeigua Monogatari*, in 41 books, is a more detailed work of the same kind, extending over the period from 889 to 1092. The name of its author and the date of its composition are both unknown, but it probably belongs to the 12th century. It is an excellent specimen of the classical form of the Japanese language. The subjects treated are chiefly detached incidents in the lives of the mikados and members of the families allied to them, and the only reason given for not placing the collection among the *monogatari* properly so called is that the stories related are true. The *Shoku Yotsugi*, in 10 volumes, is a history of the doings of the court between the years 1025 and 1170, written in pure classical Japanese. Like the *Yeigua Monogatari*, it contains a large number of Japanese songs. Another name for it is the *Imakagami*, or "Mirror of the Present." The *Hogen Monogatari* and *Heiji Monogatari*, each in 8 books, relate the strife between the Taira and Minamoto families in the years 1157 and 1159, in which the latter were entirely defeated and crushed for a while. The authorship of these two works is attributed to Hamuro Tokinaga, who must have lived about the end of the 12th century. They were originally printed in hiragana, but in the variorum editions, called *Sanko Hogen Monogatari* and *Sanko Heiji Monogatari*, the Chinese characters with katakana have been used. The *Hoken Taiki*, in 2 books, is a narrative of the wars of the Taira and Minamoto families between 1156 and 1192, by Kuriyama Gen (1671-1736); it was composed in the Chinese classical style, about the year 1689. The *Gempei Seisuiiki*, in 48 books, is a work of great literary merit, besides being of considerable value as a history of the times. As the title, "Glory and Fall of the Minamoto and Taira," indicates, it is a narrative of the struggle between these two families. It extends over the period between 1161 and 1182. The authorship is ascribed to Hamuro Tokinaga. The *Heike Monogatari*, in 12 books, is based on the *Gempei Seisuiiki* with some additions. It is said to have been composed by a certain Yukinaga in the reign of the mikado Go-Toba (1184-'98), and therefore not long after the events narrated in it. It is written chiefly in the hiragana, with a small proportion of Chinese characters; but the style is rather difficult, as the rules of grammar are disregarded in order to adapt the composition to music. Several different texts exist. The only annotated edition is the *Heike Monogatari Sho*, in 12 volumes, without date; from the appearance of the print it must be about two centuries old. The *Adsuma-kagami*, in 52 volumes, is a valuable mine of historical information about the period between 1180 and 1266. It relates the history of Yoritomo and his two sons and the three succeeding shoguns, and of their prime ministers the Hojo. The author's name is unknown, and the probability is that it is a mere compilation from the records of the Kamakura shoguns, which after the end of

the Hojo dynasty of ministers fell into the hands of the Uyesugi, who were ministers under the Ashikaga. It is written in very bad Chinese, but contains a number of official documents which are useful examples of the current style of writing. The first printed edition appeared in 1605, and a second in 1624, with an interlinear Japanese translation. A valuable work for comparison with the *Adzuma-kagami* is the *Gukuan Sho*, in 7 books, by the Buddhist priest Jichin Osho. It contains notices of the mikados from Jimmu to Juntoku Tenno (1211-'20), and much information with regard to the existing Buddhist monasteries and the affairs of the Kamakura shogunate. It appears to have been written about the middle of the first half of the 13th century. The *Shokiiki* is a record of the rebellion of Hojo Yoshitoki, in 1221, against the ex-mikado Go-Toba, whom, with his son Tsuchi-mikado and the reigning mikado Juntoku, he banished to various parts of Japan. The *Horeki Kanki*, in 3 books, is an account of events which took place between the years 1156 and 1841, by an anonymous author. The *Jinko-shoto-ki*, in 6 books, by Kitabatake Chikafusa (1293-1359), contains the history of the mikados from the commencement of the mythological period down to the accession of Go-Murakami Tenno in 1339, which is the date also of its composition. It was written to prove that the "southern emperor" was the legitimate descendant of Tensho Daizin, and his rival, the nominee of the Ashikaga family, a mere usurper. On this account it is very highly thought of by Japanese, but in point of literary execution it is very inferior, and shows the extent to which the language had then been corrupted. It was first printed in 1649. There is a supplement to it in one book, which continues the history down to the reign of Go-Hanazono (1429-'64). Many other narratives of the same period exist, of which the most important is the *Taiheiki*, in 41 books, containing a minute account of the events between 1318 and 1367. Various authors were engaged upon it, and it was composed at different times between the years 1334 and 1382. About the end of the 14th century a clean copy was made by the order of the shogun Yoshimochi for some Chinese officials on a visit to Japan. There is a variorum edition called *Sanko Taiheiki*, by two Mito scholars, Imai Kosai and Naito Teigen, in 64 books. The most complete edition is that known as the *Taiheiki Komoku*, published in 1668 in 60 volumes, with many notes. It contains besides the usual text a list of the mikados and their chief ministers from Jimmu Tenno to Ogimachi Tenno (1558-'87), a treatise on the ancient court dress, notes on the division of the provinces at various periods, treatises on the duties of civilians and military men by Fuzifusa, a servant of Godaigo Tenno (1319-'38), a treatise on war by Kusunoki Masahige, and a volume of legends relating to celebrated swords. The literary style of the *Taiheiki* is

no better than that of the *Jinko-shoto-ki*; it is wanting in unity of design, and is overloaded with references to Chinese and Indian history. The *Meitokki*, in 3 books, relates the history of the rebellion of Yamana Ugikiyo and Yamana Mitsuyoshi in 1390; and the *Oyeiki*, of the rebellion and destruction of Ouchi Yoshihiro in 1399. The *Chinyoki* is an account of the raising to the throne of Go-Hanazono Tenno in 1429, written by his father, the prince Iokin Shinno. The *Onin-ki* is an account of the civil war waged by Hosokawa Katsumoto and Yamana Sozen for the position of chief minister to the shogun Ashikaga Yoshimasa; it raged for six or seven years (1467-'73), and only came to an end through the death of both chiefs. The *Kamakura Ozoshi* is a collection of historical papers on events which occurred at Kamakura between 1379 and 1479. The style marks the transition from the pure Japanese of the *monogatari* to the modern language. The author is unknown. The *Odai Ichiran*, in 7 volumes, is the work of Hayashi Shunai (1618-'80), and contains the history of the mikados from Jimmu Tenno down to Ogimachi Tenno (1558-'87). It was written about 1633 and printed in 1664. The style of composition is decidedly inferior, and it is scarcely worthy of notice but for the fact that a translation of it into French was published in 1840 by Klapproth. The best history of the life and achievements of Toyotomi Hideyoshi (*Taikosama*) is the *Taiko-ki*, in 21 books (11 volumes), composed about 1625 by an unknown author; it contains a number of contemporary documents of high value for philology. III. LAW. Closely connected with history is the department of laws of all kinds. These are divided by Japanese writers into four branches, for which exact equivalents cannot easily be found in the English language. The preface to the *Konin Kaku* says: "The object of *ritsu* is to warn and correct; that of *rio*, to induce and persuade; the *kaku* are rules made for special emergencies; the *shiki* supplement the whole." Of these, *ritsu* seems to correspond to penal law, *rio* to administrative law; *kaku* are decrees and notifications explanatory of the *ritsu* and *rio*, and the *shiki* are supplementary directions for fulfilling the objects of the *ritsu*. According to native writers, the earliest attempt at framing a code was that made by Shotoku Taishi in the year 604 (12th of Suiko Tenno), who composed 17 chapters of law, which are preserved in the 5th book of the *Shiugai Sho*; they are rather a collection of moral precepts than law. In 668 (1st year of Tenji Tenno) 22 chapters of *rio* were compiled. In 701 Fujiwara Fubito and others drew up 6 books of *ritsu* and 11 of *rio*, which were again superseded in 718 by a new code of both in 10 books each. Of the former but a small portion has been preserved, and the fragments have been published by Hanawa Hokiichi in his great collection entitled *Gwanho Ryūjin*. The supplement to the *ritsu*, with a commen-

tary by Nakahara Akito, has also been preserved under the title of *Kingioku Shochiusho* (date of compilation, 1207). It may here be remarked that the Japanese codes were from the earliest times based on those of the Chinese, and it was on the laws of the Tang dynasty (619-907) that the above mentioned *Yoro Ritsu* were modelled. The *Ling* (pronounced *Rio* in Japanese) of the chronological period called Kaiyuen (713-'41) are supposed to have been the source of the *Yoro Rio*. This code consists of 80 chapters divided into 10 books, and has been preserved complete in the commentary prepared in 888 called the *Rio no Gige*. An excellent annotated edition of the first eight chapters was published in 1864 by Kondo Yoshiki, under the title of *Hiochiu Rio no Gige Kohon*; it is stated that the remainder is in existence in a manuscript form. A work of equal interest is the *Ruijiu Sandai Kaku*, containing collections of decrees issued between the years 701 and 907, with commentaries thereon. The first, called *Konin Kaku*, in 10 books, dates from 819; the second, or *Joguan Kaku*, was formed in 868, in 12 books; and the third in 907, with the title of *Yengi Kaku*, in 10 books and a supplement. Of the whole 82 books fragments of only 6 have survived, which were rescued from oblivion in the year 1266. Besides the *kaku*, compilations of the *shiki* were made at each of these periods. The first two, named *Konin Shiki* and *Joguan Shiki*, have not come down to us, all that was of any value in them having been preserved in the *Yengi Shiki*. This compilation occupied ten years in formation, and was completed in 927. Of its 50 books, the first 10 are devoted to matters coming under the cognizance of the *Jingikuan*, or "office of the gods," and contain directions as to the ceremonies to be observed at certain festivals, the whole of the *Norito* or liturgies, and a complete list of the Shinto temples then existing in different parts of Japan. The remaining 40 books treat of the miscellaneous duties of the other departments of the government. It appears to have been first printed in 1648. The *Gishiki*, in 10 books, defines the rites performed at certain festivals, the coronation ceremony, and the general observances of the court throughout the year. The date and author are unknown. The *Dairi Shiki*, or "Court Ceremonies," is the title of a work in 8 books compiled by Fujiwara no Fuyutsugu early in the 9th century. Of the *Hoso Ruijiu*, in 280 books, only two have survived; while nine remain of the *Seiji Yoriaku*, an equally voluminous work on administrative law. The *Suiban Shiyosha*, in one book, is a manual of the laws of Tempio (729-'48) and *Konin* (810-'23), by Sakanoye Akimoto (1138-1210). The *Hokuzan Sho*, in 11 books, by the Dainagon Kinto (966-1041), is said to be the best authority on the court ceremonies since the reign of Ichijo Tenno (986-1011); but it is surpassed in comprehensiveness by the *Goka no Shidai*,

in 21 books, by Oye no Masafusa (1041-1111). The first 11 books treat of the court business during the whole year; the 12th and 13th of Shinto and Buddhist religious festivals; the 14th and 15th of the coronation; the 16th of imperial progresses; the 17th of the mikado's coming of age, his beginning to learn to write, his marriage, the inauguration of the heir apparent and his education, and the selection of princes of the blood; the 18th of proclamations, the alteration of the chronological period (*nengo*), and other similar matters; the 19th of archery, horse racing, &c.; the 20th of certain festivals, the appointments of ministers of state, the education of the mikado's sons, &c.; and the 21st of miscellaneous proceedings of the court. This, as well as the *Shingai Sho* (1489), in 6 books, by the Sadaijin Sanehiro, are continually quoted by the historian Arai Hakuseki in his *Tokuhi Yoron*, which is a sufficient guarantee of their value. The *Giogi Shikimoku*, in one book, by the priest Giogi, who died in 749, contains land regulations, sumptuary laws, an estimate of the population, and of the amount of rice and other cereals produced annually at that period. The *Joyei Shikimoku*, also called *Go Seidai Shikimoku*, in one book, was composed under the direction of Hojo Yasutoki, prime minister of the Kamakura shoguns, and is the code of that period. In later times it has been much used as a copy book for children, but it is of great assistance to the historian as a means of understanding the system of administration which was established by the military power after the decadence of the mikados. A good edition, with a commentary, was prepared in 1584 by Sei Soyu. A very interesting book is the *Nitchiu Giogi*, by the mikado Go-Daigo (1819-'39), which details the sovereign's manner of daily life and the duties of the palace attendants. There is also a large class of books called *Nenjiu Giogi*, which describe the festivals and ceremonies of the court for the whole year. The *Seito-tsu*, in 18 books, by Ito Nagatane, explains the ancient institutions of Japan by copious reference to those of China, on which they were for the most part based. Its preface is dated 1724. One of the works on offices most widely known is the *Shokugen Sho* of Kitabatake Chikafusa (1298-1859). It was composed in 1841, without reference to any other work, in bad Chinese, and has been illustrated again and again by various commentators. The best edition is that of Kondo Yoshiki, a Choshu samurai, entitled *Hiochiu Shokugen Sho Kohon*, in 6 volumes; the preface is dated 1854. The *Kuanshoku Biko*, in 8 volumes (1695), is the most complete account of the constitution of the court and government yet produced, and is one of the few works of the kind not written in Chinese. The *Reigi Ruiten*, in 510 books, is a work compiled by order of the second prince of Mito, from about 200 private records of noble families, and is concerned with the ceremonies and etiquette of the mi-

kado's court. There are 214 books devoted to the ordinary transactions of the year, the remainder to the *kagura*, or ancient pantomimic plays performed in honor of the "three divine emblems," praying for rain and fine weather, the accession and abdication of the sovereign, the harvest festival, imperial journeys, the ceremony called *gembuku* (coming of age) of the mikado, the commencement of his studies, his nuptials, births in the imperial family, the mikado's concubines, the change of style (*kaigen*), the forms used in imperial decrees and proclamations, appointment of ministers of state, memorials to the throne, and other kindred subjects. Probably the only copy in existence is that in the public library at Tokio. One president, 15 compilers, 28 scribes, 10 readers, 4 accountants, and 8 overseers were engaged upon it for six hours every other day during 24 years, from 1686 to 1710. Nearly all the works called *Kiroku*, or (family) records, are in manuscript. That of the five noble families called *Sekke* begins with the reign of Murakami Tenno (946-'67), and occupies 210 volumes. It is called the *Huitami no Ki*. There are many more, some of even older date, which would be valuable materials for the historian. The Japanese attach great importance to lineage, and there are several large works on genealogy, the earliest of which is the *Shinsen Shoji Roku*, prepared in 815; the best edition is that published at Kioto in 1807, in 4 volumes. IV. BIOGRAPHY. The earliest specimen of this kind of writing is the *Shotoku Taishi Denriaku*, in 2 books, by Taira no Motochika, written in 992. It is the life of M'mayado no Oji, eldest son of Yomei Tenno (573-621), who was the main instrument in the spread of Buddhism in Japan. An annotated edition, called *Taishi Denriaku Biko*, in 15 volumes, was published in 1678 by the priest Riou. Of the famous statesman and historian Sugawara no Michizane (845-903), afterward deified under the name of Temman-gu, many biographies have been written. The earliest is the *Kuanke Godenki*, a Chinese work in one volume, by his relative Nobutsune, which is certainly of not later date than 1118. The *Dazai-fu Temma-gu Kojitau*, in 2 volumes, by Kaibara Tokushin (1630-1714), relates his life, deification, and subsequent history; it seems to have been written about 1685. The *Kuanke Jitsuroku*, in Japanese, by Matsumoto Guzan (3 vols., 1798), contains much introductory matter about his ancestry, with his life, exile, death, burial, and deification. But the most complete of all his biographies is the *Kitano Koso*, by Ishida Jihei (1840), containing 4 volumes of engravings from ancient drawings illustrative of events in his life, and 10 volumes of extracts from original documents. The *Saigio Monogatari* is a life of the poet Saigio Hoshi (died 1198), in Japanese, by an unknown author, and contains a large quantity of the verses made by him on various occasions. It was first printed in 1562.

The *Muso Koku* (3 vols.) is the life of the Buddhist priest Muso Kokushi (1275-1351), founder of the monastery of Tenriuji at Naga, near Kioto. Eight or nine priests seem to have shared its authorship, one of whom was the third abbot of Tenriuji, so that it cannot be of later date than the end of the 14th century. The *Genkio Shakusho*, in 15 volumes, is a work in Chinese, containing short biographies of over 400 priests, emperors, nobles, and other persons famous for their devotion to Buddhism, and embraces a period of more than 700 years, beginning with the introduction of Buddhism in the 6th century. It was compiled by the priest Koguan, and presented by him to the mikado in 1822. The *Fuso Zenrin Soden*, in 10 volumes (1675), by the priest Kosen, contains the lives of 117 priests of the Zen sect. Other works of a similarly comprehensive nature are: the *Hiakushoden* (2 vols.), containing accounts of famous warriors and chieftains from the mythological age down to Shibata Katsuiye and Toyotomi Hideyoshi, by Hayashi Doshun and his sons, Shunsai and Shuntoku; Utsunomiya Yuteki's *Nihon Kokin Jimbutsushi* (7 vols., 1668), containing notices of generals, famous families, faithful retainers, traitors, virtuous and intrepid samurai, Chinese scholars, physicians, women, and artists; the *Fuso Initouden* (3 vols., 1664), in Chinese, by the priest Gensho (1623-'68), consisting of notices of 75 persons noted for strange and solitary habits; such as Yen no Shokaku, who lived in a cave for 80 years, and made spirits do his bidding; Fushimi no Okina, who lay on the ground for three years with his eyes directed eastward, during the whole of which time he never uttered a word; Kachio no Shonio, who became a monk at the age of seven, and lived for many years tasting food only once in five days, and never spoke; and the Shiradashi no Okina, an old man who was always 70 years of age, and had been so ever since the memory of the living; the *Honcho Retsujiden* (10 vols., 1655), by Kurozawa Hirotsuda, in 10 sections, devoted to famous women since the reign of Korei Tenno (290-215 B. C.); the *Honcho Hime-kogami*, in 20 vols., by the priest Riou (1661), a collection of lives of famous women, written for his daughter in Japanese; the *Sentetsu Soden* (9 vols., 1816), by Tojo Tagayasu, notices of 73 native Chinese scholars and authors of the 17th and 18th centuries, in Chinese; *Kinsei Kijinden*, lives of about 80 poets and Japanese authors of the 17th and 18th centuries (5 vols., 1790), by Banno Kokei (1733-1806); *Shoku Kinsei Kijinden* (5 vols., 1795), a supplement to the last named work, containing notices of nearly 100 writers, by Mikumi Shiko; and *Sentetsu Soden* (4 vols., 1844), by Tokuzi Gengi, in Japanese, containing the lives of 20 modern native Chinese scholars and authors. Besides these, the 9th volume of *Tamadanihi*, by Hirata Atsutane (1780-1843), is occupied by biographies of the famous Shinto revivalists

no Adzumamaro, Mabuchi, and Motoōri ūta, written in excellent classical Japanese conceived on a proper method. The *rokka-shū Riakuden*, in 2 small volumes by Kawagita Mahiko (1848), is a handbook reference for the lives and productions of native authors of the same period. V. Y. In poetry the Japanese do not seem to have advanced much beyond the most elementary forms. With few exceptions their poetry consists of songs in five lines of syllables called *uta*. These songs seem to have been spontaneous compositions, but about the middle of the 8th century had hardened into a conventional and verse making became a mechanical plishment, of which dexterity in punning is the most important part. Assemblies were held by the amateurs of versification, at which were drawn for a certain number of subjects and the greater part of the *uta* which obtained in the numerous selections originated in this manner. The most ancient are no doubt those which are given in *Yūki* and *Nihongi*, and next to them in time must probably be ranked the *uta* in the *Manyōshū*. A *naga-uta* (or song) ought to consist of unrhymed lines of 5 and 7 syllables alternately, terminating two lines of 7 syllables each; but this by no means inflexibly adhered to. The *uta* in this collection will serve as an example; the numbers of the syllables are 6, 5, 5, 5, 5, 4, 7, 5, 7, 5, 6, 5, 6, 7. In other songs, ordinarily 31 syllables in an extra syllable is sometimes admitted; we are to believe the native commentators also permissible to insert here and there to make up the measure, odd syllables of any meaning. Another kind of short song called *sedoka*, consists of six lines of 5 syllables, arranged in the following order: 7, 7; 5, 7, 7. This, however, admits of various modifications. The actual date of the collection called the *Manyōshū* is disputed; the usual account is that it was commenced in the middle of the 8th and completed early in the beginning of the 9th century. It contains 20 of the 31-syllable songs and *sedoka*, and *ga-uta*, arranged in 20 books. The critics classify them as follows: various songs; of the affections, chiefly amatory; parables; songs involving a simile; and of the four seasons. Great difficulties attend with regard to the proper reading of the *shū*, on account of its being written in Chinese characters, which sometimes are for whole words and at others for single syllables. The first approach to a correct pronunciation is believed to have been made by the priest Keichū (1640-1701). He was followed by Kamo no Mabuchi (1698-1769), whose edition, entitled *Manyōko* (9 vols.), is highly valued, and by Kato Chikage (1734-1808), whose edition in 30 volumes, called *Manyōshū*, is perhaps the best, though by no

means perfect. The earliest of all the songs in the *Manyōshū* is that ascribed to Yūriaku Tenno (457-559); the best are contained in the 1st, 2d, and 13th books; then come those in the 11th, 12th, and 14th. The *Kokin Wakashū*, the second of the compilations made by order of the mikado, was commenced in 905 and finished about 922. The preface is one of the oldest specimens of Japanese compositions in hiragana, the Chinese character having been exclusively employed up to that time. The object of this collection was to preserve for posterity those verses which had not been considered worthy of a place in the *Manyōshū*, but it also contains many of later date. The whole number of songs is estimated at 1,099, classified as follows: spring, summer, autumn, winter, felicitations, parting, journeys, names of things, love, pathetic, miscellaneous, *naga-uta* (5), *sedoka* (4), *haikai*, and *o-naobi no uta*. The best commentary on this collection is the *Kokin Wakashū Uchigiki* (20 vols.), by Kamo no Mabuchi; the *Tokogami* (6 vols.), by Motoori Norinaga, is an explanation of the songs in the common colloquial dialect of Kioto. The *Gosen Wakashū*, in 20 books, was compiled about the middle of the 10th century; it contains 1,356 songs, classified much in the same way as those in the *Kokinshū*. The *Shū Wakashū* dates half a century later, and contains 1,351 songs, among which are a few *naga-uta* and *kagura-uta*. These three together are known as the *Sandaishū*. There are innumerable other collections made at the mikado's command and by private persons, besides selections of 100 songs, each called *Hiakushū Kūi*. The best known of the latter works is the *Hiakuninshū*, which is the most popular classic of the Japanese; it was formed about the year 1235 by a court noble, commonly called Teika Kio. The commentaries on it are very numerous, but the best are the *Uimanabi*, by Mabuchi, the *Hitoyogatari* (1833), and the *Mine no Kakehashi* (1805). A translation of the *Hiakuninshū*, with notes, has been made by F. V. Dickins (London, 1866). A better work on Japanese poetry is the *Anthologie japonnaise* of Léon de Rosny (Paris, 1870), to which is prefixed an excellent treatise on the different kinds of Japanese poetry. VI. ROMANCES. "The term *monogatari* is used to denote a class of composition which differs from history in that the author makes no attempt to sift the true from the fictitious, but simply records the current tradition respecting the hero or heroine." This definition, which is that of Mabuchi, is not applicable to all *monogatari*. In some cases individuals who actually existed at some time or other have been made the heroes of fictitious adventures, while others have not even that slight basis of fact. Certain of the *monogatari* are collections of verses, with short stories attached, which profess to give the circumstances under which they were composed; while others which bear the title are in reality his-

torical. But the *monogatari*, properly so called, is essentially a fiction, and the word "romance" is the closest English equivalent. The earliest of these is the *Taketori Monogatari*, the authorship of which is sometimes ascribed to Minamoto no Shitagau (911-783), but some writers think it belongs to the first half of the 9th century. An old man finds a little girl only three inches high in a joint of bamboo, whom he adopts and educates. She grows up into a beautiful young woman, and is solicited in marriage by five noble suitors, upon whom she imposes various labors, in which they all fail to satisfy her. The mikado also falls in love with her, and offers to make her his concubine, but she refuses. Shortly afterward she makes known to her protector that she is an inhabitant of the moon, banished to earth for some offence, and that the period of her penance being about to expire, she must soon return thither. The old man's protestations are of no avail, and she is finally carried off by her father's messengers in a flying chariot, much against her own will, and in spite of 2,000 guards placed around the cottage and on its roof by the mikado. The parting is described in a most pathetic manner. She leaves behind her farewell letters to the old man and to the mikado, and the elixir of immortality. The mikado causes the elixir to be burnt on the top of a lofty mountain in Suruga, which thenceforward is called *Fuji no Yama*, "the immortal mountain." The *Utsubo Monogatari* is a collection of 14 stories which fill 20 volumes. It is also ascribed to the author of the previous work, and is evidently one of the earliest extant. In the *Toshikage no Maki*, one of these stories, are related the adventures of a young man who is shipwrecked in a strange country, where he falls in with animals who speak, giants, and the like, and he finally returns home with some magic harps. Two of these he bequeaths to his daughter when he dies. A young nobleman, attracted by the strange music which proceeds from her dwelling, passes a night there, and never returns. She bears a son who performs wonders of filial piety, and feeds her with roots which he digs in the mountains. On the approach of winter he removes her to a cave vacated for them by a family of bears, and the apes who inhabit the surrounding hills bring them food and water. At last she is rediscovered by the young nobleman, who is now grown up to ripe manhood, as he is hunting in the mikado's train, and they live together happily for ever after. The *Himamatsuri Chinnagon Monogatari* is the story of a nobleman who goes to China, has a child by the empress, and then returns to Japan. The *Sumiyoshi Monogatari* is the story of a young girl, the illegitimate daughter of a nobleman, who has two other daughters by his own wife. When the heroine is about eight years of age her mother dies, after earnestly praying her lover to send her child to the palace to become one of the mikado's wait-

ing women. He takes her to live in his own house, in separate apartments, and the affection he displays for her excites the hatred of her stepmother. After a while the heroine's foster mother also dies, and she is left alone with her foster sister, a girl two years older than herself, through whom she enters into a secret correspondence with a young nobleman who has fallen in love with her from report of her beauty. The father constantly speaks of sending her to the palace, which excites the jealousy of the stepmother, and her ruin is determined on. With a hypocritical affectation of concern the stepmother tells her husband that she has seen a priest get out of his daughter's window at dawn; and when he refuses to believe this, she conspires with a wicked maid servant and bribes a priest to come to the house and play the part of detected lover. Upon this he is convinced, upbraids his daughter, and orders her to marry a man of rank whom she does not know; but rather than disobey, she is ready to consent. When the stepmother finds that she has been so far unsuccessful, she plots again to have the object of her hatred stolen away by a horrid old man, whose lust is inflamed by the promise of a beautiful girl for his mistress; but the plan being divulged to the young girl and her foster sister by a friendly female servant, they make up their minds to flee to Sumiyoshi, where the late nurse of the dead foster mother is living as a nun. This they accomplish successfully, and the author takes advantage of this opportunity to introduce some very effective description of seaside scenery. The lover is desperate, and resolves to become a hermit, but the hiding place of the young lady is revealed to him in a dream and he proceeds in search of her. Having found her out, he disguises her as a peasant girl and brings her back to Kyoto, where they are secretly married and have two children. The father is disconsolate at the flight of his daughter, but after seven years is invited to a feast by the young noble, and discovers in his wife his long lost favorite. Upon this the wickedness of the stepmother is revealed, and she suffers the penalty of her misdeeds by dying in misery and want. All the partners of her guilt are duly punished by avenging fate, and the father retires from the world, while all the good people in the story have their reward. The *Ise Monogatari* is the history of the love adventures of a noble celebrated for his beauty, named Ariwara Narihira (825-80), and contains a large number of verses written by himself and his numerous sweethearts. It is considered to be a model of good Japanese prose. The precise date of its composition and the name of its author are unknown, but Mabuchi thinks it belongs to the middle of the 10th century. A similar work is the *Yamato Monogatari*, in two books, the authorship of which is ascribed by some to Shigeharu, the son of Narihira, and by others to the mikado Kuazan-In (968-1008); but the

probability is that while both of them had a hand in it, it was brought into its present form by a third person. The *Ochi-kubo Monogatari* is the story of a young lady of rank who is persecuted by her stepmother, and kept out of sight in a sunken room, but is rescued by a nobleman, who marries her, and has by her a daughter who becomes empress. Minamoto no Shitagau is said to have been the author; Mabuchi is of opinion that even if this be not the fact, it must have been written about the reign of Reizei-In (967-'9). It is inferior to the *Sumiyoshi* in interest. Of all these romances the most celebrated is the *Genji Monogatari*, in 54 books, by the poetess Murasaki Shikibu, who flourished at the beginning of the 11th century, the composition of the work being referred usually to the year 1004. It relates the amorous adventures of Hikaru Genji, the son of the mikado's favorite concubine. The titles of the various books into which it is divided are chiefly taken from the names of the women whom he loved. In point of style it is considered to be far superior to all the other monogatari, being far more ornate; but the plot is devoid of interest, and it is only of value as marking a stage in the development of the language. The best edition is that entitled *Kogetsusho*, by Kitamura Kigin, a scholar of the 17th century. The *Sagoromo*, in 8 books, is a love story which takes its name from the hero. The author was Daini no Sammi, daughter of Murasaki Shikibu, and nurse to Ichijo-In (born 986), and it is thought to have been composed about 40 years later than the *Genji Monogatari*. The *Idzumi Shikibu Monogatari* is a diary of the amours of Idzumi Shikibu and the fourth son of Reizei-In, and contains all the verses which they sent to each other. Its date is about the end of the 10th century. The *Torikaihaya* is of later date than the *Sagoromo*, but the name of its author is unknown. A somewhat involved plot is founded upon the following incidents. A noble has two children, a girl and a boy, each of whom from a very early age displays the characteristics of the opposite sex, the boy being fond of playing with dolls and painted shells, averse to women, and of a retiring modest disposition, while the girl constantly seeks the society of young men, with whom she plays at foot ball, practises archery, blows the flute, and sings songs. The father is much troubled by the double perverseness of his children, and exclaims, "If I were to change them," which is the title of the romance. He puts this idea into execution, and brings up his daughter as a boy and his son as a girl. The consequences are of the same kind as those which follow upon Don Juan's introduction into the seraglio as a female slave. Of the *Ima Monogatari*, which was originally a large work, only one book now remains. It contains a number of uninteresting stories, invented no doubt to serve as settings to certain songs of no great value. The authorship is ascribed to Nobuzane, who flourished at the end of the

12th and beginning of the 13th century. The *Konjaku Monogatari* is a collection of Japanese, Chinese, and Indian stories by Minamoto no Takakuni (died in 1077), in 60 volumes, divided into customs, wonders, crimes, retributions, Buddhism, and miscellaneous. The *Uji Shitai Monogatari*, in 15 volumes, is a supplement to the above. The *Tsutsumi Chiunagon Monogatari*, in one volume, is a collection of ten short tales, ascribed to Fujiwara no Kane-suke (877-938); and if this be correct, it is one of the earliest specimens of purely Japanese composition. The *Aki no Yonaga Monogatari* recounts the loves of a priest named Keikai and a young prince, the consequence of which was a war between the monasteries of Midera and Hiyeizan, in the reign of Go-Horikawa (1222-'83). The boy drowned himself and the priest became a hermit. The style is overloaded with Buddhist terms, and it is evidently the composition of a priest. The *Matsuko Monogatari* is a similar love tale with a tragic ending. Among these romances are many which still remain in manuscript, and of those which have been printed no copies older than the 17th century exist. The consequence is that the text of many is extremely corrupt, or at least doubtful; but in spite of this defect they are of great value for philological as well as for other purposes. VII. MISCELLANIES. There is a small class of books called *soshi* or miscellanies, which belong to the classical period. The earliest of these is the *Makura no Soshi*, by Sei Shonagon, a daughter of Kiyowara Motosuke, and waiting woman to Jotomonin (988-1077). It is a medley of autobiographical fragments, observations on society, descriptions of natural objects, court ceremonies, and scattered notes of all kinds, impregnated with wit of the highest order. The *Doroboro no Soshi*, in one book, by Mioye Shonin (1174-1233), who is said to have first introduced tea into Japan, is the history of the two sons of a Kioto woman who was never seen except at night; after her death they become mendicant priests. This composition ought no doubt to be classed with the monogatari. The most famous of the miscellanies is the *Tsurezure-gusa* of Kenko Hoshi (1282-1350). It contains 244 short chapters on morals, offices, ancient customs, the seasons, the proper use of words, society, and anecdotes. In form it is an imitation of the *Makura no Soshi*, and its style is modelled on that of the *Genji Monogatari*, which in the 14th century was becoming obsolete. The commentaries on it are numerous, but that of Kitamura Kigin, entitled *Mondansho*, is the best. The *Shosho Daisei* is a variorum edition, and clumsily arranged. The *Otogi Zoshi*, in 23 volumes, is a collection of stories which belong to different periods, the latest being of the 17th century, and it ought properly to be classed with the monogatari. The *Oriorigusa*, by Tate Riutai, a pupil of Mabuchi, is a collection of notes made by the author on his travels. VIII.



**JOURNALS.** The earliest of these is the *Murasaki Shikibu Niki*, composed by her after she was left a widow. It contains descriptions of various events at the court, written in a highly ornate style, and the title is scarcely appropriate. The *Kagero Niki*, by the mother of Michiami, is a record of her connection with Michikane, beginning with the year 954, and coming down to 974. The *Ben no Naishi Niki* is a record of events beginning with the abdication of Go-Saga no In in 1246, and ending with 1252, also by a woman. The *Hojoki*, by Kamo no Chomei (beginning of the 13th century), contains accounts of the great fire in 1177, the hurricane of 1180, the removal of the capital to Kyoto in the same year, the famine of 1181, and the great earthquake of 948. The *Fuji Goran no Ki* is the journal of a visit made by the shogun Yoshinori (1429-'41) to Fuji no Yama. The *Saiokuken Sochoki* and the *Socho kuku no Ki* are autobiographical notes by the priest Socho (born 1447, lived beyond 1526). IX. **TRAVELS.** The *Tomi Niki*, by Kino Tsurayuki, is a diary of his journey back from Tosa to Kyoto in 935. The author conceals his personality by writing in the style then supposed to be exclusively employed by women. The *Suma no Ki* purports to be the diary of Sugawara Michizane on his way to exile in Chikuzen; but although its style is exactly that of the older literature, it is a manifest forgery, for it speaks of the heroine of the *Taketori Monogatari*, a book written some time after the death of Michizane. The *Matsushima Niki*, attributed to Sei Shonagon, is also condemned by the best judges as a recent forgery. The *Sarashina Niki*, by the daughter of a descendant of Michizane, is the record of a journey from Shimosa to Kyoto by the tokaido in the year 1021, and a second journey from Kyoto to Sarashina, in Shinshu, a few years later. The *Izuyoi Niki* is the journal of Teika Kio's widow on a journey to Kamakura to obtain justice for her son Tamesuke against his elder brother Tamenji. It is written in good style, and appears to be merely a vehicle for introducing verses made by the way at each post town. The *Fujikawa no Ki* is the journal of Ichijo Kaneyoshi (1402-'81) as he was fleeing from Kyoto to avoid the civil war of Onin (1467). The *Shoko Niki* is a diary of a journey from Kyoto to Suruga in 1473. The *Shirin Ikoshu*, in 6 volumes, is a collection of journeys by different persons, made by Miyagawa Issuishi. All these works belong to the purely ornamental literature. A magnificent collection of fragments of this kind is the *Fuso Shiuyoshu*, in 36 volumes, compiled by order of the second prince of Mito. There exists a supplementary collection called *Shiui Goyoshu*, in 26 volumes, by Eda Seikio, which ranges over nearly eight centuries, from the beginning of the 10th down to near the end of the 17th. It has not been published. X. **DRAMATIC.** The Japanese drama is of three kinds: the *no*, a kind of historical play, generally of a tragical cast; the

*kiogen*, or low comedy; and the *yoruri*, a mixture of the two. The former have been collected, and are known as *utai*; they date from the time of the shogun Ashikaga Yoshimasa (1449-'90), and are still played with the costumes of that period. There are five editions which slightly differ among themselves, a fact which is due to their having been separately preserved by as many families of hereditary actors, named Kanze, Hoshō, Komparu, Kongo, and Kita. The *kiogen* are in the colloquial language of the same period, and possess great philological value. Fifty of them were printed in 1662, under the title of *Kiogenki*. The *Mai no Hon*, also called *Kowaka Zashū*, is a collection of 36 ancient plays which are no longer acted, but recited with musical intonations by a single performer, without scenery or costume. The *yoruri* are the modern plays, which are either acted on the stage by actors and a chorus, or recited by a single person to the accompaniment of the three-stringed lute or *akemisen*. XI. **DICTIONARIES AND WORKS OF PHILOLOGY.** The earliest dictionary is the *Wamō Ruijū-shō*, in 20 books, by Minamoto no Shitagau (911-'83). It contains a number of Japanese words, with the corresponding Chinese characters, definitions, and quotations from five or six works. The whole is divided into the following categories: 1, heaven; 2, earth; 3, water; 4, divisions of the year; 5, demons and gods; 6, social relations; 7, relatives; 8, parts of the body; 9, arts and accomplishments; 10, music; 11, offices; 12, provinces and departments; 13, dwellings; 14, ships; 15, vehicles; 16, kine and horses; 17, treasures; 18, scents and drugs; 19, lamps, &c.; 20, woven fabrics; 21, clothing; 22, utensils, weapons, instruments of punishment, &c.; 23, household utensils; 24, eating and drinking; 25, grain; 26, fruits; 27, vegetables; 28, winged tribe; 29, hairy tribe; 30, scaly tribe; 31, insects; 32, trees and plants. It is said to have been prepared at the command of one of the princes. The *Shinsen Jikio* is a dictionary of Chinese characters, arranged according to the radicals, with the Chinese pronunciation according to the system of spelling called *han-erh* (*fan taich*), and the Japanese equivalents, completed by the priest Shōjū in 892. Only one volume remains out of twelve. At the end there are collections of double characters and onomatopœia. As a general rule, however, the Japanese have contented themselves with reprinting the best known Chinese dictionaries, such as the *Yu-pien*, Kanghi's great lexicon, and the *Wache-yun-suy*. Of these the first has also been translated into Japanese. There is a useful dictionary in two volumes called *Shinō Jibiki*, with the Chinese characters in the square and cursive forms, and the Japanese equivalents in hiragana. Dictionaries of the Japanese language came to be made only after the revival of learning in the 17th century. The first of these is the *Nihon Shakumei* (1699), by Kaibara Tokushin (1630-1714), in which an

attempt is made to give the etymologies of words, arranged under 28 categories. The *Toga*, by Arai Hakuseki (1657-1725), is an etymological and explanatory dictionary of Japanese words, in 20 books, arranged according to categories. The author has abstained from attempting to give any derivations of which he did not feel sufficiently certain. The most valuable dictionary of the Japanese language is the *Wakan Shiori* of Tanigawa Shisei, who flourished during the latter part of the 18th century. The first portion (45 vols.) contains about 18,000 words, among which are to be found the greater part of those which occur in the ancient literature, with examples. The second portion (30 vols.) contains about 12,000 words, many of which are of Chinese origin. A third part was promised, but has never been published. The arrangement is according to the 50 sounds, which is a great improvement on the old arrangement according to categories. The *Gagen Shuran* (21 vols., of which only 9 have been printed), by Ishikawa Masamochi, is a dictionary of Japanese words, with multitudinous examples, but few etymologies or explanations. In 1872 the educational department of the mikado's government commenced the publication of a gigantic dictionary, which was to contain all the words in use from the earliest periods down to the present, with examples. Only 5 volumes, containing the words beginning with A, have appeared as yet, and it is feared that the project has been abandoned. The *Wakan Gorui Oetsuyoshii*, in 18 volumes, is an excellent dictionary of Japanese words with their corresponding Chinese characters, arranged first by categories, and then according to the iroha; but it contains neither definitions nor derivations. Owing to the Japanese generally writing their own language with Chinese characters, using the *kana* only for terminations and particles, they have as a general rule been always very ignorant of spelling. The earliest attempt at rectifying the mistakes which were committed by those who used the *kana*, chiefly for writing poetry, was the *Kanamoji-tukai*, by Gioa, founded on the spelling of Teika Kio. A fuller edition of this was published in 1666 by Arakida Moriaki, under the title of *Ruiji Kanadzukai*. Neither of these works is a trustworthy guide. Keichiu (1640-1701) compiled the *Waji Shoransho* (5 vols.), a spelling book, with examples from the *Rikokushii*, *Kujiki*, *Kojiki*, *Manyoshii*, and other classical writings. The *Waji Tsureisho*, in 8 volumes, is an attack on the last named book, by Tachibana Narikazu. The *Kogentoi* (1765), by Katori Nahiko, is an alphabetically arranged list of words showing the correct ancient spelling. It is considered a very good authority on the subject. The *Sion-kana-dzukai*, by Motoōri Norinaga, treats of the proper spelling of the pronunciation of Chinese characters, a subject about which there seems to be much difference of opinion among scholars. The *Kanji Sanonko*, by the same author, discusses

the origin of the *kan-on*, *go-on*, and *to-on*. Hirata Atsutane's *Koshi Honji Kio* (4 vols.) is a most elaborate treatise on the sounds of the Japanese language, and the various kinds of transformation which they undergo. The *Dobun Tsuko* (4 vols.), by Arai Hakuseki, is a valuable work on the origin of Chinese characters and the two *kana*. The *Watoku Yorei*, by Dazai Shuntai, is a similar work. A large number of grammatical works have been the result of the great impulse given to Japanese studies by the revival of learning, chiefly produced since the beginning of the 18th century. Aston's "Grammar of the Written Language" contains a pretty complete list of the more important writings of this class. It may be observed that the efforts of native grammarians do not go beyond the accident of the language.

XII. TOPOGRAPHY. In the year 718 orders were despatched to the governors of all the provinces to give lucky names to the departments and villages, and to record the names of the metals, plants, trees, birds, beasts, fishes, and insects produced in each department; the quality of the land, whether fertile or otherwise; the origin of the names of mountains, rivers, plains, and moors; and the local legends. The last volume was completed in 784. It is a constant subject of regret with Japanese scholars that so much of this great work should have perished, for out of 66 volumes, only the volume on Idzumo and fragments of 44 others have survived the ravages of time and civil war. From this time up to the 16th century the subject seems to have been completely neglected. About 1680 was produced the *Nihon Kokubun Ki*, in 10 books, by an unknown author; it is an account of the productions of each province, with maps. Kaibara Tokushiu compiled a "History of the Province of Chikuzen" (*Chikuzen no Kuni Shoku Fudoki*), in 28 books, and "Travels in various Provinces" (*Shoshuu Meguri*, 7 vols.). Other works of this class are *Yoshii Fushi*, in 10 books, by Kurokawa Doyu, a history of Yamashiro in the Chinese language (1684); *Sanshiu Meisekishi*, by Hakuye, a description of Yamashiro (25 vols., 1702); *Yamashiro Meishoshi*, compiled from 713 works, all of which are quoted literally (30 vols. and 12 maps, 1705); *Yamashiroshi* (9 vols.), *Yamato-shi* (7 vols.), *Kowachishi* (8 vols.), *Idsumishi* (2 vols.), and *Setsumi* (4 vols.), by Nabikawa Nagashi, early in the 18th century; *Yamato Meishkoi* by Hayashi Soyu (15 vols., 1681); *Setsumi Gundan*, a description of Setsumi, by Okada Keishi (17 vols., 1698); *Shinano Kama-kurashi*, by order of the second prince of Mito (12 vols., 1685); *Dankaiishi*, a description of Omi, with local legends, by an unknown author; and the *Shinano Chimeiko*, a history of the province of Shinano, by Yoshizawa Koken (3 vols.). Besides these more serious works, there is a large class of illustrated topographical works of a popular nature, such as the *Tokaido Meishodzuyo*, *Nikkosanishi*, *Kiso Meishodzuyo*, *Yedo Meisho*, *Kioto Meisho*, *Kii Meisho*,

and *Ise Sangu Meishodzuye*, which are in general repute for their accuracy and the excellent wood engravings in which they abound. XIII. LITERATURE OF THE SHINTO RELIGION. The best sources of the study of pure Shinto are the *Kojiki*, the *Nihongi*, and the *Norito*, already mentioned, with the works of Motoōri Norinaga and Hirata Atsutane on the same subject. The *Kojikiden* of the first is a monument of learning and industry; it contains the *Naobi no Mitama*, or "Spirit of Good," a summary of Motoōri's view. This having been attacked by an anonymous author in the *Maga no Hira*, he replied to his antagonist in the *Kuzuhana*, with further developments of his position, namely, that mankind are born with a capacity for distinguishing right from wrong, the test of which is the will of the mikado, and that the Chinese system of morals, which is an invention of immoral men for an immoral age, has corrupted the original perfection of the Japanese heart. The *Kenkō-jin* ("The Madman Fettered") is a polemic against the author of a book called *Shoko Hatsu*, who had maintained that the age of the gods was a barbarous age, and had spoken disparagingly of the mikados. It is a pity that so much acuteness and erudition as Motoōri possessed should have been thrown away in defending views of which the logical effect would be to enslave the whole Japanese nation. His *Jindai Shogo* is the mythological part of the *Kojiki*, with additions from the *Nihongi*, in a mixture of Chinese characters and *kana*, with *kana* at the side, for the use of the young. The *Rekieho Shoshi-kai* is a collection of the speeches and proclamations of the early mikados, with a commentary, which from his point of view are part of the sources of Shinto. Mabuchi had already explained the liturgies in his *Norito-kai* and *Norito-ko*. Hirata Atsutane followed Motoōri's lead with the *Koshi Seibun*, which presents the whole of the mythological books worked up into a continuous and consistent form, and he added a commentary in 100 volumes, entitled *Koshiden*. This work is distinguished by an almost painful elaboration of details, both mythological and philological, but is of great value to the student. In his *Zoku Shinto Taii* (4 vols.) Hirata has given an account of the various sects of corrupt Shintoists, which number 15 or 16. Besides the works of these men, there are certain collections of ancient Shinto books which are still considered orthodox. The earliest is the *Shinto Gobusho*, containing five separate works: 1. *Yamato-hime no Seiki*, said to have been composed in the reign of Temmu Tenno (672-86), and afterward enlarged in that of Tenchi (765-70). This princess was in the year 30 B. C. appointed guardian of the sacred emblems of Tenshokodaijin, with which she travelled about in order to find a location for them. In 4 B. C. she settled down in Ise, and is said to have lived about 400 years after this. 2. *Gochinza Shūdaiki*, an account of the establishment of

the two temples at Ise; date of composition unknown. 3. *Go china Honki*, an account of the establishment of the Geku, ascribed to the reign of Keitei Tenno (507-'31). 4. *Gochiass Denki*, a work similar to the second, said to date from the reign of Yuriaku (457-'79). 5. *Hoki Honki*, an account of the manufacture of the divine emblems, composed in the reign of Shomu Tenno (723-'49). There is a commentary on these five works entitled *Shinto Gobushoshō*, by Okada Masanori (1721). The *Daijin-gu Gishikicho* (804) describes the ceremonial at these two temples throughout the year. The *Tenchi Reiki no Ko*, in 18 books, contains a mixture of Buddhism and Shinto; it is ascribed by some to Shotoku Taishi, by others to Kobo Daishi, who invented what is known as the Riobu Shinto, a harmony of that religion and Buddhism. This work and two others of the same nature, the *Jimbetsuki* and *Tenshoki*, are now asserted to be modern forgeries by Buddhist priests. The *Kogoshiui*, by Imube no Hironari (807), professes to have been written to preserve fragments of ancient traditions which had not been recorded in any of the earlier books; but the author's main object was to prove the descent of his own family from the gods. Nevertheless, the work is of great value, and was largely used by Hirata in compiling the *Koshi Seibun*. The *Fuittsu Shinto Michi Yashū* (2 vols.) is a work designed to prove that Shinto and Buddhism are identical in their essence. The majority of treatises on Shinto prior to the 17th century maintained this view. An exception is the *Genzanis* (8 vols.), by Kitabatake Chikafusa. It treats of the origin of the world, of the coming into existence of the two races of gods, the heavenly and the terrestrial, the creation of Japan, the delivery of the sacred emblems by the sun goddess to her grandson before his descent upon earth, the foundation of the temples of Ise, and other articles of the Shinto faith. The *Nijū-issha Ki* is an account of 21 principal Shinto temples, by Fujiwara no Korechika (Gidosanshi, 973-1010). The *Koro Kojitenden* contains information about the ceremonial at the temples of Ise, the old costumes preserved therein, the messengers of the gods (the fox, crow, common cock, serpents), &c. These two works are also considered good sources of information by rigid Shintoists. The *Shinto Shū* (8 vols.) is one of those now condemned on account of its confusing the two religions; it treats of the origin of Shinto, the gods of Hachiman, Shinto archways (*torii*), &c., and gives a list of the Shinto gods in various provinces who were disguised under Buddhist names. The *Riobu Shinto Kobetsushū*, by Minamoto no Yoshiyasu (6 vols., 1716), is a defence of the sect called Riobu against those who maintain that it is the same as the Fuittsu, the latter being infected with Confucianist doctrines. The *Shinto Mimoku Fujimoku* (6 vols., 1699) is a description of the accessories

of Shinto worship, such as robes and utensils, and the functions of the ministers, by Watarae no Nobuyoshi. The *Honcho Jinjako*, by Hayashi Doshin (6 vols.), contains the names of all the chief Shinto temples and of the gods worshipped therein; it is considered a good authority on these matters. The *Mosoki*, in one volume, describes burial according to Shinto rites. In the *Jiuniku Ron*, Kenko Hoashi has shown that there is no reason why the flesh of wild boars and deer should not be offered up to the gods, and that down to the reign of Seiwa Tenno (858-'76) such meats ordinarily formed part of the mikado's own diet. It was owing to the influence of Buddhism that they came in the middle ages to be looked upon as forbidden food. The *Nakatomi no Harai* is a liturgy ascribed to Tokiwa no O-muraji (middle of the 6th century); but Nobuyoshi and Suiga (the latter of whom has given his name to a separate form of Shinto) assign it to Amenotaneko no Mikoto, a person belonging to the mythological age. However this may be, it seems to have received its present form in the reign of Mommu Tenno (696-707). To Tokiwa no O-muraji is also ascribed the *Rokkon-shajo no Harai*, a work which is repudiated by the pure Shintoists as bearing the distinct traces of Buddhist influence. XIV. BUDDHIST LITERATURE. Buddhism first gained a sure footing in Japan in the reign of the empress Suiko (593-628), and the whole canon has been imported at various times and reprinted. The native works on Buddhism in the Japanese vernacular are not very important. The *Shasekishiu* (10 vols., 1279) is a book on morals by the priest Mujin, in which he endeavors to make his subject more palatable to the vulgar taste by introducing funny stories. This is a general characteristic of Buddhist teaching in Japan. The *Hosshinshiu*, by Kamo no Chomei, is a collection of stories of converts. The *Sambu Kanasho* (7 vols.), by Koa Shonin of the Jodo sect (1265-1345), consists of three works entitled *Kimei Honguansho*, *Saiyosho*, and *Fushi Sokosho*. Most of the Japanese Buddhist literature, of which there is a considerable quantity, is in the Chinese language, and therefore not easily accessible. The *Shingaku Michi no Hanashi*, *Kiuo Dowa*, and *Teshima Dowa* are collections of sermons by priests who belong to a modern eclectic sect, which professes to derive its doctrines from Confucianism, Shinto, and Buddhism. Three of Kiuo's sermons have been translated by A. B. Mitford ("Tales of Old Japan," London, 1871). XV. MODERN FICTION. This is divided into three classes: *keaku bon*, which may be called standard novels; *ninjo bon*, or novels of an erotic cast; and *kusa zoshi*, which are popular romances printed in the hiragana, and form the chief reading of women. The most famous author of the first kind of fiction is Bakin. His works are 20 in number, ranging from 5 to 40 volumes each. Bakin was a man of great learning, and his style is almost classi-

cal. Among the *ninjo bon* the most celebrated are the *Hisa Kurige* (90 vols.), containing the history of the travels of Yajirobei and Kidahachi, and the *Misawo Tsuge no Oguhi* (9 vols.), by Jippensha Ikku; and the *Musume Setsuyo*, which describes the love of Kosan and Kingoro, with its tragical ending, by Kiokusanjin. Riuti Tanehiko wrote the *Inaka Genji* (76 vols.) and *Irohobunko* (45 vols.), belonging to the class of *kusa zoshi*. A short romance by the same author, entitled *Ukiyo Rokumai Biobu*, has been twice translated, into German by A. Pfitzmaier (1840), and into English by S. C. Malan (1871). To the class of *keaku bon* may be added such works as the *Yofu Kogiden* (10 vols.), the *Yehon Chiushingura* (20 vols.), the *Yehon Sangoku Yofuden* (15 vols.), the *Yehon Kankanden* (10 vols.), and the *Honcho Kivushiku Dandzuye* (5 vols.); all of which, though purporting to be founded on historical facts, are in reality pure romances. XVI. MISCELLANEOUS LITERATURE. There are many works which cannot be classed under any of the foregoing categories, and the Japanese therefore mass them together in their library catalogues under this heading. The following are the principal bibliographical works on the native literature: *Honcho Shojaku Mokuroku* (1 vol., 1294); *Nihon Shojakko* (1 vol.), by Hayaashi Doshin, containing notices of 120 works by different authors from the earliest times; *Wakan Shojakko* (5 vols., 1702), by Kojima Soi, a list of Japanese and Chinese books printed in Japan between 1595 and 1702, giving the authors' names, and notices of the contents; *Iengi Sho Mokuroku* (8 vols.), on books with the same title, books with two titles, and those which only exist in manuscript, and containing various other information for the book hunter; *Gorui Shojaku Mokuroku Taizen* (12 vols., 1801), containing lists of books printed in Japan, beginning with those engraved by Muso Kokushi (1275-1851), and ending with the period Meiwa (1764-'7); *Kokucho Shomoku* (8 vols., 1787), containing the titles of books arranged under different headings, partly chronologically and partly according to the *iroha*; *Wakan Gunsho Sakusha Mokuroku* (4 vols.), containing the names of Chinese and Japanese authors and their works, beginning for the latter with the period Yoro (717-'23), and ending with Kuansei (1789-1808); and *Kindai Meika Chojutsu Mokuroku* (1811), containing the works of the most famous authors of the 17th and 18th centuries arranged according to the *iroha*. The *Wakan Sansaidzuye* is a cyclopaedia in 105 books, each of which treats of a separate class of subjects, with an index arranged according to the *iroha*. The *Teijo Zakkai*, in 16 books, is a work of the same nature, arranged in categories, but extending over a narrower field. Being written in the Japanese language, it is more useful to students than the *Sansaidzuye*. The author was Ise Sadatake, and it was published after his

death in 1848. The *Gioku Sekizasshi* (1848), and its supplement (1848), in 20 volumes, by Kurihara Nobumitsu, contain much antiquarian information not to be found elsewhere. The *Shiuko Jisshiu* is a magnificent collection of engravings of antique objects, in 80 folio volumes, arranged under the following headings: copper utensils, seals, inkstones, musical instruments, armor, saddlery, swords, bows and arrows, flags, inscriptions on bells and on tombstones, pictures, and autographs. The *Shincho* (6 vols.), *Monshiu*, *Kanzen Yava* (5 vols.), and *Inaka Chawa* (5 vols.) are collections of modern tales. The *Sozan Chomon Kishiu* is a work on ordinary Japanese superstitions. The *Honcho Rigen* (10 vols., 1714), by Izawa Nagahide, and *Kotowaza-gusa* (7 vols., 1700), by Kaibara Koki, are collections of proverbs and common sayings, with explanations and derivations. The *Wajishi* and *Kanjishi* (6 vols.), by Kaibara Koko (1697), are works of reference for the introduction of inventions, the origin of customs, &c., in Japan and China respectively. The *Zokusetsu-ben* (1715-'22), by Izawa Nagahide, which with its supplements extends to 51 volumes, is a work on popular errors with respect to mikados, princes, nobles, samurai, women, priests, modern times, houses, topography, persons, offices, arts and accomplishments, books, utensils, music, pictures, seasons of the year, Buddhism, plants and trees, animals, fishes, and insects. Most worthy also of notice is the collection of rare books formed by Hanawa Hokiichi (1746-1821), containing 636 separate works in 580 volumes. These consist of works connected with the Shinto religion (28), history of the mikados (15), appointments of officials (16), genealogies (4), biographies (6), offices (5), laws (4), court ceremonies (35), costumes (10), prose (16), letters (8), Japanese poetry (16), romances (13), diaries (7), travels (14), music (12), foot ball (3), hawking (2), games (6), eating and drinking (5), wars (30), history of the military class (25), Buddhism (21), and miscellaneous (84). Hanawa restricted his labors to works of not over three books each. Thirty years were occupied in collating manuscripts and in the engraving of the blocks, which number about 40,000, and the cost was over \$10,000. In addition to the collections already printed, he got together about as many more books, making a total of about 1,300. So great a work was perhaps never achieved before by any private individual, under similar circumstances. He was blind from infancy.—The history of Japanese literature may be divided into four periods. The first will commence far back in the age which preceded the introduction of Chinese literature and writing, and extend down to the end of the 9th century A. D. During this period the only purely Japanese literature consisted of poetry and sacred liturgies, the Chinese language being adopted as the vehicle of all other forms. The beginning of the second period is marked by the preface

to the *Kokinshiu*, and ends with the later romances, extending thus from the early years of the 10th to the end of the 18th century. This is the age of classical prose. The *Tsuratsurugusa*, though composed in the 14th century after earlier models, belongs properly to this period. Up to this time learning was confined to the immediate vicinity of the court. During the 14th, 15th, and 16th centuries the domination of the military class put an effectual stop to its cultivation except by a few priests. This was the dark age of Japan. With the 17th century begins the fourth and modern period of general culture, inaugurated by Iyeyasu, the first of the Tokugawa shoguns, who, after firmly establishing the power of his family, and reducing the other military chiefs to the position of vassals, devoted his later years to collecting manuscripts. Though the art of printing seems to have been introduced in the 13th century, it had not yet been turned to much use, and the rapid multiplication of books by its aid dates from his time. Chinese literature began to be ardently cultivated by a succession of scholars, of whom Hayashi Razan (also called Doshin, 1583-1657) and Ishikawa Jozan (1583-1672) were the earliest. Among their successors the most distinguished were Hayashi Shunasa (1618-'80), Hayashi Shuntoku (1624-'61), Nakaye Tojju (1608-'48), Yamazaki Ansei (1618-'82), who under his other name of Suiga is known as the founder of a separate school of Shinto, Kumazawa Banzan (1619-'91), Ito Jinsai (1627-1705), Nakamura Tekisai (1629-1702), Kaibara Tokushin (1630-1714), Arai Hakuseki (1657-1725), Ogiu Sorai (1666-1728), Miwa Shisai (1669-1744), Ito Toqui (1670-1736), Dazai Shundai (1680-1747), Itatori Nankuaku (1683-1759), Ando Toyu (1683-1719), Yamagata Shiunan (1687-1752), Hirano Kinkua (1688-1732), Usami Junsui (1710-'76), and Rai San'yō (1780-1832). These writers all belong to the class called *juusha*, or Chinese scholars, but they also wrote in the Japanese language. Arai Hakuseki's *Tokuishi-Yoron*, *Toga*, *Gejiriaku*, *Koshi-tsu*, *Seiyo Kibun*, *Sairan Igen*, and *Seiyo Deusetsu*, Sorai's *Seidan* and *Keisiron*, and Dazai's *Keisai-roku*, are all works of great merit in the vernacular. Sorai also did great service by translating Chinese standard works, not the least important of which is the penal code of the Ming dynasty. About the same time the ancient literature of Japan began to be studied with great attention by men who received little countenance and encouragement from the shoguns. The leaders in this movement were the priest Keichiu (1640-1701), Shimokawabe Choriu (1622-'84), and Katsuno Adzumamaro (1669-1736), the last of whom may be fairly regarded as the founder of the modern school of pure Shinto. Keichiu is the first who made any real progress in interpreting the ancient poems of the *Manyōshū*, but he made no original contributions to the literature of his country. To these men succeeded Kamo no Mabuchi, whose commentaries on

the *Manyōshū*, on the *Norito*, and the *Ise Monogatari*, and lexicon of *Makura-kotoba* (entitled *Kuanji-ko*), are most valuable. His original works are the *Niimanabi*, on the study of Japanese literature, and various archæological essays. From his time the study of Shinto and philology went on hand under the name of *koku-gaku*, "national learning," in antithesis to *kan-gaku*, "Chinese learning." Mabuchi's mantle fell on the shoulders of Motoōri Norinaga (1780-1801), whose greatest work is the commentary on the *Kojiki*, already mentioned. His original contributions to literature are: the *Giojiu-gaigen*, against the Chinese philosophy; the *Tama-kushige*, a work on the philosophy of government, written for the prince of Kishiu; the *Uiyama-bumi*, a treatise on the art of study, with special reference to Shinto; the *Tama-arare*, an essay on the faulty composition of common writers; the *Tama no Ogushi*, a critical work on the *Genji Monogatari*; and the *Tama-katsuma*, a collection of miscellaneous papers, which contains some interesting fragments of autobiography. His style is a model of clearness and ease, and shows what the Japanese language might have become if it had not been deformed by the introduction of Chinese words and idioms. That of Mabuchi, on the other hand, though equally correct, is painful on account of his close imitation of the ancient classic literature, which is not a convenient medium for argument. Motoōri was succeeded as the leader of modern Shintoism by Hirata Atsutane (1776-1843), whose principal writings have already been named. His *Shutsu-jo Shōgo* (7 vols.) is an extremely amusing attack upon Buddhism, written in a style closely approaching the colloquial, a style which if it were universally adopted would be an immense relief to the intellectual powers of the Japanese; for the ability to translate thought into the literary style requires years of patient study to acquire, and is a barrier to all freedom of expression. Other writers of the same school as these men are Fujitani Nariakira (1785-'76), Ozawa Koan (1723-1801), Kato Chikage (1734-1808), Tachibana Tsuneki (1704-'62), Murata Harumi (1746-1811), Arakida Hisaoye (1746-1804), Katori Nahiko (1723-'82), Motoōri Haruniwa (1763-1828), Ozaki Masayoshi (1752-1827), Hashimoto Keirio (1760-1806), and Shimidzu Hamaomi (1776-1824). Most of them confined their efforts to poetry, but Fujitani is known as the author of two celebrated works on grammar, the *Ayui-shō* and the *Kazashi-shō*. Motoōri Haruniwa produced the *Kotoba no Yachimata*, a valuable treatise on the Japanese verb. Ozaki Masayoshi is the author of the *Ihiakuninshiu Hitoyo-gatari*, which, besides explanations of the poems in that collection, contains a large number of biographical notices of eminent persons of the second age of literature, written in the very best style.—Of contemporary Japanese literature little is to be said. The 20 years following 1853 have been a period of

political disturbance and of the influx of European ideas; and original composition has been abandoned for translations of foreign elementary works, chiefly on scientific subjects. Translations of such works as Smiles's "Self-Help" and Mill's "Essay on Liberty" have found an immense sale. Together with this rage for foreign books has grown up a corrupt literary dialect, formed on Japanese word-for-word translations of the Chinese, which bids fair to become permanent, in spite of its awkward inelegance.

**JAPAN CLOVER** (*Lespedeza striata*), a plant indigenous to China and Japan, a few specimens of which were noticed by botanists in the southern states before 1860, but which has since spread with such vigor as to kill out Bermuda grass and other plants considered difficult to extirpate. It has received various names, such as "little wild clover" and "Japan pea," but it is most generally known as Japan clover. It



Japan Clover.

belongs to the *hedyaræa*, in a different tribe of the family (*leguminosæ*) from clover. The plant is a perennial, a foot or more high, not very abundantly furnished with trifoliate leaves, in the axils of which are borne single inconspicuous flowers, each of which is followed by a small one-seeded pod. Southern agriculturists differ as to the value of this plant, but as it is liked by stock of all kinds, and will grow in soil too poor to produce any other forage, the weight of testimony is in its favor. It seems to come in almost everywhere without any sowing; and though the old plant is woody and indigestible, the young shoots are readily eaten by cattle.

**JAPANNING**, the process of ornamenting wood, leather, paper, or metal by covering it with a brilliant hard varnish, in which are often introduced gilt or colored designs. The art is supposed to have been acquired from the Japanese, whence its name. It is still practised

by them and the Chinese in great perfection, and specimens of it are seen upon the fancy workboxes, tables, and other small articles of furniture imported from eastern Asia. The articles thus ornamented are first made perfectly smooth, and primed with a mixture of ox gall and rotten stone. Being then again smoothed, they are next covered with a thin coat of varnish, obtained from the juice of certain trees, which, at first appearing like cream, changes by exposure to the air to a deep black. This being dried in the sun or by artificial heat and rubbed, another coat of varnish is applied, and another polishing succeeds; and thus these processes are repeated, it may be 18 times, using toward the last the finest quality of varnish, until a perfectly smooth and brilliant surface is obtained. The ornamental design is then drawn with a pencil dipped in varnish of boiled oil and turpentine, and before this is quite dry the gold or silver leaf is laid upon it, and finally secured by another coat of varnish. The method in use of imitating this lacquered ware does not differ from the preparation of similar works in spirit or oil varnishes, except that every coat of color or varnish is dried by placing the object in a japanner's stove, which is heated by flues to as high a temperature as the articles and varnish can bear without injury. For colored grounds, the colors in ordinary use, as Prussian blue, vermilion, flake white, lampblack, and various others, are employed, well incorporated with linseed oil or turpentine, and mixed with copal or animé varnish, more commonly the latter. For black japanned work, the application is of ivory black mixed with dark-colored animé varnish. After thorough drying in the stove the application is repeated; and if the article is intended to be finally polished, several coatings and dryings are required to give firmness for resisting the friction. After the general color of the ground has been laid on, the ornamental devices are painted in the usual manner, the colors being dried in and finally protected by several coats of varnish, made without drying ingredients, which also adds to their brilliancy. To produce a gold ground, the work is varnished with gold size, upon which, when partially dried, gold dust is laid with a piece of wash leather. Subsequent varnishing gives great brilliancy to this coating. Engravings, especially prepared for the purpose upon fine paper washed with solution of isinglass or gum, are sometimes transferred to japan work with beautiful effect.—It is apparent that wood designed for japanning must be thoroughly dried, so that there shall be no risk of its cracking, shrinking, or warping by the stove heat to which it is to be exposed. After undergoing the usual process of seasoning, it is therefore, when sawn into nearly the shapes required, baked for several days in the japanner's stove; and when after this the finished shapes are given to the articles, they are again baked, and any defects that appear are remedied by the

application of white lead or putty, or otherwise. An artificial ground, prepared by a priming of size and whiting laid on with a brush, and after drying a day or two smoothed down with rushes and a wet cloth, is sometimes employed by japanners; but it is objectionable from its liability to crack. The practice of japanning has been greatly extended of late years to a multiplicity of articles, especially to those in papier maché, sheet iron, and leather. The product of the process applied to the last named material is the so-called patent leather. (See LEATHER.) Besides the introduction of the ordinary colors and of gold leaf, mother-of-pearl is often profusely scattered through the work in the first two materials. A display of gaudy colors appears to be the chief object aimed at; and as works of taste most of the articles of this sort furnished for our markets are far inferior to some of the cheapest productions of the eastern nations.

**JAPETUS**, one of the Titans of Greek mythology, a son of Uranus and Ge, and brother of Cronos (Saturn), Oceanus, Hyperion, Rhea, and others. According to one tradition, he became by Asia, the daughter of Oceanus, father of Atlas, Prometheus, Epimetheus, and Menœtia. According to other traditions, his wife was Cymene, another daughter of Oceanus. Tethys, Asopis, and Libya are also associated with him in the varying forms of the myth. The Greeks regarded Japetus as the progenitor of the human race, through his son Prometheus. His fate in the war with the gods is variously stated. Homer represents him as imprisoned with Cronos in Tartarus; another tradition is that he was buried under the island of Inarime.

**JAPHETH**, one of the three sons of Noah, by most critics regarded as the eldest. It is said of him (Gen. ix. 27): "God shall enlarge Japheth, and he shall dwell in the tents of Shem; and Canaan shall be his servant." He was the progenitor of extensive tribes inhabiting the northern parts of the Mosaic world. His sons (Gen. x. 2) were Gomer, Magog, Madai, Javan, Tubal, Meshech, and Tiras. Gomer is now generally identified with the Cimmericians of the ancients; Magog probably represents Turanian Scythians about the Caucasus; Madai is the Hebrew name for Media; Javan for Ionia and Greece; Tiras probably for Thrace. Meshech and Tubal, who in the Scriptures always appear coupled together, are identified with the equally associated Moschi and Tibareni of the Greeks, and Muscæi and Tuplai of the Assyrian inscriptions (or Muski and Tabali, as Schröder renders the names), the former of whom, according to Rawlinson (Herodotus, book I. essay xi.), "are regarded on very sufficient grounds as the ancestors of the Muscovites, who built Moscow, and who still give name to Russia throughout the East; and these Muscovites have been lately recognized as belonging to the Turkic or Finnish family, which the Slavonic Russians conquered, and which is a known Turanian race." This statement is made still more prob-

able by the Hebrew text of Ezekiel xxxviii. 2, 3, and xxxix. 1, which connects Meshech and Tubal with Rosh; the latter word, rendered "chief" in the English version, being now regarded by Gesenius and others as a proper noun corresponding to the *P&C* of the Byzantine historians, and the people *Rûs* (on the Volga) of the Arabian Ibn Foslan, and thus containing the earliest historical trace of the Russian name. Thus Japheth, as a family name, embraces a large number of primitive nations, in modern ethnology partly designated as Turanian and partly as Indo-European. This agrees with the tradition of the Arabians, which assigns to Japheth 11 sons, progenitors of as many nations, among whom are Jin (the Chinese), Gomari (Cimmerians?), Turk (Turks), Khozar (Khazars), and Ros (Russians). The name Japheth is from a Hebrew root meaning expansion, wide-spreading (Gen. ix. 27). Another derivation, meaning fair, comely, denoting the white-colored races, is less pertinent. It has also been compared with the *Japetus* of Greek mythology. Japhetic is often used by ethnologists instead of Indo-European.

**JAPURA**, or *Caquetá*, a river of South America, rising in the Pasto mountains of Colombia, and flowing generally S. E. to its junction with the Amazon by several mouths, the central one of which is in lat. 3° 20' S., and lon. 65° 40' W., opposite the town of Ega, while the extreme easterly and westerly mouths are 350 m. apart. From lon. 73° 32' it forms the boundary line between Brazil and Ecuador, and from the same point to its principal embouchure is entirely a Brazilian river. The whole length of its course is about 1,000 m. Among its tributaries are the Messai and the Apaporis, both considerable streams. It was explored in 1865 by order of the Brazilian government, and found to be navigable by large vessels as far as the cataract of Santa Cruz, lon. 72° 15', a distance of over 400 m.

**JAPYGLIA**. See *APULIA*.

**JARDIN, Karel dn.** See *DUJARDIN, KAREL*.

**JARNAC**, a town of France, in the department and on the river Charente, 16 m. W. by N. of Angoulême; pop. in 1866, 4,243. It has a small port and an active trade in grain, wine, and brandy. It is renowned for a battle fought here on March 13, 1569, between the Catholics under the duke of Anjou (afterward Henry III.) and the Huguenots under the prince of Condé, in which the latter were defeated and their leader captured and assassinated.—One of the lords of Jarnac, Gui de Chabot, a gentleman of the royal court, acquired notoriety in 1547 by fighting a duel with the permission of Henry II., in which he was about to fall when he gave a sudden thrust to his adversary; whence the expression *coup de Jarnac*. This was the last duel in France fought with the sanction of the king.

**JAROSLAV**. See *YAROSLAV*.

**JARROW**, or *Yarrow*, a town of Durham, England, on the Tyne, 5 m. E. of Newcastle, and

240 N. N. W. of London; pop. in 1871, 18,179, chiefly Irish. It was till within a recent period only a small colliery village, and its rapid growth is due to the establishment of iron ship-building yards, and chemical and other works. There are new docks, a large mechanics' institute, and many schools and places of worship. A famous monastery was established here by St. Benedict Biscop in 681; it was destroyed by William the Conqueror in 1070, but there are still some remains of it. St. Paul's church is renowned for its relics of the Venerable Bede, said to have been buried here.

**JARVES, James Jackson**, an American author, born in Boston, Mass., Aug. 20, 1818. On account of ill health he went to the Hawaiian islands in 1838, was for some years United States consul at Honolulu, where he published the first newspaper ever printed there, called "The Polynesian," and travelled extensively in California, Mexico, and Central America. During a visit to the United States he published a "History of the Hawaiian or Sandwich Islands" (8vo, Boston, 1843), "Scenes and Scenery of the Sandwich Islands" (12mo, 1844), and "Scenes and Scenery in California" (1844). He finally left the Hawaiian islands in 1848, and has for many years resided in Europe, chiefly in Florence, where he was engaged in making the large collection of pictures which was exhibited in this country under his name, and which now forms part of the art gallery of Yale college. Besides the works above mentioned, he has published "Parisian Sights and French Principles" (12mo, New York, 1855; second series, 1856); "Art Hints" (London and New York, 1855); "Italian Sights and Papal Principles" (1856); "Kiana, a Tradition of Hawaii" (1857); "The Art Idea: Sculpture, Painting, and Architecture in America" (1865); "Confessions of an Inquirer" (three parts, 1857-'69); and "Art Thoughts" (1869).

**JARVIS, I. Abraham**, an American bishop, born in Norwalk, Conn., May 5, 1739, died May 3, 1813. He graduated at Yale college in 1761, was ordained deacon in London in February, 1764, and priest a few weeks later. Returning home, he was settled as rector of Christ's church, Middletown, Conn. On the death of Bishop Seabury he was unanimously elected his successor, and in October, 1797, was consecrated at New Haven. **II. Samuel Farner**, an American clergyman, son of the preceding, born in Middletown, Conn., Jan. 20, 1786, died March 26, 1851. He graduated at Yale college in 1805, was admitted to deacon's orders in the Protestant Episcopal church in March, 1810, was ordained priest in April, 1811, took charge of St. Michael's church, Bloomington, N. Y., and in 1813 became rector of St. James's church, which was near by, holding the associate rectorship of those parishes until May, 1819. He was also professor of Biblical criticism in the general theological seminary of the Episcopal church. In 1820 he became rector of St. Paul's church, Boston. In 1826 he resign-



ed his parish, and went to Europe. Returning to the United States in 1835, he was for two years the professor of oriental literature in Washington (now Trinity) college, Hartford, and in 1837 became rector of Christ's church, Middletown. In 1838 he was appointed by the general convention historiographer of the church. He published a "Discourse on the Religion of the Indian Tribes of North America" (8vo, New York, 1820); "Chronological Introduction to the History of the Church" (New York and London, 1844); "Reply to Dr. Milner's End of Controversy" (12mo, New York, 1847); and "The Church of the Redeemed, or the History of the Mediatorial Kingdom" (vol. i., Boston, 1850).

**JARVIS, Edward**, an American physician and statistician, born in Concord, Mass., Jan. 9, 1803. He graduated at Harvard college in 1826, and received the degree of M. D. there in 1830. After practising his profession in several places, he settled in 1843 in Dorchester, Mass., where he now resides. He has obtained distinction by his knowledge and treatment of insanity, but is most widely known for his acquaintance with the statistics of human life. Since 1843 he has published a large amount of valuable matter relating to population, vitality, health, longevity, insanity, education, employments, &c., mostly in the form of addresses, reports, memorials, and articles in periodicals, which if collected would make several octavo volumes. His principal publications are: "Memorial of the Statistical Convention in respect to the Errors of the Sixth Census" (1846); two reports on the "Sanitary Survey of the State of Massachusetts" (1848-'9); "The Production of Vital Force" (1849); "Report of the Legislative Committee on New Hospitals" (1855); "Report on the Insane and Idiots" (1856); "Report of the Committee on the Memorial of the Sanitary Association" (1861); "Report of the Worcester Hospital" (1862-'3); "Report to the United States on the Mortality of the Eighth Census" (1865); "Physiology and the Laws of Health" (1 vol. 12mo, 1865); "Increase of Human Life" (1869); two reports for the United States board of education on the "Relation of Education to Mental Disease" (1872), and the "Relation of Common Education to Common Labor" (1873); "Provision for the Insane" (1872); "Infant Mortality," and two articles in the report of the Massachusetts state board of health (1873); and "Political Economy of Health" (1874).

**JASHER**, *Book of* (Heb. *Sepher hayasher*), a work cited in Joshua x. 13 and 2 Sam. i. 18, but no longer extant. Its contents are known to us only by two short extracts, both in poetic form. The quotation in Josh. x. 13 is a poetic apostrophe to the sun and moon, bidding them stand still in the heavens till the discomfiture of the enemy should be complete. In 2 Sam. i. 19-27 is another quotation, the beautiful elegy of David on Saul and his son. The 18th

verse should be rendered, "also he bade them teach the children of Judah The Bow" (the elegy so named, in allusion to "the bow of Jonathan" in v. 22, a tender reminiscence of the poet's friend); "behold it is written in the book of Jasher." Hence it is very naturally conjectured by Gesenius that it was an anthology of ancient songs written in praise of just men (so esteemed for their patriotic zeal and devotion), and called "Book of the Just." Bishop Lowth had before inferred, from the poetical character of the citations, that it was a collection of national songs. This being all that is known of it, the field is open for the wildest conjectures and the most absurd legends and forgeries; and the following specimens will show that it has not been neglected. Theodoret supposed the whole book of Joshua to be an extract from Jasher; Jerome that it was identical with the book of Genesis, an opinion also expressed, among others, in the Talmud; others, that it included the whole Pentateuch, that it was a treatise on archery, and that it contained a series of biographies of just men, *yasher* meaning just. Dr. Donaldson sees in a portion of the Old Testament narratives a careless elaboration of materials taken from the dismembered book of Jasher, which he attempts to restore to their original order. (See Donaldson, *Jasher, Fragmenta Archetypa Carminum Hebraicorum in Masorathico Veteris Testamenti Textu passim Tessellata* (London, 1854; revised and enlarged, 1860).—A treatise on Jewish laws written by Rabbi Jacob Tam in the 13th century, and printed at Cracow in 1586, bears the title of "Book of Jasher." With this was afterward confounded a later treatise on ethics under the same title, of which there are several editions. Another mediæval work in Hebrew bears the same title, and purports to have been discovered at the destruction of Jerusalem in possession of a concealed old man, brought thence to Spain, and preserved at Seville. It was first printed at Naples, afterward at Venice (1685), at Cracow (1628), and at Prague (1668). It contains the histories of the Pentateuch, Joshua, and Judges, intermixed with many legendary statements, taken from the Talmud, Midrash, Josipon, and other sources. A German translation, with additions, was published at Frankfurt in 1674; and an English translation, under the direction of Mordecai M. Noah, at New York in 1840. In 1751 Jacob Ilive, a Bristol type founder, published a forgery entitled "The Book of Jasher, with Testimonies and Notes Explanatory of the Text; to which is prefixed Various Readings; translated into English by Alcuin of Britain, who went a pilgrimage into the Holy Land." This clumsy fraud was revived at Bristol, 1827, and at London, 1833, edited by C. R. Bond.—An article on "The Book of Jasher" is among the "Literary Remains of the late Emanuel Deutsch" (New York, 1874).

**JASMIN**, Jacques, a French Provençal poet, often called the barber poet and the last of the

troubadours, born in Agen, March 6, 1798, died there, Oct. 4, 1864. He was the child of a hunch-backed tailor and a lame mother, from whom he inherited little besides poverty, and the prediction, founded on the experience of many generations, that the Jasmins must inevitably die in the almshouse. His childhood, the events of which are described in his piece entitled *Mous soubenis* ("My Souvenirs"), was one of privation and hunger; but these he might have endured with cheerfulness, of which he possessed an unailing supply, had he not been tormented with an eager thirst for education. At about the age of 12 he gained admittance to a priests' seminary, where for 2½ years he made rapid progress, until an act of youthful indiscretion caused his dismissal in disgrace. A few months later he was apprenticed to a barber and hair dresser in Agen. At 18 he was married and set up in business for himself. His leisure hours continued to be devoted to the acquisition of knowledge; and from reading plays and romances he took to verse writing, which so alarmed his wife that she persistently removed his pens and paper, and otherwise hindered him. Jasmin obeyed the hint so far as to stick to his calling, which he steadily practised; but no discouragement could induce him to give up his passion for reading and writing verses; and gradually his rural songs, written in an idiom of the *langue d'oc*, the former tongue of the southern troubadours, which is still spoken by the peasantry of southern France, found warm admirers among his friends and neighbors. In 1825 he ventured upon the publication of a burlesque poem, *Lou chalibari* ("The Charivari"). During the next ten years he produced his "Ode to Charity" (1830), "The Third of May" (1830), *Soubenis* (1832), and "Stanzas to the Scattered Remains of the Polish Nation" (1833). These were collected in 1835 and published in 2 vols. under the title of *Las papillotos de Jasmin* ("The Curl Papers of Jasmin"). His next piece, *L'Abu-glo de Castel-Cuillé* ("The Blind Girl of Castel Cuillé"), founded on a pathetic legend of Guienne, is perhaps the most popular of all he wrote. During his only visit to Paris he recited it 26 times in 15 days, on the last occasion in presence of Louis Philippe and the royal family at Neuilly. The poem is familiar to English readers through the translation by Longfellow. *Françonette*, produced in 1840, is his longest and most ambitious piece. Among his remaining works are a second series of the *Papillotos* (1843), *Lous dus frays bessous* ("The Two Twin Brothers," 1847), *Maltro l'innoucento* ("Mad Martha"), and many minor pieces.

**JASMINE**, or *Jessamine*. I. The name of shrubs, sometimes twining, of the genus *jasminum*, which with three other genera some botanists place in the order *jasminaceæ*, while others regard it as belonging to the olive family. The species are all natives of warm countries; they have compound leaves, which are sometimes reduced to a single leaflet and appear simple; the

axillary or terminal, yellow or white flowers have a tubular corolla with a spreading limb, two stamens, and a two-lobed ovary; the fruit is berry-like. The flowers of most species are deliciously fragrant, and the plants are favorites in the greenhouse, and where the climate



*Jasminum officinale*.

will allow are cultivated in the open air. The best known species is the common jasmine (*J. officinale*), which was introduced into England from the East in 1548, and is there cultivated for covering walls and arbors. It cannot be considered as properly hardy in the climate of New York, though in some sheltered situations it lasts for several years. It has become thoroughly naturalized in the south of Europe, and is also cultivated there for the sake of its perfume, which is obtained by stratifying the flowers with cotton impregnated with bene oil (*sesamum*), and allowing them to remain in a closed vessel for 24 hours; the flowers are then removed and replaced by fresh ones, and the process repeated until the oil is strongly impregnated with the odor; the oil is removed from the cotton by pressure, and is used to perfume pomades; when the oil is treated with alcohol that takes up the odor of the flowers, it forms the essence of jasmine. Perhaps the hardiest species is *J. nudiflorum*, which has yellow flowers, appearing very early in spring, but they are without odor; *J. odoratissimum* has also yellow flowers, and is one of the most fragrant; the same may be said of *J. revolutum*. One of the finest greenhouse species is *J. grandiflorum*, which is in Europe known as the Malabar, and by American florists as the Catalonian jasmine; its long weak stems allow it to be trained upon frames or trellises, and it produces its exceedingly fragrant flowers, which are tinged with pink on the outside, in clusters of two or three. The sambac (*J. sambac*), an East Indian species, is a fine shrub for a warm greenhouse; it has leaves of a single leaflet, and large flowers in small clusters, which are

very fragrant, especially in the evening; there are several florists' varieties of this species, some of which have double flowers, and are much prized by bouquet makers. The leaves of *J. floribundum* are exceedingly bitter, and are used in Abyssinia to destroy the tapeworm. The jasmines are multiplied by means of cuttings in the same manner as other greenhouse shrubs. **II. Cape Jasmine**, a popular name for plants of the genus *Gardenia*, not related to the true jasmines. This genus belongs to the madder family (*rubiaceæ*), and consists of tropical and subtropical shrubs. The cultivated species have large terminal and very fragrant white flowers. The genus was dedicated by Ellis to Dr. Alexander Garden of Charleston, S. C., who commenced in 1755 a correspondence with Linnæus and other European botanists, and did much to make American plants known to science. The best known spe-



Cape Jasmine.

cies is *G. florida*, which does not come from the Cape, but was introduced into England from China in 1754. The double variety is the one most generally cultivated, and is a popular greenhouse plant; it also succeeds in window cultivation; in the southern states it is hardy, and is used for the decoration of cemeteries, dooryards, and the like. The fruit is a large, oblong, orange-colored berry, which is said to be used in China for dyeing yellow. A smaller species, *G. radicans*, is also cultivated, and there are forms of both with variegated leaves. Those who have no greenhouse can enjoy the Cape jasmine by treating it as a bedding plant, allowing it to grow in the open border during summer, and removing it to a dry frost-proof cellar for the winter. **III. Carolina or Yellow Jasmine**, a climbing vine, found from Virginia southward, where it grows in great profusion, festooning the trees and shrubs, and in spring covered with funnel-shaped bright yellow flowers, about an inch across, which have a fra-

grance similar to that of the true jasmine; when the plant is abundant the odor is almost overpowering. It is the *gelaemium sempervirens*, of the family *Loganiaceæ*, and not closely related botanically to the jasmine. The shining leaves are very nearly evergreen, and make the plant an attractive one when not in flower. Within a few years this plant has come into use as a remedial agent, the root having been accidentally discovered to possess remarkable sedative powers.

**JASPER.** See ARGONAUTS.

**JASPER**, a variety of the quartz family occurring in the form of rocky masses, which often make up the greater portion of hills of considerable size. It is of various shades of red, yellow, brown, and green, the colors sometimes arranged in stripes, when it is called ribbon jasper. The hues are derived mostly from iron in different degrees of oxidation, and the stripes are sometimes found to be the marks of former stratification of the rock, which are retained in the metamorphic product, and sometimes presented in a brecciated appearance resulting from the forcible breaking up of the strata. From the extreme hardness of the stone and its susceptibility of taking a high polish, it is much used for ornamental purposes, having similar applications to porphyry. Bloodstone or heliotrope is a deep green variety of quartz with blood-red spots of jasper sprinkled through its mass. Lydian stone or touchstone is a velvet-black, flinty variety, used for testing the purity of alloys of gold. The alloy is rubbed upon the stone so as to leave upon it a metallic streak, and the quality is estimated by the color produced on applying nitric acid. The fitness of the stone for this use arises from its easily abrading the metal, not being itself affected by the acid, and presenting a dark smooth ground best adapted for exhibiting shades of color. Jasper was highly prized by the ancients and was much used for cameos. It was the twelfth stone in the breastplate of the high priest, according to the English version of the Old Testament, and is frequently referred to in the Apocalypse in describing the New Jerusalem. Mr. Atkinson, in his work on "Oriental and Western Siberia," speaks of the jasper in the upper valleys of the Ural, and found himself some beautiful specimens of it in a ravine on the banks of the river Irtysh, some of the rocks there being jasper of a dark reddish brown and others of a deep purple. He observed blocks of a beautiful green jasper on the banks of the Mein, in the neighborhood of the Tcherny (Black) Beryl, and in several other localities: also jasper of a deep red color in the valley of the Eremil. The principal deposit of jasper is the gorge of the Korgon. The labor of cutting out the large blocks is enormous; the workmen drill holes five inches apart the whole length of the block, and to the depth required; into these they drive dry birch-wood pins, which they keep wet till they swell and burst off the mass. The workmen arrive at the Korgon in

May, and remain there until September, when they return to their homes, some of which are at a distance of 400 to 500 m. Small stone huts are built against the precipices at the bottom of the ravine, where they live, stowed away in filth and wretchedness, feeding upon black bread and salt, and receiving the lowest of wages. Several cases of this jasper were exhibited in the London crystal palace in 1851, and a medal was awarded to them. The most beautiful variety of jasper is the Egyptian pebble, found where its name indicates, in small translucent nodules of olive brown with darker markings, and ranked among the lesser gems.

**JASPER**, the name of seven counties in the United States. **I.** A central county of Georgia, bounded W. by the Ocmulgee river; area, 480 sq. m.; pop. in 1870, 10,439, of whom 6,555 were colored. The surface is uneven and the soil moderately fertile. Gold, iron, granite, jasper, and garnets are found in the county. The chief productions in 1870 were 22,274 bushels of wheat, 185,870 of Indian corn, 15,543 of sweet potatoes, 79,099 lbs. of butter, and 5,937 bales of cotton. There were 977 horses, 1,091 mules and asses, 1,729 milch cows, 2,800 other cattle, 1,885 sheep, and 8,196 swine; 4 carriage factories, and 3 saw mills. Capital, Monticello. **II.** A S. E. county of Mississippi, drained by affluents of Leaf river; area, 650 sq. m.; pop. in 1870, 10,884, of whom 4,898 were colored. The surface is uneven and the soil fertile. The chief productions in 1870 were 255,858 bushels of Indian corn, 42,225 of sweet potatoes, 48,814 lbs. of butter, and 4,278 bales of cotton. There were 1,704 horses, 841 mules and asses, 3,621 milch cows, 1,335 working oxen, 5,034 other cattle, 4,104 sheep, and 18,418 swine. Capital, Paulding. **III.** A S. E. county of Texas, bounded W. by the Neches and Angelina rivers, here navigable by steamboats; area, 918 sq. m.; pop. in 1870, 4,218, of whom 1,759 were colored. The surface is undulating and hilly and well timbered. The soil is thin, but in the neighborhood of the streams very fertile; a large part of it is devoted to pasturage. The chief productions in 1870 were 90,377 bushels of Indian corn, 25,559 of sweet potatoes, 1,928 bales of cotton, 10,998 lbs. of tobacco, and 6,850 of rice. There were 884 horses, 2,088 milch cows, 7,832 other cattle, 2,173 sheep, and 10,775 swine. Capital, Jasper. **IV.** A N. W. county of Indiana, bounded N. by Kankakee river, and drained by the Iroquois; area, about 675 sq. m.; pop. in 1870, 6,354. The surface is mostly a level prairie, diversified with tracts of timber, and composed partly of the Kankakee marshes or wet prairies. The soil is suitable for pasturage. The chief productions in 1870 were 31,711 bushels of wheat, 111,882 of Indian corn, 79,606 of oats, 20,673 of potatoes, 22,928 lbs. of wool, 126,132 of butter, and 23,129 tons of hay. There were 8,119 horses, 3,192 milch cows, 11,272 other cattle, 7,038 sheep, and 5,078 swine. Capital, Rensselaer. **V.** A S. E.

county of Illinois, intersected by Embarras river; area, 494 sq. m.; pop. in 1870, 11,284. It has a level and in some places marshy surface, about two thirds of which is occupied by prairies. Much of the soil is fertile. The St. Louis, Vandalia, Terre Haute, and Indianapolis railroad touches the N. W. corner. The chief productions in 1870 were 87,808 bushels of wheat, 461,345 of Indian corn, 149,214 of oats, 21,755 of potatoes, 43,465 lbs. of wool, and 10,789 tons of hay. There were 4,170 horses, 2,946 milch cows, 5,178 other cattle, 17,850 sheep, and 12,508 swine. Capital, Newton. **VI.** A S. E. central county of Iowa, traversed by Skunk river and the N. fork of that stream; area, 720 sq. m.; pop. in 1870, 22,116. It has an undulating surface, occupied in great part by fertile prairies, thinly timbered. Coal is abundant. The Chicago, Rock Island, and Pacific and the Des Moines Valley railroads cross it. The chief productions in 1870 were 773,429 bushels of wheat, 2,102,366 of Indian corn, 270,631 of oats, 185,786 of potatoes, 570,285 lbs. of butter, 40,865 of wool, and 28,454 tons of hay. There were 8,506 horses, 6,658 milch cows, 10,244 other cattle, 15,886 sheep, and 31,268 swine; 12 manufactories of carriages, 4 of furniture, 1 of machinery, 11 of saddlery and harness, 3 flour mills, and 7 saw mills. Capital, Newton. **VII.** A S. W. county of Missouri, bordering on Kansas, and drained by Spring river; area, about 550 sq. m.; pop. in 1870, 14,928, of whom 138 were colored. It has an undulating surface and a good soil. The chief productions in 1870 were 87,658 bushels of wheat, 528,591 of Indian corn, 183,016 of oats, 38,418 of potatoes, 38,753 lbs. of wool, 209,967 of butter, and 11,054 tons of hay. There were 4,795 horses, 3,429 milch cows, 7,927 other cattle, 11,444 sheep, and 14,249 swine; 2 manufactories of saddlery and harness, 3 of tin, copper, and sheet-iron ware, 1 of pig lead, and 5 saw mills. Capital, Carthage.

**JASPER, William**, an American revolutionary soldier, born in South Carolina about 1750, killed at the assault on Savannah, Oct. 9, 1779. At the commencement of the revolution he enlisted in the 2d South Carolina regiment, in which he became a sergeant. In the attack upon Fort Moultrie by a British fleet, June 28, 1776, he distinguished himself by leaping through an embrasure to the ground, under a shower of cannon balls, and recovering the flag of South Carolina, which had been shot off. On this occasion Gov. Rutledge presented him with his own sword, and offered him a lieutenant's commission; this, however, Jasper, who could scarcely read or write, refused, saying, "I am not fit to keep officers' company; I am but a sergeant." His commander, Col. Moultrie, appreciating his bravery and coolness, gave him a roving commission to scour the country with a few men, and surprise and capture the enemy's outposts. His achievements in this capacity equal any recorded in the revolutionary annals. Prominent among them was

the rescue by himself and a single comrade of some American captives from a party of British soldiers, whom he overpowered and made prisoners. At the assault upon Savannah he was in the column which under D'Estaing and Lincoln attacked the Spring Hill redoubt, and received his death wound while fastening to the parapet the standard which had been presented to his regiment by Mrs. Elliott. His hold, however, never relaxed, and he bore the colors to a place of safety before he died. His last words were: "Tell Mrs. Elliott I lost my life supporting the colors she presented to our regiment." A county of Georgia and a square in Savannah have been named after him.

**JASSY**, or *Yassy* (Roum. *Yash*), a town of Roumania, capital of Moldavia, on the Bakhlui, a tributary of the Pruth, 205 m. N. N. E. of Bucharest; pop. about 90,000, of whom 35,000 are Jews. It is built partly on a hill and partly in a valley; and as many of the houses are surrounded by gardens, it covers a comparatively large space. It has few spacious streets, but a great number of churches and convents, among the more remarkable of which are the metropolitan church of St. Nicholas, the churches of Sokolla and Galata, and the convent of Trisveletch, containing the tombs of the archbishops. There are also several palaces belonging to distinguished boyar families, and in the vicinity of the city the princely summer residence Copola attracts the attention of travellers. It is the seat of a Greek metropolitan, and has a university, a theological seminary, a lyceum, schools of art and music, about 70 Greek churches, a Catholic, an Armenian, and a Protestant church, a magnificent hospital, a large bazaar, and public baths. The trade of the city is in great part in the hands of the Jews. The manufactures are limited, but the trade is important, and a large business is done in the public fairs. The place was materially injured by the Russo-Turkish war of 1853-'6, but since the consolidation of Roumania (1861) has revived and is now flourishing.—Jassy is the Jassiorum Municipium of the Romans, so called from the Jassii, a people of Dacia. Trajan built here a residence, which was destroyed by fire in the last century. Conflagrations frequently visit the city; one of the most disastrous happened in 1822, and another in 1843 destroyed a large number of the wooden houses. A peace was concluded here in 1792 between the Russians and Turks. In the wars of these nations, including the last, Jassy was often the headquarters of the contending armies. In April, 1866, on the election of Prince Charles of Hohenzollern to the throne of Roumania, Jassy was the scene of an insurrection, which was soon suppressed.

**JÁSZBERÉNY**, a town of Hungary, capital of the united districts of Jazygia and Cumania, on the Zagya, 38 m. N. E. of Pesth; pop. in 1870, 20,233. It is pleasantly situated, and the islands formed by the river in the middle of the town have been converted into promenades. Attila is popularly believed to have been buried

in a fort of which there are remains in the public square. The most conspicuous public buildings are a fine Catholic church and gymnasium, and a Protestant church. Much wine is produced in this vicinity, which also contains extensive stone quarries; and horses, cattle, and sheep are reared in great numbers.

**JATS**, or *Jants*, a race inhabiting India, principally the N. W. portion, between the Indus and Ganges. They have been variously regarded as descendants of the Getæ, Dacians, Saccæ, Indo-Scythians, Yuechi, Avars, Huns, and many other lost races. They are to all appearance a northern race whose advent is more recent than that of the Rajpoots. They are tall, strong, and active, good tillers of the soil, and if need be good fighters. They form perhaps the finest rural population of India. The Jats of the southern part of the Bari Doab, near Lahore, and of the Malwa district are mostly Sikhs; but perhaps not one third of the whole population between the Jhylum and Jumna have as yet embraced the tenets of Nanak and Govind (see **SIKHS**), and the other two thirds are about equally divided between Mohammedanism and Brahmanism. Capt. Burton mentions that a wandering predatory tribe bearing the name of Jats are found about Candahar, Herat, and Meshed. The Jats of the lower Indus appear to be of the same race as the Brahooes of Afghanistan. (See **IRASIAN RACES**, and **INDIA, RACES AND LANGUAGES OF**.)

**JACBERT**, Pierre Amédée Émile Fréha, a French orientalist, born in Aix, June 3, 1773, died in Paris, Jan. 28, 1847. A graduate of the school for the oriental languages, he was in 1798 appointed assistant interpreter in the French expedition to Egypt. After the 18th Brumaire he was appointed secretary interpreter of the government, and professor of the Turkish language in the oriental school in Paris. After other official journeys in the East, he started in 1805 on a mission to Persia, was stopped on his way by the pasha of Bajazid, who wanted to appropriate the splendid presents sent to the shah, and was for nearly four months incarcerated in a cistern. Having finally accomplished his mission, Napoleon granted him a pension and several offices and honorary rewards, and shortly before his fall appointed him chargé d'affaires to Constantinople. In 1818 he travelled again through the East, and brought to France a herd of the Thibetan goats whose hair is used in the manufacture of shawls. He was made a member of the academy of inscriptions in 1830, and under Louis Philippe became a peer, professor of the Persian language at the collège de France, and director of the oriental school. His most important publications are: *Voyage en Arménie et en Perse* (8vo, Paris, 1821); *Éléments de la grammaire turque* (4to, 1823); and a French translation of Edrisi's Arabian geography (3 vols. 4to, 1836-'40).

**JAUER**, a town of Prussia, in the province of Silesia, on the Wäthende Neisse, an affluent of

the Katzbach, and on the Schweidnitz and Liegnitz railway, 12 m. S. S. E. of Liegnitz; pop. in 1871, 9,964. It has a Protestant gymnasium, a hospital, and manufactories of leather, buckskin, and carpets. From 1814 to 1892 it was the capital of a principality of Jauer, which had an area of 1,200 sq. m., and contained the present circles of Jauer, Bunzlau, Löwenberg, Hirschberg, and Schönau.

**JAUJA**, an inland town of Peru, in the department of Junin, 108 m. E. by N. of Lima; pop. about 15,000. It is delightfully situated in the valley and near the left bank of a river of the same name, which, afterward known as the Mantaro, is one of the principal branches of the Apurimac. The town has a fine cavalry barrack and several churches and schools, and in the vicinity are numerous weaving factories. The chief commerce is in horses of excellent breed and horned cattle. In the district of Jauja are the celebrated missionary convent of Ocapa and ruins of ancient Indian towns and castles. The climate, though somewhat cold, is very salubrious. This is one of the most ancient towns in Peru, and was the capital of the viceroyalty until Jan. 18, 1535.

**JAUNDICE** (Fr. *jaunisse*, from *jaune*, yellow), a morbid affection known by the yellowness of the eyes, skin, and urine, the color of the skin sometimes becoming yellowish green or brown, the stools being usually whitish, and the course of the bile obstructed. Epidemics of jaundice have been observed, especially during and after military campaigns, during sieges, &c.; and the disease is sometimes endemic, as in damp localities exposed to high temperatures. The attack is usually preceded by symptoms of disorder of the liver and digestive organs, such as loss of appetite, irregular bowels or constipation, colic pains, nausea, headache, languor; uneasiness in the region of the stomach and liver; thirst, unpleasant taste in the mouth, tongue loaded at the base; feeling of sinking, &c. Sooner or later the yellowness of surface appears; sometimes this is the first symptom, and it usually takes in order the eyes, the face, neck, chest, and then the whole body. At first a light yellow, it deepens to a golden or orange hue, sometimes greenish. The color may appear in parts of the surface only, in a palsied side, the face, or a single eye; or while yellow in some parts, it may be green or almost black in others, constituting what is known as the black jaundice. The yellow tinge of visible objects, showing that the coloring matter has diffused itself through the humors of the eye, undoubtedly occurs, but is somewhat rare. The perspiration is yellowish. Fever, with quick or hard and full pulse, appears in cases of active congestion or inflammation of the liver; in others the pulse may be natural or irregular. From the time of the appearance of the yellow hue, however, many of the preliminary symptoms may diminish. The attack is often sudden; when following violent emotion, almost instantaneous. The course

and duration are various, the disease disappearing or proving fatal as early as the fourth day, or lasting for months or years. The darker forms are most rapid and oftenest fatal. Favorable crises occur in the form of bilious diarrhoea, profuse perspiration, hæmorrhage, or menorrhagia; or improvement begins more quietly, the color fading from the surface in the reverse order of its appearance. Jaundice, properly speaking, can hardly be called a disease. It is rather a symptom, the yellow color of the skin and excretions depending simply upon the retention in the circulation of the yellow coloring matter of the bile. Hence it may be a very serious or a trifling affection, according to the nature of the causes which give rise to it. When the coloring matter of the bile alone is retained in the circulation or reabsorbed from the liver, but little injury results, and a patient deeply tinged with the color of jaundice from this cause may still be able to walk about and attend to his ordinary business without much discomfort. On the other hand, when all the ingredients of the bile, or the substances from which they are formed, accumulate in the circulation owing to a suspension of the physiological action of the liver or intestines, the disease becomes one of great gravity, and is usually fatal if not relieved within a period of about ten days. Death is generally preceded in these cases, as in those of poisoning by urea from suspended action of the kidneys, by signs of disorder in the nervous system, and at last by a condition of coma or profound insensibility. Attacks of jaundice belonging to the former class often pass off without any other treatment than a mild laxative and judicious regimen; those of the second class often pass on to a fatal termination notwithstanding the use of the most active remedies.

**JAVA**, an island of the Indian archipelago, the most important colonial possession of the Netherlands in the East Indies, and the most fertile and prosperous tropical island in the world, situated between lat. 5° 52' and 8° 46' S., and lon. 105° 11' and 114° 33' E. It is bounded N. by the sea of Java, which separates it from Borneo; E. by a strait 2 m. wide, which separates it from the island of Bali; S. by the Indian ocean; and W. by the strait of Sunda, which separates it from Sumatra. Its length from E. to W. is 666 m., and its breadth varies from 56 to 135½ m.; area, 49,197 sq. m., or including the adjacent island of Madura, 51,336 sq. m. It is the fourth island of the archipelago in point of size, being exceeded in area by Borneo, Sumatra, and Celebes. The coast line of Java is about 1,600 m. in extent, and is remarkably destitute of harbors, especially on the S. side, where there are but two ports, Pachitan and Chalachap. On the N. coast the chief harbors are those of Batavia and Surabaya, but there are many open roadsteads with good anchorage, and the want of landlocked harbors is little felt in the calm waters of the

Java sea, where hurricanes are unknown, and storms occur only at the change of the monsoons. On the S. side there is no safe anchorage, the coast being bold and the ocean very deep, while a heavy and dangerous surf rolls continually on the shore.—The geological formation of Java is highly volcanic. A range of mountains runs from one end of the island to the other through the centre, with peaks varying in height from 4,000 to 12,000 ft. The highest is Semiru, 12,235 ft.; Slamut is 11,329 ft.; six other peaks are each over 10,000 ft. high, six others over 9,000 ft., and ten others from 5,000 to 9,000 ft. Among these peaks are 38 volcanoes, some of which are in constant activity. The most remarkable of these is in the Tenger, "wide" or "spacious" mountains, in the E. part of the island. It rises from a very large base in a gentle slope with gradually extending ridges. The summit, seen from a distance, appears less conical than that of the other volcanoes, and is about 8,000 ft. high. The crater is more than 1,000 ft. below the highest point of the mountain. It is the largest crater on the globe, with perhaps the single exception of that of Kilauea in the Hawaiian islands. The shape of the crater is an irregular ellipse with a minor axis of  $3\frac{1}{2}$  and a major axis of  $4\frac{1}{2}$  miles, and it forms an immense gulf with a level bottom covered with sand, which the Javanese call Laut Pasar, or "sandy sea." From its centre rise three cones several hundred feet in height, one of which, called Brahma, is in almost constant activity. South of the great central range is another range of mountains from 3,000 to 8,000 ft. in height, which skirts the S. coast. It is composed of volcanic materials, chiefly basalt, and is called by the Javanese Kandang, or "war drums," from the peculiar columnar form of its rocks. The volcano Papandayang in this range threw out in a single night, in 1772, ashes and scorise spreading over an area of 7 m. radius a layer 50 ft. thick, destroying 40 native villages and 8,000 people. On July 8, 1822, the volcano Galungzong, a few miles N. E. of Papandayang, destroyed everything within a radius of 20 m. Five days later a second eruption followed, and the total loss of life in both was 20,000 persons. The S. shore of the island is in many places bounded by steep piles of trap. Low ranges of limestone occur in the eastern part, and in the extreme west a few granite boulders are occasionally found. Hot springs are numerous at the bases of the volcanoes, and some of them are impregnated with carbonic acid. In the lowlands there are mud volcanoes, which furnish muriate of soda. The principal elevated plains of Java are those known as Solo and Kediri, which comprise the central districts, and in the west that of Bandong. These plains are fertile and well watered by streams from the mountains, which afford an abundant supply for irrigation. There is also a long alluvial tract running along the N. side of the island, which may be

regarded as a continuous plain, and many of the mountain valleys are also spacious and fertile.—There are a few small and beautiful lakes among the mountains, and some extensive marshes, which in the rainy season become lakes, and are navigated. The largest of these is in the province of Banyumas, and is close to the S. shore. The island, however, is abundantly watered. The rivers on the N. side are very numerous, but are none of them navigable for large vessels, being all more or less obstructed by bars of mud or sand at their mouths. They are, however, of great use for irrigation, and contribute largely to the immense agricultural capacity of the island. The largest river in Java is the Solo, which rises in one of the low ranges on the S. side of the island, and after a winding course of 256 m. empties by two mouths into the narrow strait which separates Java from the W. end of the island of Madura. This river is navigable all the year by small boats, and by large ones in all the months except August, September, and October. The second river in size is called by the natives the Brantas, but is known to Europeans as the river of Surabaya. It rises like the Solo in the low southern range of mountains, receives many affluents, and empties by five mouths into the Madura strait, after passing by the city of Surabaya and contributing to form its harbor.—The seasons in Java are divided into the wet season, which begins with October and ends with March, and during which westerly winds prevail, and the dry, which includes the rest of the year, and is characterized by easterly winds and fair weather. These periodical winds, the N. W. and S. E. monsoons respectively, set in somewhat irregularly, and even during their prevalence there is sometimes dry weather in the wet season and wet weather in the dry. At the equinoxes the weather is generally tempestuous, and thunder storms at that period are frequent and sometimes destructive. The temperature of the island is equable, the thermometer in the lowlands seldom rising above 90° or falling below 70°. Snow never falls even on the highest mountain peaks, but in the coldest weather ice a few lines thick is sometimes seen at great elevations, where the thermometer falls to 37°. At the height of 4,000 ft. in the mountain valleys there is a delightful climate, healthful to the European constitution, and favorable to the growth of northern fruits and vegetables. The general climate of the island is in point of salubrity equal to that of any tropical country; and in places where malaria formerly prevailed, as in Batavia and Cheribon, the evil has been clearly traced to the neglect of water-courses, and has been ameliorated by proper attention to drainage.—The metals found in Java are inconsiderable in quantity and value, and no veins are worked. The uncultivated portions of the island, with the exception of a few small tracts and shore districts, are covered with forest, and at all seasons a luxuriant ve-

dure overspreads nearly the whole land. The chief variety in the vegetation is caused by differences of elevation. On the low coast are found cocoanut palms, bananas, *aroides*, *amaranthaceae*, poisonous *euphorbiaceae*, and leguminous plants. At the height of 1,000 ft. ferns preponderate and magnificent forests of slender bamboos grow spontaneously. At a greater height are forests of fig trees, with tall trunks, spreading branches, and thick foliage; and the ferns here increase in number and size, and often grow to the height of several feet. Above the region of fig trees is that of oaks and laurels, with abundant melastomas and orchidaceous plants. At the height of 6,000 ft. the tropical character of the vegetation disappears, and is succeeded by *rubiaceae*, heaths, conifers, and a vegetation closely allied to that of the temperate zone. Cryptogamous plants are extensively multiplied; mushrooms are abundant, and mosses and lichens cover the ground.—The animal life of Java is as varied and abundant as its vegetation. Among the 100 species of mammals enumerated as inhabiting the island are nine species of quadrupeds, the Bengal tiger, leopards, a peculiar species of rhinoceros (*R. Sondaicus*), the wild ox (*Bos Sondaicus*), the wild hog, several species of deer, and 23 species of bats. Among the domestic animals are the ox, the buffalo, the horse, the goat, and a few sheep. Of birds there are known to be upward of 170 distinct species, among which are the peacock, the green jungle cock, partridges, quail, and many species of pigeons and herons. There are but two species of Javan parrots. Birds of prey are numerous, including falcons, owls, and carrion crows. Serpents are frequently met with, and more than 20 species are regarded as venomous. Other reptiles of common occurrence are crocodiles, lizards, the green frog, the toad, and the land tortoise. Sea turtles are found in the waters adjacent to the island. Fish are plentiful along the coast, but those of the rivers are of inferior quality as food.—Though in reality Java is wholly possessed by the Dutch, two native kingdoms, comprising together not more than  $\frac{1}{4}$  of the island, have been suffered to retain a nominal existence, under the control of the Dutch officials. These are the dominions of the *sewaan* or emperor of Surakarta, and the sultan of Jokakarta. The rest of the island, with Madura, is divided into 23 provinces, called residencies. The principal cities are Batavia, the capital, Bantam, Buitenzorg, Cheribon, Samarang, Surabaya, Surakarta, and Jokakarta. The native population of Java comprises two distinct nations, the Sundese and the Javanese. The Sundese occupy the western end of the island, and are greatly inferior in number to the Javanese, as well as less advanced in civilization. They speak a distinct language, the Sundese, while nine tenths of the entire native population speak Javanese. Both classes are of the Malayan race. They are generally about two inches shorter than the men of the

Mongolian and Caucasian races, with round faces, wide mouths, high cheek bones, short and small noses, and small, black, deep-seated eyes. The complexion is brown with a shade of yellow, and is never black. The hair of the head is thick, black, lank, and harsh, and is either scanty or altogether wanting on other parts of the body. A few short, straggling hairs compose the beard. The natives are not active, and make but poor runners or wrestlers. They are described as peaceable, docile, sober, simple, industrious, straightforward, and truthful. Java is one of the most densely peopled countries of the world, the population, inclusive of Madura, amounting, according to a census taken at the end of 1872, to 17,298,200, being 387 persons to the square mile. Of these, 28,926 were Europeans, 185,758 Chinese, and 22,082 Arabs and other foreign orientals. The Javanese are almost entirely occupied in agriculture. There is a small class of fishermen on the N. coast, and a few artisans in the towns, but the great bulk of the people live directly or indirectly by the cultivation of the land, in which they have made greater progress than any other Asiatic nation except the Chinese and Japanese. The chief cereal is rice, of which with the aid of irrigation, industriously and almost universally applied, two crops are raised in a year. Java is one of the principal coffee-growing countries of the world. The coffee plantations are situated at an elevation of 2,000 ft. and upward, and are conducted under the supervision of the colonial government. The cultivation of sugar is next in importance; indigo, cotton, pepper, tea, and tobacco are also raised. The mechanic arts among the Javanese are not so far advanced as their agriculture. About 30 crafts are practised among them, of which the principal are those of the blacksmith or cutler, the carpenter, the sheath maker, the copper-smith, the goldsmith, and the potter. Bricks and tiles are largely made. The carpenters are skilful in house and boat building. They make boats of all sizes, from fishing canoes up to vessels of 50 tons, and under European superintendence build large ships. The ordinary dwellings of the people are built of a rough frame of timber, thatched with grass or palm leaves, and with walls and partitions of split bamboo. The Javanese excel all other nations of the Indian archipelago in the working of metals. They are especially skilful in the manufacture of the national weapon, the kris or dagger, which is worn by every man and boy above 14 years as part of his ordinary costume, and by many ladies of high rank. They make also excellent gongs of brass, and these with other musical instruments of the same metal have long been exported to the neighboring countries. The only native textile material woven by the Javanese is cotton, of which they make a stout durable calico, and this is purely a domestic manufacture, carried on exclusively by the women. From raw silk imported from China,



the silkworm not being reared in Java, a coarse cloth is woven also by the women. Paper of the nature of the ancient papyrus is a manufacture peculiar to the Javanese. In science the people have made little progress, possessing only a rude notion of astronomy and a slight knowledge of arithmetic. Their architecture at the present day hardly deserves the name, though the country abounds with remarkable remains of temples built many centuries ago by the ancestors of the present inhabitants. In number and beauty these structures are probably unsurpassed by the architectural remains of any country in the world, but the action of tropical vegetation is rapidly destroying them. The most extensive and interesting of these ruins are at Brambanam, near the centre of the island, at Borobodo, 80 m. westward, and at Gunong Prau, 40 m. southwest of Samarang. At Brambanam are the "thousand

have made the greatest progress. They are passionately fond of it, and have generally fine musical ears. Their melodies are wild, plaintive, and interesting, and more pleasing to the European ear than any other Asiatic music. They have wind and stringed instruments, but their most common instruments are drums and gongs. In religion the Javanese are Mohammedans, which faith was established by Arab conquerors in the 15th century, and has entirely displaced Brahmanism and Buddhism, the ancient religions of the country, except among a few people in the Tenger mountains. During the rule of the Portuguese in the 16th century, the Catholic missionaries formed some native congregations, of which a few remnants are still left. The Dutch government showed itself decidedly opposed to all missionary labor, and Protestant missions were therefore not begun until the island passed in 1811 under the



Temple of Borobodo.

temples," consisting of 296 small temples arranged in five concentric parallelograms, and forming a quadrangle of 540 by 510 ft., exactly facing the cardinal points. The celebrated temple of Borobodo is a vast domed structure erected on an inconsiderable elevation. It is a connected series of terraced walls, composed of seven tiers one above another, and all surmounted by a triple circle of 72 towers surrounding the dome. It is 620 ft. square, and rises to a height of about 100 ft. The walls are profusely ornamented with sculpture. Wallace says that the amount of human labor and skill expended on the great pyramids of Egypt sinks into insignificance when compared with that required to complete this sculptured hill temple in the interior of Java. The temples on the mountain of Gunong Prau are reached by four flights of stone steps from different directions, there being more than 1,000 steps in each flight. Of the other fine arts, music is the one in which the Javanese

rule of England. After the restoration of the Dutch administration, all missionaries but the Dutch were in 1642 forbidden to perform missionary labor, but the Dutch missionary societies were allowed to establish missions. The results of their labors are as yet of no great importance. The number of missionaries in 1873 did not reach 20, who partly belonged to the Reformed and partly to the Mennonite church. The Roman Catholics have a vicar apostolic at Batavia, and 16 priests.—The commerce of Java is transacted chiefly at the ports of Batavia, Samarang, and Surabaya. Among the principal exports are coffee, sugar, rice, indigo, tea, tobacco, spices, India rubber, birds' nests, camphor, and rattans. In 1871 the value of the merchandise and specie exported was £7,604,691, and that of the imports was £4,489,693. About one half of the rice exported and four fifths of the other exports go to the Netherlands. In June, 1872, the length of railroads in operation was 161 m., and in January, 1873, the number of telegraph offices was 98. There was regular connection with the other islands of the archipelago by means of 15 steamers belonging to the Netherlandish India steamboat company.—The most important feature of Javanese society is the village, which forms a complete body politic, with considerable powers of self-government. Its officers are elected by the people, and are charged with the collection of the taxes and the maintenance of public order. At the time of the conquest two native sovereigns, a sultan and an emperor.

ruled the island, one in Java and the other in Sunda. When the Netherlands government acquired the Dutch East India company's title to its possessions in the East, it appropriated to the crown all unoccupied lands, and secured to the descendants of the native sovereigns and their vassal rulers their titular rank and the rights of regents; but placed with each a Dutch resident, whose "recommendations" have always been obeyed as orders. The governor general acts as viceroy, receiving his directions from the Hague, and is assisted by a vice president and a council of four appointed by the king of Holland. The governors of Amboyna, Borneo, Celebes, and Sumatra, and the army and navy in the Dutch possessions in the archipelago, are under his orders. In Batavia there is a high court of appeal for criminal and civil cases among the Europeans, and the Javanese have native courts, presided over in some instances by Europeans. There are government primary schools in all the large towns, and in each residency there are salaried vaccinators and physicians. While the native rulers, who receive large annuities from the government, have the name of regents, the residents or assistant residents, with a controller, all of whom must be natives of the Netherlands, superintend the government plantations, directing what seed shall be sown, the wages to be paid, when the harvest shall be gathered, and the prices of products. This culture system, introduced in 1832, satisfies and employs the natives, defrays the entire expense of the local administration, and returns an annual revenue of \$5,000,000 to the treasury at the Hague. In 1872 the total revenue of the colony was 121,258,800 guilders, and the total expenditure 108,164,690 guilders, leaving a surplus in guilders of 18,093,610 for that year. The culture system involves the forced labor of the natives in the cultivation of coffee and sugar, but the legislature of Holland has enacted a law by virtue of which the forced cultivation of the sugar cane will cease in the year 1890. The title to the greater part of the land in the country is in the government.—The history of Java previous to the 11th century of our era is involved in fable and obscurity. It is only certain that long before that period the Javanese had acquired a considerable degree of civilization. About the 11th century, or, according to some conjectures, several centuries earlier, Java was visited by the Hindoos, either as emigrants or conquerors, who founded kingdoms and converted the natives to Brahmanism. Java was first made known to the western world in the latter part of the 13th century by Marco Polo, who, however, did not visit the island. Luigi Barthema (Vartomanus) was the first European who landed at Java. He passed 14 days there in 1506; and he represents the natives as cannibals who even sold their children to be eaten by the buyers. The Hindoos and their religion remained dominant in the island from the end of the 13th to

that of the 15th century, when Mohammedanism, which had for a century or two been zealously propagated by Arabs, Persians, Malays, and Hindoo Mohammedans, who came as merchants or settlers, gained a complete ascendancy over Brahmanism. In 1475 a Mohammedan prince raised himself to supreme power over nearly the whole island, and founded a dynasty which still exists in the small kingdoms which are permitted by the Dutch to remain in nominal independence. Bantam, the last of the Hindoo states, was conquered in 1480. The Portuguese visited Java in the 16th century, and entered into commercial negotiations with the natives. The Dutch first came to Java about 1595 as traders. In 1610 they obtained permission to build a fort at the native village of Jacatra, near the site of the present city of Batavia. Both the Portuguese and the English, who had established a factory at Bantam, yielded to their supremacy. They soon became involved in war with the native rulers, and in 1677 obtained a considerable territory. From that period to 1680 they carried on four great wars with the natives, the first of which, begun in 1674, lasted for 84 years; the second, which began in 1718, for 5 years; the third, which began in 1740, for 15 years; and the fourth, which began in 1825, for 5 years. The third was begun Sept. 26, 1740, by a dreadful massacre of the Chinese settlers at Batavia, of whom 10,000 were killed in two days. In 1749 the principal Javan monarch conferred the sovereignty of the island upon the Dutch, by an official deed to the Dutch East India company. In 1811 the British, being at war with Holland, then a portion of the French empire, sent a fleet and army against Java, which was conquered without much opposition and held till 1816, when it was restored to Holland. By a decree of the Dutch government, slavery was totally abolished on Sept. 20, 1859, in all their colonies in India. It had never prevailed among the native Javanese, and the number of slaves in the island amounted only to a few thousands, mostly natives of other islands of the archipelago and of Africa, and held by European masters. In 1860 the Swiss auxiliary soldiers, aided by natives, mutinied; they were soon reduced to submission, and many were executed.—Sir T. Stamford Raffles's "History of Java" (2 vols. 4to, London, 1817) is a standard work. The natural history of Java has been treated by Blume, *Flora Java necnon Insularum Adiacentium* (3 vols. fol., Brussels, 1826-'36), and by Dr. T. Horsfield in his "Zoological Researches in Java and the Neighboring Islands" (London, 1824). Junghuhn is the author of several works on the natural history and geography of Java, the most important of which was published in Amsterdam in 1850 (3d Ger. ed., Leipsic, 1852). Interesting recent descriptions of Java are given by Albert S. Bickmore, in "Travels in the East Indian Archipelago" (New York, 1869); by A. R. Wallace,

in "The Malay Archipelago" (London and New York, 1869; and in W. H. Seward's "Travels around the World" (New York, 1873).

**JAVA, Language and Literature of.** Javanese, spoken in Java and several small adjacent islands, belongs to the Malayan division of the Malayo-Polynesian group of languages, and is most closely related to Malay proper. It has the peculiarity of employing special forms and flexions for addressing superior or inferior persons. The manner of speaking to subordinates is called *bdad nokó*, or simply *nokó*, commanding speech; and that to superiors *bdad krdmd*, or only *krdmd*, humble speech. A third mode of conversing, namely, between equals, or as a condescension toward a person of lower rank, is called *bdad madyd*, middle speech. In the presence of the sovereign or his ambassadors still another form of speaking is observed, called *bdad kratón*, the court language. The ancient Javanese literature, the beginnings of which can be traced to the first century of our era, is written in a language thoroughly impregnated with Sanskrit elements, and bearing the name of *Kari*, the poet's tongue. The Sunda language, spoken in the western portion of the island, is somewhat related to Javanese, but is clearly distinguished from it by many peculiarities. The Javanese alphabet consists of 20 consonants and 6 vowel sounds; but the latter are not considered by the natives to form part of it, as they are only supplementary characters, as in Arabic. The graphic system is derived from the Indian Devanâgarî.

𑀓	𑀔	ho	𑀕	𑀖	po
𑀗	𑀘	no	𑀙	𑀚	do
𑀛	𑀜	tyo	𑀝	𑀞	dyo
𑀟	𑀠	ro	𑀡	𑀢	yo
𑀣	𑀤	ko	𑀥	𑀦	nyo
𑀧	𑀨	do (dho)	𑀩	𑀪	mo
𑀫	𑀬	to	𑀭	𑀮	go
𑀯	𑀰	so	𑀱	𑀲	bo
𑀳	𑀴	vo	𑀵	𑀶	t'o (tho)
𑀷	𑀸	lo	𑀹	𑀺	ngo

The Javanese employ at the end of words abridged forms of the regular characters, as given in the second column of the alphabet. These twenty letters represent the native sounds only. There are besides the *hakârd gadi* or *hakârd marda*, large or capital letters, which are intended to be used in rendering Indie words, but rarely employed. Arabic sounds are indicated by a diacritic sign, consisting of three dots, above the letters. The foreign elements of the language are mutilated, nevertheless, in as great a degree as

Chinese is distorted by the Japanese. The sounds *f* and *ch* are wanting. Consonants have an inherent *o*, for which reason many Indian words possessing the vowel *a* are pronounced with *o*, without necessarily a change in the orthography. The gender and number of nouns are indicated by accompanying adjectives. The genitive case is formed by inflection, but the other relations of words are either expressed by prepositions or left to be inferred. Adjectives admit of no distinction of gender, number, or case, and of comparison only by extrinsic means. Pronouns are equally invariable. There is none for the third person singular or plural, none for the second person plural, and only *haku* in *Nókó* for the first person singular, *kitá* and *kami* for the same in the plural, and *kóri* for the second person singular. The suffix pronouns in *Nókó* are *-ku*, I; *-mu*, thou; *-hé*, he; the last is rendered *-na* in *Kramâ*, and the second person singular *-ta* in *Kavi*. It is customary, however, to omit pronouns, and when possible to use instead the titles of the person addressed. There are other pronominal forms, but not properly such, which are used profusely in humble and ceremonial forms of speech. The simple form of the verb indicates present time, but for clearness or emphasis some word signifying now or still is introduced. Past time is expressed by the particle *sampun* in *Kramâ*, *hèmpun* in middle, and *wis* or *wus* in *Nókó*, meaning past or already. The particle *badí* in *Kramâ*, *bakal* in *Nókó*, or the word *harad* in the former, *harép* in the latter, meaning to will, or the will, indicates the future tense. The active and passive voices are distinguished, but the latter is not properly such, and rather a nominal form. Thus the verb *tandak*, to seize, is conjugated as follows: *haku nandak*, I seize; *haku ris nyandak*, I have seized; *haku bakal nyandak*, I shall seize; and *dak tandak*, by me has been seized. Verbs obtain a passive meaning also by inserting *in*, as *rayah*, to rob, *rinyah*, to be robbed. The infix *um* forms neuter verbs. For the numerals see the comparative table in the article on the Malayo-Polynesian languages. Most of the parts of speech can be changed one into another by the use of prefixes, suffixes, or infixes, either singly or combined.—While the language is very copious in some respects, it is exceedingly meagre in others. There are two and even three names for some metals, but there is no equivalent for metal or mineral; so there is no word for animal, while there are five words for dog, six for hog, and seven for horse. There are expressions for 10 ways of standing, and 20 of sitting; and there are 50 for the different modifications of sound. Thus in unimportant trifles the Javanese language has a store of endless distinctions, while useful words, or such as seem to us absolutely necessary, are utterly wanting.—**LITERATURE.** There is a multitude of chronicles and historical works written in Javanese. Other ancient books are religious, Buddhistic,

nomical, astrological, &c. Most interesting oriental scholars are the adaptations and variations of Indian materials. Thus the *Jydnā* is based on the old Hindoo *Rāmāyaṇa*, the *Brāhṇa-yudd* on the *Mahābhārata*, and *Sastrā mandal* on Manu's book of laws. There is also an abundance of romantic literature.

Peculiar are the carefully prepared texts of the puppet shows, which are generally epopoeic with heroes borrowed from the Hindoos. Local histories of Java have been written, and some specially treat the history of the domains of various native princes. Missionaries have produced works on the Christian religion, later translated into Javanese "The Thousand and One Nights" and several other works, a Javanese newspaper has recently been published.—See Crawford, "History of the Indian Archipelago" (Edinburgh, 1880); Wilhelmsen, "Ueber die Kawi-sprache" (Berlin, 1886-'9); the grammars by G. J. van der Kolk (Batavia, 1881) and Roorda van Eysinga (Amsterdam, 1855); and Gericke's *Jasch-Nederdutch handwoordenboek* (new ed. by T. Roorda, Amsterdam, 1871 *et seq.*).

**JAXARTES**, the ancient name of the Sir Darya, a river of central Asia. The Naryn, its upper branch, rises, according to Fedchenko's map (*Petermann's Mittheilungen*, June, 1870), in Russian Turkistan, about lat. 44° 30' and lon. 76° 30' E. Taking a western course, and increased by many small streams, it flows, about 20 m. below its junction with the Irtys, to the khanate of Khokan, which it crosses in a S. W. direction. Jointly with the waters of several small rivers of S. and E. Khoiva it forms the Sir Darya a little S. of the mouth of Namangan. The Sir Darya continues in its S. W. course, enters the recently formed Russian province bearing its name, and turns abruptly to the north. Reaching about lat. 45° N. and lon. 67° E., it assumes a westerly course and falls into the sea of Aral, at the mouth of the Jaxartes figures in the history of Alexander, and other conquerors, for a time long after the Christian era was over as emptying into the Caspian.

**JAY**, the popular name of many conirostral birds of the crow family, and subfamily *Garrulinae*, inhabiting Europe, Asia and its archipelago, and America. One of the handsomest of the genera is *Cyanura* (Swains.), of which there is the blue jay, and all the species, about 15 in number, belong to America; in this genus the head is crested, the bill rather slender and curved at the tip, which is slightly hooked, the wings and tail blue with transverse black bars; the circular nostrils are concealed by bristles; the wings are rounded, the fourth, fifth, and sixth quills the longest; tail about as long as the wings, lengthened and graduated; the toes strong, with the claw large and longer than the toe. The blue jay (*C. cristata*, Swains.) is too well known to need description; it will be sufficient to say that the general color above is light

purplish blue, with the wings and tail ultramarine; the under parts are whitish, with a black crescent connected with a half collar on the neck above; besides the black bands on the wings and tail, the lateral feathers of the latter are tipped with white. This lively, impertinent,



Blue Jay (*Cyanura cristata*).

and noisy bird is one of the most graceful and beautiful inhabitants of our woods; it is found all over the United States, as far west as the Missouri, and as far north as Canada, remaining often through the winter in New England. It has a very mischievous disposition, robbing the farmer's corn crib, sucking eggs of other birds, and tearing the young to pieces; it possesses considerable imitative power, and seems to take delight in uttering the cry of the sparrow hawk to terrify the small birds and make them rush to cover; it is very quarrelsome, and in an aviary will soon destroy other birds of its size. When eggs and tender birds fail, they eat nuts, fruits, grain, and insects; they breed in all parts of the United States, though in Florida they are in a great measure replaced by the *Cyanocitta floridana*, and west of the Rocky mountains by Steller's jay. Their usual note is a harsh scream, uttered by all in the neighborhood at the approach of any rapacious bird or quadruped or human enemy, and on this account a jay is often a nuisance to the sportsman in quest of nobler game. The length is about 12 in., and the extent of wings 14.—The genus *Cyanocitta* (Swains.) includes the jays without a crest, with no bands on the wings and tail, and with shorter wings. In *C. californica* (Strickl.) the belly and under tail coverts are dull white; in *C. floridana* (Bonap.) the belly is brownish ash; in *C. ultramarina* (Strickl.) the blue color is very rich, with the under tail coverts white. The prevailing color is blue in all these jays. The Canada jay (*perisoreus canadensis*, Bonap.) is about an inch less than the blue jay, of a general cinereous color above, smoky gray below, with a whitish breast and neck and brown nuchal patch. It is found throughout the northern parts of America, even into New York and

New England. The habits are much the same as those of the blue jay, its common name of carrion bird indicating its carnivorous propensities; the young are sooty brown, and are often called "whiskey-jacks." Several other jays are described by Baird and Brewer. The jay of Europe (*garrulus glandarius*, Linn.) is a handsome bird, about as long but not so thick as a pigeon, of a light reddish brown color, the fore part of the head whitish with black spots, and the feathers elongated so as to form an erectile crest; the blue wing coverts are banded with black; the quills of the wings and tail, and broad band from the base of the bill under the eye, black; the female differs but little from the male. It is common in England, southern Scotland, and other parts of Europe; shy and suspicious like all the crow family, it frequents wooded districts, feeding principally on nuts, worms, and insects, in summer visiting gardens for the sake of their fruits and leguminous vegetables; it also plunders the nests of other species, and sometimes pounces on field mice and small birds. The flight is direct and quick, and performed with great dexterity through the thickets; the ordinary notes are harsh and loud; its power of imitation, especially in captivity, is considerable, embracing the sounds of birds and domestic mammals, and any noise which may come to its ears. The eggs, from five to seven, are  $1\frac{1}{4} \times \frac{1}{2}$  inch, pale bluish green, with faint freckles of purplish and yellowish brown.

**JAY**, an E. county of Indiana, bordering on Ohio, and drained by the head waters of Salamonie and Wabash rivers; area, 370 sq. m.; pop. in 1870, 15,000. The surface is undulating, and the soil of various qualities, but mostly fertile. The Pittsburgh, Cincinnati, and St. Louis railroad passes through the S. W. corner, and the Cincinnati, Richmond, and Fort Wayne line intersects it. The chief productions in 1870 were 282,935 bushels of wheat, 216,090 of Indian corn, 96,139 of oats, 18,946 of flax seed, 24,106 of potatoes, 78,866 lbs. of wool, 290,459 of butter, 45,008 of maple sugar, and 10,852 tons of hay. There were 6,046 horses, 4,192 milch cows, 4,352 other cattle, 24,938 sheep, and 16,866 swine; 4 carriage factories, 1 woollen factory, 1 flour mill, and 7 saw mills. Capital, Portland.

**JAY. I. John**, an American statesman, first chief justice of the United States, born in New York, Dec. 12, 1745, died at Bedford, Westchester co., N. Y., May 17, 1829. He was descended from Augustus Jay, a Huguenot merchant of Rochelle in France, who after the revocation of the edict of Nantes in 1685 emigrated to America, and settled first in Charleston, S. C., and afterward in New York. Peter Jay, the father of John, was a merchant. While still an infant John Jay was removed with the rest of the family to a country seat at Rye, Westchester co., on the shore of Long Island sound. He received his early education at the grammar school of New Rochelle, and at

King's (now Columbia) college, where he graduated in 1764. He studied law in the office of Benjamin Kissam at the same time with Lindley Murray, the grammarian. In 1768 Jay was admitted to the bar, and formed a partnership with Robert R. Livingston, afterward chancellor of the state of New York. The revolutionary movement called him actively into the field of politics. While he deemed the course of the British ministry dangerous to the rights and liberties of his countrymen, his sentiments as to the mode of resistance and redress were moderate. When intelligence of the passage of the Boston port bill reached New York, a meeting was held, May 16, 1774, and a committee of 51 formed to correspond with the other colonies. Jay was appointed a member of this committee, and at their first meeting, May 23, a sub-committee of four was nominated to draft an answer to the Boston committee, who had recommended the general adoption of a non-importation and non-exportation agreement until the act for blocking up their harbor was repealed. He was a member of this sub-committee, and is supposed to have been the author of the reply to the Boston address, in which the proposition to enter into an agreement of non-intercourse was pronounced premature and inexpedient, and a general congress of the colonies recommended. Though the moderation of this document gave much offence to the more ardent patriots, the suggestion of a congress was concurred in, and Philip Livingston, Isaac Low, John Abbot, and John Jay were unanimously elected delegates to it, and were soon afterward adopted as their delegates by the city of Albany and by some towns in Westchester and Dutchess counties. The congress met on Monday, Sept. 5, 1774, at the Carpenters' hall in Philadelphia. Jay, though the youngest member but one, took a leading part in its proceedings. He was at this time strongly opposed to any attempt at independence, but desired to see the difficulties between the colonies and the mother country adjusted on terms satisfactory to both parties. When convinced, however, by the course of events, that independence had become a necessity, he embraced the measure with zeal and lent it hearty and efficient support. He participated in most of the debates that arose, and made his first speech upon the question of the mode of voting in the congress. On Sept. 6 he was appointed one of a committee of two from each colony to state the rights of the colonies in general, the violation of those rights, and the proper mode of redress. On Oct. 11 he was appointed one of a committee of three to prepare a memorial to the people of British America and an address to the people of Great Britain. The latter document, written by Jay, gave its author a great reputation throughout the country. In the second continental congress, which met at Philadelphia May 10, 1775, Jay was one of a committee of three appointed to draw up an address

to the people of Canada soliciting their cooperation in the contest which had now become inevitable, and the paper reported by the committee was from his pen. On Sept. 23 he was appointed on a committee with Franklin, Rutledge, Randolph, and others, to consider the state of the trade of America. Their report led to an animated debate, in which Jay advocated the policy of continuing the trade with Great Britain and the British West Indies from New York, North Carolina, and Georgia, in opposition to those who maintained that, as the rest of the colonies had been excluded from this trade by the "restraining act" of parliament, the three colonies excepted should voluntarily relinquish it. On Dec. 4 Jay, Dickinson, and Wythe were appointed a committee to confer with the assembly of New Jersey, and endeavor to dissuade that body from sending a petition to the king of Great Britain, separate from the petition of united America presented by congress. The remonstrances of the congressional committee prevailed with the assembly, and the design of petitioning the king was abandoned. On Nov. 29, 1776, congress appointed Harrison, Franklin, Johnson, Dickinson, and Jay a committee to correspond with the European friends of American liberty. A secret agent of the French government had shortly before given to a committee, consisting of Jay, Franklin, and Jefferson, indirect assurances that the revolted colonies might rely on receiving aid from France. The committee of correspondence at once entered into negotiations with friends of the American cause in England, France, and Holland, the result of which was that in the spring of 1776 Silas Deane was privately sent as a political agent of America to the court of France. His letters from Paris were addressed to Jay. In addition to his labors in congress, Jay was at this time much occupied with the affairs of New York, where the tories were numerous, and the provincial congress was suspected of being lukewarm in the cause of freedom. It was difficult at this time to induce men of standing and character to accept commissions in the militia of the state. Jay, as an example to others, allowed himself to be commissioned as colonel of the second regiment of foot in the city of New York, though his duties in congress kept him from the field. In April, 1776, he was chosen a member of the provincial congress of New York, and at the special request of that body he returned from Philadelphia to assist in its deliberations. He was thus prevented from becoming a signer of the Declaration of Independence, which passed the continental congress while he was serving in the congress of New York. He however gave that measure his cordial approval and support. In the next New York congress, or convention as it was called, he took a leading part, serving on the most important committees, and was also actively engaged in taking measures to repel the incursions of the enemy up the Hud-

son, and to suppress the conspiracies of the tories. To arouse the people from the gloom occasioned by the reverses of the army, he drew up an address which was issued by the convention, Dec. 23, 1776. This document was deemed of such importance that the continental congress specially recommended it to the perusal of the people of the United States, and ordered it to be translated into German and printed and circulated at the national expense. When the convention undertook in August, 1776, to form a government for the state of New York, he was appointed one of the committee to frame a constitution and bill of rights. The report of the committee, made March 12, 1777, was written by him, and the constitution was chiefly his work. The convention, just before its dissolution, May 13, appointed a council of safety invested with dictatorial powers consisting of 15 members, of whom Jay was one. The convention also appointed Jay chief justice of the state until the legislature should meet, and the constitutional power of appointment be organized, and he presided at the first term of the supreme court at Kingston, Sept. 9. On the next day the legislature met, and Jay was duly reappointed chief justice under the constitution. On Nov. 4 he was elected by the legislature a delegate to the national congress, on the ground that the withdrawal of Vermont from the jurisdiction of New York furnished a special occasion for requiring his services at Philadelphia. He took his seat Dec. 7, 1778, and on the 10th was elected president of congress, Laurens, the former president, having resigned. On Sept. 27, 1779, he was appointed minister to Spain, and reached Cadiz Jan. 22, 1780, and Madrid on April 4. His mission had two objects, to obtain a loan of \$5,000,000, and to secure the right to the free navigation of the Mississippi. The Spanish court received him coldly, and many months passed in fruitless negotiations. Congress, without waiting to hear even of his arrival in Spain, had directed its treasurer to draw on him at Madrid for \$500,000. When these bills arrived, rather than let the credit of the country be damaged by their going to protest, he accepted them at his own risk. He was afterward enabled to meet them when due, partly by remittances from Franklin at Paris, and partly by some smaller sums reluctantly given by the Spanish government. He quitted Madrid, May 20, 1782, and proceeded to Paris to assist in the negotiation of a treaty of peace with Great Britain, congress in 1781 having appointed him a commissioner for that purpose, together with Adams, Franklin, Jefferson, and Laurens. He arrived in Paris June 23. Of his colleagues, Franklin alone was there, Jefferson being detained in America by the delicate health of his wife, Laurens a prisoner in the tower of London, and Adams in Holland negotiating a loan. On Franklin and Jay therefore the primary formation of the treaty devolved. To the value of Jay's ser-

vices in this important negotiation we have the testimony of Adams, who says that all his colleagues were very able and attentive, "especially Mr. Jay, to whom the French, if they knew as much of his negotiations as they do of mine, would very justly give the title which they have inconsiderately decorated me, that of *le Washington de la négociation*; a very flattering compliment indeed, to which I have not a right, but sincerely think it belongs to Mr. Jay." Jay quitted Paris in May, 1784, and arrived in his native city, July 24, after an absence from it of eight years. The freedom of the city was presented to him in a gold box, with an address by the corporation. He intended on leaving Europe to resume the practice of his profession, but on reaching New York he learned that congress had appointed him secretary for foreign affairs. He was also, in the succeeding autumn, elected by the state legislature a delegate to congress. He took his seat in congress Dec. 6, and held it till Dec. 21, when he accepted the secretaryship for foreign affairs, and performed its duties for five years, till the adoption of the federal constitution in 1789. In the conflict of opinion with regard to the constitution that should be formed, Jay shared in Hamilton's preference for a strong central government. When the constitution was formed, however, he urged its adoption with earnestness and ability, and wrote in its defence in "The Federalist," in conjunction with Hamilton and Madison. In April, 1788, occurred the riot in New York, known as the doctors' mob, occasioned by violations of the grave for the purpose of procuring subjects for dissection. Several physicians had been lodged in prison to protect them from the popular fury. The mob attempted to force the prison, and were resisted by Hamilton, Jay, and a body of citizens. In the conflict Jay received a wound in the temple, which confined him for some time to his bed and interrupted his contributions to "The Federalist." About the same time he was elected by a nearly unanimous vote a delegate to the New York state convention called to adopt or reject the proposed federal constitution. The convention assembled at Poughkeepsie, June 17, 1788. Of its 57 members, 46 were opposed to the constitution; but its adoption was advocated by Jay, Hamilton, and Robert R. Livingston, and after a warm debate of more than five weeks, New York gave her assent to the Union by a vote of 30 to 27. President Washington tendered to Jay a choice of the offices in his gift. He preferred the chief justiceship of the supreme court of the United States, and was confirmed by the senate, Sept. 20, 1789. The first term of the court was held at New York in February, 1790. In 1792, at the April election, Jay was the federal candidate for governor of New York, in opposition to George Clinton. Clinton was declared elected, the legislative committee rejecting on technical grounds the returns of three counties where

Jay had large majorities. The federalists were greatly exasperated, and at many public meetings Jay was declared to be the rightful governor of the state; but he counselled submission to the letter of the law. In 1794 the difficulties between the United States and Great Britain, growing out of unsettled boundaries and the attacks of the latter power on American commerce, became so serious that war was imminent. Washington wished to appoint Hamilton as special minister to England; but such was the animosity against Hamilton in the senate, that he finally nominated Jay, who embarked at New York May 12, and reached London June 15. He immediately entered into negotiations with Lord Grenville, the minister for foreign affairs, and a treaty was agreed upon, Nov. 19, 1794. It provided for constituting three boards of commissioners: one to determine the eastern boundary of the United States, by fixing on the river intended by the treaty of 1783 as the St. Croix; another to ascertain the amount of losses experienced by British subjects in consequence of legal impediments to the recovery of pre-revolutionary debts, that amount, when ascertained, to be paid by the United States; and a third to estimate the losses sustained by Americans from illegal captures by British cruisers, those losses to be paid by the British government. The amount subsequently recovered by Americans under this clause was \$10,345,000. The western posts occupied by the British were to be surrendered on June 1, 1796. There was to be a reciprocity of inland trade and intercourse between the North American territories of the two nations, including the navigation of the Mississippi, the British also to be admitted into all American harbors, with the right to ascend all rivers to the highest port of entry; but this reciprocity did not extend to the admission of American vessels into British North American harbors or rivers. These articles were declared to be perpetual; the following were limited to two years after the termination of the war in Europe: American vessels were to be admitted into British ports in Europe and the East Indies on terms of equality with British vessels; Americans might trade to the British West Indies in vessels not exceeding 70 tons burden, but without the right to transport from America to Europe any of the principal colonial products; British vessels were to be admitted into American ports on the same terms as those of the most favored nation. Privateers were to give bonds to respond in any damages they might commit against neutrals. The list of articles contraband of war was to include, besides ammunition and warlike implements, all articles serving directly for the equipment of vessels, except unwrought iron and fir plank. No vessel entering a blockaded port was to be captured unless she had first been informed of the blockade and turned away. Neither nation was to allow enlistments within its territories by any third nation at war with the other; nor

were the citizens or subjects of either to be allowed to accept commissions from such third nation, or to enlist in its service. The rest of the articles were similar to these, and were intended to preserve neutrality upon the ocean, and its observance in the American ports, so that neither French nor British privateers should be exclusively favored or supplied. A provision was made for the mutual surrender of fugitives from justice charged with murder or forgery. Jay returned to New York May 28, 1795. The treaty was submitted to the senate on June 8, and on the 24th that body advised the president to ratify it, with the exception of the articles relating to the West India trade. It was published in Philadelphia on July 2, and caused a prodigious storm of popular excitement, clamor, and misrepresentation. It was denounced as a pusillanimous surrender of American rights, and a shameful breach of our obligations to France. Meetings were held against it in all the principal cities. Copies of it were publicly burned by mobs in New York, Philadelphia, Charleston, and other places. An attempt was made at Philadelphia to burn Jay in effigy on the 4th of July. Washington, though he considered the crisis the most important and dangerous that had yet occurred in his administration, ratified the treaty on Aug. 14. This, however, did not quiet the agitation. Some of the Boston democrats paraded the streets of that town with an effigy of Jay, which they finally burned; they also attacked the house of a federalist editor, but were fired on and repulsed. On the other hand, the treaty, Jay's treaty as it was familiarly called, was defended with energy by Hamilton and other federalists. Many public meetings also were held in support of the ratification of the treaty, and the Boston chamber of commerce passed a resolution in favor of it, with only one dissenting voice, while a memorial taking the same ground was numerously signed by the merchants of Philadelphia. In the house of representatives Fisher Ames made his greatest speech in defence of the treaty, and in favor of passing the laws necessary to give it effect. After a long struggle the resolution that it was expedient to pass the laws necessary for carrying the treaty into effect was agreed to by a vote of 58 to 51, only four New England members voting against it, and from the states south of the Potomac only four for it. Jay himself, amid all this excitement and obloquy, relied upon the ultimate judgment of his countrymen.—During his absence in England his friends had put him in nomination as candidate for governor of New York, without his knowledge. He was elected by a large majority, and the result was officially declared two days before he reached New York. His administration, by reelection, lasted six years, during which time he dismissed no one from office on account of his political opinions. In 1799 the legislature passed an act for the gradual abolition of slavery, a measure which Jay had strenu-

ously urged in 1777 upon the convention which formed the constitution of the state. In 1785 he became the president of a society formed in New York "for promoting the manumission of slaves, and protecting such of them as have been or may be liberated." He continued at the head of this society till he became chief justice of the United States, when, thinking it possible that questions might be brought before him in which the society was interested, he deemed it proper to dissolve his official connection with it. In November, 1800, as the end of his second term approached, he was solicited to become a candidate for reelection, but declined. In December he was nominated by the president and confirmed by the senate to his former office of chief justice, made vacant by the resignation of Oliver Ellsworth. He firmly declined the honor, and at the age of 55 bade adieu for ever to public life, and retired to his paternal estate at Bedford, Westchester co., where he lived for upward of 28 years. He was very regular and exact in all his habits, was a member of the Episcopal church, and took great interest in the religious movements of his day, being president of several religious societies. In 1827 he was seized with a severe illness, and, after two years of weakness and suffering, was struck with palsy, May 14, 1829, and died three days afterward. In character Jay was eminent for the elevation and purity of his principles and conduct both in public and in private life. He had a high sense of justice and of humanity, and a profound feeling of religion. His mind was vigorous, exact, and logical, and characterized rather by judgment and discrimination than by brilliancy. The Bible was his constant study, and Cicero his favorite author. His public reputation as a patriot and statesman of the revolution was second only to that of Washington. — H. WILLIAM, an American jurist and philanthropist, son of the preceding, born in New York, June 16, 1789, died at Bedford, N. Y., Oct. 14, 1858. He received his early education at Albany, and graduated at Yale college in 1807. He studied law at Albany, but having injured his eyes by intense study, relinquished the practice of the profession and retired to Bedford, where he assisted in the management of the large landed estate which descended to him on the death of his father in 1829. In 1815 he began his career of philanthropic effort in the founding of the American Bible society, and was its recognized champion against the attacks of Bishop Hobart and other members of the Episcopal church, to which Jay himself belonged, during a controversy which lasted many years. As president of the Westchester Bible society he delivered a long series of annual addresses. He organized a society for temperance reform in 1815. He also took an active part in the tract, missionary, and educational movements of the day, and was frequently president of the Sunday school and agricultural societies of his county.



In 1818 he was appointed a judge of the court of common pleas, and in 1820 was made the first judge of Westchester co., which office he held till 1842, when he was superseded on account of his anti-slavery opinions. In 1835, when the legislature had in contemplation a law restricting freedom of speech on the subject of slavery, he advised the grand jury that it would be the duty of every citizen to resist such a law as a violation of the constitution. The same year, on behalf of the executive committee of the American anti-slavery society, he prepared a reply to the current charges against the abolitionists, and published a work entitled "An Inquiry into the Character of the American Colonization and Anti-Slavery Societies." In 1838 he published "A View of the Action of the Federal Government in behalf of Slavery." In 1843-'4 he visited Europe, and proceeded thence to Egypt, where he made the acquaintance of Sir Gardner Wilkinson, in conjunction with whom he investigated the subject of Egyptian slavery. He was for some years president of the American peace society, and in 1848 published a volume entitled "War and Peace: the Evils of the First, with a Plan for supporting the Last," which was reprinted by the London peace society. His plan consisted in treaty stipulations for the settlement of differences by arbitration. The committee on foreign relations of the United States senate, to whom a memorial on the subject was referred, reported in favor of his plan; and Mr. Cobden wrote to him: "If your government is prepared to insert an arbitration clause in the pending treaties, I am confident that it will be accepted by our negotiators." By his will he left a bequest of \$1,000 for "promoting the safety and comfort of fugitive slaves." His publications on all subjects were 43 in number, many of which were widely circulated and exercised much influence on public opinion. His largest work was the "Life and Writings of John Jay" (2 vols. 8vo, New York, 1833). He left in manuscript an elaborate commentary on the Bible. **III. John**, son of the preceding, born in New York, June 23, 1817. He studied and practised law, became prominent in the anti-slavery and other political movements, was active in the affairs of the Episcopal church, was for many years a manager and corresponding secretary of the New York historical society, and has published numerous pamphlets, addresses, and reports relating to these subjects. He was one of the founders and for some time president of the Union league club of New York. In 1869 he was appointed minister to Austria, which post he still holds (1874).

**JAY, William**, an English clergyman, born at Tisbury, Wiltshire, May 8, 1769, died in Bath, Dec. 27, 1853. The son of a stone-cutter, he began life as his father's apprentice, and was employed in building Beekford's mansion at Fonthill. His talents attracted the attention of the Rev. Cornelius Winter of the Marlborough dissenting academy, under whose pro-

tection and direction he prepared for the Congregational ministry. He began preaching in his 16th year. His first important sphere of labor was at Hope chapel, near Bristol. From thence he removed in 1789 to Argyle chapel in Bath, where he was settled as pastor Jan. 31, 1791, and officiated till he retired from the active ministry in January, 1853. His published sermons have passed through several editions. He also wrote an "Essay on Marriage," "Memoirs of the Rev. Cornelius Winter," "Memoirs of the Rev. John Clark," and "Lectures on Female Scripture Characters" (1854). His most popular work, however, was his "Morning and Evening Exercises" (4 vols. 1854), which has had a very wide circulation. His earlier works were collected in 12 vols. (Bath, 1845-'9; republished in 3 vols., New York). His autobiography, with a supplement by the Rev. Dr. Redford and the Rev. J. A. James, appeared in 1854.

**JAYADEVA**, a Hindoo poet, born at Kendali, a town of doubtful position, but according to tradition near the Ganges, about the middle of the 12th century. The only poem of his extant is entitled *Gita Gorinda*, in honor of Govinda or Krishna, the eighth avatar or incarnation of Vishnu. It is a species of pastoral drama, in which the loves of the god and his innamorata Rádha are described in very impassioned language. This poetry has always been greatly admired by the Hindoos, and most of the commentators contend that it is to be understood in a figurative and allegorical sense, the loves of Krishna and Rádha describing the attraction between the divine goodness and the human soul. There is an English translation of it by Sir William Jones, who admits the allegorical meaning, though others think it merely an amatory poem.

**JAZET, Jean Pierre Marie**, a French engraver, born in Paris, July 31, 1788. Under the direction of his uncle Debucoart he became famous by aquatint engravings of some of the most celebrated works of Vernet, Gros, Delacroix, and other eminent painters, and was still at work in 1864, though then in his 76th year. —His son **EUGENE**, who excelled in the same art, met with a tragic end in 1856; and another son, **ALEXANDRE JEAN LOUIS**, executed a popular engraving of Trumbull's "Declaration of American Independence" (1861).

**JAZYGES**, a tribe belonging to the numerous nationalities comprehended during the earlier period of the Roman empire under the name of Sarmatians, who dwelt originally on the northern shores of the Black sea and sea of Azov. In the time of the emperor Claudius being pressed by their neighbors, they divided into three bodies, which established themselves respectively on the Don, between the Dnieper and the Dniester, and in the marshy region between the Theiss and the Danube. The two former divisions became tributary to the Goths; the third, because of their position between Pannonia and Dacia, lived under

the protection of Rome, and were called *Jazyges Metanastæ*, or transplanted. Their name disappeared in the great invasion of the Magyars. They reappeared as a Magyarized tribe (Hun. *Jászok*, bowmen) at a later period, when their possessions between the Danube and Theiss formed a separate central district of Hungary under the name of *Jazygia* (*Jászadig*). This fertile region was united with Cumania, and down to 1848 was under the special administration of the palatine, who also bore the title of captain of the *Jazyges* and *Cumanians*. It embraces among others the towns of *Jászberény*, the capital of the united districts, *Árok-Szállás*, and *Apáthi*, and has an area of 400 sq. m., and a population of 60,000 (area of *Jazygia* and *Cumania* together, 1,825 sq. m.; pop. in 1870, 215,526). (See *CUMANIA*.)

**JAZYGIA.** See *JAZYGES*.

**JEAFFRESON, John Cordy**, an English author, born at Framlingham, Suffolk, in January, 1831. He studied medicine for a while, afterward entered Pembroke college, Oxford, where he graduated, in 1852 entered Lincoln's inn as a law student, and in 1859 was admitted to the bar. While an undergraduate he contributed frequently to magazines and newspapers. His first novel was "*Crew Rise*" (1854). This was followed by "*Hinchbrook*" (1855) and several other novels, such as "*Isabel, the Young Wife and Old Love*," "*Miriam Copley*," "*Sir Edward's Daughter*" (1860), "*Olive Blake's Good Work*" (1862), and "*Live it Down*" (1863). Among his other works are "*A Book about Doctors*" (1860), "*A Book about Lawyers*" (1866), "*A Book about the Clergy*," "*Annals of Oxford*" (1870), and "*A Woman in Spite of Herself*" (1872).

**JEANRON, Philippe Auguste**, a French painter, born in Boulogne, May 10, 1809. He is a self-taught artist, and became known in Paris in 1830 by his "*Little Patriots*" and other genre pictures, especially the "*Twelve Episodes in a Proletarian Life*," executed for Ledru-Rollin, who placed him in 1848 at the head of all the national museums, from which office he retired in 1850, after making great improvements in the Louvre and other institutions in Paris and elsewhere. He afterward became director of the museum of Marseilles. One of his best works is "*The Abandoned Port of Ambleteuse*," in the Luxembourg. He has written "*Histoire de l'école française*" (1852), and "*De l'art de la peinture*" (1865).

**JEBAIL, or Jebell**, a town of Syria, built on an eminence near the Mediterranean, at the

foot of Mt. Lebanon, 20 m. N. of Beyrout; pop. about 600. It is walled on the land side, contains large gardens, a strongly built castle, an old Maronite church, and a mosque. It is supposed to be the Byblus of the ancients, often mentioned as a city of Phœnicia, between Tripolis and Berytus, the modern Tarablus and Beyrout. In the Scriptures it is called Gebal, a word signifying mountain. Its territory is called the land of the Gibletes (*Josh. xiii. 5*); and its inhabitants are mentioned among the builders of the Phœnician king Hiram, who assisted King Solomon in building the temple of Jerusalem. Its elders and wise men are mentioned as calkers of Tyre, in the time of its glory (*Ezek. xxvii. 9*). It is said to be the birthplace of Adonis, and just S. of the town the river Adonis falls into the sea. The harbor of Jebail was destroyed during the wars of the crusaders, who captured the town and kept it as long as they maintained their power in Syria. It was taken from Mehemet Ali by the English in 1840.—Another Gebal is mentioned in the Scriptures, a mountainous region S. of the Dead sea, the Jebal of the Arabs, the Gebalene of the Greeks, and probably the Syria Sobal of the crusaders.

**JEBEL SHOMER.** See *SHOMER*.

**JEDBURGH**, the chief town of Roxburghshire, Scotland, on the left bank of the river Jed, 42 m. S. E. of Edinburgh; pop. in 1871, 3,321. It is a well built and picturesque town, with manufactures of woollens, iron and brass wares, and machinery; but its history and antiquities give it its chief celebrity. The prin-



Jedburgh Abbey.

cipal architectural remains are the ruins of the ancient and once magnificent abbey, built during the 12th century, and the castle, a favorite residence of the early Scottish kings, now used as a prison.—Jedburgh was the scene of many desperate conflicts during the

border wars, when it was strongly fortified, and was regarded, with the dense forest near by, as one of the chief Scottish strongholds. The great abbey was burned by the earl of Surrey in 1523, and again partially destroyed by the earl of Hertford in 1545. The town was also the scene of incidents in the life of Mary Stuart. It is the birthplace of Sir David Brewster and Mrs. Mary Somerville.

**JEFFERSON**, the name of 28 counties in the United States. **I.** A N. county of New York, bordering on Lake Ontario and the river St. Lawrence; area, 1,868 sq. m.; pop. in 1870, 63,415. Black river intersects it, and it is watered by other streams. The land rises gradually from the lake to a height of 1,000 ft. There are low ridges in the N. E. parallel with the St. Lawrence, and marshes in the S. W. The soil is generally fertile. Iron ore, lead, and copper are found. The Rome, Watertown, and Ogdensburgh railroad and Cape Vincent branch traverse it. The chief productions in 1870 were 228,772 bushels of wheat, 221,551 of Indian corn, 1,058,227 of oats, 413,704 of barley, 86,602 of peas and beans, 507,349 of potatoes, 104,459 lbs. of wool, 262,738 of hops, 35,850 of flax, 529,109 of maple sugar, 4,883,508 of butter, 2,545,654 of cheese, and 223,343 tons of hay. There were 15,564 horses, 72,980 milch cows, 23,525 other cattle, 26,390 sheep, and 13,930 swine, 6 manufactories of agricultural implements, 9 of cheese boxes, 35 of carriages, 79 of cheese, 21 of clothing, 4 of confectionery, 1 of cotton goods, 21 of furniture, 10 of iron castings, 1 of blooms, 11 of machinery, 4 of malt, 6 of paper, 3 of pumps, 34 of saddlery and harness, 8 of sash, doors, and blinds, 1 of sewing machines, 1 of steel springs, 24 of tin, copper, and sheet-iron ware, 6 of woollen goods, 36 saw mills, 5 breweries, 19 tanneries, 9 currying establishments, and 40 flour mills. Capital, Watertown. **II.** A W. county of Pennsylvania, drained by Mahoning and Red Bank creeks; area, 950 sq. m.; pop. in 1870, 21,656. The surface is hilly and well timbered, and the soil generally fertile. Iron ore and anthracite coal are abundant. The chief productions in 1870 were 78,618 bushels of wheat, 64,678 of rye, 200,484 of Indian corn, 390,151 of oats, 46,632 of buckwheat, 54,596 of potatoes, 56,621 lbs. of wool, 497,951 of butter, and 18,914 tons of hay. There were 4,855 horses, 5,391 milch cows, 6,029 other cattle, 20,029 sheep, and 8,889 swine; 2 manufactories of agricultural implements, 8 of carriages, 8 of furniture, 4 of iron castings, 1 of machinery, 7 of saddlery and harness, 4 of woollen goods, 11 tanneries, 7 currying establishments, 1 distillery, 3 planing mills, and 44 saw mills. Capital, Brookville. **III.** The N. E. county of West Virginia, separated from Maryland on the N. E. by the Potomac river, bounded N. W. by Opequan creek, and S. and S. E. by Virginia, and intersected by the Shenandoah; area, 260 sq. m.; pop. in 1870, 13,219, of whom

3,488 were colored. It has a rolling surface and a fertile soil resting on a bed of limestone. The Blue Ridge lies on the S. E. border. The Baltimore and Ohio and the Winchester and Potomac railroads pass through it. The chief productions in 1870 were 468,841 bushels of wheat, 336,287 of Indian corn, 44,077 of oats, 24,305 of potatoes, 28,699 lbs. of wool, 120,374 of butter, and 5,753 tons of hay. There were 3,694 horses, 2,489 milch cows, 3,313 other cattle, 6,521 sheep, and 9,151 swine, 4 manufactories of woollen goods, 5 of tin, copper, and sheet-iron ware, 1 of paper, 4 of cooperage, 1 of cement, 1 tannery, 6 flour mills, and 8 saw mills. Capital, Charlestown. **IV.** An E. county of Georgia, intersected by Ogeechee river and Brier creek; area, 634 sq. m.; pop. in 1870, 12,190, of whom 7,943 were colored. It has a level surface, and contains bauxite, agates, chalcidony, and carnelian. The soil was originally fertile. The Georgia Central railroad passes through it. The chief productions in 1870 were 11,949 bushels of wheat, 211,528 of Indian corn, 22,514 of sweet potatoes, and 6,885 bales of cotton. There were 643 horses, 1,023 mules and asses, 1,598 milch cows, 3,432 other cattle, 4,440 sheep, and 8,686 swine. Capital, Louisville. **V.** A N. county of Florida, bordering on Georgia and Appalachee bay, and bounded E. by the Ocala river; area, 470 sq. m.; pop. in 1870, 13,398, of whom 6,374 were colored. The surface is undulating and the soil fertile. The Jacksonville, Pensacola, and Mobile railroad and Monticello branch traverse it. The chief productions in 1870 were 238,728 bushels of Indian corn, 15,163 of sweet potatoes, 24 hog-heads of sugar, 21,773 gallons of molasses, and 6,051 bales of cotton. There were 494 horses, 1,025 mules and asses, 1,635 milch cows, 3,378 other cattle, 956 sheep, and 7,094 swine. Capital, Monticello. **VI.** A central county of Alabama, drained by Black Warrior and Cahawba rivers; area, 1,040 sq. m.; pop. in 1870, 12,345, of whom 2,506 were colored. It has a hilly surface and a fertile soil. Coal, iron, and timber are abundant. The Alabama and Chattanooga and the South and North Alabama railroads traverse it. The chief productions in 1870 were 45,219 bushels of wheat, 251,184 of Indian corn, 24,193 of sweet potatoes, 31,566 lbs. of butter, and 1,470 bales of cotton. There were 1,754 horses, 3,094 milch cows, 1,414 working oxen, 3,852 other cattle, 5,437 sheep, and 13,753 swine. Capital, Elyton. **VII.** A S. W. county of Mississippi, separated from Louisiana by the Mississippi river; area, 680 sq. m.; pop. in 1870, 13,848, of whom 10,633 were colored. It has a fertile soil, and the E. part is occupied by pine woods. The chief productions in 1870 were 204,464 bushels of Indian corn, 31,386 of sweet potatoes, 32,235 lbs. of butter, and 13,719 bales of cotton. There were 1,681 horses, 1,964 mules and asses, 3,215 milch cows, 1,584 working oxen, 4,825 other cattle, 2,118 sheep, and 7,629

swine. Capital, Fayette. VIII. A S. E. parish of Louisiana, extending from Lake Pontchartrain to Barataria bay, and crossed by the Mississippi; area, 884 sq. m.; pop. in 1870, 17,767, of whom 11,054 were colored. The surface is level and partly occupied by marshes and lakes. The soil is fertile. The New Orleans, Jackson, and Great Northern, the New Orleans, Mobile, and Texas, and Morgan's Louisiana and Texas railroads pass through it. The chief productions in 1870 were 67,460 bushels of Indian corn, 8,071 of Irish and 7,640 of sweet potatoes, 456 bales of cotton, 269,620 lbs. of rice, 2,196 hogsheads of sugar, and 136,300 gallons of molasses. There were 195 horses, 828 mules and asses, 533 cattle, and 386 sheep; 4 manufactories of brick, and 7 of molasses and sugar. Capital, La Fayette. IX. The S. E. county of Texas, separated from Louisiana by Sabine lake and pass, bounded N. E. by the Neches, and S. by the gulf of Mexico; area, 900 sq. m.; pop. in 1870, 1,906, of whom 498 were colored. The surface consists chiefly of vast savannas, which pasture large herds of horses and cattle. The chief productions in 1870 were 15,282 bushels of Indian corn, 8,880 of sweet potatoes, and 15,150 lbs. of rice. There were 1,758 horses, 743 milch cows, 15,807 other cattle, 642 sheep, and 535 swine. Capital, Beaumont. X. A S. E. county of Arkansas, traversed by Arkansas river, which is here navigable by steamboats; area, about 900 sq. m.; pop. in 1870, 15,738, of whom 10,167 were colored. The surface is level and the soil fertile. The chief productions in 1870 were 303,125 bushels of Indian corn, and 18,390 bales of cotton. There were 2,211 horses, 1,936 mules and asses, 3,281 milch cows, 4,815 other cattle, 1,079 sheep, and 17,098 swine; 1 manufactory of agricultural implements, 1 of carriages, and 6 saw mills. Capital, Pine Bluff. XI. An E. county of Tennessee, bounded N. W. by Holston river and drained by the French Broad; area, 356 sq. m.; pop. in 1870, 19,476, of whom 2,910 were colored. It has a hilly and well wooded surface, and contains iron ore. The soil is fertile. The East Tennessee, Virginia, and Georgia, and the Cincinnati, Cumberland Gap, and Charleston railroads pass through it. The chief productions in 1870 were 135,764 bushels of wheat, 527,853 of Indian corn, 132,453 of oats, 22,892 lbs. of wool, 75,583 of butter, and 3,923 tons of hay. There were 3,210 horses, 3,097 milch cows, 4,828 other cattle, 11,598 sheep, and 11,971 swine; 4 manufactories of agricultural implements, 1 of paints, 1 flour mill, and 3 saw mills. Capital, Dandridge. XII. A N. county of Kentucky, separated from Indiana by the Ohio river; area, 330 sq. m.; pop. in 1870, 118,953, of whom 19,146 were colored. The surface is diversified and the soil fertile. The Louisville and Nashville and the Louisville, Cincinnati, and Lexington railroads pass through it. The chief productions in 1870 were 102,820 bushels of wheat, 1,059,729 of Indian corn,

368,323 of oats, 49,975 of barley, 377,362 of Irish and 104,862 of sweet potatoes, 35,263 lbs. of wool, 812,238 of butter, and 11,228 tons of hay. There were 6,360 horses, 1,369 mules and asses, 6,268 milch cows, 3,071 other cattle, 7,089 sheep, and 34,575 swine. There were altogether 801 manufacturing establishments, chiefly in Louisville, the county seat; capital invested, \$11,129,291; value of products, \$20,364,650. XIII. An E. county of Ohio, separated from West Virginia by the Ohio river; area, 396 sq. m.; pop. in 1870, 29,188. The surface is uneven, the soil rich, and coal abundant. The Pittsburgh, Cincinnati, and St. Louis railroad and the river division of the Cleveland and Pittsburgh railroad pass through it. The chief productions in 1870 were 215,694 bushels of wheat, 630,196 of Indian corn, 430,384 of oats, 44,263 of barley, 122,530 of potatoes, 664,512 lbs. of wool, 561,047 of butter, and 28,569 tons of hay. There were 5,577 horses, 5,429 milch cows, 6,837 other cattle, 154,668 sheep, and 11,627 swine; 15 manufactories of carriages, 3 of brick, 1 of cars, 11 of clothing, 1 of rectified coal oil, 4 of coke, 1 of glassware, 8 of iron, 3 of machinery, 1 of printing paper, 5 of woollen goods, 6 tanneries, 2 currying establishments, 1 distillery, 2 breweries, 5 flour mills, and 5 saw mills. Capital, Steubenville. XIV. A S. E. county of Indiana, separated from Kentucky by the Ohio river; area, 362 sq. m.; pop. in 1870, 29,741. It has a diversified surface and a rich soil. The Jeffersonville, Madison, and Indianapolis, and the Ohio and Mississippi railroads pass through it. The chief productions in 1870 were 207,909 bushels of wheat, 466,246 of Indian corn, 131,321 of oats, 40,028 of barley, 98,952 of potatoes, 85,707 lbs. of wool, 408,565 of butter, and 20,933 tons of hay. There were 6,406 horses, 5,289 milch cows, 7,006 other cattle, 18,921 sheep, and 19,757 swine, and numerous manufacturing establishments, chiefly in Madison, the county seat. XV. A S. county of Illinois, drained by the head streams of Big Muddy river; area, 576 sq. m.; pop. in 1870, 17,864. The surface is diversified by prairies and tracts of timber, and the soil is moderately fertile. The St. Louis and Southeastern railroad passes through it. The chief productions in 1870 were 100,553 bushels of wheat, 887,981 of Indian corn, 285,949 of oats, 52,309 of potatoes, 99,469 lbs. of tobacco, 52,957 of wool, 150,298 of butter, and 10,460 tons of hay. There were 6,006 horses, 1,878 mules and asses, 3,908 milch cows, 6,484 other cattle, 22,759 sheep, and 24,805 swine; 4 manufactories of carriages, 5 of saddlery and harness, 1 of woollen goods, 3 flour mills, and 5 saw mills. Capital, Mount Vernon. XVI. A S. E. county of Wisconsin, drained by Rock, Crawfish, and Bark rivers, and by Koshkonong lake, an expansion of Rock river; area, 576 sq. m.; pop. in 1870, 34,040. The surface is generally level or undulating, and is well timbered, particularly

in the E. part. The soil is good, the valley of Rock river being of remarkable fertility. The La Crosse and St. Paul, the Prairie du Chien, and the Madison divisions of the Milwaukee and St. Paul railroad, and the Wisconsin division of the Chicago and Northwestern railroad traverse it. The chief productions in 1870 were 678,715 bushels of wheat, 34,374 of rye, 579,233 of Indian corn, 470,466 of oats, 50,310 of barley, 296,103 of potatoes, 203,403 lbs. of wool, 206,755 of hops, 908,119 of butter, 84,201 of cheese, and 50,055 tons of hay. There were 8,409 horses, 11,701 milch cows, 11,969 other cattle, 49,118 sheep, and 14,965 swine; 5 manufactories of agricultural implements, 8 of brick, 25 of carriages, 5 of cheese, 16 of cooperage, 12 of furniture, 4 of iron castings, 2 of cotton and woollen machinery, 10 of saddlery and harness, 3 of sash, doors, and blinds, 9 of tin, copper, and sheet-iron ware, 2 of woollen goods, 2 tanneries, 14 breweries, 15 flour mills, and 11 saw mills. Capital, Jefferson. XVII. A S. E. county of Iowa, drained by Skunk river and Big Cedar creek; area, 380 sq. m.; pop. in 1870, 17,839. The surface is occupied by rich rolling prairies and forests of oak, ash, hickory, maple, &c. The Burlington and Missouri River railroad and the Southwestern branch of the Chicago, Rock Island, and Pacific traverse it. The chief productions in 1870 were 234,779 bushels of wheat, 1,100,560 of Indian corn, 242,364 of oats, 72,637 of potatoes, 107,394 lbs. of wool, 403,782 of butter, and 26,335 tons of hay. There were 9,150 horses, 6,365 milch cows, 11,330 other cattle, 29,300 sheep, and 32,845 swine; 4 manufactories of carriages, 2 of furniture, 1 of machinery, 7 of saddlery and harness, 2 of woollen goods, and 3 saw mills. Capital, Fairfield. XVIII. An E. county of Missouri, separated from Illinois by the Mississippi river, and drained by Maramac river and its branches; area, 500 sq. m.; pop. in 1870, 15,380, of whom 763 were colored. The surface is diversified, and the soil is of various qualities. Rich mines of lead are worked, and copper and cobalt are also found. The St. Louis and Iron Mountain railroad passes through it. The chief productions in 1870 were 149,298 bushels of wheat, 534,705 of Indian corn, 134,279 of oats, 76,278 of potatoes, 25,235 lbs. of tobacco, 18,152 of wool, 152,334 of butter, 6,426 gallons of wine, 29 bales of cotton, and 5,675 tons of hay. There were 4,639 horses, 1,374 mules and asses, 4,739 milch cows, 1,235 working oxen, 5,999 other cattle, 10,722 sheep, and 24,882 swine; 3 flour mills, 1 manufactory of kaolin and ground earths, and 3 of pig lead. Capital, Hillsborough. XIX. A N. E. county of Kansas, bounded S. by Kansas river, and intersected by Grasshopper river; area, 550 sq. m.; pop. in 1870, 12,526. The surface is undulating, and the soil fertile. Timber and limestone are abundant, and coal has been found in several parts. The Kansas Pacific and the Atchison,

Topeka, and Santa Fé railroads pass through it. The chief productions in 1870 were 32,302 bushels of wheat, 1,257,790 of Indian corn, 210,040 of oats, 142,405 of potatoes, 261,161 lbs. of butter, and 18,925 tons of hay. There were 6,313 horses, 6,215 milch cows, 13,633 other cattle, 4,072 sheep, and 21,818 swine; 3 flour mills, 6 saw mills, and 1 woollen factory. Capital, Oskaloosa. XX. A S. E. county of Nebraska, bordering on Kansas, and intersected by Little Blue river; area, 376 sq. m.; pop. in 1870, 2,440. The soil is fertile. The chief productions in 1870 were 24,847 bushels of wheat, 72,230 of Indian corn, 15,199 of potatoes, 19,650 lbs. of butter, and 2,162 tons of hay. There were 528 horses, 507 milch cows, 905 other cattle, 791 sheep, and 712 swine. Capital, Fairburg. XXI. A central county of Colorado, situated partly in the foot hills and partly in the plains; area, about 800 sq. m.; pop. in 1870, 2,390. It is watered by small tributaries of the Platte, which afford good water power. The soil is fertile and easily irrigated. In the west are found copper, iron, coal, fire and potter's clay, and gypsum. The Colorado Central railroad terminates at the county seat. The chief productions in 1870 were 54,746 bushels of wheat, 8,625 of Indian corn, 45,523 of oats, 9,060 of barley, 15,890 of potatoes, 47,470 lbs. of butter, 8,860 of cheese, and 1,957 tons of hay. There were 433 horses, 1,026 milch cows, and 1,684 other cattle; 3 flour mills, 8 saw mills, and 2 manufactories of stone and earthenware. Capital, Golden City. XXII. A S. W. county of Montana, bounded E. by the Missouri river; area, 2,730 sq. m.; pop. in 1870, 1,531, of whom 122 were Chinese. It contains a large area of rich farming land, and is well adapted to stock raising. There are gold mines on the branches of the Missouri and Jefferson rivers. The chief productions in 1870 were 4,194 bushels of wheat, 11,584 of oats, 6,605 of barley, 11,693 of potatoes, 70,165 lbs. of butter, and 2,422 tons of hay. There were 572 horses, 2,484 milch cows, and 3,614 other cattle; 6 saw mills, and 8 quartz mills. Capital, Radersburg. XXIII. A W. county of Washington territory, bounded E. and N. E. by Hoods's canal and Admiralty inlet, and W. by the Pacific ocean; area, 1,670 sq. m.; pop. in 1870, 1,268. The interior is mountainous, and the surface is mostly covered with forests of pine and fir, but there is much land suitable for agriculture. The chief productions in 1870 were 7,650 bushels of wheat, 3,038 of oats, 4,373 of barley, 13,698 of potatoes, and 13,356 lbs. of butter. The value of live stock was \$37,674. There were 3 saw mills, producing \$326,050 worth of lumber during the year. Capital, Port Townsend.

JEFFERSON, a city and the county seat of Marion co., Texas, situated on Big Cypress bayou, 4 m. above its entrance into Soda lake, which empties into Red river, and on a branch of the Texas and Pacific railroad, 260 m. N. E. of Austin and 40 m. N. W. of Shreveport, La.:

pop. in 1860, 988; in 1870, 4,190, of whom 1,625 were colored. In the vicinity are deposits of coal and iron ore. The river is navigable to this point by large steamers, and the city is the shipping point for a large extent of fertile country, the principal articles being cotton, cattle, hides, beef, tallow, wool, and Osage orange seeds. The principal manufactories are a foundery, saw mills, planing mills, sash and door factories, and brick-making establishments. There is also an extensive foundery about 4½ m. from the city. There are a national and a savings bank, ten schools, three newspapers, and seven churches. Jefferson was first settled in 1843.

**JEFFERSON, Thomas**, third president of the United States, born at Shadwell, Albemarle co., Va., April 2, 1743, died at Monticello, July 4, 1826. His father was Col. Peter Jefferson, a planter of great force of character and high position; his mother, Jane Randolph, daughter of Isham Randolph of Dungeones in Goochland. At five years of age he was placed at an English school, and at nine commenced the study of Greek, Latin, and French under Mr. Douglass, a Scottish clergyman. Upon his father's death in 1757, he was sent to the classical school of the Rev. Mr. Maury, where he continued for two years, passing thence at the age of 17 to the college of William and Mary at Williamsburg. He soon became popular with his companions and the college professors, and is described at this time as ardent and impulsive in demeanor, with a tall, thin, and angular person, ruddy complexion, red hair, and bright gray eyes flecked with hazel. Among the friends whom he made was Francis Fauquier, the popular governor of the colony. After remaining in college two years, he studied law with George Wythe, and commenced practice in 1767 at the bar of the general court, attending also the county courts of his district. He is said to have been but slightly acquainted with the practice of the profession, and an infrequent speaker; yet during the first two years of his practice he was employed in about 200 suits, his fees amounting to at least £600, at a time when fees were very moderate. The record of the two succeeding years shows a regular increase, and in 1771 Robert Carter Nicholas, an eminent lawyer, intrusted to him all of his unfinished business. In 1769, at the age of 26, he was chosen to represent his county in the house of burgesses, where he at once took a prominent stand with the opponents of parliamentary encroachment, drafting the resolutions to be used as heads in framing a reply to Governor Botetourt's address, and signing the non-importation agreement. At this his first session he introduced a bill empowering the owners of slaves to manumit them if they thought proper; it was defeated, and its policy not fully embraced till 1782. Jefferson returned to his practice, and in the following year removed from Shadwell to a new residence but partially finished, which after-

ward became famous as "Monticello." On Jan. 1, 1772, he was married to Martha Skelton, widow of Bathurst Skelton, and daughter of John Wayles, an influential lawyer of Charles City. This lady, then 28 years of age, and remarkable for the beauty of her person and the grace of her manners, brought him a very considerable fortune. She had inherited 185 slaves and 40,000 acres of land, the value of the whole being about equal to Jefferson's own patrimony. The two combined formed an ample estate, and Jefferson's practice added largely to his income. In the spring of 1773 he was appointed by the house of burgesses a member of the "committee of correspondence and inquiry for the dissemination of intelligence between the colonies," the plan of which he had aided in devising. The house was dissolved by the governor; its members were reelected and resumed their seats in the spring of 1774; and it was again dissolved after adopting a resolution drafted by Jefferson and a few associates at a private meeting, recommending the observance of June 1 as "a day of fasting, humiliation, and prayer," in consequence of the passage of the Boston port bill in parliament. The members met privately, and recommended the election of deputies from the counties to a convention to meet on Aug. 1. Jefferson was chosen a member of this convention, but was taken sick just before the assembling of the body, and could not attend. He had however drawn up a paper to serve for instructions to the delegates to the general congress which the committee of correspondence had been directed to propose to all the colonies, and this he sent to Peyton Randolph, the president of the convention. The document was afterward ordered by the burgesses to be printed under the title of "A Summary View of the Rights of British America," and, as Jefferson believed, procured the enrolment of his name on a bill for treason brought into parliament. It was a bold, elaborate, and eloquent exposition of the right of the colonies to resist taxation, and contained the germ of the subsequent declaration of independence. The paper was offered, but not adopted, being regarded as too much in advance of public sentiment. The people were not yet ripe for resistance by force, and even the leaders still believed in the possibility of renewing the old amicable relations with Great Britain. Such a restoration of good feeling was warmly hoped for by the planters generally. A "redress of grievances" was all that the foremost leaders aimed at thus early, and the tone of the appeal for redress was the point at issue. The "Summary View" was printed in England as well as in Virginia, and extensively made use of by opposition speakers in parliament. Its influence upon the fortunes of Jefferson was marked; it placed him before the public as a courageous and uncompromising advocate of constitutional freedom, and above all as a most accomplished and eloquent writer. He attended the second convention, which met

in March, 1775, and was placed upon the committee to report a plan of defence, which was soon drawn up. The convention then proceeded to elect delegates to congress, and Jefferson was chosen as the alternate of Peyton Randolph, who might be retained by his office of president of the house in Virginia. This was the case when Gov. Dunmore summoned the burgesses to meet on June 1. Jefferson was present, and at the request of his associates drew up before leaving Williamsburg the reply of the Virginia assembly to Lord North's "conciliatory proposition." This bold and forcible paper he carried with him to Philadelphia soon afterward. Eight days before his arrival Washington had been appointed by congress commander-in-chief of the armies of the colonies. America was thus in open resistance against the crown. Jefferson's arrival was anxiously expected, as he was known to be the bearer of the reply of Virginia to Lord North's proposal; and when the reply was delivered to congress, it met with the warmest approbation. As the author of the paper, and of the "Summary View" in the preceding year, Jefferson took his position among the leaders of the body. He had "the reputation of a masterly pen," says John Adams, and "writings of his were handed about, remarkable for the peculiar felicity of expression." He was silent upon the floor, but in committee was so "prompt, frank, explicit, and decisive," says the same authority, that he won the cordial regard as well as respect of his associates. He was at once placed upon the committee to draw up the declaration of the cause of taking up arms, and aided John Dickinson in drafting the paper, of which congress approved. The body then proceeded to act upon Lord North's proposition; and Jefferson, as author of the answer of Virginia, was requested by the committee, of which he was a member, to prepare that of congress. He did so, nearly in the words of the former paper. Congress adopted it, and then adjourned. In November the news arrived of the rejection of the last petition. On May 15, 1776, Virginia instructed her delegates to propose a declaration of the independence of the colonies; and congress now solemnly approached that great event. Early in June a committee to draw up the declaration was appointed, with Jefferson for its chairman. He was "unanimously pressed to undertake the draft" by his associates of the committee, and did so, Franklin and Adams only making two or three verbal alterations in it. It was laid before congress on June 28. On July 2, the resolution to declare the colonies independent, which had been introduced by Richard Henry Lee, in accordance with the Virginia instructions, passed the body, and the draft of the declaration was taken up. The debate upon the paper, as to its tone, its statements, and the propriety of adopting at that time a measure so extreme, lasted for nearly three days, and was very hot. It was so powerfully

opposed by some of the members, that Jefferson compared the opposition to "the ceaseless action of gravity, weighing upon us by night and by day." Its supporters, however, were the leading minds, and urged its adoption with masterly eloquence and ability. On July 4 the declaration with the amendments was agreed to; and thus commenced the republic of the United States of America. The paper has justly secured a renown more extended perhaps than that of any other state paper in existence. Two questions have however arisen as to its originality: the first upon the substance of the document; the second in regard to its phraseology, in connection with the alleged Mecklenburg declaration of May, 1775. It is more than probable that Jefferson made use of some of the ideas expressed in newspapers, conversation, and by public speakers at the time; and that his study of the great English writers upon constitutional freedom was of service to him. But an impartial criticism will not base upon the fact a charge of want of originality. It should rather be regarded as the peculiar merit of the writer that he thus collected and embodied the conclusions upon government of the leading thinkers of the age in Europe and America, rejecting what was false, and combining his material into a production of so much eloquence and dignity. The "Summary View" of 1774 will however be found to contain the complete germ of the "Declaration;" and as the originality of the former has not been impeached, the merit of the latter is in every fair sense due to Jefferson. The second charge, that he made use of the alleged Mecklenburg paper, has excited volumes of controversy. Jefferson distinctly denied that he had ever seen it at the time, and John Adams declared that he had not himself met with it. Jefferson was rechosen a delegate to congress, but resigned the appointment. "The laboring oar," he wrote, was at home in Virginia. His aim now was to carry out radical changes in the laws of his native state. The new era could not commence there until fundamental reforms had taken place, and the practicability of such reforms had long engaged his attention. The first movement in the proposed direction had been the formation by the convention of a constitution for the commonwealth. Just before the composition of the declaration, Jefferson had drawn up a preamble and outline sketch of the proposed instrument, and sent it to Edmund Randolph, president of the convention then sitting. George Mason had however framed a constitution upon which the final vote was about to be taken. Jefferson's draft was not proposed, but his preamble was prefixed to the work of Mason. The great reforms in the organic laws were still unattained, and to these Jefferson ardently addressed himself. He was elected to represent his county, and declining the appointment by congress to become one of the commissioners to negotiate the now important treaties of commerce and

alliance with France, he took his seat in the Virginia house in October, 1776. He commenced at once by obtaining leave to bring in bills for cutting off entails, and for a general revision of the laws of the commonwealth. A committee of revision was appointed, and Jefferson placed at the head of it, with Edmund Pendleton and other distinguished lawyers for colleagues. The work employed the committee for more than two years, and was arduous in the extreme. To Jefferson were allotted the common law and statutes to the 4th of James I.; and he applied himself with zeal to the revision. To the more important bills which he brought in, the opposition was resolute and bitter. The explanation of this fact may be found in a few sentences of his memoir: "I considered four of these bills as forming a system by which every fibre would be eradicated of ancient or future aristocracy. . . . The repeal of the laws of entail would prevent the accumulation and perpetuation of wealth in select families. . . . The abolition of primogeniture, and equal partition of inheritances, removed the feudal and unnatural distinctions which made one member of every family rich and all the rest poor. . . . The restoration of the rights of conscience relieved the people from taxation for the support of a religion not theirs, for the establishment was truly the religion of the rich." The latter reference is to the bill "for establishing religious freedom." On the adoption of this, and the proposition to cut off entails and abolish the right of primogeniture, took place the determined stand which has been mentioned. From the peculiar character of Virginia society at the period, no measures could have been more revolutionary. The dominant class was essentially aristocratic, and the law of primogeniture represented their deliberate views of social order; the establishment was dear to them as the church of their ancestors, and as the bulwark of Protestant Christianity against heresy and superstition. The contest was prolonged for years, and enlisted all the ability of the commonwealth. The advocates and opponents of the measures fought with the desperation of men who were contending for the dearest prizes of existence. The bills all finally passed, and the reorganization was complete. When Jefferson drew up the epitaph to be inscribed upon his tomb, he added to the words, "author of the Declaration of Independence," those others, "and of the statute of Virginia for religious freedom." In addition to these radical measures, Jefferson was the author of others of importance, for the establishment of courts of law, and a complete system of elementary and collegiate education. He continued to sit in the house in 1777 and 1778. In the former year he strongly opposed the alleged scheme for appointing Patrick Henry dictator. In the latter year he proposed and procured the passage of a bill forbidding the future importation of slaves. In the spring of 1779 he was busily employed in ameliorating

the condition of the British prisoners at Charlottesville. On June 1 he was elected governor of Virginia. He entered upon office at a gloomy period in the history of the country. The last campaign had not been encouraging to the American arms, and the enemy were about to carry the war into the south. Jefferson found the commonwealth almost defenceless. Virginia had nearly 10,000 troops in the army of the United States, and the steady drain upon her other resources had so greatly enfeebled her that there was little prospect of her being able to resist an enemy. The southern campaign began in Georgia and the Carolinas, and the resources of the colonies were laid under a heavy tax for raising supplies. Virginia was so profuse in contributions of men, arms, horses, and provisions, that she was soon completely exhausted. Her extended coast and the banks of her great rivers were wholly unfortified. A few small vessels and gunboats, imperfectly manned and equipped, were all that she could oppose to the approach of an enemy's fleet. Gen. Leslie easily took possession of Hampton and Portsmouth, and Arnold ascended James river almost unresisted with fewer than 2,000 men. He entered Richmond, which had recently become the capital, on Jan. 5, 1781. The public functionaries, including the governor, retired before the enemy; but Jefferson remained until they entered the lower part of the town, and afterward busied himself in their immediate vicinity in attempts to protect the public stores. Arnold ravaged the place, burned some buildings, and then dropped down the river again. In April Gen. Phillips ascended the river and threatened Richmond; but receiving orders from Cornwallis, who had entered Virginia from the south, he joined the main army, then advancing in pursuit of Lafayette toward the Rapidan. Lafayette escaped, and Cornwallis determined to capture or disperse the legislature, which had adjourned to meet in Charlottesville. Tarleton was despatched upon this enterprise, and by a forced march he fell upon the body almost before they knew of his approach. They were dispersed, but without any captures; and Tarleton detached several of his troop to take the governor prisoner at Monticello, which was in sight of the town. Jefferson received intelligence of their approach, and hastily sent off his family. Having secured his more important papers, he followed on horseback, just in time to escape the party sent to take him. Tarleton rejoined Cornwallis, burning and ravaging on his way. Among other estates laid waste was Elk Hill, belonging to Jefferson, where a large amount of property was wantonly destroyed. The events attending this inroad of the enemy formed subsequently the basis of violent diatribes against Jefferson, who was declared to have received warning of the danger from Washington, but to have wantonly disregarded it, and neglected to put the state in a posture of defence. Additional charges were made,



discrediting his personal courage, on the ground of his withdrawal from Richmond and Monticello. But that he had the continued approbation of Washington in exhausting Virginia for the benefit of the general cause is certain; that the commonwealth, thus drained of her resources, could have been defended, is at least doubtful; and the circumstances of his withdrawal from Richmond and Monticello do not support the accusation of a want of personal courage. An error of judgment is thus all which might be justly chargeable upon Jefferson. His term of office had expired two days before Tarleton entered Charlottesville, and in his memoir he says that he had determined to decline a reelection, "from a belief that under the pressure of the invasion, under which we were then laboring, the public would have more confidence in a military chief." At the next session of the house a young member demanded an inquiry into his conduct; but it was never made, though Jefferson, who had gone to the assembly to meet it, rose in his place and also demanded it. On the contrary, the house resolved "that the sincere thanks of the general assembly be given to our former governor, Thomas Jefferson, for his impartial, upright, and attentive administration while in office." But the charges against his administration wounded him deeply, and he did not appear in the spring session of 1782.—From his retirement at Monticello, which had been recently rendered doubly gloomy by the death of his wife, he was summoned by congress to act as one of the plenipotentiaries to England, to negotiate the terms of the treaty of peace. The business was so far advanced before he was ready to sail that congress recalled the appointment; but taking his seat in that body in the winter session of 1783, he reported, as chairman of the committee to which it had been referred, the definitive treaty of peace with England. At the succeeding session Jefferson proposed and secured the adoption of the present system of United States coinage, doing away with the old £. s. d., and substituting the dollar and its subdivisions, down to the hundredth part, to which, in order to describe its value, he gave the present name of cent. At the same session he drafted the report of the committee appointed to "prepare a plan for the temporary government of the western territory." Virginia held this great extent of country under charter from James I. In 1780 she ceded to the confederation the whole territory N. W. of the Ohio, but the cession was not then formally consummated. Jefferson's plan of a government for this territory was adopted with a few amendments; these consisted of an omission of the names suggested for the districts, and of the clause providing "that after the year 1800 of the Christian era there shall be neither slavery nor involuntary servitude in any of the said states, otherwise than in punishment of crimes, whereof the party shall be duly convicted to have been personally guilty." The

cession was finally consummated in 1783.—In May, 1784, Jefferson was appointed minister plenipotentiary to Europe, to assist John Adams and Benjamin Franklin in negotiating treaties of commerce. He sailed in July with his elder daughter, and was joined by his associates in Paris. They succeeded in negotiating treaties with Prussia and Morocco, the ships of which latter government had made depredations on American commerce. By the treaties blockades were abolished, the flag covered the cargo, and contrabands were exempted from confiscation. With England all negotiations failed. At this time Jefferson printed and distributed among his friends a small edition of his "Notes on Virginia." The substance of this work had been prepared in 1782, at the request of M. de Marbois, French secretary of legation, in hours of confinement produced by a fall from horseback. An incorrect copy had been printed, and the author now published it in an accurate form. In the same year he furnished, at the request of the Virginia directors, a plan for the capitol at Richmond, on the model of the *maison carrée* at Nîmes, and another for a penitentiary, similar to a building which he had examined in England. Both plans were adopted with some alterations. In 1785 congress appointed Jefferson minister plenipotentiary to France, in place of Franklin, who had resigned. He combated the intrigues of Vergennes and Calonne, the French ministers, in opposition to the desired treaties of commerce, with energy and effect. Among other objects which he obtained were the abolition of a number of monopolies, and the admission into France of tobacco, rice, whale oil, salted fish, and flour. In the midst of these duties he found time to make excursions into Germany, Italy, and the French provinces. In Paris he became intimately acquainted with Condorcet, D'Alembert, Destutt de Tracy, and other liberal thinkers. This seems to have been one of the happiest periods of his life; and his sympathies toward France remained ever afterward unshaken. He left the country before the excesses of the revolution, and always regarded it with a strong feeling of preference, especially in comparison with England. His diplomatic functions were performed with marked ability. The adoption of the American constitution did not meet his full approval. He did not know, he wrote, whether the good or the bad predominated in the instrument, and some portions "staggered" him. He afterward formed a more favorable opinion of it.—In 1789 he obtained leave of absence for a time, and returned to America. Soon after his arrival he was offered the post of secretary of state in Washington's cabinet, and in spite of his desire to return to France, accepted it, thus terminating his ministerial career. With the entrance of Jefferson into the cabinet in March, 1790, commenced the struggle between the federalists and republicans, under the banners of their two most distinguished leaders. Alexander Hamilton, secretary of the

treasury, stood at the head of the former. Jefferson was a democrat by nature and training; strongly opposed to England and the English system, against which he had struggled from the moment of his entrance into public affairs; and an unyielding advocate of state sovereignty and decentralization. His visit to Europe had strengthened these convictions of the danger of strong governments, and the uprising of the French people had secured his cordial sympathy. In the cabinet of Washington he now represented the principles of the republican party, who opposed a strong government as tending to monarchy, advocated state sovereignty as the only true republicanism, and espoused the cause of France in opposition to England. In all the great measures Hamilton defeated his rival. The entire system of finance, including the establishment of a bank of the United States, proposed by the secretary of the treasury, was adopted in spite of the protest of Jefferson, and of Randolph the attorney general. In February, 1791, Jefferson wrote an able report upon the cod and whale fisheries, recommending congress to protect those valuable branches of trade. Later in the same year he conducted an important correspondence with Mr. Hammond, the British minister, in relation to alleged violations of the treaty of peace with England. Jefferson complained of non-compliance with that article of the treaty which contained stipulations against carrying away negroes or destroying property, and provided for the evacuation by Great Britain of all posts within the limits of the United States. Mr. Hammond replied, and Jefferson rejoined, when the correspondence closed; and the questions were not reopened for discussion until the more important differences occurred which were terminated by the treaty of 1794. In the spring of 1792 Jefferson drew up an elaborate report upon the relations of the United States with Spain. These involved the determination of boundaries, the exclusion of American citizens from the navigation of the Mississippi below our limits, interference with the Indian tribes, the restitution of fugitives from justice and of property carried off, and the terms of a commercial treaty. The negotiations were indefinitely protracted, and it was not until many years afterward that they were even partially successful. In the spring of 1793 arose the paramount question of the neutral policy and rights of the United States, in view of the declaration of war just made by France against Holland and Great Britain. Upon this question was put forth the entire strength of the two great leaders of the federal and republican parties in the cabinet. The republican party was enthusiastic in its sympathy for France in the struggle with her great enemies, and a disposition was immediately shown to fit out privateers in American ports to cruise against English vessels. This was energetically opposed by the federal leaders, who were anxious that no

cause of hostilities should be given to England, and held that the true policy of America was to preserve peace and friendship with all nations, but form entangling alliances with none. The president, who had just entered upon his second term, issued his proclamation warning the citizens of the United States against carrying to the hostile powers any articles deemed contraband of war, or performing other acts inconsistent with the duties of a friendly nation. This was advised by Jefferson, as by his colleagues. He however advocated the propriety of receiving a minister from the French republic, which was determined upon. This was followed by the appearance of Genet as minister, to succeed the former royal functionary, who had been recalled. Genet authorized the fitting out and arming of privateers, and empowered the French consuls throughout the United States to erect courts of admiralty to try and condemn prizes brought into American ports. The president ordered that his privateers should leave the ports immediately, notwithstanding which he armed a prize and ordered her to sail as a privateer. A violent debate took place in the cabinet in Washington's absence. Hamilton, supported by Knox, advocated the erection of a battery to prevent the vessel from sailing, and denounced Genet as an agent sent to embroil America with England. Jefferson opposed the scheme of a battery on the ground that the vessel would not sail, and that the matter was too trifling to cause hostilities with France. Washington arrived and addressed a heated note to Jefferson; but explanations were made. In spite of all, the vessel sailed. Genet then grew so insolent that the question arose whether he should not be ordered out of the country. It was determined, however, to request his recall. Jefferson says that he was in favor of "expressing that desire with great delicacy," but that "the others were for peremptory terms." Genet was finally recalled, and this affair terminated. It had aroused to the utmost extent all the bitterness in the hearts of the two great rivals, and the meetings of the cabinet were stormy. The last act of Jefferson as secretary of state was an elaborate report on commercial intercourse with foreign nations, with the measures necessary for regulating and improving it. In this paper he first enumerates the articles of export, with their value, and then states the various restrictions imposed upon them, calling attention to the best method of modifying or removing them. This report gave rise to long and animated discussions, and the measures secured the favor of a great majority of the national legislature; but a vote was not immediately taken, and the subject was lost sight of.—On Dec. 31, 1793, Jefferson resigned his place in the cabinet, and, returning to his home at Monticello, devoted himself to his private affairs, which had become somewhat embarrassed. In September, 1796, Washington announced that he would not

again be a candidate for the presidency, and thereupon the two great parties fixed upon John Adams and Thomas Jefferson as their nominees. In February, 1797, the votes were opened and counted in presence of both houses; and the highest number appearing in favor of Adams, with the next in favor of Jefferson, the former was declared, in accordance with the existing law, president of the United States, and the latter vice president. On March 4, 1797, Jefferson took the chair as president of the senate, and delivered a short address, in which he expressed his attachment to the laws, and his anxious wish to properly fulfil his duties. The greater part of the next four years was spent at Monticello, but Jefferson was a close observer of public events, and largely participated in affairs, through his wide correspondence. The reaction of public feeling, resulting from the excesses of the reign of terror, had almost overwhelmed the American sympathizers with France. The aggressions of the French directory, and the insulting reception of our envoys, paralyzed the enemies of the federalists. The "war message" of Adams in the spring of 1797 threw the country into unheard-of agitation. The general indignation against France swept all opposition before it. Congress declared all treaties annulled; merchant vessels were authorized to resist search; large sums were voted for defence; and these measures were soon followed by others still more energetic. The alien and sedition laws were passed; the former empowered the president to order out of the country such aliens as he considered dangerous, on pain of heavy penalties; the latter declared that printing or uttering false and malicious charges against the president or congress should be deemed seditious, and punished by fine and imprisonment. These measures were vainly opposed by the republican party. The whole nation was urgent for war, and Washington offered to take his place at the head of the army. Nothing was left for the republicans but to make an issue on the constitutionality of the alien and sedition laws, and even this was impossible in congress. "Finding themselves of no use there," they determined to resort to the state arenas; and the result was the Kentucky and Virginia "resolutions of '98." The former state was closely connected with Virginia, and Jefferson drafted the Kentucky resolutions, denouncing the obnoxious laws, and intimating a determination on the part of the states to proceed to armed resistance. They were followed in Virginia by similar resolves, drawn up by James Madison, opposing the consolidation measures of the federal party, and calling on the states to maintain their liberties inviolate. The spring of 1799 brought a revulsion in favor of the republicans. Adams sent envoys to France; Washington retired again to Mount Vernon; and the war spirit rapidly subsided. Washington died before the close of the year, and the brief pause

in political strife which succeeded the intelligence of his death was followed by more violent commotions than before. The elections in New York in the spring of 1800 were bitterly contested, but terminated in a republican triumph, which extended throughout the Union. The result was largely attributed to the intrigues of Aaron Burr, who became the republican candidate for vice president, with Jefferson for president. The federalists supported Adams and Pinckney. When the votes were opened, it was found that Jefferson and Burr were elected, but by an equal number of votes. The dilemma was serious, as the constitution did not require the specification of the office to which each was elected, and the decision devolved upon the house of representatives. Many weeks of violent struggles on the part of the supporters of the two candidates took place; but on the 36th ballot Jefferson was elected president and Burr became vice president. Jefferson took his seat March 4, 1801, at Washington, to which the capital had been removed some months before, and delivered an inaugural address which lucidly and eloquently summed up the principles of republican government. He had come in upon a swelling tide of popularity, and he carefully avoided all acts which would tend to diminish it. Few removals were made, and these chiefly of those who were appointed by Adams in the last hours of his administration. A general amnesty was granted to the federalists, and they seemed to gradually become merged in the masses, which every day grew more "republican." The old régime appeared to have suddenly passed away. A change in dress and manners followed the political success of the republicans. The reaction against the stately dignity and ceremony of Washington's era was headed by the new president, who would have no formal address from congress, and sent in his message by a common messenger. Everywhere the new philosophy of life was received with acclamations which swelled still higher the flood of Jefferson's popularity. In 1800 Louisiana had been ceded by Spain to France, and in 1802 the president opened a private correspondence with the French government, which resulted in the succeeding year in the purchase of the entire territory for the sum of \$15,000,000. The question of the constitutionality of that measure was evaded, and so great was the advantage which it secured that all opposition soon disappeared. In 1804 Captains Lewis and Clarke, under the auspices of Jefferson, set out to explore the continent to the Pacific, with instructions drawn up by the president's own hand. The expedition returned two years afterward with a mass of valuable information, which exhibited the skill of their instructions. In 1803 Commodore Preble vindicated American rights in the Mediterranean against the emperor of Morocco; Decatur in a small schooner entered the harbor of Tripoli, and burned the frigate *Philadelphia*.

under the guns of the enemy, returning without the loss of a man, and the Tripolitans were compelled to sue for peace. The acquisition of Louisiana, the naval victories, and the general prosperity throughout the nation, greatly increased the popularity of the administration; and Jefferson was reelected, with George Clinton of New York for vice president, for the term commencing March 4, 1805, by a majority of 148 out of 176 electoral votes. In 1806 Jefferson was called upon to arrest Aaron Burr for treasonable operations in the southwest. (See BURR.) The former position of the accused, and his prominence before the country, rendered the trial one of deep interest. It soon took a political complexion, and the opponents of the administration bitterly inveighed against the anxiety displayed by the president to procure a conviction. At the same time the country was powerfully excited by the loss of its profitable foreign trade as a neutral, through the British orders in council and Napoleon's Berlin decree, blockading European ports; and still more by the "right of search" asserted by Great Britain, under color of which American vessels were boarded, and their sailors impressed as subjects of the king. This wrong had been persistently opposed, but the claim was never relinquished. When, in June, 1807, the American frigate Chesapeake was fired upon by the British ship Leopard, and four of her crew were seized as deserters, the country was in a flame, and the president issued his proclamation, interdicting the entrance of British armed vessels into the ports or waters of the United States. In consequence of the continued hostile policy of France and England, congress in December passed an act laying an embargo upon American vessels, which were forbidden to leave any port of the United States. This law was violently opposed by the friends of the president to be intended as only temporary; and in February, 1809, congress repealed it from and after the 4th of the ensuing March, substituting an act of non-intercourse with France and England.—At this point in the history of the country Jefferson retired from office, and terminated his political career. He remained in retirement ever afterward, employing his time in the performance of his various duties as the head of a large plantation. In 1817 he took an active part in the measures then set on foot to establish the "central college" near Charlottesville, now the university of Virginia. In 1819 he superintended the erection of the building, and in the same year was chosen rector. The leading part which he took in founding this great institution was a subject of peculiar pride with him, and he directed "Father of the university of Virginia" to be inscribed upon his tombstone. In the spring of 1826, his fortunes having become greatly embarrassed by the generous scale of his expenditures and the profuse hospitality at Monticello, he was em-

powered by the legislature to dispose of his estates by lottery, with a view to the discharge of his liabilities. But the project was suspended, and then abandoned. His health had long been failing, and in June he rapidly declined. As midnight approached on July 3, he was evidently dying, but retained his memory, and muttered, "This is the fourth of July." He lived until past noon on the succeeding day, July 4, 1826, when he expired, a few hours before John Adams. On the same day and nearly at the same hour, just half a century before, these two great men had attached their signatures to the Declaration of Independence; and the coincidence of their death made a deep impression on the country.—Jefferson was an original thinker in every department of human concern, and essentially a reformer. He had no respect for claims of right founded only upon prescription, and attached no decisive weight to authority. In the old house of burgesses he opposed parliament upon abstract grounds which were clearly defined, and which became the bases of the subsequent struggle, inaugurated by the formal exposition of the same principles in the Declaration of Independence. In the general assembly of the state he attacked the time-honored system of aristocratic and religious intolerance, as in conflict with natural right, and for that reason wrongful, however fully acquiesced in and respected by preceding generations. He carried the rule of subjecting everything to the test of abstract reason into matters of religion, venerating the moral character of Christ, but refusing belief in his divine mission. In politics he was an opponent of strong government, and maintained that the world was governed too much. He was in favor of the free development and exercise of human power, so far as was consistent with the good order of society, and a jealous advocate of individualism. His aim in Virginia was to overthrow the old domination of the ruling classes, and raise the people. He carried the same principles to the study of the federal compact. Once convinced that the state rights doctrine of restriction was the true theory of the government, he fought for it with persistent energy. Thus commenced, on the threshold of his entrance into the cabinet, the long struggle against Hamilton, the federal champion. The first measure of that great leader, the funding law, had passed; and it was followed by the assumption of state debts, and by the United States bank, in spite of Jefferson's protest against the constitutionality of the measure. He did not waver, however, and the republican party, long suffering a series of defeats, never found its leader wanting, and finally in 1801 bore Jefferson triumphantly into the presidency. His devotion to state rights was so ardent that it led him to regard Shays's insurrection as a mere trifle, which the government made itself ridiculous by opposing. He could never get rid of the idea that Hamilton wished to create a mon-

archy in America. Such was Jefferson as a statesman and leader of a party under the old régime, which was ruled by his enemies. Under the new order of things, with his own party in power, the case was altered. The force of his opinions of the rights of individuals suffered a marked diminution when Aaron Burr openly bearded his authority. He threw the weight of his great office against Burr, and advised that one of his counsel, Luther Martin, should be indicted as an accomplice, in order to "put down this impudent and unprincipled federal bulldog." In the same manner, his state rights doctrines became modified. The executive authority had to be stretched to cover the purchase of Louisiana; and he became convinced on other occasions that the federal government, to use his own expression, must "show its teeth." In social life he faithfully carried out his democratic principles. He discarded every advantage which his birthright gave him, and mingled familiarly with the common people, as their equal. He was naturally a democrat, and held as a radical doctrine of his philosophy the principle that one man is no better than another. He was easily approached, and the natural amiability of his character rendered his society delightful to all classes. His dislike of all the trappings of authority was excessive. Not content with eradicating all traces of past authority and influence, he inaugurated a crusade against the old forms and ceremonies which had accompanied it. Washington had held levees, and awaited the two houses, standing in full dress to receive them. Jefferson abolished the practice, and sent his first message by an unofficial hand to avoid the address which was customary. A committee had been usually appointed to inform the president of his election; but Jefferson declared it was more in consonance with the simplicity of republican institutions to communicate the intelligence through the common post office. To all titles of honor he was strongly opposed. "Excellency," "Honorable," and even "Mr.," were distasteful to him. He could wish, he declared, that the last, too, might disappear. It was always "Thomas Jefferson," or "T. J.," not "Mr. Jefferson," who presented his respects to "the president," not "your excellency." These apparent trifles were in reality strong indications of the character of the man, and contributed powerfully to his popularity with the people. He was regarded as the epitome and incarnation of democracy, as opposed to the old world of aristocracy. These social traits were supported by consummate partisan ability. He never made a formal public speech, but his adroitness in politics was unsurpassed, and his management of persons and events for the accomplishment of the ends which he aimed at was masterly. The objects which he had in view were in a large measure attained by his elaborate correspondence. Monticello became the centre of a vast system of political nerves, extending their ramifications throughout the nation. In his retirement Jef-

erson was thus as powerful as in office. His hand was often felt as decisively, and his opinions, instilled into active minds holding high positions, became not seldom the ruling influence in public affairs. Slavery he regarded as a moral and political evil; but in opposing it he did not advocate a change in the agricultural character of the south. He wrote that the people would "remain virtuous as long as agriculture is our principal object, which will be the case while there remain vacant lands in America. When we get piled upon one another in large cities, as in Europe, we shall become corrupt as in Europe." At home he was a tender husband and father, a mild master, a warm friend, and a delightful host. His knowledge of life, extensive travels, and long familiarity with great events and distinguished men, rendered his conversation highly attractive to mere social visitors. His scientific acquisitions, and the deep interest which he took in all branches of natural history, made his society equally agreeable to men of learning. Many such visited him, and were impressed as deeply by his general knowledge as they were charmed by the courtesy of his demeanor. De Castellux, De Liancourt, and other noblemen and foreigners of distinction, came away from Monticello with an enthusiastic opinion of their host, and informed all Europe that the country gentleman of Virginia was the most accomplished man of his epoch. In entertaining this diverse society, in reading, writing, riding, and attending to his farms, passed the intervals of his absence from public affairs, and the long period of retirement which extended from the termination of his presidency to his death.—Of his "Notes on Virginia" many editions have been published; that issued at Richmond in 1853 was revised from his own annotated copy. His "Manual of Parliamentary Practice" is used by congress and other legislative bodies in America. A portion of his manuscripts were purchased by congress in 1848, edited by H. A. Washington, and published under the title, "The Writings of Thomas Jefferson; being his Autobiography, Correspondence, Reports, Messages, Addresses, and other Writings, Official and Private," &c. (9 vols. 8vo, Washington, 1853-'55). Among the biographical works relating to Jefferson, the most important are: "Memoirs, Correspondence, and Private Papers," edited by his grandson, Thomas Jefferson Randolph (4 vols., New York, 1829); "Life, and part of his unpublished Correspondence," by George Tucker (2 vols., Philadelphia, 1837); "Life," by Henry S. Randall (3 vols., New York, 1858); "Domestic Life," compiled from family sources, by his granddaughter Sarah N. Randolph (New York, 1871); and "Life," by James Parton (Boston, 1874).

**JEFFERSON CITY**, the capital of Missouri and seat of justice of Cole co., situated on the S. or right bank of the Missouri river, 143 m. above its confluence with the Mississippi, opposite the mouth of Cedar creek, and 125 m. W.

of St. Louis, with which it is connected by the Missouri Pacific railroad; pop. in 1860, 3,082; in 1870, 4,420, of whom 716 were colored; in 1874, about 7,500. It is built on elevated and uneven ground, commanding a fine view of the beautiful scenery on the N. bank of the river. The principal public edifices are the state house, a handsome building of stone, the governor's residence, the state penitentiary, several hotels, and eight churches of various denominations. The city has flour mills, manufactories of wooden and iron ware, carriages, furniture, &c., a state bank, two national banks, and two daily and two weekly newspapers. The state library contains about 12,000 volumes. There are graded public schools, divided in 1872 into 10 departments, including a high school, and having about 650 pupils, besides several denominational schools. The United States district court for the W. district of Missouri holds its sessions here.

**JEFFERSONIA**, a vernal plant of the natural order *berberidacea*, occurring in rich woods



Jeffersonia.

from western New York to Wisconsin and southward, named in honor of Thomas Jefferson. It is popularly known as twin-leaf, from its two-parted leaves, a character recognized in its specific name, *J. diphylla*; the long-petioled leaves arise in a tuft from the matted fibrous roots, and among them are naked flower stems, each terminated by a handsome white flower an inch in diameter, not unlike that of the bloodroot, and appearing in April and May. The calyx falls as the flower opens; petals and stamens eight; pistil single, which when ripe becomes a pear-shaped pod, which opens by a horizontal slit extending half way around it. In England the jeffersonia is valued as a plant for the spring border; well established clumps flower profusely, though the bloom is of short duration. Medicinal qualities have been attributed to the plant, which has in some localities the name of rheumatism root.

**JEFFERSONVILLE**, a city of Clarke co., Indiana, situated at the head of the falls on the Ohio river, nearly opposite Louisville, Ky.; pop. in 1850, 2,122; in 1860, 4,020; in 1870, 7,254. It is built on high ground on the site of old Fort Finney, and commands a magnificent view of the river and of Louisville. The streets are wide, well paved, and laid out at right angles with one another. It is the S. terminus of the Louisville division of the Ohio and Mississippi railroad, and of the Jeffersonville, Madison, and Indianapolis railroad, and is connected by a branch of the latter with New Albany, 5 m. below. The Ohio is here crossed by one of the finest bridges in the country, which connects these railroads with the lines diverging from Louisville. The Ohio is 1 m. wide in this part of its course, and in a distance of 2 m. has a fall of 26 ft., which affords unrivalled motive power. The depth of water is sufficient at all seasons for craft of large size, and steamboat building is an important branch of industry. There are a large manufactory of locomotives and cars, machine shops, mills, &c., and two national banks, with an aggregate capital of \$550,000. Jeffersonville is the seat of the southern state prison, with an average number of 395 convicts, and has a system of graded schools, embracing 18 departments, including a high school, with about 1,300 pupils; a weekly and two daily newspapers, and 11 churches.

**JEFFREY, Francis**, a Scottish critic, born in Edinburgh, Oct. 23, 1773, died at Craigerook, Jan. 26, 1850. He was the eldest son of a depute clerk in the court of session, and was educated at Edinburgh, Glasgow, and Oxford. At Glasgow he distinguished himself as one of the most acute and fluent speakers, and formed the habit of accompanying all his studies by collateral composition. He took little pleasure in his residence at Oxford, and after one session returned to Edinburgh, and attended the law classes at the university. At the same time he was busy with literature and poetry, and was admitted, Dec. 11, 1792, into the speculative society, in which for nearly ten years he trained his powers of speaking and writing, having among his competitors Walter Scott, Lord Henry Petty (marquis of Lansdowne), Henry Brougham, Francis Horner, John A. Murray, James Moncrieff, and Henry Cockburn. He was admitted to practice Dec. 16, 1794, but suffered under the disadvantages of being as devoted to literature as to law, and of having proclaimed himself a whig, while the effect of the revolutionary excesses of France not only debarred Scottish whigs from hope of preferment, but almost placed them under a social ban. In 1801 his professional income had amounted in no one year to £100. In that year he married, with "all the recommendations of poverty," and took up his residence in a third story in Buccleugh place. There several of his young whig associates, prominent among whom were Sydney Smith, Brougham, and Horner, were wont to visit him, and it was at

these social meetings that the "Edinburgh Review" was suggested and planned. The first number appeared Oct. 10, 1802, containing besides others seven articles by Sydney Smith, four by Horner, four by Brougham, and five by Jeffrey. Its learning, talent, spirit, and eloquence caused it to be hailed at once by the liberal party as the dawn of a brighter day, and by thoughtful men, indifferent to party, as an organ of the highest order for able and fearless discussion of every matter worthy of inquiry. A first and a second impression of 750 copies were rapidly exhausted; at the issue of the third number the regular sale was 2,500 copies, and in 1813 it exceeded 12,000. Jeffrey became its official editor with the fourth number, and continued to edit it for 26 years, during which period he was its most popular and effective contributor; and he wrote for it at intervals till near the time of his death. The whole number of his contributions is 200, of which 79 were selected for republication (2d ed., 3 vols., London, 1846; 1 vol., 1853). In the larger part of them he appears as literary critic, but several are devoted to metaphysics and to politics. The thoroughness and ability with which he analyzed literary productions, pointed out their beauties, and chastised their defects, was unprecedented in periodicals. His attack on the "Odes and Epistles" of Moore (1806) led to a harmless duel with Moore, and came near causing one between Moore and Byron. Against Wordsworth, Southey, and Coleridge he waged a long war, which he subsequently admitted to be unjustifiable. Yet even in his harshest critiques it was his custom to select the finest passages for quotation. In 1813, after having been a widower eight years, he visited New York to marry Charlotte Wilkes, a grandniece of the celebrated politician John Wilkes. In 1815 he took up his residence at Craigerock, two miles from Edinburgh, where he passed his summers until the year of his death. His reputation at the bar increased with his success as a reviewer. He rose to the highest eminence as a pleader, was elected in 1821 lord rector of the university of Glasgow, and in 1829 dean of the faculty of advocates, was appointed lord advocate in 1830, entered the house of commons in 1831, and was elevated to the Scottish bench in 1834. He took part in the reform debates in parliament, but did not maintain there the reputation for eloquence which he enjoyed at the bar. As a judge he was a model of courtesy and patience, and remarkable for the rapidity of his decisions and the vivacity and clearness of his statements. He was most highly esteemed in private life, and as a brilliant converser, abounding in wit, fancy, and amiability. His biography was written by Lord Cockburn, with a selection from his correspondence (Edinburgh, 1852).

**JEFFREYS, George**, lord, an English judge, born at Acton, Denbighshire (Wales), in 1648, died in the tower of London, April 19, 1689.

His family was good, though not rich. He was educated at Shrewsbury, at St. Paul's school, London, and at Westminster school under Dr. Busby. He became a member of the Inner Temple, May 19, 1663. Of his boyhood and youth but little is known, and that is not to his credit. He was called to the bar Nov. 23, 1668, 18 months before which he had married Mary Neaham, daughter of a clergyman, under romantic circumstances. On the death of this lady, in 1678, he married Anne, widow of Sir John Jones, who had been lord mayor of London. His rise at the bar was rapid, but his practice was in the Old Bailey and other London courts, always beneath the other tribunals in conduct, and in that age scarcely better than dens of torture and murder. So quickly did he rise that in March, 1671, he became common sergeant of the city of London. At that time he belonged to the "country party," and laid the foundations of his fortune by affecting to be a patriot and a Puritan; but he intrigued secretly for court favor, and was made solicitor to the duke of York, Sept. 14, 1677, and knighted. This startled his associates, but he insisted that the office was strictly professional, and in 1678 men of both parties united to elect him recorder of London. He then went boldly over to the court party. In the days of the popish plot he was one of the most active against the accused, acting both as judge and as counsel, in different courts; and it was by his advice that the government placed itself at the head of the patrons of the plot, whereby its inventors were prevented from turning it to the profit they had expected. He was appointed chief justice of Chester and made king's sergeant in April, 1680, and in 1681 created a baronet. Having offended the house of commons, he was reprimanded on his knees. The office of recorder he gave up Dec. 2, 1680. When the Oxford parliament was dissolved in 1681, and Charles II. resolved to destroy the whigs, Jeffreys became the most efficient agent of government. He labored against the city of London, and helped to extinguish its liberties. He was of counsel for the crown on the trial of Lord Russell, and was made chief justice of England, in order to effect the destruction of Algernon Sidney. He was deeply concerned in several other judicial murders of the same kind, and in the assaults on the municipal corporations. He presided at the trials of Oates and Baxter. On May 15, 1685, James II. made him a peer, by the title of Baron Jeffreys of Wem. In the summer of that year he was placed at the head of a special commission to try persons accused of having taken part in Monmouth's rebellion. Of the prisoners brought before him, 320 were hanged, 841 ordered to be transported and sold into the slavery of the tropics, and others punished with scourging, imprisonment, &c. Jeffreys boasted that he had hanged more traitors than all his predecessors since the conquest. His

cruelty was all the more offensive because he traded in pardons, and thus enabled rich offenders to escape. The king called his judge's doings "the chief justice's campaign in the west," and rewarded him by making him lord high chancellor of England, Sept. 28, 1685, which office he held until the downfall of the Stuarts. In the house of peers he made a bad figure. Attempting to bully the peers, he was firmly met, and so humiliated that he wept. The court of high commission having been revived, Jeffries was appointed its president, and took part in its worst acts. It was by his advice that the seven bishops were imprisoned and tried. When the king was frightened into a change of policy, Jeffries became his agent for good purposes. He carried back its charter to the city of London, and was hooted by the people. When James fled from London, Jeffries made arrangements to sail for Hamburg, but landed for the indulgence of drunkenness, and was recognized and seized. The mob wished to tear him in pieces, but the authorities succeeded in placing him in the tower, Dec. 13, 1688. There he remained for upward of four months, when he died of the stone. It is asserted that James II. was so well pleased with him, that he was to have received promotion in the peerage by the title of earl of Flint. Lord Campbell says that "when quite sober he was particularly good as a *nisi prius* judge." Macaulay says: "His enemies could not deny that he possessed some of the qualities of a great judge. His legal knowledge, indeed, was merely such as he had picked up in practice of no very high kind. But he had one of those happily constituted intellects which, across labyrinths of sophistry, and through masses of immaterial facts, go straight to the true point." His biographer, Mr. Woolrych, says: "His bright sterling talents must be acknowledged; that intuitive perception which led him to penetrate in a moment the thin veil of hypocrisy, and show things as they were, must have its meed." In spite of these eulogies, few will dissent from the declaration of Mr. Justice Foster, that he was "the very worst judge that ever disgraced Westminster hall." Though Jeffries was the father of 12 children, his family became extinct at an early day, and his title disappeared from the peerage in 1703.

**JEFFRIES, John**, an American physician, born in Boston, Feb. 5, 1744, died there, Sept. 16, 1819. He graduated at Harvard college in 1763, subsequently attended the medical schools of London, and in 1769 received from the university of Aberdeen the degree of M. D. Returning to Boston, he entered upon a lucrative practice, which continued until the evacuation of the town by the British troops, whom he accompanied to Halifax. After serving as surgeon general of the troops in Halifax, he was appointed in 1779 surgeon major of the forces in America, and was present for a short time with the army in Savannah. In the succeeding year he established himself in London

in the practice of his profession, and with so much success that he declined the lucrative post of surgeon general to the forces in India. He also occupied himself much with scientific studies, and in the prosecution of his experiments in atmospheric temperature undertook, together with François Blanchard, Jan. 7, 1785, a remarkable voyage in a balloon from Dover cliffs across the British channel, landing in the forest of Guines in France. This was the first successful attempt at aërostation on an extended scale, and Dr. Jeffries in consequence received many attentions from the learned and scientific societies of Paris and from various eminent personages. In 1789 he returned to Boston, where he practised his profession until the close of his life. He announced a course of lectures in Boston on anatomy, but such was the prejudice against dissection that on the evening of the second lecture a mob broke into his anatomical room and bore away the subject, the body of an executed felon presented to him by the governor. The course was never resumed, and the single lecture delivered is said to have been the first public one on anatomy given in New England.

**JEHOSHAPHAT**, fourth king of Judah, born about 950 B. C., succeeded his father Asa about 915, and died about 890. He fortified himself at first against Ahab, king of Israel, but afterward was connected with him by alliance in war and the marriage of their children. He was however zealous in punishing idolatry and improving the administration of justice. He took tribute from the Philistines and Arabians, and maintained a large standing army. He was Ahab's ally at the fatal battle of Ramoth-Gilead, but escaped without hurt. In alliance with Ahaziah, king of Israel, he built a fleet for an expedition to Ophir, but it was wrecked. He was successful against the Moabites and Ammonites, accompanied Jehoram of Israel in his campaign against Moab, in which they were joined by the king of Edom, and maintained the supremacy of Judah over the latter country. In his last years his son Jehoram was associated with him in the government.—The name Jehoshaphat signifies "Jehovah judgeth," and the prophet Joel (ch. iii, 2, 12) predicts the judgment of the heathen in the "valley of Jehoshaphat;" not any actual valley, but an ideal scene of Jehovah's righteous judgments on the nations, called in verse 14 "the valley of decision." But in later times the prophecy has been applied to the final judgment, and the valley of Jehoshaphat has been localized as the ravine between Jerusalem and the Mount of Olives. This application of the name appears in the 4th century, and the belief that the final judgment will take place there has led the Jews and the Moslems for centuries to use the sides of the valley as a place of burial.

**JEHOVAH** (*Yehovah*), the Hebrew name of the Supreme Being. The pronunciation and derivation of this name are matters of con-



troversy. The Jews of later periods, either from religious awe, or from a misunderstanding of Ex. xx. 7, Lev. xxiv. 16, abstained from pronouncing it, and, wherever it occurred in reading, substituted the word Adonai (the Lord), unless it followed that word, when they substituted Elohim (God); and it is now generally believed that the interlinear vowel signs attached to the Hebrew tetragrammaton Yhwh belong to the substituted word. The practice antedates the Greek version of the LXX., who everywhere substitute *κύριος*. Many believe Yahveh or Yuhavch to be the original pronunciation; but even Gesenius admits that "those who regard Jehovah as the true pronunciation are not without some apparent grounds." The name is derived by some modern critics from names of Egyptian divinities, supposed to have been nationalized by Moses; by others it is compared with the Jove of the Romans. Its resemblance to two other Hebrew words for the Divinity, Jah (*Yah*) and Ehyeh, in part strengthens and in part weakens these suppositions, which have been exhaustively treated by Tholuck (*Literarischer Anzeiger* for May, 1832; translated for the "American Biblical Repository," No. xiii., pp. 89-108). What is certain is the connection of the word, in its original or adapted form, with the Hebrew root *havah* or *hayah*, to be, and its meaning throughout the Scriptures "the Being" or "the Everlasting."

**JEJEEBHOY**, Sir **Jamsetjee**, a Parsee philanthropist, born in Bombay, July 15, 1783, died there, April 14, 1859. His parents were poor, and in early life he made several voyages to China. In one of these the ship in which he sailed was captured by the French, and he thus lost his property; but he died worth \$4,000,000. As early as 1822 he released the debtors confined in jail by paying their debts; and his donations to public objects were estimated at about \$1,500,000. In 1842 he was knighted by the queen of England, and in 1843 a gold medal bearing the image of Victoria set in diamonds was presented to him by the British government. Among his charities is the great hospital in Bombay bearing his name, and opened in 1845. Connected with it, and also endowed by him, is the Grant medical college. In various parts of the country he built comfortable places of refuge for the convenience of travellers. An establishment at Bombay for the education and support of poor Parsee children he endowed at an expense of \$250,000. In one gift he devoted to education \$150,000, besides the schools which bear his name, and also contributed \$50,000 for a school of design. He established benevolent institutions in Bombay, in Surat, in Nowsaree, in the Baroda territories, where his parents lived, and in many other places. He built the causeway which unites the islands of Bombay and Salsette, the water works at Poonah, the bridges at Earla, Parta, and Bartha, and many other public works. In June, 1856, at a public meeting, a statue was voted to him. His

statue, that of the first native Indian placed by the side of the monuments of Elphinstone, Malcolm, and Forbes, was set up in the town hall of Bombay, and exposed to public view, Aug. 1, 1859. He was advanced to the dignity of a baronet of the United Kingdom by letters patent of Aug. 6, 1857.—His title descended to his eldest son **CRIBETJEE** (born Oct. 9, 1811), who is a magistrate of Bombay. Under an act of the legislative council of India he assumed his father's name, Sir Jamsetjee Jejeebhoi, which is to be that of all his successors.

**JELALABAD**, a town of Afghanistan, capital of a province of the same name, 75 m. E. of Cabool, near the Cabool river. The stationary population is little more than 2,000, but is increased to 20,000 in the cold season by the influx from the neighboring mountains. It is wretchedly built and filthy, but has a considerable commerce and a large bazaar. It is renowned for the heroism displayed here by a single English brigade under Gen. Sale, who, after sustaining a long siege, defeated in March, 1842, a large Afghan force. (See **AFGHANISTAN**.)—**JELALABAD** or **JULLALABAD** is also the name of another town in Afghanistan, formerly Dooshak or Deshtak, capital of Seistan, near the mouth of the Helmund, 240 m. W. by S. of Candahar; pop. about 10,000. It is well built, chiefly of brick, and is the residence of a prince called king of Seistan.

**JELF**. I. **Richard William**, an English clergyman, born in London in 1798, died in Oxford, Sept. 19, 1871. He graduated at Oxford in 1820, was elected fellow of Oriel college, and became tutor. In 1826 he was appointed preceptor of Prince George, afterward king of Hanover. He became canon of Christ church in 1831, and in 1844 Bampton lecturer and principal of King's college, London. He published a number of works, mostly theological, among which are: "Sermons, Doctrinal and Practical" (1835); "The Means of Grace" (Bampton lectures, 1844); and a new edition of the "Works of Bishop Jewel" (8 vols., 1847-'8). II. **William Edward**, brother of the preceding, born in Gloucester in 1811. His education was received at Eton and at Christchurch, Oxford, where he graduated in 1833. He became tutor and censor of his college, and afterward public examiner and proctor of the university. During two years (1846-'8) he was one of the select preachers at Whitehall, and he was appointed Bampton lecturer in 1857. His principal work is "A Grammar of the Greek Language" (2 vols. 8vo, 1842-'3; 3d ed., enlarged and improved, 1861). He has edited Aristotle's "Ethics," with English notes, and published a volume of sermons (1848), "Sermons on Christian Faith" (Bampton lectures, 1857), and "Supremacy of Scripture," a reply to Dr. Temple (1861).

**JELLACHICH DE BUZIM**, **Joseph**, baron, an Austrian general, born in Peterwardein, Oct. 16, 1801, died in Agram, May 19, 1859. He was a colonel at the commencement of the Hun-

garian revolution in 1848, when his popularity among the Croats and their discontent at the advantages gained by the Magyars made him a convenient instrument for a reactionary movement. Being appointed by the emperor Ferdinand ban of Croatia, Slavonia, and Dalmatia, and general-in-chief in the southern districts, he carried on with vigor the consolidation of the Slavic tribes, convoked a diet, disregarded all adverse orders extorted from the court of Vienna by the Hungarian ministry, and finally invaded Hungary in September. Repulsed at Pákozd (Sept. 29), he joined Windischgrätz before Vienna, defeated Perczel at Moor (Dec. 29), and fought at Kápolna (February, 1849). Removed to the southern theatre of war, he was completely beaten by Guyon at Kis-Hegyész (July 14). His subsequent career was of little importance. His *Gedichte* were published at Vienna in 1850, and his soldier songs were popular.

**JELLY FISH**, the popular name of the aculeph class of radiated animals, or *medusa*,

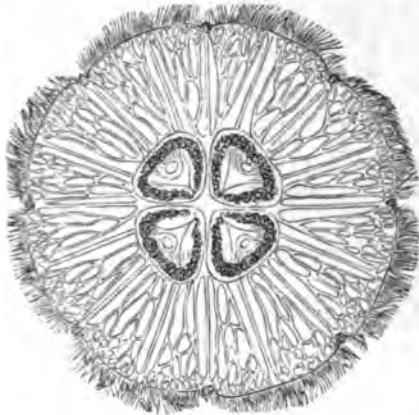

Adult Sun Fish (Aurelia).

including the orders *hydroida*, *discophora*, and *ctenophora*. The body is transparent and jelly-like, disk-shaped, with the mouth downward and in the centre of the enclosed cavity, from which hang down appendages varying in number, length, and purpose. In the genuine medusæ, of which the sun fish (*aurelia*), so common on our beaches after storms or floating in our waters in the summer, is a good example, the body is so largely made up of water that on drying it is reduced to a mere film of membrane; they would hardly be seen in the water were it not for their beautiful colors. The digestive cavity is more complex than in the polyps, being excavated in the substance of the body with branches ramifying in various directions; the stomach seems to perform the office of a heart, distributing the products of digestion over the system, and the food, arriving at the periphery, escapes by as many openings as there are traversing tubes; on the free margin are

generally numerous minute tentacles, forming beautifully delicate appendages, which absorb water into the marginal canal in contact with the food; digestion is rapidly performed; the circulation of the digested materials is irregular, sometimes in one direction and sometimes in another. The bunches of colored eggs generally hang outside the tentacles which surround the mouth; in some, red specks between the tentacles have been conjectured to be eyes. The common jelly fishes move by the alternate contractions and dilatations of the gelatinous disk; others, like the Portuguese man-of-war (*physalia*), have a large vesicle which supports the whole community at the surface of the ocean, motion being effected by the numerous contractile tentacles and the contractions of the air bladder; others (the *ctenophora* or beroid medusæ) move by means of vertical series of swimming appendages resembling the fins of a crab. This class presents the curious phenomena of alternate generation, illustrated by Steenstrup, Sars, and others, noticed also in other classes of the animal kingdom, especially the helminths or entozoa. The *tubularia*, common in pools left by the tide, a hydroid growing in tufts like small shrubs, hangs like a flower from a slender tube, with the mouth surrounded by tentacles, each animal connected with the rest of the community, and each mouth receiving nutriment for the whole; the young of this hydroid do not resemble the parent, but are little, delicate, translucent jelly fishes, like tiny cups from which hang down four long threads, and a proboscis at the end of which is the mouth; by the side of the buds branching out from the parent hang bunches of little spheres from which the jelly fishes are produced; along the proboscis of the floating cup are other spheres or eggs, from which are produced little pear-shaped bodies, which become attached and grow into the first men-

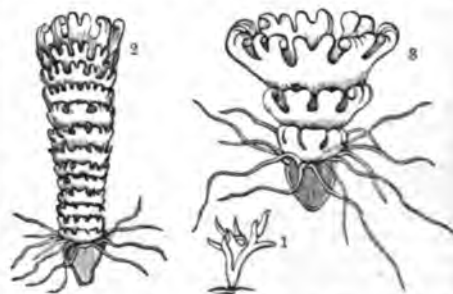

1. Early stage of Jelly Fish (Aurelia). 2. Strobilla, more advanced stage. 3. Strobilla, ready to be detached, and form the adult (Ephyra).

tioned branching hydroid. It will thus be seen that the grandchild resembles the grandparent, and the hydroid is reproduced through a generation of jelly fishes into a hydroid again; if the first be a *coryne*, the jelly fish would be a *sarsia*. Some small single hydroids, not

more than half an inch high, produce some of the largest jelly fishes; as the one which by subdivision into saucer-like contractions forms the *ephyra*, with a marginal fringe of tentacles. In our common white sun fish, the four crescentic rosy figures, forming a cross by their union in the centre, are accumulations of eggs. Some of the jelly fishes in our waters formed from these self-dividing hydroids are as large as the largest wash tub, with tentacles extending 20 or 30 ft.; these are of a deep claret color, and possess in a remarkable degree the stinging or nettling property which has given the scientific name to the class. In the Portuguese man-of-war, some of the community move the whole establishment, some secure prey with their lasso cells and eat and digest for the family, and some produce the buds from which the young jelly fishes arise; and none of these take up or interfere with the work of the others. In the same way the hydroid *campanularia* produces the jelly fish *tiaropsis*, with its edge beautifully fringed. Some very handsome jelly fishes do not originate from any hydroid, but reproduce themselves in the usual way by eggs. For the greater part of the year the eggs remain torpid, then a polyp-like vegetation arises, with buds which flower-like become rapidly developed into more highly organized free jelly fishes; these animal flowers, as they have been called, are so sensitive that they are instantly killed by a change from salt to fresh water. They are very voracious, feeding upon minute fishes, crustaceans, almost any small marine creatures, decaying animal or vegetable matters, and even their own species; they move with the rapidity and elegance of birds of prey, securing their victims with precision by means of their nettle-armed tentacles, and performing these acts in a manner which would hardly be expected in a transparent mass of jelly. A nervous system is present; and the form is in many capable of remarkable changes. For details on their structure, see Forbes's work on the British naked-eyed medusae; two papers by Prof. Agassiz in the "Memoirs of the American Academy of Arts and Sciences," vol. iv., part 2, 1850; and vol. iii. of Agassiz's "Contributions to the Natural History of the United States" (4to, Boston, 1860). The well known phosphorescence of the ocean is largely due to the light emitted by jelly fishes, shining like globes of fire, sparkling like stars, or diffusing a pale luminousness; this is most remarkable when the water is agitated by a vessel's keel, and on the coast line or amid breakers, where these creatures often serve to mark the course of the mariner. The number of these jelly fishes, often very minute, is beyond calculation or expression, especially in northern waters, where they form the food both of the small crustaceans and other animals upon which the right whales feed, which also devour the jelly fishes in immense numbers.

**JEMMAPES**, or *Gemappe*, a village of Belgium, in the province of Hainaut, on the river Haine

and on the canal from Mons to Condé, 3 m. W. of Mons; pop. in 1867, 11,405. The place contains several breweries, tanneries, forges, flour mills, a salt refinery, and extensive soap works. It is noted for a battle, Nov. 6, 1792, between the French under Dumouriez and the Austrians under Duke Albert of Teschen. The republican forces numbered about 40,000; the Austrian army was equally strong, but it was so posted that only its centre, consisting of 18,000 men, could be brought into action. These troops were entrenched, however, between Jemmapes and Mons, and their position was defended by 14 redoubts, mounting nearly 100 pieces of artillery. The battle began at daybreak with an attack by a French column under Beurnonville, who turned the Austrian flank and carried the redoubts on the left. A simultaneous attack on the centre was also successful, and the victory was complete. The Austrian loss was about 5,000, the French 6,000; but the consequences of the battle, the first regular engagement won by the republican forces, were very important to both parties. Most of the cities of the Netherlands surrendered to the victors without opposition; and when Belgium was annexed to the French republic Jemmapes gave its name to a department comprising nearly the whole of Hainaut.

**JENA**, a town of Germany, in the grand duchy of Saxe-Weimar-Eisenach, on the Saale, 12 m. S. E. of Weimar; pop. in 1871, 8,197. It is partly surrounded by steep barren mountains, and consists of the town proper, through which flows the little river *Leutra*, and several suburbs. It is the seat of a supreme court of appeals for the grand duchy, and for several neighboring duchies, and the principalities of Reuss, and contains a ducal palace, three Lutheran churches, a Roman Catholic church, three hospitals, a lunatic asylum, &c. The country around Jena is so beautiful that Charles V. is said to have placed it in that respect next to Florence. The foundation of its celebrated university was laid by the elector John Frederick the Magnanimous in 1547, when as a prisoner of Charles V. he was removed to Jena, where he was to meet his three sons. The university of Wittenberg having been wrested from him, his object was to establish in its stead a seat of learning at Jena which should become a nursery of science and of the doctrines of the reformation. The institution was sanctioned by the emperor Ferdinand I. in 1557, and inaugurated Feb. 2, 1558; and its 300th anniversary was celebrated Aug. 15-17, 1858. In connection with it are a philological and a theological seminary, a clinique, an anatomical theatre, an obstetric and pharmaceutical establishment, an institution for natural and mathematical sciences, one for agricultural science, and another founded in 1849 for political science, a botanical garden, an observatory, a museum of mineralogy, natural curiosities, archaeology, and oriental coins, and a library with more than 200,000 volumes. Jena holds a

high position in German literature, particularly in philosophy. Reinhold, Fichte, Schelling, and Hegel were all connected with it. Among the eminent scholars and poets who have held office in the university were Voss and the brothers Schlegel; among naturalists, Oken; in chemistry, Götting and Döbereiner; in theology, Danov, Griesbach, Eichhorn, and Paulus; in jurisprudence, Feuerbach and Thibaut. In the middle of the 18th century the attendance of students fluctuated between 2,000 and 3,000; at the end of that century there were still about 1,000. The student associations (*Burschenschaften*) and political agitations in 1815-'19, as well as the fact that the student Sand happened to be at Jena shortly before his assassination of Kotzebue, and the competition of the new universities, greatly injured the prosperity of Jena, and the attendance has since declined to 580, although the different duchies which support it have increased in their solicitude for its welfare. The number of professors in 1874 was 65, among whom were some of the first scholars of Germany, as Hase and Hilgenfeld in the theological, and Kuno Fischer and Haeckel in the philosophical faculty. The first literary periodical in Germany was established in Jena in 1785. After its removal to Halle, it was followed from 1804 to 1842 by the *Jenaische Literaturzeitung*, and since by the *Neue Jenaische Literaturzeitung*, which after being discontinued for some time was revived in 1874. Jena has also several private educational institutions, a musical union, and a society for the study of Thuringian history and archæology, founded in 1852.—A memorable battle was fought near Jena, Oct. 14, 1806, between the Prussian and Saxon army and the French. Napoleon's victory at Jena, says Schlosser, destroyed one half of the Prussian army, while Davoust gained on the same day a much more glorious victory over the other at Auerstädt. Prince Hohenlohe commanded the Germans at Jena, and Duke Ferdinand of Brunswick at Auerstädt, where he received a mortal wound shortly after the opening of the battle. This double defeat brought about the complete prostration of Prussia.

**JENGIS KHAN.** See GENGHIS KHAN.

**JENISEI.** See YENISEI.

**JENNER, Edward**, an English physician, born at Berkeley, Gloucestershire, May 17, 1749, died there, Jan. 26, 1823. He was the third son of the Rev. Stephen Jenner, vicar of Berkeley, and, having evinced a taste for the study of natural history and medicine, he was apprenticed at the age of 14 to a surgeon in Sudbury, near Bristol, with whom he remained seven years. At the age of 21 he went to London and became a pupil of John Hunter, then rising into eminence as a surgeon and physiologist, with whom he remained two years, and between whom and himself a lasting friendship was established. In the interval he was employed, at the recommendation of Sir Joseph Banks, to arrange the specimens of natural his-

tory brought back by Capt. Cook from his first voyage of discovery; and he received the appointment of naturalist to the expedition which sailed in 1772. He declined this offer, and in 1773 returned to Berkeley, where he established himself as a surgeon. In 1792 he procured from the Scottish university of St. Andrews the degree of M. D., and thenceforth devoted himself to the practice of medicine. As early as during his apprenticeship at Sudbury his attention had been directed to the subject of a preventive of smallpox, by hearing a young countrywoman, who had come to his master's surgery for advice, say that she could not take that disease because she had already had the cowpox. Upon inquiry he ascertained that in Gloucestershire persons engaged in milking cows frequently had the cowpox, a mild disorder of the eruptive kind appearing on the udder of the animal, and communicated in a similar form to their hands; that it had never been known to prove fatal when thus communicated; and that the belief was common among the agricultural classes that whoever had taken the disease was secure against the infection of smallpox. He immediately commenced a serious examination, and was soon led to conjecture that cowpox, as the milder disease, might advantageously supersede the inoculated smallpox, which had been introduced about 50 years before; and that as the latter is rendered less virulent by inoculation, so the former, introduced in the same way, might be milder than the casual complaint, and yet retain its protecting power. Upon going to London in 1770 he communicated this conjecture to Hunter, who made public mention of it in his lectures, but advised his pupil "not to think, but try." Upon returning to Berkeley he pursued the subject for many years, making a thorough study of varioloid eruptions. It was not until after frequent experiments that he ascertained that only one form of the eruption on the cow's udder had the property of protecting from the smallpox, and such was his faith in his discovery that several of these experiments were made upon his own son, a boy under six years of age. During all this time he met with little encouragement from physicians. Having satisfied himself of the efficacy of inoculation with the virus of the cowpox to prevent the smallpox, he next ascertained with equal certainty that the former disease could be communicated from one human being to another, without having recourse to the original vaccine matter. On May 14, 1796, he vaccinated a boy eight years of age with virus taken from a pustule on the hand of a milkmaid, who had been infected by her master's cow. On July 1 the boy was inoculated for the smallpox, and, as Jenner had predicted, without the slightest effect; and he lived to be inoculated 20 times for the smallpox, with the same result in each case. For two years afterward he continued his experiments in this direction, and in 1798 went to London. His reception was disheart-

ening in the extreme. Not only did the doctors refuse to make trial of the process, but the discoverer was accused of an attempt to "bestialize" his species by introducing into their system diseased matter from a cow's udder; vaccination was denounced from the pulpit as "diabolical;" and the most monstrous statements respecting its effects were disseminated and believed. At the end of three months he returned to Berkeley, and published his "Inquiry into the Causes and Effects of the Variolæ Vaccinæ," giving details of 16 cases of the casual and 7 of the inoculated disease. The facts described were incontrovertible; but the first impulse toward the adoption of the new practice was given by the successful vaccination of several persons in London by Mr. Cline, a surgeon, with whom Jenner on his return to Berkeley had left some vaccine lymph; and so sudden was the reaction in favor of Jenner, that in less than a year after his departure from London a manifesto expressive of confidence in his discovery was signed by 73 of the most eminent practitioners of the metropolis. Several of his medical brethren undertook to rob him of the merit of his discovery; and one of these, a Dr. Pearson, in cooperation with Dr. Woodville, physician to the smallpox hospital, brought vaccination into temporary disrepute by using and distributing matter from persons who had been inoculated with smallpox a few days after vaccination, and before the vaccine matter had taken a sufficient hold. Jenner promptly exposed this mistake in his "Continuation of Facts and Observations relating to the Variolæ Vaccinæ" (1800). In 1800-1 the "Inquiry" was translated into the principal continental languages, and within the next five years flattering testimonials from crowned heads and scientific bodies poured in upon him in abundance, and his discovery was hailed as an incalculable benefit to the human race. In 1802, not without considerable opposition, a parliamentary grant of £10,000 was voted to him; and so encouraging did his prospects appear that in 1803 he took a house in London, with a view of commencing practice there. He was however deceived in his expectations, and returned in the succeeding year to Berkeley, where he continued as before to vaccinate gratuitously all poor persons who applied to him on stated days. The royal Jennerian society for the encouragement of vaccination was established in 1803, with himself as president, but was subsequently merged in the national vaccine establishment. So inadequate had been the parliamentary grant to compensate him for his outlays and sacrifices in the prosecution of his discovery, that in 1807 a further grant of £20,000 was voted him, and he subsequently received between £7,000 and £8,000 from India. He died suddenly of apoplexy. His statue was placed in Trafalgar square, London, in 1858. His life by Dr. John Baron, with his correspondence, was published in 1827 (2 vols. 8vo; 2d ed., 1838).

**JENNER, Sir William**, an English physician, born in Chatham in 1815. In 1848 he was appointed professor of pathological anatomy in University college, London, in 1857 professor of clinical medicine, and in 1861 physician to the queen, in which capacity he attended Prince Albert in his last illness. He was created a baronet in 1868, and made K. C. B. in 1872 for his services during the illness of the prince of Wales. He is a fellow of the royal college of physicians and of the royal society. He published in 1852 his "Gulstonian Lectures," but his most important works relate to the "Identity and Non-Identity of Typhus and Typhoid Fevers."

**JENNINGS**, a S. E. county of Indiana, drained by tributaries of Muscatatuck river; area, 375 sq. m.; pop. in 1870, 16,218. The surface is diversified, and the soil is moderately fertile. The Jeffersonville, Madison, and Indianapolis, and the Ohio and Mississippi railroads intersect at Vernon. The chief productions in 1870 were 147,879 bushels of wheat, 402,266 of Indian corn, 88,242 of oats, 41,236 of potatoes, 48,293 lbs. of wool, 232,299 of butter, and 12,903 tons of hay. There were 4,837 horses, 4,012 milch cows, 6,246 other cattle, 17,083 sheep, and 20,295 swine; 8 manufactories of carriages, 1 of iron castings, 2 of brick and stone masonry, 1 distillery, 4 flour mills, and 14 saw mills. Capital, Vernon.

**JENNINGS, William**, an English miser, born in 1701, died in 1797. His father was an aide-de-camp to the duke of Marlborough and on terms of intimacy with William III., who officiated as godfather at the baptism of the son. In early life William Jennings was a page to George I. On attaining his majority he retired to a magnificent country seat in Suffolk, left unfinished by his father, where he passed the greater part of his life. He never attempted to complete the building, but lived on the basement floor in a style of penury rivaling that of his neighbor John Elwes, equally celebrated for parsimony. The remainder of his life was devoted to the accumulation of property, and at his death he possessed upward of £1,000,000. Like Elwes he also frequented Brookes's and other gambling clubs in London, but less for the purpose of play than to lend money to the unlucky at enormous interest; and so profitable was this business that, until too infirm to pursue it, he was in the habit of spending the fashionable season in London. He died a bachelor, leaving a will sealed but not executed; and the disposition of his immense property has ever since formed a subject of inquiry among those of his name.

**JENYNS, Seame**, an English author, born in London in 1704, died there, Dec. 18, 1787. He finished his education at Cambridge. His first production was a poem on the "Art of Dancing" (1730). In 1742 he was returned to parliament as a member for Cambridgeshire, and in 1755 appointed one of the commissioners of the board of trade and plantations. In 1757

he published his "Free Inquiry into the Nature and Origin of Evil," which Dr. Johnson severely criticised. In 1776 appeared "A View of the Internal Evidence of the Christian Religion," in which he avowed his early skepticism and recent conversion. A complete edition of his works was published in 1790 (4 vols. 8vo, London).

**JEPHTHAH**, the ninth judge of Israel, natural son of Gilead. He was exiled by his half brothers after the death of his father, and dwelt in the land of Tob. There he gained renown as leader of a band of border rovers, and was at length chosen by the Gileadites to be their commander in a defensive war against the Ammonites. He, however, chose to attack the enemy in their own country, first making an oath that if victorious he would sacrifice to the Lord whatsoever should first come forth from his house to meet him on his return. He conquered the Ammonites, and when he returned his daughter, an only child, issued from his house to greet him with timbrels and with dances. It is stated that at her own request "he did with her according to his vow;" but some commentators suppose that he only consecrated her to perpetual virginity. Jephthah ruled Israel six years. The sacrifice of his daughter is the subject of oratorios by Handel (1751) and Reinthaler (1855).

**JEQUITINHONHA**, a river of Brazil, rising in the Serro Frio, about 9 m. W. of the town of Serro, and S. S. W. of the peak of Itambé, in the province of Minas Geraes, and falling into the Atlantic near the town of Belmonte in Bahia, lat. 15° 50' S., lon. 39° W. It has a course of about 750 m., the first 180 m. being N., and the remainder generally N. E., and the area of its basin is estimated at 19,800 sq. m. Its bed is obstructed by many dangerous rapids and cataracts, and a magnificent series of cascades with an aggregate fall of 300 ft. occurs near the boundary line between Minas Geraes and Bahia; so that the river to that point is only navigable by canoes. Further down it widens, but, being shallow, is only available for small steamers; while the entrance, owing to numerous sand bars, is difficult for even the smallest coasters. The Poassú, however, opening on the left bank, and communicating with the Pardo, virtually forms the main channel of the Jequitinhonha; and the maize, cotton, and other products, sent down in large quantities from Minas Geraes and the lower river, are not taken to Belmonte, but to Cannavieiras, at the mouth of the Pardo, 40 m. N. Of the numerous tributaries of the Jequitinhonha, the principal is the Arassuaí, a stream of considerable magnitude from the south. Diamonds are plentiful in all the streams.

**JERBOA**, the principal old-world representative of the rodent subfamily *dipodina*, characterized by greatly developed hind legs for taking long leaps, diminutive fore legs, long hairy tail, and large infra-orbital foramen. The best known species is the Egyptian jerboa

(*dipus Egyptius*, Licht.). The incisors are slender and sharp, the upper ones grooved, two above and two below; the molars, 三三三, are complex, furnished with roots; the head is large, with prominent eyes, moderate pointed ears, and silken whiskers 6 in. long. In external conformation it somewhat resembles the kangaroo, having an elongated body thickest behind, the posterior limbs very much larger than the anterior; the neck is very short, and the six lower vertebræ are frequently found united together; the metatarsus consists of a single bone; there are five toes on the short fore feet, and three on the posterior, armed with obtuse claws; the tail is long, with hairs set in two rows, and tufted at the end; it is not thick at the base, as in the kangaroo, though it is used to sustain the body in the act of leaping. The body is about as large as a rat's, of a fawn color above and white below, the black tuft of the tail white tipped. From its generic



Egyptian Jerboa (*Dipus Egyptius*).

name, which signifies two-footed, it has been supposed that the jerboa walks entirely on the hind feet; but the animal walks upon four feet, resorting to its prodigious leaps only when alarmed; when about to spring, it raises itself on the end of the hind feet, with the support of the tail, the fore feet close to the breast; the body comes down on the fore feet, but is elevated again so quickly that it appears constantly in the air. All the species are clavicolated, and carry their food to the mouth with the fore paws; they pass the winter in burrows in a state of lethargy; they are difficult to keep in captivity, even in their own climates; the females are generally the largest, and have six or eight young. The Egyptian species lives in troops in northern Africa, most abundantly in the sandy regions and ruined places of Egypt; it extends into Syria and Arabia, and as far north as the Caspian sea; it is restless and timid, and can be taken only by surprise. The Arabians take jerboas alive in

their burrows; their flesh is eaten by the Egyptians, and their soft and shining fur is valued by them. The food of the jerboas is exclusively vegetable, and they are said never to drink. The largest species is the *scirtetes jaculus* (Wagn.), about 9 in. long, found in the steppes between the Donetz and the Don and in the Crimea; this is the *alak-daugh* of the Mongols. The fur is soft, yellowish fawn varied with grayish brown above; the under parts, interior of limbs, end of nose, and crescent on the nates are white. The general appearance and habits are as in the common species; they become lethargic both under slight cold and great heat; the food consists of succulent plants, roots, fruits, insects, and, it is said, of small birds and of each other; they dig very rapidly into the earth, and live in burrows with many openings; their swiftness is such that it is difficult to overtake them even on horseback; their flesh is also esteemed as food.—To this family also belong other jumping rodents, often called jerboas. Among them is the jumping hare of South Africa (*peletes Cafer*, Illig.), with molars  $\frac{1}{2}$  without roots, long ears, five toes on the fore feet and four on the hind, with long claws; the posterior limbs and tail are long, the latter tufted. It moves by great leaps, and sleeps by day; it is as large as a rabbit, of a fawn color, with the end of the tail black. In North America is the jumping mouse (*jaculus Hudsonius*, Zimm.), about 10 in. long, of which the tail is more than half; the color is red-brown, darker on the back, the sides and under parts white. It is found as far north as the Great Slave lake. The molars are  $\frac{1}{2}$ ; the hand has four fingers with a rudimentary thumb, hind feet five-toed, hind legs and tail very long, the latter thinly haired; upper incisors grooved longitudinally in front. For full details on this genus, see vol. viii. of the reports of the Pacific railroad survey.

**JEREMIAH**, the second of the great Hebrew prophets, son of Hilkiah, one of the priests of Anathoth, prophesied under the reigns of Josiah, Jehoahaz, Jehoiakim, Jehoiachin, and Zedekiah, and after the conquest of Jerusalem by the Babylonians, from about 627 to 575 B. C. He was but a youth when he began his prophetic career in his native city. The persecutions of his townsmen drove him to Jerusalem, where, in spite of opposition and imprisonment, he remained true to his mission, keeping firmly in view the religious and political rectitude of the state. After the death of Josiah he was assailed by priests and prophets, and was cast into prison, where he wrote some of his predictions, which were read to the people by Baruch, but burned by King Jehoiakim. After the capture of Jerusalem by Nebuchadnezzar he was spared by the conqueror, in consideration of his having advocated submission to Babylon, and he went first to Mizpah, and afterward to Egypt. There are various traditions concerning his last years and his death. A grotto is still pointed out at Jerusalem where

he is said to have composed his Lamentations, and his grave is shown at Cairo. His extant writings embrace the book containing his prophecies, and, according to general belief, the metrical book of Lamentations. While the canonicity of the book of Jeremiah in general is not doubted by any, the genuineness of some portions have of late been disputed by Movers, Ewald, Hitzig, and others. An elegy on the death of King Josiah, ascribed to him, is lost. Among the more recent commentators on Jeremiah are Hitzig (Leipsic, 1841), Umbreit (Heidelberg, 1843), Neumann (Leipsic, 1856), Graf (1862), and Cowles (New York, 1869). There are English translations and commentaries by Blayney (Oxford, 1784; new ed., Edinburgh, 1810), by Noyes (Boston, 1837), and by Henderson (London, 1851; revised, 1868).

**JEREZ** (or **Xerez**) **DE LA FRONTERA** (anc. *Asta Regia*), a town of Andalusia, Spain, in the province and 13 m. N. E. of the city of Cadiz, 3 m. from the right bank of the Guadalete; pop. about 50,000. Situated in one of the most fertile plains of the peninsula, it comprises two distinct divisions, the old and the new town. The streets in the latter are spacious, regular, clean, and well paved and lighted. There are three fine squares. The houses are well built, are generally white, and have tasteful courtyards. The cathedral, completed in 1695, though lofty and spacious, is heavy and devoid of taste; it has a library and a curious numismatical collection. Of the 11 parish churches, only those of San Dionisio, San Miguel, and Santiago are noteworthy; in them the Gothic style prevails, and among the rich decorations of the interiors are numerous paintings, statues, and bassi rilievi. There are seven convents, and a larger number of monasteries. Of the five hospitals, one is for foundlings; and there are besides a female orphan asylum, a college, and several free schools. But the most remarkable of the public buildings is the old Moorish castle (Alcazar), contiguous to the Alameda, and surrounded by turreted walls, one of the best specimens of a palatial fortress in Spain. Jerez derives its celebrity from its wines, which are by far the best in the country, and consist of the aromatic pajorete and the far-famed sherry, a name Anglicized from that of the town. Many of the cellars are capable of containing 14,000 butts. (See SPAIN, WINES OF.) Some olive oil is made, and there are a few woollen factories, soap-boiling establishments, and tanneries. The town has railway communication with Cadiz and Seville. The export trade, mainly consisting in wines, is chiefly carried on through the port of Santa Maria, 7 m. S. W.—Near the walls of Jerez, which are still standing though much dilapidated, Roderic, the last king of the Visigoths in Spain, was defeated by the Moors, shortly after their landing in 711, in a battle which is said to have lasted a week. Alfonso the Wise recovered the town from the Moors about the middle of the 13th century.

**JERICHO**, a flourishing commercial city of ancient Palestine, in the valley of the Jordan, on the W. side of that river, near its entrance into the Dead sea. It was one of the oldest and richest cities of Canaan, surrounded by groves of palms and balsam trees. It was conquered and destroyed by Joshua on his entrance into the promised land, and a curse was pronounced upon whosoever should rebuild it, its territory being allotted to the tribe of Benjamin. It was, however, rebuilt upon a site near by, became the centre of the trade between Arabia and Palestine, was fortified by King Ahab, and was the seat of a school of prophets. Mark Antony presented its plain of palm trees to Cleopatra. It was embellished by Herod the Great, who built there one of his residences; under Vespasian it was destroyed, and under Hadrian again rebuilt; it was overthrown during the Mohammedan conquest, revived under the caliphs, and completely destroyed during the crusades. The village of Riha, supposed to occupy the site of the second city, was destroyed by Ibrahim Pasha in 1840, and there only remain a few huts and a Saracenic tower.

**JERICHO, Rose of.** See ROSE OF JERICHO.

**JEROBOAM. I.** Founder of the kingdom of Israel, son of Nebat, of the tribe of Ephraim, died about 953 B. C. He was selected by Solomon to be a superintendent of the public works at Jerusalem. Informed by the prophet Abijah that he was to rule the ten tribes which should revolt from the house of David, he immediately engaged in plots against Solomon, and fled to the court of Shishak, king of Egypt, to escape punishment. On the death of Solomon he returned, headed the deputation of the chiefs of tribes which met Rehoboam at Shechem and whose demands were rejected, and was then elected by ten of the tribes to reign over them, with the title of king of Israel, Judah and Benjamin alone remaining to Rehoboam (975 B. C.). He resided at Shechem, which he fortified, built temples at Dan and Bethel, where golden calves were made the symbols of the Divinity, to which his subjects might resort rather than to Jerusalem, and was generally successful in his wars against Judah, though he was defeated in a great battle by Abijah. The leading aim of his government was to raise a barrier against any reunion of the tribes. **II.** Thirteenth king of Israel, son of Joash, reigned 823-782 B. C. His reign of 41 years was prosperous, although licentious and oppressive. He captured Damascus from the Syrians, and reconquered Ammon and Moab. In Scripture he is mentioned only in 2 Kings xiii.-xv., 1 Chron. v., and in the prophecies of Hosea and Amos. Wherever the name occurs elsewhere, it refers to Jeroboam I.

**JEROME**, king of Westphalia. See BONAPARTE, JÉRÔME, vol. iii., p. 26.

**JEROME, Saint** (SOPHRONICUS EUSEBIUS HIERONYMUS), one of the four great doctors of the Latin church, born at Stridon, on the confines

of Pannonia and Dalmatia, about 340, died in Bethlehem Sept. 30, 420. His own writings furnish an almost complete autobiography. His father Eusebius was a wealthy Christian. In 363 he was sent to Rome with his countryman Bonosus, and studied Greek and Latin literature and eloquence. In 365 he was baptized and took the name of Hieronymus. He afterward visited with Bonosus the southern and northern provinces of Gaul and the coast of Britain, and studied for some time at Treves. Returning to Italy, Jerome became the inmate of a monastery at Aquileia, and under the direction of Valerianus, bishop of that city, devoted himself to the study of Scripture and theology. While there he transcribed a commentary on the Psalms and a treatise on synods by St. Hilary of Poitiers, and published his first known treatise, addressed to Innocentius, *De Muliere septies Percussa*. There he formed the acquaintance of Rufinus, afterward his most determined theological opponent. In 372 he was called to Stridon to reclaim one of his sisters, and this incident seems to have determined him to leave Italy for ever. After a brief stay in Rome, he set out for Syria with several friends, travelled on foot through Thrace and Asia Minor, and stopped at Antioch to follow a course of lectures on Biblical exegesis by the future heresiarch Apollinaris, bishop of Laodicea. He afterward withdrew into the desert of Chalcis near Antioch, where he spent four years in a hermit's cell, assiduously studied the Hebrew language, and wrote a letter on Manichæism and two letters to Pope Damasus, one of which was in relation to the schism reigning in the church of Antioch, where there were at that time three rival bishops. The pope having advised him to acknowledge Paulinus as bishop, Jerome returned to Antioch, and in 376 consented to receive priestly orders, on the condition that he should not be forced to accept any pastoral charge. He immediately applied himself to acquire an accurate knowledge of Biblical topography and a thorough familiarity with the Hebrew and Chaldee, visiting the most celebrated scenes of Bible history, and consulting everywhere the most learned Jews. To perfect himself in Greek and to have the Bible interpreted to him by the best living masters, he went to Constantinople about 380, and became the disciple of St. Gregory Nazianzen, whom he calls his father and master. In that city he wrote a commentary on the 6th chapter of Isaiah, and translated 14 homilies of Origen and the chronicle of Eusebius. His version only follows the original to the siege of Troy; in the second part Jerome confesses to his having arranged the matters in his own way as far as the 20th year of Constantine, the remainder being entirely his work down to the death of Valens (378). Being called to Rome by Pope Damasus in 382, he acted as notary to the council held there in that year, and afterward remained as secretary or *referendarius* to the pope until the death of



the latter in 384. Jerome resided in a monastery, and at the pope's request began his revision of the old Latin or Italic version of the Bible. He produced the translation of the Psalms called *Psalterium Romanum*, and another of the Gospels dedicated to the pope, wrote a commentary on the parable of the prodigal son, a letter on the hierarchy, and a treatise against Helvidius, who denied the perpetual virginity of Mary the mother of Christ. His love of monastic seclusion induced him to win converts by voice and pen to this mode of life. A large number of noble persons, particularly Roman ladies, forsook all worldly pursuits, and placed themselves under his direction. This, and Jerome's denunciation of the worldly lives led by the generality of Roman Christians, made him many enemies, lay and clerical; while his frequent instructions on the Scriptures and Christian virtues to his numerous female converts afforded an opportunity for spreading malignant reports against him. So long as Pope Damasus lived he supported Jerome against his slanderers; but after the election of Siricius, Jerome, taking with him his younger brother Politian, set out once more for the East. In order to find the most perfect models of monastic life, he visited the monasteries of Upper and Lower Egypt, and finally fixed his abode at Bethlehem, the birthplace of Christ. Thither he was soon followed by some of his distinguished Roman converts, who devoted a portion of their wealth to the erection of monasteries. One of these, for men, was placed under Jerome's direction, and to it he soon added a hostelry and hospital for pilgrims, and for the numerous refugees who fled from Rome after its sack by Alaric in 410. There he completed his Latin version of the Scriptures, which became in the western churches what the Septuagint was in the East, and served as a basis for nearly all the earlier translations of the Scriptures subsequently made into the vernacular tongues of Europe. From Bethlehem Jerome also issued treatises against the heretics of his time, such as Jovinian, Vigilantius, and Pelagius. He combated the doctrines of John, bishop of Jerusalem, and of his old friend Rufinus, who was propagating Origenism. In 416 the Pelagians, who were in the ascendancy in Palestine, burned his establishment at Bethlehem, and compelled him to fly for his life. Having remained in concealment for more than two years, he returned to Bethlehem in 418, exhausted by privations, anxiety, and infirmities. He was buried amid the ruins of one of his monasteries; but his remains were afterward taken to Rome, and placed in the basilica of Santa Maria Maggiore, near the tomb of Sixtus V. His feast is celebrated on Sept. 30.—The personal character of St. Jerome has been the subject of much censure and much praise. His writings show him to have been a man of ardent nature, invincibly attached to what he conceived to be the truth and the right; but his very impetuosity was apt to hurry him

into extremes. He advocated evangelical poverty and self-denial under the form of monasticism among the Roman patricians, as a remedy for the low morality which everywhere prevailed; but no one denounced with greater energy than he both false monks and false penitents. Biblical scholars are unanimous in acknowledging the incomparable services which his labors rendered to the church. His complete works comprise a volume of letters, several biographical series, topographical and grammatical dissertations about Hebrew history and geography, commentaries on the books of the Old and New Testaments, translations of works of several ecclesiastical writers, and finally his Latin version of the Bible. Of all his works this is the most useful and most widely known, though in a corrupted form, under the name of the Latin Vulgate. (See BIBLE.) We have now the text of the New Testament from MSS. of about the middle of the 6th century, the *Codex Amiatinus*, edited by Tischendorf in 1853 and again in 1855, and the *Codex Fuldensis*, edited by Ranke in 1865, which rank with the oldest and best Greek MSS. in determining the true reading of the sacred text. The readings of the former in the Old Testament have been added by Heyne and Tischendorf to the Clementine Vulgate Latin, with emendations and various readings by Vercellone (1873). The principal editions of his works are those of Erasmus and Ecolampadius (9 vols. fol., Basel, 1516, reprinted in 1526 and 1537, and at Lyons in 1550); of Marianus Victorinus (9 vols., Rome, 1566-72; Paris, 1578, 1608, and 1643); of Tribbeckovius (12 vols. fol., Frankfurt and Leipsic, 1684); of the Benedictines Pouget and Martianay (3 vols., Paris, 1693-1706); and that of Vallari and Maffei (11 vols., Verona, 1734-'42; Venice, 1766-'72; reproduced by Migne, *Patrologie latine*, vols. xxii.-xxx., Paris, 1845-'6). His life has been written by Martianay (Paris, 1706), by Stilling in the *Acta Sanctorum* for September, and by Alban Butler, "Lives of the Saints," Sept. 30. See also Collombet's *Histoire de St. Jérôme* (Lyons, 1844), and Zhekler, *Hieronymus, sein Leben und Wirken* (Gotha, 1865).

**JEROME OF PRAGUE**, a Bohemian religious reformer, born in Prague about 1375, burned at Constance, May 30, 1416. After graduating at Prague he visited the universities of Cologne, Heidelberg, Paris, and Oxford. Returning to Paris, he preached boldly in favor of reforms in the church, defending his views in a disputation held with Gerson, chancellor of the university. He was employed by Ladislaus II. of Poland to organize the university of Cracow. About 1402 he began to disseminate secretly the doctrines of Wycliffe in Bohemia, and in 1408 openly identified his views with those of Hus. He was imprisoned for a time at Vienna, and only released through the earnest entreaty of his Bohemian friends. When Hus was imprisoned at Constance in 1414, Jerome

went thither in accordance with a promise to defend him; but because of the rumor that Huss would only be tried to be executed, he fled to Ueberlingen, whence he intimated his willingness to appear before the council under a safe-conduct. An equivocal answer being given, he prepared to return to Prague, but was arrested by order of the count palatine of Neuburg-Sulzbach, and delivered over to the council, May 23, 1415. He was several times brought to trial, but his learning and power of debate enabled him to answer all arguments urged against him. On his third examination, Sept. 23, he made a qualified recantation of his views as to the sacrament. After being imprisoned for several months, he was again brought before the council, May 26, 1416, and solemnly retracted his late admission of error. This hastened his condemnation, and he was burned at the stake, meeting his fate with courage. His life has been written by Heller (Tübingen, 1835), and by Becker (Nördlingen, 1858).

**JERROLD. I. Douglas William**, an English author, born in London, Jan. 3, 1803, died there, June 8, 1857. His father was manager of a theatre in Sheerness, but Jerrold himself manifested a dislike for the stage, and obtained in 1813 a commission as midshipman. The hard life in service did not suit him; and when paid off, Oct. 21, 1815, he did not attempt to reënter the navy. His father had been ruined as manager, and the family went to London, where in 1818 the boy was apprenticed to a printer, and devoted his leisure to study and reading. His first literary effort was a comedy, "More Frightened than Hurt," written at the age of 15; it was sent to a London theatre, where it remained unread for two years, but met with great success when brought out at Sadler's Wells in 1821. He was afterward employed as a writer for the newspaper on which he had worked as a printer, and in 1825 married and was engaged at a salary to write for the Coburg theatre. In 1829, having quarrelled with the manager of this establishment on account of a play, "Black-Eyed Susan," written several years before, Jerrold left his situation, and went with the MS. to Elliston at the Surrey theatre. It had a run of over 300 nights, and brought in many thousands for the manager, though the author only received about £70. In 1830 the success of a new play, "The Devil's Ducat," at the Adelphi theatre, introduced him to Drury Lane, where he produced "The Bride of Ludgate" and "The Rent Day;" the latter, founded on two pictures by Wilkie, was also strikingly successful. From 1831 to 1836 he wrote "Nell Gwynne," "The Housekeeper," "The Wedding Gown," and "Beau Nash," all of which were successful. In 1836 he undertook the management of the Strand theatre, but failed in the speculation. He had already produced many striking pieces in different magazines. He was in Paris when "Punch" was started in 1841, and on returning he became one of its most popular contributors. His "Q."

papers, "Story of a Feather," and the "Candle Lectures" made his name widely known. In 1843 he started the "Illuminated Magazine;" this was discontinued after two years, and followed by his "Shilling Magazine," which was also a failure. More successful was his connection with "Lloyd's Weekly Newspaper." He was very witty in conversation. "Douglas Jerrold's Wit and Humor," and "The Life and Remains of Douglas Jerrold," by his son, were published in 1858. A partial collection of his works, with the life, has been issued (5 vols., Philadelphia, 1869). **II. William Blanchard**, son of the preceding, born in London in 1826. He was educated partly at Brompton grammar school and partly in France; studied art, contributed to various periodicals, and wrote several tales, farces, and other works, among which are "Swedish Sketches" (1852) and "Imperial Paris" (1856). In 1857 he became editor of "Lloyd's Weekly Newspaper," succeeding his father, whose life he wrote in 1858. In 1863 he went to Paris, as commissioner of the "Morning Post," to study the institutions for the relief of the poor, and the results of his investigations were embodied in "The Children of Lutetia" (1864). He made trips in various parts of France and Spain, and published "At Home in Paris," "A Trip through the Vineyards of Spain" (1864), "Passing the Time" (1865), "On the Boulevards" (1867), and several other works. In 1869 he made a journey in the Netherlands to examine the poor-law administration. In 1871 he published "The Story of Madge and the Fairy Content," "At Home in Paris: at Peace and at War," and "The Cockaynes." His comedy, "Cupid in Waiting," was produced at the Royalty theatre in July, 1871, and his "London," illustrated by Doré, was published in 1872.

**JERSEY**, a W. county of Illinois, bounded W. by Illinois river, and separated from Missouri on the S. by the Mississippi; area, 352 sq. m.; pop. in 1870, 15,054. The surface is diversified with prairies and woodlands, and the soil is generally fertile. The main line and the Jacksonville division of the Chicago and Alton railroad, and the Rockford, Rock Island, and St. Louis railroad, traverse it. The chief productions in 1870 were 558,367 bushels of wheat, 519,120 of Indian corn, 71,770 of oats, 39,330 of potatoes, 13,226 lbs. of wool, 180,078 of butter, and 11,650 tons of hay. There were 4,531 horses, 2,978 milch cows, 7,977 other cattle, 4,552 sheep, and 16,056 swine; 2 manufactories of boots and shoes, 3 of carriages, 2 of boats, 7 of coöperage, and 8 flour mills. Capital, Jerseyville.

**JERSEY**, the largest and most important of the Channel islands, lying in the English channel, 15 m. from the coast of France, and belonging to Great Britain. It is about 12 m. long from E. to W., and 7 m. wide, and contains an area of 45 sq. m.; pop. in 1871, 56,627. The coast is indented with numerous excellent harbors, and save toward the south

is in general bold and precipitous. The surface is an alternation of wooded hills and fertile valleys. The highlands in the north consist chiefly of granite, and the reddish white syenitic granite which forms the cliffs on the N. coast is quarried extensively for exportation. In the south schist is found overlying the granite formation. The island contains neither limestone, chalk, marl, nor gravel. The climate is mild and healthful. Agriculture has recently been greatly improved. Land is held at a high rent, the holdings averaging but 15 acres. Alderney cows, small sturdy horses, sheep chiefly of the Southdown stock, and a few varieties of feathered game are the most important animal productions. Nearly all forest trees common to this latitude are found to thrive; wheat, potatoes, parsnips, and lucern are cultivated, and much attention is devoted to apple orchards, for which the soil and

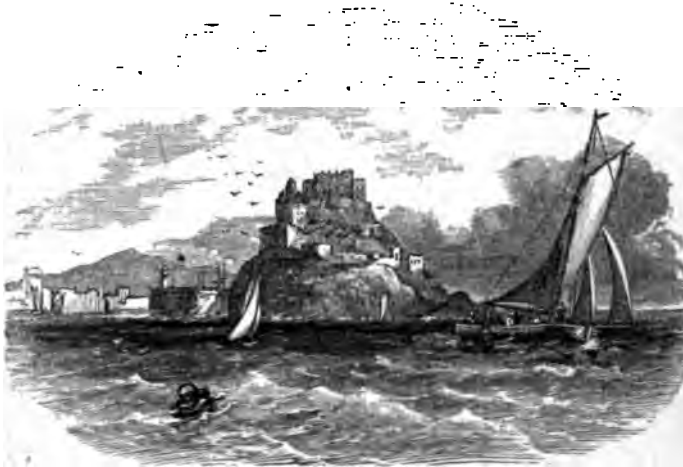

Mount Orgueil Castle, Jersey.

climate are particularly favorable; as many as 30,000 hhd. of cider have been made in good years. One of the most remarkable products of Jersey is its Chaumontelle pears, a single one of which frequently weighs a pound. The most important manufactures are shoes and hosiery. Great numbers of ships are also built, as timber and cordage are duty free. The chief exports are cattle, potatoes, and oysters; the principal imports are woollens, hardware, soap, glass, earthenware, and coal. The oyster trade employs about 3,000 persons and 400 or 500 vessels. The principal beds are on the E. side of the island, the best being nearer to the French coast than to Jersey. Between the months of February and May about 200,000 bushels of oysters are sent from the Jersey beds to England, where most of them are deposited in "parks" along the coast of Essex and the Thames, to be withdrawn according to the demand of the London market. The harbor of Gorey on the E. shore of the island is

the principal rendezvous for the vessels. Near it is Mount Orgueil castle, a picturesque structure on a headland between St. Catharine and Grouville bays. It was once the principal fortress on the island, and it was the residence of Charles II. during a part of his exile.— Jersey has a legislature of its own, called the "states," or insular parliament. It consists of the governor and the baili of the royal court, who are appointed by the crown; the 12 judges of the royal court, who are chosen for life by the rate payers; the rectors of the 12 parishes, who are appointed to their livings by the governor; and 12 constables (one from each parish), elected for three years by the inhabitants. The *vicomte*, or high sheriff, and the two *dénonciateurs*, or under sheriffs, occupy seats as officers of the assembly. The crown officers may take part in the debates, but not vote. The governor in special cases

may confirm or annul the decrees of the states. The royal court is the supreme tribunal in civil and criminal cases; appeal lies from it to the sovereign in council. The language of the upper classes is generally French, but the masses still speak a dialect of the old Norman and preserve a number of Norman feudal customs. The capital is St. Helier.

**JERSEY CITY**, a city and the county seat of Hudson co., New Jersey, situated on the W. bank of the Hudson river, here about a mile wide, at its entrance into New York bay, op-

posite the city of New York, with which it is connected by five ferries, and 50 m. N. E. of Trenton. It is bounded N. by North Bergen, West Hoboken, and Hoboken, S. by Bayonne, and W. by Newark bay, Hackensack river, and Penhorn creek, and extends about 5 m. N. and S. by 3 m. E. and W. It is in the main regularly laid out, with wide streets crossing each other at right angles, but some streets do not conform to the general plan. There are numerous handsome residences, and many substantial business structures and public buildings. Among the latter may be mentioned the city hall, court house and jail, a large market, the public school buildings, of which 14 are of brick, and the churches. There are four small public squares, of which two, Van Vorst and Hamilton, are provided with fountains laid out in grass plots, and adorned with trees. Washington square is divided into four smaller squares by intersecting streets, and Bergen square, which is unimproved, is used as a

parade ground. The population in 1850, as returned in the census, was 6,856; in 1860, 29,227; in 1870, 82,546, of whom 705 were colored and 31,835 foreigners, including 17,665 natives of Ireland, 7,151 of Germany, 4,008 of England, and 1,176 of Scotland. The number of families was 16,687; of dwellings, 9,867. The city is an outgrowth of New York, and has been built up by the overflow of its population; but the extraordinary ratio of increase is partly due to the absorption of contiguous municipalities. The township of Van Vorst, which had 4,617 inhabitants in 1850, was annexed in 1851; the cities of Hudson and Bergen, with 7,229 and 7,429 inhabitants respectively in 1860, were merged in 1870 (before the census); and in 1872 the township of Greenville was annexed. The population of Greenville in 1870 was 2,789, so that the population at the last census of the city as at present constituted was 85,335.—Jersey City is the terminus of the Morris canal and of six lines of railroad, viz.: the Erie, the Pennsylvania, the Central of New Jersey, the Northern New Jersey, the New Jersey Midland, and the New York and Newark. Besides these, the Morris and Essex division of the Delaware, Lackawanna, and Western railroad, which has its terminus at Hoboken, passes through the north part of the city. The ferry boats to New York are commodious and well appointed, and ply every few minutes throughout the day and night. Horse cars run to different parts of the city and to Hoboken. Jersey City forms part of the New York customs district, and its commerce is not separately returned. It is one of the termini of the Cunard steamship line between the United States and Great Britain. The immense quantities of coal and iron brought by the canal and railroads create an important business. Manufacturing is extensively carried on, the principal establishments being the United States watch company, large glass works, three crucible works, three steel works, zinc works, three boiler works, a machine shop, three foundries, a foundry and machine shop, three railroad repair and supply shops, locomotive works, two sugar refineries, three breweries, two planing mills, and manufactories of chains and spikes, medals, car springs, pottery, soap and candles, saleratus, castor and linseed oil, copper articles, drugs and chemicals, jewelry, fireworks, hydrants and lathes, rubber, oakum, black lead and lead pencils, stove polish, &c. The crucibles made here are used exclusively in the mints of Europe as well as of this country. The business of slaughtering live stock for the New York market was formerly carried on very extensively at Communipaw, in the S. part of the city, bordering on New York bay; but the stock yards have been removed, and an extensive abattoir, with stock yards, has been built in the N. part of the city near the river front, where cattle and sheep are slaughtered. This establishment was opened in the spring of 1874; it is connected by a branch with the Pennsylvania railroad, and drains into the river. Hogs are now only slaughtered on the Hackensack meadows beyond the city limits.—Jersey City contains three national banks with an aggregate capital of \$1,150,000, two state banks, eight savings banks, a trust company with \$200,000 capital, and four insurance companies. It is governed by a mayor and a board of 12 aldermen (two from each district), but the chief functions are exercised by the boards of police commissioners (five members), of public works (three), and of fire commissioners (five), chosen by the state legislature, and by the board of finance and taxation (five members), chosen by the board of aldermen. The county board of health has supervision of all contagious diseases. For police purposes the city is divided into five precincts, and the force consists of a chief of police, an inspector, 5 captains, 19 sergeants, and 155 men. The fire department has under its control 10 steam engines, three hand engines, five hook and ladder trucks, and a fire alarm telegraph, and the force consists of a chief engineer, an assistant, two district engineers, and 325 men, of whom 91 are permanently employed and 234 required to respond at call. The streets are well paved and sewered, and the city is supplied with gas by two companies, which have a united capital of \$1,050,000. The water works are at Belleville, on the Passaic river, 6 m. N. W. of the city. The water is pumped into the receiving reservoir by five engines, whence it is brought in pipes to the distributing reservoir within the city; another distributing reservoir is in course of construction. These works also supply Hoboken. The assessed value of property in 1871 was \$61,330,987; in 1872, \$68,496,855; in 1873, \$62,292,138, the decrease being due to the non-assessment of railroad property, which under recent laws is exempt. The estimated expenditures for the year ending Nov. 30, 1874, are \$1,376,480, of which \$317,000 (\$185,000 for lamps and lights) is on account of the board of public works; \$60,000, of hospital, dispensaries, poor, &c.; \$265,000, of schools; \$219,500, of police; \$149,430, of fire department; \$228,000, of interest; the rest miscellaneous. The bonded debt, April 1, 1874, amounted to \$13,082,775, including \$422,000 held by the commissioners of the sinking fund, of which \$5,286,500 consisted of assessment bonds, \$4,530,300 of water bonds, and \$3,265,975 of general debt. The principal charitable institutions are the city hospital, the home for aged women, and the children's home. There are two young men's Christian associations, a city mission and tract society, and numerous temperance societies, masonic and odd fellows' lodges, &c. The public schools are under the charge of a superintendent, who is appointed by the board of education, which consists of 12 members, two being elected from each aldermanic district. According to the report of the superintendent

for the year ending June 30, 1873, there were 16 school houses owned by the city and 5 buildings leased, affording 10,850 seats. The schools were divided as follows: 1 normal, 1 high, 15 grammar, 20 primary (2 colored), and 7 evening. The number of children of school age (5 to 18) was 80,758; enrolled in day schools, 16,762; average attendance, 8,320; number of teachers, 250 (18 males and 232 females); value of school property, \$674,416 72. The number enrolled in the evening schools was 2,812; average attendance, 792. The normal school is held on Saturdays for the instruction of teachers and candidates for employment as such. The expenditures, which are met partly by a state and partly by a city tax, were \$235,142 75, of which \$180,446 14 were for salaries. The number of private schools was 80 (10 denominational and 20 secular), with 5,973 pupils. Since the date of the report another school house has been opened. There are two daily and three weekly (two German) newspapers. The post office has two sub-stations. The number of churches is 59, viz.: 6 Baptist (1 German), 2 Congregational, 10 Episcopal, 2 German Evangelical Lutheran, 14 Methodist (1 German and 2 colored), 6 Presbyterian, 2 United Presbyterian, 8 Reformed, 8 Roman Catholic (1 German), and 1 Universalist.—Although the peninsula upon which Jersey City stands was granted by letters patent from Sir William Kieft, director general of the Dutch West India company, in the year 1638, it was used for farming purposes solely for more than 150 years, and it was not till the beginning of the present century that it began to be settled. In 1802 the whole population of the place, then called Paulus Hook, consisted of 18 persons, occupying but one house and out buildings. In 1804 the "associates of the Jersey company" were chartered by the legislature of New Jersey, and laid out the whole of Paulus Hook into blocks and streets. In 1820 "the city of Jersey" was incorporated with a board of selectmen; in 1838 it was re-incorporated under the name of "Jersey City," with a mayor and common council.

**JERUSALEM** (Heb. *Yerushalaim*, possession of peace; Gr. *Ἱερουζαλήμ*; Lat. *Hierosolyma*; Arab. *El-Khuds*, the holy, or *Khudaiah-Sherif*, the noble sanctuary), a city of Palestine, anciently capital of the kingdom of the Jews, afterward of that of Judah, and now the seat of a Turkish pasha. It is the holy city of the Jews and the Christians, and one of the three holy cities of the Mohammedans, ranking next in sanctity to Mecca and Medina. It is situated in lat. 31° 46' N., lon. 35° 14' E., 133 m. S. S. W. of Damascus, 33 m. E. of the Mediterranean, and 15 m. W. of the Dead sea; elevation above the Mediterranean, from about 2,000 to nearly 2,600 ft.; pop. about 20,000, of whom 5,500 are Mohammedans, 8,000 Jews, and 6,000 Christians, mostly of the Greek and Latin churches, the remainder Armenians, Protestants, Abyssinians, Copts, and Syrians. Jerusalem is built on a

high plateau about 2 m. square, connected on the north with the wide mountain range which runs N. and S. through Palestine, and which forms the watershed of the country, so that streams within a mile of the city walls flow on the one hand to the Mediterranean and on the other to the Dead sea. Between the plateau and the mountain ridge on the north is a low depression through which small streams flow during the rainy season. On the other sides the hills rise abruptly higher than the plateau on which the city stands. The limestone of this plateau is much harder than that of the surrounding hills, and is capable of receiving a high polish. The color is a pale yellow, with red or pink veins. W. of the city at Gihon, and on the N. side, about 1½ m. from each other, are two gentle depressions, one running S. E. and then E., the other E. and then S., gradually becoming deeper till they form two narrow ravines with precipitous sides. These are the valley of Hinnom and the valley of Jehoshaphat (or of the Kedron), which almost skirt the city in their course, and unite in the S. E. part, a little S. of the pool of Siloam and near the well En-rogel. A third ravine, the Tyropoeon, begins in the city, and running S. joins the other two at this point. The gorge continues its course S. E. till it is lost in the basin of the Dead sea. On the east the triple-peaked mount of Olives rises abruptly from the valley of Jehoshaphat. On the south the hill of Evil Counsel overhangs the valley of Hinnom, which separates it from Zion. On the side of the hill of Evil Counsel a chain of rocks rises precipitously from the valley to a height of 30 or 40 ft., and on the ridge is the small field called Acl-dama (field of blood), or potter's field. Further N. W., up the valley where it blends with Gihon, is the lower pool of Gihon, formed by a strong wall built across the lower end; it is called by the Arabs *birket es-Sultan*, pool of the sultan. The wall being now broken, it is used by the Arabs as a threshing floor. The course of this valley N. and then N. W. leads up to the plateau on which the city stands. On this spot, about ¼ m. from the city walls, is the upper pool of Gihon, a basin about 50 ft. long, 200 ft. broad, and 30 ft. deep. The water that accumulates in this pool, after settling, is conducted into the pool of Hezekiah, within the city, where it is used for bathing. On the sides of the pool of Gihon is the Turkish cemetery, which, as in other eastern cities is unfenced, and presents a desolate appearance. Immediately W. of this pool is the hill Gareb; the valley (Wady Haninah) beyond declines toward the Mediterranean. E. of this place, and next to the city, is a magnificent establishment built a few years ago by the Palestine commission of St. Petersburg, under the auspices of the emperor of Russia. It consists of the fine church of the Holy Trinity, two large hospices for male and female pilgrims respectively, a house for the missionaries and travellers of the higher classes, a hospital, and

a residence for the Russian consul. Near by is another large building for the Prussian deaconesses' schools. The country around Jerusalem is rocky and not very fertile. The rocks almost everywhere crop out at the surface, which in many parts is also thickly strewn with large stones, and the whole region has a dreary and barren aspect. At almost every siege the trees were either burned or cut down, and the vege-

It began N. W. of the tower Hippicus, extended to the Xystus, and terminated on the W. side of the temple, thus separating the upper from the lower city. The other part of the wall, toward the west, commencing also from Hippicus, passed by a place called Bethso to the gate of the Essenes; thence it turned S. and E., taking in all the south of Zion till above the pool of Siloam; it then turned N. E., by

the slope Ophel, and joined the E. cloister of the temple. The second wall began at the gate of Gennath, in the first wall E. of the tower Hippicus. Advancing thence toward the N. gate of the city, it turned S. E., and terminated at the fort of Antonia, which flanked the N. W. angle of the temple. The third wall began at the tower Hippicus, extended N. W. as far as the tower Psephinus, then turning E. passed by the tomb of Helena on the north for some distance, and finally turned S., joining the old wall E. of the temple. The present walls were built by the Turkish sultan Solyman the Magnificent in 1536-'9. They are 15 ft. thick at the base, and vary in height with the inequalities of the ground from 25 to 70 ft. Their total circuit is about 2½ m.—The city is irregular in its outline, but approaches a square whose four sides, each about ¼ m. long, nearly face the cardinal points. It has at present five gates that are open, two on the south, and one near the centre of each of the other sides. On the west is the Jaffa gate (or *bab el-Khalil*, Hebron



Plan of Modern Jerusalem.

tation destroyed. The soil thus exposed was gradually washed down into the valleys and thence to the plains, which to this day are remarkably fertile. Yet olives and vines thrive on the sides of these mountains, and fields of grain are seen in the valleys and level places.—The various parts of ancient Jerusalem were at different intervals surrounded by walls. The first old wall encircled Zion and a part of Moriah.

gate), the chief entrance to the city; on the north the Damascus gate (*bab el-Amud*, the gate of the columns); on the east St. Stephen's gate, called by the native Christians gate of our Lady Mary, and by the Mohammedans *bab el-Asbat*, gate of the tribes; on the south Zion gate (*bab en-nabi David*, gate of the prophet David), and another obscure portal, the Dung gate (*bab el-Magharibeh*, gate of the Moors),

near the centre of the Tyropœon. The Golden gate, on the E. side, is now walled up with solid masonry, and against it a tower has been erected, where a Mohammedan soldier is constantly on guard; for the Turks have a tradition that the Christians will some day enter by this gate and possess the city. Among the ancient gates mentioned in Scripture were the gates of Ephraim and Joshua, the horse, sheep, and fish gates (probably with adjoining market places for the sale of horses, &c.), and the old, fountain, and water gates. The streets are narrow, winding, dirty, and badly paved; the principal and broadest street is about 15 ft. wide, and some are only 5 or 6 ft. The houses are built of heavy masonry, with thick walls supporting arched roofs. They have neither symmetry nor elegance, but the rooms are generally lofty and well ventilated. The houses are usually two or three stories high, with a plain front, few or no windows in the lower stories, and doors so low that a person must stoop in entering. The roofs are terraced or rise in domes, and the apartments receive light from interior courts, which in the larger houses form cool and agreeable promenades, and sometimes are turned into gardens, where the household spend their leisure time. The principal apartments are in the upper story, the lower being

occupied by lumber rooms, kitchens, stables, cisterns, and offices. Some of the houses are three or four centuries old.—The city, as seen from the mount of Olives, above the ancient Gethsemane, appears to be a regular inclined plane, sloping gently and uniformly from W. to E., or toward the observer, and indented by a slight depression or vale running N. and S., the Tyropœon, which was formerly a deep ravine, but was filled up by Simon Maccabæus when he razed Acra. The elevation W. of the Tyropœon is Zion, E. Moriah and Ophel, N. Acra, and N. E. Bezetha. The S. E. corner is occupied by the great mosque and its extensive and beautiful grounds on Mt. Moriah, comprising about one seventh of the modern city. This enclosure corresponds, in part at least, with the ancient temple area. The site was purchased by David,

having been the threshing floor of Araunah, an altar was built, and materials were collected for the temple. The building was erected by Solomon about 1012–1005 B. C., its general plan being taken from the ancient tabernacle, while the dimensions were exactly doubled. It was 120 ft. long and 60 ft. wide, and consisted of three parts, the porch, the holy place, and the holy of holies, surrounded on all sides but the front by small chambers arranged in three stories, for the priests. The porch probably rose in a lofty second story, and its ceiling was supported by two highly ornamented pillars of brass. The temple stood within courts and cloisters of great beauty, and was connected by stone bridges spanning the Tyropœon valley with the royal palace and the city on Mt. Zion. It was destroyed by Nebuchadnezzar in 586 B. C., and was rebuilt by Zerub-



The Great Mosque (Kubbet es-Sakhra).

babel about 520, but of its restored character we have little information. The temple of Zerubbabel was standing however in the time of Herod, and the restoration by that king was in two parts: the temple proper, which the priests rebuilt in 18 months, not trusting the work to profane hands, and perhaps only repairing the ancient building; and the courts and porches or cloisters, which Herod greatly enlarged, spending eight years in fitting them for use, while the work of completion continued nearly 50 years. The façade of the temple consisted of a lofty arch spanning the entrance. The temple was surrounded by a court about 360 ft. long and 270 ft. wide, adorned by porticoes and ten magnificent gates, one of them probably the "gate called Beautiful;" while beyond this was an enclosure about 600 ft. square, bounded by por-

ticoes surpassing in size those of any other ancient temple. The whole structure was of white marble, the roofs lavishly adorned with gold, and the high and massive walls of the enclosure made it the stronghold of the Jews during the siege by Titus. The hill is now covered with greensward, and planted sparingly with olives, cypresses, and other trees, and is the most beautiful feature in the city. About the middle of this enclosure is a large and nearly rectangular platform, about 10 ft. high, 500 ft. long, and from 460 to 500 ft. in width. On this platform stands the grand mosque, *Kubbet es-Sakhra*, "Dome of the Rock." The building is an octagon, each side of which measures 67 ft. It is surmounted by a light and graceful dome, terminated by a tall crescent. Its exterior walls are covered with tiles of white, blue, and yellow glazed porcelain, with intricate arabesque patterns and inscriptions. The lower parts of the walls are further decorated with slabs of marble, few corresponding to each other; they are said to have been taken from the ruins. Four doors, facing the cardinal points, lead to the interior, which is about 150 ft. in diameter. A corridor 18 ft. wide runs round, having on its inner side 8 piers and 16 marble and granite Corinthian columns; the columns do not appear to occupy their proper places, and the Arabs say that they were lying about among the ruins when the mosque was built. Within these is another corridor 30 ft. wide, with 12 larger columns and 4 great piers, which together support the dome. Under this dome is the rock, which varies in height from one foot to five feet from the surface. Under the rock is a cave, partly excavated, which is entered on the southeast by a flight of stairs. Here are pointed out the altars of Solomon, David, Abraham, and St. George. In the centre of this chamber is a circular slab of marble, which on being stamped upon gives a hollow sound; the Mohammedans call this the "well of souls," and believe that the souls of believers descend there after death. The legend is that Mohammed, in his midnight visit to heaven, first alighted on this rock, from which he continued his journey, whereupon the rock raised itself to follow, but was prevented by the angel Gabriel; it therefore remained suspended in the air. About 450 ft. S. from the Sakhra, in the S. W. part of the enclosure, is the mosque Aksa (end or extremity, used figuratively, as *akasi el-ard*, "the ends of the earth"). Its form is that of a basilica of seven aisles; it is 272 ft. long by 184 ft. wide; in front there is a porch 20 ft. wide. The piers and columns in the interior are inferior to those in the Sakhra. At the S. end is a Saracenic dome similar to the Kubbet es-Sakhra, but much smaller. To the left, on the east, a door leads into a smaller mosque, said to have been the only one built by Omar. In front of the Aksa is a large basin with a fountain in the middle. The water that issued here was conducted from the

pools of Solomon, 6 m. S. of the city; but the aqueduct has lately been broken by the Arabs, who supply the city with water from the well En-rogel, near the junction of the valleys of Jehoshaphat and Hinnom. The building of the two mosques, the Sakhra and Aksa, is ascribed to Abdelmalek in 686; but some writers say that the emperor Justinian built the Aksa, then the church of St. Mary. Between this place and the E. wall are extensive subterranean cellars, called the stables of Solomon, nearly 200 ft. long and 100 ft. wide, supported by columns about 25 ft. high. In the centre of the E. wall is the Porta Aurea, a double gateway (*bab ed-Dahariyeh*, the Eternal gate), a magnificent portal with finely sculptured arches, which have been sadly defaced by travellers since the mosque was opened to Christians. When the crusaders held the city, a procession of Christians bearing palms entered by this gate on every Palm Sunday. The whole enclosure, including the mosques, is called Haram esh-Sherif. In this enclosure are immense tanks, calculated to hold nearly 8,000,000 gallons of water, which, together with the supply from the Virgin's fountain and the cisterns in the houses, would last during a protracted siege. The actual spot where the temple stood has not yet been ascertained. The Porte, although it has granted the English engineers permission to excavate around the city and in parts of it where no injury will be done to the dwellings, has not been able to overcome the superstition and fanaticism of the natives so far as to allow them to dig within the precincts of the Haram. On the S. W. side of the Haram a portion of the temple wall is still standing, known as the Jewish wailing place; in this wall are five courses of large bevelled stones in a very good state of preservation. Here the Jews assemble every Friday to lament the woes of their country. The pool of Bethesda (now *Birket Israil*), N. of the Haram, near St. Stephen's gate, is a reservoir about 360 ft. long, 130 ft. broad, and 75 ft. deep.—The church of the Holy Sepulchre is situated almost in the heart of the N. part of the city, where the empress Helena is said to have discovered the true cross. (See *Cross*, vol. v., p. 513.) Concerning the authenticity of the sacred places a great deal of controversy has existed and is still kept up. Dr. Robinson, in his "Biblical Researches," arrives at the conclusion "that the genuineness of the present site of the holy sepulchre is supported neither by well authenticated historical facts, nor by prior tradition, nor by archaeological features." His main argument to this effect attempts to show by the topography of Jerusalem that the present locality of the sepulchre was within the walls of the city at the time of the crucifixion, and consequently could not be near the place where Christ was crucified, which is stated in the Gospel to have been without the gates. Most Protestant and a few Catholic investigators agree substantially with Dr. Robinson; while



on the other hand the great majority of Catholics and some Protestant travellers believe in the genuineness of these remains. Among others, Mr. William C. Prime maintains the authenticity of the sepulchre on the following grounds: "It is not credible that this locality was forgotten by Christians within 800 years after the great events of the crucifixion, burial, and resurrection. Critical scholars and learned men, employed in investigating the topography of the Holy Land, had no doubt of its authenticity in the beginning of the 4th century; no one, so far as we know, thought in that age of disputing the fact, but all men acknowledged its truth; it is not doubted by any one that this is the locality in which those learned men placed their confidence, it having been well preserved from that time to this." The main entrance to the church is on the south. After descending a broad flight of rude steps, a large open paved court is reached, along

near the entrance, is called the stone of unction, and is said to cover that upon which Joseph laid the body of Christ to be anointed for burial. On the east of the stone is a chamber, the roof of which forms the floor of the chapel of Golgotha; this chamber has on the right and left the tombs of Godfrey and Baldwin, between which the visitor passes to the chapel of Adam, ending against the native rock, in which a huge fissure is visible, said to have been made by the earthquake at the time of the crucifixion. This rock, ascending through the roof, is pointed out as Calvary, where Jesus was crucified. Ascending a flight of stairs outside of the chapel of Adam and the chamber of Godfrey and Baldwin, the low vaulted chapel of Golgotha is entered. At the E. end is a platform about 10 ft. long by 7 ft. broad, and 20 in. high. In the centre is an altar, under which is a hole in the marble slab on the floor, said to be the place where the Saviour's cross

was fixed, and on the right and left are shown the holes where the crosses of the thieves were placed. In the platform is another opening in the marble pavement, through which is seen a rent in the rock continuous with the one below in the chapel of Adam. On the right hand, S. of the platform, is another division called the chapel of the crucifixion, said to have been the place where Christ was nailed to the cross. This part does not stand on the rock, but forms a kind of upper story, which is accounted for by saying that Helena removed



Church of the Holy Sepulchre.

whose sides are the bases of a row of columns, which probably once supported cloisters. Recent excavations have shown that under this court is a crypt with arches of high antiquity. On the left is the convent and chapel of St. James; and on the opposite side is the convent of Abraham or Isaac, in the place, the Greeks say, where Abraham was going to sacrifice his son. The façade of the church occupies nearly the whole of the N. side of the court. The lower story has a wide double gateway, with marble and granite columns supporting richly sculptured architraves, on which is represented Christ's triumphant entry into Jerusalem; over these are finely carved arches. The eastern section has been closed for several centuries; it is said to have been walled up by the Moslems to limit the Christians to one entrance, where the fees could be collected by one person. A large polished slab of stone on the floor of the church,

the ground beneath it and took it to Rome, so that the chapel is still on the real site. Through a barred window in this division another chapel is seen, the entrance to which is by a flight of steps outside of the church. Here the Virgin Mary and the other women stood watching the crucifixion. Returning down stairs from the chapel of Golgotha, and passing by the stone of unction, we enter the rotunda, about 70 ft. in diameter, surrounded by 18 massive piers which support the Armenian church on one hand and the Latin galleries on the other; the whole surmounted by a large dome with an opening at the top. This dome was a few years ago in a ruinous condition, but in 1899-'70 it was repaired at the joint expense of the French, Russian, and Turkish governments. This combined action was a compromise reached after long negotiations, in which the two Christian powers strenuously contended for the privilege of doing the work, as protectors re-

spectively of the Latin and Greek churches in Palestine, in order to establish a claim to exclusive possession. Claims thus originating in the large churches of Jerusalem, partitioned among different sects, have sometimes resulted in fierce quarrels, lawsuits, and even fights, requiring the interference of the Turkish soldiery. The space behind the piers was formerly open; now it is partitioned off and divided among the various sects. In the centre of the rotunda is the holy sepulchre. Above it is a chapel 26 ft. long and 18 ft. broad, built of polished native limestone, and surmounted with a small dome. The façade is ornamented with several twisted marble and limestone columns, and numerous silver and brass lamps, pictures, &c. On each side of this chapel is a small circular aperture, through which the holy fire is dealt out to the pilgrims by the Greek patriarch within. The chapel is divided into two compartments. The front chamber is the "chapel of the angel," where the angel is supposed to have sat on the stone which he rolled away from the door of the sepulchre; in the centre of the apartment, on a pedestal, is a fragment of the stone; the other part is said to have been placed by the Armenians in the convent of Caiaphas, just outside of the Zion gate. In the second chamber, which is entered by a low narrow doorway, is the tomb of Christ, occupying the whole length and nearly half the width of the apartment. It is raised about two feet from the floor, and covered with a single slab of marble, whose edges have been worn off by the kisses and embraces of the pilgrims who for centuries have gathered here from all parts of the world. Facing the chapel over the sepulchre is the Greek section of the church. It is the nave of the edifice, but is now divided from the aisles by high walls, said to have been built by the Greeks after the crusaders were expelled by Saladin. This church is quadrangular, about 70 ft. by 40. At the E. end is the high altar, reached by four steps, and divided by a richly gilt screen. On the right hand is the Greek patriarch's throne. In the centre a small column indicates the middle of the earth, and Adam's skull is said to be buried beneath. There are two other side doors, N. and S., opening into the aisles. Returning by the main entrance on the west, facing the sepulchre, the visitor turns to the right, passing between the piers of the rotunda, and arrives at a circular marble pavement, where Mary, according to the tradition, stood when she first saw Christ after his resurrection. On the north, ascending a few steps, is the Catholic section of the church. In this place is pointed out the pillar to which Christ was bound when scourged; the pillar itself is hidden from view by the building, but a stick with a silver head is thrust through an iron grating in the wall; the silver head, having touched the pillar, is drawn out and kissed. In the vestry of this chapel the sword of Godfrey is exhibited. Returning and following

the course of the aisles behind the Greek section, the visitor, after passing one or two stations connected with different events in the passion of Christ, arrives at a long flight of stairs leading to Helena's church, a massive and rudely constructed edifice, crowned by a dome with windows to admit the light. Here Helena sat while search was made for the cross. At the further end another flight of stairs leads down to the cave where the cross, the crown of thorns, and the nails were discovered. It is an irregular excavation in the rock; at one end an altar marks the spot where the true cross lay. Ascending again, and continuing his course, the pilgrim arrives at last at the principal gate to the church, near the stairs leading to Golgotha, from which he first started. About 35 yards beyond the E. door of the church of the Sepulchre are the ruins of the hospital of the knights of St. John; the entrance is by a picturesque Gothic gateway, the façade of which was richly carved with historical and symbolical sculptures, now nearly defaced by curious tourists. Beyond the gateway is an open court, part of which was once the church; at the E. end is the altar. A stairway on the south leads to a corridor surrounding a quadrangular court. The building itself is very spacious, but the chambers and halls have for ages been filled with rubbish, and several are in ruins. In 1869, on the occasion of the visit of the crown prince of Prussia, the Turkish sultan presented him with these ruins; and the Prussians are now clearing them out, and intend to restore the church and other parts of the building.—On the west of Jerusalem, at the Jaffa gate, is the citadel, consisting of three high square towers, separated from the city by a low wall and from the suburbs by a deep and wide moat. The largest and highest is called the tower of David. The lower part, rising in a solid mass, is undoubtedly ancient, and is probably the remnant of the tower Hippicus, built by Herod, and named from his friend who had fallen in the Parthian wars. The upper part, like the other towers, is of more modern construction. The battlements afford a view of the whole city, the mount of Olives, the Dead sea, and the mountains of Moab beyond. To the northeast lies the pool of Hezekiah; to the south lie the gardens of the Armenian convent, in which are the ruins of the pool of Bethesda; and to the west the Jewish almshouses, built by Sir Moses Montefiore as executor of his American coreligionist Judah Touro, who bequeathed a large sum of money for that purpose. The tomb of David, now outside of the walls, S. of the Zion gate, was formerly within the city; the place is kept by the Mohammedans, who have a mosque over the spot. In the large hall, the *cenaculum*, is a stairway leading to the cave which is said to contain the tombs of David and his successors; but no one is allowed to enter. Over the cave is a small room with a raised structure about 3 ft. high, representing a Moslem

on the other hand the great majority of Catholics and some Protestant travellers believe in the genuineness of these remains. Among others, Mr. William C. Prime maintains the authenticity of the sepulchre on the following grounds: "It is not credible that this locality was forgotten by Christians within 800 years after the great events of the crucifixion, burial, and resurrection. Critical scholars and learned men, employed in investigating the topography of the Holy Land, had no doubt of its authenticity in the beginning of the 4th century; no one, so far as we know, thought in that age of disputing the fact, but all men acknowledged its truth; it is not doubted by any one that this is the locality in which those learned men placed their confidence, it having been well preserved from that time to this." The main entrance to the church is on the south. After descending a broad flight of rude steps, a large open paved court is reached, along

near the entrance, is called the stone of unction, and is said to cover that upon which Joseph laid the body of Christ to be anointed for burial. On the east of the stone is a chamber, the roof of which forms the floor of the chapel of Golgotha; this chamber has on the right and left the tombs of Godfrey and Baldwin, between which the visitor passes to the chapel of Adam, ending against the native rock, in which a huge fissure is visible, said to have been made by the earthquake at the time of the crucifixion. This rock, ascending through the roof, is pointed out as Calvary, where Jesus was crucified. Ascending a flight of stairs outside of the chapel of Adam and the chamber of Godfrey and Baldwin, the low vaulted chapel of Golgotha is entered. At the E. end is a platform about 10 ft. long by 7 ft. broad, and 20 in. high. In the centre is an altar, under which is a hole in the marble slab on the floor, said to be the place where the Saviour's cross

was fixed, and on the right and left are above the holes where the crosses of the thieves were placed. In the platform is another opening in the marble pavement, through which is seen a rent in the rock continuous with the one below in the chapel of Adam. On the right hand, S. of the platform, is another division called the chapel of the crucifixion, said to have been the place where Christ was nailed to the cross. This part does not stand on the rock, but forms a kind of upper story, which is accounted for by saying that Helena removed



Church of the Holy Sepulchre.

whose sides are the bases of a row of columns, which probably once supported cloisters. Recent excavations have shown that under this court is a crypt with arches of high antiquity. On the left is the convent and chapel of St. James; and on the opposite side is the convent of Abraham or Isaac, in the place, the Greeks say, where Abraham was going to sacrifice his son. The façade of the church occupies nearly the whole of the N. side of the court. The lower story has a wide double gateway, with marble and granite columns supporting richly sculptured architraves, on which is represented Christ's triumphant entry into Jerusalem; over these are finely carved arches. The eastern section has been closed for several centuries; it is said to have been walled up by the Moslems to limit the Christians to one entrance, where the fees could be collected by one person. A large polished slab of stone on the floor of the church,

the ground beneath it and took it to Rome, so that the chapel is still on the real site. Through a barred window in this division another chapel is seen, the entrance to which is by a flight of steps outside of the church. Here the Virgin Mary and the other women stood watching the crucifixion. Returning down stairs from the chapel of Golgotha, and passing by the stone of unction, we enter the rotunda, about 70 ft. in diameter, surrounded by 16 massive piers which support the Armenian church on one hand and the Latin galleries on the other; the whole surmounted by a large dome with an opening at the top. This dome was a few years ago in a ruinous condition, but in 1869-'70 it was repaired at the joint expense of the French, Russian, and Turkish governments. This combined action was a compromise reached after long negotiations, in which the two Christian powers strenuously contended for the privilege of doing the work, as protectors re-

spectively of the Latin and Greek churches in Palestine, in order to establish a claim to exclusive possession. Claims thus originating in the large churches of Jerusalem, partitioned among different sects, have sometimes resulted in fierce quarrels, lawsuits, and even fights, requiring the interference of the Turkish soldiery. The space behind the piers was formerly open; now it is partitioned off and divided among the various sects. In the centre of the rotunda is the holy sepulchre. Above it is a chapel 26 ft. long and 18 ft. broad, built of polished native limestone, and surmounted with a small dome. The façade is ornamented with several twisted marble and limestone columns, and numerous silver and brass lamps, pictures, &c. On each side of this chapel is a small circular aperture, through which the holy fire is dealt out to the pilgrims by the Greek patriarch within. The chapel is divided into two compartments. The front chamber is the "chapel of the angel," where the angel is supposed to have sat on the stone which he rolled away from the door of the sepulchre; in the centre of the apartment, on a pedestal, is a fragment of the stone; the other part is said to have been placed by the Armenians in the convent of Caiaphas, just outside of the Zion gate. In the second chamber, which is entered by a low narrow doorway, is the tomb of Christ, occupying the whole length and nearly half the width of the apartment. It is raised about two feet from the floor, and covered with a single slab of marble, whose edges have been worn off by the kisses and embraces of the pilgrims who for centuries have gathered here from all parts of the world. Facing the chapel over the sepulchre is the Greek section of the church. It is the nave of the edifice, but is now divided from the aisles by high walls, said to have been built by the Greeks after the crusaders were expelled by Saladin. This church is quadrangular, about 70 ft. by 40. At the E. end is the high altar, reached by four steps, and divided by a richly gilt screen. On the right hand is the Greek patriarch's throne. In the centre a small column indicates the middle of the earth, and Adam's skull is said to be buried beneath. There are two other side doors, N. and S., opening into the aisles. Returning by the main entrance on the west, facing the sepulchre, the visitor turns to the right, passing between the piers of the rotunda, and arrives at a circular marble pavement, where Mary, according to the tradition, stood when she first saw Christ after his resurrection. On the north, ascending a few steps, is the Catholic section of the church. In this place is pointed out the pillar to which Christ was bound when scourged; the pillar itself is hidden from view by the building, but a stick with a silver head is thrust through an iron grating in the wall; the silver head, having touched the pillar, is drawn out and kissed. In the vestry of this chapel the sword of Godfrey is exhibited. Returning and following

the course of the aisles behind the Greek section, the visitor, after passing one or two stations connected with different events in the passion of Christ, arrives at a long flight of stairs leading to Helena's church, a massive and rudely constructed edifice, crowned by a dome with windows to admit the light. Here Helena sat while search was made for the cross. At the further end another flight of stairs leads down to the cave where the cross, the crown of thorns, and the nails were discovered. It is an irregular excavation in the rock; at one end an altar marks the spot where the true cross lay. Ascending again, and continuing his course, the pilgrim arrives at last at the principal gate to the church, near the stairs leading to Golgotha, from which he first started. About 35 yards beyond the E. door of the church of the Sepulchre are the ruins of the hospital of the knights of St. John; the entrance is by a picturesque Gothic gateway, the façade of which was richly carved with historical and symbolical sculptures, now nearly defaced by curious tourists. Beyond the gateway is an open court, part of which was once the church; at the E. end is the altar. A stairway on the south leads to a corridor surrounding a quadrangular court. The building itself is very spacious, but the chambers and halls have for ages been filled with rubbish, and several are in ruins. In 1869, on the occasion of the visit of the crown prince of Prussia, the Turkish sultan presented him with these ruins; and the Prussians are now clearing them out, and intend to restore the church and other parts of the building.—On the west of Jerusalem, at the Jaffa gate, is the citadel, consisting of three high square towers, separated from the city by a low wall and from the suburbs by a deep and wide moat. The largest and highest is called the tower of David. The lower part, rising in a solid mass, is undoubtedly ancient, and is probably the remnant of the tower Hippicus, built by Herod, and named from his friend who had fallen in the Parthian wars. The upper part, like the other towers, is of more modern construction. The battlements afford a view of the whole city, the mount of Olives, the Dead sea, and the mountains of Moab beyond. To the northeast lies the pool of Hezekiah; to the south lie the gardens of the Armenian convent, in which are the ruins of the pool of Bathsheba; and to the west the Jewish almshouses, built by Sir Moses Montefiore as executor of his American coreligionist Judah Touro, who bequeathed a large sum of money for that purpose. The tomb of David, now outside of the walls, S. of the Zion gate, was formerly within the city; the place is kept by the Mohammedans, who have a mosque over the spot. In the large hall, the *canaculum*, is a stairway leading to the cave which is said to contain the tombs of David and his successors; but no one is allowed to enter. Over the cave is a small room with a raised structure about 3 ft. high, representing a Moslem

grims and travellers who visit the city. Beads, crosses, and ornaments are largely manufactured and sold to strangers. Quantities of olive and sesame oil and soap are also produced here, and much is exported to Egypt and to ports on the Mediterranean; grain and other articles are also exported. Almost all manufactured articles, as cloths, sugars, candles, &c., are imported from France, England, and Germany. Petroleum has for several years been in great demand in the markets of Palestine, and has now almost superseded olive and sesame oil for lighting, these being used only for food and manufacturing soap.—The primitive name of Jerusalem appears to have been Jebus, or poetically Salem, and its king in the time of Abraham was Melchizedek. When Abraham returned from the slaughter of the kings who had made his nephew Lot prisoner, the king of Sodom met him in the valley of Shaveh, or the king's dale, now probably the valley of Jehoshaphat; and there Melchizedek brought bread and wine. At the conquest of Canaan by the Hebrews, the tribe of Judah took the city and set it on fire; but the fortress probably still remained in the hands of the Jebusites for 400 years longer. Its situation among the mountains almost in the heart of his kingdom naturally excited in David a desire to possess it. In the ninth year of his reign (about 1046 B. C.) he stormed the fortress of the Jebusites, Zion, called it the city of David, and made the place the capital of his kingdom. From that time it has been called Jerusalem. Under Solomon the temple was built on Mt. Moriah, and several palaces were erected. David's many conquests, his vast accumulation of treasures for the temple, the magnificent structure itself, and afterward Solomon's reputed wisdom and immense wealth, all tended to spread the fame of the city, and during his reign it attained its highest degree of power. At the accession of his son Rehoboam ten of the tribes seceded under Jeroboam and made Shechem, and subsequently Samaria, the capital of their kingdom of Israel. Jerusalem then lost much of its importance, remaining only the capital of the smaller, though more powerful, kingdom of Judah. About 971 B. C. Shishak, king of Egypt, took the city and plundered the temple and palace of their treasures. It was again conquered and sacked by Joash, king of Israel, and was afterward beautified by Uzziah, Jotham, Hezekiah, and Manasseh. In the time of Ahaz the king of Syria attacked Jerusalem, and carried many of the Jews captive to Damascus, though he could not take the city. Under Hezekiah it was besieged by Rabshakeh, the general of Sennacherib, king of Assyria, but it was saved by the sudden destruction which overtook the Assyrian army. Manasseh's being carried captive to Babylon seems to intimate that the city was taken by the Chaldeans about 650, although the fact is not expressly stated in the Bible. After the death of Josiah at the battle of Megiddo, Jerusalem was tributary to

Pharaoh Necho, king of Egypt, for two or three years, when it passed into the hands of the Babylonians, who, after repeated revolts and sieges, finally reduced it in 586. (See HAZARVA.) On this occasion Nebuchadnezzar demolished the walls and all the principal houses in the city, plundered and destroyed the temple, and carried away to Babylon all except the poorest citizens. For the next 50 years Jerusalem remained in ruins, till the return of the Jews during the reign of Cyrus, the conqueror of Babylon (538). This monarch issued a proclamation allowing the return of the Jewish captives to Jerusalem and authorizing them to rebuild the temple, and enjoined every one to contribute to and assist in this work. A part of the captives returned under Zerubbabel, and rebuilt the altar and laid the foundation of the second temple. But they were interrupted by the intrigues of their enemies, who unceasingly wrote insinuating letters to the capital of the empire, and at last succeeded in stopping them. The work was renewed under Ezra, who obtained a commission from Artaxerxes (Longimanus). In the 20th year of his reign (458) the king commissioned Nehemiah to rebuild the city itself. This he effectually carried out in spite of the opposition of his enemies, being himself appointed civil governor of Judea, and having the direct patronage of the king, whose cap-bearer he was. Nehemiah rebuilt the walls on the ruins of the old city. From this period till the Macedonian invasion in 332 Jerusalem enjoyed comparative peace. Yielding to Alexander without resistance, it escaped the fate of Tyre and Gaza. After the death of that conqueror and the division of his empire among his generals, Judea and its capital, lying between the rival kingdoms of Egypt and Syria, were alternately seized by the sovereigns of these two countries. Under the Ptolemies Jerusalem flourished both as a commercial city and a shrine. It was well adapted for trade, and abounded in artificers of various crafts. Its markets were well supplied by the Arabs with spices, gold, and precious stones. Goods were also imported across the sea, for there were good harbors at Gaza, Joppa, and Ptolemais (Acre). It passed into the power of Syria with the rest of Judea, in 198, and was finally ruled by Antiochus the Great; but the tyranny of his son, Antiochus Epiphanes, inflicted on it repeated massacres, and finally brought about the victorious revolt under the Asmoneans. Judas Maccabeus wrested Jerusalem from his enemies, and repaired the temple (165), though he was unable to expel the garrison that had been left in the fortress of Acra W. of Moriah, which commanded the temple, and from which the Syrians made annoying sallies. Against it he fortified Mt. Zion. This, however, shortly after surrendered to Antiochus V., who, breaking the capitulation, demolished the fort. Jonathan, the brother and successor of Judas, rebuilt it, but equally failed in an attack on Acra. His brother Simon reduced Acra, de-

d the citadel, and levelled the hill. In Jerusalem was captured by Pompey, who led between the brothers Aristobulus and Hyrcanus, the walls were demolished, and the lives of the inhabitants were slain. He entered the temple, but did not touch any treasures. It was plundered by Crassus, on his way to Parthia, in 54. The walls were destroyed by Antipater, who was appointed procurator of Judea by the Romans. In 40 the Romans, allies of Antigonus, son of Aristobulus, sacked the city. Herod, having been appointed king by the Roman senate, besieged Jerusalem, and took it in 37, and the massacre on that occasion was as bloody as that by Pompey. Herod erected or enlarged and beautified the Temple of Antonia; he also improved and beautified the city, and restored the temple on a magnificent scale than Solomon's. Jerusalem appears now to have reached the zenith of its greatness, though not of its power, which it never recovered after the death of Solomon. It is conjectured that the city at this time contained at least 200,000 inhabitants in its lofty and densely compacted dwellings. This period is marked by the most memorable events in Jewish history, the ministry and crucifixion of Jesus.

About A. D. 66 the Jews, goaded by the tyranny of the Romans, revolted against the possession of Jerusalem, and defeated an army commanded by Cestius Gallus, the governor of Syria. This was the beginning of the Jewish war which ended in the destruction of Jerusalem. In 70 Titus, with a long and vigorous siege, took the city, and the soldiery, maddened by the obstinacy of the defenders and their own fruitless attempts and great losses, neither age nor sex. Thousands of Jews, seeing all hope lost, threw themselves from the towers, turned their swords on their own breasts, rushed into the sea, or fell fighting the enemy. Titus himself is unable to control the rage of his soldiers, and with regret saw the temple destroyed by the flames and the principal towers levelled, which he had intended to preserve as trophies of his own victories. According to Josephus, 1,100,000 Jews perished in this war, and 97,000 were carried into captivity; but Titus says that the number besieged in Jerusalem, including both sexes and every age, amounted to 600,000; but a critical examination of the facts proves both statements to be exaggerated. The walls were levelled, the Temple of Moriah literally ploughed over. Sixty years afterwards Hadrian resolved to rebuild Jerusalem and colonize it with Romans. But a rebellion headed by Bar-Cokheba, for a long time frustrated the realization of his plans. For two years the insurgents held out in Jerusalem, but at last they were vanquished, and the edifices as remained or had been rebuilt were again demolished by the emperor's general. On the ruins Hadrian built

another city with luxurious palaces, a theatre, temples, and other public buildings. He called it *Ælia*, after his family name *Ælius*. On the site of the Jewish temple he raised another to Jupiter Capitolinus, from which the city took its surname of *Capitolina*. It is said that he erected a fane of Venus over the sepulchre of Christ, and Jews were forbidden to enter or come within a certain distance of the city on pain of death. Under the Christian emperors they were permitted to enter once a year, on payment of a large sum of money, to lament over their misfortunes. Under Constantine the city had already become the place of pilgrimage of the Christian world. It regained its ancient name, and the emperor furnished new attractions by the erection of a church over the place that had been pointed out as the sepulchre of Christ. The emperor Julian not only allowed the Jews to return to their city, but also made a futile attempt to rebuild the temple. About 530 Justinian followed the example of Constantine by building churches and hospitals in the city. In 614 Chosroes II. of Persia invaded the Roman empire. A division of his army marched into Palestine, and 26,000 Jews mustered under his banner, hoping to find in him a second Cyrus. After conquering the northern parts of Palestine, the united army of Persians and Jews laid siege to and captured Jerusalem. The Jews wreaked their vengeance on the Christians for all the persecutions they had suffered at their hands; 20,000 of them are said to have fallen, the church of the Holy Sepulchre was burned, and the part of the reputed cross of Christ which was deposited there was carried to Persia. It was recovered by the emperor Heraclius, and replaced in the church of the Holy Sepulchre with great pomp, and the law of Hadrian forbidding the Jews to enter the city was renewed. In 636 Jerusalem was besieged by Khaled and Abu Obeidah, the generals of the caliph Omar. The siege lasted four months, and scarcely a day passed without a sortie or an attack. The besiegers, notwithstanding the inclemency of the winter and the hardships against which they had to combat, displayed great courage and persistence. The patriarch Sophronius at length resolved to capitulate, but insisted upon treating with the caliph in person, hoping to gain from him better terms than he could from his generals. Omar came up to Jerusalem, and on taking possession of the city treated the inhabitants with great kindness and generosity. In the latter part of the 11th century Syria was invaded by the Seljuk Turks and converted into a province of their empire. The cruelties which the Christian pilgrims suffered at the hands of these people roused the indignation of all western Europe, and great numbers of the chivalry of France and England were led by Godfrey de Bouillon to recover the sepulchre from the infidels. Jerusalem was stormed and taken, July 15, 1099, and the crusaders, in their zeal to avenge the wrongs of the Christians, slew 70,-

for the year ending June 30, 1873, there were 16 school houses owned by the city and 5 buildings leased, affording 10,850 seats. The schools were divided as follows: 1 normal, 1 high, 15 grammar, 20 primary (2 colored), and 7 evening. The number of children of school age (5 to 18) was 30,758; enrolled in day schools, 16,762; average attendance, 8,320; number of teachers, 250 (18 males and 232 females); value of school property, \$674,416 72. The number enrolled in the evening schools was 2,812; average attendance, 792. The normal school is held on Saturdays for the instruction of teachers and candidates for employment as such. The expenditures, which are met partly by a state and partly by a city tax, were \$235,142 75, of which \$180,446 14 were for salaries. The number of private schools was 80 (10 denominational and 20 secular), with 5,973 pupils. Since the date of the report another school house has been opened. There are two daily and three weekly (two German) newspapers. The post office has two sub-stations. The number of churches is 59, viz.: 6 Baptist (1 German), 2 Congregational, 10 Episcopal, 2 German Evangelical Lutheran, 14 Methodist (1 German and 2 colored), 6 Presbyterian, 2 United Presbyterian, 8 Reformed, 8 Roman Catholic (1 German), and 1 Universalist.—Although the peninsula upon which Jersey City stands was granted by letters patent from Sir William Kieft, director general of the Dutch West India company, in the year 1638, it was used for farming purposes solely for more than 150 years, and it was not till the beginning of the present century that it began to be settled. In 1802 the whole population of the place, then called Paulus Hook, consisted of 13 persons, occupying but one house and out buildings. In 1804 the "associates of the Jersey company" were chartered by the legislature of New Jersey, and laid out the whole of Paulus Hook into blocks and streets. In 1820 "the city of Jersey" was incorporated with a board of selectmen; in 1838 it was re-incorporated under the name of "Jersey City," with a mayor and common council.

**JERUSALEM** (Heb. *Yerushalaim*, possession of peace; Gr. *Ἱερουσαλήμ*; Lat. *Hierosolyma*; Arab. *El-Khuds*, the holy, or *Khudsah-Sherif*, the noble sanctuary), a city of Palestine, anciently capital of the kingdom of the Jews, afterward of that of Judah, and now the seat of a Turkish pasha. It is the holy city of the Jews and the Christians, and one of the three holy cities of the Mohammedans, ranking next in sanctity to Mecca and Medina. It is situated in lat. 31° 46' N., lon. 35° 14' E., 133 m. S. S. W. of Damascus, 33 m. E. of the Mediterranean, and 15 m. W. of the Dead sea; elevation above the Mediterranean, from about 2,000 to nearly 2,600 ft.; pop. about 20,000, of whom 5,500 are Mohammedans, 8,000 Jews, and 6,000 Christians, mostly of the Greek and Latin churches, the remainder Armenians, Protestants, Abyssinians, Copts, and Syrians. Jerusalem is built on a

high plateau about 2 m. square, connected on the north with the wide mountain range which runs N. and S. through Palestine, and which forms the watershed of the country, so that streams within a mile of the city walls flow on the one hand to the Mediterranean and on the other to the Dead sea. Between the plateau and the mountain ridge on the north is a low depression through which small streams flow during the rainy season. On the other sides the hills rise abruptly higher than the plateau on which the city stands. The limestone of this plateau is much harder than that of the surrounding hills, and is capable of receiving a high polish. The color is a pale yellow, with red or pink veins. W. of the city at Gihon, and on the N. side, about 1½ m. from each other, are two gentle depressions, one running S. E. and then E., the other E. and then S., gradually becoming deeper till they form two narrow ravines with precipitous sides. These are the valley of Hinnom and the valley of Jehoshaphat (or of the Kedron), which almost skirt the city in their course, and unite in the S. E. part, a little S. of the pool of Siloam and near the well En-rogel. A third ravine, the Tyropoeon, begins in the city, and running S. joins the other two at this point. The gorge continues its course S. E. till it is lost in the basin of the Dead sea. On the east the triple-peaked mount of Olives rises abruptly from the valley of Jehoshaphat. On the south the hill of Evil Counsel overhangs the valley of Hinnom, which separates it from Zion. On the side of the hill of Evil Counsel a chain of rocks rises precipitously from the valley to a height of 30 or 40 ft. and on the ridge is the small field called Aeldama (field of blood), or potter's field. Further N. W., up the valley where it blends with Gihon, is the lower pool of Gihon, formed by a strong wall built across the lower end; it is called by the Arabs *birket es-Sultan*, pool of the sultan. The wall being now broken, it is used by the Arabs as a threshing floor. The course of this valley N. and then N. W. leads up to the plateau on which the city stands. On this spot, about ¼ m. from the city walls, is the upper pool of Gihon, a basin about 300 ft. long, 200 ft. broad, and 30 ft. deep. The water that accumulates in this pool, after settling, is conducted into the pool of Hezekiah, within the city, where it is used for bathing. On the sides of the pool of Gihon is the Turkish cemetery, which, as in other eastern cities, is unfenced, and presents a desolate appearance. Immediately W. of this pool is the hill Gareb; the valley (Wady Haninah) beyond declines toward the Mediterranean. E. of this place, and next to the city, is a magnificent establishment built a few years ago by the Palestine commission of St. Petersburg, under the auspices of the emperor of Russia. It consists of the fine church of the Holy Trinity, two large hospices for male and female pilgrims respectively, a house for the missionaries and travellers of the higher classes, a hospital, and

i residence for the Russian consul. Near by is another large building for the Prussian deaconesses' schools. The country around Jerusalem is rocky and not very fertile. The rocks almost everywhere crop out at the surface, which in many parts is also thickly strewn with large stones, and the whole region has a dreary and barren aspect. At almost every siege the trees were either burned or cut down, and the vege-

It began N. W. of the tower Hippicus, extended to the Xystus, and terminated on the W. side of the temple, thus separating the upper from the lower city. The other part of the wall, toward the west, commencing also from Hippicus, passed by a place called Bethso to the gate of the Essenes; thence it turned S. and E., taking in all the south of Zion till above the pool of Siloam; it then turned N. E., by the slope Ophel, and joined the E. cloister of the temple. The second wall began at the gate of Gennath, in the first wall E. of the tower Hippicus. Advancing thence toward the N. gate of the city, it turned S. E., and terminated at the fort of Antonia, which flanked the N. W. angle of the temple. The third wall began at the tower Hippicus, extended N. W. as far as the tower Psephinus, then turning E. passed by the tomb of Helena on the north for some distance, and finally turned S., joining the old wall E. of the temple. The present walls were built by the Turkish sultan Solyman the Magnificent in 1536-'9. They are 15 ft. thick at the base, and vary in height with the inequalities of the ground from 25 to 70 ft. Their total circuit is about 2½ m.—The city is irregular in its outline, but approaches a square whose four sides, each about ¼ m. long, nearly face the cardinal points. It has at present five gates that are open, two on the south, and one near the centre of each of the other sides. On the west



Plan of Modern Jerusalem.

tation destroyed. The soil thus exposed was gradually washed down into the valleys and thence to the plains, which to this day are remarkably fertile. Yet olives and vines thrive on the sides of these mountains, and fields of grain are seen in the valleys and level places.—The various parts of ancient Jerusalem were at different intervals surrounded by walls. The first old wall encircled Zion and a part of Moriah.

is the Jaffa gate (or *bab el-Khalil*, Hebron gate), the chief entrance to the city; on the north the Damascus gate (*bab el-Amud*, the gate of the columns); on the east St. Stephen's gate, called by the native Christians gate of our Lady Mary, and by the Mohammedans *bab el-Asbat*, gate of the tribes; on the south Zion gate (*bab en-nabi Daud*, gate of the prophet David), and another obscure portal, the Dung gate (*bab el-Magharibeh*, gate of the Moors),



near the centre of the Tyropæon. The Golden gate, on the E. side, is now walled up with solid masonry, and against it a tower has been erected, where a Mohammedan soldier is constantly on guard; for the Turks have a tradition that the Christians will some day enter by this gate and possess the city. Among the ancient gates mentioned in Scripture were the gates of Ephraim and Joshua, the horse, sheep, and fish gates (probably with adjoining market places for the sale of horses, &c.), and the old, fountain, and water gates. The streets are narrow, winding, dirty, and badly paved; the principal and broadest street is about 15 ft. wide, and some are only 5 or 6 ft. The houses are built of heavy masonry, with thick walls supporting arched roofs. They have neither symmetry nor elegance, but the rooms are generally lofty and well ventilated. The houses are usually two or three stories high, with a plain front, few or no windows in the lower stories, and doors so low that a person must stoop in entering. The roofs are terraced or rise in domes, and the apartments receive light from interior courts, which in the larger houses form cool and agreeable promenades, and sometimes are turned into gardens, where the household spend their leisure time. The principal apartments are in the upper story, the lower being

occupied by lumber rooms, kitchens, stables, cisterns, and offices. Some of the houses are three or four centuries old.—The city, as seen from the mount of Olives, above the ancient Gethsemane, appears to be a regular inclined plane, sloping gently and uniformly from W. to E., or toward the observer, and indented by a slight depression or vale running N. and S., the Tyropæon, which was formerly a deep ravine, but was filled up by Simon Maccabæus when he razed Acra. The elevation W. of the Tyropæon is Zion, E. Moriah and Ophel, N. Acra, and N. E. Bezetha. The S. E. corner is occupied by the great mosque and its extensive and beautiful grounds on Mt. Moriah, comprising about one seventh of the modern city. This enclosure corresponds, in part at least, with the ancient temple area. The site was purchased by David,

having been the threshing floor of Araunah, an altar was built, and materials were collected for the temple. The building was erected by Solomon about 1012–1005 B. C., its general plan being taken from the ancient tabernacle, while the dimensions were exactly doubled. It was 120 ft. long and 60 ft. wide, and consisted of three parts, the porch, the holy place, and the holy of holies, surrounded on all sides but the front by small chambers arranged in three stories, for the priests. The porch probably rose in a lofty second story, and its ceiling was supported by two highly ornamented pillars of brass. The temple stood within courts and cloisters of great beauty, and was connected by stone bridges spanning the Tyropæon valley with the royal palace and the city on Mt. Zion. It was destroyed by Nebuchadnezzar in 586 B. C., and was rebuilt by Zerub-



The Great Mosque (Kubbet es-Sakhra).

babel about 520, but of its restored character we have little information. The temple of Zerubbabel was standing however in the time of Herod, and the restoration by that king was in two parts: the temple proper, which the priests rebuilt in 18 months, not trusting the work to profane hands, and perhaps only repairing the ancient building; and the courts and porches or cloisters, which Herod greatly enlarged, spending eight years in fitting them for use, while the work of completion continued nearly 50 years. The façade of the temple consisted of a lofty arch spanning the entrance. The temple was surrounded by a court about 360 ft. long and 270 ft. wide, adorned by porticoes and ten magnificent gates, one of them probably the "gate called Beautiful;" while beyond this was an enclosure about 600 ft. square, bounded by por-

pieces surpassing in size those of any other ancient temple. The whole structure was of white marble, the roofs lavishly adorned with gold, and the high and massive walls of the enclosure made it the stronghold of the Jews during the siege by Titus. The hill is now covered with greensward, and planted sparingly with olives, cypresses, and other trees, and is the most beautiful feature in the city. About the middle of this enclosure is a large and nearly rectangular platform, about 10 ft. high, 500 ft. long, and from 460 to 500 ft. in width. On this platform stands the grand mosque, *Kubbet es-Sakhra*, "Dome of the Rock." The building is an octagon, each side of which measures 67 ft. It is surmounted by a light and graceful dome, terminated by a tall crescent. Its exterior walls are covered with tiles of white, blue, and yellow glazed porcelain, with intricate arabesque patterns and inscriptions. The lower parts of the walls are further decorated with slabs of marble, few corresponding to each other; they are said to have been taken from the ruins. Four doors, facing the cardinal points, lead to the interior, which is about 150 ft. in diameter. A corridor 13 ft. wide runs round, having on its inner side 8 piers and 16 marble and granite Corinthian columns; the columns do not appear to occupy their proper places, and the Arabs say that they were lying about among the ruins when the mosque was built. Within these is another corridor 30 ft. wide, with 12 larger columns and 4 great piers, which together support the dome. Under this dome is the rock, which varies in height from one foot to five feet from the surface. Under the rock is a cave, partly excavated, which is entered on the southeast by a flight of stairs. Here are pointed out the altars of Solomon, David, Abraham, and St. George. In the centre of this chamber is a circular slab of marble, which on being stamped upon gives a hollow sound; the Mohammedans call this the "well of souls," and believe that the souls of believers descend there after death. The legend is that Mohammed, in his midnight visit to heaven, first alighted on this rock, from which he continued his journey, whereupon the rock raised itself to follow, but was prevented by the angel Gabriel; it therefore remained suspended in the air. About 450 ft. S. from the Sakhra, in the S. W. part of the enclosure, is the mosque Akxa (end or extremity, used figuratively, as *akasi el-ard*, "the ends of the earth"). Its form is that of a basilica of seven aisles; it is 272 ft. long by 184 ft. wide; in front there is a porch 20 ft. wide. The piers and columns in the interior are inferior to those in the Sakhra. At the S. end is a Saracenic dome similar to the Kubbet es-Sakhra, but much smaller. To the left, on the east, a door leads into a smaller mosque, said to have been the only one built by Omar. In front of the Akxa is a large basin with a fountain in the middle. The water that issued here was conducted from the

pools of Solomon, 6 m. S. of the city; but the aqueduct has lately been broken by the Arabs, who supply the city with water from the well En-rogel, near the junction of the valleys of Jehoshaphat and Hinnom. The building of the two mosques, the Sakhra and Akxa, is ascribed to Abdelmalek in 686; but some writers say that the emperor Justinian built the Akxa, then the church of St. Mary. Between this place and the E. wall are extensive subterranean cellars, called the stables of Solomon, nearly 200 ft. long and 100 ft. wide, supported by columns about 25 ft. high. In the centre of the E. wall is the Porta Aurea, a double gateway (*bab ed-Dahariyeh*, the Eternal gate), a magnificent portal with finely sculptured arches, which have been sadly defaced by travellers since the mosque was opened to Christians. When the crusaders held the city, a procession of Christians bearing palms entered by this gate on every Palm Sunday. The whole enclosure, including the mosques, is called Haram esh-Sherif. In this enclosure are immense tanks, calculated to hold nearly 8,000,000 gallons of water, which, together with the supply from the Virgin's fountain and the cisterns in the houses, would last during a protracted siege. The actual spot where the temple stood has not yet been ascertained. The Porte, although it has granted the English engineers permission to excavate around the city and in parts of it where no injury will be done to the dwellings, has not been able to overcome the superstition and fanaticism of the natives so far as to allow them to dig within the precincts of the Haram. On the S. W. side of the Haram a portion of the temple wall is still standing, known as the Jewish wailing place; in this wall are five courses of large bevelled stones in a very good state of preservation. Here the Jews assemble every Friday to lament the woes of their country. The pool of Bethesda (now *Birket Israil*), N. of the Haram, near St. Stephen's gate, is a reservoir about 360 ft. long, 130 ft. broad, and 75 ft. deep.—The church of the Holy Sepulchre is situated almost in the heart of the N. part of the city, where the empress Helena is said to have discovered the true cross. (See Cross, vol. v., p. 513.) Concerning the authenticity of the sacred places a great deal of controversy has existed and is still kept up. Dr. Robinson, in his "Biblical Researches," arrives at the conclusion "that the genuineness of the present site of the holy sepulchre is supported neither by well authenticated historical facts, nor by prior tradition, nor by archeological features." His main argument to this effect attempts to show by the topography of Jerusalem that the present locality of the sepulchre was within the walls of the city at the time of the crucifixion, and consequently could not be near the place where Christ was crucified, which is stated in the Gospel to have been without the gates. Most Protestant and a few Catholic investigators agree substantially with Dr. Robinson; while

on the other hand the great majority of Catholics and some Protestant travellers believe in the genuineness of these remains. Among others, Mr. William O. Prime maintains the authenticity of the sepulchre on the following grounds: "It is not credible that this locality was forgotten by Christians within 800 years after the great events of the crucifixion, burial, and resurrection. Critical scholars and learned men, employed in investigating the topography of the Holy Land, had no doubt of its authenticity in the beginning of the 4th century; no one, so far as we know, thought in that age of disputing the fact, but all men acknowledged its truth; it is not doubted by any one that this is the locality in which those learned men placed their confidence, it having been well preserved from that time to this." The main entrance to the church is on the south. After descending a broad flight of rude steps, a large open paved court is reached, along

near the entrance, is called the stone of unction, and is said to cover that upon which Joseph laid the body of Christ to be anointed for burial. On the east of the stone is a chamber, the roof of which forms the floor of the chapel of Golgotha; this chamber has on the right and left the tombs of Godfrey and Baldwin, between which the visitor passes to the chapel of Adam, ending against the native rock, in which a huge fissure is visible, said to have been made by the earthquake at the time of the crucifixion. This rock, ascending through the roof, is pointed out as Calvary, where Jesus was crucified. Ascending a flight of stairs outside of the chapel of Adam and the chamber of Godfrey and Baldwin, the low vaulted chapel of Golgotha is entered. At the E. end is a platform about 10 ft. long by 7 ft. broad, and 20 in. high. In the centre is an altar, under which is a hole in the marble slab on the floor, said to be the place where the Saviour's cross

was fixed, and on the right and left are shown the holes where the crosses of the thieves were placed. In the platform is another opening in the marble pavement, through which is seen a rent in the rock continuous with the one below in the chapel of Adam. On the right hand, S. of the platform, is another division called the chapel of the crucifixion, said to have been the place where Christ was nailed to the cross. This part does not stand on the rock, but forms a kind of upper story, which is accounted for by saying that Helena removed



Church of the Holy Sepulchre.

whose sides are the bases of a row of columns, which probably once supported cloisters. Recent excavations have shown that under this court is a crypt with arches of high antiquity. On the left is the convent and chapel of St. James; and on the opposite side is the convent of Abraham or Isaac, in the place, the Greeks say, where Abraham was going to sacrifice his son. The façade of the church occupies nearly the whole of the N. side of the court. The lower story has a wide double gateway, with marble and granite columns supporting richly sculptured architraves, on which is represented Christ's triumphant entry into Jerusalem; over these are finely carved arches. The eastern section has been closed for several centuries; it is said to have been walled up by the Moslems to limit the Christians to one entrance, where the fees could be collected by one person. A large polished slab of stone on the floor of the church,

the ground beneath it and took it to Rome, so that the chapel is still on the real site. Through a barred window in this division another chapel is seen, the entrance to which is by a flight of steps outside of the church. Here the Virgin Mary and the other women stood watching the crucifixion. Returning down stairs from the chapel of Golgotha, and passing by the stone of unction, we enter the rotunda, about 70 ft. in diameter, surrounded by 18 massive piers which support the Armenian church on one hand and the Latin galleries on the other; the whole surmounted by a large dome with an opening at the top. This dome was a few years ago in a ruinous condition, but in 1669-70 it was repaired at the joint expense of the French, Russian, and Turkish governments. This combined action was a compromise reached after long negotiations, in which the two Christian powers strenuously contended for the privilege of doing the work, as protectors re-

spectively of the Latin and Greek churches in Palestine, in order to establish a claim to exclusive possession. Claims thus originating in the large churches of Jerusalem, partitioned among different sects, have sometimes resulted in fierce quarrels, lawsuits, and even fights, requiring the interference of the Turkish soldiery. The space behind the piers was formerly open; now it is partitioned off and divided among the various sects. In the centre of the rotunda is the holy sepulchre. Above it is a chapel 26 ft. long and 18 ft. broad, built of polished native limestone, and surmounted with a small dome. The façade is ornamented with several twisted marble and limestone columns, and numerous silver and brass lamps, pictures, &c. On each side of this chapel is a small circular aperture, through which the holy fire is dealt out to the pilgrims by the Greek patriarch within. The chapel is divided into two compartments. The front chamber is the "chapel of the angel," where the angel is supposed to have sat on the stone which he rolled away from the door of the sepulchre; in the centre of the apartment, on a pedestal, is a fragment of the stone; the other part is said to have been placed by the Armenians in the convent of Caiaphas, just outside of the Zion gate. In the second chamber, which is entered by a low narrow doorway, is the tomb of Christ, occupying the whole length and nearly half the width of the apartment. It is raised about two feet from the floor, and covered with a single slab of marble, whose edges have been worn off by the kisses and embraces of the pilgrims who for centuries have gathered here from all parts of the world. Facing the chapel over the sepulchre is the Greek section of the church. It is the nave of the edifice, but is now divided from the aisles by high walls, said to have been built by the Greeks after the crusaders were expelled by Saladin. This church is quadrangular, about 70 ft. by 40. At the E. end is the high altar, reached by four steps, and divided by a richly gilt screen. On the right hand is the Greek patriarch's throne. In the centre a small column indicates the middle of the earth, and Adam's skull is said to be buried beneath. There are two other side doors, N. and S., opening into the aisles. Returning by the main entrance on the west, facing the sepulchre, the visitor turns to the right, passing between the piers of the rotunda, and arrives at a circular marble pavement, where Mary, according to the tradition, stood when she first saw Christ after his resurrection. On the north, ascending a few steps, is the Catholic section of the church. In this place is pointed out the pillar to which Christ was bound when scourged; the pillar itself is hidden from view by the building, but a stick with a silver head is thrust through an iron grating in the wall; the silver head, having touched the pillar, is drawn out and kissed. In the vestry of this chapel the sword of Godfrey is exhibited. Returning and following

the course of the aisles behind the Greek section, the visitor, after passing one or two stations connected with different events in the passion of Christ, arrives at a long flight of stairs leading to Helena's church, a massive and rudely constructed edifice, crowned by a dome with windows to admit the light. Here Helena sat while search was made for the cross. At the further end another flight of stairs leads down to the cave where the cross, the crown of thorns, and the nails were discovered. It is an irregular excavation in the rock; at one end an altar marks the spot where the true cross lay. Ascending again, and continuing his course, the pilgrim arrives at last at the principal gate to the church, near the stairs leading to Golgotha, from which he first started. About 35 yards beyond the E. door of the church of the Sepulchre are the ruins of the hospital of the knights of St. John; the entrance is by a picturesque Gothic gateway, the façade of which was richly carved with historical and symbolical sculptures, now nearly defaced by curious tourists. Beyond the gateway is an open court, part of which was once the church; at the E. end is the altar. A stairway on the south leads to a corridor surrounding a quadrangular court. The building itself is very spacious, but the chambers and halls have for ages been filled with rubbish, and several are in ruins. In 1869, on the occasion of the visit of the crown prince of Prussia, the Turkish sultan presented him with these ruins; and the Prussians are now clearing them out, and intend to restore the church and other parts of the building.—On the west of Jerusalem, at the Jaffa gate, is the citadel, consisting of three high square towers, separated from the city by a low wall and from the suburbs by a deep and wide moat. The largest and highest is called the tower of David. The lower part, rising in a solid mass, is undoubtedly ancient, and is probably the remnant of the tower Hippicus, built by Herod, and named from his friend who had fallen in the Parthian wars. The upper part, like the other towers, is of more modern construction. The battlements afford a view of the whole city, the mount of Olives, the Dead sea, and the mountains of Moab beyond. To the northeast lies the pool of Hezekiah; to the south lie the gardens of the Armenian convent, in which are the ruins of the pool of Bathsheba; and to the west the Jewish almshouses, built by Sir Moses Montefiore as executor of his American coreligionist Judah Touro, who bequeathed a large sum of money for that purpose. The tomb of David, now outside of the walls, S. of the Zion gate, was formerly within the city; the place is kept by the Mohammedans, who have a mosque over the spot. In the large hall, the *cenaculum*, is a stairway leading to the cave which is said to contain the tombs of David and his successors; but no one is allowed to enter. Over the cave is a small room with a raised structure about 3 ft. high, representing a Moslem

tomb, covered with green cloth; this is pointed out as the spot under which the body of David lies. At the foot of the mount of Olives, a short distance N. of the garden of Gethsemane, is the traditional tomb of the Virgin Mary, first mentioned in the 8th century. It fronts upon a sunken court reached by a short flight of steps. Within the door 60 steps descend into the chapel, which seems excavated in the rock, and contains the tombs of Joseph and the parents of the Virgin, as well as the empty tomb of the Virgin herself. About 100 paces from it is the traditional place of the assumption. In the city walls, a few yards E. of the Damascus gate, is an opening to an extensive cavern extending to a considerable distance under the city, and known as the royal quarries. Descending S., by a sloping hill formed of accumulated débris, the traveller arrives at the edge of a large pit, into which there is a passage in another part of the cave. To the left, through some windings, is an immense hall excavated out of the rock. Several blocks, nearly detached from the rock, may be seen,



Tomb of the Virgin Mary.

and the marks of the tools in the stone are plainly distinguishable.—Modern exploration of Jerusalem begins with the visit of Dr. Edward Robinson in 1838, which was followed by his second journey in 1852. Dean Stanley, in his "Sinai and Palestine" (London, 1855), suggested the necessity of excavations in and about the city for the acquirement of certain knowledge of sacred localities; but little was done till 1864, when Miss Burdett-Coutts, for the purpose of securing a better water supply for the inhabitants, gave £500 to pay the expenses of a topographical survey of the city, and Capt. Wilson of the British army was detailed to conduct it. This led to the formation of the English society entitled "The Palestine Exploration Fund," which sent out in 1867 a party under the command of Capt. Warren, R. E., who remained in Palestine three years, chiefly occupied in and around Jerusalem, where several important discoveries have been

made. On the S. E. side of the city, where the wall rises to a height of about 55 ft. from the surface, a shaft was sunk and the foundation discovered at a depth of 73 ft., making a total height of nearly 130 ft. The masonry of the lower part must have belonged to the original wall, the bevelled stones giving indications of Phœnician workmanship. On the immense blocks that form the base of the wall several marks in red paint were discovered, resembling Phœnician characters, though no one could explain their meaning; it is supposed that they were made by Solomon's workmen. The wall extended further S. than the present one; it ran S. by Ophel, and encompassed Zion. At the foot of Mt. Moriah, in the valley of Jehoshaphat, is the Virgin's fountain, an intermittent spring; the water flows out at the rear of the cave through an aqueduct excavated in the mountain into the pool of Siloam. Above this place, on Ophel, the engineers sunk another shaft, and discovered a Roman archway leading to a small cave, at one end of which was a pit subsequently found to be connected with the subterranean aqueduct between the Virgin's fountain and the pool of Siloam. This important discovery goes far to explain how the city endured such protracted sieges. A little S. of the Jewish walling place three large stones, forming a segment of an arch, are seen projecting out of the wall. Dr. Robinson was the first to identify it as part of the bridge that was built across the Tyropœon. Capt. Warren discovered the remains of the pier that supported the other end of the arch, about 40 ft. beneath the surface, 50 ft. from the wall. The distance from the wall to the steep sides of Zoc is 350 ft., and it is calculated that five such arches formed the bridge. Further N. he found the ruins of another similar bridge. About half a mile S. of the well of Rogel is a place called by the Arabs the Almond spring, where in winter the water flowed out; it was supposed to be an outlet to the well of Rogel, through which the superfluous water escaped. The engineers dug here, and discovered a passage hewn in the rock, but choked with earth and stones, which they cleared out; it first led N. for several hundred feet, then took a N. W. direction, leaving Rogel on the right, and at last terminated in a small rock-hewn chamber, further than which no passage could be discovered. The party also excavated another remarkable rock-hewn passage, leading S. toward the temple from the convent of the sisters of Zion. Mr. Schick, who discovered the well of Gibon, traced the aqueduct from the convent to the N. part of the city, where it is partially destroyed by the formation of the ditch and the royal quarries.—The chief executive and judicial officers of Jerusalem are Mohammedans. Christians hold subordinate offices, and since the massacre of the Christians in the Lebanon, Damascus, Sidon, &c., in 1860, they have gradually been appointed to places of trust. The United States, Rus-

nd, France, Germany, Austria, Spain, e have each a consul resident here. liction of the pasha of Jerusalem ex- thward to within 15 m. of Nablus, l to Gaza and the confines of Egypt, ard to the Jordan. He is appointed by but receives his instructions through or general of Syria, except in cases atch is necessary. His principal offi- he vice governors of the towns under ction are appointed by the governor ut are subject to his orders, and deci- e courts in criminal cases are sent to at Damascus for confirmation. Most s now there are of German or Polish d speak a corrupt German dialect. called Ashkenazim, to distinguish n the Sephardim, consisting of Jews h and Portuguese origin, whose an- ere expelled from Spain and Portu- d the close of the 15th century, and k a corrupt Spanish dialect, and of nd other oriental Jews. Between bodies little intercourse exists; they termarry, and they pray in different s. The Jewish community inhabit ar portion of the city; but of late consequence of increasing numbers, extended their quarter far into the dan part, and many live in the sub- re Jews' quarter proper is badly built ; and the people suffer much from llwellings, scarcity of water, and ex- erty. Their chief rabbi is elected and is recognized by the Sublime his capacity. He is entitled to send e to act as a member of each local nits to which Jews who are Turkish re parties. The Spanish-Portuguese g subjects of the Porte, the right of vas vested in them, and the chief ays was one of the Sephardim. To shkenazim objected; but being un- rry their point, they elected one of number as their chief rabbi. Though nized by the Porte, he has great in- er the foreign Jews. The Jews, in s among themselves, are governed by inical laws, preferring to abide by ns of their rabbis rather than carry s before gentile courts. The Greek s are Arabs, Greeks, and Syrians, c only the Arabic language, except or clergy, who are natives of Greece rchipelago. They have eight con- the city. The Greek patriarch has ver and influence than any of the itual chiefs in the city, and his church althiest. He is officially recognized rkish government as the chief of the rch in Syria, and is entitled to send tives to act as members in the local nder him are two classes of priests re ordinary monks. They are the rgy, who do not aspire to the higher the church, and the unmarried. The

latter live together in the grand convent, or are appointed abbots and assistants to the other monasteries under the surveillance of the patriarch. The Latin Christians, or Roman Catholics, who are principally seceders from the Greek church, also speak Arabic. They have a patriarch, who exercises spiritual oversight over all the Catholic churches in Syria, but is recognized by the Turkish government only as a distinguished personage, and does not enjoy equal privileges with the Greek, Jewish, and Armenian spiritual heads, partly in consequence of his being a foreign subject. The right of sending representatives of the Roman Catholic community is vested in the abbot of all the Catholic convents in the country, who is always an Italian, his vicar a Frenchman, and the treasurer a Spaniard. He is appointed by the pope every three years. The Catholics at Jerusalem have one large convent, that of the Holy Saviour, and two nunneries, that of the order of St. Joseph or sisters of charity, and that of the daughters of Zion. No males are admitted into the latter, except monks and priests. There are 14 other convents in Syria, subject to the abbot of this principal one. The Armenians number about 200; they have one large convent, that of St. James, in the most elevated part of the city, and a patriarch, who is recognized in that capacity by the Turkish government, and who enjoys equal privileges with the Greek patriarch and Jewish chief rabbi. The Protestant population numbers about 200. An Anglican bishop resides here, with a diocese including Palestine, Syria, Mesopotamia, Egypt, and Abyssinia. This bishopric was established in 1841 by the joint action of the Prussian and British governments, and its incumbent is chosen alternately by the sovereigns of England and Prussia. Besides exercising supervision over a few schools, and occasionally officiating in the Protestant church, the duties of the bishop are almost nominal, as the work of preaching and conducting the Protestant institutions is managed by the missionaries. The Copts, Abyssinians, and Syrians have convents in the city, and altogether amount to about 100 persons. The non-Protestant Christians at Jerusalem are in a measure dependent on their convents, which allow them house rent and other gratuities. As nearly every community carries on a work of proselyting, it frequently happens that these Christians embrace each denomination in turn, as the chances favor. In 1867 the pasha commenced building a carriage road between Jerusalem and Jaffa, the money for the purpose being raised by taxation. For want of proper engineers and energy in the commissioners, it was imperfectly completed in about 18 months, and stage coaches carried passengers between Jerusalem and Jaffa. The work was about to be extended when a new governor was appointed, and it was discontinued. The inhabitants of Jerusalem get their support mainly from the pil-

grims and travellers who visit the city. Beads, crosses, and ornaments are largely manufactured and sold to strangers. Quantities of olive and sesame oil and soap are also produced here, and much is exported to Egypt and to ports on the Mediterranean; grain and other articles are also exported. Almost all manufactured articles, as cloths, sugars, candles, &c., are imported from France, England, and Germany. Petroleum has for several years been in great demand in the markets of Palestine, and has now almost superseded olive and sesame oil for lighting, these being used only for food and manufacturing soap.—The primitive name of Jerusalem appears to have been Jebus, or poetically Salem, and its king in the time of Abraham was Melchizedek. When Abraham returned from the slaughter of the kings who had made his nephew Lot prisoner, the king of Sodom met him in the valley of Shaveh, or the king's dale, now probably the valley of Jehoshaphat; and there Melchizedek brought bread and wine. At the conquest of Canaan by the Hebrews, the tribe of Judah took the city and set it on fire; but the fortress probably still remained in the hands of the Jebusites for 400 years longer. Its situation among the mountains almost in the heart of his kingdom naturally excited in David a desire to possess it. In the ninth year of his reign (about 1046 B. C.) he stormed the fortress of the Jebusites, Zion, called it the city of David, and made the place the capital of his kingdom. From that time it has been called Jerusalem. Under Solomon the temple was built on Mt. Moriah, and several palaces were erected. David's many conquests, his vast accumulation of treasures for the temple, the magnificent structure itself, and afterward Solomon's reputed wisdom and immense wealth, all tended to spread the fame of the city, and during his reign it attained its highest degree of power. At the accession of his son Rehoboam ten of the tribes seceded under Jeroboam and made Shechem, and subsequently Samaria, the capital of their kingdom of Israel. Jerusalem then lost much of its importance, remaining only the capital of the smaller, though more powerful, kingdom of Judah. About 971 B. C. Shishak, king of Egypt, took the city and plundered the temple and palace of their treasures. It was again conquered and sacked by Joash, king of Israel, and was afterward beautified by Uzziah, Jotham, Hezekiah, and Manasseh. In the time of Ahaz the king of Syria attacked Jerusalem, and carried many of the Jews captive to Damascus, though he could not take the city. Under Hezekiah it was besieged by Rabshakeh, the general of Sennacherib, king of Assyria, but it was saved by the sudden destruction which overtook the Assyrian army. Manasseh's being carried captive to Babylon seems to intimate that the city was taken by the Chaldeans about 650, although the fact is not expressly stated in the Bible. After the death of Josiah at the battle of Megiddo, Jerusalem was tributary to

Pharaoh Necho, king of Egypt, for two or three years, when it passed into the hands of the Babylonians, who, after repeated revolts and sieges, finally reduced it in 586. (See HAZZERA.) On this occasion Nebuchadnezzar demolished the walls and all the principal houses in the city, plundered and destroyed the temple, and carried away to Babylon all except the poorest citizens. For the next 50 years Jerusalem remained in ruins, till the return of the Jews during the reign of Cyrus, the conqueror of Babylon (538). This monarch issued a proclamation allowing the return of the Jewish captives to Jerusalem and authorizing them to rebuild the temple, and enjoined every one to contribute to and assist in this work. A part of the captives returned under Zerubbabel, and rebuilt the altar and laid the foundation of the second temple. But they were interrupted by the intrigues of their enemies, who unceasingly wrote insinuating letters to the capital of the empire, and at last succeeded in stopping them. The work was renewed under Ezra, who obtained a commission from Artaxerxes (Longimanus). In the 20th year of his reign (458), the king commissioned Nehemiah to rebuild the city itself. This he effectually carried out in spite of the opposition of his enemies, being himself appointed civil governor of Judea, and having the direct patronage of the king, whose co-bearer he was. Nehemiah rebuilt the walls on the ruins of the old city. From this period till the Macedonian invasion in 332 Jerusalem enjoyed comparative peace. Yielding to Alexander without resistance, it escaped the fate of Tyre and Gaza. After the death of that conqueror and the division of his empire among his generals, Judea and its capital, lying between the rival kingdoms of Egypt and Syria, were alternately seized by the sovereigns of these two countries. Under the Ptolemies Jerusalem flourished both as a commercial city and a shrine. It was well adapted for trade, and abounded in artificers of various crafts. Its markets were well supplied by the Arabs with spices, gold, and precious stones. Goods were also imported across the sea, for there were good harbors at Gaza, Joppa, and Ptolemais (Acre). It passed into the power of Syria with the rest of Judea, in 198, and was mildly ruled by Antiochus the Great; but the tyranny of his son, Antiochus Epiphanes, inflicted on it repeated massacres, and finally brought about the victorious revolt under the Asmoneans. Judas Maccabeus wrested Jerusalem from his enemies, and repaired the temple (165), though he was unable to expel the garrison that had been left in the fortress of Acre W. of Moriah, which commanded the temple, and from which the Syrians made annoying sallies. Against it he fortified Mt. Zion. This, however, shortly after surrendered to Antiochus V., who, breaking the capitulation, demolished the fort. Jonathan, the brother and successor of Judas, rebuilt it, but equally failed in an attack on Acre. His brother Simon reduced Acre, de-

molished the citadel, and levelled the hill. In 63 Jerusalem was captured by Pompey, who intervened between the brothers Aristobulus and Hyrcanus, the walls were demolished, and thousands of the inhabitants were slain. He also entered the temple, but did not touch any of the treasures. It was plundered by Crassus, on his way to Parthia, in 54. The walls were rebuilt by Antipater, who was appointed procurator of Judea by the Romans. In 40 the Parthians, allies of Antigonus, son of Aristobulus, sacked the city. Herod, having been appointed king by the Roman senate, besieged Jerusalem, and took it in 37, and the massacre on this occasion was as bloody as that by Pompey. Herod erected or enlarged and beautified the fortress of Antonia; he also improved and enlarged the city, and restored the temple on a more magnificent scale than Solomon's. Jerusalem appears now to have reached the zenith of its greatness, though not of its power, which it never recovered after the death of Solomon. It is conjectured that the city at this time contained at least 200,000 inhabitants in its lofty and closely compacted dwellings. This period is marked by the most memorable events in its history, the ministry and crucifixion of Christ. About A. D. 66 the Jews, goaded to despair by the tyranny of the Romans, revolted, took possession of Jerusalem, and defeated a Roman army commanded by Cestius Gallus, governor of Syria. This was the beginning of the disastrous war which ended in the complete destruction of Jerusalem. In 70 Titus, after a long and vigorous siege, took the city, and his soldiery, maddened by the obstinate resistance of the defenders and their own repeated fruitless attempts and great losses, spared neither age nor sex. Thousands of Jews, seeing all hope lost, threw themselves headlong from the towers, turned their swords against their own breasts, rushed into the flames, or fell fighting the enemy. Titus himself was unable to control the rage of his troops, and with regret saw the temple destroyed by the flames and the principal towers demolished, which he had intended to preserve as memorials of his own victories. According to Josephus, 1,100,000 Jews perished in this siege, and 97,000 were carried into captivity; and Tacitus says that the number besieged in the city, including both sexes and every age, amounted to 600,000; but a critical examination easily proves both statements to be greatly exaggerated. The walls were levelled, the dwellings demolished, the temple was burned, and Mt. Moriah literally ploughed over. Sixty years afterward Hadrian resolved to rebuild the city and colonize it with Romans. But a revolt, headed by Bar-Cokheba, for a long time delayed the realization of his plans. For two or three years the insurgents held out in Jerusalem, but at last they were vanquished, and such edifices as remained or had been rebuilt were again demolished by the emperor's general, Severus. On the ruins Hadrian built

another city with luxurious palaces, a theatre, temples, and other public buildings. He called it *Ælia*, after his family name *Ælius*. On the site of the Jewish temple he raised another to Jupiter Capitolinus, from which the city took its surname of *Capitolina*. It is said that he erected a fane of *Venus* over the sepulchre of Christ, and Jews were forbidden to enter or come within a certain distance of the city on pain of death. Under the Christian emperors they were permitted to enter once a year, on payment of a large sum of money, to lament over their misfortunes. Under Constantine the city had already become the place of pilgrimage of the Christian world. It regained its ancient name, and the emperor furnished new attractions by the erection of a church over the place that had been pointed out as the sepulchre of Christ. The emperor Julian not only allowed the Jews to return to their city, but also made a futile attempt to rebuild the temple. About 530 Justinian followed the example of Constantine by building churches and hospitals in the city. In 614 Chosroes II. of Persia invaded the Roman empire. A division of his army marched into Palestine, and 26,000 Jews mustered under his banner, hoping to find in him a second Cyrus. After conquering the northern parts of Palestine, the united army of Persians and Jews laid siege to and captured Jerusalem. The Jews wreaked their vengeance on the Christians for all the persecutions they had suffered at their hands; 20,000 of them are said to have fallen, the church of the Holy Sepulchre was burned, and the part of the reputed cross of Christ which was deposited there was carried to Persia. It was recovered by the emperor Heraclius, and replaced in the church of the Holy Sepulchre with great pomp, and the law of Hadrian forbidding the Jews to enter the city was renewed. In 636 Jerusalem was besieged by Khaled and Abu Obeidah, the generals of the caliph Omar. The siege lasted four months, and scarcely a day passed without a sortie or an attack. The besiegers, notwithstanding the inclemency of the winter and the hardships against which they had to combat, displayed great courage and persistence. The patriarch Sophronius at length resolved to capitulate, but insisted upon treating with the caliph in person, hoping to gain from him better terms than he could from his generals. Omar came up to Jerusalem, and on taking possession of the city treated the inhabitants with great kindness and generosity. In the latter part of the 11th century Syria was invaded by the Seljuk Turks and converted into a province of their empire. The cruelties which the Christian pilgrims suffered at the hands of these people roused the indignation of all western Europe, and great numbers of the chivalry of France and England were led by Godfrey de Bouillon to recover the sepulchre from the infidels. Jerusalem was stormed and taken, July 15, 1099, and the crusaders, in their zeal to avenge the wrongs of the Christians, slew 70,-



000 Moslems. Godfrey was elected ruler of Jerusalem, and his brother and successor assumed the title of king. In 1187 Saladin, sultan of Egypt, marched against the city, summoned it to surrender, and promised the inhabitants rich lands in Syria; but his proposals were rejected with scorn. Upon this he swore to avenge the Moslem blood shed by the soldiers of Godfrey, and to demolish the towers. The Christians resisted bravely for 12 days, but at last were conquered. Saladin, however, did not carry out his threat of massacre, but contented himself with expelling the Christians from the city, granting them 40 days to remove their effects, and assisting many of the poor and helpless on their departure. Jerusalem again passed into the hands of the Franks by treaty in 1229, was retaken by the Moslems in 1239, once more restored in 1243, and finally conquered in 1244 by a horde of Kharesmian Turks, who had overrun Asia Minor. In 1517 Palestine was conquered by Sultan Selim I., and since then Jerusalem has been under the rule of the Ottoman empire. From 1832 to 1840 Palestine was in the hands of Mehemet Ali, pasha of Egypt, and Jerusalem was governed by his son Ibrahim Pasha. Previous to the Egyptian invasion Palestine was distracted with anarchy, and but nominally ruled by the Turks. When Ibrahim Pasha took possession of Jerusalem his first acts were to restore order in the city and country. He did his utmost to protect the Christians and Jews against the oppressions of the Moslems, and granted them many privileges. Safety was restored, the roads were cleared of robbers, and commerce revived. (See PALESTINE, and HEBREWS.)—See Robinson, "Biblical Researches" (3 vols. 8vo, Boston, 1841), and "Later Researches" (8vo, 1856); Bartlett, "Walks about Jerusalem" (8vo, London, 1845); Fergusson, "Ancient Topography of Jerusalem" (London, 1847), "Site of the Holy Sepulchre" (1861), and "The Holy Sepulchre and the Temple" (1865); Poujoulat, *Histoire de Jérusalem* (2 vols., 2d ed., Paris, 1848); Thrupp, "Ancient Jerusalem" (Cambridge, England, 1855); Barclay, "The City of the Great King" (Philadelphia, 1857); Tobler, *Planographie von Jerusalem* (Gotha, 1858); Lewin, "Jerusalem to the Siege by Titus" (London, 1861); Sepp, *Jerusalem und das heilige Land* (Schaffhausen, 1862); Sandie, "Horeb and Jerusalem" (Edinburgh, 1864); Pierotti, "Jerusalem Explored," translated from the French by T. G. Bonney (London, 1864); De Vogüé, *Le temple de Jérusalem* (fol., Paris, 1864-5); De Saulcy, *Voyage en Terre-Sainte* (2 vols. 8vo, Paris, 1865); Wilson, "Ordnance Survey of Jerusalem" (3 vols. fol., London, 1865-7); Wilson and Warren, "The Recovery of Jerusalem" (8vo, London, 1871; popular edition, "Our Work in Palestine," 1873); and Wolff, *Jerusalem, nach eigener Anschauung und den neuesten Forschungen geschildert* (3d ed., including his latest investigations,

Leipsic, 1872). See also the works referred to under PALESTINE.

**JERUSALEM**, *Johann Friedrich Wilhelm*, a German theologian, born in Osnabrück, Nov. 22, 1709, died Sept. 2, 1789. He was appointed in 1740 preacher to Duke Charles of Brunswick, and in 1742 became tutor of the hereditary prince. In 1752 he was placed in charge of a theological seminary established by the Protestants in the former convent of Ridagshausen. He declined the appointment of chancellor of the university of Göttingen. He was one of the best preachers of Germany. The suicide of his son Karl Wilhelm suggested to Goethe the catastrophe of the "Sorrows of Werther."

**JERUSALEM CHERRY**, a name given to two species of *solanum* which are cultivated for the ornamental character of their fruit. The oldest and best known of these is *S. pseudo-capsicum*, which was introduced into England from Madeira in 1596; it is a half shrubby house plant, and when properly treated has a hand-



Jerusalem Cherry.

some rounded head upon a stalk 1 or 2 ft. high; it has lance-oblong leaves and white flowers; the small and inconspicuous flowers are succeeded by bright red berries about the size of cherries, which are borne in great profusion and render the plant very ornamental. It is usually raised from seeds, but may be grown from cuttings; if the seeds are sown in early spring and the plants kept growing rapidly, they will produce fruit the following winter. It is supposed that the name Jerusalem was applied to this, as it formerly was to other plants, more to indicate its foreign origin than with reference to the country from which it came. The dwarf Jerusalem cherry is *S. capsicastrum*, which is only about half as tall as the other, and its berries are more orange than scarlet; there is a form of this with variegated leaves. In England these plants are raised in large quantities for Christmas and table dec-

orations. An improved sort called *S. hybridum-compactum*, very popular for table decoration, is depicted above.

**JERVAS, Charles**, a British painter, born in Ireland about 1676, died in London in 1739. He studied for a short time under Sir Godfrey Kneller, and in France and Italy, although deficient in the most essential principles of art, he acquired a fictitious reputation; and having given drawing lessons to Pope, the poet dedicated to him an epistle full of extravagant praise. Horace Walpole denounced his inferiority, but Jervas was so conceited that on comparing his copy of a Titian to the original he exclaimed, "Poor little Tit! how he would stare." Lord Orford says that "the badness of the age's taste and the dearth of good masters placed Jervas at the head of his profession."

**JERVIS, Sir John**, earl of St. Vincent, a British admiral, born at Meaford, Staffordshire, Jan. 9, 1734, died March 15, 1823. He entered the navy at the age of 10 years, and became post captain in 1760. He distinguished himself in several naval engagements, was made C. B. in 1782, and during the same year sailed with Lord Howe to the relief of Gibraltar. He was promoted to the rank of rear admiral in 1787, and was in parliament from 1782 until the beginning of the French revolution, after which he sailed to the West Indies and captured Martinique and Guadeloupe. He was appointed admiral of the blue, June 1, 1795, and on Feb. 14, 1797, off Cape St. Vincent, defeated a Spanish fleet which was nearly twice as strong as his own. For this he was raised to the peerage by the title of earl of St. Vincent and Baron Jervis of Meaford, receiving a pension of £3,000. He was first lord of the admiralty from 1801 to 1804.

**JESI**, or *Iesi* (anc. *Æsis* or *Æsium*), a town of Italy, in the province and 15 m. S. W. of the city of Ancona, on the N. bank of the river Esino (anc. *Æsis*); pop. about 20,000. It is an episcopal see, and one of the most important towns of the province, with manufactures of woollen and silk goods, and with increasing activity owing to the railway connection with Ancona. Under the Romans it was a *municipium*, and from ancient inscriptions appears to have been a colony. The emperor Frederick II. was born here.

**JESI, Samuele**, an Italian engraver, born in Milan about 1789, died in Florence, Jan. 17, 1853. He was a pupil of Longhi, and first brought himself into notice by his engraving of the Madonna with St. John and St. Stephen, from Fra Bartolommeo's picture in the cathedral at Lucca. Subsequently he devoted himself to the works of Raphael. His portraits of Leo X. and Cardinals Rossi and Giulio de' Medici, from the original in the Pitti palace, are much admired. The latter is said to have occupied him five years.

**JESSAMINE**. See JASMINE.

**JESSAMINE**, a central county of Kentucky, bounded S. by Kentucky river; area, 160 sq.

m.; pop. in 1870, 8,638, of whom 2,439 were colored. It has a somewhat diversified surface, with a soil of more than ordinary richness. The Kentucky Central railroad terminates at the county seat. The chief productions in 1870 were 79,562 bushels of wheat, 30,176 of rye, 409,505 of Indian corn, 58,740 of oats, 18,644 of potatoes, 14,175 lbs. of wool, and 78,915 of butter. There were 2,594 horses, 1,016 mules and asses, 1,548 milch cows, 3,889 other cattle, 3,488 sheep, and 10,150 swine; 3 manufactories of carriages, 1 of bagging, and 1 distillery. Capital, Nicholasville.

**JESSE, John Hennessy**, an English author, born about 1815, died in July, 1874. In 1839-'40 he published "Memoirs of the Court of England during the Reign of the Stuarts" (4 vols. 8vo), which he continued in his "Memoirs of the Court of London from the Revolution in 1688 to the Death of George III." (3 vols., 1843). He also published "George Selwyn and his Contemporaries" (4 vols., 1843); "Memoirs of the Pretenders and their Adherents" (2 vols., 1845); "Literary and Historical Memoirs of London" (1847), and a second series under the title "London and its Celebrities" (1850); "Richard III. and his Contemporaries" (1861), criticising the view commonly taken of the character of Richard; "Memoirs of the Life and Reign of George III., with Original Letters of the King and other Unpublished MSS." (1867); "London, its Celebrated Characters and Places" (3 vols., 1870); and several volumes of poems.

**JESSO**. See YZZO.

**JESSULMEER**, a town of British India, capital of a native state of the same name, the westernmost of Rajpootana, situated in a rocky district, 190 m. N. E. of Hyderabad on the Indus; pop. estimated at from 30,000 to 40,000, nearly all Hindoos, the ruling class being the Bhatti tribe of Rajpoots. It is one of the finest towns in that part of India, about 2 m. in circuit, with gates, ramparts, and bastions, and a lofty citadel enclosing six temples and other remarkable buildings, and the palace of the maha Rawul, the sovereign, which is surmounted by a huge metal umbrella. The dwellings are remarkably well built. The most conspicuous building has five stories of cut stone, and a sixth of timber, surmounted by five cupolas. Opium is used to excess. There is little trade, and the fortifications are decaying.

**JESUITS**, or *Society of Jesus* (Span. *Compañia de Jesus*), a religious order of the Roman Catholic church. St. Ignatius Loyola, its founder, does not appear to have known that the title of "Society of Jesus" had been bestowed in the 15th century on an order of chivalry established by Pope Pius II., the members of which bound themselves by special vow to fight unceasingly against the Turks. This fact is attested in a letter of that pope dated Mantua, Oct. 13, 1459, and addressed to Charles VII. of France, begging him to permit one of his nobles "to enter into the society bearing the

name of Jesus, and which has been lately founded to fight for the glory of God against the infidels." The efforts of Pius to organize a crusade for the rescue of Constantinople having failed, this new order expired almost at its birth. The appellation *Societas Jesu* was inserted in the Latin forms approved in 1540 by Paul III. The word "Jesuit," it is said, was first used by Calvin in his "Institutes;" it is found in the register of the parliament of Paris in 1552; but at that time it was never used by the companions themselves. The actual title received much opposition from the Sorbonne in France, and even in Italy, where Sixtus V. ordered Claudio de Acquaviva, then general, to discontinue it. But Sixtus died before the order could be executed; and the title was expressly approved by Gregory XIV., June 28, 1594. Ignatius Loyola, very soon after his conversion, conceived the idea of a body of apostolic men specially devoted to the propagation of Christianity among the heathen. In his conception their organization and spirit were to partake somewhat of a military character; hence he always used the Spanish word *compañía* in designating his order, both before it had been canonically established, and in the constitutions which he afterward drew up for it. His original purpose, which he never abandoned, was to have the headquarters of this religious militia in Jerusalem. To effect this he visited that city as a pilgrim in 1523; but the resident Franciscan monks forbade his remaining there. Returning to Spain and becoming conscious that he lacked the literary culture necessary for the accomplishment of his design, he set about preparing himself by study in the universities, and while there collected a small band of young men whom he formed by ascetic exercises to a life of self-renouncement and devotion to the spiritual welfare of others. But the peculiarities of their dress and manner of living, and the discourses which they addressed to the people, excited the suspicions of the inquisitors. Ignatius was repeatedly imprisoned by the holy office, and forbidden to discourse in public or private on religious subjects. He thereupon separated himself from his companions, who never afterward joined him, and went to study in the university of Paris in January, 1528. There he soon gained as followers Pierre Lefèvre, a Savoyard, Francisco Xavier, Diego Laynez, Alfonso Salmeron, Nicolas Alfonso de Bobadilla, Spaniards, and Simon Rodriguez de Azevedo, a Portuguese. When each of these had been separately prepared by Ignatius for adopting a resolution conformable to his purpose, he assembled them in July, 1534, and disclosed to them his project of going to Palestine in order to labor there for the conversion of the Asiatic populations. He added that he would "bind himself to the death" to any among them who would follow him thither, and that he intended to confirm his purpose by taking before them all the vows of chastity and poverty. This

proposal was unanimously adopted; and on the morning of Aug. 15 following Ignatius and his six companions met in a crypt of the church of Notre Dame des Martyrs at Montmartre. Lefèvre, the only priest among them, celebrated mass, and all, before partaking of the communion, read a written engagement by which they renounced all worldly dignities and possessions, bound themselves to the journey to Palestine, to perpetual chastity and poverty, and to receive no stipend for their clerical functions. These vows were renewed annually in the same place while they remained in France to complete their theological studies and receive their degrees. Three more were added to the little band before Ignatius left Paris for Spain in March, 1535; and when on Jan. 6, 1537, they met in Venice, their number was increased to 13. Ignatius having incurred the resentment of Cardinal Caraffa, afterward Pope Paul IV., and not daring to visit Rome himself to solicit the pope's consent to their going to Palestine and his approval of their labors in that country, Lefèvre and the others undertook the journey to Rome amid great hardships. They were well received by Paul III., who, hearing that they were graduates of the university of Paris, made them discuss theological questions in his presence with the most learned Italians in Rome. After learning their manner of life, he approved of their project, gave them money for their expenses, and permission to receive holy orders forthwith. But, as the war between Venice and Turkey rendered the voyage to Palestine impossible, they spread themselves throughout the peninsula after their ordination, Ignatius, Lefèvre, and Laynez going to Rome in November, 1537. He now bade them say, when asked who they were, that they belonged to the *compagnia di Gesù*. The pope appointed Lefèvre and Laynez to chairs of theology in the university of Sapienza at Rome, and Ignatius occupied himself in directing persons who wished to perform his "Spiritual Exercises." All of them embraced every opportunity of assembling and catechizing the Roman children. In March, 1538, all the companions were summoned to Rome for the purpose of deliberating on the erection of the company into a religious order. But a formidable obstacle was raised by the renewal, before the inquisitors of Venice and Rome, of the charge of heresy formerly made against Ignatius in Spain and in Paris. He boldly went himself to the pope, and related to him the whole story of these inquisitorial persecutions, and demanded that an ordinary judge should be instantly appointed to inquire into the matter and decide without delay. To this the pope assented, and a solemn sentence acquitting Ignatius and his followers was issued Nov. 18, 1538. The pope, who recognized the importance of the service which the association could render in counteracting the spirit of Protestantism, immediately commanded schools to be opened throughout the city in which le-

natus and his associates might teach the elements of Christian doctrine. At the same time a fearful famine in Rome afforded them the opportunity of displaying their charity. The pope would not have hesitated to recognize them at once as a religious order, had it not been that a commission appointed that very year to inquire into clerical abuses and scandals had presented to him a report discountenancing the establishment of new religious orders. Nevertheless, Ignatius and his companions began their deliberations in the first days of April, 1539, and a sketch of the proposed constitutions in five chapters was subscribed by all on May 4, and presented to the pope. The master of the sacred palace having reported favorably on this sketch, it was approved orally Sept. 8. Meanwhile these outlines were committed for thorough examination to three cardinals, among whom Cardinal Guidiccioni was so opposed to the introduction of new orders that he would not at first even read the sketch. At length having done so, he changed his mind, won over his colleagues to his opinion, and the bull of confirmation, *Regimini militantis ecclesie*, was signed Sept. 27, 1540, and promulgated in the spring of 1541. It restricted the number of "professed" members to 60; but this restriction was removed, March 14, 1548. A written promise of entering the company after its confirmation by the pope had been signed by 11 of the members, including Ignatius, on April 15, 1539. After their deliberations closed on May 4, most of them were sent by the pope on various missions. Codure, Le Jay, Ignatius, and Francis Xavier remained in Rome, Xavier being secretary and keeping up the correspondence with the absent members. On March 15, 1540, Ignatius informed Xavier that he was to leave Rome the next day for Lisbon and the East Indies. At the same time the pope destined others for Ireland in order to counteract there the measures of Henry VIII. At the Easter of 1541 Ignatius was unanimously chosen general, those absent from Rome sending their votes in writing, and he entered on the office April 13. In conformity with the will of the pope and the wish of his companions, he now began to draw up constitutions for the new order. He had read previously the lives of the founders of religious orders, as well as the rules which they had framed for their followers; but while engaged in framing the constitutions of the society, he shut himself up, with no books near him save the Bible and the "Imitation of Christ," preparing himself before he wrote by prayer and meditation, then placing what he had written upon the altar during mass, and only consulting with the other fathers when he had well considered each matter himself and come to some decision. These constitutions, drawn up in Spanish, and translated into Latin under the eyes of Ignatius, received high praise from Cardinal Richelieu. They are now accessible to all (*Institutum Societatis Jesu*, 2 vols., Avignon, 1827-'38, a reprint from the

official edition of Prague, 2 vols., 1757). It was only in 1550 that they were so far complete that Ignatius could communicate them to an assembly of the professed who had been summoned to Rome, including Laynez and Francis Borgia. He wished his work to be suitable for all without distinction, so that the difference of countries and nations, of manners and dispositions, should require neither exceptions nor dispensations. He also submitted the constitutions to the judgment of the absent. They were examined with the most minute attention, and were only published when every correction or addition suggested and deemed necessary had been made. In 1553 they were sent upon trial to Spain, Portugal, and other countries, in order that they should be approved by the whole body only when found everywhere to be in perfect accordance with the design of the society. This sanction of the whole body was not given to them till 1558, after the death of Ignatius, and in the congregation assembled to choose his successor. They were revised with the utmost care, and confirmed with unanimity. They were then presented to Pope Paul IV., who appointed a commission of four cardinals to examine them. These approved the constitutions unanimously, and the pope confirmed them without changing a single word. Laynez added nothing to them, nor is it on record that he had any more to do with the framing of them than any other of the members consulted by Ignatius.—The kernel or indestructible portion of these constitutions is found in the draft presented to Paul III. and first approved by him. In this it is said that "whoever wishes to enter the society of Jesus, to fight under the standard of the cross and of God and our Lord Jesus Christ, and to serve the church his spouse under his vicar the Roman pontiff, must keep in mind that this society has been established for the defence and propagation of the faith, for promoting the salvation of souls, by teaching Christian doctrine and Christian life, by explaining the word of God, by giving the 'Spiritual Exercises,' by teaching catechism to the young and ignorant, by the administration of the sacraments, and especially the sacrament of penance. He must keep also in mind that its object is to perform works of mercy, more particularly for the sick and the imprisoned; and all this is to be done gratuitously and without any earthly compensation." The constitutions are divided into 10 parts. The 1st describes the qualities which allow or forbid the admission to noviceship; the 2d, the causes and manner of rejection; the 3d and 4th relate to health, devotion, and study; the 5th explains the profession of the four vows and the inferior degrees; the 6th and 7th instruct the professed and spiritual coadjutors in their various offices; the 8th and 9th concern the general, his election, authority, and duties; the 10th gives general directions for the conservation and increase of the society. The greatest discrimination is used in the choice

of candidates for membership. Some circumstances or qualities form absolute impediments to admission, such as illegitimate birth or infamous descent, public heresy or apostasy, such crimes as murder or enormous secret sins, the brand of a degrading judicial sentence, matrimonial ties, membership even for one day in another religious order, and insanity or notable weakness of intellect. Less serious impediments, such as ill temper, obstinacy, injudicious enthusiasm or visionary devotion, the being involved in debt, &c., may be compensated by other redeeming qualities and circumstances. The first probation consists of a period of some weeks spent by the candidate in a house of the society, during which he is given to read the *Examen Generale*, taken from the first part of the constitutions, containing a series of questions, which he is required to answer truthfully. His examiner is bound to the strictest secrecy as to the answers. These questions involve every possible impediment to his admission. He is required also to declare if he is perfectly free in his determination to enter, or if he is led to do so by friendship for any member of the society. He is finally asked if he is willing that all letters written by him or addressed to him shall be opened by the superior; if he consents that the superior shall admonish him of all imperfections and faults which he may remark in him, and that his companions shall report the same to the superior; and, finally, if he will be content to accept any grade, occupation, or office in the society which may be assigned to him. The candidate, having waived his natural rights on these points, is admitted to his second probation or noviceship, which lasts two years and one day from the date of his first entrance. During the first year the novices devote a full month to the performance of the "Spiritual Exercises," which they are required to master as an indispensable instrument of future utility to others. The whole two years are given up to spiritual things. They teach the elements of Christian doctrine to children and the poor, serve the sick for a month in some hospital, and travel during another month from place to place without money, and subsisting on the charity received by the way. They have also daily conferences or lessons on the constitutions and rules of the society. The severest scrutiny is exercised with regard to the capacity and dispositions of each novice, and every means is employed to encourage him to correct what is faulty and to perfect what is praiseworthy in his conduct. Such as are destined for the priesthood are called "scholastic novices;" the others, who are to be lay brothers, are not allowed to rise any further in secular knowledge. They must be content with what they already possess, and apply themselves to the acquisition of humility and solid piety. At the end of these two years, the novices pronounce the simple vows of poverty, chastity, and obedience, with a formal promise to enter the society at a future

day, implying an engagement to accept readily any degree which may be given them therein. Such as are destined to study now assume the name of formed scholastics (*scholastici formati*). If they are young enough, a space of two years, called juniorship or juvenate, is spent by them in cultivating Latin and Greek letters and rhetoric; then three years are given in a scholasticate to mental and moral philosophy and the sciences. The professors in these special seminaries are all men who have themselves passed through the entire curriculum of sacred and profane science, and have either made the profession of the four vows, or are destined to do so in due time. Every six months the scholastics undergo a most searching examination before four sworn examiners, who send separately their sealed suffrages to the general and the local provincial. At the end of the philosophical course the scholastic is sent to teach in a college, both for the purpose of enabling him to apply his acquired knowledge and of training him to the science of governing men. Should his age permit, he begins with the lowest grammar and leads his scholars up to humanities and rhetoric. This is called by the French *cours de régence*, and is followed by the study of theology, Scripture, canon law, and church history, which lasts four years. The half-yearly examination here becomes still more rigorous, and at the end of the third year it is increased in length and severity. Should the candidate break down in this he is not allowed to proceed in his fourth year of study. At the end of the third year the scholastics are raised to the priesthood. The fourth year closes with the *examen ad gradum*, or the examination which qualifies the successful candidate for the profession of the four vows, the highest rank in the society. Three months in advance of the day appointed for this, the candidate is given a series of theses embracing the substance of dogmatical theology, intellectual philosophy, and the natural sciences. He is freed from every other occupation in order thoroughly to prepare himself for the ordeal. The examination takes place before a commission of four examiners presided over by the rector, and lasts two hours, each examiner being bound by his oath to propound the most searching questions and formidable objections during half an hour. The suffrage, delivered sealed to the general and the provincial, attests that the "candidate is (or is not) able to teach the whole of theology, philosophy, and the sciences in any university." This intellectual ordeal is one regular condition for obtaining the degree of professor; the other and a more indispensable condition is proficiency in solid virtue as well as in learning. Sometimes young men of extraordinary eloquence are allowed, after passing this last examination, to spend two years more in biblical and patristic studies. Generally, however, they pass from the scholasticate to what is known as the third "profession," which is a

entire year spent in a special establishment and under a master thoroughly versed in asceticism and a knowledge of the constitutions of the society. Their exercises are substantially those of noviceship or second probation, a full month being devoted to the "Spiritual Exercises," another to pilgrimage, and a third to giving retreats or missions. This year St. Ignatius called the "school of the heart." When the special informations sent to the general concerning the probationists assure him that they possess that superiority in virtue and science required by the constitutions, he awards them their degree of professed of the four vows. Throughout this protracted course of studies and probation, every precaution is taken that the mind shall not be diverted from the object of study, that the bodily health shall not be injured by intense mental application, and that the springs of piety in the soul shall not be dried up by the exclusive culture of the intellect. The establishments in which the young Jesuits are trained are allowed by Ignatius to receive endowments, or they are supported by taxes levied on all the houses of the province, or, in some instances, wealthy novices are allowed to retain the possession of their property, but not the disposal of their revenues, until their studies and probation are ended, and thus to pay their own expenses. But in no case are they allowed to seek outside of the house for alms, or to be turned away in any manner from their studies. The members of the society who have taken their final vows, *socii formati*, are distinguished into three classes, the professed, the spiritual coadjutors, and lay brothers, or temporal coadjutors. The degree of professed of three vows is an honorary distinction bestowed for some signal service or great quality on priests who do not possess the regular theological or scientific attainments required for the profession of the four vows; this distinction enables its subject to rank with the latter, but not to hold the offices reserved to them, such as those of general, provincial, and elector in a general congregation. The "professed society" (*societas professa*) constitutes the core of the whole body; the coadjutors, both spiritual and temporal, are only auxiliaries or helpers. To the professed society belong the colleges, seminaries, houses, and residences of the order, together with all other property whatsoever, movable and immovable; and it is in its name that this property is held and administered by the coadjutors. In ordinary life the professed are not distinguished from the spiritual coadjutors. The latter are appointed in preference to the government of lay colleges and seminaries, to superiorships in residences, &c.; while the professed are left free to preach, or to teach the higher branches of sacred and profane science, and it is only by certain reserved occupations and functions that their rank is known to the majority of their brethren.—The whole order is divided into assistancies, of which there are

at present five, distributed according to the foremost European races or languages, namely, those of Italy, Spain, France, Germany, and England. The original assistancy of Portugal has been abolished since the total extinction of the society in that country, and that of England has been recently created. Each assistancy embraces several provinces and missions. A province comprises one or more colleges, a novitiate, scholasticate, and residences with a stated number of professed. It has a certain autonomy, and depends on the general only in the measure prescribed by the constitutions. At the head of the order is a general (*propositus generalis*), who is elected for life in a general congregation composed of the provincials and two delegates from each province. They elect at the same time the five assistants who form his council, the secretary of the society, and an admonitor, whose duty it is to observe the conduct and actions of the general and to admonish him when necessary. If they see in his conduct anything censurable, they must lay their observations before him; and in a case of great urgency or visible scandal, the assistants can summon without his assent a general congregation, or even depose him themselves, after obtaining by letter the suffrages of the provinces. The power of the general, so long as he acts within the limits of the constitutions, is very great. He appoints the provincials, rectors of colleges, scholasticates, and novitiates, the superiors of professed houses and residences, together with the executive officer in each house, called minister; these are properly denominated superiors, and have a right to command. The inferior officers are nominated by the provincial with the approbation of the general. Every provincial, rector, and superior has his council of four consultors and his admonitor. The provincial is required to report every month to the general; the other superiors report every three months. The consultors, both provincial and local, are bound to report separately at stated times. Every three years deputies elected by the provincial congregations meet in Rome or wherever the general resides. They compose what is called the "congregation of procurators," and one of their chief functions is to decide on the necessity of convening a general congregation. They also bear to the general from each province a complete catalogue of its members, detailing the conduct and capacity of each. In the general congregation resides the supreme legislative power. The provincial congregation is composed of the provincial, rectors, and senior professed members. The term of office for all superiors below the general is three years. Provincials visit every house in their jurisdiction once a year, to see that the constitutions are exactly observed by all. During this visitation rigorous inquiry is made into the temporal and spiritual welfare of each house. Every member, beginning with the rector or superior, has to render to the provincial a full account of

his conscience, of his temptations and trials, and the difficulties he meets with in the performance of his special office. This "manifestation of conscience," whether made in sacramental confession or not, obliges the provincial to the most inviolable secrecy. He can only make of the knowledge thus acquired the use which the inferior permits him. At the same time the latter is informed of the defects which have been remarked in his conduct. This practice is one of the fundamental points or *substantialia* of the constitutions, and contributes above all others to the government of the society its extraordinary power, as well as to make obedience easy. Another chief object of this yearly visitation is to correct every abuse in the matter of poverty. Obedience and dependent poverty are the two mainsprings of the order. One of the vows made at the time of the solemn profession binds the professed to maintain the obligations of poverty inviolable, or to make them more rigorous. The rectors and local superiors yearly demand the same "account of conscience" of their subjects; and as all who have not pronounced their last solemn vows renew their simple vows twice a year, this renewal affords a fitting opportunity for repairing every violation of religious poverty. Before the time of Ignatius one year's novitiate only was required before admission to membership in a religious order, and the emission of the solemn religious vows. In his constitutions, besides a novitiate of two full years, he demanded a further probation of several years before any one was admitted to final membership. Thus there are three kinds of vows made by Jesuits to the society: the simple vows made at the end of the novitiate, and renewed every six months, but not accepted by the society; the simple but final vows made by the coadjutors, both temporal and spiritual, when they are solemnly admitted into the society, which accepts them by the hands of the local superior; and the solemn vows made by the professed. The fourth solemn vow is to the pope, and binds the Jesuit to go wherever the former may send him for the service of the church. The professed, besides these four which are made publicly in the church, pronounce in private immediately afterward a formula containing several simple vows, among them one binding them neither to seek nor to accept any dignity or office in the society or in the church, and to denounce all of their brethren whom they know to be seeking them. The society of Jesus never admitted a third order, like the Dominicans and Franciscans; and St. Ignatius inflexibly refused not only to allow nuns to have any fellowship with the society, but to permit its members to be cumbered with the direction of nuns. There never has been any body of men or women directly or indirectly affiliated to the Jesuits. The dress adopted by St. Ignatius and his companions was that of the better class of Spanish secular priests. It con-

sists in a black cassock and cloak, and has been somewhat modified in various provinces. Two popes (Paul IV. and Pius V.) and one general (Francis Borgia) wished to assimilate the Jesuits in some points more to the other religious orders, in particular by introducing the observance of the canonical hours; but this was soon given up, and the whole energy of the order was directed to laboring in behalf of the church by means of education and missions.—As the "Spiritual Exercises" of St. Ignatius moulded not only his own religious character and that of his early companions, but the spirit of the society, it is impossible to understand either its constitutions or the private and public life of its members, without having some conception of the nature and aim of that famous book. It is not a book to be merely read; for it contains only germs of thought, and rude outlines of meditations on the great Christian truths and facts of gospel history. The "exercises" consist in a graduated series of meditations on the creation and destiny of man; on the degradation and misery wrought by sin; on the restoration of the fallen children of God to their true rank in Christ, and the manifestation of true heroism in following him in poverty, toil, humiliation, suffering, and death. The meditations are intermingled with practical rules for examining one's conscience, for the prudent use of penitential austerities for detecting and resisting temptations, for discovering the action of the good spirit on one's soul from that of the evil one, for making a safe election in determining one's calling in life, for a right distribution of alms, for moderating one's appetite in eating and drinking, and finally for conforming one's judgment to that of the church. These exercises, when fully performed in retirement, last over a month, and are divided into four stages or "weeks." In the first, the truth of God's right over man's being, faculties, and life is made the foundation of all the subsequent exercises, and a practical "indifference" in the use of all things, states, and conditions of life is inculcated as a necessary conclusion from the fact that wealth and poverty, health and sickness, are only means to an end, and in themselves indifferent. The foundation of religious poverty and self-renunciation is thus laid at the very outset. Then come the meditations on sin and its punishments in time and eternity, terminating with the contemplation of Christ crucified, and the mingled sentiments of grief and love, shame and generosity, inspired by the consciousness of one's own guilt in presence of the divine victim of sin. Next comes the meditation of Christ our king as the model of the generosity to be thenceforth displayed in serving God. Ignatius proposes here the conception formed at Manresa, when he had renounced the secular militia for a life of spiritual chivalry. Christ presents himself as a king inviting all his subjects to aid him in subjecting the whole earth to God, asking none to follow where he





grims and travellers who visit the city. Beads, crosses, and ornaments are largely manufactured and sold to strangers. Quantities of olive and sesame oil and soap are also produced here, and much is exported to Egypt and to ports on the Mediterranean; grain and other articles are also exported. Almost all manufactured articles, as cloths, sugars, candles, &c., are imported from France, England, and Germany. Petroleum has for several years been in great demand in the markets of Palestine, and has now almost superseded olive and sesame oil for lighting, these being used only for food and manufacturing soap.—The primitive name of Jerusalem appears to have been Jebus, or poetically Salem, and its king in the time of Abraham was Melchizedek. When Abraham returned from the slaughter of the kings who had made his nephew Lot prisoner, the king of Sodom met him in the valley of Shaveh, or the king's dale, now probably the valley of Jehoshaphat; and there Melchizedek brought bread and wine. At the conquest of Canaan by the Hebrews, the tribe of Judah took the city and set it on fire; but the fortress probably still remained in the hands of the Jebusites for 400 years longer. Its situation among the mountains almost in the heart of his kingdom naturally excited in David a desire to possess it. In the ninth year of his reign (about 1046 B. C.) he stormed the fortress of the Jebusites, Zion, called it the city of David, and made the place the capital of his kingdom. From that time it has been called Jerusalem. Under Solomon the temple was built on Mt. Moriah, and several palaces were erected. David's many conquests, his vast accumulation of treasures for the temple, the magnificent structure itself, and afterward Solomon's reputed wisdom and immense wealth, all tended to spread the fame of the city, and during his reign it attained its highest degree of power. At the accession of his son Rehoboam ten of the tribes seceded under Jeroboam and made Shechem, and subsequently Samaria, the capital of their kingdom of Israel. Jerusalem then lost much of its importance, remaining only the capital of the smaller, though more powerful, kingdom of Judah. About 971 B. C. Shishak, king of Egypt, took the city and plundered the temple and palace of their treasures. It was again conquered and sacked by Joash, king of Israel, and was afterward beautified by Uzziah, Jotham, Hezekiah, and Manasseh. In the time of Ahaz the king of Syria attacked Jerusalem, and carried many of the Jews captive to Damascus, though he could not take the city. Under Hezekiah it was besieged by Rabshakeh, the general of Sennacherib, king of Assyria, but it was saved by the sudden destruction which overtook the Assyrian army. Manasseh's being carried captive to Babylon seems to intimate that the city was taken by the Chaldeans about 650, although the fact is not expressly stated in the Bible. After the death of Josiah at the battle of Megiddo, Jerusalem was tributary to

Pharaoh Necho, king of Egypt, for two or three years, when it passed into the hands of the Babylonians, who, after repeated revolts and sieges, finally reduced it in 586. (See HANANWA.) On this occasion Nebuchadnezzar demolished the walls and all the principal houses in the city, plundered and destroyed the temple, and carried away to Babylon all except the poorest citizens. For the next 50 years Jerusalem remained in ruins, till the return of the Jews during the reign of Cyrus, the conqueror of Babylon (538). This monarch issued a proclamation allowing the return of the Jewish captives to Jerusalem and authorizing them to rebuild the temple, and enjoined every one to contribute to and assist in this work. A part of the captives returned under Zerubbabel, and rebuilt the altar and laid the foundation of the second temple. But they were interrupted by the intrigues of their enemies, who unceasingly wrote insinuating letters to the capital of the empire, and at last succeeded in stopping them. The work was renewed under Ezra, who obtained a commission from Artaxerxes (Longimanus). In the 20th year of his reign (458), the king commissioned Nehemiah to rebuild the city itself. This he effectually carried out in spite of the opposition of his enemies, being himself appointed civil governor of Judea, and having the direct patronage of the king, whose cup-bearer he was. Nehemiah rebuilt the walls on the ruins of the old city. From this period till the Macedonian invasion in 332 Jerusalem enjoyed comparative peace. Yielding to Alexander without resistance, it escaped the fate of Tyre and Gaza. After the death of that conqueror and the division of his empire among his generals, Judea and its capital, lying between the rival kingdoms of Egypt and Syria, were alternately seized by the sovereigns of these two countries. Under the Ptolemies Jerusalem flourished both as a commercial city and a shrine. It was well adapted for trade, and abounded in artificers of various crafts. Its markets were well supplied by the Arabs with spices, gold, and precious stones. Goods were also imported across the sea, for there were good harbors at Gaza, Joppa, and Ptolemais (Acre). It passed into the power of Syria, with the rest of Judea, in 198, and was mildly ruled by Antiochus the Great; but the tyranny of his son, Antiochus Epiphanes, inflicted on it repeated massacres, and finally brought about the victorious revolt under the *Asmoneans*. Judas Maccabeus wrested Jerusalem from his enemies, and repaired the temple (165), though he was unable to expel the garrison that had been left in the fortress of *Acra* W. of *Moriah*, which commanded the temple, and from which the Syrians made annoying sallies. Against it he fortified Mt. Zion. This, however, shortly after surrendered to Antiochus V., who, breaking the capitulation, demolished the fort. Jonathan, the brother and successor of Judas, rebuilt it, but equally failed in an attack on *Acra*. His brother Simon reduced *Acra*, &c.

demolished the citadel, and levelled the hill. In 3 Jerusalem was captured by Pompey, who intervened between the brothers Aristobulus and Hyrcanus, the walls were demolished, and thousands of the inhabitants were slain. He also entered the temple, but did not touch any of the treasures. It was plundered by Crassus, on his way to Parthia, in 54. The walls were rebuilt by Antipater, who was appointed procurator of Judea by the Romans. In 40 the Parthians, allies of Antigonus, son of Aristobulus, sacked the city. Herod, having been appointed king by the Roman senate, besieged Jerusalem, and took it in 37, and the massacre on this occasion was as bloody as that by Pompey. Herod erected or enlarged and beautified the fortress of Antonia; he also improved and enlarged the city, and restored the temple on a more magnificent scale than Solomon's. Jerusalem appears now to have reached the zenith of its greatness, though not of its power, which never recovered after the death of Solomon. It is conjectured that the city at this time contained at least 200,000 inhabitants in its lofty and closely compacted dwellings. This period is marked by the most memorable events in its history, the ministry and crucifixion of Christ. About A. D. 66 the Jews, goaded to despair by the tyranny of the Romans, revolted, took possession of Jerusalem, and defeated the Roman army commanded by Cestius Gallus, governor of Syria. This was the beginning of the disastrous war which ended in the complete destruction of Jerusalem. In 70 Titus, after a long and vigorous siege, took the city, and his soldiery, maddened by the obstinate resistance of the defenders and their own repeated fruitless attempts and great losses, spared neither age nor sex. Thousands of Jews, seeing all hope lost, threw themselves headlong from the towers, turned their swords against their own breasts, rushed into the flames, or fell fighting the enemy. Titus himself was unable to control the rage of his troops, and with regret saw the temple destroyed by the flames and the principal towers demolished, which he had intended to preserve as memorials of his own victories. According to Josephus, 1,100,000 Jews perished in this siege, and 97,000 were carried into captivity; and Tacitus says that the number besieged in the city, including both sexes and every age, amounted to 600,000; but a critical examination easily proves both statements to be greatly exaggerated. The walls were levelled, the wellings demolished, the temple was burned, and Mt. Moriah literally ploughed over. Sixty years afterward Hadrian resolved to rebuild the city and colonize it with Romans. But a revolt, headed by Bar-Cokheba, for a long time delayed the realization of his plans. For two or three years the insurgents held out in Jerusalem, but at last they were vanquished, and rich edifices as remained or had been rebuilt were again demolished by the emperor's general, Severus. On the ruins Hadrian built

another city with luxurious palaces, a theatre, temples, and other public buildings. He called it *Ælia*, after his family name *Ælius*. On the site of the Jewish temple he raised another to Jupiter Capitolinus, from which the city took its surname of *Capitolina*. It is said that he erected a fane of *Venus* over the sepulchre of Christ, and Jews were forbidden to enter or come within a certain distance of the city on pain of death. Under the Christian emperors they were permitted to enter once a year, on payment of a large sum of money, to lament over their misfortunes. Under Constantine the city had already become the place of pilgrimage of the Christian world. It regained its ancient name, and the emperor furnished new attractions by the erection of a church over the place that had been pointed out as the sepulchre of Christ. The emperor Julian not only allowed the Jews to return to their city, but also made a futile attempt to rebuild the temple. About 530 Justinian followed the example of Constantine by building churches and hospitals in the city. In 614 Chosroes II. of Persia invaded the Roman empire. A division of his army marched into Palestine, and 26,000 Jews mustered under his banner, hoping to find in him a second Cyrus. After conquering the northern parts of Palestine, the united army of Persians and Jews laid siege to and captured Jerusalem. The Jews wreaked their vengeance on the Christians for all the persecutions they had suffered at their hands; 20,000 of them are said to have fallen, the church of the Holy Sepulchre was burned, and the part of the reputed cross of Christ which was deposited there was carried to Persia. It was recovered by the emperor Heraclius, and replaced in the church of the Holy Sepulchre with great pomp, and the law of Hadrian forbidding the Jews to enter the city was renewed. In 636 Jerusalem was besieged by Khaled and Abu Obeidah, the generals of the caliph Omar. The siege lasted four months, and scarcely a day passed without a sortie or an attack. The besiegers, notwithstanding the inclemency of the winter and the hardships against which they had to combat, displayed great courage and persistence. The patriarch Sophronius at length resolved to capitulate, but insisted upon treating with the caliph in person, hoping to gain from him better terms than he could from his generals. Omar came up to Jerusalem, and on taking possession of the city treated the inhabitants with great kindness and generosity. In the latter part of the 11th century Syria was invaded by the Seljuk Turks and converted into a province of their empire. The cruelties which the Christian pilgrims suffered at the hands of these people roused the indignation of all western Europe, and great numbers of the chivalry of France and England were led by Godfrey de Bouillon to recover the sepulchre from the infidels. Jerusalem was stormed and taken, July 15, 1099, and the crusaders, in their zeal to avenge the wrongs of the Christians, slew 70,-

000 Moslems. Godfrey was elected ruler of Jerusalem, and his brother and successor assumed the title of king. In 1187 Saladin, sultan of Egypt, marched against the city, summoned it to surrender, and promised the inhabitants rich lands in Syria; but his proposals were rejected with scorn. Upon this he swore to avenge the Moslem blood shed by the soldiers of Godfrey, and to demolish the towers. The Christians resisted bravely for 12 days, but at last were conquered. Saladin, however, did not carry out his threat of massacre, but contented himself with expelling the Christians from the city, granting them 40 days to remove their effects, and assisting many of the poor and helpless on their departure. Jerusalem again passed into the hands of the Franks by treaty in 1229, was retaken by the Moslems in 1239, once more restored in 1243, and finally conquered in 1244 by a horde of Kharezmian Turks, who had overrun Asia Minor. In 1517 Palestine was conquered by Sultan Selim I., and since then Jerusalem has been under the rule of the Ottoman empire. From 1832 to 1840 Palestine was in the hands of Mehemet Ali, pasha of Egypt, and Jerusalem was governed by his son Ibrahim Pasha. Previous to the Egyptian invasion Palestine was distracted with anarchy, and but nominally ruled by the Turks. When Ibrahim Pasha took possession of Jerusalem his first acts were to restore order in the city and country. He did his utmost to protect the Christians and Jews against the oppressions of the Moslems, and granted them many privileges. Safety was restored, the roads were cleared of robbers, and commerce revived. (See PALESTINE, and HEBREWS.)—See Robinson, "Biblical Researches" (3 vols. 8vo, Boston, 1841), and "Later Researches" (8vo, 1856); Bartlett, "Walks about Jerusalem" (8vo, London, 1845); Fergusson, "Ancient Topography of Jerusalem" (London, 1847), "Site of the Holy Sepulchre" (1861), and "The Holy Sepulchre and the Temple" (1865); Poinsonat, *Histoire de Jérusalem* (2 vols., 2d ed., Paris, 1848); Thrupp, "Ancient Jerusalem" (Cambridge, England, 1855); Barclay, "The City of the Great King" (Philadelphia, 1857); Tobler, *Planographie von Jerusalem* (Gotha, 1858); Lewin, "Jerusalem to the Siege by Titus" (London, 1861); Sepp, *Jerusalem und das heilige Land* (Schaffhausen, 1862); Sandie, "Horeb and Jerusalem" (Edinburgh, 1864); Piccrotti, "Jerusalem Explored," translated from the French by T. G. Bonney (London, 1864); De Vogüé, *Le temple de Jérusalem* (fol., Paris, 1864-5); De Sauley, *Voyage en Terre-Sainte* (2 vols. 8vo, Paris, 1865); Wilson, "Ordnance Survey of Jerusalem" (3 vols. fol., London, 1865-7); Wilson and Warren, "The Recovery of Jerusalem" (8vo, London, 1871; popular edition, "Our Work in Palestine," 1873); and Wolff, *Jerusalem, nach eigener Anschauung und den neuesten Forschungen geschildert* (3d ed., including his latest investigations,

Leipsic, 1872). See also the works referred to under PALESTINE.

**JERUSALEM, Johann Friedrich Wilhelm**, a German theologian, born in Osnabrück, Nov. 22, 1709, died Sept. 2, 1789. He was appointed in 1740 preacher to Duke Charles of Brunswick, and in 1742 became tutor of the hereditary prince. In 1752 he was placed in charge of a theological seminary established by the Protestants in the former convent of Kidagshausen. He declined the appointment of chancellor of the university of Göttingen. He was one of the best preachers of Germany. The suicide of his son Karl Wilhelm suggested to Goethe the catastrophe of the "Sorrows of Werther."

**JERUSALEM CHERRY**, a name given to two species of *solanum* which are cultivated for the ornamental character of their fruit. The oldest and best known of these is *S. pseudo-capsicum*, which was introduced into England from Madeira in 1596; it is a half shrubby house plant, and when properly treated has a hand-



Jerusalem Cherry.

some rounded head upon a stalk 1 or 2 ft. high; it has lance-oblong leaves and white flowers; the small and inconspicuous flowers are succeeded by bright red berries about the size of cherries, which are borne in great profusion and render the plant very ornamental. It is usually raised from seeds, but may be grown from cuttings; if the seeds are sown in early spring and the plants kept growing rapidly, they will produce fruit the following winter. It is supposed that the name Jerusalem was applied to this, as it formerly was to other plants, more to indicate its foreign origin than with reference to the country from which it came. The dwarf Jerusalem cherry is *S. asiaticum*, which is only about half as tall as the other, and its berries are more orange than scarlet; there is a form of this with variegated leaves. In England these plants are raised in large quantities for Christmas and table dec-

na. An improved sort called *S. hybridum*, very popular for table decoration, is depicted above.

**VAS, Charles**, a British painter, born in England about 1676, died in London in 1739. He died for a short time under Sir Godfrey Kneller, and in France and Italy, although devoted to the most essential principles of art, he acquired a fictitious reputation; and having given drawing lessons to Pope, the poet dedicated to him an epistle full of extravagant praise. Horace Walpole denounced his inferiority; but Jervas was so conceited that on comparing his copy of a Titian to the original he exclaimed, "Poor little Tit! how he would have envied me!" Lord Orford says that "the badness of his taste and the dearth of good masters made Jervas at the head of his profession."

**VIS, Sir John**, earl of St. Vincent, a British admiral, born at Meaford, Staffordshire, England, 1734, died March 15, 1823. He entered the navy at the age of 10 years, and became a captain in 1760. He distinguished himself in several naval engagements, was made C. B. in 1762, and during the same year sailed with Lord Howe to the relief of Gibraltar. He was promoted to the rank of rear admiral in 1771 and was in parliament from 1782 until 1791. He sailed to the West Indies and captured Martinique and Guadeloupe. He was appointed admiral of the blue, June 1, 1795, and on Oct. 4, 1797, off Cape St. Vincent, defeated the Spanish fleet which was nearly twice as large as his own. For this he was raised to the peerage by the title of earl of St. Vincent. He was baron Jervis of Meaford, receiving a pension of £3,000. He was first lord of the Admiralty from 1801 to 1804.

**VIS, or Vesal** (anc. *Æsis* or *Æsium*), a town in the province of Ancona, 15 m. S. W. of Ancona, on the N. bank of the Esino (anc. *Æsis*); pop. about 20,000. It is an episcopal see, and one of the most important towns of the province, with manufactures of woollen and silk goods, and with increasing activity owing to the railway connection with Ancona. Under the Romans it was a *municipium*, and from ancient inscriptions appears to have been a colony. The emperor Frederick II. was born here.

**VIS, Samuele**, an Italian engraver, born in Florence, about 1789, died in Florence, Jan. 17, 1854. He was a pupil of Longhi, and first attracted notice by his engraving of the Madonna with St. John and St. Stephen, Fra Bartolommeo's picture in the cathedral of Lucca. Subsequently he devoted himself to the works of Raphael. His portraits of Pope X. and Cardinals Rossi and Giulio de' Medici, from the original in the Pitti palace, were much admired. The latter is said to have died him five years.

**VISAMINE**. See JASMINE.

**VIRGINIA**, a central county of Kentucky, bounded S. by Kentucky river; area, 160 sq.

m.; pop. in 1870, 8,688, of whom 3,489 were colored. It has a somewhat diversified surface, with a soil of more than ordinary richness. The Kentucky Central railroad terminates at the county seat. The chief productions in 1870 were 79,562 bushels of wheat, 30,176 of rye, 409,505 of Indian corn, 58,740 of oats, 13,644 of potatoes, 14,175 lbs. of wool, and 78,915 of butter. There were 2,594 horses, 1,016 mules and asses, 1,548 milch cows, 3,889 other cattle, 3,488 sheep, and 10,150 swine; 8 manufactories of carriages, 1 of bagging, and 1 distillery. Capital, Nicholasville.

**JESSE, John Hennessy**, an English author, born about 1815, died in July, 1874. In 1839-'40 he published "Memoirs of the Court of England during the Reign of the Stuarts" (4 vols. 8vo), which he continued in his "Memoirs of the Court of London from the Revolution in 1688 to the Death of George III." (3 vols., 1843). He also published "George Selwyn and his Contemporaries" (4 vols., 1843); "Memoirs of the Pretenders and their Adherents" (2 vols., 1845); "Literary and Historical Memoirs of London" (1847), and a second series under the title "London and its Celebrities" (1850); "Richard III. and his Contemporaries" (1861), criticising the view commonly taken of the character of Richard; "Memoirs of the Life and Reign of George III., with Original Letters of the King and other Unpublished MSS." (1867); "London, its Celebrated Characters and Places" (3 vols., 1870); and several volumes of poems.

**JESSE**. See Yezo.

**JESSULMEER**, a town of British India, capital of a native state of the same name, the westernmost of Rajpootana, situated in a rocky district, 190 m. N. E. of Hyderabad on the Indus; pop. estimated at from 30,000 to 40,000, nearly all Hindoos, the ruling class being the Bhatti tribe of Rajpoots. It is one of the finest towns in that part of India, about 2 m. in circuit, with gates, ramparts, and bastions, and a lofty citadel enclosing six temples and other remarkable buildings, and the palace of the maharajah, the sovereign, which is surmounted by a huge metal umbrella. The dwellings are remarkably well built. The most conspicuous building has five stories of cut stone, and a sixth of timber, surmounted by five cupolas. Opium is used to excess. There is little trade, and the fortifications are decaying.

**JESUITS**, or *Society of Jesus* (Span. *Compañia de Jesus*), a religious order of the Roman Catholic church. St. Ignatius Loyola, its founder, does not appear to have known that the title of "Society of Jesus" had been bestowed in the 15th century on an order of chivalry established by Pope Pius II., the members of which bound themselves by special vow to fight unceasingly against the Turks. This fact is attested in a letter of that pope dated Mantua, Oct. 13, 1459, and addressed to Charles VII. of France, begging him to permit one of his nobles "to enter into the society bearing the

name of Jesus, and which has been lately founded to fight for the glory of God against the infidels." The efforts of Pius to organize a crusade for the rescue of Constantinople having failed, this new order expired almost at its birth. The appellation *Societas Jesu* was inserted in the Latin forms approved in 1540 by Paul III. The word "Jesuit," it is said, was first used by Calvin in his "Institutes;" it is found in the register of the parliament of Paris in 1552; but at that time it was never used by the companions themselves. The actual title received much opposition from the Sorbonne in France, and even in Italy, where Sixtus V. ordered Claudio de Acquaviva, then general, to discontinue it. But Sixtus died before the order could be executed; and the title was expressly approved by Gregory XIV., June 28, 1594. Ignatius Loyola, very soon after his conversion, conceived the idea of a body of apostolic men specially devoted to the propagation of Christianity among the heathen. In his conception their organization and spirit were to partake somewhat of a military character; hence he always used the Spanish word *compañia* in designating his order, both before it had been canonically established, and in the constitutions which he afterward drew up for it. His original purpose, which he never abandoned, was to have the headquarters of this religious militia in Jerusalem. To effect this he visited that city as a pilgrim in 1523; but the resident Franciscan monks forbade his remaining there. Returning to Spain and becoming conscious that he lacked the literary culture necessary for the accomplishment of his design, he set about preparing himself by study in the universities, and while there collected a small band of young men whom he formed by ascetic exercises to a life of self-renouncement and devotion to the spiritual welfare of others. But the peculiarities of their dress and manner of living, and the discourses which they addressed to the people, excited the suspicions of the inquisitors. Ignatius was repeatedly imprisoned by the holy office, and forbidden to discourse in public or private on religious subjects. He thereupon separated himself from his companions, who never afterward joined him, and went to study in the university of Paris in January, 1528. There he soon gained as followers Pierre Lefèvre, a Savoyard, Francisco Xavier, Diego Laynez, Alfonso Salmeron, Nicolas Alfonso de Bobadilla, Spaniards, and Simon Rodriguez de Azevedo, a Portuguese. When each of these had been separately prepared by Ignatius for adopting a resolution conformable to his purpose, he assembled them in July, 1534, and disclosed to them his project of going to Palestine in order to labor there for the conversion of the Asiatic populations. He added that he would "bind himself to the death" to any among them who would follow him thither, and that he intended to confirm his purpose by taking before them all the vows of chastity and poverty. This

proposal was unanimously adopted; and on the morning of Aug. 15 following Ignatius and his six companions met in a crypt of the church of Notre Dame des Martyrs at Montmartre. Lefèvre, the only priest among them, celebrated mass, and all, before partaking of the communion, read a written engagement by which they renounced all worldly dignities and possessions, bound themselves to the journey to Palestine, to perpetual chastity and poverty, and to receive no stipend for their clerical functions. These vows were renewed annually in the same place while they remained in France to complete their theological studies and receive their degrees. Three more were added to the little band before Ignatius left Paris for Spain in March, 1535; and when on Jan. 6, 1537, they met in Venice, their number was increased to 13. Ignatius having incurred the resentment of Cardinal Caraffa, afterward Pope Paul IV., and not daring to visit Rome himself to solicit the pope's consent to their going to Palestine and his approval of their labors in that country, Lefèvre and the others undertook the journey to Rome amid great hardships. They were well received by Paul III., who, hearing that they were graduates of the university of Paris, made them discuss theological questions in his presence with the most learned Italians in Rome. After learning their manner of life, he approved of their project, gave them money for their expenses, and permission to receive holy orders forthwith. But, as the war between Venice and Turkey rendered the voyage to Palestine impossible, they spread themselves throughout the peninsula after their ordination, Ignatius, Lefèvre, and Laynez going to Rome in November, 1537. He now bade them say, when asked who they were, that they belonged to the *compagnia di Gesù*. The pope appointed Lefèvre and Laynez to chairs of theology in the university of Sapienza at Rome, and Ignatius occupied himself in directing persons who wished to perform his "Spiritual Exercises." All of them embraced every opportunity of assembling and catechizing the Roman children. In March, 1538, all the companions were summoned to Rome for the purpose of deliberating on the erection of the company into a religious order. But a formidable obstacle was raised by the renewal before the inquisitors of Venice and Rome of the charge of heresy formerly made against Ignatius in Spain and in Paris. He boldly went himself to the pope, and related to him the whole story of these inquisitorial persecutions, and demanded that an ordinary judge should be instantly appointed to inquire into the matter and decide without delay. To this the pope assented, and a solemn sentence acquitting Ignatius and his followers was issued Nov. 18, 1538. The pope, who recognized the importance of the service which the association could render in counteracting the spirit of Protestantism, immediately commanded schools to be opened throughout the city in which Ig-

natus and his associates might teach the elements of Christian doctrine. At the same time a fearful famine in Rome afforded them the opportunity of displaying their charity. The pope would not have hesitated to recognize them at once as a religious order, had it not been that a commission appointed that very year to inquire into clerical abuses and scandals had presented to him a report discountenancing the establishment of new religious orders. Nevertheless, Ignatius and his companions began their deliberations in the first days of April, 1539, and a sketch of the proposed constitutions in five chapters was subscribed by all on May 4, and presented to the pope. The master of the sacred palace having reported favorably on this sketch, it was approved orally Sept. 3. Meanwhile these outlines were committed for thorough examination to three cardinals, among whom Cardinal Guidiccioni was so opposed to the introduction of new orders that he would not at first even read the sketch. At length having done so, he changed his mind, won over his colleagues to his opinion, and the bull of confirmation, *Regimini militantis ecclesie*, was signed Sept. 27, 1540, and promulgated in the spring of 1541. It restricted the number of "professed" members to 60; but this restriction was removed, March 14, 1548. A written promise of entering the company after its confirmation by the pope had been signed by 11 of the members, including Ignatius, on April 15, 1539. After their deliberations closed on May 4, most of them were sent by the pope on various missions. Codure, Le Jay, Ignatius, and Francis Xavier remained in Rome, Xavier being secretary and keeping up the correspondence with the absent members. On March 15, 1540, Ignatius informed Xavier that he was to leave Rome the next day for Lisbon and the East Indies. At the same time the pope destined others for Ireland in order to counteract there the measures of Henry VIII. At the Easter of 1541 Ignatius was unanimously chosen general, those absent from Rome sending their votes in writing, and he entered on the office April 13. In conformity with the will of the pope and the wish of his companions, he now began to draw up constitutions for the new order. He had read previously the lives of the founders of religious orders, as well as the rules which they had framed for their followers; but while engaged in framing the constitutions of the society, he shut himself up, with no books near him save the Bible and the "Imitation of Christ," preparing himself before he wrote by prayer and meditation, then placing what he had written upon the altar during mass, and only consulting with the other fathers when he had well considered each matter himself and come to some decision. These constitutions, drawn up in Spanish, and translated into Latin under the eyes of Ignatius, received high praise from Cardinal Richelieu. They are now accessible to all (*Institutum Societatis Jesu*, 2 vols., Avignon, 1827-'38, a reprint from the

official edition of Prague, 2 vols., 1757). It was only in 1550 that they were so far complete that Ignatius could communicate them to an assembly of the professed who had been summoned to Rome, including Laynez and Francis Borgia. He wished his work to be suitable for all without distinction, so that the difference of countries and nations, of manners and dispositions, should require neither exceptions nor dispensations. He also submitted the constitutions to the judgment of the absent. They were examined with the most minute attention, and were only published when every correction or addition suggested and deemed necessary had been made. In 1553 they were sent upon trial to Spain, Portugal, and other countries, in order that they should be approved by the whole body only when found everywhere to be in perfect accordance with the design of the society. This sanction of the whole body was not given to them till 1558, after the death of Ignatius, and in the congregation assembled to choose his successor. They were revised with the utmost care, and confirmed with unanimity. They were then presented to Pope Paul IV., who appointed a commission of four cardinals to examine them. These approved the constitutions unanimously, and the pope confirmed them without changing a single word. Laynez added nothing to them, nor is it on record that he had any more to do with the framing of them than any other of the members consulted by Ignatius.—The kernel or indestructible portion of these constitutions is found in the draft presented to Paul III. and first approved by him. In this it is said that "whoever wishes to enter the society of Jesus, to fight under the standard of the cross and of God and our Lord Jesus Christ, and to serve the church his spouse under his vicar the Roman pontiff, must keep in mind that this society has been established for the defence and propagation of the faith, for promoting the salvation of souls, by teaching Christian doctrine and Christian life, by explaining the word of God, by giving the 'Spiritual Exercises,' by teaching catechism to the young and ignorant, by the administration of the sacraments, and especially the sacrament of penance. He must keep also in mind that its object is to perform works of mercy, more particularly for the sick and the imprisoned; and all this is to be done gratuitously and without any earthly compensation." The constitutions are divided into 10 parts. The 1st describes the qualities which allow or forbid the admission to noviceship; the 2d, the causes and manner of rejection; the 3d and 4th relate to health, devotion, and study; the 5th explains the profession of the four vows and the inferior degrees; the 6th and 7th instruct the professed and spiritual coadjutors in their various offices; the 8th and 9th concern the general, his election, authority, and duties; the 10th gives general directions for the conservation and increase of the society. The greatest discrimination is used in the choice

of candidates for membership. Some circumstances or qualities form absolute impediments to admission, such as illegitimate birth or infamous descent, public heresy or apostasy, such crimes as murder or enormous secret sins, the brand of a degrading judicial sentence, matrimonial ties, membership even for one day in another religious order, and insanity or notable weakness of intellect. Less serious impediments, such as ill temper, obstinacy, injudicious enthusiasm or visionary devotion, the being involved in debt, &c., may be compensated by other redeeming qualities and circumstances. The first probation consists of a period of some weeks spent by the candidate in a house of the society, during which he is given to read the *Examen Generale*, taken from the first part of the constitution, containing a series of questions, which he is required to answer truthfully. His examiner is bound to the strictest secrecy as to the answers. These questions involve every possible impediment to his admission. He is required also to declare if he is perfectly free in his determination to enter, or if he is led to do so by friendship for any member of the society. He is finally asked if he is willing that all letters written by him or addressed to him shall be opened by the superior; if he consents that the superior shall admonish him of all imperfections and faults which he may remark in him, and that his companions shall report the same to the superior; and, finally, if he will be content to accept any grade, occupation, or office in the society which may be assigned to him. The candidate, having waived his natural rights on these points, is admitted to his second probation or noviceship, which lasts two years and one day from the date of his first entrance. During the first year the novices devote a full month to the performance of the "Spiritual Exercises," which they are required to master as an indispensable instrument of future utility to others. The whole two years are given up to spiritual things. They teach the elements of Christian doctrine to children and the poor, serve the sick for a month in some hospital, and travel during another month from place to place without money, and subsisting on the charity received by the way. They have also daily conferences or lessons on the constitutions and rules of the society. The severest scrutiny is exercised with regard to the capacity and dispositions of each novice, and every means is employed to encourage him to correct what is faulty and to perfect what is praiseworthy in his conduct. Such as are destined for the priesthood are called "scholastic novices;" the others, who are to be lay brothers, are not allowed to rise any further in secular knowledge. They must be content with what they already possess, and apply themselves to the acquisition of humility and solid piety. At the end of these two years, the novices pronounce the simple vows of poverty, chastity, and obedience, with a formal promise to enter the society at a future

day, implying an engagement to accept readily any degree which may be given them therein. Such as are destined to study now assume the name of formed scholastics (*scholastici formati*). If they are young enough, a space of two years, called juniorship or juvenate, is spent by them in cultivating Latin and Greek letters and rhetoric; then three years are given in a scholasticate to mental and moral philosophy and the sciences. The professors in these special seminaries are all men who have themselves passed through the entire curriculum of sacred and profane science, and have either made the profession of the four vows, or are destined to do so in due time. Every six months the scholastics undergo a most searching examination before four sworn examiners, who send separately their sealed suffrages to the general and the local provincial. At the end of the philosophical course the scholastic is sent to teach in a college, both for the purpose of enabling him to apply his acquired knowledge and of training him to the science of governing men. Should his age permit, he begins with the lowest grammar and leads his scholars up to humanities and rhetoric. This is called by the French *cours de rigence*, and is followed by the study of theology, Scripture, canon law, and church history, which lasts four years. The half-yearly examination here becomes still more rigorous, and at the end of the third year it is increased in length and severity. Should the candidate break down in this he is not allowed to proceed in his fourth year of study. At the end of the third year the scholastics are raised to the priesthood. The fourth year closes with the *examen ad gradum*, or the examination which qualifies the successful candidate for the profession of the four vows, the highest rank in the society. Three months in advance of the day appointed for this, the candidate is given a series of theses embracing the substance of dogmatical theology, intellectual philosophy, and the natural sciences. He is freed from every other occupation in order thoroughly to prepare himself for the ordeal. The examination takes place before a commission of four examiners presided over by the rector, and lasts two hours, each examiner being bound by his oath to propound the most searching questions and formidable objections during half an hour. The suffrage, delivered sealed to the general and the provincial, attests that the "candidate is (or is not) able to teach the whole of theology, philosophy, and the sciences in any university." This intellectual ordeal is one regular condition for obtaining the degree of *profesus*; the other and a more indispensable condition is proficiency in solid virtue as well as in learning. Sometimes young men of extraordinary eloquence are allowed, after passing this last examination, to spend two years more in Biblical and patristic studies. Generally, however, they pass from the theologate to what is known as the third "probation," which is a

entire year spent in a special establishment and under a master thoroughly versed in asceticism and a knowledge of the constitutions of the society. Their exercises are substantially those of noviceship or second probation, a full month being devoted to the "Spiritual Exercises," another to pilgrimage, and a third to giving retreats or missions. This year St. Ignatius called the "school of the heart." When the special informations sent to the general concerning the probationists assure him that they possess that superiority in virtue and science required by the constitutions, he awards them their degree of professed of the four vows. Throughout this protracted course of studies and probation, every precaution is taken that the mind shall not be diverted from the object of study, that the bodily health shall not be injured by intense mental application, and that the springs of piety in the soul shall not be dried up by the exclusive culture of the intellect. The establishments in which the young Jesuits are trained are allowed by Ignatius to receive endowments, or they are supported by taxes levied on all the houses of the province, or, in some instances, wealthy novices are allowed to retain the possession of their property, but not the disposal of their revenues, until their studies and probation are ended, and thus to pay their own expenses. But in no case are they allowed to seek outside of the house for alms, or to be turned away in any manner from their studies. The members of the society who have taken their final vows, *socii formati*, are distinguished into three classes, the professed, the spiritual coadjutors, and lay brothers, or temporal coadjutors. The degree of professed of three vows is an honorary distinction bestowed for some signal service or great quality on priests who do not possess the regular theological or scientific attainments required for the profession of the four vows; this distinction enables its subject to rank with the latter, but not to hold the offices reserved to them, such as those of general, provincial, and elector in a general congregation. The "professed society" (*societas professa*) constitutes the core of the whole body; the coadjutors, both spiritual and temporal, are only auxiliaries or helpers. To the professed society belong the colleges, seminaries, houses, and residences of the order, together with all other property whatsoever, movable and immovable; and it is in its name that this property is held and administered by the coadjutors. In ordinary life the professed are not distinguished from the spiritual coadjutors. The latter are appointed in preference to the government of lay colleges and seminaries, to superiorships in residences, &c.; while the professed are left free to preach, or to teach the higher branches of sacred and profane science, and it is only by certain reserved occupations and functions that their rank is known to the majority of their brethren.—The whole order is divided into assistancies, of which there are

at present five, distributed according to the foremost European races or languages, namely, those of Italy, Spain, France, Germany, and England. The original assistancy of Portugal has been abolished since the total extinction of the society in that country, and that of England has been recently created. Each assistancy embraces several provinces and missions. A province comprises one or more colleges, a novitiate, scholasticate, and residences with a stated number of professed. It has a certain autonomy, and depends on the general only in the measure prescribed by the constitutions. At the head of the order is a general (*praepositus generalis*), who is elected for life in a general congregation composed of the provincials and two delegates from each province. They elect at the same time the five assistants who form his council, the secretary of the society, and an admonitor, whose duty it is to observe the conduct and actions of the general and to admonish him when necessary. If they see in his conduct anything censurable, they must lay their observations before him; and in a case of great urgency or visible scandal, the assistants can summon without his assent a general congregation, or even depose him themselves, after obtaining by letter the suffrages of the provincials. The power of the general, so long as he acts within the limits of the constitutions, is very great. He appoints the provincials, rectors of colleges, scholasticates, and novitiates, the superiors of professed houses and residences, together with the executive officer in each house, called minister; these are properly denominated superiors, and have a right to command. The inferior officers are nominated by the provincial with the approbation of the general. Every provincial, rector, and superior has his council of four consultors and his admonitor. The provincial is required to report every month to the general; the other superiors report every three months. The consultors, both provincial and local, are bound to report separately at stated times. Every three years deputies elected by the provincial congregations meet in Rome or wherever the general resides. They compose what is called the "congregation of procurators," and one of their chief functions is to decide on the necessity of convening a general congregation. They also bear to the general from each province a complete catalogue of its members, detailing the conduct and capacity of each. In the general congregation resides the supreme legislative power. The provincial congregation is composed of the provincial, rectors, and senior professed members. The term of office for all superiors below the general is three years. Provincials visit every house in their jurisdiction once a year, to see that the constitutions are exactly observed by all. During this visitation rigorous inquiry is made into the temporal and spiritual welfare of each house. Every member, beginning with the rector or superior, has to render to the provincial a full account of



his conscience, of his temptations and trials, and the difficulties he meets with in the performance of his special office. This "manifestation of conscience," whether made in sacramental confession or not, obliges the provincial to the most inviolable secrecy. He can only make of the knowledge thus acquired the use which the inferior permits him. At the same time the latter is informed of the defects which have been remarked in his conduct. This practice is one of the fundamental points or *substantialia* of the constitutions, and contributes above all others to give to the government of the society its extraordinary power, as well as to make obedience easy. Another chief object of this yearly visitation is to correct every abuse in the matter of poverty. Obedience and dependent poverty are the two mainsprings of the order. One of the vows made at the time of the solemn profession binds the professed to maintain the obligations of poverty inviolable, or to make them more rigorous. The rectors and local superiors yearly demand the same "account of conscience" of their subjects; and as all who have not pronounced their last solemn vows renew their simple vows twice a year, this renewal affords a fitting opportunity for repairing every violation of religious poverty. Before the time of Ignatius one year's novitiate only was required before admission to membership in a religious order, and the emission of the solemn religious vows. In his constitutions, besides a novitiate of two full years, he demanded a further probation of several years before any one was admitted to final membership. Thus there are three kinds of vows made by Jesuits to the society: the simple vows made at the end of the novitiate, and renewed every six months, but not accepted by the society; the simple but final vows made by the coadjutors, both temporal and spiritual, when they are solemnly admitted into the society, which accepts them by the hands of the local superior; and the solemn vows made by the professed. The fourth solemn vow is to the pope, and binds the Jesuit to go wherever the former may send him for the service of the church. The professed, besides these four which are made publicly in the church, pronounce in private immediately afterward a formula containing several simple vows, among them one binding them neither to seek nor to accept any dignity or office in the society or in the church, and to denounce all of their brethren whom they know to be seeking them. The society of Jesus never admitted a third order, like the Dominicans and Franciscans; and St. Ignatius inflexibly refused not only to allow nuns to have any fellowship with the society, but to permit its members to be cumbered with the direction of nuns. There never has been any body of men or women directly or indirectly affiliated to the Jesuits. The dress adopted by St. Ignatius and his companions was that of the better class of Spanish secular priests. It con-

sists in a black cassock and cloak, and has been somewhat modified in various provinces. Two popes (Paul IV. and Pius V.) and one general (Francis Borgia) wished to assimilate the Jesuits in some points more to the other religious orders, in particular by introducing the observance of the canonical hours; but this was soon given up, and the whole energy of the order was directed to laboring in behalf of the church by means of education and missions. As the "Spiritual Exercises" of St. Ignatius moulded not only his own religious character and that of his early companions, but the spirit of the society, it is impossible to understand either its constitutions or the private and public life of its members, without having some conception of the nature and aim of that famous book. It is not a book to be merely read; for it contains only germs of thought and rude outlines of meditations on the great Christian truths and facts of gospel history. The "exercises" consist in a graduated series of meditations on the creation and destiny of man; on the degradation and misery wrought by sin; on the restoration of the fallen children of God to their true rank in Christ, and the manifestation of true heroism in following him in poverty, toil, humiliation, suffering, and death. The meditations are intermingled with practical rules for examining one's conscience, for the prudent use of penitential austerities, for detecting and resisting temptations, for discovering the action of the good spirit on one's soul from that of the evil one, for making a safe election in determining one's calling in life, for a right distribution of alms, for moderating one's appetite in eating and drinking, and finally for conforming one's judgment to that of the church. These exercises, when fully performed in retirement, last over a month, and are divided into four stages or "weeks." In the first, the truth of God's right over man's being, faculties, and life is made the foundation of all the subsequent exercises, and a practical "indifference" in the use of all things, states, and conditions of life is inculcated as a necessary conclusion from the fact that wealth and poverty, health and sickness, are only means to an end, and in themselves indifferent. The foundation of religious poverty and self-renunciation is thus laid at the very outset. Then come the meditations on sin and its punishments in time and eternity, terminating with the contemplation of Christ crucified, and the mingled sentiments of grief and love, shame and generosity, inspired by the consciousness of one's own guilt in presence of the divine victim of sin. Next comes the meditation of Christ our king as the model of the generosity to be thenceforth displayed in serving God. Ignatius proposes here the conception formed at Manresa, when he had renounced the secular militia for a life of spiritual chivalry. Christ presents himself as a king inviting all his subjects to aid him in subjecting the whole earth to God, asking none to follow where he

does not lead himself, and promising certain victory with a fellowship in glory after a fellowship in toil and danger. The offer to follow Christ, not as the crowd may, but in the foremost ranks of those who shall wear his livery and share his poverty and privations, lays the foundation of what Ignatius conceives to be the apostolic virtues. These dispositions are fostered and continually increased by the meditations which follow on the incarnation, the nativity, the flight into Egypt, the private life of Christ at Nazareth, and the labors of his public career. In the midst of these meditations come the exercises known as the "three degrees of humility" and the "three classes of men," the whole drift of which is to raise the spiritual enthusiasm or generosity of the soul to the point of resolving to leave all to follow Christ in shame and suffering, and be content only when it has embraced what is most repugnant to flesh and blood and the judgment of the world. This resolution is still further intensified and confirmed by the meditations on Christ crucified which occupy the third week; and the meditations on the resurrection and the life of Christ with his apostles and disciples until his ascension are destined to set forth a perfect model of the sweetness to be enjoyed in Christ's company, in such a society as Ignatius contemplated.—The society spread with unparalleled rapidity, so that it was said to have had no period of youth. At the death of Ignatius there were 1,000 members in 12 provinces; soon after the death of Acquaviva, in 1615, 18,000 members in 32 provinces; in 1749, 24 professed houses, 669 colleges, 176 seminaries, 61 novitiates, 385 residences, 273 missions in Protestant and pagan countries, and about 22,600 members. In Portugal it was introduced as early as 1540 by St. Francis Xavier and Rodriguez, who found a zealous patron in King John III. Rodriguez established a college at Coimbra, which in 1544 counted 60 members. A considerable number of young noblemen prayed for admission, and thus the order soon became influential. King John appointed at the same time two Jesuits to be judges of the inquisition, but Ignatius forbade them to accept the office. "For," said he, "the society has for its mission the assistance of our neighbor by preaching and the duties of the confessional; moreover, it were undesirable that its members had power to punish heretics with death. On the contrary, their duty is to console with priestly kindness these unfortunate men." In Spain the Jesuits had at first to overcome the opposition of several bishops, but the patronage of Francis Borgia, at that time governor of Barcelona, soon procured for them a favorable reception and a number of houses and colleges, and at the university of Salamanca they received some of the theological chairs. In France, where they likewise appeared as early as 1540, they met with a very decided resistance on the part of the parliament, the university of Paris,

and many bishops. They could not secure a legal existence until 1562, when they were recognized as "fathers of the college of Clermont." The parliament at first refused to register the royal patent, but had at length to yield to the order of the king. They were unable, however, to overcome the opposition of the parliament and the Sorbonne. When Châtel, who had studied in one of their colleges, made an attempt against the life of Henry IV., they were expelled from France by a decree of the parliament in 1594, and Père Guignard, who was accused of having approved the attempt of assassination, was put to death. Henry IV. himself recalled them in 1603, and from that year they remained in the undisturbed possession of their property. They enjoyed the confidence of Louis XIII., Cardinal Richelieu, and Louis XIV., and were the principal combatants against the doctrines of the Jansenists. Their colleges were very numerous, and among their pupils were Descartes, Bossuet, Corneille, Voltaire, and the astronomer Lalande. Two Jesuits were sent to Ireland as papal nuncios in the reign of Henry VIII. Elizabeth expelled them from her dominions, and forbade them upon penalty of death to return. We find them, nevertheless, again as missionaries in the reign of James I., and after the discovery of the gunpowder plot (1605) Father Garnet, to whom the plot had been communicated by his subordinate in an "account of conscience," was put to death. In 1678 Titus Oates charged them with having entered into a conspiracy against Charles II. and the state, in consequence of which six Jesuits were put to death. In spite of several decrees against the public exercise of the Roman Catholic religion in England in general and the residence of Jesuits in particular, the society maintained itself there, although it never became very numerous. The Jesuits first appeared in Germany about 1549, at the instance of Duke William of Bavaria and of Ferdinand I. of Austria; Salmeron and Peter Canisius being appointed professors of theology in the university of Ingolstadt, and others at Prague. The society received chairs in the colleges at Cologne (1556), Munich (1559), Treves (1561), Augsburg (1563), and several other places. In Italy they spread more rapidly and more extensively than in any other country. They were banished from Venice in 1606, and the popes did not succeed until 1657 in causing their restoration. One of the wars between France and Charles V., during which all Spaniards were ordered to leave France, brought some Jesuits to the Netherlands soon after the foundation of the society. They gained a firm footing under Philip II., although the bishops showed them less favor than in other countries. In Transylvania they were favored by Prince Christopher Báthori and his son and successor Sigismund, but the assembly of the states compelled the latter prince in 1588 to sign a decree of banishment. They became very numerous in Poland, which they divided be-

fore the end of the 16th century into two provinces, and where they had houses and colleges in 20 towns. In Sweden they made great efforts, under John III. and Sigismund, to restore the sway of the Roman Catholic church, but the dethronement of Sigismund in 1604 destroyed their hopes. In Russia favorable prospects seemed to open for them with the reign of Pseudo-Demetrius, but the fall of this prince involved that of the Jesuits.—The missionary activity of the Jesuits among the pagans commenced in 1541, the year after the foundation of the order. Francis Xavier sailed in that year to the East Indies, founded a college at Goa, preached in Travancore, Malacca, Macassar, the islands, and Japan, and baptized a vast number of pagans. Other members of the order preached in Madura, Ceylon, and many other places, and the Christian population of their missions in India rose to 100,000. Some members of the society, especially Robert de' Nobili, appeared as Brahmans, and tried to excel the Hindoo Brahmans as sages and penitents, regarding this as the most efficient means of obtaining the confidence of the Hindoo population. The mission in Japan was commenced by Francis Xavier in 1549; several princes were converted, and some natives were received into the society. In 1613 the Portuguese Jesuits had in Japan two colleges, eight residences, and three professed houses; but the persecution which soon after broke out against the Catholics put an end to their establishments. Their last member, a native of Japan, was put to death in 1636. Father Rogorius penetrated into China in 1584, disguised as a merchant. Ricci established a reputation as one of the best Chinese scholars. Others became the teachers and ministers of several emperors. In 1692 they obtained a decree by which Christianity was declared to be a sacred law and the missionaries virtuous men. The number of converts was very large, and amounted in the province of Kiangsu alone to 100,000. But a controversy with several other orders on the conformity of the Jesuits to the pagan customs in China and India was decided by the pope against the Jesuits, and proved a fatal blow to the prosperity of their missions in these countries. Cochin China (1614) and Tonquin (1627) became likewise missionary fields for Jesuits; the congregations in Tonquin in 1640 numbered 100,000 members, but they were cruelly persecuted. The most celebrated of the Jesuit missions was that established in Paraguay, where they Christianized and civilized an Indian population of from 100,000 to 200,000 souls. With the consent of the Spanish authorities they retained the civil dominion over the Indians, and their principles of government have been commended by many who in other respects were their opponents, as Montesquieu, Muratori, and Southey; while many of their admirers have represented Paraguay under the sway of the Jesuits as more free from vice and corruption than any other state of modern times. The prosperity of these missions was interrupted in 1750, when Spain ceded seven parishes to Portugal, and the Indians, with an army of 14,000 men, resisted the execution of this project. After some time, however, the former state of things and the dominion of the Jesuits were restored, both of which continued until the suppression of the order in Spain. In 1566 they were sent to Florida, which in the following year was formed into a vice province of the order, and a school for the children of the Florida Indians was commenced in Havana (1568). On the invitation of a Virginian chief, called by the Spaniards Don Luis, Father Segura, the vice provincial, with seven members of the order and some Indian youths who had been educated at Havana, undertook to establish a new mission on the banks of the Chesapeake, or St. Mary's bay. But the Indian proved to be a traitor, and Father Segura with all his companions except one lost their lives (1570). This led the Jesuits to abandon Florida for Mexico. The first mission of the Jesuits in California was established by Father Eusebio Kuhn or Kino, in 1683; gradually they founded 16 missionary stations, each of which was generally directed by one missionary. They administered these missions until the suppression of the order in Spain and the Spanish possessions. In 1611 the Jesuits established their first mission in the French possessions in America. This mission was interrupted for a time by the English, who in 1629 took Quebec and carried off the missionaries; but their work was resumed in 1633, and for nearly half a century they wrestled with paganism in the northern wilds. Quebec remained their centre, whence Jesuit missionaries were sent far and wide. The most distant effort made by the Jesuits was a mission in Arkansas. When Louisiana was settled, Jesuits were sent from France to undertake missions on the lower Mississippi, but these missions were not subject to the superior at Quebec, but to another at New Orleans. After the restoration of the order, the Jesuits recommenced their missions among the Indians on the Missouri in 1684, which gradually extended over a number of tribes. In 1840 the mission in Oregon was commenced by Father de Smet, one of the most celebrated missionaries of the order in the present century. Other missions were established among the tribes near the Amazon river in Brazil (1549), Peru (1567), Mexico (1572), the Antilles (1700), Congo and Angola, on the W. coast of Africa (1560), and Turkey (1627), where they effected in particular the submission of many members of the eastern churches to the authority of the pope.—Toward the middle of the 18th century the prime ministers of Portugal (Pombal), Spain (Aranda), and France (Choiseul) resolved nearly at the same time upon the expulsion of the Jesuits from their countries. Pombal was incensed against them, ostensibly because he

l them of having instigated the Indi-  
araguay to resist the execution of the  
cession above mentioned. Soon after  
pt was made to assassinate Joseph  
, king of Portugal, and several Jesuits,  
rly Father Malagrida, were accused of  
een privy to the plot. Pombal re-  
he pope to take measures against the  
but as Clement XIII. took their de-  
royal edict of Sept. 3, 1759, declared  
ts to be traitors, suppressed the order  
gal, Brazil, and the other Portuguese  
and confiscated its property. All the  
iving in Portugal were transported to  
l States. In France they fell into dis-  
court when the two fathers who were  
ssors of Louis XV. and Mme. de Pom-  
refused to admit them to the sacra-  
the latter was dismissed from  
Mme. de Pompadour and Choiseul uni-  
influence with that of the parliament  
ess the order. At the same time its  
n among the people, which had long  
been injured by the lax contents of  
uit books of casuistry, suffered great-  
sequence of the unfortunate commer-  
ations of Lavalette, superior of an es-  
ent of the order in Martinique. La-  
peculated largely in colonial produce,  
n two of his ships were taken by the  
became a bankrupt. A firm in Mar-  
ought a suit for indemnification against  
le society, and the inferior courts as  
he parliament of Paris, to which the  
ppealed, gave sentence against them,  
le them pay 2,000,000 livres to the  
and the costs. Louis XV., who wished  
he society, at first yielded to the ur-  
s for its suppression only so far as to  
in Rome that the society be reformed,  
the French Jesuits be placed under a  
their own. To this demand the gen-  
ci, is reported to have given the fa-  
sponse: *Sint ut sunt, aut non sint*;  
on the king expelled them from France

Their expulsion from Spain was  
in 1767 by Aranda, on the charge,  
g to some historians, that treasonable  
had been discovered in one of the  
which declared the king a bastard  
entitled to the throne. But the true  
s not known, as the king declared  
kept the secret "locked up in his  
art." On April 2 all the Jesuits of  
d the Spanish colonies were arrested  
me hour, and shipped to the territory  
pe, who, at the request of the general  
der, refused to receive them. At the  
e, and in a similar way, the order was  
ed in Naples, Parma, and Malta. On  
1768, all the Bourbon courts (France,  
Naples, and Parma) demanded from  
: its entire suppression for the whole

Shortly afterward the pope died  
nd the Bourbon courts succeeded in  
g the election of Clement XIV. (Gan-

ganelli), who had given to the minister of  
Spain a written declaration that a pope, with-  
out acting against the canonical laws, was at  
liberty to suppress the order. For four years  
Clement XIV. endeavored to put off an event  
from which he feared the worst consequences;  
but at length, when also the court of Vienna  
consented to the suppression of the Jesuits,  
he issued, July 21, 1773, the famous brief, *Do-  
minus ac Redemptor noster*, by which the  
suppression of the society of Jesus in all the  
states of Christendom was declared. The brief,  
though not signed or published with the usual  
canonical formalities, was quickly complied  
with; yet the archives and treasures found in  
searching their houses did not equal in impor-  
tance and amount the public anticipation. The  
ex-Jesuits had the choice either to enter other  
religious orders or to place themselves under  
the jurisdiction of the bishops. Everywhere,  
except in Portugal, they received an annuity  
from the proceeds of their confiscated property.  
In Rome and the Papal States the colleges and  
houses of the suppressed society were intrusted  
to secular priests, who employed many of the  
former professors, and kept up the method and  
discipline of their schools. A general resis-  
tance to the brief of suppression had been ex-  
pected from the Jesuits and their many power-  
ful friends; and in anticipation of this, as  
well as to secure possession of the large funds  
supposed to be hoarded up in their houses at  
Rome, the general, Lorenzo Ricci, was imprison-  
ed in the castle of Sant' Angelo. The members  
of the order, however, submitted everywhere  
without hesitation to the pontifical will, Ricci  
did nothing to incite resistance, and the mi-  
nutest search discovered no treasures. Ricci  
on his deathbed, in November, 1775, as he was  
about to receive the sacrament, read a solemn  
protest on the part of the extinct society,  
affirming that the conduct of its members  
afforded no grounds for the suppression, and  
that he had himself given no reason for his  
imprisonment. In Prussia, although they had  
to abandon the constitution of the order (1776),  
the favor of Frederick II., who esteemed them  
as teachers, permitted them to continue as an  
organized society, under the name of priests  
of the royal school institute; but this institute  
also was abolished by Frederick William II.  
In Russia, which with the eastern part of Po-  
land had received in 1772 several houses of  
Jesuits, they enjoyed the patronage of the em-  
press Catharine II., who appointed an ex-Jesuit  
coadjutor of the archbishop of Mohilev, and  
sent him in 1783 as her minister to Rome.  
He urged Pius VI. to recognize the society as  
validly existing in Russia, and Pius, moved by  
the memoir presented to him by Cardinal Al-  
bani, as well as by the opinion prevalent in the  
college of cardinals, that the brief of Clement  
XIV. was uncanonical, granted to the Russian  
Jesuits permission to elect a vicar general. The  
number of Jesuits in Russia amounted at that  
time to 178, and the total number of ex-Jesuits

was estimated at about 9,000. Attempts to restore the order under other names were made in 1794, when the ex-Jesuits De Broglie and De Tournely founded the "Society of the Sacred Heart," and in 1798, when Paccanari founded the "Society of the Faith of Jesus," known as *pères de la foi*. This latter organization, in spite of the defection of its founder, maintained its existence, and its members formed the nucleus of the restored society in France. The prospects of restoration dawned with the pontificate of Pius VII. (1800). Solicited by Ferdinand IV., he authorized in 1804 the introduction of the order into the kingdom of the Two Sicilies; and on Aug. 7, 1814, he issued the bull of restoration. The vicar general of Russia, Brzozowski, was recognized in Rome as general. At his death an attempt was made to have the constitutions changed in such a way as to suit the altered circumstances of society. At the head of the influential persons who originated and actively favored this scheme was Cardinal della Genga, soon to be Pope Leo XII. The vicar general appointed to govern the order during the interim was drawn into the scheme, and despatched couriers with sealed orders to the electors already on their way to Rome, commanding them to proceed no further on their journey. The assistant of France, De Rozaven, in the name of his colleagues, issued a counter order, enjoining on the deputies to hasten to Rome. Not one failed to be there on the appointed day, and the first act of the congregation was to decree the expulsion of the vicar general and his associates in the order, among whom was the celebrated Padre Ventura, afterward the uncompromising opponent of the Jesuits. Aloisio Fortis was elected general, Oct. 18, 1822, and took up his residence at the Gesù in Rome. Cardinal della Genga succeeded Pius VII. Sept. 28, 1823, and his election filled the Jesuits with alarm; but the new pope on his way to St. John Lateran descended from his chair of state in front of the Gesù, to bless the general and his household. In 1824 the Jesuits received the direction of the Roman college, and in 1836, under Gregory XVI., of the college of the propaganda. As no Jesuits were allowed to occupy chairs in the latter, and the teaching was principally intrusted to their theological opponents, their connection with it became a source of such serious annoyance, that Pius IX. in 1850, at the petition of Father Roothaan, relieved them from this charge. In Modena, Sardinia, and Naples they were restored in 1815, and reinstated in the possession of a part or the whole of the former property of the order, and several new houses were established. They returned to Lombardy in 1837, to Parma and Venice in 1844, and to Tuscany (for a short time) in 1846. The revolution of 1848 endangered their existence in all Italy; mobs attacked their houses in Genoa and Naples, and they were expelled from nearly every state, even from the dominions of the pope. The general

found for some time a refuge in England. They returned after the success of the counter-revolution in 1849 to most states, except Sardinia and Tuscany, but were again expelled by the movements of 1859 from Lombardy, Parma, Modena, and the legations. In Naples the principal organ of the Jesuits, the *Civiltà Cattolica* of Rome, was prohibited in 1855 for having censured the government; but in 1859 they received from the latter new marks of confidence. In 1860 the progress of Garibaldi in Sicily and the Neapolitan provinces was attended by the expulsion of the Jesuits and the sequestration of their property. The establishment of the kingdom of Italy was the signal for the final suppression of the order in the peninsula. Pius IX., who was thought not to favor them in the beginning of his pontificate, gave them many proofs of special affection after his return from Gaëta. As province after province was taken from him, the Jesuits were driven from their houses. When Rome became the capital of Italy in 1870, the Italian parliament decreed the suppression of all religious orders and corporations. The houses destined as residences for the heads of these orders and their officers were at first reserved from the general decree; but in October, 1873, despite the efforts of the Italian ministry, these central residences were suppressed by the legislature, and no Jesuit at present legally exists in Rome or elsewhere in Italy. In Portugal, John VI. protested against their restoration; Dom Miguel admitted them by a decree of 1829, but Dom Pedro exiled them in 1834, since which time there have been no recognized communities of Jesuits in that country. In Spain, Ferdinand VII., after his restoration in 1814, put them in possession of all their former rights and property. They were banished again during the revolution of 1820, but restored with Ferdinand in 1823. In 1834 the ravages of the cholera were attributed to the poisoning of the wells by the Jesuits. The populace in consequence broke into the professed house and massacred the inmates. In 1835 Queen Christina was compelled to suppress the order, and in 1840 its last house at Loyola in Guipúzcoa, was dissolved by order of the provincial regency; but in 1844 they succeeded in establishing themselves again in the Spanish dominions. They were once more banished by Espartero in 1834, but were recalled by O'Donnell in 1858, at the instance of the emperor and empress of the French. They were intrusted with several colleges and seminaries, among others the university of Salamanca, and with important missions at Fernando Po and the Philippine islands; and a wider scope was allowed to their labors in Cuba and Porto Rico. Their numbers increased with astonishing rapidity, many novices from Portugal hastening to join them. But after the revolution of 1868 they were once more banished from Spain, and allowed only a precarious existence in her colonies. In France

during the reigns of Louis XVIII. and Charles X., they obtained only toleration, and eight of their colleges, with about 3,500 pupils, were closed in 1828 by order of the government. The revolution of July, 1830, banished them again "for ever" from France, notwithstanding which they were able to maintain themselves. In 1845 the chamber of deputies, with only a few dissenting votes, requested the government to have their houses closed; but no decree was issued against them, and after a brief interval they resumed their labors everywhere. In 1859 they there possessed 61 establishments in 38 dioceses. In 1866 they numbered in all 2,464, and in 1873 2,482, exclusive of the members belonging to the mission of New York and Canada. During the second empire the educational establishments of the French Jesuits entered into a successful competition with the university schools. Their special scientific school in Paris attained such eminence that the emperor was induced to give them the old collège St. Clément in Metz, where a second special school was established scarcely inferior to that of Paris. At the same time they accepted from the government the chaplaincy of the penal settlement of Cayenne, where the dreadful climate soon destroyed upward of 30 priests, and they multiplied their missionary colonies in Africa, Syria, Madagascar, India, and China. In the Netherlands King William I. permitted them to form establishments, and after the separation of Belgium from Holland they increased largely in the former. The Belgian province reckoned 643 members in 1873, and the province of Holland 813. The government of Austria admitted them into Galicia, which in 1820 was made a separate province of the order. The revolution of 1848 endangered their existence in Austria for a short time, but after 1849 their establishments increased rapidly. The government transferred to them seven of the state colleges, and intrusted to them one chair in the theological faculty of Vienna, and the entire theological faculty of the university of Innsbruck. The Austrian Jesuits at the present time (July, 1874) are threatened with suppression. The conversion of the duke of Anhalt-Köthen to the Roman Catholic church in 1825 was followed by the establishment of a mission of the Jesuits at Köthen, which existed till 1848. In the kingdom of Saxony they were expressly excluded from the country by a provision in the constitution of 1831. The events of 1848, which expelled them from so many countries, opened to them a wide field of action in many of the German states, where they were permitted, for the first time since their restoration, to hold missions for eight or more days. Many of the larger Protestant cities, as Berlin, heard on this occasion the preaching of the Jesuits for the first time. They were allowed to settle in Prussia, and in Westphalia and the province of the Rhine they founded within a short time a considerable number of establishments. During

the Franco-Prussian war of 1870-'71 the Jesuits distinguished themselves in the service of the sick and wounded, and several of them were decorated by the emperor William. But the active part taken by the theologians of the order in advocating and promoting the dogma of pontifical infallibility, and the coalition of the ultramontane deputies with the separatists in the Reichstag, aroused the suspicions of the German imperial government, and led finally to their suppression and their expulsion from the German empire in 1873. Of the two provinces of Germany and Galicia, the former numbered in that year 764, the latter 230 members. They were recalled to Switzerland as early as 1814 by the government of Valais, which also put them in possession of the former property of the order. In 1818 they founded a college at Fribourg, which soon became one of the most famous institutions of the order, and had numerous pupils (676 in 1845) from nearly every country of Europe. The decision of the grand council of Lucerne, in 1844, to call Jesuits to the chairs of the theological school and to one of the parish churches of the capital, greatly increased the excitement already existing against them in most of the Protestant cantons. Several incursions were made from other cantons to overthrow the local government in order to expel the Jesuits. They were however unsuccessful, and strengthened the separate alliance (*Sonderbund*) which the government of Lucerne had formed with six other cantons for the protection of what they considered their sovereign cantonal rights. In 1847 the federal diet demanded the dissolution of the *Sonderbund* and the removal of the Jesuits; the seven cantons refusing submission to this decree, war ensued, and ended in breaking up the alliance and the expulsion of the Jesuits, who have ever since been forbidden by the federal constitution to return. The Swiss constitution, as revised in 1874, rigorously excludes all religious corporations from the territory of the republic. In England, a rich Catholic, Thomas Weld of Lulworth castle, in 1799 gave to ex-members of the order Stonyhurst, which is still their largest establishment in that country. They conduct at present the colleges of Stonyhurst, near Whalley, Lancashire, Mount St. Mary's, near Chesterfield, and Beaumont Lodge, near Windsor, besides the scholasticate of St. Beuno's at St. Asaph. They possess several other flourishing establishments in England and Scotland, and maintain missions in Guiana and Jamaica. In Ireland they have, besides the well known college of Clongowes, others at Tullabeg, Dublin, Limerick, and Galway, and a novitiate at Miltown Park, Donnybrook. The Irish province has also missionary establishments in Melbourne, Australia. In Russia, where their college of Polotzk received in 1812 the rank of a university, they lost the favor of the emperor when several young noblemen, who had been their pupils, were received by them into the

Roman Catholic church. An imperial ukase of Jan. 1, 1816, closed their establishments at St. Petersburg and Moscow; and another of March 25, 1820, suppressed the order entirely in all Russia and Poland.—The Jesuits had accompanied Lord Baltimore when he sailed for the Chesapeake, and were the first religious instructors of the early Catholic settlers of Maryland, as well as of the neighboring Indian tribes. John Carroll, first archbishop of Baltimore, and some of his American fellow countrymen, were completing their "third probation" in Austria when the brief of suppression was issued. They hastened to America at the beginning of the revolutionary war, and continued to live in community until the restoration of the order. Since then their progress has been rapid. They are divided into two provinces and several important missions. The parent province of Maryland has establishments in the states of Massachusetts, Pennsylvania, Maryland, and Virginia, and the District of Columbia; the province of Missouri, founded by that of Maryland with the help of numerous recruits from Belgium and Holland, has establishments in the dioceses of St. Louis, Cincinnati, Chicago, and Milwaukee. The mission of New York, originally founded by the province of France, but now independent, embraces the whole state of New York and the Dominion of Canada, and has three colleges with a novitiate, several residences, and missionary establishments among the Indian tribes of Lake Superior. The mission of the province of Germany, recently organized for the benefit of the German population, possesses several houses in western New York and Ohio. The New Orleans mission, dependent on the province of Lyons, conducts three colleges and several flourishing houses in the dioceses of New Orleans and Mobile. The province of Naples has about 25 missionaries in New Mexico and Colorado, and the province of Turin 120 in California and among the Indians of the Rocky mountains. Their colleges in the United States are as follows: Boston college, South Boston, and college of the Holy Cross, Worcester, Mass.; of St. Francis Xavier, New York; St. John's, New York (Fordham); St. Joseph's, Philadelphia; St. John's, Frederick, Md.; Loyola, Baltimore; Gonzaga, Washington, D. C.; Georgetown, D. C.; Spring Hill, near Mobile, Ala.; St. Louis university, St. Louis, Mo.; college of the Immaculate Conception, New Orleans; St. Charles's, Grand Coteau, La.; St. Joseph's, Bardstown, Ky.; St. Xavier's, Cincinnati; St. Ignatius' college, San Francisco; and Santi Clara, Cal. In Canada, the Jesuits conduct St. Mary's college, Montreal, founded in 1848; and they have recently petitioned the Dominion parliament for a restoration to them of the estates owned by the order before its suppression in France and her colonies. The number of Jesuits in the United States and Canada at the present time (1874) is 1,062. In Mexico and the states of Central and South

America they have sometimes been admitted, sometimes again expelled, their fate being dependent on the success or defeat of the several political parties. They are now entirely expelled from the Mexican and Colombian republics. The prosperous seminaries which they directed in Guatemala were suppressed in 1873, and the Jesuits themselves compelled to leave the country. Missionary establishments had been also opened a few years ago in Ecuador, Peru, and the province of Maranhau, Brazil; but they were suppressed in 1874. In Chiá and Paraguay several establishments have been recently founded, all of which are subject to the same insecurity. Jesuits also now labor as missionaries among nearly all the non-Christian nations of the world, especially among the Indians of North America, in Turkey, in India, and China.—The number of Jesuits distributed through the five assistancies in 1873 was as follows: in the five dispersed provinces of the Italian assistancy—Rome 459, Naples 308, Sicily 206, Turin 301, and Venice 246; in the German assistancy—Austria 462, Belgium 642, Galicia 230, Germany 764, and Holland 313; in the French assistancy—Champagne 430, missions of New York and Canada 251, France 735, Lyons 722, Toulouse 595; in the dispersed Spanish assistancy—Aragon 560, Castile 784, Mexico 31; in the English assistancy—England 383, Ireland 183, Maryland 265, and Missouri 255. Total number of members, 9,266. Attached to the assistancy of Italy are the following missions: province of Rome, 80 members in Etruria, Emilia, and Brazil; province of Naples, 25 in New Mexico and Colorado; Turin, 120 in California and the Rocky mountains; Venice, 40 in Illyria, Dalmatia, and Venetia. German assistancy: Austria, 23 in South Australia; Belgium, 44 in Bengal; Germany, 52 in western New York, &c., 70 in Bombay, 31 in Brazil, and 15 in Java. French assistancy: Champagne, 31 in northern China; New York and Canada, 19 in Indian missions of Lake Superior; France, 16 in Cayenne and 86 in Nanking; Lyons, 72 in Algeria, 94 in New Orleans and gulf states, and 70 in Syria; Toulouse, 77 in the isle of Réunion and Madagascar, and 78 in Madura (India). English assistancy: England, 14 in Scotland, 13 in Guinea, and 17 in Jamaica; Ireland, 12 in Melbourne, Australia; Missouri, 13 among the Osages, and 22 among the Pottawattamie. In all, 1,774 missionaries.—The order has had since the foundation the following 23 generals, many of whom belong also to its most celebrated names: 1, Loyola, a Spaniard, 1541-'56; 2, Lainez, a Spaniard, 1558-'65; 3, Borgia, a Spaniard, 1565-'72; 4, Mercurian, a Belgian, 1572-'80; 5, Acquaviva, a Neapolitan, 1581-1615; 6, Vitelleschi, a Roman, 1615-'45; 7, Caraffa, a Neapolitan, 1646-'9; 8, Piccolomini, a Florentine, 1649-'51; 9, Gottofredi, a Roman, Jan. 31 to March 12, 1652; 10, Nickel, a German, 1653-'64; 11, Oliva, a Genoese; 1664-'81; 12, De Noyelle, a Belgian, 1682-'6; 13, Gonzalez, a

Spaniard, 1687-1705; 14, Tamburini, a Modenese, 1706-'30; 15, Retz, a Bohemian, 1730-'50; 16, Visconti, a Milanese, 1751-'5; 17, Centurioni, a Genoese, 1755-'7; 18, Ricci, a Florentine, 1758-'78, died in 1775; 19, Brzozowski, a Pole, 1814-'20; 20, Fortis, a Veronese, 1820-'29; 21, Roothaan, a Hollander, 1829-'53; 22, Beckx, a Belgian. Among the Jesuits who have been canonized or beatified, the most celebrated are Ignatius Loyola, Francis Xavier, Francis Borgia, Francis Regis, Aloysius Gonzaga, and Stanislas Kostka.—Before the suppression of the order, the Jesuits counted among their members some of the greatest scholars of Europe. The works of Petavius, Sirmond, Tursellinus, and Viger in classical literature, and of Tiraboschi in literary history, are still valued and used. Among the theologians and pulpit orators, Bellarmine, Pallavicini, Paolo Segneri, and Bourdaloue are especially distinguished. Since the restoration, Passaglia (who, however, left the order in 1858) and Perrone have gained the reputation of being among the principal theological writers of the Roman Catholic church, and Ravignan and Félix in France and Roh in Germany have been counted among the greatest Catholic pulpit orators. The most extensive literary work of the order is the *Acta Sanctorum* (Bollandist), commenced in the 17th century and still continued. Among its periodicals are the *Civiltà Cattolica*, semi-monthly, at Rome (which has the largest circulation of any theological publication of Italy); the *Précis historiques et littéraires*, semi-monthly, at Brussels; the *Études théologiques*, fortnightly, at Paris; "The Month," at London; and two published at Freiburg in Germany.—Several charges of complicity in the murder of princes have been brought against the Jesuits, some of which have been abandoned by all impartial historians, while all are contested. These charges are closely connected with the doctrine of the rightfulness of tyrannicide, which has been defended by several writers of the order. It is generally admitted that 14 Jesuits, viz., Sa, Tolet, Valentia, Delrio, Salas, Mariana, Heissius, Suarez, Lessius, Becan, Gretser, Tanner, Castro-Paolo, and Escobar, have maintained it. But on the other hand, it is alleged that this doctrine was one very common among the Roman Catholic theologians, and that even Thomas Aquinas taught it; that more than 60 Jesuits have written against it; and that those Jesuits who admit it, confine it to a few exceptional cases, and allow it to be committed only by a nation. Acquaviva, by a decree issued after the assassination of Henry IV., and dated July 6, 1610, forbade any member publicly or privately to uphold the doctrine that it is lawful for any one under any pretext of tyranny to attempt the life of any ruler. On other points of ethics members of the order have been accused of unsound principles even by certain Catholic writers, and some of the writings of Jesuits have been on this account censured by Rome. Concerning

this point the defence presents the same arguments as on the preceding, viz., that none of the censured doctrines were peculiar to the order or shared by all its members. The following passage in the constitution of the order has often been and is still construed by some writers as if it gave to the superiors of the order the right of obliging their inferiors to commit a sin: *Visum est nobis in Domino, excepto expresso voto quo societas summo pontifici pro tempore existenti tenetur, ac tribus aliis essentialibus paupertatis, castitatis, et obedientiæ, nullas constitutiones, declarationes, vel ordinem ullum vivendi posse obligationem ad peccatum mortale vel veniale inducere, nisi superior ea in nomine Domini nostri Jesu Christi, vel in virtute obedientiæ juberet.* But the Jesuits have proved this to be a mistranslation of the Latin and in conflict with others of their rules; the true sense of the passage being, that none of the rules of the order so bind the members that the non-observance by itself involves a sin, but that a sin is committed only when a member violates a special order of the superior. Several Protestant historians of note, as Ranke ("History of the Popes") and Reuchlin ("History of Port Royal"), who in the first editions of their works had followed the former interpretation, have changed their view in subsequent editions, and pronounced the interpretation which the order itself gives of it the true one.—Among the most important works on the history of the Jesuits are: *Historia Societatis Jesu*, from 1540 to 1625, by Orlandini, Sacchini, Passinus, and other members of the society; Wolf (adverse to the Jesuits), *Allgemeine Geschichte der Jesuiten* (4 vols., Leipsic, 1808), valuable for its complete bibliography; Crétineau-Joli, *Histoire religieuse, politique et littéraire de la compagnie de Jésus* (6 vols., Paris, 1844-'6); Gioberti (adverse to the Jesuits), *Il Gesuita moderno* (5 vols., Lausanne, 1847); A. Steinmetz, "History of the Jesuits" (3 vols., London, 1848); Abbé Guettée (Gallican), *Histoire des Jésuites* (2 vols., Paris, 1858-'9); Huber (Old Catholic), *Der Jesuiten-Orden* (Berlin, 1873). See also the "Institute of the Society of Jesus, approved by the Holy See," "Decrees of the General Congregations," and "Ordinances of the Superiors General," all which have been published; "Life and Institute of St. Ignatius Loyola," by Bartoli; *Documents authentiques, &c.*, by Carié de la Charie (Paris, 1827); and Ravignan's *L'Existence et l'Institut des Jésuites* (Paris, 1844), and *Clément XIII. et Clément XIV.* (2 vols. 8vo, 1854).

**JESUITS' BARK.** See CINCHONA.

**JESUS CHRIST** (Ἰησοῦς, the Greek form of the Hebrew Jeshua or Joshua, help of Jehovah, saviour; Χριστός, the Greek translation of the Hebrew Messiah, the anointed), the founder of the Christian religion, born in Bethlehem, a city of Judea, during the reign of the emperor Augustus, probably in the fourth year (or perhaps the sixth) before the Christian era, crucified in a locality of or near Jerusalem



called Golgotha, in the 34th or 35th year of his age. The 25th of December has been received and commemorated by the church in the festival of Christmas from the 4th century as the day of his birth, though this date was previously unsettled, and the opinions of the learned have always varied concerning it. His genealogy is traced from Abraham by St. Matthew, and from Adam by St. Luke, through the royal line of David; the two pedigrees, after David, are very different, and the discrepancies have been variously explained by Biblical critics. Nor are these the only debatable points in the Biblical narrative, the main parts of which are condensed in the following. His mother was Mary, who was betrothed to a carpenter named Joseph, when an angel announced to her: "The Holy Ghost shall come upon thee, and the power of the Highest shall overshadow thee;" accordingly "she was found with child of the Holy Ghost," and, as St. Matthew states, her husband "knew her not till she had brought forth her first-born son," who was named Jesus. Joseph and Mary resided in Nazareth, an obscure town in Lower Galilee, whence they went up to Bethlehem to be taxed, in compliance with a decree of Augustus, and because Joseph was of the house and lineage of David. It was there that the days were accomplished that she should be delivered, and the child was born, wrapped in swaddling clothes, and laid in a manger, the inn being full. His birth and Messianic dignity were revealed by angels to shepherds tending their flocks by night in the field, and they went in haste to Bethlehem to greet the babe. After 8 days he was circumcised; after 33 days he was presented in the temple at Jerusalem, when the aged Simeon took him in his arms, and blessed God that he had lived to see the Saviour; and soon after his birth, most probably while his parents remained in Bethlehem, three wise men (magi; according to ecclesiastical tradition, three kings) came from the East, guided by a star, and fell down before the young child, worshipped him, and presented to him gifts, gold, and frankincense, and myrrh. Their inquiries in Jerusalem had excited the suspicion of King Herod, who commanded them to bring him word when they had found the child. But the parents of Jesus, warned in a dream, fled with him to Egypt. Herod, to whom the wise men, by divine direction, had not returned, and who feared the loss of his throne if the Messiah were acknowledged, was greatly enraged, and, in order to secure the destruction of Jesus, gave orders that all the male children in and near Bethlehem, from two years old and under, should be put to death. After the death of Herod, a few months later, Jesus was brought by his parents to Nazareth. Of his early youth nothing more is known, except the summary statement of Luke that he waxed strong in spirit, was filled with wisdom, and the grace of God was upon him. When he was 12 years old

his parents took him with them to Jerusalem, to the feast of the passover. As they returned, he tarried behind without their knowledge; they retraced their steps in search of him, and after three days found him in the temple at Jerusalem, sitting in the midst of the doctors, hearing them and asking them questions, and astonishing them by his understanding and his answers. He returned to Nazareth with his parents, and was subject to them. Of the following 18 years, till the commencement of his public ministry, the canonical Gospels give no account. Various suppositions have been made to fill this gap in the narrative, as that he associated with learned Jews and studied the Greek authors; that in his 14th year he went with John the Baptist to Egypt, and was instructed for 16 years by Egyptian philosophers; that he was educated in the school of the Essenes (which is the oldest opinion); that he was a Nazarite; and that he belonged to the sect of the Sadducees. None of these hypotheses, however, rests upon any historical basis. It is more probable, as the gospel narrative intimates, that he followed the occupation of a carpenter, and, as the eldest son of the family, provided for its maintenance after Joseph's death. The apocryphal gospels give full but fanciful and often absurd narratives of this period, concerning which the four evangelists are silent. His appearance as a public teacher was heralded by John the Baptist, who admonished and warned the people, exhorting them to repentance, baptizing them in the Jordan, and announcing the approach of one mightier than himself, who should baptize with the Holy Ghost and with fire. It was probably in his 31st year that Jesus came to the Jordan at Bethabara to John, was recognized by him as the Messiah, and was baptized by him at his own command; and as he went up from the water a voice from heaven said: "This is my beloved Son, in whom I am well pleased." The events of his ministry, which is usually believed to have occupied about three years, are related by the evangelists, and have been arranged in chronological order (not in all cases with certainty) in harmonies of the Gospels. The public administration of baptism was followed immediately by the fast for 40 days in the wilderness, and the temptation by the devil. Directly after this he selected the first five or six of his twelve disciples, subsequently called apostles, and began to promulgate his doctrines, and to perform miracles. At a marriage in Cana of Galilee he changed water into wine to supply the guests. He attended a feast of the passover at Jerusalem, drove the traders out of the temple, and by his mighty works made many believe in his name. Passing from Judea to Galilee by way of Samaria, he announced himself as the Messiah to a Samaritan woman by Jacob's well at Sychar. Again in Cana he cured by a word a nobleman's son lying ill at Capernaum; in Nazareth he preached in the

synagogue, was scornfully rejected on account of his humble parentage and family connections, and took up his abode in Capernaum, where he healed a demoniac and other sick persons; on the sea of Galilee he lulled a tempest, and on the shores of the sea he performed many wonderful cures; and, as the number of those seeking help from him increased, he chose and ordained twelve disciples who should be with him continually. It was probably on another journey through Galilee that he delivered before a numerous concourse the sermon on the mount, in which he set forth the spirit of his doctrine, the conditions of participation in the kingdom of God, and gave in the Lord's prayer an example opposed to the long prayers of the Pharisees. He afterward healed the palsied servant of a centurion of Capernaum, and restored a widow's son at Nain to life. While performing such deeds as exemplifications and in attestation of his doctrines, the second feast of the passover came. He attended it, and gave occasion for the hostility of the Pharisees by healing on the sabbath day, at the pool of Bethesda, a man who had suffered from an infirmity for 38 years. Leaving Jerusalem for a third circuit in Galilee, he instructed and sent forth the twelve apostles, and miraculously fed 5,000 persons with five loaves and two small fishes. His numerous miraculous cures, and the increasing number of believers in him as the Messiah, deepened the enmity of the Pharisees, who sought to do violence to him. At this period the third passover in his ministry occurred. He, however, left Judea, and passed along the coasts of Tyre and Sidon, repeating his miracles. The transfiguration, the foreshadowing of his own sufferings, and the choice of 70 disciples, whom he sent two by two into all the places which he intended to visit, preceded his journey to Jerusalem to the feast of tabernacles. After his public teaching there, he went to Peræa; at Bethany he raised from the dead Lazarus, the brother of Martha and Mary, and on his way toward the capital he cured at Jericho blind Bartimæus. He made his entry into Jerusalem, riding on an ass, and was received in triumph by the people. Returning after a night spent in Bethany, he blighted with a word the barren fig tree, foiled the insidious attempt to ensnare him on the subject of tribute, and denounced their hypocrisy and the guilt and doom of the city. At the fourth and last feast of the passover with his disciples, he washed their feet as a lesson of love and humility; announced that on that night one of them would betray him, and designated Judas Iscariot as the traitor; and instituted the Lord's supper. Afterward with great agony of spirit he prayed in the garden of Gethsemane. Thither Judas came with an armed band, and betrayed to them the object of their search by saying, "Hail, master!" and kissing him. Refusing the offers of assistance, Jesus freely surrendered himself, when his disciples fled. He

was brought before the court of the sanhedrim; and as he did not deny that he was the Christ, the Son of God, he was adjudged guilty of blasphemy, and condemned to death. He was brought thence, on the charge of sedition, before the tribunal of Pontius Pilate, the Roman procurator of the province, who was induced by the clamor of the people and by threats to condemn him, although he declared him to be innocent. He was scourged, a scarlet robe and a crown of thorns were put on him in mockery, and he was led away to be crucified. At Golgotha (Calvary) vinegar mingled with gall was offered him to drink. He was crucified between two thieves, one of whom became penitent and was forgiven by the suffering Saviour. The cross on which he hung bore the inscription, in Hebrew, Greek, and Latin, "Jesus of Nazareth, the King of the Jews." He committed his mother to the care of his beloved disciple John, according to which evangelist his last words were, "It is finished." At his death the sun was darkened, the earth quaked, and the veil of the temple was rent in twain from the top to the bottom. In the evening came Joseph of Arimathea, a disciple of Christ, and begged the body and buried it. This was on the afternoon of Friday. On the third day, i. e., early on the morning of the day thence called the Lord's day, he rose from the dead; he appeared to his 11 remaining disciples, and to many others; remained with them 40 days, instructing them in the things pertaining to the kingdom of God, and blessing them; and then visibly ascended to heaven. His last charge to his disciples was to go and teach all nations, baptizing them in the name of the Father, and of the Son, and of the Holy Ghost.—The person and work of Jesus Christ have been the subject of extended discussion from many points of view. The *Lebensgeschichte Jesu* of J. J. Hess (Zürich, 1781) is one of the earlier general works on this subject. The "Life of Christ and the Lives of the Apostles, John the Baptist, and the Virgin Mary," by John Fleetwood (Glasgow, 1818; many times reprinted), attempts from the four gospel narratives to give the connected history. Mention may be made also of the "Life of the Saviour," by H. Ware, jr. (Boston, 1832; new ed., New York, 1868). The results of German rationalistic criticism appear in the works called *Das Leben Jesu*, by H. H. E. G. Paulus (Heidelberg, 1828), D. F. Strauss (Tübingen, 1835; revised and abridged in 1864; English translation, London, 1846), and C. F. von Ammon (Leipzig, 1842-'7). The work of Strauss, the most destructively critical of the three, made a great impression, and called out many replies. That of Karl Hase (Leipzig, 1829; English translation, Boston, 1860) was prior to it in date, and the ablest answer to Strauss was the work of J. A. W. Neander (Hamburg, 1837; English translation, New York, 1848), which was followed by those of J. P. Lange (Heidelberg, 1844-'5; English translation, Edinburgh, 1864), J. A. Dorner

(Berlin, 1845-'53), Schenckel (1864), and Keim (1867-'71). A humanitarian view is presented by W. H. Furness in "Jesus and his Biographers" (Philadelphia, 1838), and "Jesus" (1870). The *Vie de notre seigneur Jesus-Christ*, by the abbé Brispot (Paris, 1850-'53), presents the Roman Catholic view. A volume of "Historical Lectures on the Life of Christ," by C. J. Ellicott (London, 1859), is a popular work, while the notes appended consider most of the points under critical discussion. The "Life of our Lord upon Earth," by Samuel J. Andrews (New York, 1863), considers only the outward events of the life of Jesus, but is a thorough discussion of these. A new impulse was given to this department of study by the *Vie de Jesus* of Ernest Renan (Paris, 1863), which considered the gospel story as a legendary romance. A reply by E. de Pressensé, entitled *L'Ecole critique de Jesus-Christ*, appeared the same year, followed by *Jesus-Christ, son temps, sa vie, son œuvre* (Paris, 1866), by the same author; while a multitude of volumes and essays on the subject appeared in Europe and America. Among the works of more recent importance or popular interest are those of G. Uhlhorn, *Die modernen Darstellungen des Lebens Jesu* (Hanover, 1866; English translation, Boston, 1868); J. R. Seeley, "Ecce Homo" (London, 1866); Z. Eddy, "Immanuel" (Springfield, 1868); William Hanna, "Life of Christ" (Edinburgh, 1869); Lyman Abbott, "Jesus of Nazareth: His Life and Teachings" (New York, 1869); Howard Crosby, "Jesus, his Life and Works" (New York, 1871); Lewis Mercier, "Outlines of the Life of the Lord Jesus Christ" (London, 1871); Sir George Stephen, "Life of Christ" (London, 1871); Henry Ward Beecher, "Life of Jesus the Christ" (New York, 1871 *et seq.*); Charles F. Decems, D. D., "Jesus" (New York, 1872); and F. W. Farrar, "Life of Christ" (London, 1874). The principal works on the harmony and chronology of the Gospels are those of Lightfoot (1855), Macknight (1756), Benzel (1736), Newcome (1778), Greswell (1830), Wieseler (1843), Robinson (1845; revised ed., 1851), Jarvis (1845), Tischendorf (1851), Strong (1852), Stroud (1853), and G. W. Clark (1868). Other works deserving of mention are those of Stier, *Die Reden des Herrn Jesu* (1843-'8; English translation, Edinburgh, 1859); Ullmann, *Die Sündlosigkeit Jesu* (1841; English translation, Edinburgh, 1841); Schaff, "The Person of Christ" (Boston, 1865); Liddon, "Bampton Lectures of the Divinity of Christ" (London, 1867); and Plumptre, "Christ and Christendom" (London, 1867). A life of Christ according to the apocryphal gospels has been published by R. Hofmann (*Das Leben Jesu nach den Apokryphen*, Leipsic, 1851).

**JET**, a variety of lignite, resembling cannel coal, but harder, of deeper black, and of more brilliant lustre. It is found in detached pieces in tertiary clays along the coast of Yorkshire, England, and in various places on the continent

of Europe. From its susceptibility of taking a fine polish and its intense blackness, it has been largely used for mourning articles of ornament, as buttons, crosses, and ear rings.

**JETER, Jeremiah B.**, an American clergyman, born in Bedford co., Va., July 18, 1802. He entered the Baptist ministry in his native county in 1822, and removed in 1827 to the "Northern Neck" of Virginia, where he was pastor of the Maratico church in Lancaster co. and of the Nicomico church in Northumberland co. In 1836 he became pastor of the first Baptist church in Richmond, and in 1849 accepted an invitation from the second church in St. Louis. In 1852 he returned to Richmond to fill the pulpit of the Grace street Baptist church. He is the author of a "Memoir of the Rev. Abner W. Clopton," the "Life of Mrs. Henrietta Shuck," a "Memoir of the Rev. Andrew Broadus," the "Christian Mirror," "Campbellism Examined" (1845), and "The Seal of Heaven" (1871). He also, in conjunction with the Rev. Richard Fuller, compiled "The Psalmist," a hymn book in general use among the Baptists.

**JETSAM.** See FLOTSAM.

**JEVONS, William Stanley**, an English author, born in Liverpool in 1835. He was educated at University college, London, and in 1854 received an appointment in the mint at Sydney, Australia, where he remained five years. He then visited the United States, returned to England, and took the master's degree at the university of London in 1862. In 1866 he became professor of logic and mental and moral philosophy, and lecturer on political economy, in Owens college, Manchester. In 1872 he was elected a member of the royal society of London. He has published a pamphlet demonstrating the depreciation of the precious metals in consequence of the discoveries in California and Australia (1863); "The Coal Question" (1865), pointing out the probable exhaustion of the British coal mines, and the necessity of reducing the national debt; "Elementary Lessons in Logic" (1870); "Theory of Political Economy" (1871), containing an attempt to reduce the science to a mathematical form, and to explain the laws of supply and demand by the aid of the differential calculus; "The Principles of Science" (1874), in which some new views of the value of the reasoning processes are put forth, and syllogistic operations are shown to be practicable by mechanism.

**JEW, The Wandering.** See WANDERING JEW.

**JEWEL, or Jewell, John**, an English bishop, born at Buden, Devonshire, May 24, 1522, died at Monkton Farleigh, Wiltshire, Sept. 23, 1571. He finished his education at Oxford, became tutor there, and labored assiduously to disseminate the principles of the reformation among his pupils, but did not make a public profession of Protestantism till after the accession of Edward VI. He was expelled from Oxford in the reign of Mary, fled to the continent to escape imprisonment, and at the invitation of

eter Martyr went to Strasburg, where he for some time assisted in conducting a collegiate institution. On the death of Mary, Jewel returned to England, and was one of the eight divines appointed by Elizabeth to hold a controversy at Westminster with a similar number of Catholics. In 1559 he was placed on the commission to extinguish Catholicism in the western dioceses of England, and on Jan. 1, 1560, was consecrated bishop of Salisbury. The most famous of his works is his *Apologia Ecclesie Anglicanæ* (1562), of which Elizabeth ordered a copy to be chained in every parish church.

**JEWELL**, a N. county of Kansas, bordering on Nebraska; area, 900 sq. m.; pop. in 1870, 07. It is drained by affluents of the Republican and Solomon rivers. Capital, Jewell City.

**JEWES**. See HEBREWS.

**JEWSBURY**. I. Maria Jane, an English writer, born in Warwickshire about 1800, died in Bombay, India, in 1833. She was a writer of literary periodicals. In 1833 she married the Rev. William Fletcher, and went with him as a missionary to India, but died soon after her arrival in that country. She published "Phantasmagoria," a series of sketches of life and literature, "Letters to the Young," "Lays of Leisure Hours," and "Three Histories." II. Geraldine Endor, sister of the preceding, born in Warwickshire in 1821. She is the author of "Zoe, a History of Two Lives" (1845); "The Half Sisters" (1848); "Marian Vithers" (1851); "Constance Herbert" (1855); "The History of an Adopted Child" and "The Sorrows of Gentility" (1856); and "Right or Wrong" (1857). She has also written a story for children entitled "Angelo, or the Pine forest in the Alps" (1855).

**JEYPOOR**. I. A Rajpoot native state of India, between lat. 25° 40' and 27° 37' N., and lon. 75° 8' and 77° 20' E.; area, 15,000 sq. m.; pop. about 1,500,000. The surface is level excepting in the N. W., and imperfectly watered. The principal products are cattle and salt, and to some extent wheat, cotton, and tobacco. The state abounds in small forts, and possesses some of the strongest fortresses in India. The Minas are regarded as the aborigines, and the Jats are the most extensive and skilful agriculturists. The government is invested in a hereditary rajah, who pays an annual tribute of £40,000 to Great Britain. The army consists of about 20,000 men. II. A city, capital of the state, 140 m. S. W. of Delhi; pop. about 60,000. It is the most attractive city of upper Hindostan. The main thoroughfares intersect each other at right angles, each intersection forming a market square or *chawk*, and they are crossed by narrower streets, the whole forming rectangular blocks. The centre is occupied by the royal residence, seven and eight stories high, with towers and domes, including a dozen palaces communicating either by galleries or gardens. In the palace proper is an audience hall all of white marble. Many of the private

houses, three and four stories high, are embellished with frescoes, marble porticoes, statuary, and projecting stone balconies. Among the mosques and temples are exquisite specimens of the purest Hindoo architecture. Other notable public buildings are the extensive observatory and the arsenal. Jey Singh founded this city early in the 18th century as a substitute for his old and decayed capital Amber. —There are three other towns of the same name in various parts of India.

**JHANSI**, a town of India, in the Northwest Provinces, capital of a small state of the same name, annexed to the British possessions in 1854, 120 S. E. of Agra. It is a walled town, having a circuit of 4 m., with strong fortifications, and surrounded by fine groves. The streets are remarkably clean and orderly. A considerable trade is carried on with the cities of the Deccan and the Doab, and there are manufactories of native weapons. On June 4, 1857, a mutiny of native troops took place here, and 67 Europeans, about half of whom were women and children, were massacred at the instigation of the ranees or chieftainess of Jhansi. The ranees put herself at the head of the rebels, clad in mail, and during the rest of her career led her forces with masculine valor and ferocity. In 1858 a body of mutineers under her command shut themselves up in Jhansi, where they were besieged by Sir Hugh Rose, March 25. After a relieving force under Tantia Topee had been defeated, the city was stormed on April 2, 5,000 rebels being killed. The ranees escaped to Gwalior, in the storming of which place, in June, she was killed.

**JHYLUM**, Jallum, or Jehum (anc. *Hydaspes*; Sanskrit *Vitastā*; modern Hindoo, *Behut*), the most western of the five great rivers of the Punjab, British India. It rises in the N. W. Himalaya, in the southern part of Cashmere, flows N. W. along the centre of the valley of Cashmere in a winding course for about 120 m., more than half being navigable, and after various deviations finds an outlet through the pass of Baramula, and thence proceeds in a western direction toward the vicinity of Mazufarabad. Thence, enlarged by the almost equally considerable Kishen Gunga river, it pursues a S. direction until it falls into the Chenaub, after an entire course of about 450 m. It abounds in fish, and is said to contain alligators. Horace called the river *fabulosus Hydaspes*, on account of the wonderful stories associated with it. Virgil refers to it as *Medus Hydaspes*, and Ptolemy calls it *Bidaspes*. Alexander is reported to have seen crocodiles on the banks of this river, on which he built his fleet for the war with Porus from the timber of the Himalaya forests.

**JIDDAH**, Jeddah, or Djeddah, a town of Hedjaz in Arabia, on the Red sea, 65 m. W. of Mecca; lat. 21° 28' N., lon. 39° 13' E.; pop. about 18,000. It is built on the edge of the sea, in a sterile desert, about 10 m. back of which is a range of low hills, devoid of trees or vegeta-

tion. It is surrounded by walls, with fortified towers at intervals, and a ditch, and has nine gates, six facing the sea. The sea is gradually receding from the town, owing to the constant growth of the coral reefs. The harbor, which is the best on the Red sea, has a depth of from 3 to 17 fathoms; it is difficult of entrance, being shut in by ranges of reefs. The streets are straight and regular, and cleaner than those of most eastern towns, and the houses of the better class are built of stone or madrepora; but the suburbs are extremely filthy, and the dwellings little more than hovels. The principal buildings are the governor's residence, the custom house, several mosques of little architectural pretension, some large and handsome khans, and the British and French consulates. A rude stone structure outside the walls is venerated as the tomb of Eve. The climate is very trying to Europeans, the thermometer ranging from 76° to 107° F., and sometimes rising to

balm, incense, essences, senna, cassia, ivory, mother-of-pearl, pearls, tortoise shell, ostrich feathers, coral, dates, cutlery, hardware, and leather. The imports are provisions, including grain, from Egypt; metals, glass, bottles for essences, cutlery, soaps, cloths, silks, and cottons, from Europe; rice, sugar, timber, nankens, muslin for turbans, and girdles, from India; elephants' teeth, ostrich feathers, mules, and slaves, from Africa. A brisk trade is still carried on in slaves, the most of whom are Abyssinians; they are landed at night along the shore, and carried into the city in the morning with the connivance of the Turkish authorities, with whom the firman of the sultan for the suppression of the traffic is a dead letter. Jiddah was bombarded in 1858 by the British in retaliation for the massacre of the British consul and a number of Christians.

**JIBOON.** See OXRS.

**JOAB,** a Hebrew warrior, "captain of the host" (generalissimo of the army) during the greater part of David's reign, died about 1013 B. C. In the reign of Saul he accompanied David on his wanderings in the southern part of Palestine and its vicinity, and after Saul's death he defeated the troops of Abner, who supported Ishbosheth, the son of that king, as successor, and whom he assassinated after he became reconciled to David. His valor in the assault on the fortress of Zion, held by the Jebusites, gained him the chief command of the army of all Israel, and he had



Jiddah.

132° during the simoom. Intermittent fevers are prevalent, and they generally attack Europeans on arrival. During the months of pilgrimage the population is increased to 40,000, and sometimes to 60,000, about 120,000 pilgrims for Mecca and Medina passing through it annually. Of the ordinary population, about 1,000 are British-Indian subjects, a number of whom are wealthy merchants. There are also many Egyptians and a few Greeks, and several English and French merchants. The industry of the natives consists of fishing, diving for black coral, which is found for only a short distance along the coast, the manufacturing it into beads and mouth-pieces for pipes and cigars, and the dyeing of English cotton cloths. The trade of Jiddah, which is very large, is carried on chiefly by square-rigged British vessels, the vessels of the Mejidic steam company, and native coasting vessels averaging about 80 tons burden. The exports are coffee, gum, spices,

the principal merit in the conquests of his master. He adhered faithfully to the king during the revolt of Absalom. When, in order to conciliate the powerful rebellious party, the command of the host was given to Amasa, who had been Absalom's general, Joab soon rid himself of this rival by murdering him. David was obliged to overlook the murders of Abner and Amasa, but before dying gave strict directions to his son Solomon to put Joab to death. Shortly before the death of David he participated in the unsuccessful demonstration in favor of the natural heir Adonijah, and afterward fled for refuge to the altar, where he was put to death by command of the new king. His brothers Abishai and Asabel were also conspicuous as military leaders in the earlier part of the history of David.

**JOACHIM,** king of Naples. See MURAT.

**JOACHIM,** Joseph, a German violinist, born of Jewish parents at Kittsee, near Presburg.

Hungary, July 15, 1881. He received his first instruction on the violin from Helmesberger and Böhm at the Vienna conservatory. So rapid was his progress that he was permitted to play when only 11 years of age at a Gewandhaus concert in Leipsic. He performed at Leipsic during many succeeding seasons, and always with indications of progress and increasing talent. In 1850 he accepted, at the solicitation of Liszt, the post of concert master at Weimar. Three years later he exchanged this situation for a similar one at Hanover, where he still resides. He makes frequent visits to England, Holland, and Belgium, and occupies perhaps the foremost rank among living violinists. His chief points of excellence as a performer are purity and fulness of tone, perfect intonation, absolute mastery of all the technical difficulties of the instrument, and the closest sympathy with the classical composers whose works he interprets. His reluctance to appear in public has led to his declining all offers for a concert tour in the United States. He has composed both for violin and orchestra, but his fame rests on his qualities as a player rather than on the merits of his compositions.

**JOACHIMSTHAL**, a town of Bohemia, in the circle of Eger, near the frontier of Saxony, and 0 m. N. of Carlsbad; pop. in 1870, 6,566. It is situated in a beautiful valley of the Erzgebirge, more than 2,000 ft. above the sea. The educational institutions include schools for straw lating and lace making. White lead, red lead, malt, and paper are also manufactured. But the celebrity of the town is mainly due to its lead, tin, iron, and silver mines. The last employed 12,000 men in the 16th century, but the reduction has since much declined. The term *Thaler* derives its origin from this place, where he counts Schlick, who were the local rulers early in the 16th century, had *Guldengroschen* coined, which became known as Joachimsthaler, and afterward as thaler. In the neighborhood are the ruins of the castle of Freudentein. The town was almost completely destroyed by a conflagration March 31, 1873. The main church of St. Joachim was burned, with celebrated pictures by Dürer and Cranach; early 450 of the 586 houses were burned, and 4,000 persons were rendered houseless. The rebuilding of the town was at once commenced.

**JOAN, Pope**, a fictitious female personage who was long supposed to have succeeded Leo IV. in the papal chair in 855, and to have occupied it over two years. The first who mentions her is Marianus Scotus, a monk of the abbey of Fulda in the 11th century. According to Martinus Polonus, a chronicler of the 13th century, Joan was a native of Mentz, who went with an English lover to Rome in the disguise of a man, and, having become proficient in sacred and profane learning, was chosen to the papacy under the name of John III., no suspicion being had of her sex. She was seized with the pains of labor one day while passing in procession to the Lateran ba-

silica, and died in the street. This story was interpolated into the work of Anastasius, who lived at the time of her supposed reign, and some critics contend that it is even wanting in the earlier copies of Martinus Polonus. It was completely disproved by David Blondel, a Protestant writer, in his *Familier éclaircissement de la question si une femme a été assise au siège papal entre Léon IV. et Benoît III.* (Amsterdam, 1649); and it is now generally admitted that no such person as Pope Joan ever existed.

**JOAN OF ARC (JEANNE D'ARC)**, known as La Pucelle and "the Maid of Orleans," a French heroine, born at Domremy (now called from her Domremy-la-Pucelle), in Lorraine, about 1411, burned at the stake in Rouen, May 31, 1431. She was the fifth child of poor parents, whose family name was probably Darc. She received no instruction, but was accustomed to out-of-door duties, such as the tending of sheep and the riding of horses to and from the watering place. The neighborhood of Domremy abounded in superstitions, and at the same time sympathized with the Orleans party in the divisions which rent the kingdom of France. Jeanne shared both in the political excitement and the religious enthusiasm; imaginative and devout, she loved to meditate on the legends of the Virgin, and especially, it seems, dwelt upon a current prophecy that a virgin should relieve France of her enemies. At the age of 13 she began to believe herself the subject of supernatural visitations, spoke of voices that she heard and visions that she saw, and a few years later was possessed by the idea that she was called to deliver her country and crown her king. An outrage upon her native village by some roving Burgundians raised this belief to a purpose; her "voices" importuned her to enter upon her mission by applying to Baudricourt, governor of Vaucouleurs; and this, by the aid of an uncle, she did in May, 1428. The governor, after some delay, granted her an audience, but treated her pretensions with such scorn that she returned to her uncle. The fortunes of the dauphin, however, were desperate, and Baudricourt, pressed by her entreaties, sent her to Chinon, where Charles held his court. Introduced into a crowd of courtiers from whom the king was undistinguished, she is said to have singled him out at once. Her claims were submitted to a severe scrutiny. No evidence indicating that she was a dealer in the black art, and the fact of her virginity removing all suspicions of her being under satanic influence, her wish to lead the army of her king was granted. A suit of armor was made for her, and a consecrated sword which she described as buried in the church of St. Catharine at Fierbois was brought and placed in her hands. Thus equipped, she put herself at the head of 10,000 troops commanded by royal officers, threw herself upon the English who were besieging Orleans, routed them, and in a week forced them to raise the siege (May, 1429). Other exploits followed.

The presence of the virgin with her consecrated banner struck a panic into the souls of her enemies. In less than three months Charles was crowned king at Rheims, the maid of Orleans standing in full armor at his side. Her promised work was done. Dunois, however, unwilling to lose her influence, urged her to remain with the army, and she did so; but her victories were over. In an attack on Paris in the early winter she was repulsed and wounded. In the spring of the next year (1430) she threw herself into Compiègne, then beleaguered by the English; made a sortie in which she was taken prisoner (May 24), and was at once carried to Jean de Luxembourg's fortress at Beaurevoir. An attempt to escape by leaping from a dungeon wall was unsuccessful, and she was taken to Rouen. The university of Paris demanded that she should be tried on a charge of sorcery, and solicited letters patent from the king of England, which were reluctantly granted. The chapter at Rouen were rather favorably disposed toward her; many of the English in authority were unwilling to proceed to extremities; but the university of Paris prevailed. The examination lasted several months, and resulted in a conviction of sorcery. The papers were sent from Rouen to Paris, and the verdict of the university was unanimous that such acts and sentiments as hers were diabolical, and merited the punishment of fire. Sentence of condemnation was read to her publicly by the bishop of Beauvais, and the alternative offered of the stake or submission to the church. The terrified girl made a recantation, and was taken back to prison. Here her visions returned. A man's apparel being left in her cell to tempt her, she put it on; the bishop seized upon the act as a virtual relapse into her old unbelief, and hastened the execution of the first sentence. A huge pile of wood was erected in the market place of Rouen, and, surrounded by a vast assembly of soldiers and ecclesiastics, Joan of Arc was burned, and her ashes were thrown into the Seine. The infamy of this transaction lies heavily upon all concerned in it. The French king did nothing to avenge her, and waited ten years before he reversed the process by which she was condemned, and pronounced her "a martyr to her religion, her country, and her king." The character of the "Maid of Orleans" was spotless. She was distinguished for her purity, innocence, and modesty. Her hand never shed blood. The gentle dignity of her bearing impressed all who knew her, and restrained the brutality of her soldiers. The cottage in which she was born still stands between two buildings, founded as a monument to her by the department of the Vosges; it contains a copy of the beautiful statue by Marie d'Orléans, daughter of Louis-Philippe. The place where she was captured was indicated by a ruined tower which fell down in 1868; and the spot of her execution in the place de la Pucelle, Rouen, is marked by a mean statue. A

fine statue of her was unveiled in Paris, in the place des Pyramides, Feb. 23, 1873.—Among the French authors who have written the life of Joan of Arc are Lenglet du Fresnoy (2 vols. Paris, 1753-4), Lebrun de Charmettes (2 vols. 1817), Barthélemy de Beauregard (2 vols. 1847), Michelet (1853), Lafontaine (Orléans 1854), Villaurmè (Paris, 1863), and Barate (1865). The best German life is by Eysel (Ratisbon, 1864). The best English works are by Lord Mahon (now Earl Stanhope, "Life of Joan of Arc" (London, 1833), and Mrs. Bray, "Joan of Arc and the Times of Charles VII., King of France" (1874). See also Quicherat, *Procès de condamnation et de réhabilitation de Jeanne d'Arc* (published by the French historical society, 5 vols., Paris, 1841-'50), and his *Aperçus nouvelles sur l'histoire de Jeanne d'Arc* (1850). Among the poems and dramas founded on the history of Joan of Arc, the most noteworthy are Voltaire's travesty *La Pucelle*, Southey's "Joan of Arc," Schiller's *Jungfrau von Orléans*, and Calvert's "Maid of Orleans" (1874).

**JOANES, VICENTE.** See **JUANES.**

**JOANNA.** I. Queen of Naples, daughter of Charles, duke of Calabria, and granddaughter of Robert of Anjou, born about 1327, put to death at the fortress of Muro, in the province of Basilicata, May 22, 1382. An attempt was made by her father to secure harmony between the two branches of the Anjou family which had claims to the Neapolitan throne, by marrying Joanna when about seven years old to her second cousin Andrew of Hungary; but the plan proved an entire failure. As the young couple grew up the most bitter enmity arose between them, and was constantly encouraged by the opposing parties among their relatives. Duke Charles died before his father Robert, and Joanna therefore directly succeeded the latter on his death in 1343. Her court speedily divided into two factions, taking sides respectively with the queen and her husband; and two years of intense hostility terminated in September, 1345, in the assassination of the king by a party of conspirators who entered him from his room and strangled him in a corridor of the palace. Joanna seems to have deserved the accusation universally brought against her, of having inspired and directed this plot down to its smallest details; though the story of the old chroniclers that she wove the rope of gold thread with which Andrew was strangled is probably exaggerated. Shortly after the death of her husband she married her relative and supposed paramour, Louis of Taranto, without obtaining a papal dispensation. Louis the Great of Hungary, anxious for an opportunity to avenge his brother's death, made this his pretext, and in 1347 invaded the Neapolitan territory. Joanna, unprepared for defence, fled to Avignon, then the residence of the popes; but here she was summoned before a consistory and charged with the murder of her husband. She escaped the prosecution of

charge by consenting to cede Avignon to the pope for a permanent possession, on payment of 80,000 gold florins, and on condition that the pope should formally proclaim her innocence and the validity of her new marriage. In the mean time the king of Hungary fled from Naples, leaving a strong garrison behind him; and this was soon after removed, through the mediation of the pope. Louis died in 1362, and Joanna married in 1371 James of Aragon, king of Majorca, who died soon after and returned to his home in Majorca, where he died in 1376. Joanna now married a fourth husband, Otho of Brunswick, by this gave offence to Duke Charles of Anjou, whose wife was her presumptive heir to the throne. In 1378, when the rival popes Gregory VII. and Urban VI. contested the papal see, Joanna declared for Clement. Urban in revenge immediately summoned the Duke of Durazzo and proclaimed his right to the throne of Naples. Acting under the advice of Clement, Joanna made a special will, naming the second son of the king of France as her heir, and entirely disinheriting the duke of Anjou. These events gave Charles of Anjou the pretext for which he had long desired. He invaded Joanna's territory, met with little opposition from the people, and advanced to Naples, captured the queen in the city, and sent her a prisoner to Muro. Here she was placed at the disposition of the king of Hungary, who ordered her immediate execution. She was smothered with pillows, in accordance with the method of Andrew's assassination.

**II.** Queen of Naples, grandniece of Duke Charles of Anjou, and daughter of Duke Charles of Durazzo, born about 1370, died in 1435. Married first a young duke of Austria, and several years after left a widow, she succeeded her first husband Ladislas in 1414. Since her husband's death she had maintained a secret connection with Count Pandolfello Alopo, and this she continued without attempt at concealment, appointing her favorite to the highest offices and giving him virtual control of the government of the kingdom. She was finally persuaded by her councillors, however, to marry a second time, and chose as her husband Jacques de Bourbon, count of La Marche. Joanna's marriage did not put an end to her dissolute manner of life; and her husband, detecting her elusiveness, rid the court of her favorites, had Pandolfello publicly beheaded, and sent the count into retirement. An apparent reconciliation soon followed, but Joanna was never allowed to resume her place at court, and she succeeded by a stratagem in imprisoning her husband in one of the Neapolitan castles, from which he escaped with difficulty to retire from the country, and to enter a monastery in Burgundy. The rule of favoritism now began again, and the history of her reign for some years is little more than a record of intrigues, which, with the hatred of the people throughout the kingdom, gave rise

to constant feuds at court and insurrections in the country. The strife of parties was augmented by the conflicts between Louis III. of Anjou and Alfonso of Aragon, who claimed the succession to the throne. Joanna decided first for Alfonso, and then reversed her decision, and on Louis III.'s death changed her choice to another member of the Anjou house. Alfonso, however, was able to seize the throne, to which he succeeded in spite of his testamentary exclusion.

**JOANNES, Island of.** See **MARAJÓ.**

**JOANNY,** a French actor, whose real name was **JEAN BAPTISTE BERNARD BRISSEBANE**, born in Dijon, July 2, 1775, died in Paris, Jan. 5, 1849. He was a royal page, a student of art, a soldier, and a clerk in the civil service, before he appeared on the stage in 1797, where he acquired a reputation next to that of Talma, whom he succeeded at the Comédie Française in 1826. He excelled in personating Corneille's old Romans, and in Othello and kindred parts; and Victor Hugo ascribed the success of his play *Le roi s'amuse* to his acting. He retired in 1841, and published poetry and prose writings.

**JOB, Book of,** one of the canonical books of the Old Testament, so called from the name of the patriarch whose history it contains. According to the narrative contained in the introductory chapter, Job dwelt in the land of Uz (probably in the northern part of Arabia Deserta), was a man of eminent probity and piety, blessed with great riches in camels, sheep, and cattle, and highly reputed among the surrounding people. But God permitted Satan to put his virtue to the test. His oxen were stolen by the Sabæans, his sheep were consumed by fire from heaven, his camels were carried away by the Chaldeans, and his sons and daughters perished amid the ruins of a house overthrown by a whirlwind. He bore these calamities without repining, saying: "The Lord gave, and the Lord hath taken away; blessed be the name of the Lord." Then Satan was permitted to afflict his person. He was smitten with a terrible disease, and his wife counselled him to "curse God, and die" (properly rendered, according to Gesenius and others, "bless God"). Three friends, Eliphaz, Bildad, and Zophar, informed of his misfortunes, came to console him. The book consists chiefly of discussions between Job and his consolers on the question: Why do the righteous suffer? The burden of their argument, which is afterward taken up with some variation by another friend, Elihu, is that calamities are in proportion to sins, and that Job must have been guilty of great transgressions, or he would not be made to suffer so severely. They therefore admonish him to confess and repent of the guilt of which by his misfortunes he stands convicted. Job maintains, in opposition, that his afflictions are greater than his faults, that upright men are sometimes greatly afflicted, that God's justice does not always appear in the government of the world, and that he some-



times seems to act arbitrarily, as absolute Lord. At the conclusion the Lord himself addresses Job out of a whirlwind, condemning both his presumption in daring to criticise the Omnipotent, of whose ways he knows so little, and the false reasoning of his friends, who endeavored to vindicate Providence by accusing an innocent sufferer. Job acknowledges his nothingness, and is amply rewarded for his constancy. Of the author of this book nothing is known, and its age is variously estimated. Formerly it was generally believed, from the archaic character of its diction and descriptions, to be one of the most ancient books of the canon, and to have been originally written in old Hebrew or perhaps in Arabic. More recent expositors, as Gesenius, Umbreit, and De Wette, place it in the time of the Chaldean exile. Schlottmann, Delitzsch, and others refer it to the age of Solomon, or a still later one. In poetic sublimity the book is surpassed by no other in the Hebrew Scriptures, and in vigor of expression hardly equalled by any. Many of its passages, however, are exceedingly obscure.—The book of Job has been treated by many authors, among whom are De Pineda, (*Commentarii*, Madrid, 1597–1601, and later editions in Cologne, Antwerp, Venice, Paris, and Lyons), Schultens (1737), Umbreit (1824; English translation, Edinburgh, 1836–'7), Rosenmüller (1824), Ewald (1836), Lee (1837), Hirzel (1839; new ed., 1864), Heiligstedt (1847), Hahn (1849), Noyes (1850; new ed., 1867), Schlottmann (1851), Hengstenberg (1856; new ed., 1870), Conant (1856), Ebrard (1858), Renan (1859–'60), Delitzsch (1864; English translation, Edinburgh, 1866), Davidson (1862), Merx (1870), Hitzig (1874), and Green (New York, 1874).

**JOBÉ-DUVAL, Armand Marie Félix**, a French painter, born at Carhaix, Finistère, in 1825. He studied under Delaroche, and became known as a genre, portrait, and religious painter of the so-called Neo-Greek school, excelling by his delicate treatment of his subjects. He was adjunct mayor of Paris in 1870–'71, but resigned shortly after the installation of the commune, and subsequently became one of the municipal councillors. Among the best known of his numerous works are "The Painting of the Virgin" (1849), "The Toilet of a Bride" (1857), "The Jews expelled from Spain" (1857), and paintings of the life of St. Francis for the Paris church of Saint Louis en l'Île (1864).

**JOBERT, Antoine Joseph**, a French physician, known as Jobert de Lamballe, born in Brittany in 1799 or 1802, died in Paris, April 22, 1867. He took his degree of M. D. in 1828, and became one of the most distinguished surgeons of Paris, his new operations in diseases of the womb and his process of intussusception being generally adopted. In the latter part of his life he became insane. The French institute, of which he was a member, awarded a purse of 2,000 francs to his *Traité théorique et pratique des maladies chirurgicales du canal*

*intestinal* (2 vols., Paris, 1829). His other works relate to his specialty of uterine diseases and his process of intestinal intussusception (*invagination intestinale*), including *Traité de chirurgie plastique* (2 vols., 1849), with sequel, *Traitement des fistules vésico-vaginales* (1 vol., 1852); *Des appareils électriques et de poissons électriques* (1858); and *De la riande en chirurgie* (1864).

**JOB'S TEARS**, the fruit of a grass which has long been in use in Catholic countries for the



Job's Tears.

heads of rosaries. This grass, *coix lacryma* is a native of the East Indies, and was formerly



Flower Spike.

treated as a greenish plant; it will flourish in the open air in the climate of New York; and as it retains their vitality during the winter, numerous sown plants spring up where the plant stood the year before. It grows 2 or 3 feet high, and before flowering has much the appearance of Indian corn; each root produces numerous stems which form a large clump. The flowers are borne at the summit of the stems in a simple spike or branching panicle and are monocious; the structure is quite unlike that of most grasses; the pistillate flower is enclosed by an egg-shaped involucre, from an orifice in the apex of which appears a slender style which bears several staminate flowers; the stigmas of the flowers are protruded beyond the opening in the involucre to be fertilized when this has taken place the staminate flowers fall away, and the formerly herbaceous involucre

becomes of a very hard and bony texture. When ripe the involucre is of the size of a large pea, somewhat pear-shaped, pearly white or of some shade of gray, with a hard enamelled surface. These involucre, or seeds as they are popularly regarded, were formerly, on account of their stony appearance, supposed to be useful as remedies for gravel and stone in the bladder, and are found in the works of the old herbalists as *lachryma Jobi*; the Chinese still regard them as medicinal, but they are not recognized by modern pharmacopœias. Their principal use, as beads, has been already mentioned; in some countries they are made up into necklaces, chaplets, and other personal ornaments. The plant is of the easiest culture. The seeds may be sown in place after the soil is warmed, or they may be sown under glass and be transplanted afterward. When loaded with its ripened tears, the plant is an interesting if not highly ornamental occupant of the border.

**JO DAVIESS**, the N. W. county of Illinois, bordering on Wisconsin, and separated from Iowa by the Mississippi river; area, 650 sq. m.; pop. in 1870, 27,820. The surface is moderately uneven, and the soil is fertile and watered by numerous small streams. The county abounds in lead ore, and also contains copper. The Mineral Point and Illinois Central railroads pass through it. The chief productions in 1870 were 283,618 bushels of wheat, 1,286,326 of Indian corn, 874,016 of oats, 201,015 of potatoes, 66,650 lbs. of wool, 32,476 of flax, 655,681 of butter, and 34,372 tons of hay. There were 8,528 horses, 10,309 milch cows, 18,329 other cattle, 17,517 sheep, and 34,591 swine; 4 manufactories of agricultural implements, 17 of carriages, 3 of pig lead, 3 of machinery, 2 of marble and stone work, 10 of saddlery and harness, 9 of tin, copper, and sheet-iron ware, 3 of woollen goods, 2 flour mills, and 7 breweries. Capital, Galena.

**JODE, Pieter de**, the elder, a Flemish engraver, born in Antwerp in 1570, died in 1634. He engraved at Venice Titian's "Virgin and Child," and other works, and executed in Paris one of the largest prints known, after Jean Cousin's "Last Judgment," which is in the Louvre. After his return to Antwerp he produced many other fine works, his "Christ giving the Keys to St. Peter," after Rubens, being his masterpiece.—His son **PIETER** the younger also engraved many works after Vandyke, Rubens, and others.

**JODELLE, Étienne**, sieur de Lymodin, a French dramatic poet, born in Paris in 1532, died there in July, 1573. He published sonnets and odes at the age of 17, and endeavored to replace the mysteries and moralities by imitations of the Greek drama with choruses. His tragedy *Cléopâtre captive* (1552) achieved a brilliant success, despite its tediousness, he himself personating Cleopatra; and his tragedy *Didon* and comedy *Eugène, ou la rencontre*, were very popular. He was also known as an orator, architect, painter, and sculptor. His collected

works appeared in 1574; the best edition is that of Lyons, 1597.

**JOEL**, the second of the twelve Hebrew minor prophets, son of Pethuel. By some critics he is supposed to have prophesied in the reign of Uzziah, between about 800 and 780 B. C.; while according to Credner, Movers, Hitzig, and Meier, he lived in the early time of King Joash, and according to Hilgenfeld at the time of the Persian supremacy, shortly before the arrival of Ezra. The historical background seems, however, to determine the date of the prophecy. There is no mention of a king, and all is controlled by the ministers of religion, pointing to the minority of Joash under the guardianship of the high priest Jehoiada, about 870; and the absence of Assyrians in the enumeration of foreign enemies favors this early date. The book of Joel begins with announcing an extraordinary plague of locusts accompanied by drought. This is followed by promises of the divine forgiveness, of the restoration of the land to its former fertility, of spiritual blessings, and of the divine vengeance on the enemies of the chosen people. His descriptions rank, in sublimity, vividness, and purity of style, among the finest passages of Hebrew poetry. Among the more important commentators are Pocock (Oxford, 1691, and in Latin, Leipsic, 1695), Van Toll (Utrecht, 1700), Rosenmüller (Leipsic, 1836), Credner (Halle, 1831), Meier (Tübingen, 1841), and Umbreit (Hamburg, 1844); besides the works on the minor prophets by Henderson (London, 1845), Hitzig (1852), and Pusey (Oxford, 1861), and Ewald on the Old Testament prophets (2d ed., Göttingen, 1867).

**JOGUES, Isaac**, a French Jesuit missionary, born in Orleans, Jan. 10, 1607, killed by the Mohawks at Caughnawaga, N. Y., Oct. 18, 1646. He entered the Jesuit novitiate at Rouen in 1624, spent some years in teaching, studied theology in Paris, and was ordained in 1636. He had earnestly sought a foreign mission, and was sent to Canada, reaching Quebec July 2. He proceeded at once to the Huron country by the way of the St. Lawrence and Ottawa, and labored among the Hurons and Dinondadies under great danger and privations for several years. In 1642, with Father Raymbault, he penetrated westward to Sault Ste. Marie, where a number of Algonquin tribes were convened. He then accompanied a party of Hurons to Quebec to obtain supplies for the mission. On the way back they fell, Aug. 3, into an Iroquois ambuscade, and were nearly all killed or taken. The missionary was hurried away to the Mohawk by way of Lake Champlain, subjected to mutilation of the hands, and to the running of the gauntlet at the lake and in the village. Here he saw his associate, Goupil, tomahawked at his side; and although the Dutch endeavored to release him, he was reduced to the most cruel slavery. While he was with a fishing party on the Hudson, below Albany, his death was resolved

upon by the tribe, as the defeat of a war party was ascribed to a letter sent by him to his countrymen. At Albany the Dutch commander, aware of this, urged Jogues to escape. He succeeded with great difficulty, and reached a vessel in the river in August, 1643; but the tribe made such furious demands for their captive that Jogues was taken ashore again till the Mohawks were appeased. He then came to New Amsterdam (now New York), where Gov. Kieft received him kindly, and sent him to Europe in the first vessel. This ship had to put into Falmouth, England, whence he proceeded to France. He returned to Canada in time to witness the negotiations with the Iroquois at Three Rivers, July 12, 1644. In May, 1646, he set out with M. Bourdon to confirm the peace in the Mohawk castles, and on his way visited Lake George, to which he gave the name Lac St. Sacrement. Peace being to all appearance firmly established, he returned to prepare for the founding of a Mohawk mission. He set out Sept. 27, 1646, but was received as an enemy, diseases in the tribe being ascribed to a box left by him. He and his companion, Lalande, were almost immediately put to death. He wrote at Albany a long Latin letter describing his captivity, a description of New Netherland as he saw it, and an account of René Goupil. These with his letters have been published by the New York historical society (New York, 1847-'8); also his *Norum Belgium*, with translation and notes (4to, New York, 1862). A life of Jogues, by the Rev. Félix Martin, S. J., appeared at Paris in 1873.

**JOHANNA ISLAND**, called also ANZOOAN, or HINZAN, the most frequented of the Comoro islands, in Mozambique channel, E. coast of Africa; area, about 400 sq. m.; pop. said to be about 20,000. It is extremely fertile and picturesque. Its centre rises into a single peak, 5,900 ft. above the sea.

**JOHANNES SECUNDUS**, a Dutch poet, whose true name was JAN EVERARD, born at the Hague, Nov. 14, 1511, died in Utrecht, Sept. 24, 1536. He gained while young the degree of LL. D., and had also some celebrity as a sculptor and painter. After travelling in Spain and Italy, he accompanied Charles V. on his expedition to Tunis. His poems are written in purely classical Latin, and the *Bania* ("Kisses," Utrecht, 1539) have been ranked by his admirers with the lyrics of Catullus. They have been repeatedly translated into the principal European languages; and an edition, with translations by different English scholars and with notes, was published by Bohn (London, 1858). His *Opera Poetica*, consisting of elegies, odes, epigrams, and other poems, were published by his brothers, the poets N. G. and A. M. Everard (Paris, 1541; Gottingen, 1748; Leyden, 1821).

**JOHANNISBERG**. See GERMANY, WINES OF.

**JOHANNOT**. I. Charles Henri Alfred, a French artist, born in Offenbach, Hesse-Darmstadt, March 21, 1800, died in Paris, Dec. 7, 1837.

Having shown considerable talent as an engraver in Paris, in 1831 he attempted painting. His "Shipwreck of Don Juan" and "Voyage Mars" attracted the notice of Louis Philippe, who gave him several commissions, and at his death he was rising into eminence. II. Yoy, brother of the preceding, born in Offenbach, Nov. 9, 1803, died in Paris, Aug. 4, 1852. In making designs for vignettes he displayed much talent. His illustrations for "Werther," Molière's works, "Gil Blas," the "Vicar of Wakefield," and Sterne's "Sentimental Journey" are well known.

**JOHN**, the name of 23 popes, of whom the following are the most important. I. John I, SAINT, born in Siena about 470, died in Rome, May 27, 526. He was a cardinal priest when he succeeded Hormisdas, Aug. 13, 523. Shortly after his election he was sent to Constantinople by the Arian king Theodoric, to obtain from the emperor Justin milder measures toward the eastern Arians. He was received with much honor by the emperor, whom he solemnly crowned in March, 525. Justin revoked all rigorous laws against the Arians, but refused to restore the churches taken from them. John, having returned to Italy, was imprisoned by Theodoric, treated with great rigor, and died in captivity. He is honored as a martyr in the western church, and his feast is celebrated on May 27. II. John VIII., born in Rome about 820, died there, Dec. 15, 862. He was cardinal-archdeacon when he succeeded Adrian II., Dec. 14, 852. From the beginning of his pontificate his partiality for the French made him odious to the Italians. He crowned Charles the Bald of France as emperor in 875, and in 876 deposed Formosus, bishop of Porto, reduced him to lay communion, and banished him to France, whence he bound him by oath never to return. The innocence of Formosus, who was afterward pope (891), is now generally admitted. John, having solicited in vain the help of Charles against the Saracens who occupied southern Italy and were threatening Rome, purchased peace by promising to pay them an annual tribute. After the death of Charles the Bald he supported the claims of Charles the Fat against his Italian rivals, crowned him at Ravenna in 877, and was compelled to fly to France in 878, where he presided over the council of Troyes and crowned Louis III. He returned to Rome in 879, and at the prayer of the Greek emperor Basil I. approved of the restoration of Photius to the see of Constantinople. Soon afterward he retracted this approbation, and pronounced against Photius a sentence of deposition. This vacillating conduct caused Baronius to say that in the pontificate of John VIII. the church was governed by a woman. John gave the dukes of Gaëta the district of Traetto, and the town of Fondi, in order to induce him to take up arms against the Saracens. In 879 he summoned to Rome St. Methodius, apostle of the Slavs, and confirmed him as independent me-

tropolitan of the churches which he had founded. (See CYRIL AND METHODIUS.) He made many enemies by his arbitrary conduct and numerous excommunications, and died by violence. There are 326 letters by him extant.

**III. John X.** (GIOVANNI CENCI), born in Ravenna about 884, died in Rome, June 2, 928. According to Luitprand, bishop of Cremona, whose relation is discredited by Milman, Giovanni was successively appointed bishop of Bologna, Ravenna, and Rome, by the influence of the powerful and profligate Theodora. He was elected pope in 914, and displayed great energy against the Saracens. He crowned Berenger as king of Italy and emperor, March 24, 916. Uniting with the imperial army the forces of the dukes of Benevento and Naples, he led them against the Saracens intrenched in the territory of Garigliano, and utterly routed them. He confirmed the appointment to the see of Rheims of Hugo, five years old, son of Héribert, count of that city. Having resisted Marozia, the daughter of Theodora, who, with her husband Guido, duke of Tuscany, could brook no rival influence in Rome, he was cast by them into prison and suffocated there.

**IV. John XI.** (GIOVANNI CONTI), regarded by many as the son of Marozia, born in Rome between 905 and 910, died there in January, 936. He was raised to the papacy in 931, and was the mere tool of Marozia and the evil men who surrounded her. Her son Alberico, having excited the Romans to throw off her yoke, expelled her husband. King Hugo, made himself master of Rome with the title of consul, imprisoned his mother and the pope, and held them in captivity from 933 till the death of the latter.

**V. John XII.** (OTTAVIANO CONTI), son of Alberico and grandson of Marozia, born in Rome about 937, died there in 964. He was intruded into the papal office in 956, and assumed the name of John, being the first pope who thus changed his name. In 957 he took into his pay the troops of the duke of Spoleto, and marched at their head against Pandolfo, prince of Capua, who defeated him and compelled him to sue for peace. He invoked the aid of Otho the Great against Berenger II. Otho, having driven Berenger from Italy, entered Rome at the head of an army, and was crowned emperor of the West in February, 962. He secured to the pope his title to the States of the Church, and exacted from him the promise that he would hold no relation with Berenger. John violated this promise; and the emperor, incensed at his faithlessness, as well as at the loud complaints about his licentious life, returned to Rome in 963, and caused the pope to be degraded in an assembly of bishops held in St. Peter's in November, and the antipope Leo VIII. to be chosen in his stead. In 964, the Romans having revolted, John reentered Rome at the head of a large force, expelled Leo, and committed many atrocities. Otho was preparing to march once more toward Rome when the pope fell suddenly sick and died. **VI. John XXII.**

(JACQUES D'EUZE), born in Cahors, France, about 1244, died in Avignon in 1334. He was an Augustinian monk, and was transferred from the see of Fréjus to that of Avignon by Clement V., who also appointed him cardinal-bishop of Porto. He was elected pope at Lyons in August, 1316, and crowned there in September. His first act was to create one Italian and seven French cardinals, a step indicating a resolve to make the papacy a permanent French institution. French historians accordingly bestow great praise on this pope, while the Italians are unsparing in their censure. After the death of Henry VII. in 1313, the imperial crown was claimed by Louis of Bavaria and Frederick of Austria. John cited the contestants before him, and Louis refusing to appear, the pope excommunicated him. Louis appealed to a general council. The diet of Frankfort sustained him, declaring that the imperial authority depended upon God alone. The strife which existed in Italy between the Guelphs and Ghibellines made the latter espouse the cause of Louis, while the former sided with the pope. Robert, king of Naples, who aspired to be sole ruler in the peninsula, became the leader of the Guelphs, while Frederick, king of Sicily, with the Visconti, the Scalas, and the Esteas, supported Louis. They were excommunicated as heretics, a crusade was preached against them, and pope and emperor sent armies to the assistance of their respective partisans. Louis entered Italy in 1327, was crowned at Milan with the iron crown, and at Rome with the imperial crown. In an assembly held in the square of St. Peter's he cited the pope to appear and answer to the charges of heresy and high treason, deposed him, sentenced him to be burned alive, appointed in his stead Pietro da Corvara, who assumed the name of Nicholas V., and made it a law that any pope residing out of Rome for more than three months should be considered as deposed. Louis returned to Germany, the leaders of the Ghibellines died soon afterward, and the Guelphs gradually gained the ascendancy. John was indefatigable in his exertions to save Christendom from Saracenic aggression, and succeeded in the last year of his life in forming against the Turks a league composed of the kings of France, Sicily, Cyprus, and Armenia, and of the Greek emperor Andronicus. He sanctioned the custom introduced by St. Bonaventura of ringing the church bells at sunset, and saluting the Virgin with three *Ave Marias* in honor of the incarnation. He confirmed the military order of Christ (March, 1319), founded by King Denis of Portugal, restrained the power of the Teutonic knights, who oppressed the new Christians of Lithuania, and canonized St. Thomas Aquinas. He deprived by statute the people of towns of the right of electing their bishops, established the custom of collecting "annates" or first fruits, and left at his death a well filled treasury. **VII. John XXIII.** (BALDASSARE COSSA), born in Naples about 1360, died in Florence, Nov.

22, 1419. St. Antoninus, archbishop of Florence, describes him as a man of great administrative ability, a clever politician, and a bold soldier, who had been in his youth a corsair; but as a priest he was ill calculated to advance spiritual interests. He was created cardinal in 1402, and was degraded from that dignity by Gregory XII. in punishment of his tyrannical conduct toward the Bolognese, but was restored to it by Alexander V., who reappointed him governor of Bologna. He was elected pope in May, 1410, after the death of Alexander. Benedict XIII. and Gregory XII. now divided with John the allegiance of Christendom. John wrote letters to the imperial electors to induce them to choose Sigismund of Luxemburg, king of Hungary, and he espoused the claims of Louis of Anjou to the kingdom of Naples, in opposition to the reigning king, Ladislas. He entered Rome in triumph with Louis in 1411, and, gathering all the troops he could muster, attacked and defeated Ladislas at Roccasecca in May. He published a crusade against him in the following December, and compelled him to forsake the party of Gregory XII. and submit to himself. He then broke off his relations with Louis of Anjou, and restored Ladislas to his kingdom, appointing him at the same time general of the Roman church, and furnishing him with money. But Ladislas soon afterward took possession of Rome and forced John to fly. The latter now had recourse to Sigismund, who urged him to assemble a council at Constance for the purpose of terminating the great western schism and reforming ecclesiastical abuses, with the assurance that John should be free to come and go during the council. After much hesitation he consented to the emperor's scheme, and opened the council in person, Nov. 5, 1414. Meanwhile the death of Ladislas had left Rome open to John, who repented of having yielded to the emperor's solicitations, and only watched for an opportunity of returning to Italy. On March 2, 1415, he bound himself by oath to renounce the pontifical dignity as soon as his rivals had abdicated; but he afterward refused to sign the act of renunciation, and fled from Constance disguised as a merchant under the protection of the duke of Austria, and took refuge at Freiburg. In May a sentence of deposition was pronounced against him by the council; and the duke of Austria gave him over to the emperor, who sent him a prisoner first to Heidelberg, and then to Munich, where he was detained for four years. John escaped in 1419, and making his way to Florence was kindly received by Martin V., who appointed him bishop of Frascati and dean of the college of cardinals.

**JOHN**, king of England, third sovereign of the house of Plantagenet, and fourth son of Henry II. and Eleanor of Aquitaine, born in Oxford, Dec. 24, 1166, died Oct. 19, 1216. The surname of Lackland (*Sansterre*), by which

he is often mentioned, was popularly given him because of the small possessions that devolved upon him, while the elder sons were all liberally provided for; and it was "the usual appellation of younger sons, whose fathers died during their minority, and who could not possess estates until they were of age to do the feudal services required for them." When he was seven years old his father bestowed property upon him in England and Normandy. A marriage between him and Alice, eldest daughter of the count of Savoy, was negotiated, but his early death prevented its completion. Henry II. made John lord of Ireland, and he was with a large army to that country in March, 1185, accompanied by his lord deputy, De Lacy, and Gerald Barry (*Giraldus Cambrensis*, the historian). His behavior was so imprudent that he became the object of almost universal abhorrence, and his father was compelled to recall him to England at the close of the year. John was Henry's favorite son, but he joined in the repeated rebellions of his brothers; and Henry's death was occasioned by his becoming informal that John's name stood at the head of the list of those barons who had joined Philip Augustus of France against him, though at that very time he was exerting himself to benefit the fortunes of the rebellious prince. Richard I. successor of Henry, bestowed large possessions upon John, then known as earl of Mortain, but that did not prevent him from behaving as unfraternally as he had behaved unfaithfully. Richard departed on his famous crusade, intending that, in case he should die childless, his successor should be Arthur, duke of Brittany, son of his brother Geoffrey, John's senior. When Richard on his return became a prisoner in Germany, John sought to render his imprisonment perpetual, and to seize the crown, raising forces, and doing homage to Philip Augustus for such portions of Normandy as he had not surrendered to him. He besieged places in England that were held by Richard's friends, asserted that his brother was dead, and demanded his own recognition as king. He did not succeed, and Richard returned to England in 1194, seized John's castle of Nottingham, and summoned him to take his trial for treason, he being then in France, whither Richard led an army. At the intercession of their mother, the king pardoned his brother, who remained faithful during the rest of Richard's life. Richard bequeathed to John all his dominions, and most of his treasure, and required that homage should be done him. John experienced little difficulty in obtaining possession of England and Normandy, and was crowned at Rouen, April 25, 1199, and at Westminster, May 27. His accession dates from April 6, but he was not regarded as king of England until he had been crowned. According to the rule of descent, the crown belonged to Arthur, duke of Brittany, and the mother of that prince, Constance, persuaded Philip Augustus to espouse his quarrel. Philip

seized Anjou, Touraine, and Maine for Arthur, and he was advancing into Normandy when John arrived there. After some negotiation, war was renewed; but the general of Arthur's forces, finding that the French king was acting for himself alone, effected a reconciliation between John and Arthur, which was of brief duration. The uncle sought to make away with his nephew, who fled back to Philip, accompanied by his mother. In 1200 a peace was made between John and Philip, the latter acknowledging John as Richard's heir, and forcing Arthur to do him homage for Brittany. John paid a large sum of money to Philip, the collection of which caused much trouble in England. The first demand for the privileges of Magna Charta was made by the barons in May, 1201, and refused, whereupon they declined accompanying him to Paris, which he visited in order to be present at the marriage of his niece with the dauphin, and the king seized their castles. John, who had put away his first wife, Avisia, because they were related within the forbidden degrees, married Isabella, daughter of the count of Angoulême, Aug. 24, 1200. This lady had been betrothed to Hugh de Lusignan, son of the count of La Marche, who challenged John to combat. John offered to fight by his champion, an offer which Lusignan treated with contempt, declaring that the king's champions were bravos. Arthur's claims having been renewed, and insurrections in his favor occurring in Anjou and Maine, Lusignan espoused his cause, and civil war broke out in Poitou and Normandy. Arthur and Lusignan besieged Eleanor of Aquitaine in the castle of Mirebeau, in Poitou, and John hastened to his mother's assistance. On Aug. 1, 1202, he defeated the besiegers in a pitched battle, killing or capturing them all. Arthur, then in his 16th year, was among the captives. He was imprisoned, and is supposed to have been put to death by his uncle, a belief quite in keeping with John's actions. John was accused by Philip Augustus of the murder, and was summoned to defend himself before the peers of France. He refused to attend, and the court pronounced judgment, that "whereas John, duke of Normandy, in violation of his oath to Philip his lord, had murdered the son of his elder brother, a homager of the crown of France, and had perpetrated the crime within the seignory of France, he was found guilty of felony and treason, and was therefore adjudged to forfeit all the lands which he held by homage." This decree of forfeiture was vigorously put in force by Philip, whose proceedings were aided by the discontent that prevailed in John's French possessions. In 1203 nearly all those possessions except Guienne were taken by Philip, and John fled to England. He had said, on hearing of Philip's captures of towns: "Let him take them, I will one day recover them; the English sterling will restore all things." This would have been no idle boast had he been a popular monarch in England; but there he

was even more detested than he was in France. The name of Lackland was now revived for him. He landed with an army at La Rochelle in 1206, and took Angers, but then retired. He had received no aid from the English barons, whom he proceeded to fine frequently and heavily; and the archbishop of York cursed the collectors of the fines and left England. Those quarrels now began which ended in the granting of the great charter. John became involved in a contest with the church concerning the election of Cardinal Langton to the see of Canterbury, and Pope Innocent III. laid England under an interdict. The king seized the possessions of the church, and banished those who had occupied them. A bull of excommunication was issued in 1209, and John sought to prevent its promulgation in England, without which it could have no force. His fear was that Philip Augustus would attempt the conquest of England, under papal authority, and he maintained relations with some of that prince's neighbors. In the mean time he compelled William, king of Scotland, to acknowledge his supremacy, and effected conquests in Wales, dictating terms of peace to Prince Llewellyn. He also led a great army to Ireland, where he curbed the Norman colonists, divided the English possessions into counties, and established there the laws of England. He was guilty of acts of cruelty that shocked the sentiment of even that ferocious age. Of the captives whom he took in 1202, most of the principal men were starved to death in prison. On an insurrection occurring in Wales, he caused 28 hostages, all young nobles, to be executed. In 1213 the pope solemnly deposed John, and absolved his vassals from their allegiance. The French king prepared to enforce the sentence, and John assembled a numerous army to defend his kingdom; but as he could not rely upon its fidelity, he listened to the arguments of the nuncio, Pandulph, and resigned his kingdom to the pope, whose vassal he became. This act, so degrading to modern ideas, was not viewed so harshly then, and had many precedents; and the barons themselves acknowledged its validity. Pandulph proceeded to France, where he commanded Philip to put an end to his project of invasion, as England had become the patrimony of St. Peter. That monarch endeavored to turn his preparations to account by planning the conquest of Flanders, but he had ultimately to fight for his own dominions at Bovines. John invaded France, but accomplished nothing, though his fleet had previously defeated that of Philip. As he continued his course of misgovernment, a confederacy was formed against him by the nobility, at the head of which stood Archbishop Langton and the earl of Pembroke, and Robert Fitz-Walter commanded its forces. The king was compelled to submit to the barons, who forced him to make the grant known as Magna Charta, June 15, 1215. (See MAGNA CHARTA.) His submission was but momentary;

as soon as he could raise a foreign force, aided by the pope, who regarded the barons as rebels against himself, he resumed the war with success. The barons applied to France for aid, offering to make the dauphin Louis king of England. Louis entered England at the head of an army. John was about to fight a battle for his crown, when he lost his baggage, treasure, &c., in "the Wash." This affected his mind, and as he was ill at the time of the loss, his sickness so increased that he soon after died. His death was attributed to poison, and also to dysentery brought on by partaking freely of peaches and new cider. Modern England dates from the reign of John, whose cowardice and imbecility led to the loss of the greater part of the French possessions of his family, and so caused the Norman portion of the inhabitants of the island to regard the English as their countrymen. He was succeeded by his son Henry III.

**JOHN II.**, surnamed **LE BON** (the Good, or rather the Gallant), king of France, the second of the Valois family, born about 1319, died in London in 1364. Succeeding his father Philip VI. in 1350, he indulged in such extravagant expenditures to celebrate his accession to the throne that he soon found the royal treasury exhausted, and had to summon the states general for a grant of money. His first measures were marked by despotism and cruelty. By his orders the great constable Raoul, count of Eu and Guines, whom he suspected of treacherous dealings with the English, was arrested and beheaded without any form of trial, while his office and property were given to Charles of Lacerda, a Spanish prince. The latter having been murdered at Laigle, Normandy, by Charles the Bad, king of Navarre, a friend of Raoul, King John came unexpectedly to Rouen, where Charles was entertained by the dauphin, made him a prisoner with his own hand, and caused four of his followers to be decapitated on the spot. Philip, brother of Charles of Navarre, and the count of Harcourt, uncle of one of the victims, appealed to Edward III. of England for vengeance. The English invaded France at once. King John met one of their armies, under the Black Prince, at Maupertuis, near Poitiers, and, elated by his superiority in numbers, attacked him imprudently, was defeated, Sept. 19, 1356, and carried prisoner first to Bordeaux, and then to London, his conquerors treating him with courtesy and distinction. During his captivity violent dissensions broke out in France, and the dauphin (afterward Charles V.), who had assumed the regency, was for a while unable to contend against the rising power of the third estate. At the end of three years John tried to regain his freedom by a humiliating treaty with Edward III., which was rejected by the states general of France. The disastrous peace of Bretigny (1360), however, provided for the liberation of the French king by the sacrifice to the English of some of the best French provinces and the payment of

a ransom of 8,000,000 crowns. On his return home, John, coming by inheritance into possession of the duchy of Burgundy, bestowed it on his fourth son, Philip the Bold, as a reward for his gallantry at the battle of Poitiers. Another son, the duke of Anjou, whom he had given as a hostage for the fulfilment of the treaty of Bretigny, having forfeited his word by running away from England, John thought himself in honor bound to return to captivity, saying, "If good faith were banished from earth, it ought to be still found in the hearts of kings." He consequently returned to London, and there died.

**JOHN II. CASIMIR**, king of Poland, born March 21, 1609, died in Nevers, France, Dec. 16, 1672. He was a younger son of Sigismund III., of the house of Vasa, by an Austrian princess, who was baffled in her schemes to procure him the throne by his loyal adherence to his elder half brother Ladislas, who after the death of Sigismund was elected king (1632). In 1638 he embarked at Genoa for Spain to negotiate a league with Philip III. against France; but suffering shipwreck on the coast of Provence, he was seized and by order of Richelieu imprisoned at Vincennes, where he remained two years, and was only released on promise of his brother the king of Poland never to wage war against France. He then travelled through various countries of western Europe, entered the order of Jesus in Rome, was made cardinal by Innocent X., but after his return to Poland again became a layman, and, having succeeded his brother in 1648, married his widow Maria Luisa Gonzaga. His reign commenced amid the confusion and disasters caused by the great revolt of the Cossacks under Chmielnicki, who had advanced into the very heart of Poland. The power of the king had been stripped of almost all its prerogatives by the growing influence of the nobles. Russia and Sweden, which had long been active enemies of Poland, availed themselves of its distracted condition, and renewed their attacks. George Rákóczy of Transylvania, too, invaded the Polish territory, while diet after diet was dissolved by abuses of the *liberum veto*. Charles Gustavus of Sweden triumphantly marched through the country, and occupied Cracow (1655), John Casimir having fled to Silesia. Before Czentochowa, however, the Swedes met with an unexpected check, and a confederation of the nobles against all enemies of the country having been formed, Carniecki won a series of victories over the Swedes, Transylvanians, Cossacks, and Russians. The wars with the Swedes and Russians were terminated by treaties involving considerable cessions of provinces on the Baltic and the Dnieper on the part of Poland, which also lost its sway over the Cossacks, who put themselves under the protection of the czar. During these long disturbances John Casimir, though feeble and of a peaceful disposition, frequently proved his patriotism and

bravery. The intrigues of his wife in favor of the duke of Enghien, son of the prince of Condé, as successor to the throne, having brought about a rebellion under George Lubomirski, and a bloody though short civil war, the king finally resolved upon abdication, and resigned his crown at the diet of Warsaw, Sept. 16, 1668. In the following year he retired to France, where he was hospitably treated by Louis XIV. His wife had died without issue before his abdication. His body was removed to the cathedral of Cracow in 1676, his heart only being interred in St. Germain des Prés, of which Louis XIV. had made him abbot. John Casimir's reign was one of the most disastrous in the history of Poland, whose dismemberment by the houses of Moscow, Brandenburg, and Hapsburg, as it took place 100 years after his death, he predicted in a memorable speech to the diet of 1661.

**JOHN III. SOBIESKI**, king of Poland, born in the circle of Zloczów, then belonging to the palatinate of Belz, in 1629, or according to some in 1624, died June 17, 1696. His father, Jacob Sobieski, castellan of Cracow, carefully attended to the education of his two sons, of whom Marcus was the elder, and to complete it sent them to Paris. Here John entered the ranks of the musketeers of the young Louis XIV. under Condé; but on receiving the news of the death of King Ladislas IV. and the disasters caused by the bloody rising of the Cossacks (1648), both brothers hastened to their country and offered their services to the brother and successor of Ladislas, John Casimir. Both fought bravely, John especially distinguishing himself in the battle of Beresteczko (1651), but Marcus fell soon after. The invasion of Charles Gustavus of Sweden, and the simultaneous dangers which threatened Poland from every quarter, gave Sobieski ample opportunity to display his valor, and next to Czarniecki he was foremost in saving the country from ruin. His services were well rewarded, and shortly before the abdication of John Casimir he received the chief command of the army. In 1672 Poland was invaded by the Turks and Tartars, both of whose armies he successively surprised and defeated. The new king, Michael Korybut, being besieged by the Turks in the fortress of Kamenetz, concluded an ignominious treaty with the sultan; but Sobieski caused its rejection by the senate, hastened to Podolia, and routed the Turks at Khotin (1673). The news of the king's death arrived a few days later, and the commander and his followers hastened to Warsaw to attend to the election of a successor. This resulted, after stormy debates, in the choice of Sobieski, who immediately resumed the war, and rescued the fortress of Trembowla, which had been saved by the heroism of the wife of the commander. Another campaign was terminated less successfully by a treaty with the Turks at Zurawno, where Sobieski was nearly compelled to surrender with his comparatively small army.

The rising of the Hungarians under Tököli, and the invasion of the Mussulmans under the grand vizier Kara Mustapha, having brought Austria to the brink of ruin, Sobieski was persuaded by his wife and the ambassadors of the emperor and pope to hasten to the rescue of Vienna, which was besieged by an army of 300,000 men (1683). The Poles, numbering about one tenth as many, were joined by a somewhat larger body of German troops. Scarcely had they arrived before Vienna when Sobieski gave the signal for attack. The Turks were driven within their intrenchments, and attacked there on the next day (Sept. 12). The charge was terrible, and after a short struggle the Turks were completely routed. Sobieski made a triumphal entry into Vienna, and was hailed by all Europe as the saviour of Christendom. The emperor Leopold alone, who had fled from his capital, was too proud to receive cordially the hero who was "only an elected monarch." Sobieski pursued his success, following the enemy into Hungary, which was soon restored to the emperor. Returning to Poland, where the intrigues of his wife had created for him a large number of enemies, he made a disadvantageous peace with the czar, in order to be able to turn all his forces against the Turks. The conquest of Wallachia was the aim of this undertaking, in which he failed after various attempts. The last years of his life were embittered by civil as well as domestic troubles. Admired as a warrior, he was little esteemed by the Polish nation as a monarch, and after his death his three sons, Jacob, Constantine, and Alexander, were passed over at the election, which gave the crown of Poland to Augustus of Saxony.—The *Lettres du roi de Pologne, Jean Sobieski, à la reine Marie Casimire, pendant la campagne de Vienne*, were published in Paris in 1826.

**JOHN (JOHANN NEPOMUK MARIA JOSEPH)**, king of Saxony, born in Dresden, Dec. 12, 1801, died there, Oct. 29, 1873. He was the youngest son of Duke Maximilian of Saxony and the princess Carolina of Parma. At the age of 20 he entered the ministry of finance, of which he was president until he retired in 1831. As a member of the upper house he took an active part in the discussion of the constitution of that year. He was commander of the national guard from 1831 to 1846. His brother, Frederick Augustus II., dying without issue, Aug. 9, 1854, he became king. He adopted a policy on eastern affairs hostile to the western powers, and in the war of 1866 took the side of Austria. The Prussians entered Saxony June 18, and the Saxon army, having withdrawn without a blow to Bohemia, fought against them in the battle of Königgrätz, July 3. Peace was concluded between Prussia and Saxony, Oct. 21, and the king returned to Dresden Nov. 3, having agreed to pay a large sum, and to cede the fortress of Königstein. Subsequently Saxony entered the North German confederation, and her troops, under command of the crown prince Albert,



took a conspicuous part in the Franco-Prussian war of 1870-71. King John early showed a taste for archaeological study and Italian literature. He made a journey to Italy in 1838, and as the fruit of his studies published, under the pseudonyme Philalethes, a German translation of the *Divina Commedia* of Dante, with critical and historical notes of great value (Leipzig, 1839-'49; 2d ed., 1865). In 1824 he became president of the society of antiquaries of Saxony, and in 1852 and 1853 was president of the German society of history and antiquities. He left manuscript translations from the English of 70 poems, including several by Bryant.

**JOHN (JOHANN BAPTIST JOSEPH)**, archduke of Austria, ninth son of the emperor Leopold II. and Maria Louisa of Spain, born in Florence, Jan. 20, 1782, died in Gratz, May 10, 1859. He was carefully educated, and in 1800, when but 18 years of age, was made commander-in-chief of the Austrian army. He pressed forward into Bavaria, encountered the French under Moreau at Hohenlinden, and suffered a grave defeat there (Dec. 3), which was quickly followed by a second at Salzburg (Dec. 14). After the conclusion of peace in February, 1801, he became director-in-chief of the departments of fortification and engineering throughout the empire. He especially interested himself in the welfare of Tyrol, and after serving as minister of war from 1803 to 1805, he was appointed in the latter year to command the army stationed in that province. After the separation of Tyrol from Austria, he planned through Hormayr the rising of the Tyrolese in 1809 against their new masters, and commanded with success the army operating there and in Italy, defeating the viceroy Eugene (April 16) in an important engagement near Sacile, but retreating when he heard of the critical situation of Vienna. On his retreat he suffered two defeats (on the Piave and at Raab), nor was an attempt to join his forces with those of his brother at Wagram attended with better fortune. He resigned his command soon after the peace of October, 1809, and was afterward but little concerned in military affairs. He lived in retirement in Gratz, a city on which he conferred many public benefits, till 1848, when he was elected vicar of the empire (*Reichsverweser*) by the Frankfort parliament. In this capacity he chiefly devoted himself to protecting the interests of the house of Austria against the growing preponderance of Prussia; and this course he continued after the nomination of the Prussian king as emperor. On the expiration of his term of office (Dec. 20, 1849), which in the mean while had become merely nominal, he again retired to Gratz. He contracted amorganatic marriage in 1827 with Anna Plochel, the daughter of a Styrian postmaster; and by her he left one son, the count of Meran.

**JOHN, Eugene**, a German novelist, popularly known under the *nom de plume* of E. Marlitt, born at Arnstadt, Thuringia, Dec. 5, 1825.

She is the daughter of a painter, and on account of her fine voice was adopted in 1841 by the princess Matilda of Schwarzburg-Sondershausen, who had her educated, and enabled her to study music in Vienna during three years. She then appeared on the stage, but a sudden deafness made her return to Sondershausen as a companion of the princess. Her correspondents, struck with her attractive style, encouraged her to write novels, for which purpose she returned to Arnstadt in 1863. Her first work, *Die Zwölf Apostel*, appeared in the *Leipziger Gartenlaube* in 1865. She acquired celebrity in 1866 by her graphic and poetic delineations of German life in *Goldelise*; and in the same year she published *Blauhart*. Her subsequent works are *Das Geheimnis der alten Mamsell* (1867), *Reichgräfin Gisela* (1869), *Das Hünleprinzeßchen* (1871), and *Die zweite Frau* (1874). Many of them have been translated into English by Mrs. Wister of Philadelphia.

**JOHN, Knights of Saint.** See SAINT JOHN, KNIGHTS OF.

**JOHN OF AUSTRIA, Don**, a Spanish general, natural son of the emperor Charles V., born in Ratisbon, probably in 1547, died near Namur, Oct. 1, 1578. His mother was Barbara Blomberg, said to have been originally a washerwoman; she at one time declared in a fit of passion that Don John was not the emperor's son, so that there still remains some doubt as to his origin, though Charles himself never entertained any. The child, at first called Gerónimo, was carried to Spain and brought up with great care by the emperor's majordomo Don Luis Quijada; but his parentage was concealed till after Charles's death in 1558, when a private letter to his son and successor Philip II. was found acknowledging him. Philip changed his name, gave him a splendid establishment at Madrid, and sent him to Alcalá to be educated. He was distinguished for beauty and for martial tastes and accomplishments. In 1565 he departed secretly for Barcelona to take part in the defence of Malta, but was compelled to return by command of the king. Philip manifested for him the tenderest affection, and his countrymen came in time to regard him with feelings little short of idolatry. In June, 1568, Don John sailed in command of an expedition against the Barbary corsairs, with Requesens as lieutenant, and returned triumphant at the end of eight months. In the same year the great insurrection of the Moriscos of Granada had broken out, and Don John was sent thither as nominal commander-in-chief, but hampered by a council to whose will he was obliged to defer. His first independent exploit was the capture of Galera, which fell Feb. 6, 1570, after immense losses on both sides, and all the inhabitants except a few women and children were by his order put to the sword, and the place was razed to the ground and sown with salt. Other successes followed rapidly until the final expulsion of the Moriscos from Granada, in which

Don John had but a subordinate share. In 1571 he was placed in command of the immense armament organized by the holy league against the Turks, which won the famous naval victory of Lepanto, Oct. 7. Although this success was not followed up, owing to the dissensions of the chiefs, and subsequently to the avoidance of battle by the Turks, all Europe rang with the praise of the young hero, and his ambition rose with his glory. In September, 1573, he made a descent on the Barbary coast, and captured Tunis, the fortifications of which he repaired and strengthened, although ordered by Philip to destroy them, and conceived the project of establishing a throne for himself on the ruins of Carthage. The pope favored the scheme, but the king thwarted it, and the next year Tunis was recaptured by the Turks. He then turned his attention northward, and promised all the aid in the power of the pope, dreamed of liberating and marrying the captive Mary, queen of Scots, and reigning with her over all Britain, Elizabeth being dethroned. Opportunely, as it seemed, for this wild plan, he was appointed governor general of the Netherlands, and, disguised as a Moorish slave to one of his attendants, travelled secretly through France, and entered Luxemburg Nov. 4, 1576, the very day of the terrible massacre and pillage by the Spanish soldiery known as the "fury of Antwerp." Don John came with the contradictory instructions to conciliate the provinces, but concede nothing; but before he could procure his recognition as governor, he found himself obliged to sign the treaty called, after its ratification by Philip, the perpetual edict, and to send away the hated Spanish soldiers, on whom he had relied for carrying out his personal designs upon England. The edict ostensibly confirmed the "pacification of Ghent," concluded between the provinces just before his arrival, for the purpose of securing religious toleration; but William of Nassau, and the provinces of Holland and Zealand under his guidance, perceiving the duplicity of its stipulations, and the governor's insincerity, refused to accept it. Don John, for his own purposes, was sincerely desirous of establishing peace, but at the same time determined to maintain the royal supremacy and suppress heresy; and the long and harassing negotiations carried on with these irreconcilable aims, during which he made to no purpose unbounded offers of wealth and power to the prince of Orange, chafed his fiery spirit and embittered his hatred of the Netherlanders. At length he seized the castle of Namur, held for the states by a feeble garrison, but of which he had the right as governor to take peaceable possession, and recalled in small bodies and at intervals the troops he had sent to Lombardy, while in spite of the treaty he had all the time retained a numerous German force. Meantime the archduke Matthias of Austria, called in by a faction of nobles, had been nominally accepted by the states general as governor of the Neth-

erlands, while the real power was placed in the hands of William of Nassau; and on Dec. 7, 1577, Don John was formally deposed, and denounced as an infractor of the peace which he had sworn to maintain. The states had by great exertions raised a force equal to his own, but led by lukewarm nobles, which assembled near Namur, and then retired to seek a stronger position. The governor followed with his army, and his vanguard came up with them near Gembloux, Jan. 31, 1578. There, while they were struggling irregularly through a marsh, Alexander Farnese with a small body of cavalry attacked them by surprise, and almost annihilated them, many thousands being slain, all their equipments captured, and many prisoners carried off and put to death; while on the Spanish side scarcely a man was lost or a wound received. This stunning blow, however, Don John could not effectively follow up from want of resources, though he possessed himself of many towns. All through his administration he had received abundant promises, but very little substantial aid, from Philip II., who, by the intrigues of his minister Perez, had been led to suspect him of designs upon the throne; and he was forced to remain idly in his intrenched camp a league from Namur, while the provinces, more united than ever, were again gathering head under the exertions of William, and the duke of Alençon was threatening him with a French force from another quarter. Moreover, his own soldiers were dying in crowds of the plague; and he now heard of the assassination, by royal order, of his secretary and confidential friend Escovedo, whom he had sent to Madrid in the previous year to represent his grievances. (See PEREZ, ANTONIO.) At length he was carried off by a fever which had long been consuming him, dying in a wretched hovel hastily prepared for his reception. His body after death presented strong appearances of having been poisoned, but no other evidence of the fact has ever transpired. His funeral was celebrated with great pomp at Namur, and then his embalmed remains were by order of Philip, in order to save the expense of a public progress, divided into three parts and secretly transported through France in bags slung at the pom-poms of troopers. On their arrival in Spain they were reunited by wires, magnificently robed for presentation to Philip with a mockery of life, and then interred in the Escorial, in accordance with his wish, by the side of Charles V. He was succeeded in the government of the Netherlands by his nephew Alexander Farnese.

**JOHN THE BAPTIST**, the forerunner and relative of Christ, son of the priest Zacharias and Elizabeth, and cousin of the Virgin Mary, born at Juttah or at Hebron about 5 B. C., beheaded about the end of A. D. 28. The main particulars of his life are contained in the Gospel of Luke. His birth and office were foretold by the angel Gabriel to his father

as he was burning incense in the temple of Jerusalem. When Zacharias asked for some sign of the truth of the prophecy, his tongue was sealed, and he did not recover his speech till after the birth of the child. Six months after Elizabeth had conceived, she was visited by Mary, and at her salutation she felt the babe leap in her womb. John abode in the desert until, a short time before the ministry of Jesus, he appeared clothed with camel's hair and with a leathern girdle about his loins as a prophet in the country about the Dead sea, exhorting the people to repentance, and proclaiming the approach of the Messiah. Those who believed he baptized in the Jordan, announcing at the same time the coming of a mightier one, who should baptize them with the Holy Ghost and with fire. He recognized the Messiah in Jesus, who presented himself for baptism, and publicly declared him "the Lamb of God, that taketh away the sins of the world." It is not certain what were the relations between John and Jesus; but the disciples of the former were a separate sect after his death, and still exist in the East under the name of Sabians or Christians of St. John. On account of his censure of the marriage of Herod Antipas with his sister-in-law Herodias, John was imprisoned in the castle of Machærus, and probably it was there that he was beheaded at the instance of Herodias. His birth and death are commemorated by the Roman Catholic church respectively on June 24 and Aug. 29. In England he was formerly esteemed the patron of architects, and was held in special honor by the freemasons.—See, besides the different lives of Jesus, especially those by Hase and Neander, Witsius, *De Joana Baptista* (in his *Miscellanea Sacra*, vol. ii.); Leopold, *Johannes der Täufer* (Hanover, 1825); and Von Rohden, *Johannes der Täufer* (Lübeck, 1838). The ecclesiastical traditions concerning John the Baptist are collected in the *Acta Sanctorum*, vol. iv., and in a compendious form in Tillemont's *Mémoires*, vol. i.

**JOHN THE EVANGELIST**, one of the apostles, son of the fisherman Zebedee and Salome, born in Bethsaida, on the lake of Galilee, died about A. D. 100. He followed the occupation of his parents, was probably a disciple of John the Baptist, and became when about 25 years old, with his brother James, a disciple of Jesus, whom he was one of the first constantly to accompany. It is believed that he was the youngest of the apostles, and the special attachment of the Saviour to him is expressed in his description of himself as "that disciple whom Jesus loved." He was present at the transfiguration, assisted in preparing the last supper, at which he reclined on the bosom of his master, and was the only disciple who accompanied Jesus to the cross. While hanging on the cross the Saviour confided his mother to the care of St. John. After the ascension John remained for a while at Jerusalem, but from this time Scriptural history is silent con-

cerning him. The traditions, however, agree that he afterward abode in Ephesus and Asia Minor. According to Jerome, he was arrested by command of the proconsul, and taken to Rome, where he was plunged into a vessel of boiling oil, but, as this did not harm him, he was banished in the year 95 to the island of Patmos. He was released after the death of Domitian, and died in the reign of Trajan, at a very advanced age. According to the same authority, he became toward the last so weak that he was obliged to be carried to the Christian assemblies, and when there could only say, "Love one another, my children." His festival is celebrated by the Roman Catholic church on Dec. 27. He is usually painted with a cup from which a serpent is issuing, in allusion to poison which was believed to have been offered him in a glass, from which he expelled the venom in the form of a serpent by making the sign of the cross.—The New Testament contains a Gospel, three epistles, and the Apocalypse, or book of Revelation, bearing his name. His Gospel gives the speeches of Christ more fully than the synoptic Gospels, but historical facts appear less prominently in it than the doctrines which are implied and established by the facts. According to the fathers, it was written at Ephesus or at Patmos in the latter part of the 1st century. The work of Bretschneider, *Probabilia de Evangelii et Epistolarum Johannis Apostoli Indole et Origine* (Leipsic, 1820), is the earliest attempt of importance to raise doubts of the genuineness of the Gospel. The subject is discussed by Strauss (in his *Leben Jesu*), Baur, Schweigger, and others, from a rationalistic standpoint; while it has been defended by Tholuck (*Glaubwürdigkeit der evangelischen Geschichte*) and others of note. See, besides the authors just mentioned, Ebrard, *Kritik der evangelischen Geschichte* (Zürich, 1850); Meier, *Commentar* (Göttingen, 1856; new ed., 1865-'6); Ewald, *Die Johanneischen Schriften* (2 vols. Göttingen, 1861-'2); Bleek, *Einleitung in das Neue Testament* (Berlin, 1862); Davidson, "Introduction to the New Testament" (London, 1866); and Roffhack, *Auslegung, &c.* (Leipsic, 1871).—The first epistle was probably addressed to Christian congregations in Asia Minor, which had been under the charge of the apostle, and urges love, devotion, and moral strictness. It consists of separate thoughts and precepts with little logical connection. The most important works on this epistle are the commentaries of Sebastian Schmid (Leipsic, 1637, and many later editions) and Neander (Berlin, 1851; English translation by Mrs. Conant, New York, 1852). The second epistle is addressed to a lady of rank, called "the elect lady," supposed by some to refer to a Christian church. The third epistle is addressed to Gaius, who is commended for his hospitality to the faithful, and contains, like the first, allusions to Gnostic errors. (For the book of Revelation, see APOCALYPSE.)

**N THE FEARLESS**, duke of Burgundy, about 1370, assassinated Sept. 10, 1419. He was the son of Philip the Bold, whom he succeeded in 1404, and took immediate measures to secure for himself the influence which he had possessed in the government of France. He was opposed by the queen and the duke of Orleans, brother of the king. The duke of Orleans was murdered in Paris by assassins hired by John in 1407. A civil war followed, in which John was supported by Henry V. of England (1411); it was suspended by the treaty of Arras in 1414. In 1416 John entered into a secret alliance with Henry V. of England, and soon overran a great part of France, and in 1418 obtained possession of the person. A plot was formed to assassinate him, in pursuance of which he was invited to meet the dauphin on the bridge of Montereau. He went there with an escort slightly inferior, and perished with many of his companions, the rest escaping by flight. He was succeeded by his son Philip the Good.

**JOHN OF GAUNT** (or **GHEENT**), duke of Lancaster, fourth son of Edward III., born in London in 1340, died Feb. 3, 1399. He distinguished himself for valor in the wars of his father, the Black Prince in France, and succeeded to his government in that country. In 1380 he married the lady Blanche, daughter and heiress of Henry Plantagenet; she bore him a son who in 1399 became the first English king of the house of Lancaster, as Henry IV. After her death he married in 1370 Constance, daughter of Pedro the Cruel of Castile, and assumed the arms and title of king of Castile, but returned to England within less than a year after his brother. There he defeated Wycliffe, and was often suspected of usurpation at the crown. He resigned his pretensions to the throne of Castile when his daughter Katharine married the heir apparent of that kingdom. John of Gaunt's third wife was Catherine Swynford, governess of his children by whom he had three sons and one daughter before their marriage. These were all legitimated, and one of them, John de Beaufort, earl of Somerset, was an ancestor of the Stuart kings.

**JOHN OF LEYDEN**, a Dutch fanatic, born in 1510, put to death in Münster, Westphalia, January, 1536. His true name was John de Witt or Bockelson, and he was the son of a cooper of the Hague, and worked in that trade of a tailor. In 1533 he joined the Anabaptists in Münster, where he assisted in the massacre of Haarlem in the rebellion of that year. After his death he assumed power as a prophet.

On June 24, 1534, he was crowned with the title of king of Zion. He appointed 12 judges to administer his government, assumed princely pomp and luxury, introduced polygamy, married 15 wives, and the city was given up to excesses of fanaticism and lust. He issued edicts of banishment against neighboring rulers, and put more than 20 apostles, who preached

his doctrine, though they rejected many of his excesses. He coined money, specimens of which, silver pieces with his stamp, are in the museum of Hanover. Being besieged by the bishop of Münster, discontent and rebellion broke out among his followers, which he repressed with much cruelty and bloodshed, executing one of his wives with his own hand. The city was taken by treachery in the night of June 24, 1535, and he was made prisoner. He was sent through the country in an iron cage, and at length, together with two of his companions, was tortured to death with hot pincers. Their caged bodies were hung upon the tower of St. Lambert's church, where the cages are still to be seen. His house in Münster is yet standing. (See ANABAPTISTS.)

**JOHN OF SALISBURY**, called also **JOHANNES PARVUS** (John the Little), an English scholastic philosopher, born in the old town of Salisbury (Old Sarum) about 1120, died in Chartres, France, Oct. 25, 1180. He studied at Oxford, and in 1136 passed over to France, where he attended the lectures of Abélard and others. He opened a school in Paris about 1140, but with little success, and on account of his poverty retired to the abbey of Montier-la-Celle. About 1151 he returned to England, and was appointed secretary to Theobald, archbishop of Canterbury, who introduced him to his future successor Thomas à Becket. He was sent on important diplomatic missions to Popes Eugenius III., Anastasius IV., and Adrian IV., with the last of whom he was an especial favorite. He was the secretary of Becket when he became archbishop of Canterbury, was called his eye and his arm, supported him in his contest with Henry II., shared his exile and disgrace, and returned with him to England. In 1176 he was elected bishop of Chartres, and passed the rest of his life in his diocese. He was highly reputed not only as a scholar, but as a poet and orator. His most important works are *Polyeraticus, sive de Curialium Nugis et Vestigiis Philosophorum*, an erudite and caustic satire on the follies of courtiers and philosophers, and *Metalogicus*, in which he vindicates the studies of the schools against the sneers and outcries of the ignorant. His complete works were first collected by J. A. Giles (5 vols., Oxford, 1848).

**JOHN SCOTUS.** See ERIGENA.

**JOHN OF SWABIA**, or **John the Parricide**, a German prince, born in 1289, died in 1313 or 1368. He was a son of Duke Rudolph of Swabia and nephew of the emperor Albert I., the son and successor of Rudolph of Hapsburg. On attaining his majority he claimed the possessions to which he was entitled in Austria and Bohemia, but the emperor would not even surrender the county of Kyburg, which had been bequeathed to John by his mother Agnes of Bohemia. The prince thereupon entered into a conspiracy with a number of discontented noblemen, with the assistance of three of whom he murdered his uncle the emperor,

May 1, 1308, near Windisch, in Switzerland, assailing him as he was crossing the river Reuss on his way to Brugg. The murderers, who had been disguised as monks, escaped separately, and John fled to Italy, where according to some accounts he ended his life in Pisa, April 13, 1313, after having received absolution from Pope Clement V. at Avignon. But this story is doubtful, as well as that of his having spent the rest of his life as a hermit on his estate of Eigen without being recognized, and that he only made himself known at the time of his death in 1368. The emperor's daughter Agnes, the widow of Andrew III. of Hungary, and her mother, the dowager empress Elizabeth, being unable to lay hands on the conspirators, doomed to death thousands of their innocent relatives, friends, and vassals, destroying their abodes and confiscating their property. One of the conspirators, Rudolph von Palm, was beheaded in the presence of Agnes and Elizabeth, with 63 other knights and their armbearers, while Agnes held a wreath of roses in her hand and exclaimed exultingly that "she was bathing in the dew of May," referring to the shedding of her father's blood on the first of May. Rudolph von der Wart, another conspirator, having been surrendered by the Burgundian count Blamont, to whom he had fled, was broken on the wheel after having been submitted in his wife's presence to fearful tortures. Part of the proceeds of her victims' estates was appropriated by Agnes toward the establishment of the nunnery of Königfelden, on the site where her father had been slain, and where she died, May 13, 1364, but without having been able to satiate her revenge on John himself. He was however outlawed by her father's successor, Henry VII. of Luxemburg. Schiller introduces John in his *Wilhelm Tell*.

**JOHNSON**, the name of eleven counties in the United States. I. An E. central county of Georgia, bounded W. by the Oconee river, and drained by the Great Ohoopce; area, about 250 sq. m.; pop. in 1870, 2,964, of whom 915 were colored. The surface is undulating. The chief productions in 1870 were 47,229 bushels of Indian corn, 7,168 of sweet potatoes, and 1,558 bales of cotton. There were 374 horses, 680 milch cows, 755 other cattle, 1,306 sheep, and 4,571 swine. Capital, Wrightsville. II. A N. E. county of Texas, bounded S. W. by Brazos river; area, 594 sq. m.; pop. in 1870, 4,923, of whom 279 were colored. The surface is undulating; the soil is well adapted to wheat, and is generally fertile. Prairie and timber lands are distributed in nearly equal quantities. The chief productions in 1870 were 5,694 bushels of wheat, 153,455 of Indian corn, 6,718 of oats, 7,297 of sweet potatoes, and 1,212 bales of cotton. There were 6,343 horses, 2,549 milch cows, 16,396 other cattle, 1,212 sheep, and 8,758 swine. Capital, Cleburn. III. A N. W. county of Arkansas, bounded S. by Arkansas river, which is here navigable by steamboats; area,

576 sq. m.; pop. in 1870, 9,152, of whom 613 were colored. The surface is moderately uneven, and the soil is fertile, but not uniformly so. The Little Rock and Fort Smith railroads pass through it. The chief productions in 1870 were 13,864 bushels of wheat, 275,185 of Indian corn, 21,159 of oats, 7,048 of Irish and 16,890 of sweet potatoes, 11,915 lbs. of tobacco, 70,493 of butter, and 4,489 bales of cotton. There were 3,341 horses, 2,958 milch cows, 4,708 other cattle, 3,135 sheep, and 18,964 swine. Capital, Clarksville. IV. The N. E. county of Tennessee, bordering on Virginia and North Carolina, and having the Alleghany mountains on its S. E. boundary; area, 500 sq. m.; pop. in 1870, 5,852, of whom 418 were colored. It is watered by Watauga river and its branches. The surface is mountainous and thickly wooded, and the county is rich in iron. The chief productions in 1870 were 16,464 bushels of wheat, 13,397 of rye, 65,782 of Indian corn, 34,682 of oats, 10,671 of potatoes, 11,333 lbs. of wool, 72,041 of butter, and 1,513 tons of hay. There were 951 horses, 1,661 milch cows, 2,579 other cattle, 6,004 sheep, 5,271 swine, and 7 iron forges and rolling mills. Capital, Taylorsville. V. An E. county of Kentucky, traversed by the W. fork of Big Sandy river; area, 140 sq. m.; pop. in 1870, 7,494, of whom 37 were colored. It abounds in sandstone and coal, and has a hilly surface with a sandy but fertile soil. The chief productions in 1870 were 9,482 bushels of wheat, 234,356 of Indian corn, 30,310 of oats, 13,341 of potatoes, 14,481 lbs. of tobacco, 13,798 of wool, and 81,082 of butter. There were 1,129 horses, 1,537 milch cows, 1,088 working oxen, 2,338 other cattle, 8,105 sheep, and 9,277 swine. Capital, Paintville. VI. A central county of Indiana, watered by the W. fork of White river and several smaller streams; area, 330 sq. m.; pop. in 1870, 18,366. The surface is moderately uneven, and the soil is chiefly a rich loam. The Jeffersonville, Madison, and Indianapolis and the Cincinnati and Martinsville railroads traverse it. The chief productions in 1870 were 544,917 bushels of wheat, 1,394,221 of Indian corn, 50,392 of potatoes, 45,363 lbs. of wool, 300,915 of butter, and 6,376 tons of hay. There were 6,319 horses, 4,279 milch cows, 8,233 other cattle, 13,775 sheep, and 30,006 swine; 2 manufactories of agricultural implements, 11 of brick, 13 of carriages, 3 of clothing, 7 of cooperage, 5 of brick and stone masonry, 8 of saddlery and harness, 1 of starch, 2 of woollen goods, 2 leather-carrying establishments, 11 flour mills, 2 planing mills, and 14 saw mills. Capital, Franklin. VII. A S. county of Illinois, drained by Cache river; area, 486 sq. m.; pop. in 1870, 11,248. It has a level surface and a good soil. The chief productions in 1870 were 92,191 bushels of wheat, 343,256 of Indian corn, 74,525 of oats, 19,764 of Irish and 7,076 of sweet potatoes, 307,013 lbs. of tobacco, 21,663 of wool, 99,725 of butter, 2,327 tons of hay, and 33 bales of cotton. There

were 2,247 horses, 926 mules and asses, 1,846 milch cows, 2,202 other cattle, 9,568 sheep, and 13,988 swine. Capital, Vienna. **VIII.** A S. E. county of Iowa, drained by Iowa river, which is navigable by small steamboats in the S. part; area, 324 sq. m.; pop. in 1870, 24,898. The surface is moderately uneven and the soil remarkably fertile. The Chicago, Rock Island, and Pacific railroad passes through it. The chief productions in 1870 were 503,141 bushels of wheat, 2,147,570 of Indian corn, 491,187 of oats, 104,889 of potatoes, 674,500 lbs. of flax, 69,796 of wool, 594,573 of butter, 32,962 of cheese, and 40,659 tons of hay. There were 9,989 horses, 9,628 milch cows, 15,902 other cattle, 16,975 sheep, and 40,456 swine; 7 manufacturing factories, 1 of linseed oil, 1 of wrapping paper, 5 of saddlery and harness, 5 of tin, copper, and sheet-iron ware, 2 of woollen goods, 3 breweries, 6 flour mills, 1 planing mill, and 4 saw mills. Capital, Iowa City. **IX.** A W. county of Missouri, drained by branches of Black river; area, 785 sq. m.; pop. in 1870, 24,648, of whom 1,458 were colored. The surface is mostly prairie, diversified with large tracts of timber. The soil is generally good and suitable for pasturage, and there are rich beds of coal. The Pacific railroad of Missouri passes through it. The chief productions in 1870 were 462,990 bushels of wheat, 1,946,741 of Indian corn, 356,351 of oats, 106,731 of potatoes, 18,700 lbs. of tobacco, 43,256 of wool, 367,464 of butter, and 12,049 tons of hay. There were 9,732 horses, 2,187 mules and asses, 7,161 milch cows, 14,516 other cattle, 16,865 sheep, and 36,152 swine; 2 manufacturing factories of agricultural implements, 5 of carriages, 1 of iron castings, 6 of saddlery and harness, 5 of tin, copper, and sheet-iron ware, 5 flour mills, and 3 saw mills. Capital, Warrensburg. **X.** An E. county of Kansas, bordering on Missouri, and bounded N. W. by Kansas river; area, 472 sq. m.; pop. in 1870, 13,684. It is watered by several streams, and has a fertile soil. The Kansas City and Santa Fé division of the Leavenworth, Lawrence, and Galveston railroad, and the Missouri River, Fort Scott, and Gulf line pass through the county. The chief productions in 1870 were 71,835 bushels of wheat, 1,074,186 of Indian corn, 335,056 of oats, 112,046 of potatoes, 219,358 lbs. of butter, 24,850 of cheese, and 16,399 tons of hay. There were 4,798 horses, 4,518 milch cows, 6,701 other cattle, 3,691 sheep, and 10,342 swine. Capital, Olathe. **XI.** A S. E. county of Nebraska, intersected by the Big Nemaha river, and drained by the S. fork of the Little Nemaha; area, about 375 sq. m.; pop. in 1870, 3,429. It contains extensive fertile prairies, with good timber along the streams. Coal and limestone are abundant. The chief productions in 1870 were 81,454 bushels of wheat, 113,495 of Indian corn, 32,914 of oats, 21,341 of potatoes, 58,107 lbs. of butter, and 4,545 tons of hay. There were 671 horses, 533 milch cows, 999 other cattle, and 1,442 swine. Capital, Tecumseh.

**JOHNSON, Alexander Bryan**, an American author, born at Gosport, England, May 29, 1786, died in Utica, N. Y., Sept. 9, 1867. He came to the United States in 1801, and settled at Utica, where he was a banker for many years. He was admitted to the bar, but never practised. From his youth he had given all his leisure to the study of problems in intellectual philosophy, and especially of the relations between knowledge and language. He attempted to show the ultimate meaning of words, apart from their meaning as related to each other in ordinary definition, and thus to ascertain the nature of human knowledge as it exists independent of the words in which it is expressed. His publications include "Philosophy of Human Knowledge, or a Treatise on Language" (New York, 1828); "Treatise on Language, or the Relation which Words bear to Things" (1836); "Religion in its Relation to the Present Life" (1840), in which he aims to establish the congruity of Christian precepts with man's physical, intellectual, and emotional nature; "The Meaning of Words Analyzed into Words and Unverbal Things, and Unverbal Things Classified into Intellections, Sensations, and Emotions" (1854), in which he confesses that he had been 50 years in arriving at a clear comprehension of the object of his search; "Physiology of the Senses, or How and What we See, Hear, Taste, Feel, and Smell" (1856); "Encyclopedia of Instruction, or Apologues and Breviates on Men and Manners" (1857); and several works on financial and political topics.

**JOHNSON, Andrew**, seventeenth president of the United States, born in Raleigh, N. C., Dec. 29, 1808. His father, Jacob Johnson, who died in 1812, was city constable, sexton, and porter of the state bank. Extreme poverty prevented Andrew from receiving any schooling, and at the age of 10 he was apprenticed to Mr. Selby, a tailor. A gentleman was in the habit of visiting the shop and reading to the workmen, generally from "The American Speaker;" and Andrew became intensely interested, especially in the extracts from the speeches of Pitt and Fox. He determined to learn to read, and having done this, he devoted all his leisure hours to the perusal of such books as he could obtain. In the summer of 1824, a few months before his apprenticeship expired, he got into trouble by throwing stones at an old woman's house, and ran away to avoid the consequences. He went to Laurens Court House, S. C., and obtained work as a journeyman tailor. In May, 1826, he returned to Raleigh. Mr. Selby had moved into the country, and Johnson walked 20 miles to see him, apologized for his misdemeanor, and promised to pay him for the unfulfilled portion of his apprenticeship. Selby required security, which Johnson could not furnish; and in September he went to Tennessee, taking with him his mother, who was dependent upon him for support. He worked for

a year at Greenville, during which time he married, and, after a vain search for a more desirable home further west, finally settled there. Thus far his education had been limited to reading; but now, under his wife's instruction, he learned to write and cipher. Taking an interest in local politics, he organized in 1828 a working men's party, to oppose the so-called aristocratic element which had always ruled the town. Considerable excitement ensued, and Johnson was elected alderman by a large majority. He was reelected in each of the two following years, and in 1830 was chosen mayor, which office he held three years. During a portion of this time he was prominent in a debating society formed by some young men of the neighborhood and students of Greenville college. One of the students says: "On approaching the village, there stood on the hill by the highway a solitary little house, perhaps ten feet square. We invariably entered when passing. It contained a bed, two or three stools, and a tailor's platform. Here we delighted to stop, because one lived here whom we knew outside of school, and made us welcome; one who would amuse us by his social good nature, taking more than ordinary interest in catering to our pleasure." In 1834 the county court elected Johnson a trustee of Rhea academy; and in that year he was also active in securing the adoption of the new constitution of the state. In the summer of 1835 he offered himself as candidate for a seat in the lower house of the legislature, and announced that he was a democrat. Meeting with a cool reception from the leaders of that party, he entered the canvass personally, and in his first speech made such a vigorous and well sustained attack on the political career of his whig opponent that their opposition soon ceased, and he was elected. The most important measure brought before that legislature was a bill which involved the state in a debt of \$4,000,000, for a vast scheme of internal improvements, consisting chiefly of macadamized and turnpike roads. Johnson strenuously opposed it, on the ground that no such debt should be incurred until the question had been submitted to the people, and predicted that the scheme would only result in a squandering of the money, without securing the benefits it promised. The bill became a law, and was so popular that in the election of 1837 Johnson failed to be returned to his seat. But before the expiration of the next two years the evils he predicted had developed themselves; many of the works were abandoned, and some of the companies had defrauded the state. In 1839 he was again elected. In the presidential contest of 1840 he canvassed eastern Tennessee in favor of Mr. Van Buren, and was a candidate on the democratic ticket for elector at large. In 1841 he was elected to the state senate, into which he introduced a judicious measure for internal improvements in the eastern part of the state. He was elected

to congress from the first district of Tennessee in 1843, took his seat in December of that year, and held it by successive reelections for ten years. During this time he advocated the bill refunding the tax imposed on Gen. Jackson at New Orleans, the annexation of Texas, the war with Mexico, the tariff of 1846, and general retrenchment in the expenses of the government. He sustained President Polk in his acceptance of the parallel of 49° as a settlement of the Oregon boundary question, and was conspicuous in urging the passage of a homestead law. On Aug. 2, 1848, he delivered an elaborate speech in favor of the veto power. In 1853 he was elected governor of Tennessee, over Gustavus A. Henry, the whig candidate; and in 1855 he was reelected, over Meredith P. Gentry, candidate of the whigs and the "know-nothings." The contest was exciting, and violence and threats of murder were frequent. At one meeting Johnson appeared with a pistol in his hand, laid it on the desk, and said: "Fellow citizens, I have been informed that part of the business to be transacted on the present occasion is the assassination of the individual who now has the honor of addressing you. I beg respectfully to propose that this be the first business in order. Therefore if any man has come here to-night for the purpose indicated, I do not say to him, let him speak, but let him shoot." After pausing for a moment, with his hand on his pistol, he said: "Gentlemen, it appears that I have been misinformed. I will now proceed to address you on the subject that has called us together."—On Dec. 7, 1857, Mr. Johnson took his seat in the United States senate, to which he had been elected for a full term by the legislature of Tennessee. Here, as in the lower house, he persistently urged the passage of a bill giving 160 acres of the public land to any citizen who would settle upon it and cultivate it a certain number of years; and he was soon recognized as the leading advocate of that measure. The bill was finally passed by more than a two-thirds vote in each house; but President Buchanan vetoed it, and the veto was sustained. In 1858 Johnson was one of the foremost opponents of the bill introduced by Jefferson Davis to increase the standing army because of the troubles in Utah, and offered a substitute which authorized the raising of 4,000 volunteers, to be dismissed when the trouble was over; which was modified so as to authorize two regiments of 18-month men, and passed. In 1859 he was conspicuous in his efforts to secure the passage of a bill to retrench the government expenses, and in his opposition to the Pacific railroad. On the question of slavery, Johnson as a southern man and a democrat generally went with his party. He accepted slavery as an existing institution, protected by the constitution, but believed it would some day come to an end, and held that it must be kept subordinate to the Union at every hazard. He opposed the compromise measures of 1850, but finally voted for

them. In the Charleston-Baltimore democratic convention of 1860 he was the presidential candidate of the Tennessee delegation. In the canvass which followed he supported Breckenridge and Lane, the candidates of the ultra southern wing of his party. But when the purposes of the leaders of that wing became apparent, and secession was actually introduced, he took ground against them, and in a speech delivered in the senate, Dec. 18 and 19, set forth the injustice and folly of the movement, and placed himself unreservedly on the side of the government. The legislature of Tennessee having voted the state out of the Union, in spite of the fact that the people had voted down a proposition for a convention on the subject, a reign of terror began there, and Johnson, returning home in May, 1861, was in peril of his life. On one occasion a mob entered a railroad car with the intention of lynching him; but he met them boldly, pistol in hand, and they retired. In nearly every city of the state he was burned in effigy. He took a prominent part in the East Tennessee Union convention of May 30, and on his arrival at Cincinnati (June 19) he received an ovation from the loyal citizens. On Jan. 31, 1862, he spoke in favor of the expulsion from the senate of Jesse D. Bright of Indiana. In the winter of 1861-'2 large numbers of Unionists were driven from their homes in East Tennessee, and sought refuge in Kentucky. Mr. Johnson met them there, relieved the immediate wants of many from his own purse, and used his influence with the government for the establishment of Camp Dick Robinson, where these refugees found shelter, food, and clothing, and were to a large extent organized into companies and mustered into the national service. His own wife and child had been turned out of their home, and his nine slaves confiscated.—On March 4, 1862, President Lincoln nominated Andrew Johnson to be military governor of Tennessee; the senate confirmed the nomination; and on the 12th of that month he reached Nashville and assumed the duties of the office. The insurgent state government had been moved to Memphis when the capital was occupied by national troops. On March 18 Governor Johnson issued a proclamation which recited briefly the history of the state, the means by which it had been placed in hostility to the federal government, the reestablishment of the national authority, and the abdication of the governor and dissolution of the legislature; announced his own appointment as military governor, and his purpose to fill the state and county offices by appointment until order could be restored; and declared that, "while it may become necessary, in vindicating the violated majesty of the law and reasserting its imperial sway, to punish intelligent and conscious treason in high places, no merely retaliatory or vindictive policy will be adopted." This proclamation attracted wide attention, because it was looked

upon as indicating the policy of the federal administration; but it produced little effect on the secession element in Tennessee. He next addressed a letter to the mayor and council of Nashville, requiring them to take the oath of allegiance. They refused, and he immediately declared their offices vacant, and appointed other citizens to fill them temporarily. Two months later, to protect Unionists from outrage at the hands of roving bands of secessionists, he issued a proclamation of which the following is the essential portion: "In every instance in which a Union man is arrested and maltreated by the marauding bands aforesaid, five or more rebels, from the most prominent in the immediate neighborhood, shall be arrested, imprisoned, and otherwise dealt with as the nature of the case may require; and further, in all cases where the property of citizens loyal to the government of the United States is taken or destroyed, full and ample remuneration shall be made to them out of the property of such rebels in the vicinity as have sympathized with, and given aid, comfort, information, or encouragement to the parties committing such depredations." Three days after issuing this proclamation, he addressed a Union meeting at Nashville in a three-hour speech, which was most enthusiastically received. Here the tide of affairs seemed to turn; and similar meetings in various parts of the state greatly strengthened the Union cause. But Tennessee was still overrun by guerillas, and Johnson pursued his task amid continual personal peril. He showed courage and ability in maintaining order in Nashville while it was threatened by Gen. Bragg, and preventing the evacuation or surrender of the place, in providing for Union refugees, and in raising troops for the government. On Dec. 8, 1862, he issued a proclamation ordering elections to fill vacancies in the 37th congress; and on the 15th an order levying five monthly assessments on certain citizens of Nashville, "in behalf of the many helpless widows, wives, and children in the city of Nashville who have been reduced to poverty and wretchedness in consequence of their husbands, sons, and fathers having been forced into the armies of this unholy and nefarious rebellion." On Feb. 20, 1863, he issued a proclamation warning all persons who occupied property belonging to "traitors" not to pay the rents until a person should be appointed to receive them in the name of the United States. In a speech at Columbus, Ohio, March 3, he expressed his belief that slavery would be extinguished by the war, but declared that the emancipation proclamation would not at all affect the question. On the first Saturday in March, 1864, by his order, elections were held for state and county officers, and the usual machinery of civil government was once more set in motion.—On June 7, 1864, the republican convention at Baltimore, having renominated Mr. Lincoln for the presidency, nominated Andrew Johnson for the vice presidency.



He accepted the nomination in a long letter, in which he set forth fully his views on the questions at issue. On Sept. 30 he issued a proclamation ordering an election in Tennessee for presidential electors, and prescribing a rigid test oath as the condition of suffrage. On his inauguration as vice president (March 4, 1865) Johnson delivered an incoherent address, which was severely censured. President Lincoln was assassinated on the evening of April 14, and died the next morning. The members of the cabinet, excepting Mr. Seward, at once addressed a note to Mr. Johnson announcing the fact, and urging his immediate qualification as president. Accordingly, at 10 o'clock he took the oath of office, in the presence of the chief justice, a portion of the cabinet, and several congressmen, at his room in a hotel. On April 17 he made a speech in which he said: "The American people must be taught, if they do not already feel, that treason is a crime and must be punished; that the government will not always bear with its enemies; that it is strong not only to protect, but to punish. In our peaceful history, treason has been almost unknown. The people must understand that it is the blackest of crimes and will be surely punished." Though in the same speech he said, "In regard to my future course I will now make no professions, no pledges," yet the whole country looked upon these expressions as foreshadowing a severe policy in dealing with the secessionists. But it soon became evident that this expectation was to be disappointed, and the result was the alienation from President Johnson of almost the entire body of the party that had elected him. On May 1 he appointed a military commission for the trial of those immediately concerned in the assassination conspiracy, and offered \$100,000 for the arrest of Jefferson Davis, and smaller amounts for several others, on the ground that they had aided and incited that conspiracy. On May 9 a new set of rules regulating trade with the southern states was promulgated, and on June 24 all restrictions were removed. An order for the restoration of Virginia to her relations with the federal government was issued May 9; and on May 29 two proclamations were promulgated, one establishing a provisional government in South Carolina, the other granting a general amnesty, on condition of their taking an oath of allegiance, to all persons engaged in the rebellion, with the exception of 14 specified classes, persons included in any of which might obtain pardon by a special application to the president. The appointment of provisional governments for the other insurgent states followed at brief intervals. On the assembling of congress in December, a determined opposition on the part of the majority to the reconstruction policy of the president was at once developed. The point at issue was, whether the seceding states should be at once admitted to representation in congress, and resume all the rights

they enjoyed before the civil war, without further guarantees of good faith than the surrender of their armies, and with no provision for protecting the emancipated blacks in the enjoyment of their freedom and securing them the full rights of citizenship. A joint committee of 15 was appointed, to which were referred all questions concerning the recognition of these states, and the credentials of persons sent from them as senators or representatives were laid on the table, to await the action of that committee. Congress passed an act known as the "civil rights bill," and another for the extension of the freedmen's bureau, both of which the president vetoed, and the bills were then reconsidered and passed over the veto. In a speech delivered before the White House, Feb. 22, 1866, the president characterized the position assumed by congress as a new rebellion; and thereafter, in messages and speeches, he maintained an open hostility to the majority of that body. In June, 1866, a call was issued for a convention to be held at Philadelphia on Aug. 14, of delegates from every state and territory. Its specific object was not defined; but it was understood to be the foundation of a new party, on the basis of President Johnson's reconstruction policy. It failed of any practical effect, though some leading members of the dominant party attended or approved it. The members of President Lincoln's cabinet had remained in office; but in July the postmaster general, Mr. Denison, the attorney general, Mr. Speed, and the secretary of the interior, Mr. Harlan, resigned their offices, because of disagreement with the president; and their places were filled by A. W. Randall, Henry Stanbery, and O. H. Browning, respectively. On Aug. 28 President Johnson, accompanied by Secretaries Seward, Welles, and Randall, Gen. Grant, Admiral Farragut, and others, left Washington for Chicago, to be present at the laying of the corner stone of a monument to Stephen A. Douglas. They went by way of Philadelphia, New York, and Albany; and at every important place the president addressed the assembled crowd, entering very fully into a discussion of his policy, and often denouncing the action of congress. An expression which he frequently repeated in these speeches gave rise to the popular quotation, "swinging round the circle." The effect of this conduct upon himself was disastrous, and the autumn elections indicated a decided popular approval of the position maintained by congress. In June that body had resolved that no state should be readmitted until it had ratified the proposed 14th amendment to the constitution, which made all persons born or naturalized in the United States citizens thereof, and of the state wherein they resided; and in the session of 1866-7 it passed acts requiring the elective franchise to be granted without distinction of color in the territories before they should be admitted as states, and similarly extending the franchise in

strict of Columbia. All these measures determined opposition of President Johnson; but his vetoes were regularly overruled by the constitutional majority in congress. His argument against such measures was that they "initiated an untried experiment for a people who have said, with one that it is not for their good," and that were unconstitutional. On March 2, congress passed over the president's veto dividing ten of the seceding states into military districts, and making the civil matters therein subject to the authority of the United States, exercised through the military commanders. After appointing the military commanders, President Johnson requested the opinion of Mr. Stanbery, the attorney general, on the legal questions arising from the reconstruction acts; and this opinion, after being read in the cabinet, where Mr. Stanton objected to those portions calculated to curtail the law, was issued to the district commanders as an order. Gen. Sheridan, commanding the fifth district, soon after reported to President Grant, commander-in-chief, that "the opinion of Mr. Stanbery's opinion is beginning to work itself by a defiant opposition to all the military commanders, by impeding and rendering helpless the civil officers acting under their appointment." In July congress passed an act declaring the meaning of the reconstruction act, and making the conduct of the military commanders subject only to the approval of the general of the army. This was passed, and passed over the veto. The only thing left to the president was to change military commanders, which he did before the end of the year. On Aug. 12, 1867, the president notified Mr. Stanton his suspension from office as secretary of war, and the appointment of Gen. Grant as secretary *ad interim*. Mr. Stanton turned over the office to Gen. Grant, submitting, "under protest, to surmount," but denying the right of the president to remove him. This denial was based on the tenure-of-office act (passed March 7), which provided that no such removal could be made without the consent of the senate, and that appointments to vacancies occurring during the recess of congress should be subject to the approval of the senate at its next session. On Aug. 20 the president issued a proclamation declaring that order, and civil authority existed once again throughout the United States; and on Aug. 21 he proclaimed an amnesty which restored nearly all the white inhabitants of the rebel states from any liability to confiscation of property, and restored to them the right of suffrage. When congress assembled in September the president sent to the senate a message setting forth his reasons for the removal of Stanton; but that body refused to sanction the removal, and Gen. Grant immediately re-assumed the office into Mr. Stanton's hands. On Sept. 21, 1868, Mr. Stanton was again in-

formed of his removal, and of the appointment of Gen. Lorenzo Thomas as secretary of war *ad interim*. When the senate was officially informed of this action, it passed a resolution declaring that "the president has no power to remove the secretary of war and designate any other person to perform the duties of that office." Mr. Stanton therefore refused to vacate his office. On the following day the house of representatives passed a resolution that the president be impeached for high crimes and misdemeanors (yeas, 126; nays, 47; not voting, 17). The articles of impeachment were agreed to by the house on March 3, and presented to the senate on the 5th. The specifications were based on the president's removal of Mr. Stanton, his expressions in public speeches of contempt for congress, declaring the 39th not a constitutional congress, and his hindrance of the execution of some of its acts. The trial began on March 23, the president appearing by counsel. In his defence he asserted that his reconstruction policy was in pursuance of a course which had been marked out and determined upon by President Lincoln and his cabinet; and that Mr. Stanton himself had expressed his emphatic opinion of the unconstitutionality of the tenure-of-office act, when its veto was under consideration. On May 16 the senate voted upon the article in reference to contempt of congress and hindrance of execution of its acts, and on the 26th upon that in reference to the removal of Mr. Stanton. In each case the vote stood: guilty, 35; not guilty, 19. So the president was formally acquitted, as a two-thirds vote is required to convict. Mr. Stanton thereupon resigned his office, and was succeeded by Gen. Schofield. At the democratic national convention held in New York, July 4, 1868, Mr. Johnson's name was presented as a candidate for the presidency, and on the first ballot he received 65 votes, leading all other candidates except George H. Pendleton, who received 105. On the successive ballots he lost rapidly, until on the 19th he received no votes. On July 4 President Johnson issued a proclamation of pardon to all persons except those under presentment or indictment before a United States court; and on Dec. 25 a full pardon to everybody who had participated in the rebellion. On March 4, 1869, he was succeeded in the presidential office by U. S. Grant, and retired to his home in Greenville, Tenn. In 1870 he was a candidate before the legislature of Tennessee for a seat in the United States senate, but was defeated by two votes. In 1872 he was an independent candidate for congressman at large, and divided the democratic vote with the confederate Gen. B. F. Cheatham, which resulted in the election of Horace Maynard, the republican candidate.—See "Life and Public Services of Andrew Johnson," by John Savage (New York, 1865); "Life, Speeches, and Services of Andrew Johnson" (Philadelphia, 1865); "Speeches of Andrew

Johnson," with a biographical introduction by Frank Moore (Boston, 1865); "Life and Speeches of Andrew Johnson, President of the United States," by Lillian Foster (Philadelphia, 1866); "Life and Times of Andrew Johnson" (New York, 1866); "Impeachment and Trial of Andrew Johnson" (Philadelphia, 1868); and "Proceedings in the Trial of Andrew Johnson" (Washington, 1868).

**JOHNSON, Eastman**, an American painter, born at Lovell, near Freyburg, Me., July 29, 1824. He first became known for his drawings in crayon, and in 1849 went to Düsseldorf, where he studied for two years. He afterward resided at the Hague for four years, and executed there the "Savoyard" and "Card Players," his earliest elaborate paintings in oil, besides a number of portraits and genre paintings. He also visited the principal galleries and studios in Holland, Italy, and France. In 1856 he removed to Paris, but returned the same year to America, and has since resided for the most part in New York. He gives his attention mainly to genre painting, finding his favorite subjects in the American rustic and negro, and in glimpses of household and childish life. His paintings are characterized by clearness, vigor, and faithfulness to nature. Among the best known are "The Old Kentucky Home" (1859), first exhibited in New York, and sent with "Mating" (1860) and "The Farmer's Sunday Morning" (1866) to the Paris universal exposition in 1867; "The Barefoot Boy" (1860), illustrating Whittier's poem: "The Village Blacksmith" (1864); "Fiddling his Way" (1865); "The Boyhood of Abraham Lincoln" and "The Field Hospital" (1867); "The Pension Claim Agent" (1868); "Our Father who art in Heaven" (1869); "The Old Stage Coach" and "Bo-peep" (1871); "The Wounded Drummer Boy" (1872); "Dropping off" and "The Peddler" (1873). He has also, during a visit to the upper Mississippi, sketched some excellent portraits of American Indians. His "Old Kentucky Home," "Boyhood of Abraham Lincoln," and some other works, have been copied in chromolithography, and photographs have been published of the "Wounded Drummer Boy" and "Our Father who art in Heaven."

**JOHNSON, Edward**, a historian of New England, born in Kent, England, about 1600, died at Woburn, Mass., April 23, 1672. He emigrated to America probably with Gov. Winthrop in 1630. In 1632 he was engaged in trade at Merrimack, but appears to have resided usually at Charlestown. He was on the committee appointed to superintend the foundation of a new town and church at the place now called Woburn. In 1643 he went to Providence with Capt. Cook's party to seize Gorton, and in the same year was elected a member of the legislature of Massachusetts, in which he continued to sit till 1671, with the exception of the year 1648. In 1655 he was chosen speaker of the house. He was recorder of Woburn from the time of its incorporation till

his death. In 1665 he was one of the members deputed to hold conference with the commissioners sent from England by Charles II. He wrote a "History of New England from the English Planting in 1628 till 1672, or Wonder-Working Providence of Zion's Saviour" (London, 1654), which, notwithstanding its defective and desultory style, is interesting and valuable. It has been reprinted in the second series of the Massachusetts historical collections, scattered through vols. ii., iii., iv., vii., viii.

**JOHNSON, Isaac**, one of the original colonizers of Massachusetts, born in Clipsham, Rutlandshire, England, died in Boston, Sept. 30, 1630. He arrived at Salem with his wife, June 12, 1630, and was one of the four persons who founded the first church at Charlestown in the following month. The water there, however, being bad, Mr. Johnson and some others removed to Shawmut, now Boston, where was "an excellent spring." He superintended the first settlement of Boston, and bequeathed at his death considerable property to the colony.—His wife, **ARBELLA OF ARABELLA**, daughter of Thomas, 14th earl of Lincoln, accompanied him to New England, and died in Salem in the August subsequent to her arrival. She was usually styled the "Lady Arbella," and was highly esteemed by Winthrop, who changed the name of his ship, and called it after her.

**JOHNSON, Beverly**, an American statesman, born in Annapolis, Md., May 21, 1796. He was educated at St. John's college in that city, and at the age of 17 began to study law in Prince George's co. in the office of his father, who was chief justice of the judicial district of which that county was a part. In 1815 he was admitted to the bar, and in 1817 removed to Baltimore. He has devoted much of his time to the arguing of cases before the United States supreme court. In conjunction with Mr. Thomas Harris he reported the decisions of the Maryland court of appeals, known as "Harris's and Johnson's Reports" (7 vols., 1820-27). In 1821 he was elected a state senator for four years, and in 1825 reelected. In 1845 he was chosen a United States senator, which office he resigned in 1849 on being appointed by President Taylor attorney general of the United States. On the succession of Mr. Fillmore after the death of President Taylor, Mr. Johnson resigned that office, and resumed in Baltimore the practice of the law. In 1861 he was a member of the convention in Washington which tried to prevent the outbreak of the civil war. In 1862 he was again elected to the United States senate, and was a member from 1863 to 1869. In June of the latter year he was appointed minister to England, where he negotiated a treaty for the settlement of the Alabama claims, which was rejected by the senate. He was recalled in 1869.

**JOHNSON, Richard Hunter**, an American statesman, born near Louisville, Ky., Oct. 17, 1788, died in Frankfort, Nov. 19, 1850. He was educated at Transylvania university, and sub-

sequently studied law and practised with success. He commenced his public career as a member of the Kentucky legislature, to which he was elected at the age of 23, and in 1807 was returned to congress, and remained a member of the house till 1819. He was a firm supporter of the administration of President Madison, and upon the commencement of the war of 1812 raised a body of Kentucky mounted riflemen, whom he commanded with the rank of colonel on the Canadian frontier. He resumed his legislative duties in the autumn of that year, but upon the adjournment of congress in the spring of 1813 he immediately raised another mounted regiment, with which he was employed for several months on the Indian frontier. In September he joined Gen. Harrison, then in pursuit of Proctor, and by the decisive charge of his mounted volunteers mainly contributed to the brilliant victory gained over the British and Indians at the battle of the Thames, Oct. 5. Col. Johnson fought with distinguished valor in this engagement, and it was by his hand that the Indian leader Tecumseh is commonly supposed to have fallen. He was carried from the field desperately wounded, his person, clothing, and horse having been pierced by more than 25 bullets; but in the following February he resumed his seat in congress. In 1819 he was elected to fill a vacancy in the United States senate, of which he continued a member till 1829, when he was again returned to the house of representatives, and held his seat there till March, 1837. Having been a candidate for vice president on the Van Buren ticket in 1836, and received a large plurality of votes, though not a majority as required by the constitution, he was elected to the office by the senate, and discharged the duties of presiding officer of that body for four years. In the presidential election of 1840 he was again candidate of the democratic party for vice president, and was defeated. He returned to his farm in Scott co., Ky., after upward of 34 years' continuous public service, and thenceforth lived chiefly in retirement. He was, however, serving a term in the state legislature at the time of his death. In congress his chief efforts were against the discontinuance of the Sunday mails, and in behalf of soldiers of the revolution or of the war of 1812 who applied for pensions. He was the author of the law abolishing imprisonment for debt in Kentucky.

**JOHNSON, Samuel**, an American clergyman, first president of King's (now Columbia) college, New York, born in Guilford, Conn., Oct. 14, 1696, died in Stratford, Conn., June 6, 1772. He graduated at Yale college in 1714, and two years later was appointed tutor there. In 1720 he was ordained as a Congregational minister, and settled at West Haven. He relinquished his pastoral charge in 1722, and soon after, in company with Mr. Cutler, rector of the college, and another gentleman, sailed for England, where they received

episcopal ordination in 1723, and in May he received the degree of A. M. from the university of Oxford. He soon returned to America, bearing a commission as missionary of the society for the propagation of the gospel in foreign parts, and settled in Stratford, Conn., as rector of an Episcopal church there. In 1743 he received the degree of D. D. from the university of Oxford. In 1746 he published "A System of Morality," and about the same time composed a compend of logic and metaphysics, and another of ethics, originally prepared for the use of his sons. The two latter were printed by Franklin (Philadelphia, 1752), as text books for the university of Pennsylvania. In 1753 he was invited to become president of the newly founded college in New York; and having declined the presidency of the university of Pennsylvania, he entered upon his duties in New York in 1754. In addition to teaching the classes he assisted in planning the college edifices, and made earnest appeals to his friends in England for assistance in its endowment. During the nine years of his presidency he lost his wife, younger son, and stepson, and became so much depressed as to be unwilling to remain longer in charge of the college. He accordingly wrote to England for a successor, and in 1763 resigned and returned to Stratford. During his presidency he published one or two small works, and after his return to Stratford, where he resumed his parochial duties, revised his previous works, and published an English and a Hebrew grammar.—See "Life of Dr. Samuel Johnson," by E. E. Beardsley (New York, 1874).

**JOHNSON, Samuel**, an English author, born in Lichfield, Sept. 18, 1709, died in London, Dec. 13, 1784. His father, Michael Johnson, was a bookseller and stationer, and for some time a magistrate of Lichfield; but dying in middle age, he left his family in poverty. From his birth the younger Johnson was afflicted with a malignant scrofula which permanently disfigured his face, and injured both his sight and hearing. At 10 years of age he commenced the study of Latin at the Lichfield free school, and remained there five years, and another year at a private academy in Stourbridge. On account of poverty his entrance at Oxford was delayed for two years, during which time he amused himself chiefly in reading the books in his father's shop. At length he went to Oxford with a schoolmate, the son of a neighboring gentleman, as assistant and fellow student, and was admitted to Pembroke college in 1728. His college life was disorderly, but not vicious. He especially distinguished himself in a Latin translation of Pope's "Messiah," for which he received the applause of his college, while Pope himself declared that it would be a question for posterity which was the original and which the translation. While at Oxford he showed signs of the morbid state of his brain and nervous system which affected him in all his after life; but by skilful treat-

ment, and the strong will of the patient, the disease was held in check, and the threatened wreck of intellect averted. He remained at the university about three years, left it on account of poverty without a degree, and procured employment as an usher in a school at Market Bosworth, Leicestershire. He next spent some time at Birmingham with a bookseller, who also published a small newspaper, to which Johnson contributed. Here he became acquainted with the family of Mr. Porter, a linen draper, whose widow he afterward married. About this time he executed his first literary work, a translation of Father Lobo's "Voyage to Abyssinia." He soon after issued proposals to publish by subscription the Latin poems of Politian, with a history of Latin poetry from the age of Petrarch to the time of Politian; but the work was never completed. He spent his time alternately at Birmingham and Lichfield, till after two years he was married to Mrs. Porter, who was nearly twice his age, and then he opened a private academy at Edial Hall, near Lichfield. But he obtained only three pupils, two of whom were David Garrick and his younger brother; and after trial of a year and a half the enterprise was abandoned.—In the spring of 1737 he set out for London accompanied by Garrick. He sought employment among the booksellers, and lived at the most economical rates, bearing all his privations and discouragement with a sullen fortitude. He contributed to the "Gentleman's Magazine," and at length became assistant editor of that publication. He first became known in 1738 by the publication of "London," a poem in imitation of the third satire of Juvenal, which was received with decided favor. He was recommended to the mastership of a school at Appleby, but his want of a degree disqualified him by the statutes of the corporation. A like difficulty prevented his entering the legal profession. He now contributed to the "Gentleman's Magazine" a class of papers in biography and general literature which gave a new and higher character to that work. He also wrote two or three political pamphlets against Walpole and the whig administration. At the beginning of the session of parliament in November, 1740, Johnson undertook to write imaginary reports of the debates, following the order in which the members spoke, and imitating their respective styles. The eloquence of the speeches thus produced excited universal admiration, and the sale of the magazine was greatly increased; but after a little more than two years Johnson relinquished the position, because he doubted the morality of the deception he was practising upon the world, though he still retained his connection with the magazine. Early in 1744 was published the "Life of Richard Savage," which Johnson had promised to the public immediately upon the death of its subject, a few months before. The book contributed very considerably to fix the repu-

tation of its author. The next year, among other labors, he wrote the preface and index to the Harleian miscellany, a collection of pamphlets from the library of the earl of Oxford, which had been purchased by the bookseller Osborne. In that painful drudgery Johnson toiled as a day laborer, and was treated by Osborne with an insolence that once provoked Johnson to knock him down. The same year he issued a pamphlet entitled "Miscellaneous Observations on the Tragedy of Macbeth," to which he affixed proposals for a new edition of Shakespeare. This pamphlet attracted the attention of Warburton, who was then engaged in a similar work, and was commended by him as evidently the work of "a man of parts." In 1747 Garrick became joint manager of Drury Lane theatre, and Johnson wrote a prologue to be spoken at its opening, which added greatly to his reputation. In this year he issued proposals for his "Dictionary of the English Language." The plan of the work, which indicates a thorough acquaintance with the subject, and a comprehensive knowledge of the method to be pursued in its prosecution, was addressed to the earl of Chesterfield, then one of the secretaries of state, who was ambitious of the reputation of a patron of learning, and expressed a warm interest in the enterprise. Five publishing houses were concerned in the contract. Johnson was to receive £1,575, which amount however was to cover all the incidental expenses of preparing the work for the press. To facilitate his work he removed to Gough square in Fleet street, where he had rooms properly arranged for its prosecution, being assisted by six copiers. He availed himself of whatever helps were offered in the extant works on English philology and lexicography, but relied chiefly on his own original labors. This great work occupied its author, though not exclusively, during the next seven years. A trip to Tunbridge Wells, in the summer of 1748, brought him into contact with some of the celebrities of the metropolis, among them William Pitt, Lord Lyttelton, and Speaker Onslow, who paid him marked attention. To facilitate his intercourse with his literary associates, he also this year originated a club, called from its place of meeting the "Ivy Lane Club." At its organization it consisted of ten members, of whom Johnson, Hawkins, and Dyer afterward belonged to the celebrated "Literary Club." In 1746 Dodsley brought out his "Preceptor," a compilation of choice pieces for young persons, in which first appeared Johnson's "Vision of Theodore, the Hermit of Teneriffe." To this year also belongs his second poetical production, "The Vanity of Human Wishes," an imitation of the 10th satire of Juvenal; it was printed by Dodsley, and brought its author 15 guineas. While yet residing at Lichfield Johnson had commenced a tragedy, in five acts, called "Irene," which he finished during his first two or three years in London; and Garrick,

after his accession to the management of Drury Lane theatre, undertook to bring it out. It was acted for nine successive nights, before a remarkably large and highly respectable audience, and was received with a good share of success. The author's profits amounted to £200, the copyright brought him another £100, making together a larger amount than he had hitherto received on any one occasion.—On March 20, 1750, Johnson issued the first number of the "Rambler." Its authorship was publicly confessed, but it was readily identified by all who knew anything of Johnson's character; nor did he affect any great secrecy in the matter. Its merits were generally conceded, and for two years the semi-weekly issues were continued without omission. Johnson was the sole author of all but eight of the numbers. At the same time he was chiefly occupied with his dictionary, then rapidly approaching its completion. During this period of his life his mind was remarkably vigorous and fruitful, and its vast accumulations were thrown off in profusion and with great facility. The "Rambler," though coldly regarded as a periodical, immediately became popular when collected into volumes. About this period Johnson was concerned in an attempt to prove Milton guilty of a wholesale plagiarism in his "Paradise Lost." One Lauder, a Scotch schoolmaster, pretended to have found a large share of the best portions of Milton's poem among the works of the modern Italian poets; his proofs of this grave charge embodied in a pamphlet, to which Johnson was induced to write a preface and postscript, thus by implication approving the whole action. But Lauder's pretended quotations from the modern Latin poets were found either taken from Hogg's Latin version of "Paradise Lost," or pure forgeries. Johnson was deeply chagrined, and at once acknowledged his own error, and compelled Lauder to publicly confess his falsehood. That Johnson highly appreciated Milton's genius, he about this time gave a practical demonstration. "Paradise Lost" was to be produced at Drury Lane Theatre for the benefit of Milton's granddaughter living in London in poverty. Johnson entered into the arrangement with zeal, and wrote the prologue for the occasion, which was spoken by Garrick. Early in 1752 Johnson's wife died. Notwithstanding the disparity of their ages, his early affection had changed into a settled esteem. At her death he was convulsed with grief, and yet as she lay a corpse awaiting burial he composed a funeral sermon to be spoken over her remains. His published "Prayers and Meditations" indicate his feeling. He prayed that, according to the will of God, he might be blessed with her guardianship, and with the assistance of her presence, "by appearances, visions, dreams, or in any other manner agreeable to the divine government." In 1752 Johnson engaged with Dr. Hawkesworth in

the publication of the "Adventurer," a series of periodical essays on the plan of the "Rambler." Of these 140 numbers appeared, 29 of which were written by Dr. Johnson. The dictionary was completed in 1755. Lord Chesterfield, who had received the "Plan" with great coolness, now wrote two laudatory letters in "The World," shortly before the work was printed. But Johnson rejected these tardy advances, and the dictionary was issued without a dedication. The original preface was at once a characteristic and a highly valuable essay. The merits of Johnson's dictionary are too well known to require any statement in this place. It first brought order out of the chaos of the language; and though it has been generally superseded by later compilations, yet the fundamental excellences of all modern dictionaries of the English language have their elements in that work. It greatly enhanced its author's reputation, but he was still compelled to labor unremittingly for the means of daily subsistence. He published at this time a large number of reviews in Newbery's "Literary Magazine." The proposal for an edition of Shakespeare made some years before, but not prosecuted, was renewed and a subscription opened, but the work still lingered on his hands through nine years. He next engaged with the publishers of the "Universal Chronicle," a weekly newspaper, to furnish a series of miscellaneous essays, and the "Idler" appeared in regular order for two successive years, beginning in April, 1758. Of its 103 numbers Johnson wrote all but 12. In the spring of 1759 appeared his most celebrated work, "Rasselas, Prince of Abyssinia," which he wrote in the evenings of one week, and sent to the printer as first written, receiving for it £100, out of which he paid the expenses of his mother's funeral. But if Johnson's literary labors had failed to provide him a competence, they had procured for him a greatly advanced social position, and secured him a large circle of admirers. His constitutional indolence had however become positively morbid, and he indulged in idleness just as far as his immediate necessities would allow. He seldom went abroad, lay in bed till past noon, and spent the rest of the day in promiscuous conversations with whosoever called upon him; or moped in morbid melancholy if left to himself, which, however, was not often the case. To his guests he devoted a large share of each afternoon, meanwhile regaling himself with his favorite tea, with which he solaced both his earlier and his later hours. Among his personal associates at this period were Richardson, Garrick, Reynolds, Warton, Baret, Arthur Murphy, Dr. Charles Burney, Dr. (afterward Bishop) Percy, Bennet Langton, and Topham Beauclerk. He was all this time domiciled at Gough square, where he had passed the greater portion of the years of his residence in London. Here, before the decease of his wife, he had begun to gather about

him a family group, which was afterward much enlarged, made up of a strangely assorted set of dependants and pensioners. Anna Williams, the blind daughter of a Welsh physician; Robert Levett, who practised medicine among the very poor, and often received his fees in liquor; Mrs. Desmoulins and her daughter, who had no other claim upon his benevolence than the service which the father of the former, Dr. Swinfen, had rendered to Johnson in a professional capacity in his youth; and Francis Barber, his negro servant, were among the inmates of his house.—Johnson had an implicit belief in the supernatural and invisible world. He practically adopted the maxim that it is safer to believe too much than too little. He believed in the existence and appearance of disembodied spirits, and that they might be manifested to our cognizance. A case of this kind occurred in 1763, which exposed Johnson to the ridicule of his enemies. Certain strange phenomena in the form of "rappings" about the bed of a young girl, in a house in Cock lane, caused a considerable excitement, and a number of gentlemen, of whom Johnson was one, attempted to solve the mystery. Their examinations satisfied them that the whole was a cheat and imposture, and Johnson afterward wrote out a statement of it for the "Gentleman's Magazine." But the affair was seized upon by Johnson's enemies, as exposing a vulnerable point for their attacks. Churchill, in his poem "The Ghost," depicted Johnson in such broad caricature that it was at once recognized; and Foote the comedian proposed to present him on the stage for the amusement of the town, but abandoned his purpose upon being assured that Johnson was preparing to chastise him if he undertook it.—In 1762 Johnson received from the king a pension of £300. He had often stigmatized the whole business of giving and receiving pensions as the basest kind of bribery; but it being urged by his friends that the whole nation was his debtor for what he had written, and especially for the dictionary, and the premier assuring him that no service to the ministry would ever be expected from his pen in return for the favor, he allowed his scruples to be overcome. Early in 1765 the long promised and long delayed edition of Shakespeare made its appearance, with an elaborate preface discussing the genius and writings of the dramatist, and with a concise account of each play, and notes and commentaries, both original and selected, on various passages. But the work was not such as the reputation of the editor had promised. He no doubt possessed many valuable qualifications for such a work, yet he was better adapted for original compositions, and in this case his powers were but moderately called into requisition. His own estimate of the work did not differ greatly from that of others. He had now fully attained the height of his ambition as a scholar and man of letters. His claim to the first place among his peers

was cheerfully conceded to him with almost absolute unanimity. The university of Oxford, from which he sought in vain for the degree of M. A. when it would have been valuable to him, now accorded a tardy recognition of his greatness by granting to him by diploma the honor of LL. D. He had received the same degree ten years earlier from Dublin university; but after returning thanks for the honor, he declined to wear it, and would not consent to be called doctor till Oxford had given him the title.—About this time Johnson was introduced by Arthur Murphy to Mr. Thrale, a wealthy brewer of Southwark. Thrale was a man of a well cultivated mind, of sound judgment, and great force of character; and his wife, whose name has become intimately connected with Johnson's history, was also a person of some learning and of almost unbounded vivacity, flippant, versatile, and addicted to hero worship. The acquaintance thus begun soon grew into friendship. Johnson dined with his new friends weekly during several succeeding months, when, having suffered by an attack of sickness, he was removed in 1764 to their residence, and had apartments assigned him in their house at Southwark, and also in their villa at Streatham. Thrale was a member of parliament for Southwark, and as his political creed was nearly allied to that of his guest, Johnson became interested in the politics of the times, and there was at one time a purpose to bring him into parliament; but the government, fearing that he would not prove sufficiently facile, did not encourage it, and so the design was abandoned. He accompanied his friends on their annual excursions visiting various parts of the kingdom with them, and also making a visit of several weeks at Paris. His connection with this family not only brought him innumerable comforts and pleasures, but it also afforded him a retreat from his own strangely assorted household, where strifes and complaints were loud and frequent. It continued till the death of Thrale, and the subsequent marriage of his widow to Signor Piozzi, greatly to the chagrin of her friends.—A few years previous to his connection with the Thrales, Johnson had formed another association, by which his future renown was to be very largely affected. In 1763 James Boswell, a young man, the son of a Scotch judge, visited London and obtained an introduction to Johnson. Boswell was loose in life and conversation, conceited, meddling, and inquisitive, yet endowed with an insight into character, and an appreciation of qualities the furthest possible removed from his own. Johnson fancied this young Scot on first acquaintance, and Boswell at once fastened himself upon him. They were together almost daily, rambling in the parks, supping together at the Mitre tavern, or wandering the streets till after midnight. Boswell lived in Johnson's shadow, noting his words, describing his manners, and detailing the most trivial occurrences; all of

which were afterward embodied in his "Life of Johnson," by which, much more than by the dictionary, or the "Rambler," or even by "Rasselas" and the "Vanity of Human Wishes," Johnson is known.—The founding of the "Literary Club" belonged to this period. Reynolds and Johnson led in the movement, and among the original nine members were Hawkins, Langton, Beauclerk, Goldsmith, and Burke. Goldsmith had a few years before become somewhat intimate with Johnson, by whom he was greatly esteemed as a writer and cherished as an associate. During its earlier years the club held weekly meetings for conversation, which contributed not a little to maintain the balance of Johnson's strangely affected mind. New members were admitted with great caution, and for several years the whole number did not exceed 12. In 1778 it had grown to 26, and two years later to 35, when 40 was fixed as its complement. The club is still in existence, but it has become rather a learned than a convivial society.—Johnson's indolent and purposeless mode of life proved highly unfavorable to his spirits. His "Prayers and Meditations," published after his death, indicate the unhappy state of his mind. He was accustomed to write bitter things against himself in his penitential moments, and especially during Lent. Sometimes his melancholy verged almost on insanity; and again he would pass suddenly to the most extravagant hilarity. His ordinary manners, especially in his later years, were strangely eccentric. He talked much to himself, muttering in a vocal but generally inaudible undertone. He was never still, but sat with head inclined over the right shoulder, his vast trunk swaying backward and forward, and his hand keeping up a corresponding motion upon his knee. At times he would make a kind of clucking sound, and again a suppressed whistle, and still more frequently a humming noise, accompanied with a vacant smile. His conversation was often violent and discourteous, and he delighted in contradictions. During the years from 1770 to 1775 he produced several political pamphlets, all in the interest of the government, and designed to meet some immediate necessity. The last of these, "Taxation no Tyranny" (1775), was written to controvert the remonstrance of the American congress against taxation without representation. In this Johnson sustained the British government in its measures against the colonies, and predicted the speedy subjugation of America. In 1773 he made a tour to the highlands of Scotland and the Hebrides, through the persuasion of Boswell, who became his fellow traveller, and afterward the chronicler of the journey, of which an account was also written by Johnson. While in Scotland Johnson made inquiries respecting the original manuscripts from which Macpherson pretended to have translated the poems of Ossian, and came away with the conviction that a large share of that work was a forgery, and the rest

of comparatively modern origin. His avowal of this conviction after his return led to a violent controversy between himself and the professed translator. In 1774 he made a tour in Wales with Mr. and Mrs. Thrale. His last considerable literary work, the "Lives of the English Poets," in four volumes, appeared from 1779 to 1781, when their author was over 70 years old; they were undertaken at the request of the booksellers, and performed by irregular impulses. In some respects this was one of the best written of all his works, simple in its style, genial and appreciative in its spirit, and full of interesting statements and valuable criticisms.—About the date of the close of that work the hand of death began to be busy with those about him. Mr. Thrale died in 1781, and a few months later he removed to his own house. In 1782 Levett died, and the next year Mrs. Williams followed him. Some time before the last event he had suffered temporarily from a partial paralysis of the vocal organs. In the latter part of the same summer he once more visited his native town; but as winter drew on he was again brought down, and his whole system became swollen with dropsy. By the assiduity of his friends, and skilful medical treatment, he so far recovered that during the next summer he visited Derbyshire and was again at Lichfield. Late in the following autumn he grew worse. To physical suffering he was comparatively indifferent, and when near his end he earnestly entreated his attendants to spare no efforts, however painful, to prolong his life. He anticipated death with horror; but as his last hour approached his forebodings at length gave place to humble confidence in the divine clemency.—Few names are more conspicuous in the annals of English literature than that of Dr. Johnson. Though scarcely reckoned among English poets, his productions in that department sufficiently vindicate his claim to a recognition, and not a few judicious critics have believed that with equal devotion to that kind of writing he would have rivalled Pope or Dryden. As an essayist he is ranked with Addison and Steele, whom he imitated only as to the form of his pieces, impressing whatever he thus wrote with his own individuality. He lacked their vivacity and variety, and especially their genial good humor, but surpassed them in depth of reflection and nervous energy of style. He especially excelled in biographical writing, and among his numerous sketches of personal history and mental portraits are some that may be studied as models of their kind. As a critic, his judgment was clear and discriminating, and such was his independence that he often condemned the popular favorites of the day, and in most cases posterity has confirmed his decisions. His fictions are chiefly moral allegories; for so fully was he intent on inculcating the practical lesson of life, that it was constantly before him, and gave form and coloring to his purely imaginative productions.—The only complete



edition of Johnson's works is that of Oxford (11 vols. 8vo, 1825). That by Hawkins (15 vols. 8vo, London, 1787-9) contains several pieces not written by Johnson. That by Murphy not containing the parliamentary debates (12 vols. 8vo, London, 1792), has been frequently reprinted, and in a compact form by Bohn (2 vols. 8vo, London, 1850). Lives of Johnson are numerous. Boswell's (2 vols. 4to, London, 1791) has been many times edited. Croker's edition (5 vols. 8vo, London, 1831) is one of the best; and an exact reprint of the first edition, with notes by Percy Fitzgerald, appeared in 1874 (3 vols., London).

**JOHNSON, Walter Rogers**, an American physicist, born in Leominster, Mass., June 21, 1794, died in Washington, April 26, 1852. He graduated at Harvard college in 1819, and in 1821 became principal of the academy at Germantown, Pa. In 1826 the Franklin institute established a high school in Philadelphia, to give the industrial classes cheap instruction in sciences and arts, according to a plan of Mr. Johnson, and gave him the chair of mechanics and natural philosophy. He added to his instructions a public course of lectures on mechanics and philosophy, under the direction of the institute, which were largely attended by both sexes. In 1836 he commenced a series of geological investigations, with special reference to the coal formations and iron ores of Pennsylvania. In 1837 he was appointed to take charge of the department of magnetism, electricity, and astronomy in the United States exploring expedition, but he resigned owing to changes of the original plan. In 1839 he was appointed to the chair of chemistry and physics in the medical department of the university of Pennsylvania. In 1843 he entered upon a course of investigations, under the authority of congress, into the character of the different varieties of coal, and their absolute and relative values for generating steam and heat and producing illuminating gas, of which a report was published in 1844. He subsequently made scientific researches on other subjects connected with the navy department; and in 1845, under appointment of the city authorities of Boston, he examined the sources from which a supply of pure water might be brought to that city. He participated in the organization of the American association of geologists, and, at its subsequent reorganization as the American association for the advancement of science, was its first secretary.

**JOHNSON, I. Sir William**, baronet, a British general and colonial officer, born at Warrentown, county Down, Ireland, in 1715, died near Johnstown, N. Y., July 11, 1774. He was a younger son of Christopher Johnson, an Irish gentleman of good family. Educated to a mercantile life, his career was entirely changed by the refusal of his parents to permit him to marry a lady with whom he had fallen in love. His uncle, Admiral Sir Peter Warren, had married a daughter of Stephen De Lancey

of New York, and received with her a large landed estate in that colony, which he increased by purchase, chiefly in the valley of the Mohawk, then a wilderness. Sir Peter offered his nephew the management of his entire property in New York, if he would undertake its improvement and settlement. Johnson accepted the offer, and in 1738 established himself upon a tract of land on the Mohawk, about 24 miles from Schenectady, which Sir Peter had called Warrensburgh. In addition to the settling and improving of the country, he embarked in trade with the Indians, whom he always treated with perfect honesty and justice. He would never deal with them when they were under the influence of liquor, nor yield to them anything when he had once refused. This course, added to his easy but dignified and affable manner, and the intimacy which he cultivated with them, by accommodating himself to their manners, and sometimes even to their dress, soon won for him their entire confidence, so that he acquired an influence over them greater than was ever possessed by any other white man. He became a master of their language, speaking many of their dialects perfectly, and was thoroughly acquainted with their peculiar habits, beliefs, and customs. He was adopted by the Mohawks as one of their own tribe, chosen sachem, and named Wariaghejaghe, or Warraghaghly, "he who has charge of affairs." Complaints against the Indian commissioners and local quarrels led to their resignation, upon which Gov. Clinton appointed Johnson, already justice of the peace, colonel of the Six Nations. In 1746 he became commissary of New York for Indian affairs, and as such was very active in sending out war parties against the French. In February, 1748, he was placed in command of all the New York colonial troops for the defence of the frontier, and showed ability in organizing and preparing for a campaign. No important operations took place, as peace was soon after made at Aix-la-Chapelle. In April, 1750, he was appointed a member of the provincial council. The revival of the Albany board of commissioners in 1753 led to a quarrel between the colonists and the Indians, and the council and assembly urged Col. Johnson to effect a reconciliation. The governor having granted him a new commission, July 5, 1753, he proceeded to Onondaga, held a council, and succeeded in settling the difficulty, but declined having anything further to do with Indian affairs. He lived at Fort Johnson, a large stone dwelling which he had erected upon the N. side of the Mohawk, directly opposite Warrensburgh, and which he had fortified in 1748 shortly before the commencement of the war with the French. It is now (1874) standing in good preservation, about three miles west of the present village of Amsterdam. In 1754 he attended as one of the delegates from New York the celebrated congress of Albany, and also the great council held with the In-

dians on that occasion, at which they strongly urged his reappointment as their superintendent. At the council of Alexandria, April 14, 1755, he was sent for by Braddock and commissioned by him "sole superintendent of the affairs of the Six United Nations, their allies and dependants." He was also, pursuant to the determination of that council, created a major general, and commander-in-chief of the provincial forces destined for the expedition against Crown Point. At the head of these forces, in September, Johnson utterly defeated Baron Dieskau at Lake George. He was wounded in the hip early in the action, but remained on the field of battle. This victory saved the colony from the ravages of the French, prevented any attack on Oswego, and went far to counteract Braddock's disastrous defeat on the Monongahela. Gen. Johnson received the thanks of parliament for his victory, was voted £5,000, and on Nov. 27, 1755, was created a baronet of Great Britain. It was on his arrival at Lake St. Sacrement a few days before this battle that he gave to it the name of Lake George, "not only in honor of his majesty, but to assert his undoubted dominion here." In March, 1756, he received from George II. a commission as "colonel, agent, and sole superintendent of the affairs of the Six Nations, and other northern Indians," with a salary of £600, paid by the mother country. He held this office for the rest of his life. In 1756 and 1757 he was engaged with his Indians in the abortive attempts of the British commanders to relieve Oswego and Fort William Henry; and in 1758 he was present with Abercrombie at the repulse of Ticonderoga. In Gen. Prideaux's expedition against Fort Niagara in 1759, Sir William Johnson was second in command, and upon the death of Prideaux before that fort succeeded to the command in chief. He continued the siege with great vigor, routed the French army under Aubry sent to its relief, and then summoned the garrison, which surrendered at discretion. He led the Indian allies the following year in the Canadian expedition of Amherst, and was present at the capitulation of Montreal and the surrender of Canada to the British arms in 1760. The war was now at an end, and the king granted to Sir William for his services a tract of 100,000 acres of land, north of the Mohawk, long known as "Kingsland" or the "Royal Grant." His influence alone prevented the whole Six Nations from joining Pontiac in 1763, though he could not prevent some acts of hostility by the Senecas. In 1764 Sir William erected Johnson hall, a large wooden edifice still standing near the village of Johnstown, a few miles north of Fort Johnson. The village of Johnstown had already been laid out, and the building of stores, an inn, a court house, and an Episcopal church soon followed. Numerous settlers were brought in, the surrounding country was improved, and in three years Johnstown be-

came a thriving village, and in 1772 the shire town of Tryon co. Sir William gave great attention to agriculture, and was the first who introduced sheep and blood horses into the valley of the Mohawk. He lived in the style of an old English baron, and exercised the most unbounded hospitality. He continued active in his duties as head of the Indian department, made the treaty of Fort Stanwix in 1768, and his death resulted from over-exertion at an Indian council. About 1740 he married Catharine Wisenburgh, a German girl, who died young, leaving him a widower with three children, a son, John, knighted in 1765, and two daughters, who married respectively Col. Claus and Col. Guy Johnson. Sir William never married again. He had for some years many mistresses, both Indian and white, by whom it is said that he had 100 children; and one of his earlier ones, also a German, has been the probable cause, from having been confounded with his wife, of the erroneous statement that none of his children were legitimate. Mary, or as she is generally called "Molly" Brant, the sister of Thayendanega or Joseph Brant, the great Mohawk sachem, whom he took to his house, and with whom he lived happily till his death, is by some termed his wife, but they were never legally married. He had eight children by her, whom he provided for by his will, in which he calls them his natural children. The church in a vault of which he was buried was burned down in 1837; but in 1862 the vault was discovered, and his remains were removed and reinterred. His life has been written by W. L. Stone (2 vols., 1865). II. Sir John, son of the preceding, born in 1742, died in Montreal, Canada, Jan. 4, 1830. He succeeded to his father's title in 1774, and was at the same time appointed a major general in the British service. In the revolutionary war he remained loyal to the crown, and used his influence with the Indians to inflict frequent injuries upon the frontier settlements of New York, in retaliation for the sequestration of his large estates in the Mohawk valley. He was governor of Upper Canada for several years subsequent to 1796.

**JOHNSTON**, a central county of North Carolina, drained by Neuse and Little rivers; area, 660 sq. m.; pop. in 1870, 16,897, of whom 5,194 were colored. It has a diversified surface, and contains iron ore and granite. The North Carolina railroad traverses it. The chief productions in 1870 were 246,338 bushels of Indian corn, 132,277 of sweet potatoes, and 4,108 bales of cotton. There were 1,366 horses, 788 mules and asses, 3,253 milch cows, 1,689 working oxen, 4,239 other cattle, 5,653 sheep, and 20,530 swine; 4 flour mills, 5 saw mills, 1 manufactory of sash, doors, and blinds, and 6 of tar and turpentine. Capital, Smithfield.

**JOHNSTON**, Albert Sidney, an American soldier, born in Mason co., Ky., in 1803, killed at the battle of Shiloh, April 6, 1862. He graduated at West Point in 1826, and served on fron-

tier duty and in the Black Hawk war till 1834, when he resigned, went to Texas, enlisted as a private soldier, in 1836 became adjutant general, and soon after succeeded Gen. Felix Houston in the chief command of the army of Texas. This led to a duel, in which Johnston was wounded. He was the Texan secretary of war from 1838 to 1840. On the outbreak of the Mexican war he was made colonel of a volunteer regiment of Texan rifles; his regiment having been discharged, he became inspector general on the staff of Gen. W. O. Butler, and was present at the battle of Monterey. From 1846 to 1849 he was engaged as a farmer on the Brazos river. In October, 1849, he reentered the United States army with the rank of major, and served as paymaster till 1855. He was then made colonel of cavalry and placed in command of the department of Texas, which he held till August, 1857, when he took command of the expedition to Utah. In November, 1857, he was made brevet brigadier general for meritorious conduct while in command of the army in that territory. In January, 1861, he was placed in command of the department of the Pacific, but was superseded in April by Gen. Sumner. He resigned his commission May 3, entered the confederate service, and was placed in command of the division of the West. On the first day of the battle of Shiloh he received a ball in the leg which severed an artery, and he soon died from loss of blood, Gen. Beauregard succeeding to the command.

**JOHNSTON, Alexander**, a Scottish painter, born in Edinburgh in 1816. He early became known chiefly in Scotch genre painting and smaller pictures. His more elaborate work, "Lord and Lady Russell receiving the Sacrament in Prison" (1846), is in the Vernon gallery, and his subsequent productions include "Melancthon surprised by a French Traveller while rocking the Cradle of his Child" (1854) and "Tyndal translating the Bible" (1855). His "Introduction of Flora Macdonald to Prince Charlie" was exhibited at Paris in 1853. Many of his pictures have been engraved.

**JOHNSTON, Alexander Keith**, a Scottish geographer, born in Kirkhill, Mid-Lothian, Dec. 28, 1804, died at Ben Rhydding, July 9, 1871. He was educated in Edinburgh, and then apprenticed to an engraver, but soon manifested a decided taste for the study of geography. That he might be able to consult the highest geographical authorities in the original, he made himself master of a number of modern languages. He also travelled extensively for scientific purposes. His first important work was the "National Atlas" (1843), which secured his election to the royal geographical society, and his appointment to the office of geographer to the queen for Scotland. In 1848 his "Physical Atlas" was published, and immediately after its appearance he was chosen member of the *Genellschaft für Erdkunde* of Berlin, of the geographical society of Paris, and of the geological society of London. His

other principal works are: a "Dictionary of Geography" (1850-'52; last ed., 1867); a "Geological Map of Europe," in the preparation of which he was aided by Sir R. I. Murchison and Prof. Nichol; "Atlas of North America" (1858); "Military Atlas to Alison's Europe;" "Royal Atlas of Modern Geography," with a special index to each map (1860-'62, and later editions), the only atlas for which a prize medal was awarded at the London exhibition of 1862; and a series of six library maps of the great divisions of the globe (1863-'5).

**JOHNSTON, Arthur**, a Scottish physician, born at Caskieben, near Aberdeen, in 1587, died in Oxford in 1641. After studying at the university of Aberdeen, he went to Padua, where he completed his education in 1610. He then travelled for some time in southern and central Europe, and resided for 20 years in France. About 1632 he returned to Scotland, and was appointed physician to Charles I. In 1637 he became principal of the university of Aberdeen, but his duties as royal physician requiring his residence at court, the greater part of his subsequent life was passed in England. He was highly esteemed as a Latin poet, his principal works being *Purerga et Epigrammata* (Aberdeen, 1632); *Cantici Salomonis Paraphrasis Poetica* (London, 1633); and *Paraphrasis Poetica Psalmorum Davidis* (Aberdeen, 1637), by many considered equal to Buchanan's version.

**JOHNSTON, or Johnstone, Charles**, a British satirist, born in Ireland early in the 18th century, died in British India about 1800. He studied law, but on account of deafness practised only as a chamber counsel in London; and during his last 18 years he was a journalist in Bengal. He published many satirical works, and acquired most notoriety by his "Chrysal, or the Adventures of a Guinea" (London, 1760; 3d and enlarged ed., 4 vols. 1761; French translation by Frenais, Paris 1768), with contemporary sketches painting "the baser sides of literature and life."

**JOHNSTON, George**, a Scottish naturalist, born in 1798, died in Berwick-on-Tweed, July 1, 1855. After serving a medical apprenticeship with Dr. Abercrombie of Edinburgh, he entered the university of that city, where he graduated in 1819. Subsequently he settled as a medical practitioner at Berwick-on-Tweed. Amid many arduous professional duties he cultivated natural history with an enthusiasm and a success which rendered the place of his residence "one of the most classic localities in Great Britain." Apart from numerous papers contributed to the "Edinburgh Philosophical Journal" and other scientific periodicals, he published two works of first-rate importance: "History of British Zoophytes" (2d ed., 2 vols. 8vo, London, 1847), and "History of British Sponges and Lithophytes" (8vo, 1842). In 1830 appeared his "Introduction to Conchology," with an abundance of illustrations. His latest work was "The Natural History of the East-

ern Borders" (vol. i., "Botany," 8vo, 1854), and he was engaged at the time of his death upon a complete work on British annelids. He is considered one of the most accomplished contributors to the literature of natural history, and was one of the founders of the Ray society.

**JOHNSTON, James F. W.**, a Scottish chemist and agricultural writer, born in Paisley about 1796, died in Durham, England, Sept. 18, 1855. When a young man he supported himself by preparing students for the Glasgow university, and in 1825 he established a school at Durham. In 1830 he married, gave up his seminary, went to Sweden, and became a pupil of Berzelius. On his return he settled in Edinburgh, and was appointed chemist to the agricultural society of Scotland, filling at the same time the office of lecturer on chemistry and mineralogy in the university of Durham. After the dissolution of the society he removed to Durham, and devoted himself chiefly to the composition of works on agricultural chemistry. He subsequently visited the United States and France. His works are: "Elements of Agricultural Chemistry and Geology" (8vo, Edinburgh, 1842); "Suggestions for Experiments in Agriculture" (8vo, 1843); "Catechism of Agricultural Chemistry and Geology" (16mo, 1844), translated and used as a school text book in most countries of Europe and America; "Lectures on Agricultural Chemistry and Geology" (8vo, 1844); "Contributions to Scientific Agriculture" (1849); "Treatise on Experimental Agriculture" (1849); "Use of Lime in Agriculture" (1849); "Notes on North America, Agricultural, Economical, and Social" (2 vols. 8vo, 1851); "Instructions for Analysis of Soils, Limestone, &c." (3d ed., 1855); and "Chemistry of Common Life" (2 vols., 1854-5).

**JOHNSTON, Joseph Eccleston**, an American soldier, born in Prince Edward co., Va., in February, 1807. He graduated at West Point in 1829, and served mainly in garrison duty till 1834, and afterward in the Seminole war, in which he was aide to Gen. Scott. He resigned in May, 1837, and became a civil engineer, but in July, 1838, reentered the army, with the rank of first lieutenant of topographical engineers, and was brevetted as captain for gallantry during the war with the Florida Indians. He served in the topographical bureau, and in 1843 on the survey of the boundaries between the United States and the British provinces. From 1844 to 1846 he was engaged on the coast survey. During the Mexican war he served as captain of topographical engineers under Gen. Scott in all the important actions, was twice wounded, and successively brevetted as major, lieutenant colonel, and colonel. The regiment of voltigeurs, of which he had been made lieutenant colonel, was disbanded in 1848, but he was replaced in his former rank as captain in the army. From 1853 to 1855 he was in charge of western river improvements. He was subsequently employed in various duties in Kansas and elsewhere, and in 1858 was act-

ing inspector general in the Utah expedition. In June, 1860, he became quartermaster general, with the rank of brigadier general of staff. He resigned his commission April 22, 1861, entered the confederate service, and commanded at the battle of Bull Run, and subsequently at Yorktown and Richmond. During the battle of Fair Oaks (May 31, 1862) he was severely wounded, and was for some months disabled for service. In November he reported for duty, and was assigned to the command of the departments of Tennessee and Mississippi. During Grant's Vicksburg campaign he made an attempt with a feeble force to extricate Pemberton, but was repulsed, May 14, 1863, at Jackson, and retreated to Canton. After Bragg's defeat at Chattanooga in November, he took command of his army, occupying a position at Dalton, Ga., which was turned by Sherman early in May, 1864; whereupon Johnston fell back successively to Resaca, Allatoona pass, Kenesaw mountain, and Atlanta, in turns fighting and flanked. Failing to satisfy the expectations of the authorities at Richmond, he was on July 17 ordered to turn over the command to Gen. Hood. Near the close of February, 1865, Sherman having marched from Atlanta to Savannah, and thence into South Carolina, Johnston was directed to assume the command of the army of Tennessee and all troops in the department of South Carolina, Georgia, and Florida, and to "concentrate all available forces and drive back Sherman." The force which he could concentrate was wholly inadequate, and he was unable to check the march of the victorious army, though he fought a part of it at Bentonville, N. C. (March 18). Having learned that Lee had surrendered the army of Virginia to Grant, Johnston surrendered the forces under his command to Sherman, April 26, at Durham's Station, near Greensboro, N. C. In his farewell order to his troops he said: "I earnestly exhort you to observe faithfully the terms of pacification agreed upon, and to discharge the obligations of good and peaceful citizens as well as you have performed the duties of thorough soldiers in the field." Since the close of the war he has been actively engaged in the industrial reconstruction of the South, especially in connection with its agricultural, commercial, and railroad enterprises, residing at Savannah, Ga. He has published a "Narrative of Military Operations" directed by him during the war between the states (New York, 1874).

**JOHNSTONE**, a town of Renfrewshire, Scotland, on the Black Cart Water, 10 m. W. of Glasgow; pop. in 1871, 6,882. It has grown rapidly in population and importance within the last 50 years, in consequence of the establishment of cotton mills and iron and brass founderies. It is well built, and contains five churches and several schools and libraries.

**JOHNSTOWN. L.** A village in the town of the same name, seat of justice of Fulton co., New York, on Cayadutta creek, a branch of

the Mohawk river, 40 m. N. W. of Albany; pop. in 1870, 8,282; of the town, 12,273. It is connected with Fonda on the New York Central railroad, 6 m. distant, by the Fonda, Johnstown, and Gloversville line, and contains large skin and leather dressing establishments, a large number of glove and mitten factories, three hotels, a gas-light company, three weekly newspapers, and ten churches. The town also contains the village of Gloversville. (See GLOVERSVILLE.) II. A borough of Cambria co., Pennsylvania, at the junction of Stony creek and Conemaugh river, on the Pennsylvania canal and railroad, 78 m. E. of Pittsburgh; pop. in 1850, 1,269; in 1860, 4,185; in 1870, 6,028. It has an active trade, and contains extensive iron works, a national and a savings bank, two state banks, a daily and four weekly newspapers, and a monthly periodical.

**JOIGNY** (anc. *Joriniacum*), a town of Champagne, France, in the department and on the river Yonne, 15 m. N. W. of Auxerre; pop. in 1872, 6,400. It is surrounded by an old wall with six gates, and has two suburbs, exceedingly steep streets, a fine quay, several Gothic churches besides the fine cathedral, and good cavalry barracks. Coarse cloth and other articles are manufactured, and the trade in wine is brisk.—The territory of Joigny was a county in the middle ages, and about 1600 belonged to the cardinal de Gondy, a brother of Marshal de Retz, who built a handsome castle here.

**JOINT-STOCK COMPANY.** This name usually designates a partnership in which the capital is distributed by shares among a large number of partners. They assume in certain respects a corporate form, but possess legally none of the peculiar attributes or powers of corporations, except as conferred by statute. Like these, however, they adopt a corporate name; divide a fixed capital into shares, which they make transferable by assignment and delivery; and commit the conduct of their business to a board of directors. It is also sometimes stipulated in the fundamental articles of the association, that no member shall be liable for the company's debts beyond the amount of his shares. So far as the partners alone are concerned, they may adopt what rules they will for the internal administration of the partnership; but their imitation or assumption of corporate powers or responsibilities cannot avail them in law, except so far as recent legislation favors them, or prejudices the rights of third parties. They remain partnerships, and are generally subject to the rules of law which govern partnerships. Thus, such a company cannot sue its shareholders at law for breach of their engagements to it; for as copartners of the plaintiffs, they cannot be made liable, according to the rules of pleading, in such a suit; they must therefore resort to the intervention of trustees in order to avail themselves of contracts made or to be made with their members, or they must sue in equity. And they are bound by that familiar rule of

partnership law, which no mere mutual agreement can evade, that each member of the association is liable as a partner *in solido*, or to answer with his whole private property for the debts of the partnership. It is doubtful whether this rule would be changed, though the creditor dealing with the company have notice of a stipulation in the articles of association limiting the responsibility of members to the mere joint funds, or to a qualified extent. In recognition of the advantage secured to the community by the combination of capital in the prosecution of important enterprises, and in view of the embarrassments to which they are subjected by the operation of the rules of law, joint-stock companies received both in England and in the United States some assistance from legislation, which gives them a qualified corporate character, a separate legal existence apart from that of their individual members. There is no uniformity in these statutes as will admit of a comprehensive statement of their purport. In general it may be said that the statutory joint-stock companies occupy an intermediate position between corporations and partnerships, and partake of the nature of both.

**JOINT TENANTS**, persons to whom a real estate is granted jointly by the same deed or will, and without any exclusive restriction or explanatory words. The grant can take effect in such a case only by considering that all the grantees have equal interests, and that each has the entire possession of the whole estate. 1. Between the grantees there is a unity of title, the estate being derived from one and the same conveyance; 2. of time, for it was created and vested in them at the same period; 3. in respect to interest, for it is a single estate which was conveyed; 4. in respect to possession, for the estate is to be enjoyed in common during the same time. It was the distinguishing incident of joint tenancies that, upon the death of his co-grantees, the estate passed to the last survivor. This is the so-called *jus accrescendi*, or right of survivorship. It originated in the feudal law, the policy of which was averse to the division of tenures and to the distribution of the feudal services among tenants who might be strangers to the lord. The rules of law in relation to joint tenancies were strictly upheld for a long time in the courts of common law, but were regarded with less favor in proportion as the law of tenancies was modified. Joint tenancies, with their incidents, have been but little recognized in the United States; and the incident of survivorship is very generally abolished, except in the case of conveyances to husband and wife or to trustees as such, or by way of mortgage.

**JOINVILLE**, François Ferdinand Philippe de Marie d'Orléans, prince de, the third son of Louis Philippe, king of the French, born at the place of Neuilly, near Paris, Oct. 14, 1816. Like his elder brothers, he completed his classical studies in the college of Henry IV., and th

in the naval school at Brest. His birth led him rapid promotion. In 1838, when Al Baudin was sent against Mexico, he had the rank of post captain, and distinguished himself during the bombardment of the island of San Juan de Ulua. A few days later, at the head of a detachment of sailors, he landed on Vera Cruz, broke in the gate of the city, through the streets amid brisk discharges of artillery, and with his own hand took Gen. Alvarado prisoner. He was rewarded by the cross of the legion of honor, and promotion to the rank of full captain. In 1840 he was sent to the coast of Senegal, with two frigates, the Belle Poule and the Favorite, to receive the remains of Napoleon I., which were transported to France. In 1841 he made a visit to the United States and a cruise along the coast of Africa, he repaired to Rio de Janeiro, which he had already visited, and on May 1, 1843, married the princess Françoise of Bragança, the sister of Dom Pedro II. In the same year he was appointed rear admiral and became a member of the admiralty.

He participated in the deliberations of the committee for the organization of a steam navy, insisting upon the necessity of taking precautions toward this end. In 1844 he was placed in command of the French fleet along the coast of Morocco, and while Admiral Bugeaud was invading that empire by sea he bombarded Tangier, Aug. 6, and Mogador, Aug. 15, taking possession of the island of the Moor, and obliged the Moors to come in. The prince, who entertained liberal notions, had more than once warned his father of the dangers attending his retrograde policy; but his voice had been powerless. On coming out of the revolution of 1848 he fled to Algeria; he resigned his command to other officers, sailed for England, and his exiled family at Claremont. When the constituent assembly discussed the decree of proscription against the Orleans family, he made a protest couched in most dignified terms.

He lived for some years in retirement, altogether aloof from all political intrigues, and gave his leisure hours to the education of his children and the colonization of his vast possessions in Brazil. The domain in France he inherited from his aunt Adelaide was bequeathed by Louis Napoleon in 1852. Shortly after the breaking out of the civil war in France he came to the aid of the duke de Chartres, joined the staff of General McClellan, and took an active part in the Chickahominy campaign, returning to England in 1862. At the news of the first defeats of the French in the war of 1870 he offered his services to Napoleon, who declined to accept them.

Considering the decree of his exile void by the downfall of the empire, he went with his brother the duke d'Aumale and the duke de Chartres to Paris. The government of national defence ordered their immediate departure, but the prince succeeded in participating in the campaign of the army of

the Loire under cover of his American pseudonym of "Colonel Lutherod." Gambetta, who was then minister of war, ordered his arrest, and he was escorted by the police on board of a vessel to take him back to England, Jan. 18, 1871. Two departments, La Manche and Haute-Marne, elected him in the following month to a seat in the national assembly. He decided to represent the latter, but the assembly reserved its decision on the validity of his election. After the repeal of the laws of expatriation against the former sovereign families of France, and the declaration of the validity of the election of the princes, Joinville resigned his seat at the instance of Thiers. But, contrary to their promise, he and the duke d'Aumale appeared in the national assembly, Dec. 19. In letters addressed to the electors they explained their reasons for this step, and by an almost unanimous vote the assembly declared that the promises given were an entirely private affair in which it was not concerned. He has contributed anonymously to the *Revue des Deux Mondes* many articles, several of which have been reprinted in pamphlet form. Among these are: *Note sur l'état des forces navales de la France* (1844); *Étude sur l'escadre de la Méditerranée* (1852); *La guerre de Chine* (1857); *La guerre d'Amérique, campagne du Potomac* (1863); and a comparative view of the fleets of the United States and of France (1865). To him also has been attributed an article on the battle of Sadowa (1868).

**JOINVILLE, Jean**, sire de, a French chronicler, born in the château of Joinville, Champagne, about 1224, died about 1319. He was of an illustrious family, and early became seneschal to Thibaut IV., king of Navarre. In 1248 he joined the crusade of Louis IX. with 700 men-at-arms, and a strong friendship sprang up between them. He fought bravely, was taken prisoner and liberated with the king, spent four years with him in Palestine, returning to France in 1254, and afterward remained his intimate friend and counsellor. But when, in 1270, Louis summoned his barons to another crusade, Joinville declined to go, in consequence of an ominous dream, though he excused himself on the ground of duty to his people. He bore witness to the king's virtues during the inquest preparatory to canonization, and he gladly assented when Queen Jeanne of Navarre requested him to write the deeds and good sayings of her husband's grandfather. To this request we owe his *Mémoires*, which are invaluable as a chronicle, and unrivalled in point of simplicity and grace. They were completed about 1309, and first printed by Marnef brothers (4to, Poitiers, 1547). The best editions are those of Du Cange (1668), Capperonnier (1761), and F. Michel (Didot, Paris, 1858). Capperonnier's was reprinted in 1840, with annotations, in the *Recueil des historiens de France*, vol. xx. An edition from a newly discovered manuscript, rendered into modern French by Natalie de

Wailly, was published at Paris in 1873, under the title of *Histoire de St. Louis*.

**JÓKAI, Mór**, a Hungarian author, born at Comorn in 1825. He became known in 1842 by a drama, and in 1846 by a novel. He has since published more than 150 volumes. During the movements of 1848 he made himself conspicuous by his revolutionary ardor, but in 1849 belonged to the moderate party. He was at the time editor of the weekly literary journal *Életképek*, and from 1858 to 1863 of the humorous *Estókai* ("The Comet"). Since 1863 he has been editor of the *Hon* ("Fatherland"), a daily political journal. He has been several times elected to the diet from Pesth. His more recent works include *Politikai divatok* ("Political Fashions," 4 vols., Pesth, 1863); *Mire megrónulánk* ("Till One grows Old," 4 vols., 1865); *Szeretem bolondjai* ("Love's Fools," 4 vols., 1867); *A kőszívű ember fiai* ("The Sons of the Man with the Stony Heart," 4 vols., 1869); and *Fekete gyémántok* ("Black Diamonds," 5 vols., 1870). In 1848 he married Rosa Laborfalvi, a distinguished actress.

**JOKJOKERTA, Jokjokarta, or Yugyakarta. I.** A maritime province or residency in the S. part of Java, formerly one of the most important native states on the island, but now subject to the Dutch; pop. about 500,000. It contains the volcano of Nerapi, 3,000 ft. high, abounds in teak, is very fertile, and produces rice, coffee, and tobacco, but has no good harbors. **II.** The capital of the residency and seat of a native sultan and a Dutch resident, near the S. coast, about 275 m. E. S. E. of Batavia; pop. about 120,000. The most interesting features of the town are said to be the native monarch's water palace, with its walls, towers, and subterranean approaches, and the fort occupied by Europeans. The sultan is attended by a body guard of young females, armed with lance, sword, and pistol, and serving both as infantry and cavalry. From them are often chosen inmates for the royal harem. There is now a Christian church and school.

**JOLIBA.** See NIGER.

**JOLIET**, a city and the county seat of Will co., Illinois, situated on both sides of the Des Plaines river, 35 m. S. W. of Chicago; pop. in 1850, 2,659; in 1860, 7,102; in 1870, 7,263. The Illinois and Michigan canal passes through the city, and it is the point of junction of the Chicago, Rock Island, and Pacific, the Chicago and Alton, and the Michigan Central railroads. It is surrounded by a rich agricultural country, and is the principal shipping point for the produce of this region which is exported by canal. The canal and river furnish water power, and there are several flour mills, manufactories of agricultural implements, &c. There are inexhaustible quarries of fine blue and white building stone near the city. Joliet is well built and lighted with gas. The city hall is a large and imposing edifice. The state penitentiary, one of the finest buildings of the kind in the country, cost more than \$1,000,000. There

are two national banks, a semi-weekly and weekly newspapers, and 10 public schools, including a high school.

**JOLIET, Charles**, a French author, born Saint-Hippolyte, department of Doubs, A. 8, 1832. He was employed in the civil ser till 1864, and became known as a journal and as a miscellaneous writer. His works elude *Le roman de deux jeunes maris* (P. 1866), *Mademoiselle Chérubin* (1870), and triotic novels based upon the Franco-Ger war of 1870-71, which have given hi reputation almost equal to that of Erckm Chatrian.

**JOLIETTE.** L. A. W. county of Qu Canada, bounded S. E. by the St. Lawr river; area, 2,669 sq. m.; pop. in 1871, 23 of whom 22,020 were of French descent is drained by the river L'Assomption several smaller streams. **II.** A town, ca of the county, on L'Assomption river, 4 N. N. E. of Montreal; pop. in 1871, 3,047. is connected by a railway 12 m. long w harbor on the St. Lawrence. Joliette is business centre of the surrounding coun has a weekly market, and carries on an ex sive trade in agricultural produce and lux It contains large grist, saw, carding, and fe mills, an extensive foundry, a tannery, q ries of limestone, a college, a French we newspaper, a hospital, and a convent.

**JOLLIET, or Jollet, Louis**, one of the early plorers of the Mississippi, born in Quebe 1645, died in 1700. His father was the m of the settlement, but placed his son at Jesuit college, where he made rapid prog and evinced a decided taste for hydrogra He received the tonsure and minor order 1662, and graduated in 1666. He soon abandoned his design of becoming a priest, went west, where he spent some years in acquiring a knowledge of Indian langua and of western topography. This led to selection by Talon in 1672 to push through the Mississippi. He and Père Marquette st over the route, drawing up maps from t own knowledge and Indian reports, by down rivers, tribes, and natural features. T started from Michilimackinac May 17, 1673, proceeded to Green bay. Then they ascen the Fox river to an Indian town, where t obtained guides to the Wisconsin, and on J 17, 1673, entered the Mississippi. They fo some Illinois 60 leagues lower down, near mouth of the Des Moines, but passed the J soursi, the Piesa or Painted Rocks, and the Ol without encountering other Indians. T soon met a tribe not named, then the Ma gameca, and finally the Arkansas. Here t found that the Indians had intercourse w Europeans; and having gone far enough to certain that the river flowed into the gulf Mexico and not into the Pacific, they tur back up the river, July 17, ascended the Illi and reached Lake Michigan. Jolliet at a set out to report his success, but his canoe

set in the Lachine rapids near Montreal, and he lost his men and his valuable maps and papers, barely escaping with his life. His report from memory was necessarily brief, and his map less accurate than that which Père Marquette had drawn and retained. Although he continued to study the topography, and by maps from time to time embodied all new data of discovery, he was not allowed to continue his researches in the west, but made an expedition in the king's service to Hudson bay. His modest merits were thrown in the shade by the pretensions of La Salle, who had won Frontenac's favor. As if to keep Jolliet as far as possible from the Mississippi, he was rewarded in 1680 by a grant of the seignury of Anticosti island. He devoted himself to the development of its fisheries and trade, and from this time signed himself Jolliet d'Anticosti. He was also appointed royal hydrographer at Quebec, and his numerous maps still extant show that his title was not a nominal one. Few men contributed more to the geography of the continent at that time. In 1697 he obtained the seignury of Joliette, which still belongs to his family. Among his descendants in 1874 are Archbishop Taschereau of Quebec and Archbishop Taché of Red River.

**JOLLIVET, Pierre Jules**, a French painter, born in Paris, June 27, 1803. He left the school of fine arts in 1825, lived for some time in Madrid, and returning to Paris exhibited in 1831 genre pictures relating to Spanish history and life. His works include "Louis VIII. taking the Oriflamme at Saint Denis," and other pieces, at Versailles; "Lara," after Byron's poem, at the Luxembourg; "The Massacre of the Innocents," at the museum of Rouen; and "The Installation of the Magistrates in 1849," in possession of the government. Among his recent productions are "Art in the Time of Pericles" and "The Jewels of Cornelia" (1869).

**JOMARD, Edme François**, a French geographer, born in Versailles, Nov. 20, 1777, died Sept. 22, 1862. He was a member of the Egyptian scientific commission in 1798, distinguishing himself by his successful researches, and was afterward appointed secretary of the commission to prepare the *Description de l'Égypte*, and in 1807 superintendent of the engraving and printing of that work, to which he devoted 18 years. He participated in 1821 in the establishment of the geographical society. In 1828, on the organization of the new department of geography and travels in the royal library, he received the appointment of *conservateur administrateur*. Being held in great esteem by Mehemet Ali, he persuaded the pasha to send a number of young Egyptians to study in Paris. These young men formed what was called the *institut des Égyptiens*, placed under the direction of Jomard. As a reward for his services, the successor of Mehemet Ali appointed him his scientific correspondent, and granted him the honorary title of bey. His numerous publications are all devoted to

geography, archæology, or public education. Besides his contributions to the great work of the Egyptian commission, which he printed separately, under the title of *Recueil d'observations et de mémoires sur l'Égypte ancienne et moderne* (4 vols. 8vo, Paris, 1830), his most important publications are: *Voyage à l'oasis de Syouah* (1819), from the notes of the travellers Caillaud and Drovetti; *Remarques sur les rapports de l'Éthiopie et de l'Égypte, &c.* (1822); *Aperçus et coups d'œil sur les nouvelles découvertes dans l'Afrique centrale* (1824-'7); *Observations sur le voyage au Darfour* (1845); *Classification méthodique des produits de l'industrie extra-européenne* (1862); and *Les monuments de la géographie* (1862), a collection of ancient charts of Europe and the Orient, reproduced in facsimile.

**JOMELLI, Nicolò**, an Italian composer, born in Aversa, near Naples, in 1714, died in Naples, Aug. 28, 1774. He was a pupil of Leonardo Leo. His *Errore amoroso* and *Odoardo*, produced in Naples before he was 24 years of age, established his reputation, and he was invited to Rome, where he composed two new operas. Thence he went to Bologna, where he studied under Padre Martini. After a successful career in the chief cities of Italy, he returned in 1749 to Rome, where his *Artaserse* was coldly received. In the following year he produced his *Achille in Sciro* with complete success in Vienna, where he made a congenial friend in the poet Metastasio, whose *Didone* he set to music, and on whose works he thenceforth almost exclusively employed himself. Returning to Rome in 1751, he was made chapelmaster of St. Peter's, but resigned in 1753 to accept an invitation from the duke of Würtemberg to settle as musical director in Stuttgart. He returned to Naples in 1768; but his style no longer pleased, and his *Demofonte* and *Ifigenia in Aulide* failed. The *Miserere* was the last and greatest of his works.

**JOMINI, Henri**, baron, a French military historian, born at Payerne, canton of Vaud, Switzerland, March 6, 1779, died at Passy, near Paris, March 24, 1869. He joined the French army in 1804 with the rank of major, and was soon made a colonel, serving as aide-de-camp and chief of staff to Marshal Ney in Germany and Spain. In 1805 he presented to Napoleon on the field of Austerlitz the first edition of his *Traité des grandes opérations militaires, ou Histoire critique et militaire des guerres de Frédéric II. comparées à celles de la révolution* (5 vols. 8vo, with an atlas, Paris, 1804-'5). In consequence of a misunderstanding with Ney in 1808, he resigned, and offered his services to the emperor Alexander; but Napoleon compelled him to return and accept the commission of brigadier general. In 1812 he was appointed governor of Wilna and then of Smolensk, and was of great service to the French army during the latter part of the disastrous retreat from Moscow. After the victory of Bautzen Ney asked for him the rank of general of divi-



sion; but Berthier, who was unfriendly to him, put him under arrest on account of some trifling irregularities in his routine duties. This treatment he deeply resented; and after the armistice of Pläswitz he left the French army and repaired to the headquarters of Alexander, who appointed him his aide-de-camp. Sentence of death was passed against him as a deserter. The rumor that he betrayed the military plans of the French was wholly unfounded, according to Napoleon's own declaration. Jomini even declined taking an active part in the operations of the allied armies against France. In 1815 he accompanied the czar to Paris, and received the cross of the order of St. Louis from Louis XVIII. He tried, but in vain, to save the life of Ney. After sojourning in France to superintend the publication of his great work, *Histoire critique et militaire des campagnes de la révolution de 1792 à 1801*, written in conjunction with Col. Koch (15 vols. 8vo, Paris, 1819-'24), he returned to Russia in 1822, and was intrusted with the completion of the military education of the grand duke Nicholas, who on his accession to the throne retained him as his aide-de-camp. He served in 1828 during the Russian war against Turkey, and organized in 1830 the Russian military academy. He then retired to Brussels, but hastened to St. Petersburg on the breaking out of the Crimean war. He spent the last years of his life in Brussels and Passy. Besides the above mentioned works, which are the basis of his reputation as a military writer, his chief publications are: *Principes de la stratégie* (3 vols. 8vo, Paris, 1818); *Vie politique et militaire de Napoléon, racontée par lui-même au tribunal de César, d'Alexandre et de Frédéric* (4 vols., 1827); *Tableau analytique des principales combinaisons de la guerre et de leurs rapports avec la politique des états* (4th ed., St. Petersburg, 1836); *Précis de l'art de la guerre, ou nouveau Tableau analytique des principales combinaisons de la stratégie, de la grande tactique et de la politique militaire* (1830; new ed., Paris, 1855); *Précis politique et militaire de la campagne de 1815* (1839); *Appendice au Précis de l'histoire de la guerre* (1849). The following translations of his works have appeared in the United States: "Art of War," by Capt. G. H. Mendell and Lieut. W. P. Craighill (Philadelphia, 1862); "Political and Military Life of Napoleon," by Maj. Gen. H. W. Halleck (4 vols. 8vo, New York, 1864); "Political and Military History of the Campaign of Waterloo," by Capt. S. V. Benet (New York, 1864); "Treatise on Grand Military Operations, and Art of War," by Col. S. B. Holabird (2 vols. 8vo, with atlas, New York, 1865).

**JONAH**, the fifth of the minor Hebrew prophets, son of Amittai, born in Gath-hepher, in the tribe of Zebulun, prophesied in the kingdom of Israel under Jeroboam II. The book called after him relates that he received the divine command to go to Nineveh and denounce the

wickedness of that city. Fearing to undertake the mission, he embarked at Joppa for Tars-hish, that he might flee from the presence of the Lord. Overtaken by a tempest, the mariners threw him overboard as the cause of their disaster. He was swallowed by a great fish, within which he lived three days and three nights, when the monster threw him forth upon dry land. Again sent to Nineveh, he prophesied the destruction of that city within 40 days. The Ninevites repented, and God forbore to execute the sentence which he had pronounced. Jonah complained of this result, retired from the city, and while dwelling in a booth was symbolically reproved by God. The literal interpretation of the book of Jonah was maintained by the early ecclesiastical authors. Various allegorical and mythical interpretations have been advanced by some modern critics, as Semler, Michaelis, Herder, Eichhorn, Meier, and De Wette. A modern oriental tradition places the tomb of Jonah at Nebi Yunus, opposite Mosul. (See NINEVEH.)—See Jäger, *Ueber den Zweck des Buchs Jonas* (1840), and Kraemer, *Das Buch Jonah historisch-kritisch untersucht* (1846), besides the collective works on the minor prophets by Hitzig, Keil, and Lange.

**JONAS**, Justus, a German theologian, born in Nordhausen in 1493, died in Eisfeld in 1553. He studied law and afterward theology at Erfurt, and was appointed in 1521 professor at Wittenberg, where he embraced with zeal the doctrines of the reformation, becoming intimate with Luther and accompanying him to the diet at Worms. He was present at the conference in Marburg and at the imperial diet of Augsburg. In 1541 he was appointed preacher at Halle, from which place when banished he accompanied Luther on his last journey to Eisleben. At the time of his death he was pastor and superintendent at Eisfeld. He assisted Luther in translating the Bible. The work by which he is best known is the *Discursio pro Conjugio Sacerdotali* (1523).

**JONATHAN**, brother of Judas Maccabeus. See HEBREWS, vol. viii., p. 592.

**JONES**, the name of five counties in the United States. I. A S. E. county of North Carolina, drained by Trent river; area, 300 sq. m.; pop. in 1870, 5,002, of whom 2,636 were colored. It has a level and marshy surface, with pine and cypress forests, and a sandy soil. The chief productions in 1870 were 96,385 bushels of Indian corn, 14,100 of sweet potatoes, and 1,196 bales of cotton. There were 251 horses, 256 mules and mares, 683 milch cows, 1,594 other cattle, 1,610 sheep, and 4,717 swine. Capital, Trenton. II. A central county of Georgia, bounded W. by Ocmulgee river; area, 360 sq. m.; pop. in 1870, 9,436, of whom 6,445 were colored. The surface is hilly, and the soil generally good, though much worn. Iron, granite, and quartz are found. The central Georgia railroad passes along its southern boundary, and the *North*

and Augusta line crosses the S. E. portion. The chief productions in 1870 were 6,191 bushels of wheat, 108,945 of Indian corn, 6,815 of oats, 14,354 of sweet potatoes, and 5,188 bales of cotton. There were 479 horses, 891 mules and asses, 1,082 milch cows, 2,648 other cattle, 1,250 sheep, and 6,675 swine. Capital, Clinton. **III.** A S. E. county of Mississippi, drained by Leaf river and its tributaries; area, 672 sq. m.; pop. in 1870, 3,313, of whom 308 were colored. It has a rolling or slightly hilly surface, with a sandy soil of various qualities. The chief productions in 1870 were 43,187 bushels of Indian corn, 5,662 of oats, 20,503 of sweet potatoes, 29,070 lbs. of rice, and 315 bales of cotton. There were 608 horses, 1,804 milch cows, 2,738 other cattle, 3,773 sheep, and 7,764 swine. Capital, Ellisville. **IV.** A N. W. county of Texas, drained by the head streams of Brazos river; area, 1,004 sq. m.; returned as having no population in 1870. It is nearly all prairie; mesquite grass and the timber of the same name abound. The soil is of a reddish color and generally fertile. The county is well adapted to stock raising. **V.** An E. county of Iowa, drained by Wapsipinicon and Makoqueta rivers; area, 576 sq. m.; pop. in 1870, 19,731. It has a diversified surface, with alternations of prairie and forest, and a fertile soil resting chiefly on a bed of limestone. The Dubuque Southwestern, the Davenport and St. Paul, and the Sabula, Ackley, and Dakota railroads traverse it. The chief productions in 1870 were 476,039 bushels of wheat, 1,606,646 of Indian corn, 682,260 of oats, 111,216 of potatoes, 37,104 lbs. of wool, 733,645 of butter, 35,121 of cheese, and 37,936 tons of hay. There were 7,791 horses, 9,736 milch cows, 9,811 other cattle, 7,725 sheep, and 18,724 swine; 10 manufactories of carriages, 1 of cheese, 6 of saddlery and harness, 5 of tin, copper, and sheet-iron ware, and 4 flour mills. Capital, Anamosa.

**JONES, Anson**, president of the republic of Texas, born in Great Barrington, Mass., Jan. 20, 1798, died by his own hand in Houston, Texas, Jan. 7, 1858. He commenced the study of medicine in Litchfield, Conn., in 1817, and in 1820 was licensed to practise. After a residence in South America, Philadelphia, and New Orleans, he established himself in 1833 in Brazoria, Texas. Upon the outbreak of the troubles between Texas and Mexico he served as a private soldier and as surgeon in the Texan army. In 1837-'8 he was a representative in the Texan congress. In 1838 he was sent as minister to Washington, where he remained about a year, and where he unsuccessfully endeavored to secure the annexation of Texas to the United States. On his return to Texas he took his seat in congress as senator from Brazoria, and in 1841 he was appointed by President Houston secretary of state, which office he filled three years. In September, 1844, he was elected president for three years from the

ensuing December, and held that office until the annexation of Texas to the United States. The latter years of his life were passed in agricultural pursuits. In 1859 his journal, preceded by a brief autobiography, was printed for private circulation.

**JONES, Inigo**, an English architect, born in London about 1572, died July 21, 1652. He was of humble origin, and in early life is said to have been apprenticed to a joiner; but manifesting a strong inclination for drawing, he attracted the notice of the earl of Pembroke, who afforded him the means of procuring an art education abroad. During several years he made careful studies of the chief architectural monuments of France, Germany, and Italy. In Venice he became acquainted with the masterpieces of Palladio, whose style he subsequently transplanted into England. At the invitation of Christian IV. of Denmark he visited Copenhagen in 1604, and furnished, it is said, the designs for the royal residences of Rosenborg and Frederiksborg. In 1605 he returned to England, where he was employed by James I. to prepare the scenery, decorations, and machinery for the masques written by Ben Jonson, which were among the chief amusements of the court. He became a person of considerable consequence at court, and by his overbearing manners incurred the enmity of his dramatic associate Jonson, who satirized him under the name of Lantern Leather-head in his "Bartholomew Fair." In 1612, upon the death of Prince Henry, to whom he had been appointed architect, he revisited Italy, and succeeded in materially improving his style. Upon his return he was appointed surveyor general of the royal buildings, and during the next 25 years was occupied with many important public works. His designs for the palace at Whitehall, of which only the banquetting house was built, are considered his masterpieces; besides which he designed the river front of Somerset house, a Corinthian portico added to old St. Paul's, the arcade and church of St. Paul, Covent Garden, York stairs, surgeons' hall, Shaftesbury house, Ashburton house, and many private residences in various parts of England. At the request of James I. he made a careful examination of the druidical remains at Stonehenge, and pronounced them part of a temple of the Roman or Tuscan order dedicated to Coelus. The errors of his restoration, as disclosed in his "Essay on Stonehenge," published after his death by his son-in-law John Webb (fol., 1655), have since become apparent. During the civil war he adhered to the royal cause, and suffered so much from fines and other persecutions that he died broken-hearted and in poverty. He was an accomplished classical scholar and mathematician, and occasionally wrote verses. His publications consist of a masque and several miscellaneous essays, and he also left some notes on Palladio's architecture. His designs were published by

William Kent in 1727 and 1770, and by Isaac Ware in 1743. See "Life of Inigo Jones," by Peter Cunningham (London, 1848).

**JONES, Jacob**, an American naval officer, born near Smyrna, Kent co., Del., in 1770, died in Philadelphia in August, 1850. After studying medicine, he received in April, 1799, a midshipman's warrant, and served for some time in the frigate United States under Commodore John Barry. He was promoted to the rank of lieutenant in February, 1801, and at the opening of the war with Tripoli was attached to the frigate Philadelphia, in which he was captured off Tripoli in 1803, and remained a prisoner 20 months. He was afterward employed for some years on the S. coast of the United States, a part of the time in command of the brig Argus. In April, 1810, he was commissioned as master commandant, and in 1811 was appointed to the command of the Wasp, a sloop of war of 18 guns. He was on his passage home from France in 1812 when war was declared by the United States against England. On his arrival the Wasp was ordered to sea again immediately, and met a convoy of English merchantmen protected by a sloop of war. An engagement ensued, lasting 43 minutes, when the Wasp boarded and carried her antagonist. The captured vessel, which proved to be the British sloop Frolic, Capt. Whinyates, was a mere wreck when she surrendered. Before they were able to clear the wreck, the British ship Poitiers, of 74 guns, captured both vessels and carried them to Bermuda. The Americans were soon put on parole, and returned to the United States. Congress voted a gold medal to Jones, and silver ones to each commissioned officer of the Wasp. In March, 1813, he was promoted to the rank of post captain, and appointed to command the frigate Macedonian in the squadron of Decatur.

**JONES, John**, a Welsh clergyman, born in Carmarthenshire, died in London, Jan. 10, 1827. He completed his education at the Unitarian college of Hackney, and in 1792 was appointed classical and mathematical tutor in the Welsh academy at Swansea. He continued in this situation for three years, and then removed to Plymouth Dock, where he became minister of a Unitarian church. This charge he exchanged in 1797 for that of the Unitarian congregation at Halifax, in Yorkshire. About 1800 he removed to London, and resided there during the remainder of his life, chiefly as a classical teacher. He published a Greek grammar (1804), "Illustrations of the Four Gospels" (London, 1808), a "Greek and English Lexicon" (1823), and *Etymologia Græca* (1826), an enlarged edition of his grammar.

**JONES, John Paul**, an American naval officer, born at Arbigland, on Solway firth, Scotland, July 6, 1747, died in Paris, July 18, 1792. His name was John Paul, that of Jones having been assumed in after life. At the age of 12 he was apprenticed to a merchant of Whitehaven, who was engaged in American trade.

His first voyage was to Virginia, where his elder brother was established as a planter. He was afterward engaged for a short time in the slave trade, which he left in disgust, and made a number of voyages to the West Indies, realizing, it was said, a fortune by commercial speculations. At the commencement of the American revolutionary struggle he was in Virginia, and entered the colonial service as a lieutenant in the navy, Dec. 22, 1775. It is said that Jones hoisted on the Alfred (of which he was first lieutenant), the flag ship of a squadron of eight vessels, the first American flag ever displayed. The device it bore is believed to have been a pine tree with a rattlesnake coiled at its root. From the Alfred he was soon transferred to the command of the sloop Providence, of 12 guns and 70 men, in which vessel he made 16 prizes during a cruise of six weeks between the Bermudas and the gut of Canso. He was appointed a captain in 1776, receiving command of the Alfred, and in 1777 of the Ranger. He made many prizes on his cruises and broke up the fishery at Cape Breton. In November, 1777, he sailed to Europe, harassed the coasting trade of Scotland, and made a bold attack on Whitehaven. He also attempted to capture the earl of Selkirk, who resided upon his estate near Kirkcudbright, on the river Dee, in order to bring about a system of exchanges of prisoners, to which England had hitherto showed a reluctance. This design failed, owing to the absence of the earl from home. The crew plundered the home of the silver plate; but Jones bought it of them and restored it to Lady Selkirk. During this cruise the Ranger captured the Drake, a sloop of war superior to her in force. On May 8, 1778, the Ranger arrived at Brest, with her prize and 200 prisoners, being nearly double the number of her own crew. From this time until February, 1779, he used every effort to obtain another and better command. The Ranger was despatched by the commissioners to America, Jones being retained by them in France. After many months of disappointment, he set out for Paris, and made such strong personal appeals to the minister, M. de Sartine, that on Feb. 4 he was appointed to the command of the ship Duras, an old Indianman converted into a ship of war, and then lying at Lorient. In compliment to Dr. Franklin, Jones changed the name of this ship to "Bon Homme Richard." After many delays she was equipped for service, though in a very inefficient manner. On her main or gun deck she mounted 28 12-pounders, and on her quarter deck and fore-castle 14 9-pounders, making an armament of 42 guns in all. But Jones determined to make the most of her, caused 13 ports to be cut in her gun room below, where 6 old 18-pounders were mounted. This expedient did not add to the efficiency of the ship, but, on the contrary, as will be seen, produced disastrous consequences. On Aug. 14, 1779, Jones sailed from Lorient, having under

mand a squadron of five vessels. By middle of September 26 vessels had been captured or destroyed by them, which created alarm upon the E. coast of England. On the 23<sup>d</sup> the *Bon Homme Richard* was off the rough Head, having in company the *Countess*, Capt. Landais, and the *Pallas*, a ship carrying 32 light guns, commanded by Capt. Chau. Soon after noon the headmost vessel of a fleet, known to be from the Baltic, was seen standing out from under Flamborough Head, and beating down toward the point of Dover. This fleet was under command of the *Serapis*, 44, and *Countess* of Scarborough, 22. Signal for general chase was given by Jones, and the *Alliance*, being the lead of the squadron, took the lead; but no vessel had discovered the force of the British vessels of war than she stood off from the *Serapis*.

About 7½ o'clock the *Richard* came to the *Serapis*, commanded by Capt. Boscawen, and closed with her, upon her weatherboard, to about half pistol shot. At the commencement of the action two of the old muzzles mounted in the *Richard*'s gun ports burst, blowing up the deck above and wounding a large portion of the crew stationed at them. This part of the battle was then abandoned, and the ports were

A close and heavy cannonade was maintained by both ships for about an hour when they fouled each other, and Jones with his own hands assisted in lashing the jib of the *Serapis* to the mizzen mast of the *Richard*. The ships being in actual contact, and adrift, each discharged her guns into the water through the ports of her antagonist. The effect of such a fire was terrible to both. At 10 o'clock the *Serapis* struck, and her first lieutenant of the *Richard* (afterward Commodore Dale), was ordered on board in possession of her. In the morning the spectacle presented by the *Richard* was singular and dreadful. She was on fire in two places and had 7 ft. of water in her hold. Her foremast and quarters on the lower deck were destroyed, the whole of her main battery was disabled, and she was cut to pieces in an extraordinary manner. The after part of the ship, in line with the guns of the *Serapis* so completely beaten in that the upper part was only sustained by a few frames, could not have been missed by shot. It being impossible to carry her into port, the masts were removed, and she soon after the *Serapis* suffered much less. She was a new ship, in excellent condition, and superior in force to the *Richard*, mounting 44 guns, though rated at 44. Her crew numbered 320, while those engaged upon the *Richard* were only 227, Irish, Scotch, Portuguese, Norwegians, &c., with but very few British. During the action the *Countess* of Scarborough surrendered to the *Pallas*, the crew of which requested Capt. Landais of the *Richard* to take charge of the prize, to enable

him to go to the assistance of the *Richard*; but Landais, instead of complying, actually opened fire upon Jones's ship. Jones carried his prize into the Texel. On his arrival in France he was received with the most distinguished honors. A sword was presented to him by Louis XVI., who also requested permission of congress to decorate him with the military order of merit. In 1781 he sailed for the United States, arriving in Philadelphia in February, where congress voted him a gold medal, and Washington addressed him a highly complimentary letter. He was afterward employed to superintend the construction of a line-of-battle ship, the *America*, at Portsmouth, N. H., which he was to have commanded; but the ship was presented by congress to France. He then went to Paris as an agent for prize money, and while there was invited into the Russian service with the rank of rear admiral, but was disappointed at not receiving command of the fleet in the Black sea. He quarrelled with the admiral, the prince of Nassau, and owing to the intrigues of enemies fell into disfavor at court, and was finally permitted by the empress Catharine to retire from the service, with a pension which was never paid. He took up his residence in Paris, where he died in poverty and neglect.

**JONES, Owen**, an English architect, born in Wales in 1809, died in London, April 19, 1874. He was the only son of Owen Jones, a Welsh tradesman, whose "*Myvyrian Archaeology of Wales*," published under the name of Owain Myvyr (3 vols., London, 1801-'7), has been described by Matthew Arnold as a great repository of Welsh literature. The son, after studying with a London architect, spent four years on the continent and in the East. While in Granada he made with Jules Goury drawings of the Alhambra, which revealed for the first time the striking characteristics of that unique monument; and after Goury's death he carried on the publication of the work almost alone, investing in it his whole patrimony, and sparing no effort in its elaborate execution. It was published under the title of "*Plans, Elevations, Sections, and Details of the Alhambra*," with a notice of the kings of Granada and the translation of Arabic inscriptions by Gayangos (London, 1836-'42; 2d ed., 1847, with 101 plates). In 1851 he became one of the superintendents of the crystal palace in London, and next year director of its decoration in conjunction with the present Sir Matthew Digby Wyatt; and the courts of architecture and sculpture in the Sydenham crystal palace, and the decorative painting of that building, were all completed under his direction, with the assistance of Bonomi, Sharpe, and others in the Egyptian court. His polychromatic decoration of the Greek court having excited comment, he vindicated his imitation of the ancient Greek sculptors, and illustrated his views by painting a portion of the casts of the Elgin marbles at Sydenham in party-colors, the

hair being gilt. In his handbooks to the Alhambra and other courts of the crystal palace, he gives a full exposition of the principles of ornamentation. His principal architectural work is St. James's Hall in Piccadilly. He also delivered lectures, and published one of the most important of them for the promotion of his views, which he lived to see generally adopted, though the variety and novelty of his conceptions occasioned controversy. The last of the many public recognitions he received was an honorary diploma for designs at the Vienna exhibition of 1873. He also prepared with Goury "Views on the Nile" (London, 1842), and furnished many others for illustrated works. His other productions include "Designs for Mosaic and Tessellated Pavements," with an essay by F. O. Ward (1842); "The Polychromatic Ornament of Italy" (1846); an elaborate "Grammar of Ornament" (folio, 1856); "One Thousand and One Initial Letters," and "Seven Hundred and Two Monograms" (1864); "Examples of Chinese Ornament" (1867); and several volumes of Biblical illustrations. A scholarship was founded after his death in 1874, by the "Owen Memorial" committee, in commemoration of his genius, and his portrait in mosaic was presented by it to the nation.

**JONES, Thomas Bymer**, an English anatomist, born about 1810. He became a member of the royal college of surgeons in 1833, but on account of a defect in his hearing has never practised. Subsequently he was appointed professor of comparative anatomy in King's college, London. His first work, "A General Outline of the Animal Kingdom" (8vo, 1841), written to supply a want in English scientific literature, established his reputation as a comparative anatomist and physiologist, and is still regarded as one of the best works of its kind in any language. About this time he was appointed Fullerian professor of physiology in the royal institution, and subsequently he became examiner in comparative anatomy and physiology in the London university. In 1845 and 1852 were published the first two volumes of his Fullerian lectures, under the title of "Lectures on the Natural History of Animals," the work being still incomplete. His other works are: "General Outline of the Organization of the Animal Kingdom, and Manual of Comparative Anatomy" (1855); "The Aquarian Naturalist" (London 1858); and "The Animal Creation" (1865). He also contributed to the "Cyclopaedia of Anatomy and Physiology."

**JONES, William**, an English divine, born at Lowick, Northamptonshire, in 1726, died at Nayland in 1800. He was educated at the Charterhouse, and at University college, Oxford, and became successively vicar of Bethesda (1764), rector of Pluckley, perpetual curate of Nayland (1776), and rector of Pasten and of Hollingbourn, the last three of which appointments he held at his death. He was eminent as a scholar and theologian, and proficient in music. His principal works are: "The Catho-

lic Doctrine of the Trinity Proved" (1754); "Lectures on the Figurative Language of the Holy Scriptures" (1786, several times reprinted); "The Scholar Armed against the Errors of the Time," a compilation (2 vols. 1792); and a "Life of Bishop Horne" (1795). He also wrote treatises on music, composed anthems, and was the originator of the "British Critic." A collected edition of his works with a biography by William Stevens, was published in 1801 (12 vols.; new ed., 6 vols. 1810). Two posthumous volumes of his sermons, edited by Henry Walker, appeared in 1830.

**JONES, Sir William**, an English orientalist, born in London, Sept. 28, 1746, died in Calcutta, April 27, 1794. His father, an eminent mathematician, died when he was but three years old, and the care of his education devolved on his mother. When seven years old he was sent to the grammar school at Harrow, where he remained ten years, not only surpassing his associates in classical studies, but making some progress in Hebrew and Arabic, and applying himself to French and Italian during his vacations. In 1764 he was entered at University college, Oxford; and in 1765 he was invited to reside in the family of Earl Spencer, as tutor to Lord Althorp, then seven years of age, which office he held for five years, during which he was elected a fellow at Oxford. Meantime his fame for oriental scholarship had begun to extend, and in 1768 Christian VII. of Denmark requested him to translate into French a Persian life of Nadir Shah. This was published at London in 1770, in connection with a dissertation, also in French, on oriental poetry, containing translations of several of the odes of Hafiz. In the following year appeared his Persian grammar, which, as enlarged by subsequent editors, long remained the standard text book on the subject. In 1770 he became a student at the Temple, and began to contemplate "the stately edifice of the law of England," but was immediately called upon to defend his university against the aspersions of the French orientalist Anquetil-Duperron. His pamphlet (1771) was anonymous, in idiomatic and effective French, and was universally admitted to surpass the attack both in wit and learning. In the following year he published a small volume of poems, chiefly translations from the Asiatic languages, which was followed by the more important *Poeseos Asiaticae Commentariorum Libri Sex* (1774; republished by Eichhorn, Leipsic, 1777), in which with equal skill and erudition he aimed to familiarize the European mind with oriental modes of thought and expression. Called to the bar in 1774, he left at Oxford all his oriental books and manuscripts, and applied himself exclusively to legal studies. He was ambitious of a seat in parliament, and in 1780 stood for the university of Oxford; but his liberal politics and his condemnation of the American war and of the slave trade, deprived him of all chance of success, and he withdrew from the

contest. His political opinions were declared in several essays, as his "Inquiry into the Legal Mode of Suppressing Riots," "Plan of a National Defence," and "Principles of Government;" and he produced in 1781 a more elaborate work on the "Law of Bailments," which alone, according to Judge Story, would have given him "a name unrivalled in the common law for philosophical accuracy, elegant learning, and finished analysis." He resumed his oriental studies to produce a translation of the "Moallakat, or Seven Arabian Poems which were suspended in the Temple at Mecca" (1783). In 1783 he was married, knighted, and, through the influence of Lord Ashburton, appointed a judge of the supreme court of judicature at Fort William in Bengal. One of his first acts after his arrival was the founding of the Asiatic society of Bengal, or "society for inquiring into the history and antiquities, the arts, sciences, and literature of Asia." He was the first president of this body, and contributed to the first four volumes of its "Asiatic Researches" numerous treatises of great importance. He undertook to make a digest of Hindoo and Mohammedan laws, similar to the codification of Greek and Roman law effected by Justinian. This task he did not live to complete, and it was finished under the superintendence of Mr. Colebrooke. He translated and published in 1794 the ordinances of Manu, the foundation of Hindoo jurisprudence. He also translated the *Sakontala*, or "The Fatal Ring," an Indian drama by Kalidasa; the *Hitopadesa*, the original of the famous fables of Bidpay; the tales and fables of Nizami; and portions of the Ramayana and the Vedas. He had decided to return to England, when he died suddenly. He was familiar with 27 languages. No predecessor had equalled his attainments in Sanskrit, Arabic, and Persian. A collected edition of his works was published in 6 vols. in 1799; a life by Lord Teignmouth was added in 1804; and the whole was reprinted in 1807, in 13 vols.

**JONESBORO**, a village, capital of Clayton co., Georgia, on the Macon and Western railroad, 20 m. S. of Atlanta; pop. in 1870, 531. An important battle was fought here, Aug. 31, 1864. Sherman, then besieging Atlanta, dispatched a force under Howard to seize the railroad near Jonesboro, an operation which if successful would compel the evacuation of Atlanta. Hood, the confederate commander, sent a force under Hardee to oppose this attempt. Howard occupied an entrenched position in which he was attacked by Hardee. After a severe action of two hours, the confederates withdrew. Their loss, as officially given by Hood, was 1,400 killed and wounded; the Union force, being attacked in their intrenchments, suffered much less. As the immediate consequence of this action, Atlanta was evacuated by the confederates in the night of Sept. 1.

**JÖNKÖPING**. I. A S. province or län of Sweden, bordering on Östergothland, Kalmar,

Kronoberg, Halland, and Elfsborg; area, 4,298 sq. m.; pop. in 1872, 181,788. It is traversed by several mountains, and is watered by the rivers Nissa and Em and by Lake Wetter. It is well cultivated and wooded, and abounds in minerals, particularly iron, which is largely exported, together with corn, cattle, butter, cheese, pitch, and tar. Hemp, flax, and potatoes are also extensively raised. II. A town, capital of the län, situated on a tongue of land at the S. end of Lake Wetter, 175 m. S. W. of Stockholm; pop. in 1872, 11,751. The low situation requires embankments against inundations. It is well built, and has a fine parish church, ruins of an old castle, a governor's residence, a superior court, and a theatre. The harbor in the adjoining Munk lake has increased in importance through the opening of the Göta canal. The trade is chiefly in corn, iron, and wood; famous lucifer matches are made here, and much used in France and England. In the vicinity are mineral springs, summer resorts, and villas. It is one of the principal stations on the southern railroad, and is connected by steamers with Stockholm.

**JONSON**, Benjamin, commonly called Bex, an English dramatist, born in Westminster in 1573 or 1574, died Aug. 6, 1637. He was the posthumous son of a clergyman, and during his childhood his mother was married a second time, according to tradition, to a master bricklayer named Fowler. Ben was educated at Westminster school under the tuition of Camden, and subsequently followed the calling of his stepfather, whom he assisted in building part of Lincoln's Inn. Finding this occupation not to his taste, he enlisted in the army, and served a campaign in Flanders. Returning to England, he is said to have entered himself at St. John's college, Cambridge. About the age of 20 he went upon the stage, but met with little success as an actor, and also engaged in dramatic composition. In 1596 appeared his "Comedy of Humors," which was recast and brought out at the Globe theatre in 1598 under the title of "Every Man in his Humor." Shakespeare, who is said to have aided in the composition of the play, was one of the performers. About the same time he was imprisoned for killing Gabriel Spenser, an actor, in a duel, and during his confinement was converted to the Roman Catholic faith, although he subsequently became again a Protestant. "Every Man in his Humor" was succeeded in 1599 by "Every Man out of his Humor," a less able performance, in which the "enphusism" so fashionable at that time is ridiculed; "Cynthia's Revels" (1600); the "Poetaster" (1602), which involved the author in a quarrel with Decker, who retaliated upon him in "Satyromastix;" and "Sejanus," a tragedy (1603), in which Shakespeare is said to have taken his farewell of the stage as an actor. Shortly after the accession of James I., Jonson, in conjunction with Chapman and Marston, wrote the comedy of "Eastward Hoe," containing

some reflections on the Scottish nation, in consequence of which the three dramatists were imprisoned and threatened with the loss of their ears and noses. After a short confinement they were pardoned, and Jonson made his peace with James, who employed him in writing masques and other court entertainments. Between 1605 and 1611 appeared his comedies of "Volpone," "Epicorne, or the Silent Woman," and "The Alchemist," and the tragedy of "Catiline." In 1613 he visited the continent as travelling tutor to a son of Sir Walter Raleigh. Among his favorite haunts at this time was the Mermaid club, where he was thrown into the society of Shakespeare and the great Elizabethan dramatists, and of Raleigh, Camden, Selden, Donne, and others. The Apollo club, which met at the Devil tavern in Fleet street, was founded by Ben Jonson himself at a later date. In 1619 he received the appointment of poet laureate with a pension of 100 marks, and about the same time made a pedestrian excursion to Scotland, in the course of which he visited Drummond of Hawthornden, who has preserved some curious notes of his conversation. In 1628 he was attacked by palsy, and compelled also by poverty to write for the stage. His "New Inn" was unsuccessful, but Charles I., hearing of his necessities, sent him a present of £100, and raised his salary to that sum, adding a tierce of canary annually. Notwithstanding this assistance, his improvident habits kept him always in difficulties. He wrote two or three more dramas, which Dryden calls his "dotages," and left "The Sad Shepherd," a fragment of great beauty. Jonson's pride of learning, which obtrudes itself into some of his best works, has interfered not a little with their popularity as literary performances. In the opinion of some of his critics his genius was more poetic than dramatic. His delineations of character are striking, original, and artistic, rather than natural. His comedies are esteemed his best performances. His tragedies, founded on classic history, and burdened with long extracts from Sallust, Tacitus, and other Latin authors, are correct in form, but lack vivacity. He published in 1616 a folio edition of most of his works produced previous to that date, carefully revised and corrected. Various collective editions subsequently appeared, the first good one being that of Gifford (9 vols. 8vo, 1816), accompanied with notes critical and explanatory, and a biographical memoir, written with ability, but in a partisan spirit. Moxon's reprint, the latest, prefaced by Gifford's memoir (royal 8vo, 1853), contains 17 plays, 15 of which were performed on the stage; over 30 masques and interludes; epigrams, translations from Horace, an English grammar, and a variety of miscellanies in prose and verse. He was buried in Westminster abbey, and the pithy inscription upon his tomb, "O rare Ben Jonson," was added at the expense of an eccentric Oxfordshire squire, called Jack Young, who, observing

the tomb to be destitute of an epitaph, gave a mason 18 pence to carve the words upon it. The stone has since been removed.

**JONSSON, Finn**, an Icelandic historian, born in Hitardal, Jan. 16, 1704, died July 23, 1789. In 1725 he entered the university of Copenhagen, and in 1728 was present at the fire which destroyed the great collection of Icelandic MSS. formed by his patron Arni Magnússon. In his endeavors to save these MSS. he neglected his own effects and library, which were burned. On returning to Iceland he obtained a benefice, and in 1754 was appointed bishop of Skalholt. He wrote many works in Latin and Icelandic, the principal of which is the *Historia Ecclesiastica Islandiæ*, published under the care of his son Hannes Finsson at Copenhagen (4 vols. 4to, 1772-'9). The latter, who succeeded his father in the bishopric, made important additions to this work, edited several sagas, and was the founder of the Icelandic agricultural society.

**JOODPOOR**, or **Marwar**. I. The largest of the native Rajpoot states of India, between lat. 24° 36' and 27° 40' N., and lon. 70° 4' and 73° 23' E.; area, about 36,000 sq. m.; pop. estimated at 1,800,000, chiefly Hindoos. The Loonee river divides it into two parts; the S. E. or left bank is fertile, and the N. W. or right bank is a continuation of the desert of Sinde. It is traversed in the east by the Aravulli range of mountains, from 3,000 to 4,000 ft. high, the torrents of which irrigate the south, and favor the cultivation of grain. The chief products are wheat and cotton, but frosts often destroy the latter in a single night. Millet and a pulse called *moth* are the principal food. Camels, horses, cattle, and sheep abound, as well as many wild animals, and snakes to such an extent that thick gaiters are worn as a protection. Salt is plentiful. Iron is worked to some extent, and there are large deposits of hard red sandstone adapted for building; and fine quarries of marble at Mukrana, 120 m. N. E. of Joodpoor. Various woollen articles are manufactured, and trade is active, the natives chiefly Jains, excelling as merchants and bankers. The revenue is about £175,000, and the maharajah or ruler of Joodpoor pays to Great Britain a considerable annual tribute. II. A town, capital of the state, 300 m. S. W. of Delhi; pop., including suburbs, estimated as high as 150,000, but supposed to be rather less than 80,000. It is enclosed by a rampart 3 m. in circuit, which is in a dilapidated condition. The town is well built; several streets and the tanks are bordered by trees, and some of the houses are built of red freestone. The greater part of the area of the citadel is occupied by the royal palace and premises, and there are many temples. The Mahumandir suburb outside the walls, enclosed by a fortified wall with a distinct settlement of 1,000 houses, derives its name from a great sanctuary which has a lofty spire and rich interior decorations, one of the most conspicuous of which

is a canopy of silver in the shape of an umbrella. The most important manufactures are those of ivory and hardware. It was founded in 1459 as the capital of Marwar, in place of Mandor, the ruins of which are 5 m. N.

**JOONPOOR**, or **Jannpoor**, a town of India, capital of a district of the Northwestern Provinces, on the Goomtee, 86 m. N. W. of Benares; pop. about 16,000. The river, which is navigable here, divides the town into two unequal parts, and its bridge is one of the finest and strongest in India. The fort on the bank of the river, with a highly ornamental gateway, is half a mile in circuit, and is used as a prison. The castle and mosques were renowned in former times for their splendor, and the town and its vicinity abound in ruins of magnificent buildings. The principal mosque, though dilapidated, is an imposing edifice with colonnades and lofty domes. The population was formerly much more considerable in the town as well as in the district, in which latter it has declined from over 1,100,000 to about 800,000. Joonpoor is renowned for its sugar.

**JOPPA**. See **JAFFA**.

**JORDAENS, Jacob**, a Flemish painter, born in Antwerp in 1594, died there in 1678. He studied in the school of Adam van Oort, whose daughter he married. Rubens, whom he imitated, intrusted him with the execution on a large scale of many of his small sketches. He excelled in the representation of bacchanalian subjects and scenes of festive riot. Of these, the pictures of the "Satyr and the Man blowing hot and cold," and "Pan and Syrinx," are well known specimens. He was an industrious painter, designing and executing with great facility, and in the course of his long life finished an immense number of works.

**JORDAN** (Heb. *ha-Yarden*, the descender, now called by the Arabians of Palestine *esh-Sheriah*, or *Sheriat el-Kebir*, the great watering place), the only large river in Palestine, and one of the few perennial streams in that country. Its sources are on the southern declivities of the Libanus and Anti-Libanus. The highest rises in the S. part of Mt. Hermon, near the village of Hasbeiya, 1,700 ft. above the level of the sea, formed by about 20 springs which bubble up within a small circuit and form a pool 15 ft. deep. The united waters, under the name of the Hasbany, flow W. and then S., receiving small tributaries on either side till the river enters the marshy plain of Huleh, where it is joined by the united streams of the Leddan, Dan, or Daphne, and the Banias, the two larger and principal sources of the Jordan. The former of these streams, one of the largest single sources in the world, originates in a large pool, 12 m. below the source of the Hasbany, at the southern prolongation of Hermon, about 650 ft. above the sea; and 4 m. E. of it rises the other, near Banias, about 1,150 ft. above the sea level. Struggling through the morass, which is thickly overgrown with papyrus, the Jordan

enters Lake Merom, now called Huleh, also El Mallaba and Bahr Banias or Bahr Khait, 150 ft. above the sea. On leaving the lake the river is sluggish and turbid, but is soon purified, and becomes a torrent rushing between small islands and rocks thickly set with oleanders.



Source of the Jordan.

About 2 m. below the lake is the so-called Jacob's bridge, where Jacob on his return from Mesopotamia is said to have crossed; it was built after the crusades, probably in connection with the caravan route from Egypt to Damascus. The breadth of the river at this place has been variously stated from 64 to 80 ft. About 13 m. below it enters the lake of Tiberias or Gennesaret, which is between 600 and 700 ft. below the Mediterranean, and about as much above the Dead sea. Issuing from the S. extremity of this lake, the river enters a broad valley, or *ghor*, by which name the natives designate a depressed tract or plain between the mountains; the Bible calls it "the plain;" its width varies from 5 to 10 m. The river at first winds very much, and flows first near the W. hills, then turns E., and continues to the district called Kurn el-Hemar, then again returning toward the W. side. Lower down it rather follows the middle of the great valley. Its course is so tortuous that within a space of only 60 m. long and 4 or 5 m. broad it traverses at least 200 m. and plunges over 27 formidable rapids. It enters the Dead sea at its N. extremity, 1,316 ft. below the Medi-



terranean, after a total direct course of 120 m. Its mouth is 180 yards wide. Its principal affluents are the Zurka (Jabbok) and Sheriat el-Mandhur, or Yarmuk. Its breadth and depth greatly vary, which circumstance explains the great discrepancies in the reports of travellers. Its entire descent from Hasbeiya to its mouth is about 3,000 ft., from Banius about 2,450 ft. The Jordan flows through a deep chasm or fissure in the earth's crust, caused by the rending and falling in of the aqueous strata, upheaved by the eruption of the basalt which forms its bed, and belonging to the prehistoric age of the present configuration of the earth's surface. At the surface of the sea of Galilee it is 653 ft. below the Mediterranean; at the surface of the Dead sea it is 1,316 ft., and at the greatest depth of that sea 2,624 ft., below the ocean level. The sources and the course of the Jordan were partially explored in 1847 by the English Lieut. Molyneux, and very thoroughly in 1848 by an American expedition under Lieut. Lynch, and again in 1868-'9 by Mr. Macgregor (see "The Rob Roy on the Jordan," London, 1869). As Christ was baptized by John in the Jordan, Christians have often regarded it as a special privilege to receive baptism in its waters, and water is even now occasionally procured from the Jordan for the baptism of princes. (See DEAD SEA, and GENNESABET.)

**JORDAN, Camille**, a French statesman, born in Lyons, Jan. 11, 1771, died in Paris, May 19, 1821. He was educated by the Oratorians, opposed the revolutionary government, distinguished himself in the insurrection at Lyons, and left France on the fall of that city, Oct. 9, 1793. Returning after the 9th Thermidor, he was elected in 1797 to the council of 500, advocated the principles of religious liberty, opposed the directorial government, and was again compelled to seek refuge abroad after the 18th Fructidor. Recalled in 1800, he energetically opposed the designs of Bonaparte, and denounced the frauds in the election of 1802, in a pamphlet entitled *Vrai sens du vote national sur le consulat à vie*. From that period till the return of the Bourbons he devoted himself exclusively to literature. In 1816 he was elected to the chamber of deputies. He was one of the fathers of the *doctrinaire* school of politics. A collection of his speeches was published in 1818.—See *Camille Jordan et Madame de Staël*, by Sainte-Beuve (1868).

**JORDAN, Charles Etienne**, a French author, born in Berlin, Aug. 27, 1700, died there, May 14, 1745. He belonged to a French Protestant family and became a clergyman. After the death of his wife in 1732 he travelled for some years; and in 1736 he became a literary assistant of the crown prince of Prussia, who on his accession as Frederick II. (1740) made him privy councillor and curator of the national academies. He was the king's inseparable companion. Carlyle in his "History of Frederick the Great" makes many references to Jordan's intimate relations with the king, and

to his gossiping letters to him, which are included in vol. x. of his posthumous correspondence; but Carlyle ridicules Jordan's *Histoire d'un voyage littéraire en 1733 en France, Angleterre et Hollande*, because it "awakens a kind of tragic feeling, being itself dead, and treating of matters which are all gone dead."

**JORDAN, Dorothy or Dora**, an Irish actress, born near Waterford about 1762, supposed to have died at St. Cloud, July 3, 1816. She was the daughter of a Capt. Bland, an Irish gentleman, who, having married her mother under age, procured the invalidation of the union. At 16 she made her début in Dublin, under the name of Miss Francis, as Phebe in "As You Like It." She soon, under the name of Mrs. Jordan, by which she was afterward known, was engaged at the York theatre, where she remained for three years. She then went to London, and made her first appearance there Oct. 18, 1783, soon becoming immensely popular in comedy and musical farce. By her talents and remarkable beauty she attracted the attention of the duke of Clarence, afterward William IV. She was at that time under the protection of Mr. Richard Ford, and had several children, but yielded to the admiration of the royal duke. Her children by him were ten in number, and are known under the name of Fitz-Clarence. At the termination of this connection she went to France, and died there in obscurity and poverty. A monument by Chantrey was erected to her memory at St. Cloud by William IV. after his accession to the throne. Her professional career was brilliant. She was of an amiable character and a kind heart, and her domestic duties were performed with devotion to the interests of her family. Her "Memoirs," by J. Boaden, were published in 1831. There is some mystery as to her retirement, which is not cleared up by her biographer, and it was generally supposed that she did not actually die at the time and place stated, but that she lived in England for seven years after under a different name.

**JORDAN, Rudolph**, a German painter, born in Berlin in 1810. He studied in that city and in Düsseldorf, resided for a long time in Heligoland, and became known as a marine and genre painter. His "Interior of a Pilot's House" (1831) has been purchased for the royal gallery at Babelsberg, and his "Proposal of Marriage in Heligoland" (1834) has been often lithographed. His other masterpieces comprise "An Examination of Pilots," "Shipwreck on the Coast of Normandy," in the gallery of the earl of Ellesmere, and pictures of life in the Dutch islands.

**JORDAN, Wilhelm**, a German poet, born in Insterburg, Prussia, Feb. 8, 1819. He graduated at the university of Königsberg in 1842, and published his first volume of poetry in the same year. He was a member of the Berlin national assembly in 1848, and was subsequently employed for a short time in naval affairs. His works include *Geschichte der Insel Helig*

(2 vols., Leipsic, 1846-'9), tragedies and comedies, and translations of Sophocles and of Shakespeare's poems and several of his plays. His most famous poetical production is *Demiurgos, ein Mysterium* (3 vols., 1852-'4), and he has written an epic, in a peculiar old German metre, entitled *Sigfridsage*, portions of which he has recited in various cities of Germany, as well as of the United States, which country he visited in 1872.

**JÖRG, Joseph Edmund**, a German author, born at Immenstadt, Bavaria, Dec. 23, 1819. He studied theology at Munich, and was for several years amanuensis of Döllinger. In 1847 he became connected with the bureau of archives, and in 1852 succeeded Guido Görres as editor of the *Historisch-politische Blätter*. In 1865 he became a member of the second Bavarian chamber, to which he has been repeatedly reelected, and in 1867 of the customs parliament. He is a prominent partisan of ultramontane views, and his works include *Geschichte des grossen Bauernkriegs* (Freiburg, 1850), *Geschichte des Protestantismus in seiner neuesten Entwicklung* (2 vols., 1857), and *Geschichte der social-politischen Parteien in Deutschland* (1867).

**JÖRG. I. Johann Christian Gottfried**, a German physician, born at Predel, near Zeitz, Dec. 24, 1779, died in Leipsic, Sept. 20, 1856. He was professor of obstetrics in the university of Leipsic from 1810 till his death. His works relate chiefly to female physiology and pathology, and include a series of manuals which passed through several editions. **II. Eduard**, son of the preceding, born in Leipsic, Jan. 19, 1808. After taking his degree of M. D. he travelled extensively, went to the United States in 1837, and spent several years in Cuba observing tropical diseases, on which he published several works. Subsequently he returned to the United States and practised in Illinois and in Pennsylvania.

**JORGENSEN, Jorgen**, a Danish adventurer, born in Copenhagen in 1779, died in New South Wales about 1830. He belonged to the celebrated family of watchmakers named Jørgensen, was apprenticed at 14 years of age to the master of an English collier, and subsequently, it is said, served in the British navy as a midshipman, and Anglicized his name into Jorgenson. In 1807 he sailed from Copenhagen in command of a privateer, and was captured and taken to England, where he was put upon his parole. He succeeded in inducing a London merchant named Phelps to freight a vessel for the purpose of opening a trade with Iceland. Jørgenson arrived at Reykiavik in January, 1809, but was forbidden to land his cargo. He then seized a Danish brig, which had arrived with needed provisions, and the alarmed authorities permitted him to land his goods, but forbade trade with him. Restoring the captured brig, and leaving his supercargo with his goods, he returned to England, but came back with Phelps in June. Five days

before his arrival the governor, Count Trampe, had agreed with the captain of the British sloop of war Rover to allow trade with British subjects during the war; but this agreement not being carried out, Phelps imprisoned the governor on his ship, making a prize of his brig the Orion; and the next day Jørgenson assumed the government of Iceland, declaring its independence of Denmark, and seized the public money chest, containing 2,700 rix dollars. On July 11 he proclaimed himself protector of Iceland, appointed a new flag, and repealed all restrictions upon trade. His authority was acknowledged by an ecclesiastical synod, and by the people generally. He equipped an army of eight men, confiscated all Danish property on the island, established a battery to defend Reykiavik, and seized a Danish vessel which came into the harbor. But in August the British sloop of war Talbot arrived at the island, and, upon the representations of the Danish merchants and Count Trampe, her captain sent both Jørgenson and Trampe to England. The former opened a correspondence with the admiralty, but it having transpired that he was a prisoner of war who had broken his parole, he was confined for a time in Tothill Fields prison. In 1811 he published a work entitled "State of Christianity in Otabeite, and a Defence of the Gospel against Modern Antichrists." Upon the conclusion of the Napoleonic wars he travelled on the continent, and in 1817 published "Travels in France and Germany in 1815-'17." He subsequently fell into bad habits, was convicted of theft, and sentenced to transportation for life, and in 1825 was sent to New South Wales. Previous to his departure from England he published "The Religion of Christ is the Religion of Nature; written in the condemned cells of Newgate, by Jorgen Jorgenson, late Governor of Iceland" (8vo, London, 1827).

**JORNANDES**, or according to the oldest MSS. **JORDANES**, a Gothic historian, who lived about the middle of the 6th century. He was at first one of the notaries or rather secretaries of the king of the Alans, who inhabited Mœsia, but became a convert to Christianity, and embraced the monastic state. It has been said, but without proof, that he was bishop of Crotona. He wrote *De Getarum sive Gothorum Origine et Rebus Gestis*, which is chiefly an extract from Cassiodorus's lost "History of the Goths." Notwithstanding its many shortcomings and incorrect style, it is an important work. He left also, under the title *De Regnorum et Temporum Successione*, a synopsis of universal history, which has been generally printed at the end of his Gothic history. The first edition of the latter is that published by Peutinger with Warnefrid's "History of the Lombards" (Augsburg, 1515). It has been frequently reprinted in various historical collections; a correct edition is to be found in Muratori's *Scriptores Rerum Italicarum*; the latest edition, with critical notes, is that of Closs (Stuttgart, 1861).

**JORTIN, John**, an English divine and author, born in London in 1698, died in Kensington, Sept. 5, 1770. He graduated at Cambridge in 1719, and was presented by his college with a living in Cambridgeshire; but after his marriage he removed to London, where he soon became widely known as a popular and powerful preacher. He was successively rector of Eastwell in Kent and St. Dunstan's-in-the-East, domestic chaplain to the bishop of London, prebend of St. Paul's, and in 1764 archdeacon of London. He published *Lusus Poeticus* (1722), a small volume of Latin poems, which were greatly admired, and numerous critical and theological works, which display a vast amount of unusual learning. The most important are: "Remarks upon Authors, Ancient and Modern" (2 vols., 1731-'32); "Remarks on Ecclesiastical History" (5 vols., 1751-'73); and "Life of Erasmus" (2 vols., 1758-'60). He also wrote criticisms on Spenser, Milton, Tillotson, and Seneca.—See "Memoirs of John Jortin, D. D.," by John Disney, D. D. (London, 1792).

**JORULLO**, a volcano of Mexico, in the state of Michoacan, 160 m. W. by S. of the city of Mexico. It rises from the plain of Malpais, which forms a part of a platform having a mean elevation of 2,500 ft. above the sea, and is on a line with a chain of volcanoes including Tuxtla, Orizaba, and Popocatepetl to the east, and Colima to the west. From the discovery of America down to the middle of the 19th century no volcanic disturbance had occurred in this region; and the present site of Jorullo, about 100 m. from the nearest sea, was the centre of a series of sugar and indigo fields, drained by two small streams,



Jorullo.

the Cuitimba and the San Pedro. In June, 1759, strange hollow sounds were audible, and earthquakes succeeded each other until the end of September, when flames issued from the ground, and rocks were thrown to a prodigious height. On the line of a chas-

running from N. N. E. to S. S. W. were formed six volcanic cones composed of scoria and fragmentary lava, the smallest of which attained 300 ft. in height, while Jorullo, the central volcano, rose to an elevation of 1,600 ft. above the level of the plain, and launched forth streams of basaltic lava with included fragments of granitic rocks, which ejection did not cease until February, 1760. The natives on returning to the spot many years after the outburst, found the ground still uninhabitable from the excessive heat. Around the base of the newly formed cones, and radiating from them as from a centre, over an area of 4 s. m., is a convex mass of matter some 350 ft. high at its junction with the cones, and gradually sloping thence in all directions toward the plain; and on this convex protuberance, sloping at an angle of about 6°, are thousands of low conical mounds, called *hornitos*, ranging from 6 to 9 ft. in height, from which, as well as from extensive fissures across the plain, issued clouds of sulphurous acid and aqueous vapor. In 1827 they had entirely ceased to emit steam, and the mountain has not since shown any signs of activity; vegetation had made marked progress on the flanks of the new hills; and cultivation had been resumed on the fertile plain surrounding the volcanic centre. The great distance of Jorullo from the ocean is observed by Lyell as an important circumstance, showing that proximity to the sea, though a common characteristic, is not an essential condition of the site of active volcanoes. The two streams above mentioned disappeared at the time of the eruption below the eastern extremity of the plain, and afterward reappeared as hot springs at its western limit.

**JOSEPH**, son of Jacob and Rachel, having a younger brother Benjamin and ten elder half brothers. He was envied by his brethren on account of his father's partiality toward him; and their aversion was increased by two dreams that he told, in which was foreshadowed his preëminence in the family. Conspiring against him, they sold him for a slave to a caravan of Arabian merchants, and he was taken to Egypt. There he rose to the highest power in the house of Potiphar, an officer of Pharaoh. The wife of Potiphar, stung by his rejection of her licentious advances, caused his imprisonment on a false charge; but his successful interpretation of the king's dreams soon raised him to supreme authority at the court. One of the dreams foretold a famine, against which he made ample provision; and such was his distinction that he married the daughter of the high priest of On or Heliopolis. While the famine prevailed, his brethren came from Canaan to Egypt to purchase corn. He at once recognized them, and after a period of delay in which he became convinced that they had lamented their former cruelty to him and repented of it, he made himself known to them, and appropriated to Jacob and his family the land of Goshen. The Egyptian people were

at length obliged to pay with their land for food for the public granaries, so that "Joseph bought all the land of Egypt for Pharaoh," and the whole territory of the country, excepting that of the priests, was let to the population as tenants. The story of Joseph is one of the most interesting portions of the Mosaic writings. He died at the age of 110 years, and left two sons, Manasseh and Ephraim, who, being adopted by Jacob, took their place among the heads of the tribes of Israel.

**JOSEPH**, the spouse of Mary the mother of Jesus Christ. He was of the tribe of Judah, and a descendant of David. Matthew and Luke give his genealogy, the former making him the son of Jacob and descended from David through Solomon, and the latter calling his father Eli, and tracing his lineage through Nathan. This discrepancy is explained in various ways. Julius Africanus supposes that Jacob and Eli were brothers, and that, Eli dying without children, Jacob married his widow, who bore him Joseph. The child was thus the son of Eli according to the Mosaic law, but of Jacob according to nature. Other commentators assume that the genealogy given by Luke is that of Mary. It is not known where Joseph was born. He was living at Nazareth, where, according to the received tradition, he followed the trade of a carpenter, when he was betrothed to Mary. Finding her pregnant, he was minded to put her away; but being warned by an angel in a dream that she was with child of the Holy Ghost, he took her to himself, but knew her not till she had brought forth her first-born son, who was called Jesus. Joseph is supposed to have died before the crucifixion of Christ, but there is little mention of him in the Scriptures. He is held in high honor in the Roman Catholic church, and March 19 is assigned as his festival. In painting he is represented as an aged man, with a lily or flowering branch.

**JOSEPH I.**, emperor of Germany, of the house of Hapsburg, eldest son of Leopold I. by his third wife, born July 26, 1678, died April 17, 1711. He was crowned king of Hungary in 1687, of Rome in 1690, and after the death of his father succeeded to the imperial throne of Germany in 1705. He inherited at the same time a double war, against Louis XIV. for the succession of his brother Charles to the throne of Spain, and in Hungary against the revolted patriots under Francis Rákóczy. He was willing to make concessions to the Protestants of Hungary and other provinces, frequently attempted to negotiate with the insurgents, and readily yielded to the demands of Charles XII. of Sweden in behalf of the Protestants of Silesia, which country the young conqueror crossed on his march from Poland to Saxony without even asking the permission of the distracted emperor. The victories of Marlborough and Eugene in the war of the Spanish succession allowed Joseph, who had personally taken part in the siege of Landau, to send con-

siderable forces against the Hungarians, and dissensions which broke out in the camp of the latter slowly prepared a final triumph of the imperial arms. Shortly before the death of Joseph, Count Pálffy succeeded in concluding a treaty with the insurgents at Szatmár, in the absence of Rákóczy. Joseph was of a mild disposition, and exceedingly fond of ceremony and of the chase. He founded the academy of arts at Vienna, and a national bank. He was succeeded by Charles VI.

**JOSEPH II.**, emperor of Germany, elder son of Francis I. and Maria Theresa, born March 13, 1741, died Feb. 20, 1790. When Joseph was born, his mother confided him and her rights under the pragmatic sanction to the protection of the Hungarian nation, which gallantly responded to her confidence, and Prince Batthyányi afterward took the principal charge of his education. Ambitious, but obstinate, Joseph gave proofs of considerable capacity. Languages, mathematics, war, and music were the studies to which he devoted most of his zeal. He participated in none of the campaigns of the seven years' war, though this was waged in the years of his advanced youth, and though he admired no less the military glory of its hero, Frederick, than he did after its close his peaceful career. He successively married and lost within seven years a princess of Parma and a princess of Bavaria. His only daughter died in 1770 in her eighth year. Made titular king of Rome in 1764, he became emperor of Germany on the death of his father in the following year; but this was then little more than an empty title, and in the hereditary possessions of his mother he received only the dignity of assistant without any real influence, though placed at the head of military affairs. He returned to the state 22,000,000 florins of bonds and all the estates which his father had purchased during his reign. He travelled extensively incognito, traversing not only the countries which were to be ruled by his sceptre, but also non-Austrian Germany, Italy, Spain, Holland, and France. He had an interview with Frederick in his camp at Neisse in Silesia (1769), a province which that king had wrested from the empire of Maria Theresa. Frederick in the following year repaid the visit at Neustadt in Moravia, where Joseph not only strove to display the perfections of his army, upon which he bestowed his principal cares, and into which he had introduced various liberal reforms, but also concerted with his guest the scheme of dismembering Poland jointly with Catharine II. of Russia. This extraordinary act was executed in 1772, and added Galicia and the Zips to the empire of Austria. A few years later Bukowina was taken from Turkey. Bavaria, the elector of which died in 1777, was also to be annexed, but Frederick suddenly marched into Bohemia; and Joseph, who eagerly grasped the opportunity of measuring his strength with that of the renowned conqueror, was compelled by the order of the

old empress peaceably to terminate the short struggle of succession. In 1780 he went to Mohilev to see Catharine, with whom schemes of Russian and Austrian aggression in Turkey and Italy respectively were agreed upon. Soon after his return his mother died, and the reign of the imperial philanthropist, so long impatiently looked for by liberal Europe, began. The long suppressed desire of totally transforming his empire and its nations, nourished by a love of the people, and a certainly not less ardent ambition, now found full satisfaction. Equality, centralization, and uniformity were the leading principles. Serfdom was abolished, German was made the official language everywhere, new codes were introduced, the press was almost entirely made free; about 700 convents, containing 36,000 of the younger monks, were dissolved, and all others placed under the bishops; the bulls of the pope were made dependent upon the *placet regium*; the bulls *Unigenitus* and *In Curia Domini* were expunged from the Austrian rituals; and by the celebrated edict of toleration, which, however, excluded deists, the Protestants were set on a perfectly equal footing with the Catholics. All this was executed without consulting any legislative or deliberative body, and the private rights of individuals were as little considered as the privileges of classes, or the prejudices and ignorance of the masses. The people were to be enlightened and made happy by decrees, all obstacles violently removed, and the refractory punished. Pius VI. personally visited Vienna, and strove in vain to check or moderate the reformatory movement. But in the mean time the interests which had been so violently assailed by these changes, having their defenders in the most powerful and most influential classes of society, were active in preparing the overthrow of the new system. Nobles, priests, and patriots were united in secret opposition. The dissatisfaction was most intense in Hungary, Brabant, Tyrol, and Bohemia. In Transylvania a bloody rising of the Wallach peasantry against the nobles, under Hora and Kloska, was slowly suppressed and most cruelly punished. Joseph's attempt to exchange the Austrian Netherlands for Bavaria was prevented by Frederick's last great act of external policy, the formation of the *Fürstentum* (confederation of princes) in 1785. Unflinching amid all these difficulties, Joseph proceeded in his course of reform, and, eager to add military glory to the fame of his internal achievements, visited Catharine at Kherson during her triumphal progress through the southern regions of her empire (1787), and finally concerted with her the long meditated war against Turkey. It was soon begun. Joseph opened it by a sudden attack on Belgrade, but suffered a repulse, which was followed by the defeat at Lugos (1788), and other disasters. A part of the army was lost, when Joseph returned to his capital, with a fatal malady, while victory followed the banners of the Russian

generals. Brabant, which had long been an open rebellion, declared its independence. Hungary was violently agitated, and it availed Joseph little that Laudon partially restored the fortunes of the war in 1789. The revolution in France brought new dangers. Broken in spirit, Joseph, shortly before his death, which was attributed by some to poison, abrogated all his innovations (January, 1790), except toleration and the abolition of serfdom.

**JOSEPH**, king of Naples and of Spain. See BONAPARTE, vol. iii., p. 29.

**JOSEPH, Father**, the confidential friend of Cardinal Richelieu, whose real name was FRANÇOIS LECLERC DE TREMBLAY, born in Paris, Nov. 4, 1577, died at Rueil, Dec. 18, 1638. He was the son of an eminent functionary, and his mother belonged to the Lafayette family. In his youth he saw much of society of different countries, and also something of warfare, having served in the army under an assumed name. Entering the priesthood, he attained great eminence in the order of Capuchin friars. His tact, intelligence, and activity attracted the attention of Richelieu, who employed him as his secretary and as his agent in many diplomatic negotiations. The immense work of the cardinal was performed by Father Joseph, who became indispensable to him, and was intimately associated with the most confidential and important transactions of the period. To an enthusiastic religious zeal, which caused him to send missionaries to England, Canada, and the East, and to advocate a crusade against the Turks, he added a consummate shrewdness and a wonderful capacity for incessant labor. Richelieu used to say that no statesman in Europe could grapple with the astute Capuchin friar, and deplored his death as a great calamity. The king prevailed upon the pope to make Joseph cardinal, but the latter died before the dignity was tendered to him. Owing to his immense influence over the cardinal and in public affairs, he was treated with great regard, though his cat-like and mysterious manner and his occasional outbursts of rudeness and wrath were repulsive. He is the reputed author of a Latin poem in favor of a crusade against the Turks, and of other writings, the most remarkable being manuscript memoirs in 4 vols. (in the national library in Paris, purporting to be a history of Louis XIII. in 1634-'6, but narrating events down to near the end of 1638; it gives authentic documents of several treaties, and interesting information about Wallenstein (in whose removal from command in 1629 Father Joseph was instrumental at Vienna), about the project of making a free state out of the Netherlands, and in respect to other schemes and incidents. Ranke submitted in 1860 a report on these memoirs to the French academy of moral and political sciences. Gérôme has painted a celebrated picture of Father Joseph, called *L'Éminence grise*.

**JOSEPHINE**, a S. W. county of Oregon, bordering on California, bounded N. by the Rogue

River mountains, and drained by Rogue and Illinois rivers; area, 1,000 sq. m.; pop. in 1870, 1,204, of whom 228 were Chinese. The surface is hilly and in some parts mountainous, with small valleys of rich alluvial soil. In the S. part are rich gold mines, and copper ore is also found. The value of farm productions in 1870 was \$24,775; of live stock, \$27,100. Capital, Kirbyville.

**JOSEPHINE**, empress of France. See **BONA-PARTE**, vol. iii., p. 46.

**JOSEPHUS, Flavius**, a Jewish historian, born in Jerusalem about A. D. 37, died about 100. His father belonged to the highest sacerdotal family, and his mother was descended from the Asmonean princes. He received a superior education, and acquired an extensive acquaintance with Greek literature. He studied the doctrines of the three Jewish sects, and passed three years in the desert with the ascetic Banus, of the sect of the Essenes, after which he remained by creed as by birth a Pharisee. At the age of 26 he was sent to Rome to plead the cause of some Jewish priests arrested by the procurator Felix, and, escaping from a shipwreck on his way, was introduced to Poppæa, the wife of Nero, and not only effected the liberation of his friends, but received many presents from the empress. Returning to Jerusalem, he attempted to dissuade the Jews from the revolt on which they were bent, but failing in his efforts he joined the war party. He was appointed one of the generals and deputed to defend the province of Galilee, and he made vigorous and for a time successful preparations against the Romans, though vehemently opposed by a strong party in the council at Jerusalem led by John of Giscala. On the approach of Vespasian in 67 he threw himself into Jotapata, the strongest of the Galilean cities, where he maintained a desperate resistance for 47 days. Escaping from the massacre which succeeded its fall, he took refuge in a cave, but was betrayed to the Romans. He thereupon assumed the character of a prophet, and, professing to derive his knowledge from the sacred books of the Jews, announced to Vespasian that the Roman empire should one day be his and his son's. Confidence in him was increased by the discovery from prisoners that he had foretold the exact number of days that the siege of Jotapata should last. He was not, however, released from bonds till Vespasian became emperor, and Titus succeeded to the control of the Jewish war. He was present at the siege of Jerusalem, suspected as a traitor by both Jews and Romans, and accompanied Titus on his return to Rome, where he passed the remainder of his life in literary pursuits. He was presented with the freedom of the city, an annual pension, and a house which had formerly been an imperial residence. He was three times married, and was divorced from his first two wives. Pride in the ancient glories of his nation, awe of the greatness and power of Rome, personal vanity, and a ten-

dency to unbounded flattery of the Flavian family, appear with equal prominence in his writings. In a passage, the genuineness of which is much disputed, allusion is made to Christ as something more than man, to his miracles, Messiahship, death, and resurrection in accordance with the prophecies; but there is no evidence that he was a Christian. His principal works are a "History of the Jewish War," written in Hebrew, translated by himself into Greek, and published about 75; and a treatise on "Jewish Antiquities," written in Greek, completed about 98. The former extends from 170 B. C. to the war which terminated in the destruction of Jerusalem, of which it gives a detailed narrative; and the latter includes the period from the creation to A. D. 66, and manifests a desire to conciliate heathen readers. He also wrote his own biography, and a treatise against Apion on the antiquity of the Jewish nation. An account of the martyrdom of Eleazar, and of seven youths and their mother, entitled *Εἰς Μαρτυρίαν*, has been ascribed to him, but is of doubtful genuineness. The best editions of his works are by Hudson (Oxford, 1720), Havercamp (Amsterdam, 1726), and Dindorf, in Didot's *Bibliotheca Græca* (Paris, 1845). The principal English translations are by Lodge (1602), L'Estrange (1702), Whiston (1737), and Dr. Robert Trail, who died, leaving finished only "The Jewish War," which was edited by Isaac Taylor (3 vols., London, 1847). An imitation of Josephus's histories, in excellent Hebrew, but containing many legendary and fabulous narratives, was composed in the middle ages, and has often been published under the title "Book of Josipon."

**JOSE BELL** (now called **BELL**), a S. E. county of Kentucky, bordering on Tennessee and Virginia, and drained by Cumberland river and the S. fork of the Kentucky; area, about 600 sq. m.; pop. in 1870, 3,731, of whom 111 were colored. The surface is mountainous. There are extensive deposits of coal and iron ore. The chief productions in 1870 were 3,608 bushels of wheat, 105,465 of Indian corn, 12,883 of oats, and 42,357 lbs. of butter. There were 670 horses, 2,660 cattle, 2,890 sheep, and 5,086 swine. Capital, Pineville.

**JOSHUA**, the successor of Moses in the command of the Israelites. He was the son of Nun, of the tribe of Ephraim. He gained the victory over the Amalekites at Rephidim, accompanied Moses to Mt. Sinai, was deputed with eleven others to explore the land of Canaan, was appointed by Moses, at the age of 85, to the command of the Israelites, led them into the promised land, and divided the country among the tribes. (See **HEBREWS**.) He governed Israel during 26 years. He was buried at Timnath-serah in the mountains of Ephraim. His reputed tomb was discovered in 1873, near Tibneh, by M. Guérin, who was employed by the French government in scientific researches in Palestine.—His history is contained in the

canonical book called after him. Formerly this book was usually regarded as a production of Joshua; but at present the common opinion among theologians of all schools is that it received its name from its subject, not from its author. While some critics believe it to have been written soon after the death of Joshua, others refer its origin to the time of David, or even of the Babylonian exile. Among the best commentaries on the book are those by Maurer (1835), Keil (1847; new ed., 1863), Knobel (1861), and Crosby (New York, 1874).—There is a Samaritan book of Joshua (published in Arabic and Latin by Juynboll, Leyden, 1848), which is a chronicle of events from the death of Moses to the time of Alexander Severus.

**JOSIAH**, king of Judah, son of King Amon, succeeded to the throne about 640 B. C., at the age of eight, and died about 609. Unlike his immediate predecessors, he did right in the sight of the Lord, and undertook to free the land from idolatry, though the groves and altars consecrated to idol worship were favored by men of rank and influence in the kingdom. Having accomplished this purpose in the 18th year of his reign, he proceeded to repair and adorn the neglected temple of the Lord. In the sanctuary there was found a volume containing the books of Moses, which seems to have been regarded as the original copy of the Mosaic law. Soon after this he ordered the celebration of the passover with a care and magnificence unexampled from the time of the judges. Being tributary to the Babylonian empire, he resisted the passage through his territories of the Egyptian king Necho, on an expedition against the Chaldeans, and fell in the battle of Megiddo fought between the Hebrew and Egyptian forces.

**JÓSIKA**, **MIKLÓS**, baron, a Hungarian novelist, born in Torda, Transylvania, Sept. 28, 1796, died in Dresden, Feb. 27, 1865. He studied law, and early entered the Austrian army, which he left in 1818 with the rank of captain of cavalry. After the reunion of Transylvania with Hungary in the spring of 1848, he became a member of the upper house of the Hungarian diet, was a decided supporter of Kossuth, and on the resignation of the Batthyányi ministry was appointed member of the committee of defence. He followed the revolutionary government to Debreczin, and after its overthrow effected his escape to Brussels, where he resided till 1864, when he removed to Dresden. Condemned to death in his absence, he was hanged in effigy in Pesth in 1851. His works include *Abafi* (1836); *Az utolsó Báthori* ("The Last of the Báthoris"); *A Csehek Magyarországon* ("The Bohemians in Hungary"); *Zrínyi a költő* ("Zrínyi the Poet"); *Jósika István* ("Stephen Jósika"); *A Csehek Magyarországon* ("The Bohemians in Hungary"); *Zrínyi a költő* ("Zrínyi the Poet"); *Jósika István* ("Stephen Jósika"); *A Csehek Magyarországon* ("The Bohemians in Hungary"); and *Misodik Rákóczi Ferenéz* ("Francis Rákóczy II.," 1861). All these, with others of his works, have been translated into German, partly by Klien, partly by the

author's second wife Julia Podmaniczky, whom he married in 1847.

**JOSQUIN DES PRÉS**, or **DEPRÉS** (JODOCUS PRÆTENSIS), a French composer, born in Hainaut, Belgium, about 1450, died at Condé, France, Aug. 27, 1531. Though known to musicians as Josquin, this was only his Christian name, it being the contraction of the Flemish *Josquin*, or little Joseph. He was rightly styled the father of modern harmony, and was esteemed in his own day as the greatest composer of his time. Preceding as he did by nearly a century Palestrina, Cipriano, and Orlando di Lasso, he nevertheless anticipated most of their methods and forms of composition. So great was his knowledge of counterpoint and fertility of invention, that every subtlety of the art seemed known to him. His first master was Jean Ockeghem, one of the chaplains of Charles VII., with whom he studied at Paris for several years. He then went to Italy, and entered the pontifical choir of Sixtus IV., at Rome. Here he studied with diligence and gave the first proofs of his great genius as a composer. Returning to France, he was made the chief singer in the chapel of Louis XII., a position corresponding to that of chapelmaster subsequently created. He added to his duties as musician those of an ecclesiastic. The king had promised Josquin a benefice, but it was long before the promise was redeemed, the composer being constantly put off with the words *Laissez moi faire*. At last Josquin composed a mass on the notes *La sol fa ré mi* (*Laissez faire moi*). This not being effectual as a reminder, he composed music to a part of the 119th psalm (*Memento verbi tui sermo tuo*), "Remember thy word unto thy servant, upon which thou hast caused me to hope." This also failing to produce the desired effect, Josquin composed a motet on the words, "I have no inheritance in the land of the living." Upon this the benefice was granted, and the composer expressed his gratitude in a setting of the psalm, "O Lord, thou hast dealt graciously with thy servant." These compositions were all of great merit. The works of Josquin were numerous, consisting of masses, motets, and other compositions of a religious character. Many of them are preserved among the manuscripts of the British museum.

**JOST**, **ISAAC** **MARUS**, a German author, born in Bernburg, Feb. 22, 1793, died in Frankfurt, Nov. 25, 1860. He studied at Göttingen and Berlin, was appointed teacher in the latter city in 1816, and in 1835 principal teacher of the Jewish *Realschule* in Frankfurt, which post he held till his death. Of his numerous historical and other works, the best known are: *Geschichte der Israeliten* (9 vols., Berlin, 1820-'29); *Allgemeine Geschichte des jüdischen Volkes* (2 vols., 1832); *Neuere Geschichte der Israeliten* (3 vols., 1846-'7), containing the history of the Jews since 1815; and *Geschichte des Judenthums* (3 vols., Leipsic, 1857-'9). He translated the Mishnah into German (6

vols., 1832-4), and in 1839-41 edited the *Israëlitische Annalen* (Frankfort).

**JOTUNS.** See MYTHOLOGY.

**JOUBERT, Barthélemy Catherine**, a French general, born at Pont-de-Vaux, in Bresse, April 14, 1769, fell at the battle of Novi, Aug. 15, 1799. He enlisted in the army in 1791, distinguished himself on the Rhine and in Italy, and especially in the invasion of Tyrol which preceded the peace of Campo Formio (1797). Napoleon gave him the highest praise, and sent him to Paris with the trophies of his brilliant victories, upon which the directory successively placed him at the head of the army in Holland, at Mentz, and in Italy (August, 1798), where he speedily occupied Piedmont and gained possession of vast materials of war in the arsenal of Turin and other places. He took umbrage in 1799 at the commissioners appointed by the directory for the prevention of venality among the generals, and tendered his resignation, which was accepted. He was soon reinstated in his command, but being detained in Paris by his marriage with Mlle. de Montholon, he reached his headquarters only in August to take the place of Moreau. Joubert, in order to recover the ground lost during his absence (Alessandria and Mantua having surrendered in July), at once crossed the mountains of Montferrat with 20,000 men, took Acqui, and effected a junction with the remains of the army of Naples under Championnet, when his forces mustered about 40,000, against 70,000 Russians and Austrians. Before he had time to carry out his project of retiring to the passes of the Apennines to await additional reinforcements, he was attacked at the dawn of Aug. 15 by Suvaroff, and, exposing himself to the fire of the enemy, was shot while encouraging his soldiers, and died begging one of his aides-de-camp to make the Russians believe that he was still alive. Joubert's death was mourned as a great public calamity. Fort La Malgue at Toulouse received the name of Fort Joubert, and monuments in his honor were erected at Bourg and in the senate building. It was generally believed that if he had lived, he instead of Napoleon would have been called upon by the directory to restore order in Paris.

**JODIPORE.** See JODPOOR.

**JOUFFROY, Théodore Simon**, a French philosopher of the eclectic school, born in the hamlet of Les Pontets, Doubs, July 6, 1796, died in Paris, Feb. 4, 1842. After attending the college of Nozeroy, he was confided in 1807 to the care of his uncle, an ecclesiastic and professor in the college of Pontarlier, with whom he remained four years, and was then transferred to the college of Dijon. Rollin was the first author in whom he took delight, and history continued through his life to be a constant and favorite study. He had already attempted a tragedy, when in 1814 he was selected as a brilliant pupil for admission into the normal school. Theological meditations had led him to the highest problems, and he

describes himself as at this time uncertain about the enigma of human destiny, yet detesting incredulity, and resolute to solve the question by the light of reason, since he had lost that of faith. He was thus in a condition to be strongly impressed by the youngest of his masters, Victor Cousin, whose eloquent lectures decisively directed his vocation to philosophy. In 1817 he became pupil-assistant in the philosophical department of the normal school, at the same time lecturing in the Bourbon college, and fulfilled both tasks till his health obliged him to resign the latter in 1820. By the suppression of the normal school in 1822, he was deprived of public employment for five years, and in the interval he delivered a private course of lectures, attended by the élite of the young men of the capital; published philosophical articles in the *Globe* and other journals and reviews, one of which, entitled *Comment les dogmes finissent*, added much to his reputation; translated the "Moral Philosophy" of Dugald Stewart (Paris, 1826), to which he furnished an elaborate preface; and began his translation of the complete works of Thomas Reid (6 vols., Paris, 1828-'35), to which he added several of the lectures of Royer-Collard, and a preface in which he undertook a complete examination of the Scottish philosophy. In 1828 he was made assistant professor of ancient philosophy in the faculty of letters of Paris, and, interested rather in philosophy than its history, treated of the faculties of the soul in a course of lectures on the first "Alcibiades" of Plato; and in 1830 became adjunct professor of the history of modern philosophy, and delivered his *Cours de droit naturel* (2 vols., 1835; vol. iii., edited by Damiron, 1842), his most eloquent work, which treats at once of ethics, psychology, and theodicy. In 1831 he was elected to the chamber of deputies, and in 1833 was appointed to the chair of Greek literature and philosophy in the collège de France, and elected to the academy of moral and political sciences. In 1835 he was obliged to seek a restoration of his health in Italy, and on his return in 1838 resigned his professorship to succeed Laromiguière as librarian of the university. His feeble voice and calm and methodical mind alike unfitted him to excel in the chamber of deputies, though from his abilities and personal character he always commanded attention. In 1840 he was called into the royal council of public instruction, and, being appointed to draw up the address of the new ministry, maintained that its administration should be distinguished by some broad difference from that which had preceded it. Finding himself in a minority, his disappointment had a fatal influence on his already broken health. His principal works not already mentioned are the *Mélanges philosophiques* (1833), containing 28 essays, most of which had before appeared in periodicals; the *Nouveaux mélanges philosophiques*, edited by Damiron (1842); and the *Cours d'esthétique*, also edited



by Damiron (1843). His *Cours de droit naturel* has been translated into English under the title of "An Introduction to Ethics," by W. H. Channing, and a selection from his essays under that of "Philosophical Miscellanies," by G. Ripley, in Ripley's "Specimens of Foreign Literature" (Boston, 1838-'40).

**JOUFFROY D'ARBANS, Claude François**, marquis de, a French mechanician, born about 1751, died in Paris in 1832. The idea of steamboats occurred to him first in 1775, on occasion of his examining a fire engine; but he failed in the experiment which he made with a small propeller on the river Doubs in the summer of 1776. Other experiments in 1780 and 1783 on the same river and on the Saône at Lyons were less unsatisfactory, though far from successful; and the government, after referring the matter to the academy, declined (1784) to grant him a patent, whereupon he went to England. He did not return to France until the consulate, when he became acquainted with Fulton. In 1816 he received permission to form a company, and the count of Artois allowed him to give his name of Charles Philippe to the first steamer, which was launched on the Seine Aug. 20. But the enterprise, as well as that of a rival company, ended disastrously, and the marquis retired after the July revolution to the Invalides, where he died of the cholera. He wrote *Mémoires sur les pompes à feu* for the academy, and published in 1816 *Les bateaux-à- vapeur*. His claim to the discovery of steam navigation was acknowledged by Arago, and in 1840 by the French academy; and Fulton spoke highly of his invention.—His son **ACHILLE**, marquis de, born about 1790, was an ardent legitimist politician and writer, but after the revolution of 1830 devoted himself to the perfecting of steamboats, invented an unsuccessful system of railway propulsion, and published several works on history, inventions, &c.

**JOULE, James Prescott**, an English natural philosopher, born at Salford, Dec. 24, 1818. At the age of 15 he became the pupil of Dr. John Dalton, the author of the atomic theory, who trained him in the art of physical experimentation and the philosophy of chemistry, and taught him mathematics. His first scientific paper was upon the construction of electro-magnetic engines; but on account of the difficulties in the way, the chief of which is the rapid decrease of attraction accompanying increase of distance between magnets, he soon relinquished the design of producing a practical motor. In 1841 he gave a lecture in the royal Victoria gallery at Manchester on the results of his experiments on a new class of magnetic forces, which embraced a statement of what had been done by Jacobi of St. Petersburg and himself in applying magnetism as a motive power. Continuing the investigation in connection with Mr. Scoresby, Joule arrived at the result that a grain of coal consumed by a steam engine will raise 143 lbs. one foot in height, while a grain

of zinc consumed in a voltaic battery can only raise, theoretically, a weight of 80 lbs. through the same distance; and that the cost of power by electro-magnetism is about 25 times greater than that of steam. His communication to the royal society "On the Change of Temperature produced by the Rarefaction and Condensation of Air" led Prof. Thomson of Glasgow to unite with him in investigating the thermal effects of fluids in motion. The first of the series of papers on this subject was read before the royal society in June, 1853, the last in June, 1862; and they were all published in the "Philosophical Transactions." He also published, in connection with Dr. Lyon Playfair, an account of investigations into the volumes occupied by bodies when in a solid state, and when dissolved in water; a subject having many important relations to molecular physics. His inventive talent was early displayed in the construction of galvanometers, the use of which was so constantly required in his electro-magnetic investigations. In 1863 he described to the Manchester society a new and sensitive thermometer, with which he was enabled to detect heat in the moon's rays. The principal subject to which he has devoted himself, however, is that of heat in its relation to mechanical power. His labors in this direction commenced about the year 1840, when he communicated to the royal society the discovery of a principle in the development of heat by voltaic action, in which he established certain relations between heat and chemical affinity. The experiments of Count Rumford in 1796-'8 had exposed the fallacy of the caloric or material theory of heat, and had very nearly established the mechanical equivalence of heat, and Prof. Mayer of Heilbronn had announced his belief that the heat evolved in compressing a gas was exactly equal to the compressing force; but these views required for their complete establishment the demonstration by experiment. Placing water in a vessel made for the purpose, Joule agitated it by paddles driven by a measured force, and determined both the amount of heat produced by stirring the liquid, and the amount of labor expended. He also measured the amount of heat produced by revolving cast-iron wheels against one another. He varied the experiments by forcing water through capillary tubes, and calculating the heat generated by the friction produced. He employed other liquids in place of water, such as oil and mercury, and although he found a different degree of sensible heat evolved with the same force expended upon different fluids, still he found that it was exactly in the inverse proportion of the fluid's specific heat, thus adding another proof of the correctness of his opinions, and of his methods of experimenting. By numerous trials he found that the quantity of heat required to raise one pound of water one degree F. in temperature is precisely competent to raise 772 pounds avoirdupois one foot in height, or in other words, is equal to

772 "foot pounds," which is the measure of the force called the mechanical equivalent of heat. (See CORRELATION OF FORCES.) In consideration of these important labors, the royal medal of the royal society was awarded to him in 1852, and in 1860 he received the Copley medal. His contributions to scientific periodicals and other publications have been numerous and important. He was elected a fellow of the royal society in 1850; has received the degree of D. C. L. from Oxford, and of LL. D. from Dublin and Edinburgh; is a corresponding member of the institute of France; and was president of the British association for the advancement of science in 1873.

**JOUNPORE.** See JOONPOOR.

**JOURDAN, Antoine Jacques Louis**, a French physician, born in Paris, Oct. 29, 1788, died there, Jan. 2, 1848. He was a surgeon in the army and in military hospitals till 1814, and took the degree of M. D. in Paris in 1819. He wrote *Traité complet des maladies vénériennes* (2 vols., 1826), *Pharmacopée universelle* (2 vols., 1828; 2d ed., 1840), and *Dictionnaire raisonné, étymologique, synonymique et polyglotte des termes usités dans les sciences* (2 vols., 1834). He translated many works from the German (including those of Hahnemann), English, Italian, and Latin.

**JOURDAN, Jean Baptiste**, count, a French general, born in Limoges, April 29, 1762, died in Paris, Nov. 23, 1833. He enlisted in the army when scarcely 16 years old, served five years in America under Count d'Estaing, and was discharged in 1784. He then became a merchant's clerk, and had married a milliner and adopted her business when the revolution broke out. He became a lieutenant of the national guards, and was in 1791 elected to command a battalion of volunteers; he joined the army of the north, distinguished himself in Belgium under Dumouriez, was appointed brigadier general in 1793, and four months later promoted to the rank of general of division. Wounded at the battle of Hondschoote, he had scarcely recovered when he was placed in command of the army of the north. He drove the imperial troops from their position at Wattignies, Oct. 16, 1793, and was called to Paris to consult with the committee of public safety; but being unexpectedly placed on the retired list, he returned to his shop at Limoges. But his services could not well be dispensed with, and on April 15, 1794, he received the command of the army of the Moselle. A few days later he was transferred to that of the Sambre and Meuse, with which he won (June 26) the victory of Fleurus, executed several other successful operations, and drove the Austrians beyond the Rhine. In 1795 he displayed uncommon talents in crossing that river. In 1796 he advanced into Germany, and defeated Clerfayt at Altenkirchen; but being subsequently worsted near Würzburg by the archduke Charles, he was obliged to fall back, and resigned his command. In 1797 he was

elected to the council of 500, where he procured the adoption of the law of military conscription. He was president of that body in October, 1798, when he resigned his legislative functions to assume the command of the army on the Danube. After a short and unsuccessful campaign, he returned to Paris, was reelected to the council of 500, refused to participate in the plans of Bonaparte for the subversion of the directorial government, and was one of the members excluded from the corps législatif formed after the 18th Brumaire. He nevertheless was sent by the first consul on a special mission to Piedmont, and reconciled that country to the French domination. He was appointed marshal of the empire and grand eagle of the legion of honor in 1804, but received no important command, and lived in comparative inactivity until he was appointed in 1806 governor of Naples, and became the principal adviser and friend of Joseph Bonaparte. He accompanied Joseph to Spain, with the title of major general of the armies of his Catholic majesty; but he had as such neither authority nor influence, and was not answerable for the reverses of the French armies in the Peninsula from 1808 to 1813. He was treated by Napoleon with a coldness amounting to disgrace. In 1814, having assented to the deposition of Napoleon, he received a peerage from Louis XVIII. He joined Napoleon during the hundred days, but on his defeat at Waterloo went back to the Bourbons, was created a count, then governor of the seventh military division, and in 1819 peer of France. On the revolution of July, 1830, he held for a few days the ministry of foreign affairs, and was appointed by Louis Philippe governor of the Invalides. He was honest, and died poor.

**JOURNALISM.** See NEWSPAPERS.

**JOUEL, Henri**, a French explorer, born in Rouen about 1651. He was the son of a gardener, served in the army from an early age, and in 1684 joined La Salle's expedition to the mouth of the Mississippi. La Salle placed Jouetel in command of his first fort in Texas, and also of the larger one, St. Louis, when he set out in November, 1685, to seek the river. On the last expedition, in January, 1687, Jouetel accompanied La Salle, and was in charge of the camp when the latter was assassinated. Leaving the murderers, he set out with La Salle's brother and nephew and three others, and reached Canada by way of the Illinois. Thence he returned to France in 1688, and retired to his native city. In 1713 appeared at Paris his *Journal historique du dernier voyage que feu M. de la Sale fit dans le golfe de Mexique*, edited by M. de Michel. Charlevoix met Jouetel at Rouen in 1723, and speaks highly of him. The only stain on him is his complicity in the fraud practised by Cavalier on Tonty in the Illinois country.

**JOUVENET, Jean**, a French painter, born in Rouen about 1645, died in Paris, April 5, 1717. He belonged to a family of artists, be-

came known in 1673 by his "Jesus curing the Paralytic," and was professor and president of the academy of painting. In 1675 appeared his masterpiece, "Esther before Ahasuerus," comparing favorably with the works of Poussin and Lebrun. Several of his pictures are at Notre-Dame and in the Louvre. His right hand being disabled shortly before his death, he painted with his left hand the "Magnificat" in the choir of Notre-Dame.

**JOUY, Victor Joseph Etienne de**, a French author, born at Jouy, near Versailles, probably in 1764, died in St. Germain-en-Laye, Sept. 4, 1846. Having enlisted in the army when a boy, he went to South America, and afterward to India, where he was introduced to Tippoo Sahib. He participated in the first campaigns of the French revolution, reached the rank of major, and at the age of 33 was placed on the retired list. He now produced several light comedies, and in 1807 gained considerable reputation by *La vestale*, a lyric poem, set to music by Spontini; this performance was rewarded three years later with one of the great decennial prizes. He composed the libretti for Spontini's *Fernand Cortez* (1807); Catel's *Les bayaderes* (1810), Cherubini's *Les amazones* and *Les Abencerrages* (1812-13), and Rossini's *Moses* (1827) and *Guillaume Tell* (1829). He also attempted tragedy. His *Tippo-Sahib* was performed in 1813; *Sylla*, for which Talma's acting, and especially his wonderful resemblance to Napoleon, secured a remarkable success, in 1822; *Belmire* in 1825; and *Julien dans les Gaules* in 1827. A series of his sketches was collected in 1812-'14 under the title of *L'hermite de la chaussée d'Antin*, which was compared with Addison's "Spectator." In 1815 he became a member of the French academy. Under the restoration he took an active part in politics, and his attacks brought the wrath of the government upon him and his friend Jay; both were incarcerated for a few months, which considerably added to their popularity, and was the occasion of their publishing *Les hermites en prison* (1823) and *Les hermites en liberté* (1824). After the revolution of July, 1830, he was appointed librarian at the Louvre by Louis Philippe, who granted him also in his later years an apartment in the chateau of St. Germain. He published his own *Œuvres complètes* (27 vols. 8vo, Paris, 1823-'37).

**JOVELLANOS, Gaspar Melchior de**, a Spanish poet, born in Gijon, Jan. 5, 1744, died at Vega, Nov. 27, 1811. He was originally destined to the church, and received his first tonsure at the age of 13. But after having studied philosophy at the university of Oviedo, his friends in Madrid persuaded him to change, and he was appointed a magistrate of the criminal court of Seville in October, 1767. In 1774 he became judge of the same court, and four years later alcalde of the royal household and court at Madrid. The friend and protector of Cabarrus, he shared in the persecutions visited upon the latter by Godoy. Cabarrus was cast into

prison, and Jovellanos banished from court, under the pretext of a mission to explore the province of Asturias, and report upon the state of its natural resources. On the restoration of Cabarrus to Godoy's favor Jovellanos was recalled (1797), and appointed ambassador to Russia; but before he had time to set out he was made minister of justice. But Godoy soon sent him once more to Asturias, and in 1801 had him dragged from his bed by night, hurried to Barcelona, and transported to Majorca, whence he did not return until after the downfall of Charles IV. in 1808. He rejected a portfolio tendered him by Joseph Bonaparte, but represented his native province in the first central junta, and was its leading spirit in the darkest moments of his country's struggle for existence. When the junta was dissolved on the approach of the French troops, he succeeded in reassembling the dispersed members, and prevailed upon them to yield their power to the regency. He then returned to Gijon, whence upon the occupation of the town by the French in 1811 he escaped to Vega. Distinguished alike as a patriot and a scholar, he materially aided Llorente in his endeavors for the introduction of such reforms into the tribunal of the holy office as should insure the publicity of its proceedings, and strove sedulously for the reform of the Spanish drama. His complete works (7 and 5 vols., Madrid), with a biography prefixed, comprise lyrical and didactic poems, epistles, odes, and other minor compositions in verse, both grave and gay; a drama, *El delincuente honrado*, a discourse on the study of history; a paper on the agrarian law, &c. Jovellanos was versed in English literature, and translated the first book of "Paradise Lost."—See *Memorias para la vida de Jovellanos*, by Cean-Bermudez (12mo, Madrid, 1814).

**JOVIAN (FLAVIUS CLAUDIUS JOVIANUS)**, Roman emperor, died in February, 364, after a reign of seven months. The son of Varronianus, one of the greatest generals of his age, he was captain of the body guards of the emperor Julian, and participated in his fatal campaign against the Persians. After the death of Julian, he was proclaimed emperor by the legions, and declared himself a Christian. His army was in the midst of a hostile country, from which his first care was to extricate it. But Sapor, the Persian monarch, so harassed his march with repeated attacks, that Jovian, to save his army from destruction, consented to an ignominious peace, which restored to the Persians several possessions formerly wrested from them, both E. and W. of the Tigris. On reaching the Roman territory, the emperor caused an edict to be issued which annulled Julian's edicts against the Christians, and restored the supremacy of their religion; but he would not permit the pagans to be oppressed on account of their belief. On the way to Constantinople he arrived, Feb. 16, 364, at Dadastana, an obscure village of Galatia, where he was found dead in his bed the next morn-

hether suffocated by the charcoal fire in  
 m, or overcome by intemperance, or  
 tim of poison, is uncertain.

**ES, Paulus.** See GROVIO.

**ETT, Benjamin,** an English clergyman  
 tic, born at Camberwell in 1817. He  
 lucated at St. Paul's school, elected  
 of Balliol college, Oxford, in 1835, and  
 three years later. He became tutor in  
 ege in 1842, was very successful as an  
 or, and was appointed regius professor  
 sk in the university in 1855, and master  
 liol college in 1870. He published a  
 nentary on the Epistles of St. Paul to  
 essalonians, Galatians, and Romans"  
 , 1855), and contributed to the "Essays  
 views" a paper "On the Inspiration of  
 re." His principal work is "The Dia-  
 of Plato, translated into English, with  
 es and Introductions" (4 vols., 1871).

**F, or Djowf** (Arab., belly), a province of  
 anate of Jebel Shomer, Arabia, between  
 ° and 30° N., and lon. 39° and 41° E.;  
 out 700 sq. m.; pop. about 40,000. It  
 d of oasis, a deep oval depression in the  
 by which it is surrounded as if by hills,  
 0 m. long by 10 or 12 broad. The prin-  
 own, of the same name, is a collection  
 t villages, once distinct but now united.  
 h, another large village, lies 12 m. N. E.  
 f. The united population of the two  
 is about 34,000. The climate of the val-  
 emperate and dry. The gardens of the  
 re celebrated in that part of the East.  
 e palm is the main object of cultivation,  
 e peach, apricot, fig, and grape grow  
 ntly, and surpass in flavor the fruits of  
 nd Palestine. Various cereals, legumi-  
 ants, gourds, melons, &c., are also raised.  
 dens are irrigated by running streams,  
 of from wells and cisterns, as in the  
 . The inhabitants are fine specimens of  
 rthern Arab type. They are tall, well  
 igned, and of dignified carriage, strong,  
 long-lived, brave, hospitable, and intel-  
 .

They are said to have been Christians  
 their forcible conversion to Islamism.—  
 wf became subject to the Wahabee mon-  
 ear the close of the last century, but re-  
 its independence at the downfall of that

Civil contentions followed, and the  
 iding Bedouins forced it into a tributary  
 . This continued until the rise of the  
 tanate of Jebel Shomer, when it was  
 l and made a province of that govern-  
 . Since then it has advanced rapidly in  
 and civilization.

**, Antonio,** a Portuguese dramatist, born  
 on early in the 18th century, burnt  
 sept. 23, 1745. His comic plays were  
 opular, especially "Don Quixote" and  
 . Being of Jewish descent, he was  
 of Judaism, and condemned by the  
 ion to die at the stake. His works are  
 d in the *Theatro comico portuguez* (5  
 isbon, 1759-'62).

**JUAB,** a central county of Utah; area, 1,100  
 sq. m.; pop. in 1870, 2,034. It is situated in  
 a mountainous region, and contains the sources  
 of streams flowing N. to Utah lake and S. W.  
 to Sevier river and lake. The loftiest peak is  
 Mt. Nebo, 12,000 ft. high. Along the E. bor-  
 der is the most elevated portion of the Wasatch  
 range. Only a small portion is suitable for  
 agriculture. The chief productions in 1870  
 were 23,965 bushels of wheat, 6,141 of Indian  
 corn, 2,069 of oats, 12,320 of potatoes, 5,947  
 lbs. of wool, 23,300 of butter, and 1,181 tons  
 of hay. There were 313 horses, 460 milch  
 cows, 607 other cattle, and 2,908 sheep; 1 flour  
 mill, 2 saw mills, and 1 wool-carding estab-  
 lishment. Capital, Nephi.

**JUAN, Don.** See JOHN OF AUSTRIA.

**JUANES, or Joanes, Vicente,** a Spanish painter,  
 born at Fuente la Higuera, Valencia, in 1523,  
 died at Bocairent, near Alicante, Dec. 21, 1579.  
 He studied in Italy, and devoted himself to re-  
 ligious subjects, his piety leading him to par-  
 take of the communion as a preparation for  
 each new painting. His studio at Valencia  
 became a nucleus of art, and he was one of  
 the most renowned Spanish painters of his day.  
 The churches and convents of Valencia and  
 other parts of Spain abound with his works.  
 His masterpieces are the "Baptism of Christ"  
 in the cathedral of Valencia, and six pictures  
 of the life of St. Stephen in the royal palace  
 of Madrid. The finest of his works in the  
 Louvre is the "Holy Supper."

**JUAN FERNANDEZ,** an island in the South Pa-  
 cific ocean, in lat. 33° 38' S., lon. 78° 46' W.,  
 about 420 m. W. of Valparaiso, belonging to  
 Chili. It is of irregular form, about 12 m. in  
 length from E. to W., but not more than 4 m.  
 across in the widest part. A small detached  
 portion at the S. W. end is called Santa Clara  
 island. About 92 m. W. lies a small island  
 called Mas-á-Fuera (further off shore), Juan  
 Fernandez being distinguished as Mas-á-Tierra  
 (nearer the mainland). Mas-á-Fuera is covered  
 with trees and well provided with fresh water;  
 but being destitute of anchorage or landing  
 place, it is seldom visited, and very little known.  
 Juan Fernandez is, like most of the isolated  
 oceanic islands, of volcanic origin, though the  
 original shape and position of the crater are  
 difficult to trace. The principal material in its  
 formation is a stratified tufa, interspersed with  
 blocks of harder volcanic rocks, such as vesic-  
 ular lava and greenstone. The N. E. part is  
 high, rising to 3,000 ft. in the mountain called  
 El Yunque (the anvil). The headlands form  
 abrupt cliffs toward the sea, and are separated  
 by narrow valleys, clothed in rich vegetation,  
 and watered by small streams of excellent wa-  
 ter. The S. W. prolongation of the island is  
 less elevated, forming a plateau covered with  
 grass, destitute of trees, and bordered by cliffs.  
 A few other parts of the S. shore present the  
 same appearance. The island is very pictu-  
 resque, particularly when approached from the  
 north. The mountains, rising rapidly from

the sea, have when seen from that side an aspect of grandeur which they lose when seen from other directions. Notwithstanding their steepness, which renders most of the summits inaccessible, they are wooded to the top. The only anchorage in use is Cumberland bay in the N. E. part; it is well sheltered from the southerly winds, which are the prevailing ones in summer. Two valleys open into this bay, and at their confluence is situated the settlement, consisting of a few Chilian huts, surmounted by the remains of a fort.—The first settler on the island was a Spaniard, after whom it is named, who resided here with his family, but afterward went to live on the newly conquered mainland of Chili. Subsequently the island was for a long time a debatable ground between the Spaniards and the buccaneers, the latter finding it a convenient place to refit within easy distance of the Spanish settlements. To that period may be attributed the numerous small batteries of which the remains can be seen in Cumberland bay, and, according to the residents, in all the small bays in which a landing might have been attempted. At one time it was made the seat of a Chilian penal settlement. To the labor of the convicts are due the series of large caves, dug in the side of the hill above the anchorage, now being rapidly closed up by the crumbling of the hillside. A foot path over the Yunque range, through a pass 1,800 ft. high, was also constructed by them. In 1872 only a dozen Chilians resided on the island, cultivating a few vegetables, and raising poultry in limited quantities; but they were supplied with most of the necessaries of life from Valparaiso.—It is doubtful whether there were any native land mammals on the island at the time of its discovery. Anson indeed speaks of having seen the burrows of an animal called *pardela* by older writers, which he thought to be then extinct. Goats were early introduced, perhaps by Juan Fernandez himself. They multiplied enormously, and formed the chief supply of the buccaneers who used the island as a rendezvous. The viceroy of Peru caused a large number of dogs to be landed, in the hope that they would destroy the goats and thus deprive the buccaneers of this resource; but the steepness of the summits and of the cliffs preserved many of those animals. When Anson visited the island (1741) the dogs were still numerous, but subsisted chiefly on young seals. At present they have been nearly exterminated by the settlers, and the goats have increased again, though mostly confined to the southern slope of the island. Horses and asses roam over the island in a half wild condition; horned cattle and a few sheep are kept by the settlers, but apparently in numbers much below the resources of the pasture offered. The shores were formerly frequented by large numbers of seals, sea lions, and sea elephants. The last are extinct, as on the neighboring coast of South America, and the first have become

much less numerous. A thrush-like bird and one or two of smaller size are found in the woods. A fine humming bird is abundant at a considerable elevation; and a few hawks may occasionally be seen. Most of these birds are peculiar to this island. Pigeons, resembling the European rock pigeon, frequent the cliffs on Cumberland bay, and may have been introduced. Few sea birds are seen except at the breeding season on some of the islets on the S. side. No reptiles have been found here. Fish are abundant, and are dried for the Chilian market, to which are also sent the dried tails of a large crawfish.—The most striking parts of the vegetation are a myrtle-like tree, the aromatic wintersbark, tree ferns, and a large variety of other ferns. A remarkable palm, peculiar to the island, but very limited in numbers, grows only on a few inaccessible summits. Apples, plums, apricots, and peaches were planted by Anson, and have become plentiful. Fig trees grow luxuriantly near the settlement, where also turnips and radishes run wild in abundance. A species of *Guanay*, with enormous leaves, forms a beautiful ornament, overhanging the small streams at the bottom of the valleys. Strawberries abound. The pasture lands are covered with a species of oat, besides other grasses.—A romantic interest attaches to this island through the story of Alexander Selkirk, supposed (though probably without reason) to have given to Defoe the idea of "Robinson Crusoe." (See D'ARCY.) Selkirk, a Scotch sailing master on board the ship *Cinque Ports* of Dampier's squadron, was left on this island at his own request (1704), on account of differences with his captain. He remained in solitude four years and four months, and was finally taken off in February, 1709, by Capt. Woodes Rogers. After having exhausted his ammunition, he subsisted by running down and catching goats. Tradition points to a cave in the bay next west to Cumberland bay as his habitation. The summit of the pass over the Yunque range is called his lookout, and a tablet reciting the principal points of his history has lately been placed there by the officers of the British ship *Topaz*. Previously to Selkirk, a Mosquito Indian had been accidentally left behind, and taken away again, after the lapse of three years, by Dampier.

**JUAN Y SANTACILIA**, *Jorge*, known as Don *Jorge Juan*, a Spanish explorer, born at Orihuela, Valencia, in 1712, died in Cadix June 21, 1774. He crossed the Atlantic in 1733 as commander of a frail polacca, explored a great portion of the American coast, and made astronomical observations which on his return to Madrid led to his election to the academy. Philip V. appointed him vice admiral, and rejoined him in 1735 to Ulloa's expedition to South America for the measurement of a degree of the meridian at the equator, with the assistance of La Condamine and Bouguer of the French academy. In 1753 he became commander of the marine guards and inspector of

harbors, and promoted the efficiency of the Spanish navy. He wrote the scientific part of Ulloa's *Relacion* of the expedition to South America and of the measurement at the equator (see ULLOA, ANTONIO DE), and jointly with him published a historical and geographical dissertation on the Spanish-Portuguese meridian boundary line (Madrid, 1749; French, Paris, 1776). His other works include a manual of navigation (Madrid, 1757), and a work relating to the application of technology to ship building (2 vols., Madrid, 1761-'77), which has been translated into English and French.

**JUAREZ, Benito Pablo**, president of Mexico, born in the village of San Pablo Guetatao, near Tixtlan, in the state of Oajaca, March 21, 1806, died in Mexico, July 18, 1872. When very young he lost his parents, who were Indians in humble circumstances; and at the age of 12, when he was still unable to speak Spanish, an uncloistered friar of Oajaca took him into the service of his family, and gave him his first education, placing him afterward at the seminary of that city. Young Juarez soon abandoned theology for the law; and having graduated with honors at the new college of Oajaca, where in addition to his legal studies he held the chair of natural philosophy from 1829 to 1831, he was admitted to the bar in 1834. In 1836 he was imprisoned by the conservatives; but in 1842 he became chief judge of the republic, which post he held till 1845, when a partial triumph of his party led to his appointment as secretary of the state government of Oajaca under Gen. Leon. He was, however, soon obliged to give up this office, and he acted as chief justice of the superior court till the end of the same year. When the revolution headed by Salas triumphed in August, 1846, the state of Oajaca resumed its sovereignty, and established a junta, vesting the executive power in a triumvirate composed of Fernandez del Campo, Arteaga, and Juarez. The junta immediately after its organization restored the constitution of 1824; and Arteaga was elected governor, while Juarez was sent as deputy to the general constituent congress of 1846, where he gave a vigorous support to the policy of the acting president Farias in negotiating a loan of \$14,000,000 on church property, to defray the expenses of the war against the United States. Arteaga having resigned in 1847, Juarez was elected in his stead, and remained governor till August, 1852. During this period he introduced many useful reforms, and managed the finances so well that, after over-paying all the contributions to the national government and liquidating the state debt, he left on retiring a surplus of \$50,000 in the treasury. One of the first acts of his implacable enemy Santa Anna, on seizing the reins of government soon afterward, was the arrest and exile of Juarez, who, almost destitute of resources, sojourned two years in New Orleans. In July, 1855, he returned to Mexico by way of Panama, and landed at Aca-

pulco, where he joined Gen. Alvarez, then commanding the revolutionary troops against Santa Anna. Alvarez was proclaimed president on Oct. 4, and he at once appointed Juarez minister of justice and religion. Immediately after the inauguration of the new administration, Juarez proposed a bill for the abolition of the special clerical and military courts, under which these two classes had long enjoyed immunity from the laws of the nation. The measure received the unanimous sanction of the constituent congress. When Comonfort succeeded Alvarez in the presidency (Dec. 11, 1855), he at once appointed Juarez governor of Oajaca, in order to remove him from the cabinet. Juarez was received with joy in his native state, and his second administration was marked by still more happy results than the first. He was reelected as constitutional governor in September, 1857, at the same time that the general elections resulted in his elevation to the post of president of the supreme court of justice, which in Mexico is equivalent to the vice presidency of the nation. In October Comonfort, in obedience to the voice of the whole liberal press, created him minister of the interior. On the downfall of the Comonfort administration, Juarez repaired to Guanajuato, issued a manifesto, formed a cabinet, and, in virtue of his office of chief justice, was recognized as president by all the states in January, 1858; but, unable to oppose the reactionary forces, he was obliged to transfer his government first to Guadalajara, afterward to Colima, and ultimately by way of the isthmus of Panama and New Orleans to Vera Cruz, where he arrived on May 4. In April, 1859, he was recognized as president by the United States. On Jan. 11, 1861, after having defeated Miramon, he entered the city of Mexico; and in the following March he was confirmed in the presidential functions by a general election, in which Don Miguel Lerdo de Tejada was the opposing candidate. Three important acts of the Juarez administration deserve special mention: the suppression of religious orders, the confiscation of the church property (June, 1861), and the suspension for two years of payments on account of the foreign debt and of all national liabilities. The decree for this last measure, issued by congress, on the recommendation of Juarez, July 17, led to the formation of an alliance of intervention (London, Oct. 31) between England, France, and Spain, and the invasion of the republic by the allied forces, which reached Vera Cruz on Dec. 8. Juarez, however, promised to protect the interests of the creditors, and in consequence England and Spain declined to commence hostilities, and prepared to evacuate the country; but France insisted upon the necessity of active measures, ostensibly for the protection of the French residents, but really for the purpose of establishing an empire in Mexico, and accordingly declared war against Juarez on April 16, 1862. The president, after the capture of Puebla by

Gen. Forey, regarding the defence of the capital as hopeless, abandoned it on May 31, 1863, and established his government at San Luis Potosí (June 10), whence he was compelled to retreat to Monterey, and thence to Chihuahua, arriving at the last city on Oct. 12, 1864. Meantime the archduke Maximilian of Austria had assumed the functions of emperor at the capital. Continued reverses of Juárez's troops rendered it necessary for him to withdraw as far north as El Paso del Norte, where he fixed his government on Aug. 15, 1865. While at this place, his term of office having expired (Nov. 30), Gen. Gonzalez Ortega, in virtue of his position as president of the supreme court of justice, asserted his right to assume the executive power; but Juárez, foreseeing the disastrous effects that a change of government might produce at such a juncture, declared his term of administration extended until peace should be restored and new constitutional elections take place. To avoid the appearance of abandoning the national soil, he frequently refused invitations of the American commander of Fort Bliss to visit him. In June, 1866, his arms obtained a first decided success; and continuing victorious, he left El Paso and steadily advanced southward, tarrying for brief periods at Chihuahua, Durango, Zacatecas, and San Luis Potosí (February, 1867), while the troops under Maximilian were concentrated in the city of Querétaro, after the reëmbarkation for France of the forces under Bazaine. That place was soon invested by the Juárez troops, and Maximilian captured and shot (June 19). On July 16 Juárez reëntered the capital of the republic, and in October he was reëlected constitutional president. The five succeeding years were marked by a series of revolutions, in which the principal actors were Gen. Porfirio Diaz (the unsuccessful candidate against Juárez in 1867) and his partisans. Peace was restored in 1872; and Juárez, who had been reëlected in 1871, seemed likely to enjoy a season of tranquillity; but his constitution, naturally strong, had gradually given way under the trials which beset his stormy administration, and he died of apoplexy.

**JUARROS, Domingo**, a Central American ecclesiastic, died about 1820. He was synodal examiner to the archbishop of Guatemala, and wrote *Compendio de la historia de la ciudad de Guatemala*, in six books (Guatemala, 1800-18). It embraces accounts of Guatemala, San Salvador, Honduras, Nicaragua, and Costa Rica.

**JUBA I.**, king of Numidia, son of Hiempsal (who had been restored to the throne by Pompey), died by his own hand in 46 B. C. Juba succeeded to the throne on the death of his father, and in the conflict between Caesar and Pompey he sided with the latter, both from enmity to Caesar, with whom he had quarrelled on an official visit to Rome during his father's lifetime, and from friendship for the man to whom his father owed his crown. The moment Curio, Caesar's lieutenant, landed in Afri-

ca (49), Juba hastened to the succor of Atius Varus, the commander of Pompey's forces. Varus had already been defeated under the walls of Utica; but on the approach of Juba, Curio retreated and assumed a strong post near the sea. He was drawn from his position by a stratagem, and overthrown, himself being slain, and his army almost cut to pieces. Juba sullied the glory of this victory by cruelty, causing some cohorts of cavalry who had surrendered to be massacred. He enjoyed his kingdom in peace till 46 B. C. when Caesar arrived in Africa to crush the last remnant of the Pompeian faction. Boetba, king of Mauritania, was invited to invade Juba's dominions, and a Roman force was sent to coöperate with him. Juba heard of their inroad on the way to join Scipio, the Pompeian commander, and turned against them, but finally went to Scipio's aid. The rival hosts encountered at Thapsus, and the result proved fatal to the Numidian and his ally. Juba, fleeing from the field, wandered about for a few days as a fugitive, and then in despair killed himself. After his death his kingdom was formed into a Roman province, of which the historian Sallust was the first governor.—His infant son, **JUBA II.**, was taken to Rome and carefully educated, and became a favorite of Octavius, who in 30 B. C. restored him to his father's kingdom, which in 23 was exchanged for Mauritania and a part of Gætulia. He wrote many valuable historical and other works, all of which are lost. He is supposed to have died about A. D. 18.

**JUBBILPORE**, a town of India, in the British territory of Saugor and Nerbudda, at the base of a rocky hill, near the Nerbudda river, 200 m. S. W. of Allahabad, and capital of a district of 6,237 sq. m., with about 500,000 inhabitants. The population of the town is not stated, but it has acquired importance as a station on the East Indian railway. It is a large and flourishing place, with a renowned school of industry, established in 1850 in place of the former college. In the vicinity are many remarkable geological formations, and a number of lakes and tanks, which in the rainy season are so swollen as to make the place inaccessible, and to strengthen its strategical position. A small English force defeated here, Dec. 19, 1817, 5,000 Mahratta troops of the rajah of Nagpore. The town has an English garrison and a political agent subordinate to the authorities of Saugor.

**JUBILEE**, a festive twelvemonth of the ancient Hebrews, celebrated every 50th year, and inaugurated by the blowing of trumpets (*yobel*.) According to the Mosaic law every 7th year as well as every 7th day was observed as a period of rest. To avoid the difficulty of supposing two successive years to be thus observed, some critics have endeavored to prove that the year of jubilee was the 49th instead of the 50th. During this year there was neither sowing nor reaping, all depending alike on the spontaneous products of the earth and

the surplus produce of the preceding years. Bondmen of Hebrew descent became free, and every one resumed possession of his inheritance, howsoever it had been alienated. Unlike the sabbatical year, however, the jubilee did not annul debts. The design of this institution was to check the rise of any great inequality of social condition, and to prevent the rich from oppressing and enslaving the poor or appropriating their lands. It also strengthened the bonds of families, and bound the people to their country, by leading them to cherish an affection for estates derived from their ancestors and to be transmitted to their posterity. The jubilee did not continue to be observed after the Babylonish captivity.—In the middle ages, the term was applied to the year in which all who visited the church of St. Peter at Rome for a certain number of days with pious offerings received plenary indulgence. A jubilee was first declared by Pope Boniface VIII. in 1300, and was to recur in every 100 years. The time was limited by Clement VI., Urban VI., and Paul II. respectively, to 50, 33, and 25 years, and the last period still remains the ordinance of the Roman Catholic church. The condition of visiting Rome is no longer in force, certain works of charity or devotion being substituted.

**JUDEA.** See **JUDEA**.

**JUDAH** (Heb. *Yehudah*), the fourth of the sons of Jacob by Leah. The tribe named after him was the most numerous of the tribes of Israel. On the conquest of Palestine it received all the land bounded by Dan, Benjamin, the Dead sea, Idumæa, Simeon, and the Mediterranean. It became particularly powerful under the dynasty of David, which originated in one of its towns, Bethlehem, and, after the division of the Hebrew state into two kingdoms, the principal member and representative of the southern, named from it the kingdom of Judah. After the destruction of the northern kingdom, Israel, by the Assyrians, Judah became the common name of the Hebrew nation in general, and the name Jews (Heb. *Yehudim*, Lat. *Judæi*) is derived from it. Jerusalem, the capital of the undivided Hebrew state, and afterward of the southern division, was situated on the confines of Judah and Benjamin. The mountain of Judah was a range traversing its centre, and the desert of the same name near its southern boundary.

**JUDAH**, surnamed **HAKKADOSH**, "the Holy," a celebrated rabbi of the 2d century, of the house of Gamaliel, one of his successors as *nasi* (patriarch), and the principal author of the Mishnah. He was a friend of one of the Roman emperors, whom Rapoport, the most competent critic on the subject, identifies with Marcus Aurelius.

**JUDAH**, surnamed **HALLEVI**, "the Levite," a Spanish rabbi of the 12th century, called as an Arabic writer **ABUL HASSAN**. He distinguished himself as a physician, philosophical theologian, and poet, in the last capacity being unsurpassed, if not unequalled, by any post-

Biblical writer in Hebrew. Shortly before the middle of the 12th century he made a pilgrimage to the land of his fathers, a part of which he sings in glowing strains of pious devotion; but before he reached the holy city every trace of him is lost. According to a tradition, he was killed by a Mussulman before entering its gate. His principal work is the *Kuzari* ("The Khazar"), a vindication of the truth and exposition of the principles of Judaism, in fictitious discourses on religion between a king of the Khazars, who was converted to that faith about four centuries before the time of the author, and a rabbi. It was translated from the Arabic into Hebrew by Judah ben Tibbon, into Latin by Buxtorf, and also into Spanish and German. His songs, which among others contain the gems of Hebrew liturgical poetry, have found numerous translators and editors, among the most recent of whom are Luzzato, Sachs, Dukes, and Geiger (*Der Dican des Castiliens Abu'l-Hassan Juda ha-Levi*, Breslau, 1851). His elegy on Zion was translated into German by Mendelssohn.

**JUDAS ISCARIOT**, one of the twelve apostles, and the betrayer of Christ. As to his surname Iscariot (Gr. *Ἰσκαριώτης*), there are many theories; the most probable is, that it is merely the Greek form of writing the Hebrew *ish Kerioth*, "man of Kerioth," a town of Judah. He was the son of Simon, was appointed treasurer of the apostles, covenanted with the chief priests to deliver Jesus up to them for 30 pieces of silver (at the highest computation about \$22, but in comparative value probably equivalent to nearly \$500), accomplished this purpose, repented when he saw his Lord condemned and buffeted, offered to restore the money, confessed that he had betrayed innocent blood, and in despair committed suicide by hanging, according to Matthew, or fell and burst asunder, as related in Acts in the words of Peter. Some interpreters suppose that the motive of his betrayal was to oblige Jesus, in self-defence, to announce himself as the expected king Messiah, to surmount the emergency by his miraculous powers, and to open to himself, the apostles, and the Jewish kingdom the anticipated career of aggrandizement. "The difference," says Archbishop Whately, "between Iscariot and his fellow apostles was, that though they all had the same expectations and conjectures, he dared to act on his conjectures, departing from the plain course of his known duty to follow the calculations of his worldly wisdom and the schemes of his worldly ambition." See Whately's "Discourse on the Treason of Judas Iscariot," in his "Essays on some of the Dangers to Christian Faith" (London, 1839). That he was simply a traitor is the impression generally made by the narrative.

**JUDAS MACCABÆUS.** See **HEBREWS**, vol. viii., p. 592.

**JUDAS TREE.** The tradition that Judas hanged himself upon a species of *cercis* (the oriental name for the tree) has kept his name



attached to the three or four species comprised in the genus. In America the genus is represented by *C. Canadensis*, which also bears the popular name of red-bud; it is a small tree, rarely exceeding 30 ft., found from New York southward and westward, especially on the banks of rivers. When not crowded by other trees it forms a rounded head, and appears at a distance somewhat like an apple tree; the leaves are round heart-shaped, of a bluish green above, with a grayish green on the under surface; the foliage has a remarkably clean and healthy appearance, and is not liable to the attacks of insects. It belongs to the *leguminosae*, in a suborder in which the flowers are not perfectly papilionaceous; the flowers are of a dark peach-blossom color, and are produced before the leaves appear in small umbel-like clusters, not only upon the wood of the previous year, but upon branches that are several years old, and even upon the trunk itself; though individually small, the flowers are in



Judas Tree (*Cercis Canadensis*).

such profusion as to quite cover the tree, which when planted for ornament should be set against a background of evergreens, to show to the best advantage; the fruit is a flattened pod with numerous seeds. The wood is hard and capable of receiving a fine polish. Upon the continent the flowers of the European species are used in salads, and fried in butter as fritters, and the flower buds are pickled in vinegar; it is said that the French settlers in this country make a similar use of the flowers of our species, which have a pleasantly acid taste. This is one of the native trees which have received too little attention from planters, as it is pleasing at all times, and highly ornamental in early spring.—The European Judas tree, *C. siliquastrum*, has less pointed leaves and darker flowers than ours, and is also less hardy. One of the most valuable hardy ornamental shrubs of recent introduction is called in the nurseries *C. Japonica*, but is probably a variety of *C. Chinensis*, and is known as the

Japan Judas tree. It is of slow growth, but blooms profusely when only a foot or two high, and has darker-colored flowers than the others. All the species grow from seeds.

**JIDD**, Sylvester, an American author, born in Westhampton, Mass., July 23, 1813, died in Augusta, Me., Jan. 20, 1853. He graduated at Yale college in 1836, subsequently embraced the Unitarian creed, studied theology at Cambridge, and was ordained pastor of the East parish in Augusta, Me., in 1840. In 1841 he began the work on which his literary reputation chiefly rests, "Margaret, a Tale of the Real and Ideal," &c. (12mo, Boston, 1845), which has been illustrated by a series of outline drawings by Darley (New York, 1856). In 1848 he published "Philo, an Evangelist," a didactic poem in blank verse, and in the same year "Richard Edney," a romance. An old Irish tradition suggested to him a dramatic poem in five acts, "The White Hills, an American Tragedy." A volume entitled "The Church in a Series of Discourses," was published posthumously in 1854; and his "Life," by Mrs. Arethusa Hall, appeared in the same year.

**JUDE** (Gr. 'Ιουδᾶς), Salm, surnamed THADDEUS, or LEBBEUS, one of the apostles, a relative of Jesus, probably a son of Alphaeus and a brother of James the Less. No circumstances of his life are related. According to the traditions of the West, he preached and suffered martyrdom in Persia. According to eastern traditions, he labored in Arabia, Syria, and Palestine, and died in Edessa; or, according to others, visited Assyria also, and died in Phœnicia. He is commemorated in the western church on Oct. 8. The tradition of the church regarded him as the author of the Epistle of Jude, one of the canonical books of the New Testament; but some recent critics believe the apostle Jude Thaddæus to be different from Jude the brother of the Lord and of James the Less, and the latter Jude to have been the author of the epistle. The genuineness of the epistle was disputed as early as the time of Jerome, chiefly because it cites the two apocryphal books of "Enoch" and the "Assumption of Moses." Most critics, however, have maintained it. It is written with vehemence and fervor, seems to have been addressed to converted Jews in Asia Minor and beyond the Euphrates, and contends against Gnostic, Nicolaitan, and other dangerous doctrines. Commentaries on the epistle have been written by Scharling (1841), Rampf (1854), Gardiner (Boston, 1856), Huther (2d ed., 1859), Wiesinger (1862), and Schott (1863).

**JUDEA**, or Judæa, a name variously used in ancient geography to designate the whole of Palestine or the land of the Jews, especially during the period between the Babylonish captivity and the last wars of the Jews; the southern kingdom of the Hebrews, or that of Judah, in contradistinction to that of the ten tribes of Israel; or the southern division of Palestine W. of the Jordan in the time of the

Asmoneans and Romans, between Samaria on the north, the Jordan and the Dead sea on the east, Idumea and the desert on the south, Egypt on the southwest, and the Mediterranean on the west. The limits of Judea in each of these acceptations were continually varying. (See PALESTINE, and HEBREWS.)

**JUDGES, Book of,** one of the historical books of the Old Testament, narrating the deeds of the thirteen judges of Israel from Othniel to Samson. It is a fragmentary rather than a complete and connected history, the fullest accounts being given of Deborah and Barak, Gideon, Jephthah, and Samson. It begins with showing that the calamities suffered by the Hebrews after the death of Joshua were due to their apostasy from Jehovah. It is supposed by many that the first 16 and the remaining 5 chapters are by different authors. The first portion, believed by some to have been written before the time of David, is ascribed to Samuel. Most German critics, however, believe the book to have been compiled on the basis of ancient documents at a late period. According to Bertheau (Schenkel's *Bibelleicon*, art. *Richter*, Leipsic, 1873), the compiler was Ezra. The same writer also regards it as probable that the book of Ruth originally formed a portion of the book of Judges. Among the most important commentators on the book are Le Clerc, Rosenmüller, Maurer, Studer, Bush, Bertheau, Keil (1863), and Bachmann (1868).

**JUDGES OF ISRAEL.** See HEBREWS.

**JUDGMENT,** in law, a solemn determination of a question, declared by a court of record. The language used in a judgment is, that "it is considered by the court," &c., the theory being that the function of the court is not to give its own decision, but to ascertain and pronounce the decision of the law. To give validity and full force to a judgment, the court which renders it must have competent jurisdiction over the case; that is, it must be authorized by law to entertain and determine the question which it decides, and the parties, or, in case of proceedings *in rem*, the subject matter of the suit must, by process or some substitute therefor, have been brought within the authority of the court. When these circumstances concur, merely irregular action of the court or its officers will not invalidate its judgments. A judgment may be arrested and avoided, if, within the time prescribed by the rules of the court, it can be shown that there are intrinsic defects appearing of record, which are of sufficient importance. For, the judgment being founded upon the record, it cannot stand if the party against whom it is rendered can show that the record is inconsistent with it or insufficient for it. The more common instances of this are where there is an irreconcilable contrariety between parts of the record; as, for example, where the judgment is founded upon a verdict which is essentially different from the pleadings at issue.—Judgments are of many kinds, for the reason that they must conform to the

pleadings and issue. They are usually classed as judgments upon demurrer, on a verdict, on confession, on default, or on nonsuit. (See PLEADING.) A judgment is also interlocutory or final; and the best definition of an interlocutory judgment is to say that it is any judgment which is not final, or which does not entirely dispose of the whole question. A judgment that is final and valid is the highest assurance known to the law. Such judgments were formerly extensively used in England to operate as conveyances of land; the party to whom the land was to be transferred commencing an action for it against the party who was to transfer it, and this being concluded by a judgment that the land in question belongs to the plaintiff.—From the high and solemn nature of a judgment, the doctrine of merger was applied to it. If one sues another on his promise, or indebtedness of any kind, or for wrong of any kind, and recovers judgment, it is a technical rule of law that the original cause of action merges or is lost in the judgment. So, too, it was formerly thought to be well established that if one brought an action against another for depriving him unlawfully of his property, and recovered a judgment for damages, this judgment vested in the defendant a right or title to the property, although the damages were never paid nor the judgment satisfied in any way. There are writers who hold, however, that the title does not pass until execution is taken out, and still others of high authority that satisfaction of the judgment is essential; and this, perhaps, is the better doctrine.—There is no doubt whatever that a judgment of a court of record may be made the foundation of a suit. If it be the judgment of a competent court in the same state, it proves itself; and no defence can be made which does not distinctly impeach it for fraud, or for want of jurisdiction. If it be the judgment of a court of another of the United States, it falls within that clause in the federal constitution which provides that "full faith and credit shall be given in each state to the public acts, records, and judicial proceedings in every other state," and authorizes congress to provide the manner in which they shall be proved. Congress, by an act passed May 26, 1790, made this provision. Under this it is held that a judgment has the same conclusive nature in another state that it has in the state in which it was rendered. The question how far a foreign judgment, *proprio vigore*, has force and validity, has been discussed in many cases, with some diversity in the conclusions. On one extreme stand those who would make it a mere *prima facie* evidence, open to rebuttal by any evidence tending to show that it ought not to have been rendered. Where this doctrine is held, it is plain that the whole case may be tried over again in the action on the judgment, with the burden of proof on the party who would set it aside. Against this are those who hold the opposite extreme, that a foreign judg-

ment is as conclusive as a home judgment. The law on this subject both in the United States and in England may now be considered as resting on a medium ground. First, it is certain that no sovereign state is bound to execute a judgment or decree of any foreign state. Next, a foreign judgment is valid and conclusive, provided: 1, that the court rendering the judgment had full jurisdiction of the case; 2, that the case was properly brought before that court and properly tried; 3, that there is nothing in the unquestionable law of the case which forbids or contradicts the judgment; and 4, that it was not obtained by fraud, deception, or oppression. The civilians of the continent of Europe generally maintain the absolute validity of a foreign judgment. But the courts of France have never yet recognized the validity of a foreign judgment, to the extent to which this is now admitted in England and the United States; although the recent adjudications of that country indicate a much nearer approach than formerly to what may be called the English view of "the comity of nations" in this respect.—Not only may a judgment be made the foundation of a suit, but a former judgment may be relied upon as a defence against a suit which would raise the same question anew. This ancient and important rule is never denied in its general form; and it rests upon the obvious principle that there must be, at some time and by some means, an end of litigation. Therefore, if a question be once tried by a proper tribunal, and in a proper way, and solemnly decided, it is decided for all time, and cannot again be brought up for consideration. In other words, a judgment rendered is conclusive upon the merits of a question; and this rule is now applied, with the qualifications above stated, to a foreign judgment.—For the lien on the real estate of the judgment debtor created by the judgment, see LIEN.

**JUDENBACH**, a village of Saxe-Meiningen, Germany, on the S. E. ridge of the Thuringian Forest, near the former boundary line of Thuringia and Franconia, and formerly celebrated as a great focus of trade between N. and S. Germany and of Nuremberg and Augsburg merchants. Luther was here in 1530, and the tavern (*Wirthshaus zur Rast*) where he resided, a decayed old building, was about to be sold and pulled down in 1873, when it was purchased by Mr. Fleischmann, a merchant of the neighboring town of Sonnenberg, who put it up in 1874 on the Schönberg, in the same condition in which it was when Luther inhabited it.

**JUDITH**, daughter of Merari of the tribe of Reuben, widow of Manasseh, celebrated for her deliverance of her native city Bethulia when besieged by the Assyrian general Holofernes. Mourning the death of her husband during the siege of the town, and noted for her beauty, she went forth in rich attire to the camp of the enemy, played a treacherous part,

attracted Holofernes by her charms, and on the third day, when she was alone with him in his tent, and he was intoxicated, struck off his head with a falchion, and bore it into Bethulia. In the morning the Israelites attacked and discomfited the Assyrians, who were panic-struck at the loss of their general. She lived to the age of 105 years, and the Jews are said to have instituted an annual festival in honor of the victory. The history is contained in the apocryphal book of the Old Testament which bears her name. Calmet supposed the narrative to be a parable and not a real history, an opinion which is now generally shared by critics. According to Hilgenfeld, Lipsius, and others, the events described in the book took place in the time of the Maccabees; and by Nebuchadnezzar we must understand Antiochus Epiphanes, and by Holofernes Nicanor. They suppose the book to have been written about 144 B. C. According to Volkmar, Hitzig, and others, it was not composed until about A. D. 118, and the principal persons described in it are the emperor Trajan and his general Lusius Quietus. The book appears to have been originally written in Hebrew, and the Greek translation to have been the source from which the somewhat different Latin version was derived.

**JUDITH**, Mlle. (JULIE BEKENT), a French actress of Jewish parentage, born in Paris, Jan. 29, 1827. She is a remote relation of Rachel Félix, and made her first appearance on the stage in 1842. From 1844 to 1846 she played at the Variétés theatre, her oriental beauty and fine voice contributing to her success, and subsequently at the Théâtre Français, of the society of which she became a member in 1862. In 1859 she married M. Bernard-Derosne, whom she assisted in translations from the English. She afterward left the Théâtre Français and performed at the Galeté and other theatres. She excels as Charlotte Corday and as Rosine in the *Barbier de Séville*, and unites tragical power with sprightliness.

**JUDSON**, I. Adairam, an American missionary, born in Malden, Mass., Aug. 9, 1768, died at sea, April 12, 1850. He was the son of the Rev. Adoniram Judson, a Congregational clergyman, and descended from William Judson, who came to New England in 1634. He graduated at Brown university in 1807, opened a private school in Plymouth, Mass., and published "Elements of English Grammar" (1808) and "Young Ladies' Arithmetic" (1809). His previously skeptical views having yielded to an examination of the evidences of Christianity, he entered the second class at Andover theological seminary, not as a candidate for the ministry, but as an inquirer after truth, and completed the course in 1816. The reading in 1809 of Dr. Buchanan's celebrated sermon entitled "The Star in the East" led him to devote himself to the missionary enterprise. Several of his fellow students concurred in his views, and a formal application

el and encouragement, addressed by Judson, jr., Samuel Nott, jr., Sam-  
 a, and Samuel Newell, to the general  
 ional association of Massachusetts,  
 e incipient step toward the forma-  
 e American board of commissioners  
 n missions. Impatient at the slow  
 of the American movement, he em-  
 r England, under invitation, to con-  
 the directors of the London mis-  
 ciety in regard to the practicability of  
 n with that society by the newly  
 erican board. The vessel in which  
 ed was captured by a French priva-  
 the young missionary soon found  
 a prison in Bayonne. Released on  
 reembarked for England, where he  
 May, 1811, and was offered for him-  
 is associates appointments and sup-  
 the London society, but the plan of  
 n was declined as unadvisable. He  
 o New York in August, and in Sep-  
 a present at the meeting of the  
 board at Worcester. Here his elo-  
 ortunity, united with that of one of  
 ues, triumphed over the continued  
 to delay, and Judson, Newell, and  
 h Gordon Hall, were appointed by  
 its missionaries to the Burman em-  
 her Rice was subsequently added to  
 ber, and the five young men were  
 at Salem, Feb. 6, 1812. Mr. Judson's  
 with Miss Ann Hasseltine had oc-  
 e day previous to his ordination, and  
 th of the same month they, with  
 nd Harriet Newell, embarked from  
 e Calcutta. At this place, and at  
 ey were subjected for a full year to  
 oyance by the East India company's  
 s. Finally they found refuge in  
 angoon, in the Burman empire, the  
 heir original destination, where they  
 1 July, 1813. Meanwhile Mr. and  
 on had adopted the views of the Bap-  
 tination, and having been baptized  
 arey, English Baptist missionary at  
 e, had surrendered their connection  
 American board. Mr. Rice, arriving  
 a by another vessel, had on his voyage  
 imilar studies with similar results,  
 eturned to America to enlist the Bap-  
 tie United States in the support of  
 issions. In April, 1814, the Baptist  
 nvention, called since 1845 the Ame-  
 tist missionary union, was formed at  
 ia, and immediately appointed Mr.  
 Judson its missionaries. Established  
 n, the field left to them by the clo-  
 e English Baptist mission, they ap-  
 selves with great zeal to the acquisi-  
 e language, without grammar or dic-  
 e teachers who could speak English.  
 on first attained the power to con-  
 e Judson's habits of thorough philo-  
 niry rendered his progress less rapid,  
 his mastery of the language equal to

that of native scholars. In three or four years  
 he published a "Summary of the Christian  
 Religion," a catechism, and a translation of the  
 Gospel of Matthew. In March, 1817, an in-  
 telligent Burman, accompanied by his servant,  
 presented himself to Mr. Judson as an inquirer;  
 in April, 1819, the first *sayat* (an edifice which  
 is both a caravansary and a place for public  
 meetings) was opened for Christian worship;  
 and on June 27 in the same year the first na-  
 tive convert was baptized. At the close of the  
 year 1820 the number of baptized converts  
 was 10. Meanwhile the mission had been re-  
 enforced by the arrival of additional mis-  
 sionaries, and the impression which it was making  
 had in 1819 excited the displeasure of the new  
 viceroy. Mr. Judson determined to appeal to  
 the king for toleration, and, with his colleague  
 Mr. Colman, ascended the Irrawaddy to Ava  
 for that purpose. He was admitted to an au-  
 dience, but the plea was unavailing. Believing  
 that they had made a mistake in appealing to  
 the king, and fearing that this measure would  
 bring upon the converts the vengeance of the  
 government, they had well nigh formed the  
 purpose of removing to a safer place in Ara-  
 can, but were deterred by the steadfast cour-  
 age of the native Christians. In 1821 the con-  
 tinued ill health of Mrs. Judson compelled her  
 to return for a time to the United States,  
 where, after a short stay in England, she  
 arrived in September, 1822. While in this  
 country she published her "History of the  
 Burman Mission," and by her presence and her  
 personal appeals contributed largely to increase  
 the missionary zeal of the American churches.  
 In the spring of 1823, with her health but  
 partially restored, she reembarked for Calcutta,  
 accompanied by Mr. and Mrs. Wade as recruits  
 to the mission, and rejoined her husband at  
 Rangoon in the autumn of the same year.  
 During her absence the number of converts  
 had been nearly doubled, and Mr. (now Dr.)  
 Judson had completed a translation of the New  
 Testament, as well as an epitome of the Old.  
 Their residence had been transferred to Ava  
 by request of the king, who was anxious to  
 command the medical services of Dr. Price, a  
 missionary physician who was colleague with  
 Dr. Judson. The sudden breaking out of war  
 however between the East India company and  
 the Burman government brought upon the  
 missionaries, and other foreign residents at  
 Ava, the severest privations, perils, and suffer-  
 ings. For nearly two years no tidings came of  
 the fate of the missionaries. Three Englishmen  
 residing at Ava having been arrested by the na-  
 tive authorities and examined, it was found that  
 the accounts of one of them showed considera-  
 ble sums of money paid to Drs. Judson and Price,  
 and, ignorant of the methods of transmitting  
 funds by bills of exchange, the government  
 saw in this fact proof of their complicity with  
 the English in the war. On June 8 Dr. Jud-  
 son was arrested at his dwelling by a posse of  
 officers, thrown into the "death prison" with

all the other white foreigners, and loaded with chains. Mrs. Judson was kept a prisoner in her own house, under the guard of ten ruffianly men; but on the third day a message to the governor of the city, expressing a desire to appear before him with a present, resulted in an order for her release. Further gifts secured the promise of an amelioration of her husband's sufferings, and permission to visit him in prison; and by the same means all the prisoners were delivered from their suffocating confinement, and placed in an open shed within the prison enclosure. Hither she sent food and mats for them all, commencing those angelic ministries to the sufferers which have rendered her name immortal. Seven months thus passed away, during which she employed her time in devising and executing measures for the comfort of the prisoners, and especially for the release of her husband, scarcely a day passing in which she did not visit some member of the government, or some branch of the royal family; with no other effect, however, than that she and the objects of her solicitude were kept from despair by the encouraging promises of a capricious court. New miseries were still in store. The hot season had arrived, and the sufferings of the prisoners had become intolerable. The birth of a child suspended for a brief period these ministries of Mrs. Judson. Twenty days after this event she was again at the prison, and again in the presence of the governor pleading for ameliorations. Returning to the prison from an interview which the governor had requested, she found the white prisoners all removed. She learned from an old woman that they had gone toward Amarapura, the old capital, distant six miles. She obtained a passport, and set off for Amarapura, where she learned that the prisoners had just left for Oungponla. Here she found them, chained two and two, and almost dead from fatigue and suffering. They spent the next six months at this place, subjected to continual oppression and extortion. The king was at length forced to ask conditions of peace of the British, and in February, 1826, Mr. and Mrs. Judson were released through the demand of Gen. Sir Archibald Campbell. Descending the river to the territories ceded by the Burman government to the English, they commenced missionary operations at Amherst, a new town designed to be the British capital. Scarcely, however, were they fixed in this abode, when urgent overtures were made to Dr. Judson to accompany an embassy to Ava, to negotiate a new treaty. In the hope that an article providing for religious toleration might be incorporated, he yielded to the wishes of the commissioner, and parted with Mrs. Judson on July 5, never to see her more. Her constitution, broken by the intense sufferings and cares of the long imprisonment, yielded to an attack of fever, and she died after 18 days' illness. Returning to Amherst, Dr. Judson applied himself with diligence to missionary labors. The number

of native converts was increased, many missionaries arrived, and new branches of the mission were established, that among the Karens starting at once into importance among the most successful of modern times. Dr. Judson was chiefly employed in the translation and revision of the Scriptures, and in the preparation of a Burmese-English dictionary. In January, 1834, he completed the translation of the Bible. In April of the same year he married Mrs. Sarah H. Boardman, widow of a missionary, the Rev. George Dana Boardman. For eleven years he continued his missionary labors, to a large degree Biblical and theological, till 1845, when the failing health of his wife compelled a voyage to the United States. Mrs. Judson died in the harbor of Helena, Sept. 1, and was buried on that day. Dr. Judson arrived at Boston, Oct. 15. The emotion excited by his return spread over the whole country, and was shared by every denomination of Christians. He was received with distinguished marks of respect and veneration by public meetings in many cities and towns of the United States, and especially by his Baptist brethren assembled in missionary conventions at New York and Richmond. On July 11, 1846, he returned for Burmah, having married Miss Emily C. Buck. Arriving at Maulmain in December, he resumed his work with ardor, assuming the pastoralship of the Burman church, and carrying forward the dictionary on which he had been so long engaged. In the autumn of 1846 a severe cold, followed by a fever, withdrew him from his work. His disease refused to yield to remedies, and on April 3, 1850, he died, his wife in a state of health which forbade her accompanying him, and departed with a single attendant for the isle of Bourbon. He suffered much while descending the river, but remained for a time on the open sea. On April 13 he sank quietly to rest, and was buried in the ocean. The Burmese and English dictionary on which he was engaged at the time of his death, was compiled from his papers by A. Stevens and printed at Maulmain in 1850.—A memoir of his life was written by Rev. Francis Wayland, D. D. (2 vols. 12mo, Boston, 1858). See also a memoir by J. C. Kent (12mo, Auburn, N. Y., 1852); "Recollections of his Life, Character, and Achievements," by the Rev. D. T. Middleditch (12mo, New York, 1854); and "The Earnest Man: a Sketch of the Character and Labors of the Rev. Ananias Judson," by Mrs. H. C. Conant (Boston, 1856). II. Ann Hasseltine, first wife of the preceding, daughter of John and Robert Hasseltine, born in Bradford, Mass., Dec. 17, 1789, died at Amherst, Burmah, Oct. 24, 1846. She was educated at the academy of her native town. Her mind was well disciplined, and her acquisitions were unusually large. Mr. Judson's acquaintance with her commenced in 1810, and resulted in an invitation to share with him the responsibilities and perils of a

ry life. They were married at Bradford, N. H., 1812, and on Feb. 19 embarked for Calcutta. Her subsequent history will be found in connection with that of her husband. A fair air of her life was written by the Rev. S. D. Knowles (2d ed., Boston, 1829; times reprinted). III. Sarah Hall (Boardman), second wife of Adoniram Judson, born at Westford, N. H., Nov. 4, 1803, died at the island of St. Helena, Sept. 1, 1845. She was the eldest child of Ralph and Abiah Hall. When she was a child her parents removed to Danvers, Mass., and then to Salem. On July 4, 1825, she became the wife of the Rev. George Dana Boardman, and on July 16 embarked for Calcutta, arriving there on Oct. 15. The Burman war still raging, Mr. Boardman accepted temporarily an invitation to preach at the Circular Road Baptist church in Calcutta. Here they remained till the month of Aug. 1827, when they embarked for Burmah, where arrangements were made for their settlement by Mr. Boardman of the mission station at Maulmain, which subsequently became the chief seat of Baptist missions at country. Here Mrs. Boardman made progress in the acquisition of the language, and availed herself of every opportunity of method in her benevolent work. This progress being fairly established, Mr. and Mrs. Boardman were transferred to Tavoy for a missionary service, where was commenced the valuable work of the propagation of the Gospel among the Karens, the inhabitants of the interior jungles. In two years Mr. Boardman died. His widow continued her missionary labors, and besides managing a school with great success, and giving religious instruction in various ways at Tavoy, she was accustomed to make long and toilsome journeys up the mountains. In these excursions, multitudes of hundreds gathered around her, notwithstanding her reluctance to assume seemed like the office of a public teacher, as obliged to conduct their worship, and direct them more perfectly in the Christian

life. In April, 1834, she became the wife of the Rev. Adoniram Judson. Her subsequent life was less eventful; it was filled with steady, quiet usefulness.

She was perfectly familiar with the Burmese language, and skilful in the use of it. She translated into it the first part of Bunyan's *Pilgrim's Progress*, and various tracts, prepared a hymn book, several volumes of Scripture questions for Sunday schools, and, as one of her last works of her life, a series of Sunday school lessons. Before the Peguans had a missionary, she acquired their language, and translated or intended the translation of the New Testament and the principal Burman tracts into Peguan tongue. In these useful labors she continued till 1845, when her shattered health prevented her to attempt a voyage to America in the hope of its restoration, but she sank before its completion. A memoir of her life was written by Mrs. Emily C. Judson (18mo,

New York, 1850). IV. Emily Chubbuck, third wife of Adoniram Judson, born in Eaton, Madison co., N. Y., Aug. 22, 1817, died June 1, 1854. Though her opportunities of early culture were extremely limited, she made much progress in learning. At the age of 14 she took charge of a district school, and continued teaching, with very brief intervals, until the age of 28, contributing in the mean time a number of pieces in prose and poetry to the village newspapers. In 1840 she entered the Utica female seminary as a pupil, but was soon transferred to the office of teacher. She began her career of formal authorship by writing several Sunday school books ("Charles Linn," "Allen Lucas," &c.), which, however, yielded little pecuniary remuneration. Charged with the support of her aged parents, she turned to other sources, and in 1844 addressed a playful letter, under the assumed name of Fanny Forester, to Messrs. Morris and Willis, editors of the New York "Evening Mirror," proposing contributions to that journal. She soon after became a regular contributor to several periodicals, and a brilliant literary career was opening before her, when a new direction was given to her destiny by her marriage with the Rev. Dr. Judson, in June, 1846, and their departure for India in July following. She remained in Burmah until January, 1851, when, learning the death of her husband, she returned to America. While in Rangoon she wrote the memoir of Mrs. Sarah B. Judson, and in Maulmain composed some of her best poems connected with her personal history. She returned with a broken constitution, but devoted herself to the care of her children and of her aged parents, and to her literary labors. She prepared and arranged the papers for Dr. Wayland's life of Dr. Judson, and collected her poems, which were published under the title of "Olio of Domestic Verses." Her other works are "The Kathayan Slave," a collection of missionary writings in prose and verse, and "My Two Sisters." Her magazine tales and sketches had been collected and published before she left America, under the title of "Alderbrook." A memoir of her life was written by Dr. A. C. Kendrick (12mo, New York, 1858). The "Lives of the Three Mrs. Judson," by Mrs. A. M. Wilson, was published in New York in 1851-'5.

JUEL, Niels, a Danish admiral, born May 8, 1629, died in Copenhagen, April 8, 1697. He served under Martin van Tromp and De Ruyter, and became captain of a Dutch frigate, and subsequently commander of a Danish squadron, with which he cooperated in defending Copenhagen in 1659 against the Swedish fleet. In 1676 he captured the island of Gothland, and repulsed (June 4), with 25 ships, a Swedish force twice as large; and he soon afterward achieved another victory over the Swedes in conjunction with Cornelius van Tromp. In 1677 he was still more successful in overwhelming two separate Swedish squadrons, capturing a great number of ships, for which he subse-

quently received the rank of grand admiral lieutenant, the order of the Elephant, and the island of Taasing. He failed in an attempt to take Calmar, but took Rügen in 1678.—His brother JOHANN, Baron Julinge (died 1700), shared in many of these victories, and was one of the negotiators of the peace of Lund (1679).

**JUGGERNAUT**, or *Jagannath* (called by the natives *Pooree*), a town of Bengal, India, on the N. W. coast of the bay of Bengal, in the province of Orissa, and in the district and 45 m. S. of the city of Cuttack; pop. about 30,000. The ground on which it stands is esteemed holy, and is held free of rent on condition of performing certain services in and about the temple. The principal street is composed chiefly of religious establishments called *maths*, which consist of stone buildings with low-pillared verandas in front and shaded by trees. At the end of this street, which is very wide, rises the celebrated temple. In the vicinity of the town are luxuriant groves and gardens, and many fine tanks of great antiquity. Between the S. W. side of the town and the sea are numerous ancient edifices nearly buried in the drifting sand. Juggernaut is the most holy of the shrines of Hindostan, and is visited annually by upward of 1,000,000 pilgrims. The temple stands within a square enclosure, surrounded by a lofty stone wall, each side of which measures 650 ft., making an area of about 10 acres. On the E. side is a grand gate-

way from which a broad flight of steps leads to a terrace 20 ft. high, enclosed by a second wall, each side of which measures 445 ft. From this terrace the great pagoda rises, from a base of 30 ft. square, to the height of 200 ft. above the ground. It tapers from bottom to top, and is rounded off in the upper part. Most of the Hindoo deities have temples within the enclosure. The great temple is dedicated to Krishna, considered as an avatar or incarnation of Vishnu, and derives its name from his title Juggernaut (properly *Jagannātha*, "the lord of the world"). Siva and Subhadra are the next principal objects of adoration, and these three deities are respectively represented by three frightful-looking idols made of blocks of wood about 6 ft. high, each surmounted by a grim

representation of the human countenance. The block representing Krishna is painted dark blue, while Siva's image is white, and Subhadra's yellow. Each idol is provided with a chariot, which is a lofty platform mounted on wheels. That of Juggernaut or Krishna is the largest, 48½ ft. high, 84½ ft. square, and is mounted on 16 wheels, each 6½ ft. in diameter. The *Bath Jatra*, or great festival of Juggernaut, occurs in March when the moon is of a certain age, and the idols are then taken on their chariots to visit their country house, about 1½ m. from the temple. The chariots are drawn by long ropes held by enthusiastic thousands of men, women, and children, while priests standing on the platforms sing and repeat obscene stories, accompanied by corresponding gestures, and



The Principal Gateway of the Temple of Juggernaut.

the applauses of the multitude. In former years some of the votaries were occasionally sacrificed by falling accidentally or by design before the chariot wheels, and being crushed to death by the ponderous rolling vehicle; but latterly there have been no occurrences of this sort. The temple of Juggernaut is of considerable antiquity. The present building is supposed to have been completed in 1198, at a cost of more than \$2,000,000. The British obtained possession of the town in 1803. Its former masters, the Mahrattas, had levied a tax upon the pilgrims resorting thither, and out of the large sum thus raised granted a small allowance to defray the expenses of the temple. The British continued this tax and the provision for the maintenance of the temple till 1839, when

the tax was abolished and an annual donation from the public treasury given to the priests. In consequence of the scandal created by the spectacle of a Christian government contributing to support the most obscene rites of heathen worship, this donation was suspended about 1855, and the temple now depends on a pilgrim tax collected by the native authorities.

**JUGGLER**, one who practises or exhibits tricks by sleight of hand, or who makes sport by tricks of extraordinary and deceptive dexterity. The further we go back in history, the more do we find the juggler assuming the character of the thaumaturgist or worker of serious marvels; and in the 16th century men were burned alive in Spain and Italy for performances which now excite but little wonder. In the earliest times, when knowledge and science were devoted to strengthening heathen religion, juggling was a real power, and formed the most efficient means of sustaining the dignity of the priesthood. The hierarchy of India and Egypt carried thaumaturgy to an incredible extent, and it is by no means impossible that a great proportion of the marvels ascribed by legend to magicians were actually or apparently performed. The investigations of Salvete have shown in what manner most of these could have been done, and with what effect, especially in the depths of temples, before witnesses filled with awe and devoid of doubt. Thus Iamblichus (*De Mysteriis*, cap. 29) and Porphyry speak of those who showed the apparitions of gods in the air; a trick explained by Robertson ("Memoirs," vol. i., p. 354) to be of easy performance. The wonder-worker Maximus probably used a similar secret when, on burning incense before a statue of Hecate, the goddess was seen to laugh so plainly as to fill all present with horror. Ordinary jugglers at the present day show the face of another person to those looking in a mirror; a trick also used by fortune tellers to exhibit future husbands to superstitious girls. This, which is done by a very simple optical contrivance sold in many shops, perfectly explains the manner in which the Agrippas and Fausts of the middle ages, as well as the earlier magicians, showed those who were supposed to be absent, or the forms of the departed, as Cleonice appeared to Pausanias. Juggling, properly regarded, is a science, the principal of whose divisions is that of sleight of hand or substitution. The commonest tricks performed by these means have been known to all cultivated races. The tossing of knives and balls, the marvellous balancer, the producer of unexpected objects from strange receptacles, occur in Saxon manuscripts and on the walls of Egyptian and Etruscan tombs; they amazed the Norseman and the Roman; and when the troubadour degenerated to a vagabond, he became a *jongleur* (Lat. *joculator*), whence the word juggler. The tying and untying of intricate knots, which has even in these days been attributed to supernatural agency, yet which is shown by every

juggler, leads us back to the Scottish warlock whom no bonds could hold, and to the symbolic mazes of Runic and Gordian ties. Not many years ago London was amazed at a man who could tell one person in secret what card it was that another thought of. Lord Bacon (*Sylva Sylvarum*, cent. ix., 946) tells of one that "did first whisper the Man in the Eare, that such a Man shoulde think such a Card." Those who have seen glasses or chains broken, and handkerchiefs apparently torn to pieces, and then restored to the owners, may be amused to know that a learned writer of the 16th century, Fromann (*Tractatus de Fascinatione*, p. 588), really believed that this was done by magic, though he tells us in the same book that in his time many common jugglers (*conculatores aut sacularii*) were often mistaken for magicians. Modern wizards simply amuse by showing us eggs or other objects which dance and follow the motion of the hand, an invisible silk thread or hair being the medium used; but of old the king of Babylon stood at the parting of the ways and used divination with arrows which leaped up and pointed the way he was to go, as they did in after times for the Arabs (Koran, v. 99); and for the Tartar Genghis Khan the same trick was used. Reginald Scot, in his "Discoverie of Witchcraft," explains how the head of a man may come through a table, upon a plate, and being duly whitened like a corpse may astonish the world by talking; an account which throws much light on the talking heads of Arabic, Greek, Hebrew, Norse, and mediæval fable. Down to the present century ventriloquism was regarded as a physiological mystery, and of old it seemed awful when the river Nessus saluted Pythagoras, when a tree spoke before Apollonius, and when a new-born infant, or animals, or statues talked. Every modern juggler allows himself to be shot at; the first European, Laing, who went among the Sulimas, near the source of the Joliba, saw a native chief perform the same trick on a grand scale and in a curious manner, the muskets always flashing in the pan when aimed at him, but shooting well when turned, however unexpectedly, to other objects. In all ages, and especially in the East, wizards have stuck arrows and swords through their own limbs, and driven nails through their hands; but when in 1859 a so-called "India-rubber man" attempted to astonish by similar feats, his secret was quickly exposed in the newspapers. Ancient jugglers performed extraordinary feats by mechanism, which is defined by Cassiodorus (*Varia* lib. i., c. 45) as "the science of constructing machines whose effects shall seem to reverse the order of nature." In those days the floors of temples heaved like waves, doors widened of themselves to admit portly visitors, tripods advanced to salute them, statues wept, nodded, and bled; all which marvels are imitated by modern jugglers. In the 17th century, by acoustics, invisible sprites called *tramarces* rapped audibly on any object indicated; in the



19th, Haller, Blitz, and others summon them again. The abbé Mical and Maelzel in modern times astonished the world with *androïdes*, little speaking figures; the Egyptian priests made gods and statues which prophesied and explained dreams. Stone statues of the gods which rang like a bell when struck (Pausanias, "Attica," c. 42) are still found in China as the jade-stone images of Buddha. In optics, the Chinese jugglers show a clear metallic mirror which, when it reflects sunshine on a wall, exhibits in the circle of light an inscription; the secret of which was accidentally discovered several years ago in Paris by seeing a letter stamped in the back of a daguerrotype plate reflected in like manner, though not visible on the reflecting surface. The magic lantern fully explains the images of the gods shown in the water by ancient wizards, and the devils seen by Benvenuto Cellini in the Colosseum. In hydrostatics, the bottle yielding all kinds of wine, which has often appeared in romance, as on the table of Faust, has been realized by many wizards of the present day. Many tricks performed by modern eastern jugglers have however never been fairly explained. Their placing a boy in a basket on the ground and stabbing through it, causing blood to flow and the boy to vanish and reappear, is one of these; so too is their curious trick of making trees grow visibly in a few minutes. Something like this was shown by a Neapolitan, who professed to make lettuce seed sprout by electricity, and who thereby long puzzled the scientific world. In modern Egypt (Lane, "Manners and Customs of the Modern Egyptians," vol. ii.) a naked juggler is tied up in an empty bag, and comes out bringing with him plates of food and lighted candles. The Indian and Japanese jugglers are also exceedingly skilful.—Common jugglers are said to have originated in Egypt, and thence made their appearance in Greece; in Rome they were termed *præstigiatores*, *pillarii* (bull players), *ventilatores* (tossers), and *saccularii*, "those who tricked with bags and into pockets." The real Faust of the middle ages was a common juggler, and much below the dignity of black-art scholars like Agrippa and Paracelsus. Of his class was the Bohemian Zito. Among the most remarkable jugglers of modern times have been Pinetti, Eckartshausen, Philadelphia, and the famed Katterfelto. More recently we have had Bartolommeo, Bosco of Turin, Döbler, Prof. Anderson, Heller, Houdin, and Hermann. Most eminent of these was the Frenchman Robert Houdin, who applied to his art both genius and science. His memoirs were published in Paris in 1859. For other works on the subject, see Reginald Scot, "Discovery of Witchcraft" (1584); the works of Wiegand, Halle, Funk, and Eckartshausen; Sir David Brewster, "Letters on Natural Magic" (London, 1831); and Esèbe Salverte, *Des sciences occultes* (2 vols., Paris, 1829).

**JUGURTHA**, a Numidian king, born before the middle of the 2d century B. C., died in Rome

in 104. He was the illegitimate son of Mastanabal, youngest son of Masinissa, king of Numidia. Micipsa, his paternal uncle, on succeeding to the throne, adopted him, and had him brought up with his own sons, Hiempsal and Adherbal. Jugurtha's superior abilities and skill in all martial exercises soon excited the jealousy of Micipsa, who, to remove him out of the way, sent him in 134 with an auxiliary force to aid Scipio in the Numantine war. Jugurtha's courage and capacity won him the friendship of the Roman commander and officers. On the conclusion of the war he returned to Numidia, and was received with ceremonious respect by Micipsa, who, to purchase his forbearance, made him at his death (118) heir to the kingdom in common with his two sons. The three princes quarrelled on their first meeting after his death, and a little later Hiempsal was assassinated by Jugurtha. Adherbal and his party took up arms, but were defeated, when he fled for refuge to Rome, and submitted his case to the senate, which, despite the intrigues and bribes of Jugurtha, sent commissioners to Africa to divide Numidia between the rivals. The commissioners took gifts from Jugurtha, and gave him the larger and better half of the kingdom. But he was not satisfied, and after trying in vain to provoke Adherbal to declare war, he invaded his territory, and compelled him to take refuge in Cirta, where on his surrender in 112 he massacred him and all his followers. The conduct of Jugurtha now excited loud indignation at Rome, and an army was despatched to Africa to depose him. But the Roman commander and legate suffered Jugurtha to purchase peace on terms which involved no greater sacrifice on his part than 30 elephants and an inconsiderable sum of money. This shameful transaction so weakened the confidence of the Roman people in the patricians, that the prætor Cassius was sent to Numidia to guarantee to Jugurtha a safe-conduct if he would go to Rome and give evidence against the general. The king consented, proceeded to Rome, and appeared in the *comitia*; but a tribune in the interest of the generals forbade him to testify, and the attempt to convict the corrupt officers proved a failure. Jugurtha remained at Rome for some time, intriguing and adding to his influence among the aristocracy. Having however procured the assassination of Masiva, a Numidian prince, who since the death of Adherbal had been a competitor for that kingdom, he was ordered to quit Italy. It was while leaving Rome on this occasion that he uttered the memorable exclamation, which indicates how the Romans had fallen from their ancient integrity: "Behold a city for sale, could she but find a purchaser." The war was now renewed, and a division of the army of Spurius Albinus, under the command of his brother Aulus, was surprised by Jugurtha in its camp, the greater part cut to pieces, and the survivors compelled to pass under the yoke. This dis-

stirred up the Roman spirit, a new army raised, and Q. Cæcilius Metellus was sent to succeed Albinus. Metellus was at once a general and an honest man. After the campaign Jugurtha was willing to purchase peace on any conditions short of surrendering himself a prisoner of war. But Metellus was ambitious not only of terminating the war but of adorning his triumph with the spoils, and the contest was renewed. Jugurtha avoided a general engagement, and Metellus discontinued offensive operations on the ground that Marius was to supersede him in the command. Marius arrived in Africa in 107, and quickly reduced almost all the king's strongholds, and gradually subjected his territory to the dominion of Rome. Jugurtha, seeing his position slipping from his grasp, had formed an alliance with Bocchus, king of Mauritania, and invited forces attacked the army of Marius in its march, but after a desperate contest were completely defeated. The Mauritanian king now turned his ally, and enticed him into an ambuscade, where he was made prisoner, and detained in chains to Sulla, the quaestor of Macedonia.

He was taken to Rome, and, after adorning the triumph of his conqueror (Jan. 1, 104), was cast into prison, where he died of starvation six days. The details of the life of Jugurtha are chiefly known from the interesting history of the "Jugurthine War" by Sallust.

**JULLERAT, Clotilde Gérard**, a French painter, born in Lyons about 1810. She studied under Delacroix, and exhibited her first works in 1830.

In 1840 she married the poet and dramatist Paul Juillerat (born in Paris about 1815). Her productions include many fine portraits.

**JUJUBE**, a name given to species of *Zizyphus*, especially *Z. vulgaris*, a small tree, native of

and probably also jujube through the French. In its native country it is a tree 20 or 30 ft. high, but it will bear fruit when only a shrub; it has prickly branches, oval, thick, shining leaves, inconspicuous greenish flowers, and a fruit of the shape of an olive, but not quite so large, which in ripening turns yellow and then red; the fruit contains a single bony nut surrounded by a fleshy pulp, which is somewhat acid when fresh, but when dried is sweet and agreeable to the taste. In the East the fruit is eaten both fresh and dried; it is considered as mildly medicinal, and a sirup and a paste of jujubes are used in Europe for coughs and catarrhs; the true jujube paste is made of the pulps of jujubes, gum arabic, and sugar, but that which is sold under the name is merely gelatine and sugar, sometimes with a little tartaric acid and flavoring. The tree has fruited in Georgia, and would probably be hardy further north; aside from its fruit, it is worth cultivating, where the climate will allow, on account of its graceful habit and fine foliage. The Chinese cultivate several varieties of *Z. jujuba*, the fruit of which, known to foreigners as Chinese dates, is much esteemed by them. *Z. lotos* is one of several plants supposed to be the lotus of the lotophagi. An African species, *Z. Baclei*, has a fruit which tastes like gingerbread.

**JUJUY**. A province of the Argentine Republic, bounded N. by Bolivia, E. by the Gran Chaco, S. by the province of Salta, and W. by Bolivia; area, about 30,000 sq. m.; pop., in 1869, including foreigners, 40,379. The whole N. W. portion is an elevated plain called the Puna, which is a continuation of the great Bolivian table land, and which terminates somewhat abruptly to the south and east in a mountain chain extending due N. from Salta, and presenting a few snow-covered peaks of about 14,000 ft. E. of these mountains the territory gently inclines toward the plains of the Chaco, with a few inconsiderable mountains. The valleys bounded by the several ridges, especially those of the east, are exceedingly fertile, owing to abundant irrigation, an advantage not enjoyed in the Puna and the W. country generally. The principal river is the San Francisco or Grande, which flows in a semicircle forming the southern boundary of the province, receives numerous tributaries, and joins the Bermejo 25 miles S. of Oran. In the Puna are two lakes, Toro in the south and Casabindo in the north, both of considerable extent, and the second furnishing inexhaustible quantities of salt, much of which is exported. Asphalt, petroleum, gold, silver, copper, iron, and quicksilver abound in most districts; but for want of suitable means of transportation no mines have as yet been worked. Although mostly comprised within the tropics, this province has a mild and salubrious climate. The arboreal vegetation is luxuriant, and includes the maté, dragon's blood, and Peruvian balsam trees, and many kinds of timber and cabinet woods.



Jujube (*Zizyphus vulgaris*).

belonging to the *Rhamnaceæ* or buckthorn family. The Arabic name of the tree is *jujuba*, from which is derived the generic name,

Rice, maize, the sugar cane, and tobacco are largely cultivated. The principal industries are agriculture, the rearing of cattle, mules, sheep, goats, llamas, and vicuñas, spinning, and weaving. Coarse woollen stuffs are extensively manufactured. There are schools in every town, but at the time of the census, of 6,021 children aged from 6 to 14 years, only 1,383 attended; and of the whole population, only 4,309 read and 3,376 wrote. Formerly Jujuy was a part of the adjoining province of Salta.

**II. San Salvador de**, a city, capital of the province, situated on the right bank of the Rio San Francisco, in a fertile valley 4,000 ft. above the sea, 870 m. N. W. of Buenos Ayres; pop. in 1869, 7,629. It has no edifices worthy of mention. The industries of the place are chiefly conducted by Indians and mestizos; there is a weekly fair for cattle and agricultural products. In the vicinity are saline hot springs, the waters of which are efficacious against chronic rheumatism.

**JULIAN (FLAVIUS CLAUDIUS JULIANUS)**, surnamed the Apostate, a Roman emperor, born in Constantinople, Nov. 17, A. D. 331, died in Persia, June 26, 363. He was the son of Julius Constantius, the grandson of Constantius Chlorus, and the nephew of Constantine the Great. When Constantius II. ordered the male descendants of Chlorus by his second wife Theodora to be put to death, he made an exception in favor of Julian and his half brother Gallus, whose tender years did not excite his apprehension; but he banished them to certain cities of Ionia and Bithynia, and ultimately confined them in the strong castle of Macellum near the Cappadocian Cæsarea. During the period of their restraint Julian was instructed in the doctrines of the Christian faith, and was taught to fast, to pray, and to fill the office of reader in the church of Nicomedia. In 351 Gallus was taken from prison, invested with the dignity of Cæsar, and made prefect of the East. Through his mediation Julian was liberated, and permitted to fix his residence in any of the Asiatic cities. He now first became acquainted with those Platonic philosophers who ere long induced him to abandon Christianity for paganism; but he did not make a public avowal of his apostasy till he could do so with safety. After the murder of Gallus he again became an object of distrust to Constantius, who had him transported to Italy and imprisoned at Milan, whence having been liberated by the intercession of the empress Eusebia, he retired to Athens. Constantius soon recalled him, and on Nov. 6, 355, proclaimed him Cæsar, and gave him his sister Helena in marriage. He was at the same time invested with the government of all the transalpine provinces, and with the command of the forces which were to drive the German invaders of Gaul beyond the Rhine. Having effected this latter undertaking, and checked the rapacity of the local governors, he acquired such popularity that when the jealous Con-

stantius in 360 commanded him to send his best soldiers to the Persian war, the troops proclaimed him emperor. Julian crossed over into Germany, and made an admirable march along the forest-covered valley of the Danube, intending to advance against Constantinople; but the sudden death of Constantius gave him undisputed possession of the empire. On Dec. 11, 361, he made his triumphal entry into the capital, amid the acclamations of the soldiers, the citizens, and the senate. He now openly avowed his abandonment of Christianity, which had long before been known to his friends, and his Christian subjects apprehended a cruel and relentless persecution. Shortly after his accession, however, he published an edict which granted perfect toleration to all sects and religions. But the spirit of this edict was not respected even by Julian himself. He excluded Christians from civil and military offices, forbade them to teach grammar and rhetoric in the schools, compelled them to contribute to the building and repair of pagan temples, permitting at the same time the Jews to rebuild their temple at Jerusalem, and wrote a voluminous treatise against the assumed errors of Christianity. Amid the licentious priests and lascivious dancers who thronged the pagan temples, he was frequently seen bearing the wood, kindling the fire, slaughtering the victim, and divining from the entrails of the expiring animal. He was nevertheless worthy in other respects to wield the sceptre. Immediately after his accession he applied himself to reform the luxury and extravagance of the imperial court. He ordered the laws to be equitably administered, and instituted a tribunal for the trial of such officials as had been guilty of peculation or oppression in the former reign. The incursions of the Persians upon Roman territory led him to declare war against that people, and in 363, having crossed the Euphrates at Hierapolis, he advanced with the main body of his army against Ctesiphon. Under the walls of this place he gained a brilliant victory over a division of the enemy; but having been induced by the representations of a Persian noble, who affected to be a fugitive, to postpone the siege, and to march into the desert in search of Sapor, the Persian monarch, he was surprised by the enemy, and received a wound from an arrow which proved mortal in the evening of the same day. Julian was proclaimed his successor on the battle field. In his manner of life Julian emulated the temperance and simplicity of the primitive Romans; he was indefatigable in the discharge of his public duties, and in his intervals of leisure was devoted to study and philosophy. He possessed rhetorical and literary talents of a high order, and wrote much and well on various subjects. The ablest if not the most important of his extant works are: "The Cæsars," or "The Banquet," a satirical composition in which the different Roman emperors are made to appear at a celestial banquet

where old Silenus censures their vices and crimes; and the "Misopogon," or the "Beard-Hater," in which the emperor exposes the licentiousness and effeminacy of the citizens of Antioch, who had ridiculed the beard of their sovereign, such appendages not being fashionable in that city. His treatise against the Christians has been lost, except those extracts preserved in the refutation of it by Cyril of Alexandria. The best collective edition of the works of Julian is that of Spanheim (Leipsic, 1696). The most celebrated modern lives of Julian are by Gibbon in his "Decline and Fall of the Roman Empire;" by the abbé de la Bletterie, *Histoire de l'empereur Julien l'Apostat* (Paris, 1785); and by Neander, *Ueber den Kaiser Julianus und sein Zeitalter* (Leipsic, 1812).

**JÜLICH** (Fr. *Juliers*), a town of Prussia, in the province of the Rhine, capital of a circle celebrated for fertility, in the district and 17 m. N. E. of the city of Aix-la-Chapelle; pop. in 1871, 5,244. It is in a fertile plain, surrounded by low swampy grounds which make it unhealthy. Among its manufactures are common and white leather, soap, and vinegar. It has also some trade in cattle and in country produce. Coal is mined in its neighborhood.—The town was the Juliacum mentioned in the "Itinerary" of Antoninus. One of the imperial counts of Jülich, Gerhard I., assisted Henry the Fowler in his warfare against the Hungarians, and the county of Jülich was raised to the rank of a duchy in favor of Gerhard's descendants by the emperor Charles IV. (1357). For a long time afterward Jülich was one of the independent duchies on the Rhine, until the beginning of the 16th century, when the male line of hereditary dukes became extinct, and Jülich was united through the female line with Cleves, having previously been united with Berg. After the expiration of the house of Cleves in 1609, the contest about "the Jülich succession" formed one of the preludes to the thirty years' war. The dispute was not settled before 1666, when Jülich and Berg were given to the counts palatine of Neuburg. Jülich was annexed by the French republic, and by the congress of Vienna allotted to Prussia, with the exception of a few localities annexed to the Dutch province of Limburg. The razing of the fortress of Jülich was begun in 1860.

**JULIEN**, Stanislas Aignan, a French orientalist, born in Orleans, Sept. 20, 1799, died in Paris, Feb. 14, 1873. He was the son of a noted mechanic. After completing his classical studies in his native town, he went to Paris, where he studied several living European languages and perfected his knowledge of ancient Greek. Gail, professor of Greek in the collège de France, appointed him his substitute in 1821; and to vindicate his claims to this distinction, he published in 1823 a critical edition of the poem of Coluthus, Ἐλένη Ἀρ-αγή, with translations in Latin, French, Italian, Spanish, English, and German. In

1824, under the title of *La lyre patriotique de la Grèce*, he produced a French translation of the lyrical poems of the modern Greek poet Calvos of Zante. A young Scotchman inspired him with a taste for the Chinese language, and introduced him to Sir William Drummond, who supplied him with the means of studying it. He also attended the lectures of Abel Rémusat, and mastered the Chinese with such uncommon rapidity that within a year he was able to translate into Latin the writings of Mencius. In 1832 he succeeded Abel Rémusat as professor of the Chinese language and literature, and afterward did much toward making the literature of China known in Europe, publishing translations of many Chinese tales, poems, dramas, and other books. His most important publication, under the general title *Voyages des pèlerins Bouddhistes* (8 vols., Paris, 1853-'8), throws much light on the early history, geography, and religion of India. In 1869 was published his *Syntaxe nouvelle de la langue chinoise*, and at the time of his death he was engaged in the preparation of a complete Chinese dictionary.

**JULIERS.** See JÜLICH.

**JULIUS**, the name of three popes. **I. Saint**, born in Rome, died there, April 12, 352. He was chosen pope, Feb. 6, 337. He sustained Athanasius in his contest with the Arians, and summoned a council in 342, in which the course of Athanasius was approved, and the pope addressed a letter in his defence to the church of Alexandria. At his instance a general council was held at Sardica in 347, for the purpose of averting the threatened schism between the churches, at which it is asserted that the right of arbitration in cases of deposition of bishops was reserved to the see of Rome. The feast of St. Julius is celebrated on April 12. Two letters of his are given in the *Epistola Romanorum Pontificum*. **II. Giuliano della Rovere**, born at Albisola Marina in 1441, died Feb. 21, 1513. He was bishop successively of Carpentras, Albano, Ostia, Bologna, Avignon, and Mende, and was made cardinal by his uncle Sixtus IV., who also gave him command of the papal troops sent against the revolted Umbrians. His success in this war so increased his popularity, that Alexander VI. on assuming the tiara banished him from Rome. Julius returned to the camp, and contributed an important part in the conquest of Naples by Charles VIII., the rising of the Genoese, and the expulsion of Luigi Sforza. On the death of Alexander, Aug. 18, 1503, he caused the election of the aged Pius III., who survived his elevation only 26 days, and Julius himself was then chosen on the first ballot. His first care on coming to the throne was to drive out Cæsar Borgia from the Papal States, his next to strengthen and extend the power of the holy see. The refractory nobility at home were soon reduced to obedience; but the Venetians, who held Ravenna, Rimini, and other territories of the church, were a more formidable

enemy. After fruitless negotiations, Julius joined in 1509 the famous league of Cambrai, formed by the emperor Maximilian, Louis XII. of France, and Ferdinand of Aragon, for the dismemberment of the Venetian republic. The troops of the league were everywhere successful; the doge sued for peace, and the pope, who had now got what he wanted, grew jealous of Louis, and willingly united with the Venetians to expel the French from Italy. Ferdinand was also led to view the success of Louis with uneasiness, and became a party to the "holy league," which was signed in October, 1511, and of which Henry VIII. of England afterward became a member. Julius took the field in person, and, after several campaigns of varying success, drove out the "barbarians," as he termed his former allies. He could not so easily rid himself of the Swiss, German, and Spanish troops by whom he had effected this result, and in the midst of the disorder raised by his warlike and ambitious policy, he died without achieving for the holy see that preëminence which had been the whole aim of his pontificate. Julius was in heart and action a thorough soldier. He "made his tiara a helmet and his crosier a sword," and his disposition is well expressed in an old epigram:

Cum Petri nihil efflant ad prælia claves,  
Auxilio Pauli forstian ensis erit.

He was nevertheless regarded by the Italians as a friend to the liberation of their country, and the justice and wisdom of his internal administration gained him their affection. He laid the corner stone of St. Peter's church, and was a patron of Michel Angelo, Bramante, and Raphael. It was Julius II. who granted Henry VIII. a dispensation to marry Catharine of Aragon. He was succeeded by Leo X. III. *Gian Maria del Monte*, born in Arezzo, Sept. 10, 1487, died March 23, 1555. He belonged to a noble family, held several high offices under the papal government, was made cardinal in 1536, and succeeded Paul III. in 1550. He reopened the sittings of the council of Trent, which had been discontinued under his predecessor, and confirmed the institution of the Jesuits. He took part with Charles V. in his quarrel with Ottavio Farnese and the French, but was compelled to sign a truce with his enemies in April, 1552, soon after which he declared the suspension of the council of Trent, which had already been broken up by the Protestants, and retired to his luxurious villa near Rome. He reconciled England under Queen Mary with the holy see. He was succeeded by Marcellus II.

**JULIUS, Nikolaus Heinrich**, a German physician, born in Altona, Oct. 3, 1783, died in Hamburg, Aug. 20, 1862. With a view of examining the condition and management of prisons, he explored many parts of Europe and the United States, delivered lectures, and published a variety of works on this and kindred subjects, as *Die Amerikanischen Verbesserungssysteme* (Leipsic, 1837), *Nordamerikas sittliche Zustände*

(1839), and *Beiträge zur britischen Irrenheilkunde* (1844). He also edited the *Jahrbuch der Straf- und Besserungsanstalten* (Berlin, 1829-'48), and in concert with Gerson the *Nagaria der ausländischen Literatur der gesammten Heilkunde* (Hamburg, 1821-'35). In 1840 he returned to Hamburg, where he had previously practised his profession. His German translation of Ticknor's "History of Spanish Literature" appeared in 1852 (3 vols., Leipsic), and in 1866 a supplementary volume, edited by A. Wolf, was published.

**JULIUS AFRICANUS.** See **AFRICANA.**

**JULLIEN, Louis Georges**, a French composer, born at Sisteron, Basses-Alpes, April 23, 1812, died in Paris, April 16, 1860. At six years of age he was a skilful performer on the viola, and about 1830 gained admittance as a pupil into the *conservatoire* at Paris, where he was instructed by Cherubini. In 1839 he went to England, and for a number of years directed promenade concerts in London with great success. In 1858 he produced at Covent Garden theatre an opera entitled *Pietro il Grande*; and in the same year, accompanied by a large orchestra, he visited the United States, in the chief cities of which he gave concerts. His subsequent career was less prosperous, and he died in a charitable institution.

**JULY** (Lat. *Julius*), the seventh month of the year, consisting of 31 days. By the Romans it was originally called Quintilis (*quintus*, fifth), it being the fifth month in the original Latin year, which before Numa began with March. The name was changed to July, by proposal of Mark Antony, in honor of Julius Cæsar, who was born on the 12th of this month. In the Athenian calendar, the latter part of Scirophorion and the first part of Hecatombæon correspond to July. The Anglo-Saxons called it *mead monath* (mead month), because the meads were then in bloom, and *litha afters* (latter mild month), June being known as the "earlier mild month." Charlemagne gave it the name of *Heumonath* (hay month). The French revolutionary calendar merged it in the last part of Messidor and the first of Thermidor.

**JUMNA**, a river of Hindostan, and the principal tributary of the Ganges. It rises in Gerwhal, near the S. base of the Himalaya, in lat. 31° N., lon. 78° 32' E. at the foot of a group of hills called the Jumnotri peaks, near which it receives the overflow of several hot springs. It is here a violent torrent, having for 16 m. an average descent of 314 ft. per mile. After a S. W. course of about 60 m., during which it is joined by several large mountain streams, it receives the Tons in lat. 30° 30', lon. 77° 53'. About 97 m. from its source it enters the plain of Hindostan, flowing S., and divides into several branches. It here becomes navigable by rafts. After passing Delhi, where it is crossed by a bridge of boats, its general course is S. E. It joins the Ganges at Allahabad, 619 m. below Delhi, and 899 m. from its source. In the lower part of its course

the Jumna is sometimes 2 or 3 m. wide. Its banks are rocky and precipitous, and its current is rapid. Navigation is attended with much difficulty, but many of the most serious obstructions have been removed, and vessels can now ascend to Calpee. Its principal affluents are the Chumbul, Sinde, Betwa, Cane, and Hindaun. Delhi, Agra, Muttra, Etawah, Calpee, and Allahabad are the most important places on its banks.—There are two extensive systems of irrigation connected with the Jumna. The western Jumna canal comprises the ancient canal of Feroze Shah and the Delhi canal, on the right bank of the river, which were restored between 1823 and 1843 by the British authorities, who built many additional branches. This system waters the country along the western bank of the Jumna, from a point called Hathni Kund, just north of the 80th parallel, down to Delhi. The aggregate length of its main lines is 445 m., and in 1866-'7 the area irrigated comprised 447,171 acres, in 797 villages. The net receipts from water rates in 1871-'2 were £74,518, being 26 per cent. on the outlay for construction. The eastern Jumna canal irrigates a district about 120 m. long and 15 m. broad on the left of the river, and extends from a point in the main stream near the head of the western system, southward to Delhi, flowing for 40 m. between embankments, at a height of from 6 to 12 ft. above the general level of the land. It was projected by Shah Jehan, between 1628 and 1659, but had long been disused when it was restored by English engineers in 1830. The main channel is itself 180 m. long, and feeds 619 m. of distributary streams. The area of irrigation in 1871-'2 was 192,749 acres, and the net revenue £32,881, being 16.6 per cent. on the outlay.

**JUNE**, the sixth month of the year, consisting of 30 days. The name is variously derived from *juniores* (the young men), to whom Romulus is said to have assigned it, as he assigned May to the elders; from Juno, whence it was sometimes called Junonialis; from Junius Brutus, the first consul; and from *jungo* (to join), with reference to the union of the Romans and Sabines, or because it was considered the most suitable time for marriage. It was the fourth month of the old Latin calendar, and originally had but 26 days. Romulus is said to have given it 30 days. Numa made it the fifth month and deprived it of one day, which was restored by Julius Cæsar. In the Athenian calendar, the latter half of Thargelion and the first half of Scirophorion correspond to June. The Anglo-Saxons called it *litha ærra* (earlier mild month), also *sear monath* (dry month) and *midsummer monath* (midsummer month). It was named by Charlemagne *Brachmonat* (fallow month). In the French revolutionary calendar it corresponds to the last part of Prairial and the first of Messidor.

**JENEAU**, a S. central county of Wisconsin, bounded E. by the Wisconsin river, and drained

by Lemonweir, Yellow, and Baraboo rivers; area, about 800 sq. m.; pop. in 1870, 12,372. The surface is undulating and the soil fertile. Timber is abundant. The La Crosse division of the Chicago, Milwaukee, and St. Paul railroad crosses it. The chief productions in 1870 were 192,304 bushels of wheat, 115,893 of Indian corn, 197,005 of oats, 97,755 of potatoes, 26,904 lbs. of wool, 527,027 of hops, 221,008 of butter, and 15,499 tons of hay. There were 2,040 horses, 2,846 milch cows, 3,982 other cattle, 8,406 sheep, and 4,959 swine; 8 manufactories of carriages, 2 of sash, doors, and blinds, 6 of tin, copper, and sheet-iron ware, 4 flour mills, and 11 saw mills. Capital, New Lisbon.

**JUNE BERRY**, one of the common names for *amelanchier Canadensis*, a roseaceous shrub or small tree, which botanically differs from *pyrus*, the genus of the apple and pear, only in the number of cells in the fruit. This species is found as far north as Hudson bay, and extends throughout the United States; running through such a wide geographical range, it presents a great variety of forms; more than a dozen species were described by the early botanists, but Torrey and Gray, in their "Flora of North America," very properly reduced all these to a single polymorphous species, of which there are half a dozen forms sufficiently marked to be regarded as varieties. These differ in stature, in the shape and pubescence of the leaves, size of petals, and size and abundance of the fruit. A mountain variety, *pyrnilla*, is only 3 or 4 ft. high, while the variety *botryapium* reaches 30 ft. in height. The leaves in all are simple, heart-shaped, or oval, with white flowers in pendulous racemes, which appear just as the leaves are opening. In some parts of the country the different varieties are known as shad flower or shad bush, as the flowers appear at the time the shad ascends the streams, and also as service berry. The fruit is globular or pear-shaped, the size of a large pea, purplish, sweet and edible. From the character of the fruit the bush is known in some localities as the sugar pear, but more generally, from the time of its ripening, as June berry. Some plants produce fruit abundantly, which is mostly eaten by birds. The dwarf variety has been brought into cultivation in some of the western states as a market fruit, and is there known as "mountain whortleberry;" it has been tried by amateurs at the east, who find that the birds reap the harvest. All forms of the species are worthy of cultivation as ornamental trees or shrubs, on account of their early and abundant flowering; a well formed specimen, completely sheeted with white, is not exceeded in beauty by any exotic. There is a European species, known in Savoy as *amelancier*, from which the name of the genus is derived.

**JUNG**, or *Jungius*, *Joachim*, a German philosopher, born in Lübeck, Oct. 23, 1587, died in Hamburg, Sept. 23, 1657. He was professor of mathematics at Giessen from 1609 to 1614.

He subsequently studied medicine and took his degree at Padua in 1618, but again filled a chair of mathematics at Rostock in 1624. He was prevented by the thirty years' war from accepting a professorship of medicine at Helmstedt, and lived in retirement at Brunswick and Rostock till 1629, when he became rector of the Hamburg Johanneum. Leibnitz ranks him, on account of his perspicacity in opposing the scholastic school of philosophy, next to Copernicus and Galileo, and not far below Descartes. His works include *Geometria Empirica* (Hamburg, 1688). Johann Vaget edited his MS. *Joachim Jungius Isagoge Phytoscopica, &c.* (Hamburg, 1678), in which he anticipated Linnæus in suggesting technical terms relating to botany and in other respects.—See Guhrauer, *Joachim Jung und sein Zeitalter* (Stuttgart, 1851), and Avé-Lallemont, *Des Dr. J. Jungius aus Lübeck Briefwechsel mit seinen Schülern und Freunden* (Lübeck, 1863).

**JUNG-BUNZLAU**, or **Bunzlau** (Boh. *Mlada Boleslav*), a town of Bohemia, capital of a circle, on the Iser, 80 m. N. E. of Prague; pop. in 1869, 8,695. It has 16 churches and a monastery of the Piarists, with a gymnasium. The ancient castle, which is said to have been built by Boleslas II. in the 10th century, is now used as barracks. The town stands near the site of an older Bunzlau, founded by Boleslas I., and destroyed in the Hussite and thirty years' wars.

**JUNGERMANNIA**, a genus of cryptogamous plants belonging to the family *hepaticæ* or liverworts, which is closely related to the mosses; there are about 20 species in the United States, all small delicate plants, the general structure of which is described under **LIVERWORT**.

**JUNGFRAU** (the "Maiden" or "Virgin"), a picturesque mountain, or rather group of mountains, in Switzerland, forming one of the ridges of the Bernese Alps, and separating the cantons of Valais and Bern. It is 13,671 (according to others 13,718) ft. high, and derives its name either from the pure mantle of snow which covers its crest, or from the fact that until the present century it was deemed inaccessible. In 1811, however, the brothers Meyer of Aarau claimed to have ascended it. In 1828 the highest peak was reached by some peasants from Grindelwald, and in 1841 by Agassiz, accompanied by Prof. Forbes of Edinburgh and others. Although the thermometer fell to 6½° below zero, lichens were found on the highest exposed points. The highest peak rises in a sharp point, its summit being not more than 2 ft. broad. The Silberhörner, which are inferior peaks on the W. side, are remarkable for their graceful forms.

**JUNGHEHN**, Franz Wilhelm, a German naturalist, born at Mansfeld, Oct. 26, 1812, died at Lembang, Java, April 24, 1864. He studied medicine, botany, and geology in Halle and Berlin, and became assistant surgeon in the Prussian army. Having fought a duel, he was sentenced to 20 years' imprisonment, but es-

caped to France. He then received a pardon, and went in 1835 to the Dutch East Indies, was employed in Batavia for a year as military physician, and afterward explored the islands, especially Java and Sumatra, under the auspices of the government. In 1849-'55 he was in Holland, preparing his observations for publication, and then returned to Java. His *Topographische und Naturwissenschaftliche Reisen* were edited by Nees von Eoenbeck (Magdeburg, 1845). German and Dutch editions of his *Battaländer in Sumatra* appeared in Berlin and Leyden in 1847; and a German version by Hasskarl of his *Zurückreise von Java nach Europa* in 1851. His most important work, considered by many the best on the subject, treats of the botany, geography, and geology of Java (*Java, seine Gestalt, Pflanzendecke und innere Bauart*, German ed. by Hasskarl, 3 vols., Leipzig, 1852-'4). In 1853 appeared his *Landschaftsansichten von Java und der Natur aufgenommen*. In 1851 was begun, under the supervision of several distinguished naturalists, a large work entitled *Planta Javahuhniana*, giving a description of the plants and fossils discovered by him in Java and Sumatra.

**JUNGMANN**, Josef Jakob, a Slavic philologist, born at Hudlitz, Bohemia, July 16, 1773, died in Prague, Nov. 14, 1847. He was the son of a poor farmer, but received a superior education, and completed his studies at the university of Prague. He was teacher at the gymnasium of Leitmeritz from 1799 to 1815, and afterward connected with the gymnasium and university of Prague till 1845, the last five years as rector of the latter institution. In 1820 he published a Bohemian chrestomathy (*Slowenost*, 2d ed. 1846); in 1825 a history of the Bohemian language and literature (2d ed., 1848); and in 1835-'9 a complete Bohemian-German dictionary (*Slownik Cesko-Nemecky*).

**JUNG-STILLING** (JOHANN HEINRICH JFFE), a German mystic, born at Im-Grund, Nassau, Sept. 12, 1740, died in Karlsruhe, April 2, 1817. After being successively a charcoal burner, tailor, and teacher, he began to study medicine at Strasburg, where he became acquainted with Goethe, who in his autobiography has given a fine analysis of his character. He operated for cataract with eminent success at Elberfeld, was professor of rural economy at Lautern (1778), Marburg (1787), and Heidelberg (1804), and at his death was a privy councillor of Baden. The best known of his writings is an autobiography, *Stilling's Jugend, Jünglingsjahre, Wanderschaft, Lehrjahre, häusliches Leben und Alter* (published in three parts, 1777, 1789, and 1817), a curious work, containing many profound thoughts, and marked by an eccentric religious and moral enthusiasm. He wrote several allegorical and mystical tales, as the *Geschichte des Herrn von Morgethau* (1779), *Geschichte Florentino von Paldorn* (1781), *Leben der Theodora von Linden* (1783), *Das Heimweh* (1794), and *Thalheld oder der Schwärmer* (1797). In his autobiog-

raphy he takes a sentimental delight in picturing his three successive wives, and love and marriage are treated with special enthusiasm in his romances. In his later works he appears as a ghost-seer and theosophist. The most important of them are: *Theorie der Geisterkunde* (1808), and *Apologie der Theorie der Geisterkunde* (1809), full of marvellous but not carefully authenticated narratives; *Scenen aus dem Geisterreich* (1817), consisting of conversations in heaven, and inculcating a sort of worship of genius; and the poem *Chrysdon, oder das goldene Zeitalter* (1819), descriptive of the millennium. His various works were collected in 14 vols. (Stuttgart, 1838).

**JUNIATA**, a river of Pennsylvania, formed in the S. central part of the state, by the junction of the Little Juniata and Frankstown branch, which rise at the foot of the Alleghany mountains, in Blair and Bedford counties. Its general course is E., with many deviations; and after passing through a mountainous country, it joins the Susquehanna 14 m. above Harrisburg. Nearly its whole course is celebrated for its picturesque scenery. Including the Frankstown branch, it is about 150 m. long. It is not navigable. The Pennsylvania canal and railroad follow its banks throughout its whole extent, the latter crossing the river many times.

**JUNIATA**, a central county of Pennsylvania, watered by the Juniata river; area, 860 sq. m.; pop. in 1870, 17,390. It has a mountainous surface, with many fertile valleys. The Pennsylvania railroad and canal pass through it. The chief productions in 1870 were 280,624 bushels of wheat, 329,281 of Indian corn, 347,054 of oats, 69,520 of potatoes, 16,988 lbs. of wool, 299,575 of butter, and 19,809 tons of hay. There were 4,215 horses, 9,160 cattle, 6,315 sheep, and 7,164 swine; 4 manufactories of agricultural implements, 13 of carriages, 8 of lime, 18 tanneries, 9 flour mills, and 2 saw mills. Capital, Mifflintown.

**JUNIPER** (*juniperus*, the ancient Latin name), a genus of evergreen shrubs and trees, of the cypress subfamily of the order *conifera*. The leaves in this genus are awl-shaped or scale-like, rigid, and sometimes of two shapes in the same tree; the flowers, mostly dioecious, are in small axillary aments; the sterile aments consist of shield-shaped scales, beneath each of which are three to six anther cells; the fertile have three to six fleshy, one-ovuled, coalescent scales, and in ripening become a berry-like fruit. The common juniper (*J. communis*), also a native of Europe, is abundant in the northern states, especially on dry sterile hills near the coast, where it is not rare to find plants only a foot or two high spreading close to the ground, and forming a circular mat 30 ft. in circumference. It sometimes rises to the height of 5 to 10 ft., and old specimens attain a much greater size. One at the Bartram garden, near Philadelphia, a few years ago, measured 35 ft. The leaves are articulated with the stem in whorls of three, spreading and

prickly-pointed; the upper surface is glaucous white, the under dark green. The berries are about the size of a pea, and dark purple; they contain a brownish pulp, with three seeds; their taste is sweetish, warm and bitterish, with a peculiar terebinthinate flavor; they contain a volatile oil (oil of juniper), which is separated by distillation. The berries are stimulant and diuretic, and have long been used for urinary diseases; they are used in the manufacture of gin, and give to that liquor its peculiar flavor and diuretic properties. In Europe a kind of tar is prepared from the wood, which under the name of oil of cade is used for cutaneous diseases. The common juniper varies greatly; in a bed of seedlings it is difficult to find two alike; some of its forms are useful in ornamental planting. A very prostrate form, the variety *alpina*, found along the great lakes and northward, is a useful plant for rockwork. The well known Irish (var. *Hibernica*) and Swedish (var. *Suecica*) junipers are remarkably erect varieties of this species; these, especially the latter, are much used in ornamental planting, where their columnar forms afford a marked contrast to other trees. They are liable to be bent out of shape by the accumulation



Pistillate and Staminate Flowers.

of snow among their dense erect branches; this can be prevented by winding the tree with a cord or fine wire at the approach of winter. A related species from the south of Europe, *J. hemispherica*, is remarkably dwarf, a plant ten years old being not over a foot high; this is known as the hedgehog juniper, and is a favorite with planters for the decoration of small grounds.—The section of savin junipers differs from the true junipers, to which the foregoing belong, in having their leaves opposite and not articulate with the stem. A prominent representative of this section is the red cedar (*J. Virginiana*), which is found from Canada to the gulf of Mexico. Few trees present in their wild state a greater variety of form; in some localities every specimen takes an erect habit and forms a dark green column, tapering but slightly from the base, and as regular in outline as if artificially pruned; in other places, especially inland, the tree has a clear trunk and handsome open head, with somewhat pendulous branches; those which grow



in exposed situations, upon sterile soil near the sea, are of slow growth, and often assume picturesque and even fantastic forms; along the coast it is rarely more than 80 ft. high, but at the west it reaches 60 and even 90 ft. Upon the old branches the leaves are small, scale-like, and appressed; but those on the young plant and on the young shoots of old trees are much longer, sharp and spreading. The wood is light, close-grained, and very durable; the sap wood white, and the heart wood of a dark red, a fact recognized in the common name. The durable character of the wood adapts it for fence posts, and this together with the forms assumed by the branches makes it the most desirable material for rustic fences, summer houses, pavilions, and the like; it is much used in the manufacture of pails and tubs; it is employed by the pencil makers in place of the more rare pencil cedar, *J. Bermudiana*. Much more use is made of the red cedar as a tree for planting in the western states than at the east, as it grows more rapidly there. It was at one time highly recommended for hedges and windbreaks; but as it soon becomes ragged at the base, it has fallen into disrepute. The true savin is *J. sabina*, a native of Europe; it differs from the red cedar mainly in its larger fruit, which is nodding upon a recurved peduncle-like bractlet. A prostrate form of this, var. *procumbens*, is found from Maine to Wisconsin, along the great lakes, and northward. This has a dense, closely spreading habit, and a dark green color, which makes it much prized as an ornamental plant; it is known as the prostrate juniper, *J. prostrata* of the nurseries. The leaves of the savin have a limited use in medicine, as the active ingredient in savin cerate, a stimulant application to ulcers. The Rocky mountain juniper is *J. occidentalis*, not over 40 ft. high, and found from the Rocky mountains westward.—There are several exotic species in cultivation, most of which are of uncertain hardness in the northern states; among the hardy ones are *J. squamata*, a shrub-like species from the Himalayas, and the Chinese juniper (*J. Chinensis*), the two sexes of which have leaves so unlike that they appear like different species; the sacred juniper of India (*J. religiosa*) is hardy in some localities.

JUNIUS, the signature of an English political writer, the author of letters which appeared in the London "Public Advertiser" newspaper between Jan. 21, 1769, and Jan. 21, 1772. As acknowledged in the first authorized collection, the series consisted of 44 letters by Junius and 15 by Philo-Junius, an auxiliary part being assumed under the second name for the purpose of supporting and defending the principal character, but with the design of being ultimately avowed. There have been preserved also 62 brief business letters which he addressed to Woodfall, the publisher of the "Public Advertiser," between April 20, 1769, and Jan. 19, 1773, and 10 letters written by him in private correspondence with John Wilkes between

Aug. 21, and Nov. 9, 1771. To the same hand are attributed also 113 letters, on various political subjects and under different signatures, as Mnemon, Atticus, Lucius, Brutus, and Domitian, published in the "Public Advertiser" between April 28, 1767, and May 12, 1772. Some of these are of doubtful authenticity, and few of them are so elaborately finished and polished as the letters of Junius, to which signature he adhered for his most important addresses after the extraordinary effect produced by the first letter under it, apparently employing others when he wrote for explanatory and collateral purposes. The utmost period in which the agency of Junius can be traced is thus less than six years, and the period in which he wrote his acknowledged letters is about three years. These letters, directed against the ministry and the leading public characters connected with it, contain some of the most effective specimens of invective to be found in literature. Their condensed and lucid diction, studied and epigrammatic sarcasm, dazzling metaphors, and fierce and haughty personal attacks, arrested the attention of the government and of the public. Not less startling was the immediate and minute knowledge which they evinced of court secrets, making it believed that the writer moved in the circle of the court, and was intimately acquainted not only with ministerial measures and intrigues, but with every domestic incident. They exhibited indications of rank and fortune as well as scholarship, the writer affirming that he was "above a common bribe" and "far above all pecuniary views." When Woodfall was prosecuted in consequence of Junius's letter to the king, the author promised to make restitution to him of any pecuniary loss. The authorship of Junius was the greatest secret of the age. Every effort that the government could devise or private indignation prompt was in vain made to discover it. The earl of Mansfield and other legal advisers of the crown had many consultations as to how this "mighty boar of the forest," as he was called by Burke, could be most adroitly ensnared in the network of the law. The host of enemies whom he aroused in every direction were eager in plotting schemes for his detection. But, aware that his power and perhaps his personal safety depended upon concealment, he continued to astonish every one by his secret intelligence and to assail the government with undiminished intrepidity and rancor, revealing his apprehensions and precautions only in his private notes to Woodfall. His security was doubtless due in large measure to the forbearance and honor of this publisher, who followed strictly the imperative and precise orders of his correspondent. In one of his letters to a public character Junius gave as a reason for his concealment: "Though you would fight, there are others who would assassinate." In a letter to Woodfall he writes: "I must be more cautious than ever. I am sure I should not survive a discovery thro"

days; or if I did, they would attain me by bill." In other letters he speaks with the utmost confidence. "As to me, be assured that it is not in the nature of things that they, or you, or anybody else should ever know me, unless I make myself known; all arts, or inquiries, or rewards would be equally ineffectual." And in his dedication to the English nation he declared: "I am the sole depository of my own secret, and it shall perish with me." Junius appears to have written in a disguised hand. Various prescribed signals, as "C," "A letter," or a scrap of Latin poetry, were made to him in the notices to correspondents in the "Public Advertiser." Answers and parcels from the printer were left for him according to his orders in a great variety of places, addressed to different names. Who the person was who thus foiled the scrutiny of his own age has been the subject of more than 100 volumes or pamphlets, and of a vast number of essays in periodicals. Efforts have been made at different times to identify him with Sergeant James Adair, Col. Isaac Barré, Hugh Macaulay Boyd, Edmund Burke, Bishop John Butler, Lord Camden, Lord Chatham, Lord Chesterfield, J. L. De Lolme, John Dunning (Lord Ashburton), Samuel Dyer, Henry Flood, Dr. Philip Francis, Sir Philip Francis, Edward Gibbon, Richard Glover, Henry Grattan, William Greatrakes, George Grenville, James Grenville, William Gerard Hamilton, James Hollis, Sir William Jones, John Kent, Gen. Charles Lee, Charles Lloyd, Thomas Lord Lyttelton, Laughlin McLean, the duke of Portland, Gov. Thomas Pownall, Sir Robert Rich, John Roberts, the Rev. Philip Rosenhagen, Lord George Germaine (Viscount Sackville), the earl of Shelburne, Earl Temple, John Horne Tooke, Horace Walpole, John Wilkes, Alexander Wedderburn (Lord Loughborough), Dr. James Wilmot, and Daniel Wray. Several of these laid claim to the honor of which they were ambitious, while the real author may have declined to accept a brilliant literary fame with the stigma of an almost fiendish malignity of character. The first attempt to fix the authorship upon Sir Philip Francis was made in 1816 by John Taylor, in his "Identity of Junius with a Distinguished Living Character Established," and it has from that time been more generally ascribed to him than to any other. According to Macaulay, "the case against Francis, or, if you please, in favor of Francis, rests on coincidences sufficient to convict a murderer." Besides numerous and constant coincidences in dates and circumstances, and resemblance of character and handwriting, it should be observed that he never directly denied the charge. In answer to an inquiry, he wrote evasively: "Whether you will assist in giving currency to a silly malignant falsehood is a question for your own discretion." Lady Francis affirms that his first gift to her after marriage was an edition of Junius, which he bade her take to her room, keep from sight,

and never to speak on the subject; and he made a posthumous present to her of a sealed copy of Taylor's "Identity of Junius," found in his bureau. According to her statement, also, Sir Philip made himself known as Junius to the king, Lord North, and Lord Chatham, under an engagement of secrecy, and received in consequence his Indian appointment; and the secret was faithfully kept by each of the contracting parties, who were equally interested in not divulging it. Since the publication of the facsimiles of the feigned handwriting of Junius, facts have come to light which seem to prove conclusively the identity of Francis with him. A lady recognized the handwriting as the same as that of an anonymous note which she received in 1770 at Bath, enclosing a copy of verses written in a different hand. When the life of Francis was published (1867), two lines of these verses were found quoted in a letter from Richard Tilghman of Philadelphia, dated Sept. 29, 1773, in a manner implying that Francis would recognize them. Renewed examination proved that the lady's copy of verses was in Tilghman's handwriting. Tilghman, who was a law student in the Temple in 1769 and 1770, was a near relative and intimate friend of Francis, and was with him at Bath when the verses were delivered. This led to a careful examination of the note in which the verses were enclosed by experts, who unhesitatingly pronounced it to be written in the feigned hand of Junius. Now Tilghman could not have been Junius, for the letters were begun before he left America, and continued after his return home. It follows then that Francis was the writer of the note and consequently Junius.—Complete editions of his letters were published by George Woodfall, son of the original printer of them (3 vols., London, 1812 and 1814), to which an elaborate preliminary essay was prefixed by Dr. John Mason Good. A new edition (1850-'55), by John Wade, forming two volumes in Bohn's "Standard Library," contains the whole of Woodfall's edition. The most complete bibliography of Junius is given in Lowndes's "Bibliographer's Manual," vol. iii. (London, 1860). Merivale's "Memoir of Sir Philip Francis" (3 vols. 8vo, London, 1867) contains much new evidence concerning the authorship. See also Chabot and Twistleton's "Handwriting of Junius Professionally Investigated" (4to, London, 1871). Sir Alexander Cockburn, lord chief justice of England, in a work announced for publication in 1874, is said to prove almost conclusively the identity of Sir Philip Francis with Junius.

**JUNIUS. L. FRANCIS** (FRANÇOIS DU JOX), a Protestant theologian, born in Bourges, France, in 1545, died in Leyden in 1602. He was designed for the law, but having embraced the doctrines of the reformation, he went in 1563 to Geneva, where he studied theology. He became minister of a Walloon congregation in Antwerp in 1563, and took a prominent part

in the early history of the reformation in the Netherlands, but was obliged to seek refuge in Germany. In 1573 he was invited by the elector palatine to Heidelberg, where, in conjunction with Tremellius, he made a Latin translation of the Old Testament, which is highly esteemed by critics (5 parts, Frankfort, 1575-'9; many times reprinted, last in Zürich, 1764). Subsequently he became professor at Leyden. He wrote many theological books, and an autobiography (1595). His *Opera Theologica* were published in 2 vols. fol. (Geneva, 1607). **II. Francisus**, a philologist, son of the preceding, born in Heidelberg in 1589, died in Windsor, England, Nov. 19, 1677. He studied at Heidelberg and Leyden with a view to the profession of a military engineer, and in 1603, after the death of his father, joined the army; but leaving it on the truce of 1609, he devoted himself to study and literature. In 1620 he went to England, and for 30 years filled the office of librarian to the earl of Arundel. During this period he studied the Teutonic languages, and came to the conclusion that the Gothic was the parent of them all. He published an edition of the Gothic Gospels of Ulfilas, with a commentary; but his greatest work was his *Glossarium Gothicum*, in five languages, the Saxon department of which has since been issued separately under the title of *Etymologicum Anglicanum*. He also wrote a treatise *De Pictura Veterum*, which he translated into English himself. In 1650 he visited Germany, and remained there for some years. He died while residing in the house of his nephew, Isaac Vossius. He bequeathed all his MSS. to the Bodleian library at Oxford.

**JUNO**, called by the Greeks **HERA**, in ancient mythology, a daughter of Saturn and Rhea, and the sister and wife of Jupiter. She bore the same relation to women that Jupiter did to men, and was treated with the same reverence by the Olympians as the father of gods and men himself, and styled the queen of heaven. She was surnamed, by the Greeks and Romans respectively, *Βασίλεια* and *Regina*, as the celestial queen; *Γαμήλια* and *Pronuba*, as the patroness of marriage; *Ειδειθνα* and *Lucina* as presiding over childbirth. She was not, according to Homer, a very amiable, obedient, or devoted wife, and her jealousy, obstinacy, and violence often caused Jupiter to tremble on his throne. Having conspired with Neptune and Minerva to dethrone and confine him, Jupiter bound her with chains and hung her up in the clouds. Juno was the mother of Mars, Hebe, and Vulcan. The chief seats of her worship were Argos, Samos, Sparta, and Rome. Her most celebrated Hellenic temple, situated near Argos, contained a colossal statue of the goddess, made of ivory and gold. At Rome her principal temple was on the Capitoline hill, and her great festival, the *matronalia*, was celebrated on the 1st of March by the wives and matrons of the city. Juno is usually represented in works of art as a woman of majestic mien,

crowned, and sitting in a chariot, with a peacock beside her. She was the great goddess of nature, the impersonation of maternity.

**JUNOT**. See **ABRANTÈS**.

**JUPITER** (Lat. gen. *Jovis*, whence the English form *Jove*), called **ZEUS** by the Greeks, the greatest of the Greek and Roman gods, son of Saturn and Rhea, and brother of Neptune, Pluto, Vesta, Ceres, and Juno. As Saturn was wont to devour his children as soon as they were born, his wife Rhea, when she found herself pregnant with Jupiter, entreated Cœlus and Terra (Uranus and Ge) to save the life of the child. On their advice she fled to Crete, and concealed him in a cave of Mt. *Ægæa*. As he approached maturity Jupiter gave evidence of the divinity of his nature. He delivered the Cyclops from the bonds with which they had been fettered by Saturn; gave liberty to the hundred-handed giants Briareus, Cottus, and Gyes; subdued the Titans, and shut them up in Tartarus; and finally dethroned his father, and obtained the empire of the universe, which he shared with his brothers Neptune and Pluto, assigning the dominion of the sea to the former, that of the lower regions to the latter, and reserving for his own peculiar realm the heavens and the atmosphere; while over the earth and earthly beings the whole three exercised a joint rule. Jupiter fixed his residence on the summit of Olympus, and took successively to wife Metis, by whom he became the father of Minerva; Themis, who bore him the *Horæ* and the *Parcæ*; Eurynome, who was the mother of the *Graces*; Ceres and *Mammosyne*, whose offspring were *Proserpine* and the *muses*; Latona, who became the mother of Apollo and Diana; and Juno, whose children by him were Mars, Hebe, and Vulcan. Jupiter was the most powerful of the gods, the supreme ruler both of mortals and immortals. Everything good or bad proceeded from him, and at his pleasure he assigned a happy or an unhappy destiny to earthly beings. He was armed with thunder and lightning, and at the shaking of his shield the tempest raged, and the rain and the hail descended. His most distinctive epithets were *Ὀλύμπιος*, or *Olympian*, *Capitolianus*, from his principal temple at Rome on the Capitoline hill, and *Κεραυνός*, or *Tonans*, "the thunderer." The most celebrated Hellenic temples of Jupiter were those of Dodona and Olympia, the latter of which contained the famous colossal statue of the god by Phidias. The eagle, the oak, and the summits of mountains were sacred to Jupiter, and his favorite sacrifices were goats, bulls, rams, and cows. Jupiter is generally represented sitting on a throne with a thunderbolt in his right hand, a sceptre in his left, and an eagle standing by him.

**JUPITER**, the largest member of our planetary system, and the fifth in order of distance from the sun, so far as the primary members of the system (omitting the asteroids) are concerned. It is designated by the sign ♃. Jupiter travels

at a mean distance of 475,692,000 m. from the sun, his greatest distance being 498,639,000 m., and his least 452,745,000 m. When he is in opposition, his distance from the earth is reduced by the whole amount of the earth's distance from the sun at the time; and as it chances that the perihelion and aphelion of his orbit lie almost directly opposite the parts of the earth's orbit where she is at her mean distance (91,430,000 m.), it follows that when in opposition Jupiter's distance from the earth varies between 407,209,000 m. (498,639,000 — 91,430,000) and 361,315,000 m. (452,745,000 — 91,430,000), a very noteworthy difference. It may be mentioned that Jupiter's perihelion lies in about lon. 12°, so that oppositions occurring when the earth's heliocentric longitude is about 12° (in other words, during the first week in October) are under ordinary circumstances the most favorable occasions for the study of this planet. Nor is the advantage so slight that the oversight of the circumstance in our ordinary text books of astronomy can be readily understood. At an opposition of this kind the apparent area of Jupiter's disk exceeds the apparent area at an opposition early in April, roughly in the proportion of (407)<sup>2</sup> to (361)<sup>2</sup>, or as 430 to 338—say as 5 to 4; and in addition, Jupiter is more fully illuminated by the sun in the proportion (still roughly) of (499)<sup>2</sup> to (458)<sup>2</sup>, or as 522 to 430—say as 6 to 5; and as the comparatively small illumination of Jupiter limits the magnifying power which can be applied with any given telescope under the most favorable conditions, we may fairly combine these two ratios, and regard 8 to 2 as representing the proportion in which an October observation of Jupiter surpasses an April observation, the planet being in either case in opposition. Jupiter circles round the sun in a mean period of 4.3325848 days; and his mean synodical period (that is, the interval separating his successive returns to opposition) has a mean value of 398.867 days. Various estimates have been obtained of Jupiter's dimensions; but we may take 85,000 m. as the most probable extent (in round numbers) of his equatorial diameter. His polar diameter is considerably less, the compression of the planet being variously estimated at from  $\frac{1}{12}$  to  $\frac{1}{14}$ . We may assume  $\frac{1}{12}$  as approximately correct, according to which estimate his polar axis would be about 5,700 m. less than an equatorial diameter. His volume is about 1,235 times as great as the earth's; but his density being only about one fourth of the earth's, his mass does not exceed that of the earth in so considerable a proportion. Nevertheless, the disproportion still remains very great, since the mass of the planet exceeds the earth's more than 301 times. It must be remarked that this number 301, being deduced from the observed motions of the planet's satellites, may be relied on as approximately exact, whereas the number 1,235, representing Jupiter's volume (the earth's being 1), depends only on the estimated diam-

eter and compression of the planet, and therefore cannot be regarded as exactly determined. The estimated density is necessarily affected by any inaccuracy which may exist in the determination of the volume; but a moment's consideration will show that the probable limits of error in the determination of the density are not wide. Jupiter rotates on his axis in rather less than 10 hours. The period given by Beer and Mädler (see their *Beiträge zur physischen Kenntniss der himmlischen Körper im Sonnen-systeme*, Weimar, 1841) is 9 h. 55 m. 26.5324 s.; but no reliance can be placed on the last four digits in this result: first, because it is doubtful whether any markings exist on Jupiter which can be recognized after the lapse of long intervals of time; and secondly, because if such marks exist, none have been observed during periods long enough to insure that even the seconds in the rotation period should be rightly assigned.—Jupiter is the centre of a noble scheme of dependent bodies, called his satellites, which circle round him at the distances indicated in the accompanying table, which presents the chief elements of this interesting system:

ELEMENTS OF JUPITER'S SATELLITES.

NO.	Sidereal revolution.	Distance in radii of J.	Inclination of orbit to J's equator.	DIAMETER.		Mass, that of Jupiter being 1.
				Appar.	In miles.	
I....	1 18 30	6.05 0' 7"	1.026	2,352	0.00017328	
II....	8 18 4	9.62 1 6	0.91	2,099	0.00022235	
III....	7 3 48	15.25 5 3	1.49	3,436	0.00058497	
IV....	19 16 32	26.99 0 34	1.27	2,922	0.00043259	

The densities of the satellites have usually been stated incorrectly in the text books of astronomy at respectively 0.114, 0.171, 0.396, and 1.468 (where the density of water is unity). Whence these values were originally derived we do not know; but they are unquestionably incorrect. The following values of the densities have been calculated by the present writer from Laplace's estimates of the masses, combined with the values of the diameters above stated:

Satellite	Density (earth's as 1).	Density (water as 1).
I.....	0.198	1.148
" II.....	0.374	2.167
" III.....	0.225	1.868
" IV.....	0.228	1.468

Thus all the satellites have a greater mean density than Jupiter. Probably their real densities are greater than those here tabulated, since irradiation would increase their apparent diameters. The motions of the satellites of Jupiter have been studied with scrupulous care by astronomers, from the time when Galileo in 1610 first discovered these bodies. They had not been long observed in this way before a peculiarity was recognized which Römer was the first to interpret. It was found that pre-

dicted phenomena of the satellites occurred earlier when Jupiter was in opposition than when he was in quadrature, and that in fact the further Jupiter was from opposition up to the time when he was so near conjunction that his satellites could no longer be observed, the later these phenomena occurred. It was at length suggested by Römer that the discrepancy was due to the increase of distance, the light which brings to our earth information of the phenomena taking longer in reaching the earth when the planet is further away. Repeated observations confirmed this theory, which at first astronomers of repute ridiculed as too fanciful for serious consideration. Bradley's discovery of the aberration of light placed the theory beyond the possibility of question.—The appearance of Jupiter's disk is such as to suggest the idea that the planet is enveloped in a deep vaporous atmosphere, heavily laden with cloud masses. A series of broad bands or belts, alternately dark and light, and differing in color, lie across the disk, agreeing generally in position with the latitude parallels of the planet. On a close study with telescopic power, these belts are found to present peculiarities of structure exceedingly interesting. Rounded clouds appear to float separately within the deep atmosphere, and from time to time changes of shape and of color are noticed which seem to imply the action of forces of great intensity. Theoretical investigations applied to the subject of an atmosphere of great depth, attracted by the strong gravity of Jupiter, suggest that conditions of pressure would exist incompatible with the gaseity of the envelope. And the known small density of the planet, combined with the result just mentioned, suggests that in the case of Jupiter, as in that of the sun, the increase of pressure and therefore of density, which we should expect from the mere mass of the planet, is counteracted by the expansive effects of intense heat. This view of the planet's condition has been adopted recently by Prof. Benjamin Peirce on independent mathematical grounds, and may be regarded as altogether more probable than the old-fashioned but quite unsupported opinion that the planet's condition resembles generally that of our own earth.

**JUPITER AMMON.** See AMMON.

**JURA**, an island off the W. coast of Argyleshire, Scotland, one of the inner Hebrides; area, about 85 sq. m.; pop. in 1871, 761. It is separated from the mainland on the east by the sound of Jura, about 5 m. wide, from the island of Islay on the southwest by a narrow strait 1½ m. wide, and from the island of Scarba on the north by the gulf and strait of Corryvrecken. Its length is 27 m., and its greatest breadth 7 m. On the west the coast line is broken by a narrow deep indentation, called Loch Tarbert, which nearly cuts the island in two, penetrating to within a mile of Tarbert bay on the east. The western shores are bleak and rugged, but the eastern are more pleasing,

having green slopes and a belt of plain. A ridge of rugged mountains traverses the entire length of the island, rising at three points, into high conical peaks, called the Paps of Jura, the highest of which is 2,566 ft. There is little arable land, only 600 acres being under cultivation. Oats, barley, potatoes, and flax are raised, and large flocks of sheep and goats are fed upon the mountains. From 1,000 to 1,200 head of cattle are exported annually. There are excellent slate quarries and a very fine sand for glass making. The island is famous for its red deer, and for remarkable caverns on its E. coast. With some adjacent islands it forms the united parish of Jura and Colonsay.

**JURA**, a range of mountains between Switzerland and France, extending about 180 m. in length, from the waters of the Rhône in the department of Ain on the S. W. to those of the upper Rhine in a N. E. direction. The great valley of Switzerland and the lake of Neuchâtel lie along its S. E. base, and over these from its summits may be seen Mont Blanc and the principal peaks of the Alpine chain. The Jura, like the Appalachian chain of the United States, consists of parallel ridges including narrow longitudinal valleys, along which the rivers flow in one or the other direction, occasionally passing through a break in the mountains into the next valley. In their external form, and the wave-like arrangement of the stratified rocks of which they are composed, the resemblance is still more striking. They occupy a belt of country averaging about 30 m. in width; and the highest summits, which are mostly in the S. part of the range, attain nearly the same elevation as the White mountains in New Hampshire. The principal summits are Crêt de la Neige, Reculet de Téry, Mont Tendre, Dôle, Pié de Marmiers, Chamon, Chasseral, Credoz, and Colomby; the first named of which is 5,653 ft., and the last 5,200 ft. high. The principal strata are limestones of the oolite formation, named the Jura from their abundance in this range, and with them are associated shales and sandstones, including beds of gypsum. The highest summits of the Jura lose their snowy winter covering in the summer, and are then green with dense forests of fir. The growth below is in great part of walnut, groves of which surround almost every village. In the valleys are found some of the richest pasture lands in Switzerland, where are produced the Gruyère and other cheeses famed throughout Europe. Great numbers of cattle are reared and fed on the mountains. The Jura and the intermediate undulating country abound in wooded hills, among which rocky masses project at intervals above the fertile slopes, which by the aid of irrigation yield three crops of grass annually. The most picturesque scenery is presented by the Val Moutiers, or Münster Thal, between Béal and Biemme, the pass of Klaus at the foot of the Ober-Hauenstein, and the lac de Joux.—The name Jura has also a wider application than

mountain range above described; the continuation of the same limestone country through Swabia and Franconia being distinguished as the German Jura, situated between the Rhine and Main, and divided by the rivers Moselle and Altmühl into three parts, viz.: the Black Forest Jura (*der Schwarzwald-Jura*), situated between the Rhine and Danube; the Franconian Jura (*der Schwäbische Jura*), on the east and Altmühl, and designated by various names in various localities, as Ober-Horng, Rauhe Alp, &c.; and the Franconian Jura (*der Fränkische Jura*), between the Altmühl and Main, traversed by the Ludwig's canal and noted for its bone caves.

**JURA**, an E. department of France, in Franche-Comté, bordering on Switzerland and on the departments of Haute-Saône, Doubs, Ain, Saône-et-Loire, and Côte d'Or; area, 1,926 sq. m.; pop. in 1872, 287,684. The name is derived from the mountains which cover two-thirds of the department. The surface presents three divisions, viz.: the western part, consisting of a low plain about 7 m. in width; the first mountain elevation rising suddenly from the plain and forming a plateau nearly level; and the high mountain district, consisting of lofty summits and deep valleys. The highest summits are Reculet, La Dôle, and Poupet, which rise between 5,000 and 6,000 ft. above the sea. Among the numerous rivers are the Ain, Loue, and Doubs, which are the most important. The Bienne is the most important of the smaller rivers. There are many marshes and lakes. The Rhône and Rhine canals cross the N. part of the department, and are several lines of railway. Large quantities of squared timber are floated in the small rivers into the Saône and Rhône to Lyons. The forests abound with oak and pine. Agriculture is highly cultivated, and dairy farming is extensively practiced, one of the chief productions being cheese. The annual production of cheese amounts to 8,500,000 gallons; the best are those of Lons-le-Saulnier and Polignac. Coal and iron mines are worked. Lithographic stone, marble, and alabaster are quarried and there are extensive salt works at Montmorot and Salins. The department is divided into the arrondissements of Lons-le-Saulnier, Poligny, Sainte-Claude, and Dôle.

**JEF, Pierre**, a French theologian, born at Orléans, Dec. 24, 1637, died in Rotterdam, June 11, 1713. He was sent to England to complete his education under his maternal uncle, Peter Du Moulin, and while in England was ordained. He succeeded his uncle in the pastorate of the Reformed church in Rotterdam, and afterward was made professor of Greek and Hebrew at the academy of Sedan.

That institution was suppressed in 1681, and he retired to Rotterdam, where he became pastor of the Walloon church. He passed the remainder of his life there, engaged in

a bitter controversy with friends and enemies, especially Bayle. Jurieu got the better of the philosopher, and caused his dismissal from his professorship. He was the author of various works, highly esteemed in their day, several of which have been translated into English. Among these are: *Histoire du Calvinisme et du papisme* (2 vols., Rotterdam, 1682); *Lettres pastorales* (8 vols., 1686-'7); *Accomplissement des prophéties, ou la délivrance prochaine de l'Église* (2 vols., 1685); *Apologie pour l'accomplissement* (1687); *Tableau du Socinianisme* (the Hague, 1691); and *La pratique de la dévotion* (2 vols., Rotterdam, 1700). His principal work is *Histoire critique des dogmes et des cultes bons et mauvais qui ont été dans l'Église depuis Adam jusqu'à Jésus-Christ* (Amsterdam, 1704; with supplement, 1705; English translation, 2 vols., London, 1705).

**JURY**, a chosen body of men whose duty it is either to judge or determine certain questions of fact submitted to them, or to inquire into the existence of certain alleged facts. Upon the jury a very large proportion of the whole procedure for the trial of actions in England and America rests. Its intrinsic importance has made the inquiries into its early origin and history interesting; and they are the more so, because they are found to be closely interwoven with investigations into the political, legal, and social institutions of many nations. Different writers have come to very different conclusions, perhaps because they began from different points of departure, and viewed their facts under different aspects. In almost all the results thus presented there is some truth; but we apprehend that they have erred in attributing the institution of juries to some one or two only of the many origins from which it has arisen, and the many influences which have combined to give to it its present form in England and in the United States. Its principal source has been found in the *δικαστήριον* of Athens, or in the *judices* of Rome, or in the compurgators of the Saxons, or in the trial by the vicinage of the Romans, or in the Norwegian *Gulathing*. We apprehend that it would be, if not impossible, at least so difficult to determine which among all these things may be considered as having contributed most to form the trial by jury, that the inquiry is not worth the time and labor it costs; for it must end in the conclusion that all have contributed, and importantly, to this result. The essence of the trial by jury is the determination of questions arising in actions at law by a select body of persons, who, without holding permanent judicial offices, come from among the people for this purpose, and, after their work is done, return to them. In Asia we find nothing of this at any time; and nothing of it in history, until the *δικαστήριον* of Athens was regulated if not introduced by Solon. The *dicasts* were a large body of men, numbering some thousands, who were selected or appointed from among the freemen of Athens, in some

way under if not by the archons. From this large body a smaller number was selected, perhaps by lot, for each case, to hear and determine the questions which might arise in that case, under the direction of a presiding archon or other magistrate. Before proceeding to hear any case, they were sworn to discharge their duty faithfully. After hearing the case, they gave their votes by depositing them in urns or vases, from which the presiding magistrate took them and announced the verdict. In this there is much resemblance to the jury of our own day; the principal difference being in the large number who sat in each case, which appears to have been sometimes as many as 500. This body the advocates addressed, beginning their speeches with *Ἀνδρες δικασταί* (as we see in Demosthenes, Æschines, and Lysias), in the same manner as our advocates say, "Gentlemen of the jury." It cannot be doubted, we think, that the judicial procedure of Rome was, to a great extent, derived from and formed by that of Athens. We are accustomed to translate the word *judex* by "judge," but there was no officer or magistrate known to the Romans who discharged precisely the duties which with us belong to the judge; the prætor came nearest to it; but *judex* would be much better translated by the word juryman. When the plaintiff (*actor*) came before the prætor or other magistrate having jurisdiction, he made his complaint, and the defendant (*reus*) answered it. The prætor then referred the case to the judges to determine the facts; usually stating, in this reference, that such or such conclusions of law would follow from such or such conclusions of fact. The number of judges usually sitting is not known, and sometimes even an important case was tried before a single *judex*; as we know that Cicero delivered his oration *Pro Quintio* before one *judex*, assisted by a *consilium*. The judges generally were aided by juriconsults who sat with them. The whole number of persons from whom could be selected the judges of each case was in Rome as in Athens large, amounting to some thousands; but by whom or on what principle it was appointed, or how or by whom the smaller number was appointed for each case, is not certainly known. There was sometimes an agreement of the parties as to the *judex* or judges, who were sometimes called *arbitri*, and who then answered to our arbitrators; and there was a method of objecting to judges appointed by lot or otherwise (*recusatio judicis*), which answered very exactly to our challenges. As we know that, as soon as Rome conquered a province, it introduced at once the provisions and the forms of its own law (its *jura et instituta*), in part perhaps because the province might be thus most effectually bound to the empire, and in part also because they were always better than those of the conquered nation; and as we know therefore that institutions, which resembled in so many particulars our jury, were in full force

in England for more than three centuries, it would seem to be unreasonable to deny them an important influence in creating the trial by jury. But, on the other hand, the Saxons brought into England the trial by compurgators. Then the party accused, or in later times the party plaintiff or defendant, appeared with his friends, and they swore, he laying his hand on theirs and swearing with them, to the innocence of the accused, or to the claim or defence of the party. Little is certainly known either of the origin or of the extent, in point of time or of country, over which the trial by compurgators prevailed; but it must have had great influence upon the subsequent forms of procedure. If in nothing else, it fixed the number of the traverse jury at 12, that being the common number of compurgators, whence the old mediæval phrase *jurare duodecim manu*; and this was a great improvement on the varying and sometimes very large number in Greece and Rome. Besides this, however, recent investigation has shown, among the Norman legal usages, traces of trial by jury, more numerous and more nearly resembling that trial as now conducted, than anything known to have existed among the Anglo-Saxons. Moreover, it is now known that, with much variety of form, modes of trial essentially similar to that by jury prevailed among both the Teutonic and Scandinavian nations, from a very remote antiquity. We regard it therefore as certain that all these influences contributed to establish this mode of trial in England, and to shape it as we know it to exist there. Indeed, it was not until all of them had had an opportunity of completing their work, that we find what we should now call a jury certainly existing. Glanville represents it, in one of its most important forms and purposes, as introduced in the reign of Henry II.; he calls it "a royal benefit conferred upon the people by the goodness of the sovereign, with the advice of the nobility." So many of the attendant circumstances indicate that it was a Norman institution, bestowed upon his English subjects by a Norman king, that Sir Francis Palgrave has not hesitated to consider our jury trial as derived directly from Norman law.—One mistake in regard to a clause in Magna Charta is so common, and perhaps so important, that it should be corrected. The great charter says that no freeman shall be arrested or imprisoned, or exiled, or otherwise destroyed, *nisi per legale iudicium parium suorum, vel per legem terra*. This has been held to mean, "unless by lawful trial by jury," and an argument has been drawn from it against the legality of any conclusive procedure against any person but on the finding of a jury. But the *iudicium parium* of Magna Charta did not mean a judgment or verdict of a jury. Even in Magna Charta itself we read of *juratores*; and the phrase *verdictum legum hominum*, and others by which a jury is indicated, are common in the law language of

day. But the *judicium parium* was the familiar and well known feudal process, by which the lord with his vassals sat to try questions of title between others of his vassals. It is quite probable, however, that the alternative phrase, *per legem terræ*, was intended to indicate trial by jury.—In Greece and Rome, and among the Teutonic and Scandinavian nations, and probably among the Normans, the agreement of a majority of a jury, or of the body which presented a jury, was sufficient; but from the earliest times unanimity has been required in English traverse jury, and also in this country. The origin of this peculiarity is quite unknown. The most plausible conjecture, for which indeed there is some authority, is, that originally there were or might be more than twelve jurymen, but the agreement of that number was required; and when the number of the jury was finally settled down at 12 and no more, unanimity became requisite. There have been, perhaps all ages, doubts whether the advances of this rule were sufficient to compensate the mischiefs which sometimes result from it, but no very strenuous effort has ever been made to change it. In Scotland, however, by Acts 22 and 23 Victoria, the verdict of nine or more of the jurors may be received if unanimity is found impossible after three hours' deliberation.—There is, in respect to the evidence which a jury acts, a circumstance strikingly illustrative of the change which has taken place in the constitution and in the functions of the trial jury. Now, they have nothing to do to hear and weigh the evidence offered to them in open court; and anything beyond this is a departure from their duty; and if one of the number happens to know anything about the facts of the case, he ought not to communicate it to the others, and they ought not to be influenced by it, unless he is sworn as a witness and examined as a witness; so anxious is the law to keep from the jury all evidence which does not rest upon an oath, and has not been admitted to examination. It is however certain, that, in the beginning of jury trials, and in the 15th century, the jury themselves were witnesses, and the only witnesses, they were selected to determine the questions of the case, because they were supposed to know the facts, and no other witnesses being examined, no evidence whatever being offered to them. Nor was it until about the middle of the 16th century that there is any trace of any process known to the law for the summoning of witnesses. (See *Summers v. Mosely*, 2 Npton and Meeson, p. 483.)—As the jury do not pay any attention to any evidence not admitted before them, so they must not go beyond the evidence, and inquire into the law, which is the exclusive province of the court. In civil cases, no one has ever doubted this; and in criminal cases, no one has ever doubted that in civil cases it was the duty of the court to state the law to the jury, and the duty of the jury to obey and obey the law thus given to them.

But of late a question has arisen in regard to criminal trials, which has assumed, at least in many of the United States, an aspect of much importance. There are those who insist that in all criminal cases the juries shall be judges of the law as well as of the fact; and such is the rule by decision in some states and by statute in some others, and it prevails generally in prosecutions for libel by express constitutional or statutory provisions.—Juries are either grand juries or petit juries. Nearly all that has been said in this article relates only to petit juries, which are sometimes called traverse juries, and sometimes trial juries. A grand jury tries no question, and finds no verdict. The proper authority of the state, usually the attorney for the government, brings before the grand jury a case of supposed crime or wrong, with a bill of indictment, and the evidence on the subject. This they consider *ex parte*, or without hearing the accused; and if they think that the evidence is sufficient, they approve or "find" the bill, and present the accused to the court. If they do not think it sufficient, they "ignore" the bill (as it is termed), and no indictment is presented. The usual method of "finding" a bill is for the foreman (whom the jury choose) to write on the back of the bill, "A true bill," with his signature and the date; and when a bill is rejected, the foreman writes upon it: "*Ignoramus*," with signature and date. Sometimes the government attorney prepares no bill, but brings before them the case and evidence, and prepares a bill only when they direct him to do so. The grand jury are the exclusive judges of the weight and force of the testimony offered before them. The grand jury is generally more numerous than the petit jury. The more usual number is 23; originally it was 24, but as unanimity is not necessary, although at least 12 must agree to an indictment, to avoid the inconvenience of having 12 for and 12 against a bill, one less than 24 is the common number. Besides bills of indictment, and specific offenders, the grand jury may present to the court any public wrongs they think should be brought to its notice, and sometimes exercise a wide liberty in this respect. None are present with the grand jury during their deliberations but the officer of the government; and it is a part of their oath that they shall keep secret "the commonwealth's counsel, their fellows', and their own." But there is a reasonable limit to this, for it is no uncommon thing for a grand juror to take the witness stand in a trial of a case, and testify as to what some person has said as a witness before the jury. A grand jury constitute a regular body, recognized as such by the law, having what may be called a jurisdiction coextensive with that of the court to which they make presentments.—Jurors, both grand and petit, are returned by the sheriff of each county (or, for the United States courts, by the marshal of each district), in obedience to a writ, called a *venire*, which com-



mands him to summon to come (*ut facias venire*, in the old law Latin) to the court at the appointed time the proper number of persons. The authorities of every city and town, or sometimes county, put into a box the names of all persons therein, or a certain proportion thereof, qualified and bound to serve as jurors. Usually these are all persons qualified to vote, with some special exemptions. From the number so returned the requisite number for grand and petit jurors is drawn by lot, and the persons so selected are then summoned by the sheriff or marshal. The whole list or schedule of a jury is called the "panel." (In the Scotch law, the word "panel" means the accused, or the party on trial.) The grand jury is "impanelled" when sworn and organized. A petit jury is impanelled when the names are called over, and the first 12 who are present, and are not excused or objected to, are sworn, and set apart as the jury. It is common in most of our courts having much business to impanel two juries; that sitting on the right hand of the court being called "the first jury," and that on the left hand "the second jury." Sometimes, when the urgent pressure of business requires it, a third jury is impanelled. The purpose in impanelling more than one jury is, that while one is charged with a case and is deliberating, another case may be tried before another jury. Upon trials before a jury, the court are the exclusive judges of the admissibility or competency of evidence; but if it be admitted, the jury are the judges of its value. For about a quarter of a century changes of an important nature have been gradually creeping into the system of jury trial in the United States by statutory modifications. One of these very generally adopted is the trial of cases by fewer than 12 in all courts not of record; usually six, but sometimes a still smaller number. One more important, however, is the trial of all questions of fact as well as of law in all civil cases by the judge without a jury, unless a jury is demanded by one of the parties or specially ordered by the court. Where this change has been introduced it is found that in the large majority of cases the parties are satisfied to submit their disputes to the court.—We may remark that the institution of the grand jury certainly existed, substantially the same or nearly the same as at present, among the Saxons; and it is from this grand jury that some suppose the petit or trial jury to be derived; and doubtless this is in some degree true.

**JUSSIEU, De**, a French family of natural philosophers who have been styled the "botanical dynasty" of France. The most celebrated are the following. I. **Antoine**, born in Lyons, July 8, 1686, died in Paris, April 22, 1758. He took the degree of M. D. at Montpellier, and went to Paris in 1708, where he commenced practice, was appointed professor of botany at the *jardin du roi*, entered the academy of sciences in 1711, and contributed several papers to its *Mémoires*,

the most curious of which is perhaps his *Recherches physiques sur les pétrifications qui se trouvent en France de diverses parties de plantes et d'animaux étrangers*. In the course of a journey through southern France and Spain he made a valuable collection of plants previously very imperfectly known. Among his published essays is a *Discours sur les progrès de la botanique* (Paris, 1718). He edited Barrelier's posthumous work on the plants of France, Spain, and Italy, and published a new edition of Tournefort's *Institutiones Rei Herbaria*, with an appendix (Lyons, 1719). His *Traité des vertus des plantes*, a synopsis of his lectures at the faculty of medicine, was published in 1773. II. **Bernard**, brother of the preceding, born in Lyons, Aug. 17, 1699, died in Paris, Nov. 4, 1777. In 1722 he was appointed assistant demonstrator of botany at the *jardin du roi*. A man of contemplative disposition, abstemious habits, and no ambition, he never rose above this subordinate office, but gradually obtained the reputation of one of the first botanists in Europe. In 1725 he edited Tournefort's *Histoire des plantes des environs de Paris*, with additions and annotations, which were considered so valuable that he was made a member of the academy of sciences, although he was only 26 years of age. To its *Mémoires* he contributed very few papers, and these on subjects of secondary importance, but remarkable for precision, ingenuity, and thorough method. He devised a system of classification based upon the natural affinities of plants, and applied it in 1759 to the arrangement of a botanical garden at Trianon, which had been ordered by Louis XV. His catalogue has been regarded as the foundation of the "natural system," afterward expounded by his nephew Antoine Laurent. Linnæus entertained the highest opinion of his acquirements. III. **Antoine Laurent**, nephew of the preceding, born in Lyons, April 12, 1744, died in Paris, Sept. 17, 1836. He was called to the metropolis in 1765 by his uncle Bernard, and studied medicine, but ultimately devoted himself to botany. As early as 1778 he presented to the academy of sciences a *Mémoire sur les renonculacées*, in which the first principles of the "natural system" are clearly perceptible; and the next year he reduced the system to practice in the replanting of the botanical division in the *jardin du roi*. In 1778 he commenced the publication of his great work, *Genera Plantarum secundum Ordines Naturales disposita, juxta Methodum in Horto Regio Parisiensi exaratum, anno 1774*, which was not completed till 1789. To bring together all those plants which are allied in all essential points of structure, and to take into account the true affinities of plants on a comparison of all their organs, is the leading feature of the "Jussieuan system," which has finally superseded the artificial or sexual system of Linnæus. In 1790 he was elected a member of the municipal council of Paris, and intrusted with the supervision of the hospitals and charities, which

office he held for two years. In 1793, when the *jardin du roi* was reorganized as the museum of natural history, he was raised to a professorship, and while director of that institution he laid the foundation of its library, which is one of the best, if not actually the best of its kind in Europe. In 1804 he was appointed professor of materia medica at the faculty of medicine, and life member of the council of the university, but was deprived of both these offices after the restoration. In 1826 his failing health and partial blindness caused him to resign his chair of botany in favor of his son Adrien. From 1804 to 1820 he published in the *Annales du Muséum* a series of valuable papers prepared with reference to a new edition of his *Genera Plantarum*. Besides the works above mentioned, he wrote several historical notices of the museum of natural history, and a number of valuable articles on botany in the *Dictionnaire des sciences naturelles*, among which the one upon the "Natural Method of Plants" deserves special notice. **IV. Adrien**, son of the preceding, born in Paris, Dec. 23, 1797, died June 29, 1853. On taking his degree of M. D. in 1824, he defended a thesis *De Euphorbiacearum Generibus*. He succeeded his father as professor at the museum in 1826, and soon achieved a distinguished rank among botanists by his lectures and publications. In 1831 he was elected to the academy of sciences, and in 1845 was appointed to the chair of the organography of plants at the Sorbonne; his lectures there, which he continued till his death, were both brilliant and attractive. His most important work is a *Cours élémentaire d'histoire naturelle: Partie botanique* (Paris, 1848; translated by I. H. Wilson, "Elements of Botany," London, 1849), which is a most valuable elementary treatise on botany. His treatise on botanical taxonomy, in the *Dictionnaire universel d'histoire naturelle* (1848), is also very valuable. Among his papers printed either in the *Annales du Muséum* or the *Comptes rendus de l'académie des sciences*, one of the best is his *Monographie des malpighiacées* (1843). A very interesting essay, *De la méthode naturelle et des Jussieu*, was published by P. Flourens in his *Éloges historiques*, second series. **V. Laurent Pierre**, cousin of the preceding, born in the department of Isère, Feb. 7, 1792. He was a member of the chamber of deputies from 1839 to 1842, and became known by educational and other popular works, including *Simon de Nantua, ou le marchand forain* (1818), which has been translated into many languages and passed through upward of 30 editions; that of 1860 contained also his *Œuvres posthumes de Simon de Nantua*, for which he received the Montyon prize, and similar honors were accorded by various institutions to the former and other works. New editions of his *Les petits livres du Père Lami* (6 vols.) appeared in 1853, and of his *Fables et contes en vers* in 1864.—His brother **ALEXIS**, a political writer and functionary, born in 1802, died in 1866.

**JUSTE, Théodore**, a Belgian historian, born in Brussels in 1818. He is secretary of the Belgian board of education, and member of many learned societies. His principal works are: *Histoire élémentaire et populaire de la Belgique* (Brussels, 1838; 3d and enlarged ed., 1848); *Histoire de la révolution belge de 1790* (8 vols. 12mo, 1846); *Précis de l'histoire du moyen âge* (5 vols. 12mo, 1848); *Les Pays-Bas sous Philippe II.* (2 vols. 8vo, 1855); *Charles-Quint et Marguerite d'Autriche* (8vo, 1856); *Les Pays-Bas au XVI<sup>e</sup> siècle* (2 parts, 1858-'63); *Histoire du soulèvement des Pays-Bas contre la domination espagnole* (1862-'3); *Histoire des États généraux des Pays-Bas* (2 vols. 8vo, 1864); *Les fondateurs de la monarchie belge* (1865 and 1871); *Le soulèvement de la Hollande en 1813, et la fondation du royaume des Pays-Bas* (1869); and *Notes historiques et biographiques* (1871).

**JUSTI, Karl Wilhelm**, a German author, born in Marburg, Jan. 14, 1767, died there, Aug. 7, 1846. He was professor of theology at Marburg, wrote the *Nationalgedänge der Hebräer* (5 vols., Leipzig, 1808-'18), published an enlarged edition of Herder's *Geist der Ebräischen Poesie* (2 vols., 1829), several historical and miscellaneous writings, including a life of St. Elizabeth, and some volumes of poetry.

**JUSTICE OF THE PEACE.** In the English law, justices of the peace are "judges of record appointed by the king's commission to be justices within certain limits, for the conservation of the peace and the execution of divers things comprehended within their commission and within divers statutes committed to their charge." Before the institution of this office there existed in England by the common law certain officers appointed for the maintenance of good order, and called *conservatores pacis*, keepers of the peace. Some of them exercised their functions by virtue of their tenure, and some by virtue of their offices; others were chosen by the freeholders of their counties. The period at which this office ceased, and justices of the peace were first created, has been disputed; but the better opinion seems to fix it at the beginning of the reign of Edward III. At that time the now king, fearing that some risings or other disturbances might take place in protest against the manner of his accession to the crown, sent writs to all the sheriffs in England commanding that peace be kept throughout their bailiwicks on pain and peril of disinheritance and loss of life and limb; and in a few weeks after the date of these writs it was ordained in parliament that, for the better maintaining and keeping of the peace in every county, good men and lawful which were no maintainers of evil or barrators in the county should be assigned to keep the peace. (Black. Com., i. 350.) From that time the election of the conservators of the peace was taken from the people, and their creation resided thenceforth in the assignment of the crown. It was only, however, by subsequent statutes that the

conservators of the peace acquired a judicial character and functions. By 4 Edward III. c. 2, they were empowered to "take indictment," and by 34 Edward III. c. 2, they were commissioned to "hear and determine" in cases of felonies and trespasses. It is probable that not until then were these officers called justices. The office, as constituted and defined by these and later statutes, occupies an important place in the English judicial system. It was adopted in the several states of this country at their settlement, and may be considered to possess here the general character and functions allowed to it in England by force of statutes. But it is to be remarked that in all the states legislative enactments have so fully enumerated the powers and duties of justices of the peace, both in civil and criminal affairs, as perhaps to preclude reference to the English law on the subject.—Justices of the peace are in some states elected by the people, and in others receive their appointment from the executive. Their jurisdiction is determined by their commissions and the provisions of various statutes. These are to be strictly construed, and no authority can be implied. Without attempting a recital of all the particular functions exercised by these officers, it will suffice for our present purpose to mention, under their criminal jurisdiction, that when they are not limited by the existence of special courts, they possess still their ancient common law powers as conservators of the peace, and as such may suppress riots and affrays and apprehend all disturbers of the peace. Then they may punish them by fine, and take recognizances for their future good behavior. By virtue of their criminal authority they may also issue their warrants for the arrest of offenders. If the offence be a trifling one, they may themselves determine in the matter. If, however, it be of an aggravated nature, they commit or bind over the criminal for trial in a regular court. They may judge in civil suits when but a small amount is involved, but not generally in cases of libel, slander, or malicious prosecution, or when title to real property comes in question. As further examples of their usual powers, it may be added that they may issue summonses for witnesses to appear in their own courts, and to answer in civil suits pending before other courts; they may administer oaths in all cases in which an oath is required; they may celebrate marriages; and may make examinations and issue warrants in cases of bastardy. They also exercise certain functions under the poor laws. The justice must have jurisdiction of the parties and of the matter, or his interference is a trespass. But when he acts within his jurisdiction and by color of his office, he is responsible in a civil suit only when he has acted from corrupt or malicious motives. He may be impeached, and in some states removed by petition and hearing of the charges made against him before a higher court. A justice must keep a record of his proceedings, and may ad-

journal his court from day to day. The pleadings before him are, for the benefit of suitors, treated with great liberality.—In the decree for the reorganization of the judicial system of France (Aug. 24, 1790) *juges de paix* were created in imitation of the English officers of the same name. They were to decide summarily, without expense to suitors and without the intervention of counsel, affairs of slight importance, and especially those which involved disputed facts rather than contested points of law. The decree of September, 1791, concerning criminal procedure, invested the *juges de paix* with police functions; at a later period they were called to the presidency of those police tribunals which took cognizance of minor offences. Under the law of May 25, 1838, the French justices are empowered to decide finally in all causes purely personal, and involving no more than 100 francs, but subject to appeal in all such causes involving from 100 to 200 francs. With similar limitations they have jurisdiction in actions between landlords and tenants; in suits for damages to fields, fruits, and harvests; between laborers and their employers, and between servants or apprentices and their masters; and in civil suits for verbal defamation, and in those breaches of the peace and assaults which are not expressly provided for in the criminal law. Their decrees are subject to appeal in all possessory actions, in cases involving questions of boundaries, and in those arising out of the use of mill privileges and streams applied to irrigation. As officers of the judicial police and auxiliary to the prosecuting officer of the government (*procurateur du roi*) they receive informations and make examinations into charges of flagrant crime committed within their jurisdiction.

**JUSTIN (FLAVIUS ANICETUS JUSTINUS).** L. The Elder, Byzantine emperor, born of a family of barbarian peasants at Tauresium, a village near Sardica (now Sophia), in Bulgaria, in 450, died in 527. He went with two other youths on foot to the capital to enter the army, and on account of his strength and stature was placed among the guards of the emperor Leo I. Under the reigns of Zeno and Anastasius he emerged to wealth and honors. Having served in the Isaurian and Persian wars, and been promoted successively to the ranks of tribune, count, and general, and the dignity of senator, he was commander of the imperial guards at the time of the death of Anastasius (518). The eunuch Amantius, who then reigned in the court, being bent on setting one of his creatures, Theodatus, on the throne, intrusted an ample donative to Justin, with which to gain the suffrage of the guards for his purpose. Justin employed the bribe in his own favor, and was proclaimed emperor at the age of 68. Brave, but ignorant, according to Procopius, even of the alphabet, he intrusted the *questor* Proclus with the affairs of the state, and adopted Justinian, his nephew, and a native of his village, who, however, was educated in Constantinople.

are some dark stains on Justin's character. Amantius was executed on charges of racy and heresy, Theodatus was murdered in prison, and Vitalian, a Gothic chief, had become popular by his civil war. Anastasius in defence of the orthodox was treacherously murdered at a banquet.

Both Justin and his successor Justinian (part of his reign) were defenders of the orthodox creed. II. The Younger, nephew of Justin I., succeeded him in 565, and died in 578. He was of a very crafty disposition while his cousins Justin and Justinian, sons of Germanus, were absent in the East. In the East, against the Persians, he remained in Constantinople and courted the aged emperor. Justinian, assuming the imperial authority after the death of Justinian, he won popular favor by his repression of virtuous and generous sentiments. He granted a general pardon to offenders and liquidated all the debts of Justinian, and issued an edict of universal religious toleration. Justinian soon showed his true character. He ordered the murder of his cousin Justin, of whom he had become jealous, sold offices and lands without disguise, and recovered by rapacity and oppression the sums used in satisfying the creditors of his predecessor. While Justinian was thus arousing the indignation of the people at home, Italy was in a deplorable state. Justinian, who had been removed from the East through the hatred of the empress Sophia, re-vengeed himself by inviting an invasion of the Longobards, who overran the country. At the same time Justin was involved in a war with the Persians, who ravaged Syria and Arabia. On the receipt of this news he exhibited symptoms of insanity, and the government devolved on the empress Sophia, who deposed the emperor (574) to adopt Tiberius, captain of his guards. The latter became eventually the ruler from that time, although Justinian did not create him Augustus until September, 581.

JUSTIN (JUSTINUS), a Latin historian, of whose personal history nothing is known. It is probable that he lived at Rome in the 3d or 4th century. He is the author of a work entitled *Historiarum Philippicarum Libri XLIV.*, based on a lost work of Trogus Pompeius, a historian of the Augustan age. The original, though professing to give only an account of the Macedonian monarchy, was hardly more than a universal history, and was of great value.

Justin seems rather to have compiled his work from more than to have abridged it systematically, and his history contains a great variety of information that would not otherwise have been preserved, carelessly arranged, but written in a clear and sometimes elegant style. The first edition of Justin was printed at Venice by Jensen in 1470. The latest editions are of Gutschmid (Leipzig, 1857), Hartwigswick, 1860), Pierrot and Boitard (Paris, 1865), and Domke and Eitner (Breslau, 1865). English translations are by Codrington

(1664), Brown (1712), Bayley (1732), Clark (1732), and Turnbull (1746).

JUSTINIAN. I. (FLAVIUS ANICIUS JUSTINIANUS), surnamed the Great, a Byzantine emperor, born at Tauresium, a village near Sardica (now Sophia), in Bulgaria, in 482 or 483, died Nov. 14, 565. He was the son of a poor barbarian family, but his elevation was promoted by his uncle Justin I., who shortly before his death in 527 adopted him as co-emperor at the request of the senate. Justinian, who had effectively and unscrupulously promoted his uncle's elevation, was possessed long before the decease of the latter of all power in the state, as well as of a large private fortune. He shared both his power and wealth with Theodora, a beautiful, crafty, and unscrupulous woman, the daughter of a keeper of wild beasts, who had been long known as a comedian and prostitute, and despised by the people of the capital as one of the vilest of her sex. Having married her in spite of all opposition, he not only seated her on his throne, but made her an equal colleague; and her demoralizing, corrupting, and despotic influence remained powerful till her death in the 22d year of their reign. In the questions of creed in the church and of color in the games of the charioteers in the hippodrome, then distracting the empire, Justinian and his wife were agreed in zealously supporting the orthodox and the blue parties. In the capital and most of the provinces heresy was totally powerless, but the faction of the greens was often able to resist by open violence the arrogance of their opponents and oppressors. In 532, after a fierce contest between the factions, in which Constantinople was almost laid in ashes, they momentarily combined their forces against the government, and proclaimed Hypatius, a nephew of the emperor Anastasius, emperor. The resolute spirit of Theodora and the bravery of Belisarius triumphed. The blues returned to allegiance, the greens were crushed with dreadful slaughter, Hypatius and his principal accomplices were executed, and tranquillity was restored. Justinian now turned his chief attention to the external interests of his vast empire. Purchasing at an immense sum a truce from Chosroes I. of Persia, after a war of a few years waged with varying success, he sent Belisarius with a fleet and an army against Gelimer, who had usurped power in the kingdom of the Vandals of Africa, and as an Arian ruler oppressed his Catholic subjects. A series of victories soon brought Carthage and the person of Gelimer himself into the power of the Byzantines. Gelimer was sent a captive to Constantinople, the kingdom of the Vandals destroyed, and the Arian worship suppressed. The conquest of the province of Africa and the adjoining provinces procured new influence and some strong stations in Spain, and paved the way for the reestablishment of the Roman imperial power in Italy, where Theodatus had succeeded (535) the regent Amalasontha, who usurped the

power on the death of her son Athalaric, the profligate grandson of Theodoric the Great. Belisarius successively reduced Sicily and conquered Naples; Theodatus was deposed by his people and assassinated; and Rome opened its gates to the army which fought in its name (536). In 539 Ravenna was reduced, but Justinian from envy recalled the conqueror. Chosroes, king of Persia, was driven from Syria in 541, and Belisarius, after a short period of disgrace, was again sent into Italy to prevent the capture of Rome by Totila. The attempt to relieve it was unsuccessful, and Belisarius was finally succeeded in the command by Narses. In 552 Justinian once more received the keys of the ancient capital, which in his reign had been five times taken and recovered. Totila had fallen in the battle of Tagina, and his successor Teias, the last of the Ostrogothic kings, shared the same fate on the Sarnus in the following year. Another great victory of Narses over the Franks and Alemanni, who then invaded Italy, secured the possession of that country, which he governed as exarch, residing in Ravenna. In the East, Justinian terminated a protracted war with the Persians by a peace (561), in which Chosroes extorted the ignominious promise of an annual tribute. The northern frontiers of the empire were in part secured against the invasions of the barbarians by similar treaties, and a vast line of fortifications, especially along the Danube, was added from a feeling of precaution which the degeneracy of the empire made but too natural. The imperial armies themselves consisted mainly of barbarian hirelings. In the interior the reign of Justinian was marked by tyranny, extortion, and lavish expenditure, especially in the erection of sumptuous buildings, of which the rebuilt church of St. Sophia was the most magnificent; by a continual meddling in the affairs of the church, and the severe persecution of heretics, Samaritans, Jews, and pagans, involving the dissolution of the Athenian school of philosophy; and by uninterrupted intrigues at the court, which, among others, finally succeeded in ruining Belisarius. Justinian, however, who was fond of studies as well as of arts, has the great merit of having, through Tribonian and other lawyers, prepared that code of Roman laws which bears his name and is the great monument of his reign. (See CIVIL LAW.) The introduction of silkworms from China through some missionaries, who brought the eggs in hollow sticks, is another of its lasting merits. Justinian was patient, frugal, and diligent, but vain, selfish, and ungrateful. "He was neither beloved in his life nor regretted at his death." He was succeeded by Justin II., his nephew. II. Surnamed *Κνηχιόμαρτος* (Shorn Nose), a Byzantine emperor, born in 669, died in December, 711. He succeeded his father Constantine IV. (Pogonatus) in 685. His reign was marked chiefly by wars with the Saracens, persecutions of the Manichæans, and the rapacity and exactions of his ministers. In 688 he

broke the peace which his father had made with the Bulgarians, and, although at first successful, was finally routed by them in the defiles of Mount Rhodope, and narrowly escaped with his life. The Arabs, equally provoked, invaded Africa and ravaged Cyprus, subsequently overran Asia Minor and Mesopotamia, and conquered Armenia. In 695 his general Leontius drove him from the throne, cut off his nose, and banished him to the Crimea. Leontius was soon after deposed by Tiberius Apsimerus, who reigned seven years. In 705 Justinian recovered his throne through the assistance of the Bulgarians, and put to a cruel death Leontius and Tiberius, and many others. His atrocities at last aroused a new rebellion, and he was dethroned and killed by Philippicus Bardane, who succeeded him.

**JUSTIN MARTYR** (**FLAVIUS JUSTINUS**), the earliest of the church fathers after the apostolic age, born at Flavia Neapolis (the modern Nablus), in Samaria, about 105, died in Rome about 165. His parents were Greeks who had joined the colony sent by Vespasian to the desolated city of Shechem, which was now called after him Flavia. He appears to have been educated in the schools of Asia Minor, Greece, and Egypt, and to have studied first under a Stoic, whose teaching on the nature of God left him unsatisfied. He then attached himself to a Peripatetic, who disgusted him by his greed for money; and, unwilling to undergo the mathematical course exacted by the Pythagoreans, he finally embraced the Platonic philosophy. The objections raised by an aged Christian against its doctrines led him to study the Old Testament writings, and the heroism of the Christian confessors and martyrs induced him to profess Christianity (about 132). He appears to have continued to wear his philosopher's mantle after his conversion. About 145 he composed a polemical work against heretics, particularly against Marcion. During the persecution of Antoninus Pius he addressed a first plea (*ἀπολογία*) for the Christian cause to that emperor and the Roman people. About 150 he met, probably at Ephesus, but according to some at Corinth, with a learned Jew named Tryphon, who was attracted by Justin's philosophical garb, and had a discussion with him on the divinity of the Christian religion, which was soon afterward published. The persecution of the Christians being renewed under Marcus Aurelius, Justin addressed to that emperor a second and supplementary plea. At this time his usual residence appears to have been at Rome; and his zeal in unmasking the hypocrisy of one Crescentina, a prominent persecutor of the Christians, is thought by Eusebius to have been the occasion of his imprisonment and death. Besides the two "Apologies" and the "Dialogue with Tryphon," the authenticity of which is generally acknowledged, three other works have been attributed to him, an "Address to the Greeks," an "Admonition to the Greeks," and

a "Letter to Diognetus" on the characteristics of the Christian worship compared with paganism and with Judaism. His feast is celebrated by both the Latin and Greek churches. The principal editions of his works are those of Robert Stephens (Paris, 1551, completed by Henry Stephens, 1592 and 1595); Friedrich Sylburg, with a Latin translation (Basel, 1565); and Prudent Maran (Paris, 1742). The best modern collection of all his works, with the acts of his martyrdom, is found in the first five volumes of Otto's *Corpus Apologetarum Christianorum Saeculi Secundi* (Jena, 1842; 2d ed., 1847-'50). His apologies were translated into English by William Reeves ("The Apologies of the Christian Fathers," London, 1709), and they are also included in a collection of translations published at Cambridge (2d ed., 1851); his "Dialogue with Trypho" by Henry Brown (London, 1755; new ed., Cambridge, 1846).—See *Justin der Märtyrer*, by Karl Semisch (2 vols., Breslau, 1840-'42; translated into English by J. E. Ryland, Edinburgh, 1843); "Some Account of the Life and Writings of Justin Martyr," by Bishop Kaye (London, 1836); and *St. Justin, philosophe et martyr*, by L. Aube (Paris, 1861).

**JUTE**, the fibre of *corechorus capsularis* and other species; the name is also applied to the plant which furnishes the fibre. The genus *corechorus* belongs to the order *tiliaceae*, of which the linden or basswood is a familiar representative; the species furnishing the fibre are annuals, natives of Asia, and grow about 10 or 12 ft. high. *C. capsularis* has straight stems about as large as the little finger, branching only near the summit; the lanceolate leaves



Jute (*Corechorus capsularis*).

are about 6 in. long, nearly 2 in. broad at the base, sharply serrate on the margin, with the lower serrature on each side prolonged into a thread-like point; the yellow flowers have five sepals and petals, numerous stamens, and a single pistil which becomes a globular, flat-

topped capsule. Another species, *C. olitorius*, has a general resemblance to the preceding, but differs in its fruit, which is cylindrical, and about 2 in. long; its specific name has reference to the use of the young shoots as a pot herb, for which purpose the plant is cultivated in Egypt and Syria, and has thus become naturalized in most parts of the East as far as the Mediterranean. It is known as the Jews' mallow, and yields a portion of the jute fibre. The fibre is contained in the bark of the stems, which are cut when the plant begins to blossom, as it is then of finer quality than when the plant is older; the stems are macerated in water until the fibre readily separates; the latter is from 8 to 12 ft. long, appearing like hemp, but much more soft and silky; it is capable of minute subdivisions, and when used with silk in the manufacture of cheap fabrics it readily escapes detection. Jute does not stand exposure to the weather, and hence is not suited for the manufacture of cordage; yet it is said to be sometimes mixed with hemp for this use, and can only be regarded as an adulteration. Coarse cloth, like burlaps, matting, and cheap carpeting, are made of the fibre; and when large *chignons* were in vogue, no considerable quantity of jute was consumed in the manufacture of "switches." The great use for the fibre, however, is in the manufacture of the coarse bagging known as gunny; bags made of this are largely used in packing rice, coffee, and other eastern merchandise for shipment, and they are scarcely less in demand in this country for the transportation of our agricultural products. Cotton is largely baled in gunny cloth, and as it requires seven yards to the bale, the consumption for this product alone is very great. In India the spinning of the fibre to form gunny twist is done by men, women, and children, the material being kept at hand, to occupy the spare moments of the household; and boatmen and others who are likely to have intervals of leisure engage in the occupation. Jute butts, which are the thick ends of the stems, about 9 in. long, are used for paper making, and are also worked into a coarse fabric; the refuse fibre as well as old gunny bags furnish stock for the manufacture of coarse paper. The value of jute and its various products imported into the United States in 1873 was nearly \$4,500,000. The experiments in jute culture that have been made in some of the southern states show that fibre of a fine quality can be produced there, and there can be little doubt that when proper relations are established between producer and manufacturer, this will become an important item in our agriculture. In California, where the demand for bags to transport the immense grain crops is large, the experiments in raising jute have been encouraging. In India, the stems after stripping are utilized for making enclosures to gardens, for coarse basket work, and even for producing a fine charcoal for gunpowder and fireworks.

**JUTLAND** (Dan. *Jylland*), an irregular peninsula, forming a province of the kingdom of Denmark, lying between lat. 55° 18' and 57° 45' N., and lon. 8° 5' and 10° 57' E., bounded N. by the Skager Rack, E. by the Cattegat and the Little Belt, S. by Schleswig, and W. by the North sea; area, 9,738 sq. m.; pop. in 1870, 788,119. It is the main part of the ancient Cimbric Chersonese, and the country of the Jutes. The Jutes were a Germanic or Scandinavian tribe, of whose presence in this quarter we have evidence as early as the 8th century. According to Mannert, they were identical in race with the Guthi of Ptolemy, and came from the opposite Scandinavian coast. They were the earliest Teutonic invaders of Britain after the departure of the Romans. Jutland is divided into four districts called *Stifte*: Aalborg in the north, Aarhus in the east, Viborg in the centre, and Ribe in the south and west. The capital is Viborg. The N. and part of the W. coast are low, flat, and sandy, presenting long lines of dangerous banks, broken on the west by several large fiords which may be said to form lagoons. The E. shores are more rocky and have some good harbors. The Liim or Lym fiord entirely insulates the N. part of the peninsula. There are many ponds and marshes scattered over the surface, but few rivers. The largest streams are the Guden, which flows into the Cattegat, the Lonborg, which enters the Ringkøbing fiord, and the Konge, which partly separates Jutland from Schleswig. There are no mountains, and the hills are little more than accumulations of sand, seldom exceeding 100 ft. in height. The Himmeljberg, the highest point, is only 550 ft. above the sea. The soil on the east and west is fertile, but the central districts are sandy and sterile, and the N. coast is covered with drifting sands, which are planted with reeds to prevent them from being borne by the wind over the cultivated lands. On the east there are considerable forests of oak, fir, and birch, but the province has been nearly stripped of its timber, with which it was covered in the 11th century. Agriculture is in a very low state, but efforts have been made with some success to improve it. The chief products are corn, hemp, flax, and tobacco. The climate is temperate but variable, with frequent fogs and rains. The industry of the inhabitants is directed chiefly to husbandry, the coast fisheries, and domestic manufactures. There are manufactories of woollen goods, firearms, and earthenware. Commerce is active, and is much facilitated by the long fiords. The principal commercial emporium is Aarhus, which is connected by railway with Viborg, Hølstebro, Aalborg, and Veile.

**JUVENAL** (*JUVENALIS*), *Decimus Junius*, a Roman satirical poet, flourished in the latter part of the 1st century A. D. and in the first quarter of the 2d. The only certain facts in his personal history are that Aquinum was either the place of his nativity or his chosen residence, and that he was an intimate friend of Martial,

who addresses him in three of his epigrams. According to the oldest memoir of him, ascribed with little probability to Suetonius, he was either the son or the *alumnus* of a wealthy freedman, occupied himself till middle age as a pleader, and was led to devote himself to satirical composition by the success of some verses which he wrote upon a pantomimist named Paris; after much hesitation he recited his satires before numerous audiences, which were received with so much favor that he ventured to insert in one of them his attack on Paris; this was construed into an attack on an actor at that time in high favor at court, and he was therefore, although 80 years of age, appointed to command a cohort of infantry in Egypt, and soon died of vexation and grief in this honorable exile. The pantomimist Paris, a favorite of Domitian, was put to death in A. D. 83; and as it is established that one of the satires of Juvenal was written not earlier than 96 and another not earlier than 100, he could not have been sent to Egypt in the lifetime of Paris, unless he afterward returned, in which case it is strange that his works contain no allusion to his exile. The story of his banishment is therefore questioned by some critics. Juvenal disputes with Horace the honor of being the greatest Roman satirist. Living amid the vices of a declining state, under the tyranny of Nero and Domitian, and seeing the humiliation of his countrymen, his compositions are much more purposely and formally severe than the easy and good-humored satires of Horace. Each of them is an elaborate and sonorous piece of declamation, which confirms the statement of some of his biographers that in youth he diligently attended the schools of the rhetoricians, and that he was accustomed to declaim at the forum during many years of his life. His extant works are 15 satires, and a fragment of doubtful authenticity, all in heroic hexameters. There are numerous very early editions, six of which may claim to be the *princeps*. Among the most complete editions are those of Ruperti (Leipzig, 1819), Heinrich (Bonn, 1839), and Otto Jahn (Berlin, 1851). Jahn holds that only the first 9 satires and the 11th are Juvenal's, and that these contain many interpolations; see also Ribbeck's *Der echte und der unechte Juvenalis* (Berlin, 1865). The English metrical translators are Holyday, Stapleton, Dryden (of five satires), Gifford, Hodgson, Badham, and Evans; there is also a literal prose translation, with notes, by J. D. Lewis (London, 1873).

**JUXON**, William, an English prelate, born in Chichester in 1582, died June 4, 1663. He was educated at the merchant taylors' school, and at St. John's college, Oxford. Originally destined for the law, he studied theology, and became vicar of St. Giles's, Oxford, in 1609, and rector of Somerton in 1614. He was president of his college in 1621, and vice chancellor in 1626 and 1627. He became successively dean of Worcester and prebendary of Chichester,

of Hereford, and in the same year, 1633, of London. In 1635 he was appointed high treasurer, but in 1640 earnestly so leave to resign the office, and returned charge of his diocese. He was attached king, whom he attended in the isle of

Wight, at his trial, and to the last upon the scaffold. After the king's execution he was deprived of his bishopric, and imprisoned for refusing to disclose his last conversation with the king. After the restoration he was made archbishop of Canterbury (1660).

## K

THE 11th letter of the Phœnician and other Semitic graphic systems, named hollow of the hand), is also the 11th of glish and many other European alphabets, h the letters preceding it do not exact- cide in both systems. It is the 10th ) in Greek. In ancient Latin, as long as used as the sign of G, it was the 9th; er the innovation of C for the hard gut- n all positions, and the introduction of s corresponding soft guttural, it became h letter, though used only in a few ab- ions, such as K. for *Caso*, *kal*. for *ca- &c.* It is erroneously said to be the some modern Latin grammars. Sallust, marian of Rome, attributes its introduc- to the Latin to one Salvius. Quintilian it a place in the Latin, and blames its n before *a*, as in *kalenda*, *kalumnia*, h it was burnt in upon the forehead of ers. It was represented by *qu* in an- rench, in all positions, though in modern only in *que* and *qui*; while in the same re the K is maintained only in a few for- rds, and in proper nouns. The sound produced like that of G, with this dif- , that the larynx does not oscillate du- e sudden explosion of the sound.—Some nouns are written either with K or C; instance, in German, Carl, Cöln, or Karl, or in French, Coran, Colocotroni, or Ko-. In German, *ck* is written for *k* (in it is pronounced *tsk*, as in Potocki), and ial *k* before consonants is frequently the ed particle *ge* deprived of *e*, as in the *Knecht*, servant, from *ge-neigt*, bent, to; and *klug*, prudent, from *ge-lug*, out.—As a numeral sign, K denotes 20 Semitic, Greek, Georgian, and Cyrillic nce in the Russian) systems; 40 in the tic; 60 in the Armenian; 250 (along ) in the period of Rome's decline. A ver it raises these values to as many ds. In rubrication it marks 10, the *j* ing counted. On Roman coins and nonuments it stands for *Kaisar*, *Kar- laput*, and many other words beginning *r* in the later Latin. On French coins nates Bordeaux; on those of Austria, K. ify Körmöcz-Bánya or Kremnitz mine.

**KA**, or **Caaba**. See MECCA.

**KALAH**. See CABALA.

**KILES**. See ALGERIA.

**KAF**. See CAF.

**KAFFA**, or *Kafa*, a country of E. Africa, lying S. of Abyssinia and W. of Somauli. It consists of an extensive table land, between two branches of the river Gojeb or Godafo, at an elevation of about 5,000 ft. above the sea. The country is under the sway of an absolute king, or *tata*, who it is said can raise 10,000 horse- men, and who is frequently at war with his neighbors. The inhabitants are of an Aby- sinian type, and profess to be Christians; their language belongs to the Hamitic group of tongues. They cultivate the soil, which is fer- tile in palms, cotton, and coffee. The staple food of the people is the *ensete*, a plant resem- bling the banana. The cereals are not raised, and the appellation of "grain-eater" is used as a term of contempt. Trade is carried on with the merchants of Enarea, who exchange rock salt, copper, horses, cattle, and silks for coffee, cotton, and slaves. Coffee, which is supposed to have received its name (Turk. *kahve*) from this country, is indigenous, as is a species of tea plant called *khat*. The brothers Abbadie, in 1843, were the first Europeans who pene- trated into the country. The chief town is Bonga, lat. 7° 12' 30" N., lon. 36° 4' E.; it contains 6,000 or 7,000 inhabitants.

**KAFFA**, *Caffa*, or *Feodosia* (Theodosia), a sea- port of S. Russia, on the S. E. coast of the Crimea, 60 m. E. by N. of Simferopol; pop. about 10,000, exclusive of the garrison. It is built on a wide, open bay of the Black sea. The inhabitants, consisting of Russians, Tartars, Greeks, Armenians, Germans, and Jews, are mostly engaged in fishing and the manufacture of salt. Caviare is made there. Wool and hides are exported. It is the seat of a Greek archbishop, and has, besides Greek churches, a Roman Catholic church, two synagogues, two mosques, a public library, museum, botanic garden, theatre, custom house, and quarantine buildings. It is near the site of ancient Theo- dosia, which was founded by the Milesians, and was one of the towns of the ancient king- dom of Bosphorus. The Genoese established a colony here in the 13th century, and its com- merce became so important that the Italians called the Crimean peninsula "Isola di Caffa." In the 14th century it was surrounded by for- midable fortifications, the remains of which are still to be seen. The Turks captured it in 1475, and although it declined under their rule



in the middle of the 17th century, it had a population of 80,000, and 400 ships were to be seen in its harbor. It was taken by the Russians in 1770, and was ceded to them by the



Kaffa.

treaty of Jassy in 1792. Recently the place has obtained considerable importance for its sea bathing, and it is a favorite resort of the higher classes of Simferopol.

**KAFFRARIA**, or *Kaffirland*. See **CAFFRARIA**.

**KAFFRISTAN**, a country of central Asia, lying between lat. 35° and 36° N., and lon. 69° 20' and 71° 20' E., bounded N. by Badakhshan, E. by Chitral, and S. and W. by Cabool; area, about 7,000 sq. m.; pop. unknown. The surface is very rugged, and the climate exhibits great extremes of temperature. In the north the snow-crested spurs of the Hindoo Koosh range divide the country into narrow valleys and rocky chasms, which form the beds of torrents; but in the south it is more level. There are no roads but narrow foot paths, and the two passes through the mountains into Badakhshan are open only during the summer months. This wild and almost inaccessible region derives its name from the epithet *kaffirs* or infidels applied by the surrounding Mohammedans to its people. They assert that they are descendants of the troops of Alexander the Great, and differ in features, customs, and creed from the neighboring tribes. They are fair in complexion, blue-eyed, of regular features, intelligent, social, kind, and hospitable. They believe in one God, but worship various intercessory idols. Their language is a dialect of the Persian. Domestic slavery is practised, the slaves being sometimes those taken in feuds with hostile tribes and sometimes orphans of their own tribe. In the working of metals, which abound in their mountains, they exhibit much skill, and their silver drinking cups are often of elaborate and tasteful designs. They are almost continually at war with their Moham-

edan neighbors, who like annual incursions into their territory for slaves. Their weapons are bows and barbed arrows, which are sometimes poisoned, and for close combats and knives; but they have recently begun to use firearms. The principal occupation is the raising of cattle and sheep, of which herds are fed in the hills. In the valleys raised wheat and millet, and various kinds of fruit, particularly grapes. They make excellent wine, and both sexes indulge in it to excess. Their chief amusement is dancing to the music of the ppy and tabor. It is not known that they have any regular government, nor have they any general name for their nation; but they are divided into tribes, and all matters affecting the common welfare are settled by consultation among the chief men. They are sometimes distinguished as black Kafirs and white Kafirs, from peculiarities in their costume, the former being clad in black goat skins with the hair outside, the latter wearing a dress of white cotton.

**KAGOSHIMA**, or *Kagoshima*, a town of Japan, in the S. part of the island of Kyushu, renowned for its landlocked harbor, 40 m. long and from 10 to 12 m. wide at the upper part, and about 5 m. at the entrance. Kagoshima is the capital of the feudal prince Satsuma, and it was bombarded in 1863 by the English, to whom reparation had been denied for the murder of Mr. Richardson, a British subject. Three of Satsuma's steamers were sunk during the engagement, and much damage was inflicted upon the town before the prince submitted to pay an indemnity of £25,000, and to execute the murderers. The fortifications have since been repaired, and the manufactory of arms and munitions has been restored.

**KAHLENBERG**, a mountain of Austria, on the Danube, between Vienna and Klosterneuburg, consisting of the Kahlenberg proper, or Josephsberg, and the Leopoldsberg, and rising to a height of about 1,000 ft. above the river. It is also known as the Wiener Wald, and is the most N. E. continuation of the North Alps. On the Leopoldsberg is a ruined castle, with a church where Charles of Lorraine, Sobieski, and other warriors prayed for success in the battle against the Turks, in September, 1683. At the foot of the same mountain, 6 m. above Vienna, is the *Kahlenberger Dörfel*, associated with the humorous priest Wigand (*der Pfaff*)

from *Kahlenberg*), who is said to have lived here in the first part of the 14th century.

**KAHNIS, Karl Friedrich August**, a German theologian, born in Greitz, Dec. 22, 1814. He studied at Halle, graduated in Berlin, and became professor in Breslau, and in 1850 in Leipzig. He was regarded as a leader of the orthodox Lutherans until the publication of his *Lutherische Dogmatik* (2 vols., Leipzig, 1861-'4), which placed him in antagonism with the views of Hengstenberg and other orthodox theologians, and in nearer relation with the Reformed church. His works are numerous.

**KAJETEER FALL.** See GUIANA.

**KAIRWAN, Kairwan**, or *El Kirwan*, a city of Tunisia, Africa, 80 m. S. of the city of Tunis; pop. estimated at 15,000. It is situated on a height commanding a large sandy plain, and is surrounded by a crenellated wall having four gates. It is well built and contains many elegant structures, including numerous mosques and tombs of marabouts. The Akbar mosque is a magnificent edifice, covering nearly the whole of one of the quarters. Its roof is supported by 312 columns of marble, granite, and porphyry, of the Roman period. The town is badly supplied with water, the main dependence being a capacious open reservoir of Saracenic origin, called the cistern of Ibrahim ben Aglab, a polygon of 64 sides, each of six yards. Kairwan was founded by the Arabs about A. D. 670, and was from 802 to 970 the capital of their independent African dominions. It is regarded by the Mohammedans as the most holy city of Africa, and no Christian or Jewish merchant is permitted to take up his residence there. According to Arabian historians, its population was once 60,000. It is noted chiefly, in a commercial point of view, for the manufacture of yellow morocco boots and slippers.

**KAISARIYEH**, a city of Asia Minor, capital of a district of the same name, in the vilayet and 160 m. S. E. of the city of Angora; pop. variously estimated from 25,000 to 50,000. It is situated in a recess of the Arjish mountains, at an elevation of 3,200 ft. above the sea. An extensive plain, watered by the river Kara-su, and fertile in cotton, fruits, and wine, stretches N. from the hills. The town is walled, and the houses are mostly of stone, but the streets are narrow and dirty. It is the emporium of an extensive export trade. The chief industry is the manufacture of cotton yarn, cloth, and yellow morocco leather.—This place, anciently called Mazaca, was the capital of Cappadocia until that country was formed into a Roman province, when the name of the city was changed to Cæsarea (whence its modern name), under which latter appellation it gave title to a Christian bishop from the early times of the church. (See CÆSAREA, II.)

**KAISERSLAUTERN**, a town of Bavaria, in the Palatinate, on the Lauter, 32 m. W. N. W. of Spire; pop. in 1871, 17,867. It has a Catholic and two Protestant churches, a Latin school, a Protestant normal school, several other educa-

tional institutions, and a richly endowed hospital. There are manufactories of tobacco, cotton, and hosiery, and several iron works. On Nov. 30, 1793, the duke of Brunswick gained here a victory over Hoche. The French also suffered defeats here in May and September, 1794.

**KAISERSWERTH**, a town of Prussia, in the province of the Rhine, on the river Rhine, 6 m. N. N. W. of Düsseldorf; pop. in 1871, 2,223. It is noted for the house of evangelical deaconesses founded by Pastor Fliedner, which has now branches in all countries of the Protestant world. (See DEACONESSA.)

**KAKODYLE**, or *Cacodyle* ( $As_2C_2H_4$ ), a coupled compound of arsenic and methyle, expressed by the name *arsendimethyle*. The substance is a highly poisonous liquid, heavier than water, gives forth vapors of specific gravity 7.1, which have a most disgusting odor, and takes fire spontaneously on exposure to the air. It boils at  $386^\circ F.$ , and solidifies in square prisms at  $43^\circ F.$ ; it is soluble in alcohol or ether, but scarcely so in water. It unites as a base directly with oxygen, and probably with sulphur and chlorine also; and it furnished the first instance of the isolation of an organic metallic basyle. It is obtained by decomposing its chloride by granulated zinc, or its sulphuret by means of mercury. The preparation of the compounds of kakodyle is difficult and dangerous. The oxide obtained by distilling equal parts of dried acetate of potash and arsenious acid is an impure quality of the fetid liquid formerly known as *Cadet's fuming liquor*, or *alkarsine*, which inflames spontaneously on exposure to the air.

**KALAFAT**, a walled town of Roumania, in Little Wallachia, on the left bank of the Danube opposite Widin, 155 m. W. S. W. of Bucharest; pop. about 2,500. It has a town hall, a custom house, a quarantine, and cavalry barracks. The town is built on a plain of the same name, skirted by hills. Its fortifications describe an arc of a circle around the town, the Danube forming the chord. It is important in a strategic point of view, and has figured more than once in Turkish military annals. Here the Russians in 1829 lost 10,000 men in their operations against the Turks. Severe engagements took place in its vicinity in the early part of January, 1854; and an assault of the Russians was repulsed by the Turks on April 19.

**KALAMATA**, a town of Greece, capital of the nomarchy of Messenia and of an eparchy of the same name, about 1 m. from the gulf of Koron in the south of the Peloponnesus; pop. about 6,200. It is the seat of the bishop of Messenia, and of a court of the first resort, and has a busy trade. Its chief exports are wool, oil, cheese, raw silk, and figs. A kind of handkerchief is manufactured here, which is in great demand in the Levant. Kalamata is supposed to be built on the site of *Pheræ*, one of the maritime cities in the time of the Trojan war. During the crusades it was one of the

most important places of the Peloponnesus, and was annexed to the possessions of Venice. It passed into the hands of the Turks at the beginning of the 18th century. It was among the first towns delivered by the Greeks in 1821, and the first where a Grecian legislative assembly was convened. In 1825 it suffered from the attack of the Egyptians under Ibrahim Pasha, but the damage then inflicted upon the town has been gradually repaired.

**KALAKAUA**, David, seventh king of the Hawaiian Islands, born in Honolulu, Nov. 16, 1836. He is the son of C. Kapaakea and Keohokalole, and is descended on his mother's side from Keawe, an ancient king of the island of Hawaii. He received an English education, with Prince Lunaililo and about 15 other hereditary chiefs, in the royal school at Honolulu. In 1860 he visited California. On Dec. 19, 1863, he married the chieftainess Kapiolani. On the death of Lunaililo, Feb. 3, 1874, without proclaiming a successor, both Kalakaua and the queen dowager Emma, relict of Kamehameha IV., announced themselves as candidates for the throne. The legislature was summoned in extra session to elect a king. On Feb. 12 Kalakaua received 39 electoral votes out of 45, the remaining 6 being given to Queen Emma; and the former was consequently declared king. On hearing the result a mob of Queen Emma's partisans broke into the court house and attacked the legislature still sitting there. The authorities asked help from the American and British ships of war then lying in port, and the insurgents were promptly dispersed by parties of marines from the Tuscarora, Portsmouth, and Tenedos. Kalakaua was installed as king on the same day. On the 14th he proclaimed his brother, Prince William Pitt Leleiohoku, heir apparent.

**KALAMAZOO**, a S. W. county of the S. peninsula of Michigan, drained by the Kalamazoo and affluents of St. Joseph's river; area, 576 sq. m.; pop. in 1870, 32,054. The surface is level or undulating, with rich prairies, fertile plains dotted with oak timber, and thick forests. It is traversed by the Michigan Central and its South Haven division, the Grand Rapids and Indiana, the Kalamazoo division of the Lake Shore and Michigan Southern, and the Peninsular railroads. The chief productions in 1870 were 844,284 bushels of wheat, 143,817 of Indian corn, 226,942 of oats, 312,777 of potatoes, 299,532 lbs. of wool, 29,392 of hops, 714,969 of butter, and 40,784 tons of hay. There were 8,583 horses, 7,182 milch cows, 7,634 other cattle, 76,699 sheep, and 18,748 swine; 5 manufactories of agricultural implements, 5 of brick, 15 of carriages, 10 of cooperage, 4 of iron castings, 2 of engines and boilers, 2 of musical instruments, 1 of printing paper, 12 of saddlery and harness, 2 of sash, doors, and blinds, 6 of tin, copper, and sheet-iron ware, 1 of woollen goods, 4 breweries, 5 planing mills, 15 saw mills, 10 flour mills, and 4 tanneries. Capital, Kalamazoo.

**KALAMAZOO**, a village and the county seat of Kalamazoo co., Michigan, on the left or W. bank of the river of the same name, about 65 m. from its mouth in Lake Michigan, 60 m. S. W. of Lansing, and 143 m. W. of Detroit; pop. in 1850, 2,507; in 1860, 6,070; in 1870, 9,181. It is pleasantly situated, in the midst of a beautiful and fertile country, and is regularly built with broad streets shaded by the oak, maple, and elm trees. It contains many elegant residences and fine business structures. The Grand Rapids and Indiana railroad, the main line and South Haven division of the Michigan Central, and the Kalamazoo division of the Lake Shore and Michigan Southern railroads intersect here. The manufactories, which are run partly by water power furnished by the river and partly by steam, include two founderies, an extensive paper mill, two marble works, two carriage factories, a wagon shop, a piano and billiard-table leg factory, a farming mill factory, three planing mills, a plough and cultivator factory, manufactories of furniture, steel springs, burial caskets, washing machines, and morocco, tanneries, &c. There are two national banks, with a capital of \$400,000, and a state bank. Kalamazoo is the seat of the state insane asylum; of Kalamazoo college (Baptist), organized in 1855; and of Michigan female seminary (Presbyterian), organized in 1866. Kalamazoo college has a preparatory and a collegiate department, the latter including classical and scientific courses, and in 1872-'3 had three professors, 6 instructors, and 192 students, of whom 116 were males and 76 females, 26 collegiate and 166 preparatory, and a library of 2,000 volumes. Michigan female seminary is a collegiate institution, having in 1873-'4 10 instructors and 57 students. There are six public schools, employing more than 40 teachers, a private school for young ladies, a daily and two weekly newspapers, a monthly periodical, and 16 churches.—The village was first settled in 1829, and was organized in 1831. It was known as Bronson, from the first settler, till 1836.

**KALAMAZOO RIVER**, a river of Michigan, which rises in Hillsdale co., in the S. part of the state, and after a circuitous course of nearly 200 m. flows into Lake Michigan, in Allegan co., 98 m. in a direct line from its source. Its general direction is W. N. W. It is 300 or 400 ft. wide at its mouth, and navigable at all seasons by vessels of 50 tons to Allegan, 38 m. from the lake. It drains a rich level country, affording extensive water power.

**KALCKREUTH**, Friedrich Adolf von, count, a German general, born at Sottershausen, Feb. 22, 1737, died in Berlin, June 10, 1818. He entered the army in 1752, and in reward of distinguished services was made a count in 1788. In 1798 he compelled Mentz to capitulate, and shared in the victories at Kaiserslautern (1793-'4) and in subsequent successes. In 1807 he defended Dantzic against the French, was allowed to surrender under the same hon-

le conditions which he had accorded at  
tz, and was made field marshal. In the  
year he concluded a truce with Berthier  
ilsit, preliminary to the treaty of peace  
h he and Goltz negotiated in July with  
yrand. In 1810 he became governor of  
in, which office he resumed in 1814, after  
ng been governor of Breslau.—His son,  
t FRIEDRICH, published in 1825 *Drama-  
e Dichtungen*; and a nephew of the latter,  
at STANISLAUS (born Dec. 25, 1820), be-  
a landscape painter and director of the  
ol of art at Weimar.

**KALEIDOSCOPE** (Gr. *καλός*, beautiful, *εἶδος*, a  
y, and *σκοπεῖν*, to see), an optical instru-  
t for multiplying the reflected images of  
l colored objects, producing by the sym-  
y of their arrangement patterns of great  
ty. An instrument on this principle was  
ally described by Battista della Porta and  
her; and in a work by R. Bradley, pub-  
d in 1717, entitled "New Improvement of  
ting and Gardening," it was recommended  
aiding in the production of designs for  
en plots and fortifications. Its true prin-  
s were first developed, however, by Sir  
id Brewster, who devised the proper method  
ts construction, and in 1817 took out a  
nt for it.—When two oblong mirrors of  
same dimensions are placed so as to hinge  
ther along an edge of each, their reflecting  
aces facing each other, and are then opened,  
s to make an angle which is an aliquot part  
80°, an object placed between the planes  
he mirrors, or in contact with one of the  
emities of the pair, is reflected from one  
o to the other, and produces as many  
es as the angle of the opening is contained  
60°. These images are arranged in sym-  
ical order around a circular area, the ra-  
of which is the width of the mirror, and  
centre the point of meeting in the two  
es. The perfect symmetry of their ar-  
ement depends on the angle of the open-  
eing an aliquot part of two right angles,  
that usually employed is either 18° or 20°.  
ther requisite is, that the line of junction  
e two mirrors should be fine and smooth,  
ny irregularities would produce imperfec-  
t. As usually constructed, the mirrors are  
s of glass blackened on one side. They  
kept together by a piece of cloth glued  
the edges in contact, and the proper an-  
s preserved by securing them in a tube of  
ble shape. The open side of the triangu-  
rism formed by the two mirrors is closed  
a strip of black velvet of suitable width  
l to the backs of the two mirrors. The  
idrical tube is of the diameter of the larger  
of the prism, and the angle formed by the  
ing of the two planes at the other extrem-  
s nearly coincident with the centre of the  
lar end of the tube. Through the cover  
his a small aperture is made exactly in the  
e, to which the eye is to be applied in  
g the instrument. At the other extremity a

plain disk of thin transparent glass is fitted close  
to the ends of the mirrors, and outside of this  
is another disk, the two kept apart by a ring  
set in between them. In the intervening space  
the objects to be reflected are placed. These  
may be small fragments of colored transparent  
glass intermixed with a variety of other small  
bright objects. But care must be taken not to fill  
the case too full for the objects to move freely  
among themselves while the tube is made to  
turn in the hand upon its axis. By looking  
into the circular aperture made for the eye,  
the most gorgeous figures are perceived sym-  
metrically arranged, and all forming one com-  
plete pattern.—Kaleidoscopes are also made  
with three, four, five, or more mirrors, and are  
then termed polycentral. To produce symme-  
try and regularity of form in the images of  
these kaleidoscopes, the angles which the mir-  
rors make with each other must necessarily be  
aliquot parts of 180°; and as their number is  
increased, the range of the instrument in the  
variation of these angles is diminished. Thus  
three mirrors only should be arranged to make  
the three angles of 60° each, or two of 45° each  
and one of 90°, or one of 30°, one of 60°,  
and one of 90°. By the first arrangement, the  
images appear in groups of three repeated  
throughout the pattern. This instrument is  
called the triascope. By the second arrange-  
ment, the instrument, called the tetrascope,  
produces a pattern divided into square com-  
partments. By the third arrangement, the pat-  
tern, of hexagonal form, presents a remarkable  
symmetry, and the instrument is termed a hex-  
ascope. The last two forms are especially  
useful to the draughtsman.

**KALERGIS**, Demetrius, a Greek soldier, born  
in Candia about 1803, died in Athens, April  
24, 1867. He was educated in Russia, distin-  
guished himself in the war of Grecian inde-  
pendence, was one of the promoters of the  
revolutionary movement of 1848, into which  
he entered as a partisan of Russia, and subse-  
quently became general and adjutant of King  
Otho, but resigned in 1845. In London he  
became acquainted with Louis Napoleon, which  
led to his being appointed Greek ambassador  
at Paris in 1861, after having in the interval  
acted for some time as minister of war.

**KALGAN**, or *Changkiakan*, a town of China,  
in the province of Chihli, 110 m. N. W. of Pe-  
king, renowned as a commercial station be-  
tween Russia and China, and as one of the  
great market towns of the empire. It extends  
several miles along the W. bank of a tributary  
of the Yangho, the stream breaking through a  
narrow gorge and forming a natural outlet for  
the highway of N. Asia. Remains of a gate  
of the great wall are visible on either side of  
the gorge, and the scenery is fine.

**KALEVALA**, the national epic of Finland.  
See FINLAND, vol. vii., p. 208.

**KALIDASA**, an Indian poet, who, according to  
tradition, lived at the court of King Vikrama-  
ditya, in the 1st century B. C. He was one

of the poets called the nine precious stones of the court. Vikramaditya (sun of strength) is a title given to several Hindoo monarchs, and many scholars believe Kalidasa to have flourished in the 11th century A. D. at the court of King Bhoja. The works attributed to him are so various that the existence of several poets of his name at different periods has been supposed. His best production is the drama *Sakuntala*, which was translated into English by Sir William Jones in 1789, and immediately excited in Europe a lively interest in Sanskrit literature. It was translated into German by Forster (1790), Herder (1803), and others, and into French by Chézy (published with the Sanskrit original, 1830). He is the author also of the drama *Vikramorvasi* (translated into English by H. H. Wilson; published with a Latin translation by Lentz, Berlin, 1833); the comedy "Malavika and Agnimitra" (published with a Latin translation by Fallberg, Bonn, 1840); the epical poem *Raghurana* (published in Sanskrit and Latin by Stenzler, London, 1832); the *Kumara-Sambhara* (also edited by Stenzler, London, 1838); the *Megha-duta*, or "Cloud Messenger" (translated into English verse by H. H. Wilson, Calcutta, 1813, and London, 1843); and other dramatic and lyrical pieces.

**KALISZ.** See **KALISZ**.

**KALISCH, David**, a German humorist of Jewish parentage, born in Breslau, Feb. 23, 1820, died in Berlin, Aug. 21, 1872. He began his literary activity in Paris, and in 1848 founded in Berlin the *Kladderadatsch*, the German "Punch," which toward the close of his life he edited jointly with Dohm. He was the author of several popular plays, among the best known of which are *Hunderttausend Thaler*, *Berlin bei Nacht*, *Doctor Peschke*, and *Berlin wie es weint und lacht*. His pieces have been played with great success. There is a collection of his works entitled *Berliner Leierkasten*.

**KALISPELS**, or **Pends d'Oreilles**, a tribe of Indians, of the Selish family, living in Montana, Idaho, Washington territory, and British America. They are a brave but peaceable and good-tempered race, willing to work, and, though originally a miserable half-starved race, have made great improvement, chiefly under the influence of the missions founded among them by Father P. J. De Smet in 1844. They have been exposed to inroads of less civilized tribes, and have been forced from lands which they had cultivated and deemed secured to them. A treaty made in July, 1855, ceded the lands of the Montana band, but no consideration was paid; this treaty was approved in 1859, and the Kalispels were left on a reservation in Bitter Root valley till 1871, when, under a clause in the treaty of 1855, President Grant ordered them to be removed to Jocko reservation. His action was approved by act of congress, June 5, 1872. The houses for chiefs promised by the treaty of 1855, and an agricultural school also promised, were never begun. In 1872 this band numbered 1,000. They had 70

farms under cultivation in Bitter Root valley, had 800 cattle, 2,000 horses, and many hogs, raised large quantities of wheat, oats, potatoes, and corn, and had to a considerable extent adopted the dress of the whites. The band in Idaho numbered 700, and were alternately on British and on American soil. The band in Washington territory, numbering about 400, were in Kalispel valley, east of the Cascade mountains, and were reported as the most peaceable and quiet tribe in the territory, cultivating about 400 acres, and having numerous horses, cattle, and poultry. An executive order of July 2, 1872, directed their removal to a reservation north and west of the Columbia, although they remonstrated against it.

**KALISZ** (Ger. *Kalisch*). L. A. W. government of European Russia, in the kingdom of Poland, bordering on the governments of Plock, Warsaw, and Piotrków, and the Prussian province of Posen; area, 4,200 sq. m.; pop. in 1867, 601,029. II. One of the oldest towns of Russian Poland, capital of the government, between two branches of the Prerna, on the Prussian frontier, 130 m. S. W. of Warsaw; pop. in 1867, 13,602, of whom one fifth were Jews. It has several higher schools, a theatre, and a fine promenade. It was conspicuous during the wars of the Polish and Silesian princes in the middle ages, and was taken in 1656 by the Swedes. The Russians and Saxons gained a victory here over Charles XII. in 1706, and the Russians over the French in February, 1813. A few days after the latter event an alliance was formed here between the czar and the king of Prussia.

**KALKASKA**, a N. W. county of the S. peninsula of Michigan, drained by the Manistee and Grand Traverse rivers; area, 576 sq. m.; pop. in 1870, 424. Capital, Clearwater.

**KALKBRENNER**. I. Christian, a German composer, born in Minden, Sept. 22, 1755, died in Paris, Aug. 10, 1806. He was for a number of years in the service of Prince Henry of Prussia, the brother of Frederick the Great, a composer; and subsequently he officiated as singing master in the academy of music in Paris. He is the author of a number of operas and pianoforte pieces, and of a history of music, not completed at his death, which is considered valuable authority on whatever relates to Hebrew and Greek music. II. Friedrich, son of the preceding, born in Cassel in 1784, died at Enghien-les-Bains, near Paris, June 10, 1849. His musical education commenced at an early age, and was completed in Paris, where in 1802 he gained two prizes at the conservatory. As a pianoforte performer he was one of the most eminent of his time, and his compositions for that instrument are still in great estimation. During several years he resided in England as a teacher, but in 1808 he fixed himself permanently in Paris. Among his works are many pieces of chamber music for a variety of instruments. He arranged the symphonies of Beethoven for the pianoforte.

**KALM, Peter**, a Swedish botanist, born at Osterbotten in 1715, died in Abo, Nov. 16, 1779. He was educated at Upsal, and on the suggestion of Linnæus he was selected in 1745 by the Swedish government to make a botanical tour of North America. He arrived in Philadelphia in the summer of 1748, and remained in America till 1751, travelling and gathering specimens of plants in Canada, New York, and Pennsylvania. On returning to Sweden he published *En resa til Norra Amerika* (3 vols., Stockholm, 1753-'61), translated into English by John Reinhold Forster under the title of "Travels in North America" (2d ed., 2 vols., London, 1772); it was also translated into German and Dutch. He was made professor of natural history at Abo, and published numerous dissertations covering a wide range of botanical subjects.

**KALMAR.** See CALMAR.

**KALMIA**, a genus of handsome flowering, evergreen, North American shrubs of the order *Ericaceæ*, named in honor of Peter Kalm. They are popularly known as laurels, but are not related to *Laurus*, the true laurel. The best known and most conspicuous species is the mountain laurel (*K. latifolia*), a fine shrub, sometimes forming a small tree 15 or 20 ft. high; it is found upon rocky hills, in mountain ravines, as well as in damp rocky pastures, from Canada to Florida. The leaves are scattered, or in whorls or tufts, 2 to 4 in. long,



*Kalmia latifolia*.

ovate-lanceolate, petioled, somewhat reflexed on the margins, of a bright green color and a leathery texture. The flowers, which vary from pure white to deep rose color, are borne in large terminal heads, and are externally so viscid as to adhere to each other when carelessly plucked. The corolla is beautiful both before and after it opens; in its unexpanded state it has been compared to a "ten-angled casket;" it is monopetalous and salver-shaped or shallow bell-shaped. There are ten stamens, the long filaments of which are arched by each anther being caught in and held by a depression

in the corolla; a slight disturbance, such as the entrance of an insect, dislodges the anthers from their niches, and the bowed stamens spring violently upward, the jerk scattering the pollen, which is in this genus liberated from a hole or pore in the apex of each anther cell. This is one among the many contrivances for securing cross fertilization. The stems and roots afford a favorite material for rustic work; the wood is close-grained and hard, and is used for turning handles for tools and other small wares; from its use in carving, it is in some places called spoonwood, and it is also sometimes called calico bush. The mountain laurel is in Europe one of the most highly prized of American plants, but is rarely seen in our gardens. It is commonly supposed to be impossible to transplant it; but if the head of the tree be severely cut back so that nothing but naked branches are left, and the plant removed to good garden soil in early spring, it will soon throw out new shoots and by autumn be well clothed with foliage. The flowers may be had late in winter by placing bud-bearing branches in water in a warm room. The other species have the same structure in the flowers as the one already described. The low laurel, sheep laurel, or lamb-kill (*K. angustifolia*) is equally widely distributed, but is much smaller, not growing above 3 ft., and often forming tufts in low grounds. Its leaves are opposite or in threes, light green above, and pale or whitish below; the small deep crimson flowers are in corymbs, which appear lateral by the growth of the present season's shoots. As indicated by its common names, this shrub has the reputation among farmers of being poisonous to sheep; some have attributed the ill effects upon sheep to the indigestibility of the leaves; but there seems to be no doubt that the foliage of this and the preceding species produces poisonous effects on man, including nausea and temporary blindness, and similar symptoms are observed in sheep, which are relieved by an emetic. The pale laurel (*K. glauca*) is found in cold peat bogs, usually on mountains from Pennsylvania northward. It is about one foot high, with a straggling stem, opposite, nearly sessile leaves, which are very glaucous beneath, and few-flowered corymbs of lilac-purple flowers. A species peculiar to the southern states from Virginia to Florida is popularly called wicky (*K. hirsuta*); it differs from the others in having solitary axillary flowers; it does not grow over 18 in. high, and has very small leaves, a decoction of which is used by the negroes to cure diseases of the skin. The only other species is *K. cuneata*, a rather uncommon low shrub found in North and South Carolina.

**KALOCSA**, a town of Hungary, near the E. bank of the Danube, in the county and 69 m. S. of the city of Pesth; pop. in 1869, 16,802. It is the seat of a Roman Catholic archbishop, and has an episcopal seminary and a gymnasium. The inhabitants are chiefly engaged in agriculture and the cultivation of wine.

**KALUGA.** I. A central government of Russia, bordering on Smolensk, Moscow, Tula, and Orel; area, 11,927 sq. m.; pop. in 1867, 984,255. The surface is in general very level. It is watered by numerous rivers, the principal of which is the Oka. The soil is of a sandy or strong clayey nature, and only moderately fertile. More than half of this province is under forest. The climate is one of the mildest in Russia. Iron, coal, chalk, and gypsum are found. Woollens, linens, sail cloth, &c., are manufactured. II. A city, capital of the government, on the left bank of the Oka, 95 m. S. W. of Moscow; pop. in 1867, 36,080. It is irregularly built, being 7 m. in circumference, though not containing more than 4,000 houses, chiefly of wood. It is surrounded by a rampart which has been converted into a public promenade. It contains 23 churches, a theological college, nunnery, hospital, gymnasium, government house, orphan asylum, public library, and theatre. It is a place of considerable trade, and the chief seat of the manufactures of the province. A commercial bank was founded here by a public-spirited citizen in 1859, the profits to be applied to charitable purposes. Political offenders of high rank have been banished to Kaluga for many years past. Shamyl was removed to Kaluga in 1859.

**KALW.** See CALW.

**KAMA,** a river of Russia, the principal affluent of the Volga. It rises in a branch of the Ural mountains in the N. E. part of the government of Viatka, runs first N. and N. E., then takes a S. and S. W. direction through the governments of Perm and Kazan, forming intermediately the boundary between Viatka and Ufa, and joins the Volga, after a course of about 1,200 m., 40 m. from the city of Kazan, almost doubling the volume of the Volga. It receives in its course the tributary rivers Visher, Tchušovaya, Bielaya, and Ik on the left, and the Obva and Viatka on the right. The Kama is navigated by barges to Perm, and by flatboats much higher. Its waters at Perm have a depth of 23 ft. less at the end of summer than in the freshets of spring. It is connected with a branch of the Dwina by a canal 12 m. long, establishing water communication between the Caspian and White seas.

**KAMEELA,** or *Kamala*, the glandular powder and hairs obtained from the capsules of *Rottlera tinctoria*, a small tree of the order *euphorbiaceæ* growing in the East Indies. The finest, consisting of roundish three-celled capsules, is gathered in February and March, and the light, mobile, brownish red powder formed by the glands and hairs, brushed off. This consists in a large proportion (78 per cent.) of resins, one or more of which is supposed to be the active principle. Kameela is actively purgative in full doses, sometimes acting violently, and occasionally causing nausea, but seldom vomiting. It has been long used in India in the treatment of tapeworm, and seems to have been found very efficient by the British practitioners in

that country. It has, however, only within a few years been used in Europe and America. It is given, without previous preparation of the patient, in the dose of from one to three drams, suspended in water, mucilage, or sirup. A tincture has been employed. The bark of another species of the genus, *R. Schimperii*, growing in Abyssinia, has been supposed also to possess anthelmintic properties. When kameela is administered in cases of tapeworm, the worm is usually expelled with the third or fourth stool.

**KAMEHAMEHA,** the name of a line of sovereigns of the Hawaiian islands. I. Called Nui (the Great), born in 1753, died at Kailua, on the island of Hawaii, May 8, 1819. He was the son of Keoua, a powerful chief among the different leaders of tribes who governed the islands in the early part of the 18th century. He was at first ruler of the western part of Hawaii, and conceiving the idea of a united government, he conquered the remainder of that island, and ultimately the whole group, the last island submitting to him in 1809. Having established his authority in 1796, he adopted liberal measures, such as the partial abolition of the *tabu* system and of human sacrifices, the introduction of many reforms, and the encouragement of agriculture and commerce. Some of these measures were owing to the suggestions of Vancouver, the explorer, who gained the king's friendship and exercised great influence over him. II. Son of the preceding, called Iolani or Liholiho, born on Hawaii in 1797, died in London, July 14, 1825. When he came to the throne the old native religion and customs were fast giving way before foreign ideas and innovations; and the American missionaries, who arrived in the islands March 31, 1820, met with immediate success. During the early part of his reign he completed the abolition of the *tabu* and of idolatry, accorded many privileges to the missionaries, and encouraged their endeavor to educate the people. On Nov. 27, 1823, Kamehameha, who had long desired to visit foreign countries, sailed for England with his queen Kamehamehala and suite. They received much attention in London, and met with a cordial reception from George IV. As they were about to return, however, several members of the party were attacked by a malignant form of measles, to which both the king and queen succumbed. Their bodies were carried to the islands by H. M. S. *Bionda*, arriving at Honolulu May 6, 1825. Kamehameha II. not having appointed a successor, a council of chiefs elected his younger brother to the vacant throne. III. Called *Kauikoa*, brother of the preceding, born March 17, 1814, died in Honolulu, Dec. 15, 1854. From his accession, June 6, 1825, he reigned under the regency of Kaahumanu, queen dowager of Kamehameha I. She died in 1832, and in the early part of 1833 he assumed full control of the kingdom. He granted a liberal constitution to his subjects, and greatly encouraged

the advancement of education and civilization among them. During his reign, however, the Roman Catholic missionaries were banished from the islands. He suffered greatly from the efforts made by officers of several foreign powers, especially by the English Capt. Belcher and the French admiral du Petit-Thouars, to intimidate him, and force him to consent to measures favorable to their own nationalities; but he successfully resisted their attempts.

**IV.** Son of Kekuanooa, governor of Oahu, and adopted son of the preceding under the name of Alexander Liholiho, born Feb. 9, 1834, died in Honolulu, Nov. 30, 1863. In 1850 he visited Europe with his elder brother, afterward Kamehameha V.; and soon after his return he succeeded to the throne (1854). In 1856 he married Emma, the daughter of a high native

chief by an English woman, and the adopted daughter of an English physician at the islands, Dr. Rooke. Both the king and queen had thus enjoyed the benefit of a good education by Americans, and were of much greater refinement and broader culture than their predecessors. A son was born to them May 20, 1858, but he died when but four years old. In a fit of intoxication the king wounded one of his companions by a pistol shot. Remorse for this act, and grief at the death of his son, hastened the progress of his last illness. During his later years he translated the "Book of Common Prayer" into Hawaiian, omitting the Athanasian creed. **V.** Called Lot, elder brother of the preceding, born Dec. 11, 1830, died in Honolulu, Dec. 11, 1872. Succeeding his brother in 1863, he made great changes in the affairs of the kingdom. In 1864 he set aside the constitution given by Kamehameha III., and proclaimed instead of it a more absolute one, which was accepted only after much parliamentary opposition. His reign was prosperous, but comparatively uneventful. He died unmarried, and the direct line of the Kamehamehas ended with him. He failed to nominate a successor, as provided by the constitution; and after his death Prince Lunailo, of a high family of native chiefs, was elected to succeed him.

**KAMENETZ**, *Kamieniec*, or *Kamenetz-Podolskoi*, a town of Russia, capital of the government of Podolia, 12 m. N. of the Dniester, on the left bank of its confluent the Smotritza, 235 m. N. W. of Odessa; pop. in 1867, 22,490, of whom half are Jews. It is the seat of a Greek eparchy and a Roman Catholic see. The prin-

cipal buildings are the cathedral of Peter and Paul and four other Greek churches, several convents, one Armenian and three Roman Catholic churches, a Greek theological seminary, a gymnasium, two public schools, and a government library. The town has some manufac-



Kamenetz.

tures and a considerable trade, especially in peltries with Moldavia. Its fortifications were razed in 1812; it has still a citadel and a detached fort. This place was the strongest bulwark of the Poles toward their Turkish frontier. The Turks took it in 1672, and held it till the peace of Carlovitz in 1699.

**KAMENZ.** See **CAMENZ.**

**KAMES**, *Henry Home*, lord, a Scottish jurist, born at Kames, Berwickshire, in 1696, died Dec. 27, 1782. He was educated at the university of Edinburgh, and, after nearly 30 years' practice at the bar, was in 1752 elevated to the bench as a judge of the court of session. In 1763 he was made a lord of justiciary. Under the title of Lord Kames he filled both offices with ability and integrity until the close of his life. As an author he is known by numerous works on law, metaphysics, criticism, agriculture, &c., covering a period of more than 50 years. To legal literature he contributed a series of reports, consisting of an abridgment of the "Decisions of the Court of Session" from its foundation, arranged like a dictionary (2 vols. fol., 1741), "Remarkable Decisions of the Court of Session" (2 vols. fol., 1728-'66), covering nearly the whole period between 1716 and 1752, and "Select Decisions of the Court of Session from 1752 to 1768" (1 vol. fol., 1780); "Statute Law of Scotland abridged, with Historical Notes" (8vo, 1757); "Principles of Equity" (fol., 1760), &c. In 1747 he published "Essays on several Subjects concerning British Antiquities," and in 1751 appeared his "Essays on the Principles of Morality and Natural Religion," a work of ability,



but which gave offence to the Scottish church from the supposed irreligious tendency of some of the author's views. The work upon which his reputation chiefly rests is his "Elements of Criticism" (3 vols. 8vo, 1762), which was greatly admired at the time of its appearance, possessing, in the opinion of Dugald Stewart, "infinite merits," but of which Goldsmith once said, "It is easier to write that book than to read it." He also published "Sketches of the History of Man" (2 vols. 4to, 1774); "The Gentleman Farmer, being an Attempt to improve Agriculture by submitting it to the Test of Rational Principles" (1776); and "Loose Hints on Education" (8vo, 1781), written the year before his death. As a member of the board of trustees for the encouragement of manufactures, fisheries, and arts, and a commissioner for the management of forfeited estates, he labored earnestly to promote the material prosperity of Scotland. In 1807 appeared an account of his life, by Lord Woodhouselee (2 vols. 4to).

**KAMIENIEC.** See KAMENETZ.

**KAMMIN.** See CAMMIN.

**KAMOURASKA**, an E. county of Quebec, Canada, bounded S. E. by the state of Maine and N. W. by the river St. Lawrence; area, 1,017 sq. m.; pop. in 1871, 21,254, of whom 21,038 were of French descent. It is drained by Du Loup, Kamouraska, and Oncle rivers, and other small tributaries of the St. Lawrence, and by some affluents of the St. John. The surface is diversified, and in the south mountainous. Wheat, rye, barley, oats, and potatoes are the principal productions. It is traversed by the Rivière du Loup division of the Grand Trunk railway. Capital, Kamarouska.

**KAMPEN**, a town of the Netherlands, in the province of Overysseel, on the Yssel, 8 m. W. N. W. of Zwolle; pop. in 1869, 15,653. It has a gymnasium and an industrial school, machine shops, iron founderies, and manufactories of stockings and cigars. It is traversed by a canal, and its river trade is rapidly increasing. There is regular connection by steamship with Amsterdam, Zutphen, Niméguen, Arnheim, Emmerich, and Cologne.

**KAMPEN, Nikolaas Godfried van**, a Dutch historian, born in Haarlem, May 15, 1776, died March 14, 1839. As a youth he acquired in a book store, where he was employed, a knowledge of literature, and mastered several languages. He then became teacher of German, editor of the "Leyden Gazette," and finally professor of the Dutch language, literature, and history, first at the university, and then at the atheneum in Leyden. He was the author of numerous works, many of which, translated into German, have a European reputation.

**KÄMPFER**, or *Kaempfer*, *Engelbrecht*, a German traveller, born in Lemgo, Lippe-Detmold, in 1651, died in Detmold, Nov. 2, 1716. He studied at Königsberg, and accompanied as secretary a Swedish ambassador to Persia. In 1685 he entered as surgeon the naval service

of the Dutch East India company, and sailed for Batavia, whence in 1690 he was despatched to Japan as physician to the embassy. He remained in Japan two years, and gathered materials for his great work on the history, resources, &c., of that empire. In 1693 he returned to Europe. He was the author of various valuable works, but published nothing himself, save his *Amanitates Esoticae* (1712), which contains much curious matter touching the natural history, antiquities, &c., of Persia and other countries of western Asia. His account of the Japanese empire has never been published in the original, but an English translation of it, under the title of "History of Japan and Description of Siam," appeared in London in 1727, and from this the French and German versions have been taken.

**KAMPTZ, Karl Albert Christoph Heinrich von**, a Prussian jurist, born in Schwerin, Sept. 14, 1769, died in Berlin, Nov. 3, 1849. He acquired renown as minister of justice and as one of the most voluminous and best writers on law. His works include *Die Provinzial- und statutarischen Rechte in der preussischen Monarchie* (3 vols., Berlin, 1826-'8), and *Zusammenstellung der drei Entwürfe des preussischen Strafgesetzbuchs* (in 3 parts, 1844-'5).

**KAMTCHATKA**, a large peninsula of the Russian empire, in the N. E. of Asia, about 800 m. long from N. to S., and of irregular breadth, the maximum, along the 56th parallel of latitude, being about 250 m.; area, about 100,000 sq. m.; pop. about 20,000. It is bounded N. by the country of the Tchuktschia, E. by the sea of Kamtchatka, S. by a strait separating it from the Kurile islands, and W. by the sea of Okhotsk. Since 1856 it has been united with the Trans-Yablonic district and the recently acquired Amoor territory to form the maritime province of Eastern Siberia. The coasts are dangerous of approach on account of outlying reefs. A lofty range of volcanic mountains traverses the country in a S. W. direction, with many peaks between 7,000 and 16,000 ft. high. The snow line, in lat. 56° 40', is at an elevation of 5,260 ft. This range is a portion of the great volcanic chain extending from the Yablonnoi mountain range to the Kurile islands. Dittmar, a Russian traveller (1851-'3), traced five successive formations and found 17 volcanoes still in active operation. Numerous rivers rise in the heights. The Kamtchatka, with its affluent the Yelovka, is navigable for 150 m. The most fertile portion of the peninsula for agricultural purposes lies along the valley of this river. The Russian settlers here raise oats, barley, rye, potatoes, and garden vegetables, but the rest of the country is little adapted for culture. The climate is very severe; the winter lasts nine months, and frost is common at all seasons. The mean annual temperature at Petropavlovsk on the E. coast is 28.5°, while at Tigil on the W. it is 45°. The average temperature of summer at the former place is 55.5°, and that of winter 17°.

but the thermometer has been known to fall as low as  $-25^{\circ}$ . Earthquakes are frequent and violent. Animal life is very abundant, and until recently the inhabitants supported themselves wholly on the products of the chase; but since the game has diminished they find plenty of aliment in fish, which swarm in the seas and rivers. The wild animals yet abundant in the more sequestered localities are bears, wolves, reindeer, argalis or wild sheep, black, red, and gray foxes, ermines, sables, and otters. Wild fowl are very numerous. The principal varieties of fish are herrings, cod, and salmon. Whales are often seen in the adjacent seas. The mountains are covered with forests of birch, larch, pine, and cedar, of considerable size in the south, but diminishing northward until the northernmost portion of the territory is covered only with reindeer moss.—The Kamtchatdales, the principal native tribe, are of diminutive stature, but stout, with flat features, small eyes, thin lips, lank black hair, and scarcely any beard. They are a peaceable, honest, lazy, and intemperate race. In winter they live in sunken huts, in summer in huts raised on poles some 13 ft. from the ground. Their dress is equally adapted to the changes of temperature, being of fur in winter and nankeen in summer. They are nominally governed by their own *toions* or chiefs, under the jurisdiction of the Russian *ispranik*, or chief commissary. Dog trains are used as the means of transport. The other principal tribe are the Koriaks, who live north of lat.  $58^{\circ}$ . While the Kamtchatdales are hunters and fishermen, with fixed habitations, the Koriaks are a wandering tribe, subsisting on the produce of the reindeer, and differing from them in language and mode of life. The commerce of Kamtchatka is chiefly with Okhotsk. Its exports are furs, oil, &c. Its imports are flour, sugar, dry goods, whiskey, rice, and coffee, almost all passing through the port of Petropavlovsk, the capital, on Avatcha bay. The other ports are Bolsheretsk, on the W. coast, and Lower Kamtchatka, on Kamtchatka river, with 220 inhabitants. Kamtchatka is one of the principal places of deportation in the Russian empire.—See Kennan, "Tent Life in Siberia" (New York, 1870), and Bush, "Reindeer, Dogs, and Snow Shoes" (New York, 1872).

**KANABEO**, an E. county of Minnesota, drained by Snake river, a branch of the St. Croix; area, 540 sq. m.; pop. in 1870, 93. The surface is uneven and partly covered with forests. Capital, Brunswick.

**KANAGAWA**, a town of Japan, on the W. side of a harbor in the bay of Yedo, and 16 m. S. S. W. of Tokio (Yedo); pop. about 4,000. In the town and vicinity are several famous temples and remains of old fortifications. Its former military, ecclesiastical, and strategic importance arose from the fact of its situation at the point where the great highway of Japan, the Tokaido (East Sea road), strikes the bay of Yedo. Along this road the daimios, or territorial nobles, and the envoys of the mikado

made their official journeys to and from Yedo, prior to 1868. Kanagawa was to have been opened as a treaty port, July 1, 1859; but the shogun's officials, not wishing to have foreigners live on the Tokaido, chose Yokohama, and had jetties, custom houses, storehouses, &c., already built when the foreign merchants and diplomats arrived. A few missionaries, consuls, and merchants lived for a short time at Kanagawa, but finally the entire foreign settlement was made at Yokohama. Hence arose the official fiction that the consulates of the treaty powers are at Kanagawa. Kanagawa gives its name to the *ken* or prefecture which includes the country round Yokohama, the 25-mile circuit in which foreigners are allowed to travel. Like many Japanese towns, Kanagawa consists chiefly of one long street. It has a fort, military barracks, and telegraph and railway station. A causeway connects it with Yokohama. It has lost its former importance.

**KANAWHA**, a S. W. county of West Virginia, intersected by the Great Kanawha and drained by Elk, Coal, and Pocatalico rivers; area, about 1,100 sq. m.; pop. in 1870, 22,349, of whom 2,184 were colored. The surface is mountainous, and the uplands are mostly covered with timber. The valleys are fertile. It is traversed by the Chesapeake and Ohio railroad. The chief productions in 1870 were 46,000 bushels of wheat, 406,826 of Indian corn, 96,268 of oats, 44,800 of Irish and 7,905 of sweet potatoes, 412,469 lbs. of tobacco, 20,457 of wool, 168,149 of butter, and 2,840 tons of hay. There were 2,426 horses, 3,400 milch cows, 1,078 working oxen, 4,011 other cattle, 9,879 sheep, and 15,714 swine; 4 manufactories of saddlery and harness, 9 of salt, 1 of woollen goods, 1 of iron castings, 39 of cooperage, 8 of flour mills, and 11 saw mills. Capital, Charleston, which is also the capital of the state.

**KANAWHA RIVER**. See GREAT KANAWHA.

**KANDIYOHI**, a S. W. central county of Minnesota; area, 864 sq. m.; pop. in 1870, 4,921. Since the census the former county of Monongalia has been united with it. The statistics are for the county as at present constituted. The surface, which is dotted with numerous small lakes, is undulating or level; the soil is productive. The St. Paul and Pacific railroad passes through it. The chief productions in 1870 were 97,315 bushels of wheat, 5,418 of Indian corn, 56,831 of oats, 27,744 of potatoes, 93,080 of butter, and 14,032 tons of hay. There were 788 horses, 1,864 milch cows, 2,924 other cattle, 3,210 sheep, and 821 swine. Capital, Kandiyohei.

**KANE**, L. A. N. E. county of Illinois, drained by Fox river; area, 540 sq. m., pop. in 1870, 39,091. The surface consists chiefly of rolling prairie, diversified by numerous small tracts of timber. The soil is fertile and rests on a bed of limestone. The Chicago and Northwestern, the Chicago and Iowa, and the Chicago, Burlington, and Quincy railroads pass through it. The chief productions in 1870 were 189,151

bushels of wheat, 674,833 of Indian corn, 785,608 of oats, 137,407 of barley, 211,048 of potatoes, 173,264 lbs. of wool, 758,898 of butter, 124,928 of cheese, 945,351 of flax, and 73,255 tons of hay. There were 8,923 horses, 16,034 milch cows, 13,312 other cattle, 86,186 sheep, and 14,942 swine; 7 manufactories of carriages, 1 of cars, 10 of cheese, 1 of nails and spikes, 9 of iron castings, 8 of machinery, 8 of paper, 9 of saddlery and harness, 5 of tin, copper, and sheet-iron ware, 1 of watches, 3 of woollen goods, 12 flour mills, 2 tanneries, 1 currying establishment, and 1 distillery. Capital, Geneva. II. A S. E. county of Utah, bounded E. by Colorado, and S. by Arizona; area, 7,500 sq. m.; pop. in 1870, 1,518. It contains a portion of the great cañon of the Colorado river, which crosses the county and is joined within its borders by the San Juan river. There is some arable land at the base of the Wasatch mountains in the west, and in the valley of the Virgin river. The chief productions in 1870 were 1,663 bushels of wheat, 5,188 of Indian corn, and 6,225 of potatoes. There were 308 horses, 557 milch cows, 828 other cattle, 909 sheep, and 103 swine. Capital, Toquerville.

**KANE, Elisha Kent**, an American arctic explorer, born in Philadelphia, Feb. 3, 1820, died in Havana, Feb. 16, 1857. He was the son of Judge John K. Kane of Philadelphia. In 1836 he entered the Virginia university, and was rapidly qualifying himself for the profession of a civil engineer, when in 1838 he left the institution owing to a disease of the heart, from which he never fully recovered. He began in 1839 the study of medicine in Philadelphia, and on Oct. 19, 1840, he was elected, while still an undergraduate and not of age, resident physician in the Pennsylvania hospital. His health still continuing bad, his father obtained for him the post of surgeon in the navy, and he sailed in the frigate *Brandywine* with Commodore Parker, in May, 1843, as physician to the embassy to China. The American legation being delayed for several months at Bombay, Dr. Kane visited the cave temples of Ellora and Carlee, and travelled in Ceylon. While the expedition remained for nearly seven months at Macao, Dr. Kane crossed the China sea to Luzon, where he made a more complete examination of the Philippines than any foreigner had at that time effected. He traversed Luzon from Manila to the Pacific coast, and descended the crater of the great volcano of Taal. "Only one European had attempted this before, and he without success." He afterward displayed great courage and remarkable activity in visiting Chinese cities and their environs. He remained after the legation had left China, and was engaged for six months in successful practice as a physician at Whampoa, but at the close of 1844 he resolved on account of his health to return home. Before doing so he visited Borneo, Sumatra, and Ceylon, and spent several months in travelling through India, including

the Himalaya mountains. He afterward passed through Persia and Syria, traversed Egypt as far south as Sennaar, and became acquainted with Lepsius. He lost his baggage and papers, was wounded in fighting with Bedouin robbers, and returned to Alexandria, where he had an attack of the plague. Scarcely recovered, he set out for Greece, which he traversed on foot, and then passed from Patras to Trieste. He now travelled through Germany and Switzerland, making in the latter country careful studies of the glaciers, which he afterward found of service in illustrating his theories of the arctic regions. From Switzerland he went to Italy, France, and England, and from England returned home. On May 25, 1844, he sailed in the frigate *United States* for the coast of Africa. Having in Brazil in 1843 obtained letters of introduction from the famous slave dealer Da Souza to his agents in Africa, Dr. Kane was enabled to inspect the factories, and joining a caravan visited Dahomey, where he became acquainted with the sovereign. But in returning to the coast he was attacked by the fever of that region, and finally reached Philadelphia, April 6, 1847, much weakened in health. Having obtained a transfer from the naval to the military staff, he set out on Nov. 6 for Mexico. Being desirous of reaching the American army in time to take part in the war, he went from Perote with a guerilla spy company. On the way he was concerned in a desperate encounter with a Mexican party, performing feats of heroism in defence of prisoners against his own men after the victory. Generals Gaona and Torrejon were among the persons thus saved. Kane received a lance wound and had his horse killed under him. He was most kindly tended by the family of Gaona, and having been carried to Mexico on a hospital ambulance was there invalided and returned home. In January, 1849, he sailed in a store ship to Rio Janeiro, Lisbon, and the Mediterranean, returning in October. In May, 1850, he sailed from New York as surgeon and naturalist to the expedition under Lieut. De Haven, fitted out at the cost of Mr. Henry Grinnell, to search for Sir John Franklin. (See *ARCTIC DISCOVERY*, vol. i., p. 674.) Of this expedition he published an account, "Narrative of the Expedition in Search of Sir John Franklin" (New York, 1854). The disappointment which had attended the return of the unsuccessful English and American expeditions had only increased the public desire to ascertain the fate of Franklin. More vigorous efforts were to be made, and Dr. Kane was desirous of taking part in them. When so ill as to be incapable of writing a long letter, he wrote to Mr. Grinnell, offering his services. Finally, through the liberality of Mr. Grinnell and Mr. George Peabody, \$10,000 and a brig (the *Advance*) were secured. Kane contributed his own pay (about \$3,000) and the proceeds of the lectures which he delivered in 1852-3. The *Advance* sailed from New York under Dr.

Kane's command, May 30, 1853, and the surviving officers and crew reached home again in October, 1855, having been forced to abandon the brig in the ice, and to travel with sledges and boats for 84 days to the Danish settlements on the coast of Greenland, where they met the expedition sent out for their relief under Capt. Hartstene. No traces of Sir John Franklin's party had been found. The most striking result of the voyage was the discovery of what was supposed to be an open polar sea, the existence of which Dr. Kane had maintained in a paper read before the American geographical society, Oct. 14, 1852. The story of the sufferings and discoveries of this heroic band of explorers was told by Kane in his "Second Grinnell Expedition in Search of Sir John Franklin" (2 vols. 8vo, Philadelphia, 1856). Gold medals were awarded to him by congress, by the legislature of New York, and by the royal geographical society of London. He also received the queen's medal given to arctic explorers between the years 1818 and 1856, and a testimonial from the British residents of New York city. Dr. Kane's health now gave way again, and soon after completing his narrative he sailed for England. In London he grew rapidly worse. Finding himself sinking, he sailed on Feb. 17 for St. Thomas, whence he went to Havana, suffering during the voyage a paralytic stroke. On Dec. 25 he reached Havana, where he died as he was about to be removed to the United States.—See "Life of Dr. E. K. Kane," by William Elder, M. D. (Philadelphia, 1857).

**KANE, Sir Robert**, an Irish chemist, born in Dublin in 1810. He was early appointed chemical clerk to the Meath hospital, and in 1830 obtained a prize for the best essay "On the Pathological Condition of the Fluids in Typhus Fever." In 1831 he published "Elements of Practical Pharmacy." In 1832 he received the title of M. D. from Trinity college, Dublin, and in the same year projected the "Dublin Journal of Medical Science." In 1841 he was elected a fellow of the Irish college of physicians, and published the first part of his "Elements of Chemistry;" the third part, completing the work, appeared in 1842. This was for many years a text book in colleges. An edition by Prof. John W. Draper was immediately published in New York. In 1844 he published a work on "The Industrial Resources of Ireland." He was professor of natural philosophy to the royal Dublin society from 1844 to 1847, and in the latter year the royal academy awarded him the Cunningham gold medal for useful discoveries in chemistry, especially for researches on the coloring matter of lichens. In 1845 he was appointed, in conjunction with Professors Lindley and Taylor, to investigate the cause and means of prevention of the potato disease, but their labors were unsuccessful. In 1846 he was knighted by the lord lieutenant, and was appointed one of the Irish relief commissioners. In the

same year the measures recommended by him for the formation of a museum of Irish industry were carried out, the museum at St. Stephen's Green was established, and he was appointed a director. A second edition of his "Chemistry" appeared in 1849. He received the appointment of president of Queen's college, Cork, and delivered the inaugural address at the opening, Nov. 7, 1849, but resigned in 1864.

**KANGAROO**, a marsupial animal, whose numerous species constitute the family *macropodidae*, peculiar to Australia and the neighboring islands. (See **MARSUPIALS**.) The dentition is as follows: incisors  $\frac{1}{2}$ , canines none or one on each side in the upper jaw, premolars  $\frac{1}{2}$ - $\frac{1}{2}$ , molars  $\frac{1}{2}$ - $\frac{1}{2}$ ; the upper incisors are large and broad, some of them resembling those of man, often arched, grooved, and dilated at the end; the lower incisors are horizontal, compressed, lanceolate, with cutting margins; the molars are broad, tuberculated, with nearly quadrangular crowns; in many of the species the lower incisors may be separated by means of the loose connection of the branches of the jaw at the chin. The head is elongated, the upper lip cleft, the muzzle entirely or nearly naked, ears large, eyelashes springing directly from the lids; the clavicles weak and slender, especially in the large species; fore limbs usually very small in proportion to the hind; the hands naked beneath, with five well developed fingers, each armed with a strong curved claw; the hind legs large and powerful; the foot long, four-toed, the first or inner toe being absent, the second and third long, slender, and so united by integument as to resemble a single toe with a double nail; nails distinct and hollow beneath; fourth hind toe much developed, with a large solid claw, the fifth smaller with a strong claw; tail long, thick at the base, and usually very powerful; the marsupial pouch well developed and opening forward; mammae usually four; stomach complex, and caecum long and simple. Kangaroos are vegetable feeders, browsing like ruminants, and like these, according to Owen, occasionally chew the cud; they vary in height from that of a man to that of a hare, but when browsing apply the fore feet to the ground; at other times they rest upon the tripod formed by the hind legs and powerful tail, with the fore part of the body inclining slightly forward. They are the only marsupials which are not of nocturnal habits.—Of the 30 species described, the largest and the best known is the great kangaroo (*macropus giganteus*, Shaw), discovered in 1770 on the coast of New South Wales during Cook's first voyage; an adult male in the British museum measures 5 $\frac{1}{2}$  ft. from tip of nose to root of tail, the latter being 3 $\frac{1}{2}$  ft. additional, the head 8 $\frac{1}{2}$  in. to the ears, ears about 5 in., length of forearm and hand (without the claws) 17 in., and of tarsus alone 15 $\frac{1}{2}$  in.; the female is about one third smaller. The hair is moderately long and soft, of a general gray brown above

and paler below, toes and end of tail black. It prefers low grassy hills and plains and open districts, where it browses upon the herbage and low bushes, retiring from the heat of mid-day under the shelter of the ferns and tall grasses. At the least alarm it raises itself on the hind legs and tail, its height enabling it to command a very extensive view; exceedingly timid, with acute senses of smell and sight, it is difficult to approach, but occasionally falls a victim to the spears and traps of the natives who hunt it for food; the English colonists pursue it so successfully with hound and gun that it is now rarely seen except in the interior. The kangaroo sometimes turns upon his canine enemies, and will either rip them open with the sharp hind feet, or clasp one in his fore paws leap to some water hole and drown it; the unwary human hunter may meet a similar fate. One of the principal uses of the peculiar Australian weapon, the boome-



Great Kangaroo (*Macropus giganteus*).

rang, which may be made to fall in advance of or behind the thrower, is to destroy the timid and wary kangaroo. Though nearly as awkward as a bat when browsing, it is a most fleet and graceful animal when making its enormous bounds, sometimes clearing a rod at a leap. The fore feet are prehensile, and are used in the various offices connected with the care of the young. Kangaroos are not generally gregarious. The skin is valuable for leather, which is esteemed for shoes and gloves; the flesh is also considered a delicacy. Prof. Owen has ascertained that the gestation in the *M. giganteus* is 29 days; the young when first born resemble, according to observations made at the London zoological gardens by him, earth worms in color and semi-transparency, the body being bent upon itself, the short tail tucked in between the hind legs, and these last one third shorter than the fore legs; the whole length, when stretched out, was  $1\frac{1}{2}$  in. As soon as born, the young are placed in the

mother's pouch, which is held open by her fore paws while they are taken up by her mouth. There is no vascular connection between the young kangaroo and the nipple; when separated by force the milky secretion is seen oozing out; the young seem unable to regain the nipple, which is sometimes replaced in the mouth by the mother; the teat has a circular enlargement at the tip, which makes it easy to be retained. Though the young can firmly grasp the nipple by the lips, it cannot draw the milk without the aid of the mother, which by the action of a muscle in the mammary gland can inject this fluid into the mouth of the suckling; lest the act of injection, when not coinciding with that of suction, should endanger the life of the foetus from suffocation, the cartilages of the larynx are so arranged that the opening of the glottis is placed at the top of a cone which projects, as in whales, into the posterior nostrils, so that the stream of milk passes on each side into the gullet without the possibility of entering the wind-pipe.—The subgenus *lagorchestes* (Gould) includes a few small kangaroos with the muffle clothed with velvet-like hairs; *halmaturus* (F. Cuv.) comprises those in which the muffle is naked in front; *heteropus* (Jourdan) contains the rock kangaroos, with compact body, hind feet comparatively short and rough beneath, hairy tail, and naked muffle. In the tree kangaroos (*dendrolagus*, Muller) the fore legs are almost as long and strong as the hind legs, with pointed claws, and the tail is long, bushy, and cylindrical; they ascend trees with facility. The rat kangaroos constitute the genus *phymnus* (Illiger), called also potoroides; they are about the size of a rabbit, with upright ears, compact body less elongated anteriorly, and with the toes of the fore feet unevenly developed, the three central ones the longest, with solid nails compressed and broadest above; they feed on roots which they dig up with their fore paws.—Fossil kangaroos have been found in the limestone caverns and alluvial deposits of Australia, of which the *M. Atlas*, *Titan*, and *Goliath* (all of Owen) were at least one third larger than any living species. The fossil genera *diprotodon* and *nototherium* of Owen, the former superior and the latter equal to the rhinoceros in bulk, found in the alluvial deposits of the Australian Condamine river, are considered to have been marsupials coming near the kangaroos and the wombats.

**KANKAKEE**, a N. E. county of Illinois, bounded E. by Indiana, and drained by Kankakee and Iroquois rivers; area, about 590 sq. m.; pop. in 1870, 24,352. It has a level surface, and consists chiefly of prairie with some swamps. Coal and limestone are found. The Chicago branch of the Illinois Central, the Chicago, Danville, and Vincennes, the Cincinnati, La Fayette, and Chicago, and the Chicago and Alton railroads pass through it. The chief productions in 1870 were 103,946 bushels of wheat, 687,399 of Indian corn, 772,408 of oats,

118,451 of potatoes, 122,891 lbs. of flax, 86,760 of wool, 714,666 of butter, and 73,585 tons of hay. There were 18,514 horses, 12,075 milch cows, 17,166 other cattle, 4,397 sheep, and 16,158 swine; 11 manufactories of carriages, 1 of cheese, 2 of iron castings, 8 of machinery, 1 of linseed oil, 1 of paper, 7 of tin, copper, and sheet-iron ware, 1 of sash, doors, and blinds, 1 of woollen goods, and 5 flour mills. Capital, Kankakee City.

**KANO**, a city of central Africa, capital of a province of the same name in Houssa, situated on a fertile plain in lat. 12° 0' 19" N. and lon. 8° 40' E.; pop. about 40,000, nearly half of whom are slaves. In busy times the influx of foreigners and merchants swells the population to upward of 60,000. The city is surrounded by a well built clay wall 80 ft. high, having 14 gates defended by guard houses,

and making a circuit of more than 15 miles; but not more than a third of the space enclosed by the walls is occupied by houses, the remainder being appropriated to gardens and cultivated fields. It has large markets well supplied with all the necessaries of life. The principal article of commerce is the cotton cloth woven and dyed here of various colors, and which is exported to many parts of central and northern Africa. The fine cotton fabrics in such extensive demand in Timbuctoo, and which have been supposed to be produced there, are derived chiefly from Kano. Tanning and the manufacture of leathern jars and sandals are also carried on to a considerable extent. Among other articles of export are hides, dyed sheepskins, the kola nut, ivory, &c. The slave trade is an important branch of native commerce, and about 5,000 slaves are an-



Kano.

nally exported, besides many sold for domestic use. The principal European goods imported are printed muslins and calicoes from Manchester, silks, beads, sugar, needles, razors, sword blades, and various other kinds of hardware.—The province of Kano comprises a large and fertile district, with a population of more than 500,000, of whom about one half are slaves.

**KANSAS**, a tribe of Indians of the Dakota family, who have given their name to one of the states of the Union. They are an offshoot of the Osages, and resemble them in person, character, customs, and language. They were first heard of by Marquette, who lays them down on his map in 1673 as on the Missouri, beyond the Missouris and Osages. They soon opened friendly intercourse with the French, who in 1700 prevented the Illinois and their allies from attacking them. They were

visited in July, 1724, by De Bourgmont, who was on his way to the Comanches, and was well treated by the Kansas. A Jesuit mission among them is spoken of in 1728. They finally made peace with the Osages in 1806. After Louisiana was ceded to the United States, government made a treaty of peace with the Kansas, Oct. 28, 1815. They were at this time on the river Kansas at the mouth of the Saline, having been forced from the right bank of the Missouri by the Sioux. They numbered about 1,500 in 130 earthen lodges. They had been hostile, but were then friendly. They defended themselves bravely against the Pawnees and Ottoes, but in 1819, at the instance of Major Long, their chief Herochabe made peace with the Ottoes and other tribes. Some chiefs accompanied Major O'Fallen to Washington about 1820. By the treaty of June 8, 1825,

Nampawarrah, or White Plume, and other chiefs, ceded all their lands in Missouri and some west of that state, retaining a reservation 30 m. wide on the Kansas river. Thirty-six sections of good land were to be sold, and the proceeds invested as a school fund. In return government was to give them an annuity of \$3,500 for 20 years, and aid them with domestic animals and farming implements to adopt an agricultural life. They were at this time uncontaminated with the vices of the whites, but were indolent and averse to all improvement. The buffalo was their great dependence, although game of all kinds was beginning to diminish rapidly. Their houses were conical, 40 ft. in circumference and 10 ft. high, formed of poles, covered with bark, and then with sods a foot thick. The frame was supported by wooden posts. Their features were nearly European; they shaved the head, except the scalp lock, which passed through a bone ring, and was adorned with a crest of deer's hair. They had discarded buffalo robes for blankets, and were expert with the rifle. The Methodists began a mission among them in 1835, and labored many years, but failed to produce any impression, or to make their school successful. In 1838 the Kansas had divided into three towns, two on the north bank and one on the south. They could not be induced to cultivate the soil, and being constantly at war with the Pawnees, and in their hunts frequently attacked by other tribes, they lost rapidly in numbers. By the treaty of January, 1846, they ceded certain lands for \$200,000, 5 per cent. on which amount was to be paid annually, and a reservation of 20 m. square was assigned to them on the head waters of the Neosho, S. of the Shawnees and W. of the Sacs and Foxes. In 1849 they had gathered on the Neosho, began to use liquor freely, and to plunder the trains on the Santa Fé road. As Kansas began to be settled their reservations were invaded by whites. In 1856 the half-breeds, who were all Catholics, were forced from their reservation by the squatters, aided by officials. Neither the Kansas nor the half-breeds took any part in the Kansas troubles. Railroad companies, by a treaty of 1854, obtained a right of way through the reservation. During the civil war 80 or 90 entered the United States army, and did good service. In 1862 stone houses were erected, a school was begun by the society of Friends, and an attempt was made again to induce them to cultivate the soil; but these efforts proved ineffectual. Peace was indeed made with the Pawnees, but their reservations were now overrun, and out of 80,000 acres they had only 225 in cultivation; the Indians, with the annual appropriation of \$10,000, were actually starving. They sought to move to Indian territory. A treaty was made with commissioners at Washington in 1867, and another in March, 1869; but by the act of May 8, 1872, government directed their reservation of 80,000 acres, and

their trust lands of 137,000 acres to be sold, half the proceeds to be invested for the benefit, half to be spent in providing and erecting new homes for them within the reservation in Indian territory. Some money to arise from this source, the 1 per cent. on \$200,000 under the treaty of 1846, and the interest on \$27,485 stocks sold by them by government. The tribe about 1840 numbered 1,300; in 1860, 803; in 1872, 311.

**KANSAS**, a western state of the American Union, the 21st admitted, lying between 37° and 40° N., and lon. 94° 40' and 102° W., bounded N. by Nebraska, E. by Missouri, S. by Indian territory, and W. by Colorado. A portion of the boundary on the northeast, adjoining Missouri, is formed by the Missouri river. The state has the general form of a rectangle, extending 410 m. E. and W. and about 210 m. N. and S., and containing 81,318 sq. m. It is divided into 104 counties, of which 31 in 1874 were unorganized, as follows: Allen, Anderson, Annapahoe, Atchison, Barbour, Barton, Bourbon, Brown, Buffalo, Butler, Chase, Cherokee, Clay, Coffey, Cowley, Crawford, Davis, Decatur, Dickinson, Doniphan, Douglas, Edwards, Ellis, Ellsworth, Foote, Ford, Franklin, Gore, Graham, Grant, Greeley, Greenwood, Hamilton, Harper, Harvey, Hodgeman, Howard, Jackson, Jewell, Johnson, Kansas, Kearney, Kingman, Kiowa, Labette, Lane, Leavenworth, Lincoln, Linn, Lyon, Marion, Marshall, McPherson, Meade, Miami, Mitchell, Montgomery, Morris, Nemaha, Neosho, Ness, Norton, Osage, Osborne, Ottawa, Pawnee, Phillips, Pottawatomie, Pratt, Rawlins, Reno, Republic, Rice, Riley, Rooks, Rush, Russell, Saline, Scott, Sedgewick, Sequoyah, Seward, Shawnee, Sheridan, Sherman, Smith, Stafford, Stanton, Stevens, Sumner, Thomas, Trego, Wabancusa, Wallace, Washington, Wichita, Wilson, Woodson, Wyandotte. The cities of Kansas, as reported by the federal census of 1870, were: Atchison, which had 7,054 inhabitants; Baxter Springs, 1,284; Emporia, 2,168; Fort Scott, 4,174; Lawrence, 8,320; Leavenworth, 17,873; Ottawa, 2,941; Paola, 1,811; Topeka, the capital, 8,786; and Wyandotte, 2,940. Kansas had 8,291 inhabitants in 1855, 107,206 in 1860, and 364,398 in 1870. Township and city assessors are required to make every year an enumeration of inhabitants. According to the state census of 1873, the number of inhabitants in the organized counties was 605,063; the population in the unorganized counties was estimated at 5,800, making the total population of the state 610,863, a gain of 246,464, or 67-68 per cent. in three years. Of the total population in 1870, 202,324 were males and 162,173 females; 316,007 were native and 48,393 foreign born; 346,377 were white, 17,108 colored, and 316 Indians. Of those of native birth, 63,321 were born in the state, 35,558 in Illinois, 13,673 in Iowa, 16,918 in Indiana, 29,773 in Missouri, 18,557 in New York, 105 in Ohio, and 18-

Pennsylvania. Of the foreigners, 5,824 natives of British America, 6,161 of England, 10,940 of Ireland, 1,274 of France, 12,167 of Germany, 4,954 of Sweden, and 1,328 of Switzerland. The density of population was 48 persons to a square mile. There were



State Seal of Kansas.

165 families, with an average of 5.08 persons to each, and 71,071 dwellings, with an average of 5.13 persons to each. In the S. W. part of the state is a settlement of Mennonites. The increase of population from 1860 to 1870 was 39.9 per cent., a much larger gain during any period than is shown in any other state; the relative rank rose from 33 to 29. The number of male citizens 21 years old and upward was 99,069. There were in the state 108,399 persons from 5 to 18 years of age, and 96,314 males from 18 to 45. The total number attending school was 63,183; 16,369 persons of 15 years of age and over were unable to read, 4,550 could not write. Of the 105,680 adults in the state, 8,894, or 8.42 per cent., were illiterate; and of the 69,645 female adults, 10,000, or 13.2 per cent., were illiterate. The number of paupers supported during the year ending June 1, 1870, was 361, at a cost of \$46,300. Of the total number (336) receiving support June 1, 1870, 190 were natives and 146 foreigners. The number of persons convicted of crime during the year was 151. Of the number (329) in prison June 1, 1870, 262 of native and 67 of foreign birth. The prison contained 128 blind, 121 deaf and dumb, 100 sane, and 109 idiotic. Of the total population 10 years of age and over (258,051), there were engaged in all occupations 123,852 persons in agriculture, 73,228, including 21,714 agricultural laborers and 50,820 farmers and ranchmen; in professional and personal services, 10,000, of whom 538 were clergymen, 4,481 domestic servants, 72 journalists, 7,871 laborers unclassified, 682 lawyers, 906 physicians and surgeons, and 6,012 teachers not specified; in manufacturing and transportation, 11,762; in manufacturing and mechanical and mining industries, 10,000, including 4,138 blacksmiths, 625 boot

and shoe makers, 5,064 carpenters, and 1,466 brick and stone masons. The total number of deaths returned by the census of 1870 was 4,596; there were 418 deaths from consumption, or one death from that disease to 11 from all causes; 599 from pneumonia, 354 from scarlet fever, 240 from intermittent and remittent fevers, and 204 from enteric fever. The Indians remaining in Kansas, not enumerated in the census of 1870, are the Kickapoo, 290 in number, on a reservation of 19,200 acres in the N. E. part of the state; the prairie band of the Pottawattamie, about 400, on a reservation of 77,357 acres 14 m. N. of Topeka; and about 56 Chippewas and Muncies, who own 5,760 acres of land about 35 m. S. of Lawrence. —The general surface of Kansas is an undulating plateau, which gently slopes from the western border, where the altitude above the sea is about 3,500 ft., to the eastern line, which is elevated about 750 ft. above the sea at the mouth of Kansas river. The river bottoms are generally from one fourth of a mile to 3 m. wide, but toward the western part of the state, on the Arkansas and Republican rivers, they are from 2 to 10 m. wide. Back from the bottom lands, bluffs rise to a height of from 50 to 300 ft., with a slope of 20° to 30°. From the summits of these bluffs may be seen a succession of rolls, or upland prairies, whose tops are from a quarter of a mile to a mile apart, and from 20 to 80 ft. above the intervening valley. The general inclination of the ridges is N. and S. There is no portion of the state which is flat or monotonous. The surface of eastern Kansas is chiefly undulating, and presents a succession of rich prairies, grass-covered hills, and fertile valleys, with an abundance of timber on the streams. The western half is not so diversified in its scenery, but it has a rolling and varied surface, with every requisite for a fine grazing country. Kansas is well supplied with rivers. On the E. border of the state the navigable Missouri presents a water front of nearly 150 m. The Kansas is formed by the confluence of the Republican and Smoky Hill rivers near Junction City, whence it flows in an E. course about 150 m. to the Missouri near Kansas City. It is not navigable, though steamboats have ascended to Junction City on the Smoky Hill. The latter has its source near the Rocky mountains in Colorado; it receives from the north in Kansas the Saline river, about 200 m. long, and the Solomon, 300 m. The Republican river rises in Colorado, and after flowing through N. W. Kansas into Nebraska, enters Kansas again about 150 m. W. of the E. border of the state; it is more than 400 m. long from its source. The Kansas receives from the north the Big Blue river, which rises in Nebraska and is about 125 m. long, and the Grasshopper, about 75 m.; on the south, it receives near Lawrence the Wakarusa, which is nearly 50 m. long. About two thirds of the state lies S. of the Kansas and Smoky Hill rivers, and is there-



fore called southern Kansas, the remainder being known as northern Kansas. The Osage river rises in the E. part of the state, and after a S. E. course of about 125 m. enters Missouri. The most important rivers having a southerly course are the Neosho, which rises in the central part of the state, and after a S. E. course of about 200 m., during which it receives the Cottonwood and other streams, enters the Indian territory about 25 m. W. of the S. E. corner of Kansas; the Verdigris, which flows nearly parallel with the Neosho into the Indian territory, receiving Fall river on the west; and the Arkansas, which has its sources in the Rocky mountains in Colorado. This river runs through nearly three fourths of the length of Kansas, first E. and then S. E., and with its tributaries waters two thirds of the southern part of the state. Its windings in Kansas have been estimated at 500 m. Its tributaries on the N. or E. side include the Walnut, the Little Arkansas, and Cow creek. In the S. W. corner, the Cimarron flows for a considerable distance in the state. The above constitute only the most important of the rivers of Kansas; there are numerous tributaries of these from 25 to 75 m. long, which with the main streams make Kansas one of the best watered of the western states; but none of them are navigable.—No thorough geological survey of Kansas has yet been undertaken; but preliminary examinations have been made by Professors G. C. Swallow and B. F. Mudge. The eastern portion of the state belongs to the carboniferous system, in which are found all the bituminous coal measures of the state. The greater part of this area is the upper carboniferous, the lower carboniferous only coming to the surface in the S. E. corner. This formation is composed of many different strata of limestone, sandstone, coal, marls, shales, fire clay, slate, selenite, &c., varying in thickness, and occurring irregularly. The carboniferous system is divided by Prof. Swallow into the following series: upper coal, 391 ft. thick; chocolate limestone, 79; cave rock, 75; Stanton limestone, 74; spring rock, 80; well rock, 238; Marais des Cygnes coal, 303; Pawnee limestone, 112; Fort Scott coal, 142; Fort Scott marble, 22; lower coal, 350; lower carboniferous, 120; total, 1,986 ft. Some of these series, however, are only local. Further west is the upper and lower Permian system, having a depth of about 700 ft., and containing numerous strata of magnesian limestone and beds of gypsum. This system is supposed to extend across the state from N. to S. in an irregular belt about 50 m. wide. Adjoining it on the west is a tract belonging to the triassic system, the strata of which have a thickness of 338 ft., and are composed of limestone, sandstone, thin coal veins, gypsum, selenite, and magnesian marls and shales. West of this is the cretaceous formation, extending to the foot hills of the Rocky mountains. It crosses the state in a N. E. and S. W. direction near the mouths

of the Saline and Solomon rivers, these covering the whole western portion of the state. Prof. Mudge says: "This is one of the richest deposits of the United States in its fossils, and possesses great geological interest. It not only abounds in well preserved fossils, similar to those of other parts of the United States, as well as of Europe, but contains many species new to science. The predominant fossils of the eastern part of this formation are dicotyledonous leaves, of which about 50 species have been found, a dozen of which are new to science. Among these is the cinnamon, now growing only in torrid climes. More westerly are quantities of the remains of sharks and other fish, equaling in size the largest now known; also snakes and other amphibians, of large size and peculiar forms." Fifteen specimens of marine shells, three of reptiles, and five of fishes, previously unknown, were obtained here. The coal-bearing region of Kansas occupies the entire E. portion of the state, having a general width from E. to W. of about 120 m., and embracing an area of about 17,000 sq. m. Throughout this region outcroppings of bituminous coal appear. Many of the veins are thin, but some of them are 7 ft. thick and produce a good quality of bituminous coal; mining is extensively carried on at several points. Coal is also found in the W. part of the state, but of inferior quality. In this region salt also exists in large quantities in numerous springs and extensive salt marshes. The salt deposit embraces a tract about 80 by 35 m., covering the Republican, Solomon, and Saline valleys. Salt is also found S. of the Arkansas river. On the W. border of the state there is an extensive deposit of crystallized salt in beds from 6 to 28 in. thick. It has not, however, been made available for commercial purposes, in consequence of the difficulty of access. Analyses of Kansas salt show it to be of remarkable purity, entirely free from chloride of calcium. Iron ores have been found in various localities, but not of a character to be profitably worked. Lead, alum, limestone suitable for hydraulic cement, petroleum, deposits of paints, lime, excellent building stone, and brick and other clays are found.—Perhaps no other western state has so pleasant and beautiful a climate as that of Kansas, or so many bright sunny days. The winters are milder than in the same latitude further east, the temperature rarely falling below zero. According to observations covering five years made by Prof. Snow, Kansas had more sun during the seven months from March 1 to Oct. 1 than any other of 19 northern and western states with which comparison was made; and less during the winter months than any other except one. In summer the temperature ranges from 80° to 100°, but the air is dry and pure, while the nights are invariably cool and refreshing. The extraordinary clearness of the atmosphere is remarked by all strangers. The most

disagreeable feature of the climate is the severe winds which sweep over the prairies during the winter months from the northwest; during summer, pleasant S. W. breezes prevail. The mean annual temperature for five years was 52° 8': spring, 52° 2'; summer, 75° 5'; autumn, 54° 3'; winter, 29° 1'. The average annual rainfall was 41.09 in.: spring, 10.82; summer, 18.6; autumn, 9.79; winter, 5.42; from March 1 to Oct. 1, 34.15. The climate of Kansas is said to be highly favorable to consumptives and those suffering with asthmatic or bronchial complaints; the central and W. portions are singularly free from the diseases which prevail in miasmatic regions and mountain districts, such as fever and ague, and rheumatic and acute febrile diseases.—The soil of Kansas is highly favorable to agriculture. On the bottom lands it is from 2 to 10 ft. deep, and on the uplands from 1 to 3 ft. In the E. half of the state it is a black sandy loam intermixed with vegetable mould. In the W. part the soil is light-colored, and is deeper than that of eastern Kansas, being from 2 to 10 ft., but it contains less vegetable mould. The soil of the entire state is rich in mineral constituents; this feature, together with an unusually good drainage, gives to it valuable qualities for the growth of vegetation. Reports covering nine years show that the average production of Indian corn per acre was 18 to 48.4 bushels, wheat 11.6 to 21.4, rye 17 to 25.8, oats 25 to 43, barley 23 to 38, potatoes 85 to 149. Fine grazing and good hay are afforded by the prairie grasses which everywhere abound, growing from 1 to 6 ft. high. The plains in the W. part of the state are covered with a small grass, which has a short curled leaf and spreads on the ground like a thick mat. It is known as buffalo grass, and is extremely sweet and nutritious. Good timber is well distributed throughout the E. part of the state, being generally found along streams and adjacent ravines. The abundance of coal and stone, however, diminishes the need of wood for fuel or building purposes. The most abundant kinds of trees are oak, elm, black walnut, cottonwood, box elder, honey locust, willow, hickory, sycamore, white ash, and hackberry. The buffalo, elk, deer, antelope, prairie dog, squirrel, horned frog, prairie hen, grouse, wild turkey, wild goose, and many varieties of small birds are found. The rearing of cattle is a prominent industry, and the W. part of the state presents unusual advantages for sheep raising.—According to the census of 1870, there were 5,656,879 acres of land in farms, including 1,971,003 acres of improved land, 635,419 of woodland, and 3,050,457 of other unimproved land. The total number of farms was 38,292; there were 5,478 containing between 10 and 20 acres, 13,744 between 20 and 50, 8,732 between 50 and 100, 5,346 between 100 and 500, 42 between 500 and 1,000, and 13 over 1,000. The cash value of farms was \$90,327,049; of farming implements and ma-

chinery, \$4,053,312; total amount of wages paid during the year, including value of board, \$2,519,452; total (estimated) value of all farm productions, including betterments and additions to stock, \$27,630,651; value of orchard products, \$158,046; of produce of market gardens, \$129,013; of forest products, \$368,947; of home manufactures, \$156,910; of animals slaughtered or sold for slaughter, \$4,156,386; of all live stock, \$23,173,185. The number of acres under cultivation was returned at 2,476,862 in 1872, and 2,962,599 in 1873; the value of farm productions in the former year was \$25,265,109. The chief agricultural productions in 1870 and 1873 were as follows:

PRODUCTIONS.	1870.	1873.
Wheat, spring, bushels.....	1,814,522	.....
" winter.....	1,748,676	.....
Indian corn.....	17,923,525	29,668,848
Rye.....	83,297	891,957
Oats.....	4,097,925	2,837,881
Barley.....	95,405	508,002
Buckwheat.....	27,826	76,929
Peas and beans.....	13,109	.....
Potatoes.....	2,392,531	.....
Grass seed.....	8,023	.....
Flax seed.....	1,553	.....
Hay, tons.....	490,259	.....
Hemp, lbs.....	78,400	1,410,804
Flax.....	1,040	.....
Cotton.....	3,500	251,222
Tobacco.....	83,241	858,522
Wool.....	335,605	.....
Butter.....	5,022,738	4,804,098
Cheese, farm.....	226,607	143,932
" factory.....	.....	131,173
Honey.....	119,527	133,254 (1872)
Wax.....	2,208	3,688 (1872)
Wine, gallons.....	14,889	84,505
Milk sold.....	196,662	.....
Orchard products, bushels.....	.....	718,954
" " value.....	.....	\$356,977
Grapes, lbs.....	.....	528,120 (1872)
" " value.....	.....	\$42,441

The number of domestic animals on farms reported by the census of 1870, and the number and value of all in the state as reported by the state authorities in 1873, were:

ANIMALS.	1870.	1873.	Value in 1873.
Horses.....	117,786	176,161	\$10,298,499
Mules and asses.....	11,746	17,516	1,262,971
Milk cows.....	128,440	.....	.....
Sheep.....	109,065	51,166	119,723
Pigs.....	36,527	34,701	2,068,468
Cattle.....	250,527	684,021	13,314,441

—Though having an abundance of water power, Kansas has not yet attained a high rank in manufacturing industry, the people being devoted chiefly to agriculture, stock raising, and fruit growing. According to the census of 1870, the total number of manufacturing establishments was 1,477, having 254 steam engines of 6,360 horse power, and 62 water wheels of 1,780 horse power, and employing 6,844 hands, of whom 6,590 were adult males, 118 adult females, and 127 youth. The capital invested amounted to \$4,319,060; wages paid during the year, \$2,377,511; value of mate-



for his debts. She may convey her property, or make contracts concerning it. She may sue and be sued, in the same manner as an unmarried woman, and may carry on any trade or business and have full control over her earnings. Neither husband nor wife may bequeath more than one half of his or her estate away from the other without written consent. Divorces may be granted by the district court, among other causes, for abandonment for one year, adultery, impotency, extreme cruelty, drunkenness, gross neglect of duty, and imprisonment in the penitentiary subsequent to marriage. The plaintiff must have resided a year in the state. In actions for libel, the truth published with good motives and for justifiable ends may constitute a good defence. The legal rate of interest is limited to 12 per cent. Kansas is represented in congress by two senators and three representatives, and has therefore five votes in the electoral college. The total state debt, Jan. 1, 1874, was \$701,550; bonded school debt of counties, \$1,928,585; municipal debt, \$10,899,445; aggregate, \$13,529,580. The income and disbursements of the various funds were as follows:

SOURCES.	Receipts.	Disbursements.	Balance.
General revenue.....	\$744,856 99	\$638,655 68	\$106,201 16
Interest fund.....	144,775 11	98,408 00	46,367 11
Sinking fund.....	47,229 96	6,905 00	40,324 96
Annual school fund.....	249,771 62	237,220 23	12,551 39
Permanent school fund.....	281,164 61	229,625 97	51,538 64
Military fund.....	7,516 89	3,500 00	4,016 89
Insane asylum fund.....			80
Railroad fund.....	8,210 88	6,000 81	2,150 87
Penitentiary fund.....			3,272 00
Int. on municipal bonds.....	58,389 16	54,280 79	4,108 37
<b>Total.....</b>	<b>\$1,498,865 42</b>	<b>\$1,291,860 18</b>	<b>\$206,977 49</b>

The value of taxable property, as fixed by the state board, and the amount and rate of taxation since Kansas became a state, are shown in the following table:

YEARS.	Taxable property.	Rate.	Tax levied.
1851.....	\$24,744,838	3 mills.	\$74,238
1852.....	19,255,749	5 "	101,469
1853.....	25,461,400	5 "	127,302
1854.....	30,702,791	5 "	152,384
1855.....	36,227,290	5 "	181,186
1856.....	50,489,634	4 "	201,700
1857.....	56,276,360	5 "	231,381
1858.....	66,949,549	4 1/2 "	315,407
1859.....	76,388,697	10 "	763,886
1860.....	92,528,099	7 1/2 "	699,620
1871.....	108,758,575	6 "	652,521
1872.....	127,680,987	7 1/2 "	1,065,872
1873.....	125,684,176	6 "	754,106

The state government is supported chiefly by a tax directly upon the people, the assessment being made upon a cash valuation of all the real and personal estate, including the property of railroad companies and other corporations. The asylums for the insane, deaf and dumb, and blind are each controlled by a board of six trustees appointed by the governor and senate. The asylum for the insane at

Osawatomie is greatly inadequate to the needs of the state. The number of patients at the close of 1873 was 121; the current expenses for the year amounted to \$28,221. Since the opening of the asylum in 1863, 378 persons have been admitted, of whom 161 have been discharged recovered, 88 improved, 26 stationary, and 19 died. The asylum for the deaf and dumb at Olathe, organized by the legislature in 1866, is intended to afford instruction, without charge for board or tuition, to all the deaf and dumb of the state between the ages of 10 and 21 years. The course of instruction covers six years, but may be extended in certain cases. Students are also required to devote time to industrial pursuits with a view of being able to obtain a livelihood after leaving the institution. By this means a considerable income is created for the asylum. In 1873 there were 5 instructors and 77 pupils, of whom 52 were in attendance at the close of the year. The amount appropriated by the legislature was \$36,604, including \$20,000 for additional buildings. The institution for the blind, founded in 1867, is at Wyandotte. It comprises educational and industrial departments, and in 1873 had 4 instructors and 33 pupils. The cost of the institution in that year was \$11,590. The state penitentiary at Leavenworth at the end of 1873 had 340 convicts, of whom 19 had been sentenced by the United States and 49 by military courts; 25 had been convicted of murder, 11 of manslaughter, 10 of assault with intent to kill, 173 of larceny, 32 of burglary, 15 of robbery, and 15 of rape. The disbursements for 1873 were \$126,267; the resources amounted to \$189,607, including \$70,000 appropriated by the legislature and \$54,232 received from prisoners' labor, boarding United States prisoners, &c. Some of the convicts are employed in various industrial pursuits within the prison, while others are employed under contract outside. Convicts may receive a percentage of their earnings. In 1873, for want of a state reform school, 75 boys from 15 to 20 years of age were confined in the penitentiary.—The constitution requires the legislature to "encourage the promotion of intellectual, moral, scientific, and agricultural improvement, by establishing a uniform system of common schools, and schools of a higher grade, embracing normal, preparatory, collegiate, and university departments." The proceeds of all lands granted by the United States to the state for schools, and of the 500,000 acres granted to each of the new states by congress in 1841, all estates of persons dying without heir or will, and such percentage as may be granted by congress on the sale of lands in this state, are made a perpetual school fund. The income of the state school funds is required to be disbursed annually among the school districts; but no district is entitled to receive any portion of such funds in which a common school has not been maintained at least three

months in each year. General educational interests are under the supervision of a state superintendent of public instruction, and there is a superintendent in each county. The board of education consists of the state superintendent, the chancellor of the state university, the president of the state agricultural college, and the principals of the state normal schools at Emporia and Leavenworth. A prominent duty of the board is to issue diplomas to such teachers as pass the examination. The state institutions of learning are governed by a board of seven regents, of whom one is an *ex officio* member and six are appointed by the governor and senate. According to the census of 1870, the whole number of schools was 1,689, having 1,955 teachers, of whom 872 were males and 1,083 females, and attended by 59,882 pupils. Of these, 1,663 were public schools, with 1,864 teachers and 58,030 pupils; 5 were colleges, with 27 teachers and 489 students; 6 were academies, with 36 teachers and 415 pupils; and 4 were private schools, with 4 teachers and 115 students. The total income of all the educational institutions was \$787,226, of which \$19,604 was from endowment, \$678,185 from taxation and public funds, and \$89,437 from tuition and other sources. In 1873 there had been organized 4,004 school districts, in which there were 3,133 school houses. The entire school population of the state (between 5 and 21 years of age) numbered 184,957, of whom 121,690 were enrolled in the public schools, the average daily attendance being 71,062. There were 1,880 male teachers, receiving an average monthly salary of \$38 43, and 2,143 female teachers, whose average monthly salary was \$30 64. The permanent school fund was \$1,013,982, including \$1,008,682 interest-bearing securities. The income from various sources for public schools amounted to \$1,657,318, including \$931,958 from district tax and \$231,917 received from state fund. The total expenditures for schools were \$1,483,676, including \$716,056 for teachers, \$51,504 for rent and repair of buildings, \$160,723 for furniture, apparatus, &c., \$515,071 for buildings and sites, and \$79,812 for miscellaneous items. The total value of school houses was \$3,408,956; of apparatus, \$33,873. Kansas has four state normal schools for the free training of public school teachers: one at Emporia, organized in 1865; one at Leavenworth, in 1870; one at Quindaro, in 1871; and one at Concordia, in 1874. The first named has a normal department, which affords a two years' and a four years' course of study, and a model department. The number of students in 1873 was 218, the disbursements \$17,829. The school at Leavenworth comprises a normal department, which affords a thorough knowledge of all subjects taught in the public schools of the state, and a model school in which the art of teaching may be practised. This model school comprises 13 grades or departments, in which in 1873 there were 1,100

pupils receiving instruction from 15 teachers. In the normal department there were 7 teachers and 68 students. The Quindaro normal school is for colored persons, and was attended in 1873 by 82 pupils. The state university is at Lawrence. The plan of the institution comprises six departments: 1, science, literature, and the arts; 2, law; 3, medicine; 4, theory and practice of elementary instruction; 5, agriculture; 6, normal department. In 1874 only one of these departments had been organized; this comprised a classical course, a scientific course, and a course in civil and topographical engineering. There were then 11 instructors and 272 pupils, of whom 73 were in the collegiate and 199 in the preparatory department. No charge is made for tuition. The university already has valuable collections in natural history, and a considerable library. The magnificent building of the institution, 246 ft. long, 98 ft. wide in the centre and 62 in the wings, contains 64 rooms, including an immense hall, to be devoted to purposes of instruction. The state agricultural college at Manhattan has received the national grant of lands made for the establishment of colleges of agriculture and the mechanic arts. The aim of the institution is to afford an industrial rather than a professional education. Four general courses of instruction are provided: the farmer's, the mechanic's, the commercial, and the woman's. The farm contains 200 acres of prairie upland, so arranged as to afford the best facilities for teaching the applications of science to agriculture and making practical experiments. The nursery of 61 acres contains the largest and most valuable assortment of fruit and forest trees west of the Mississippi river. The mechanical department embraces carpenter, wagon, blacksmith, paint, and harness shops. Women are taught sewing, printing, telegraphy, photography, and other branches. Tuition in all departments is free. The principal colleges are St. Benedict's (Roman Catholic), at Atchison, founded in 1859, which in 1873 had 7 instructors and 94 pupils; Washburn college (Congregational), at Topeka, founded in 1865, having 5 instructors and 93 students; Highland university (Presbyterian), with 4 instructors and 137 students; Baker university (Methodist Episcopal), at Baldwin City, with 8 instructors and 65 students; college of the sisters of Bethany (Episcopal), at Topeka, with 10 instructors and 65 pupils; and Ottawa university (Baptist), at Ottawa. The Kansas academy of science was organized in 1868 as a society of natural history, but was enlarged in its scope in 1871, and incorporated by the legislature the following year. In its present form it comprehends observers and investigators in every line of scientific inquiry, and aims to increase and diffuse knowledge of science particularly in its relation to Kansas. The society has made valuable contributions to the knowledge of the state in geology, botany, ornithology, ichthyology, en-

tomology, and meteorology, and designs in time to make a complete scientific survey of the state.—According to the census of 1870, there were in the state 574 libraries, having 218,676 volumes; 364, with 126,251 volumes, were private, and 190, with 92,425, were other than private, including 4 circulating libraries with 6,550 volumes. The state library in 1874 contained about 10,000 volumes. The number of newspapers and periodicals in 1870 was 97, with an aggregate circulation of 96,803; copies annually issued, 9,518,176; 12 were daily, circulation 17,570; 4 tri-weekly, circulation 1,840; 78 weekly, circulation 71,398; and 8 monthly, circulation 6,000. The number of religious organizations of all denominations was 530, having 301 edifices, with 102,135 sittings, and property valued at \$1,722,700. The denominations were represented as follows:

DENOMINATIONS.	Congreg- ations.	Edifices.	Sittings.	Property.
Baptist, regular.....	91	56	18,540	\$247,900
Christian .....	35	16	4,550	45,300
Congregational .....	43	29	8,350	152,000
Episcopal, Protestant .....	14	9	8,290	57,500
Evangelical Association .....	2	1	370	6,000
Friends .....	7	7	1,600	13,300
Jewish .....	2	1	300	1,500
Lutheran .....	9	5	1,400	12,500
Methodist .....	166	74	23,525	316,600
Presbyterian, regular .....	84	55	20,761	277,900
Presbyterian, other .....	10	7	2,150	24,500
Reformed Church in the United States (late German Reformed).....	1	1	275	3,000
Roman Catholic .....	37	84	14,675	513,200
Unitarian .....	2	1	470	20,000
United Brethren in Christ .....	24	8	2,200	31,500

—Kansas was annexed to the United States in 1803 as part of the territory bought from France under the general designation of Louisiana. By the Missouri compromise bill of 1820 it was provided "that in all the territory ceded by France to the United States under the name of Louisiana which lies N. of lat. 36° 30' N., excepting only such part thereof as is included within the limits of the state [Missouri] contemplated by this act, slavery and involuntary servitude, otherwise than in the punishment of crime whereof the party shall have been duly convicted, shall be and is hereby forever prohibited." By an act of congress passed in May, 1854, the territories of Kansas and Nebraska were organized, and in section 14 of this act it was declared that the constitution and all the laws of the United States should be in force in these territories except the Missouri compromise act of 1820, "which . . . is hereby declared inoperative and void." The question of slavery was thus left to the decision of the inhabitants of the territory. This formed the leading topic of discussion in congress, and caused a great agitation throughout the country. About a month previously the legislature of Massachusetts had incorporated the Massachusetts emigrant aid company, for the purpose of assisting emi-

grants to settle in the new territories, by giving them useful information, procuring them cheap passage over railroads, and establishing mills and other conveniences at central points in the new settlements. In July the legislature of Connecticut granted a charter to a similar company. A large immigration into Kansas from the northwestern states had already taken place, and emigrants in considerable numbers from the free states and a few from the slave states now availed themselves of the opportunities for cheap transportation offered by these companies to settle in Kansas. A party of 80 men led by Mr. Branscomb founded the town of Lawrence, and were soon after joined by 60 or 70 more led by Mr. Charles Robinson and S. C. Pomeroy. Settlers from Missouri were at the same time passing into Kansas, in many cases taking their slaves with them. On July 29, 1854, a public meeting, called by the "Platte County Defensive Association," was held at Weston, Mo., and resolutions were adopted and published declaring that the association would hold itself in readiness, whenever called upon by any of the citizens of Kansas, "to assist in removing any and all emigrants who go there under the auspices of northern emigrant aid societies." On Aug. 13 another meeting was held at Weston, at which resolutions were adopted, declaring in favor of the extension of slavery into Kansas. It also appears from a congressional investigation ordered in 1856, that before any elections were held in the territory a secret society was formed in Missouri for the purpose of extending slavery into Kansas and other territories. This was to be done by sending voters into the territory. Andrew H. Reeder of Pennsylvania had been appointed governor by President Pierce, and arrived in Kansas Oct. 6. An election for a territorial delegate to congress was held Nov. 29. The polls were taken possession of by armed bands from Missouri, and out of 2,843 votes cast it was subsequently estimated by a congressional investigating committee that 1,729 were illegal. On March 30, 1855, another election for members of the territorial legislature was held, and the polls were again taken possession of by large bodies of armed men from Missouri, who, after electing pro-slavery delegates from every district, returned to their own homes in the adjacent state. From the investigation by the congressional committee it appeared that out of 6,218 votes cast at this election, only 1,410 were legal, of which 791 were given for the free-state or anti-slavery candidates. From six of the districts, evidence of the illegal nature of the proceedings having been laid before Gov. Reeder, he set aside the returns and ordered new elections in those districts, which resulted in the choice of free-state delegates, except at Leavenworth, where the polls were again seized by Missourians. Gov. Reeder soon after visited Washington to confer with the federal authorities, and after his return his removal from the office

of governor was announced, July 26, for the alleged reason of irregular proceedings in the purchase of Indian lands. The territorial legislature assembled at Pawnee, July 3, but two days afterward adjourned to Shawnee mission, near the Missouri line, where they reassembled July 16, and remained in session till Aug. 30. One of their first acts was to expel the free-state men chosen at the second elections ordered by Gov. Reeder, and to give their seats to the pro-slavery men originally returned. They also passed an act making it a capital offence to assist slaves in escaping either into the territory or out of it; and felony, punishable with imprisonment at hard labor from two to five years, to conceal or aid escaping slaves, to circulate anti-slavery publications, or to deny the right to hold slaves in the territory; also an act requiring all voters to swear to sustain the fugitive slave law; and they also adopted in a body the laws of Missouri, and passed an act making Leecompton the capital of the territory. Wilson Shannon of Ohio was appointed governor in place of Mr. Reeder, and assumed office Sept. 1. A few days later a convention of the free-state party was held at Big Springs, and, after protesting against the acts of the legislature, nominated ex-Governor Reeder as delegate to congress, and appointed Oct. 9 as the time for holding the election, when Gov. Reeder received about 2,400 votes. Delegates were subsequently chosen to a constitutional convention, which assembled at Topeka Oct. 23, and sat till Nov. 12, when they promulgated a constitution for the state of Kansas in which slavery was prohibited. The contest between the free-state and pro-slavery parties now grew to such a pitch of violence that several men were killed on each side, and the people of Lawrence began to arm for self-defence. The governor called out the militia. A large number of Missourians enrolled themselves as Kansas militia, and Lawrence for some days was in a state of siege; but the difficulty was temporarily adjusted by negotiation, and the Missourians retired to their own state. On Dec. 15 the people voted upon the question of accepting the Topeka constitution, and the pro-slavery men abstaining from participation, it was accepted with only 45 votes against it, exclusive of Leavenworth, where the polling was prevented by an inroad from Missouri. On Jan. 15, 1856, an election was held for state officers and a legislature under the Topeka constitution, and Charles Robinson was chosen governor. The legislature met at Topeka March 4, and, after organizing and inaugurating the governor and other officers, adjourned to July 4. Early in April a considerable body of armed men from Georgia, Alabama, and other southern states, led by Major Buford, arrived in Kansas. On the 17th of the same month a special committee of the United States house of representatives, appointed about a month before, and charged to investigate the troubles in the ter-

ritory of Kansas, arrived at Lawrence. The result of their investigations was a report by the majority of the committee, Messrs. Howard of Michigan and Sherman of Ohio, in which they said: "Every election has been controlled, not by the actual settlers, but by citizens of Missouri; and, as a consequence, every officer in the territory from constable to legislators, except those appointed by the president, owe their positions to non-resident voters. None have been elected by the action, and your committee have been unable to find that any political power whatever, however unimportant, has been exercised by the people of the territory." Mr. Oliver of Missouri, its third member of the committee, made a minority report, in which he said that there was no evidence that any violence was resorted to, or force employed, by which men were prevented from voting. On May 5 the grand jury of Douglas county found indictments against Reeder, Robinson, Lane, and other free-state leaders, for high treason, on the ground of their participation in the organization of a state government under the Topeka constitution. Reeder and Lane escaped from the territory, but Robinson was arrested and kept in prison for four months. The United States marshal took Buford's men into pay, and armed them with government muskets. Lawrence was again besieged by a large force, and on May 21, under a promise of safety to persons and protection to property, the inhabitants gave up their arms to the sheriff. The invaders immediately entered the town, blew up and burned the hotel, burned Mr. Robinson's house, destroyed two printing presses, and plundered several stores and houses. A state of civil war now spread through the territory, the free-state party being furnished with contributions of arms and money from non-slaveholding states. On May 26 a fight in which five men were killed, occurred at Pottawattamic, where John Brown with a band of free-state men was encamped; and on June 2 there was another at Black Jack, which resulted in the capture of Capt. Pate together with 30 of his men. Similar affairs, attended with loss of life, continued to occur for three or four months. Parties of emigrants from the free states on their way through Missouri were in many cases stopped and turned back. The free-state legislature met at the appointed time (July 4) at Topeka, and was forcibly dispersed by United States troops under Col. Sumner. On Aug. 14 the free-state men assailed and took a fortified post near Leecompton, occupied by Col. Titus with a party of pro-slavery men, and captured Titus and 20 other prisoners. On Aug. 17 a treaty was agreed to between Gov. Shannon and the free-state men, by which Shannon restored the cannon taken at Lawrence, and received in exchange Titus and the other prisoners. A few days later Shannon received notice of his removal from office, John W. Geary of Penn-

sylvania being appointed in his stead. Mr. Woodson, the secretary of the territory, and acting governor before Geary's arrival, on Aug. 25 issued a proclamation declaring the territory to be in a state of rebellion. He collected a considerable armed force at Lecompton, while another body, amounting to 1,150 men, assembled under the Hon. David R. Atchison, late U. S. senator from Missouri, at a point called Santa Fé. On Aug. 29 a detachment from Atchison's army attacked Osawatomie, which was defended by a small band under John Brown, who made a vigorous resistance, but were defeated with the loss of two killed, five wounded, and seven prisoners. Five of the assailants were killed, and 30 buildings were burned. The next day a body of free-state men marched from Lawrence to attack Atchison's army. On their approach the latter retired with his forces into Missouri. On Sept. 1 the annual municipal election took place at Leavenworth. A party, chiefly from Missouri, killed and wounded several of the free-state men, burned their houses, and forced about 150 to embark for St. Louis. On Sept. 8 Gov. Geary arrived at Lecompton, and Robinson and the other prisoners held on a charge of treason were released on bail. The governor on assuming office issued a proclamation calling upon all bodies of armed men to disband. He also promised protection to the free-state men, who accordingly laid down their arms. But the Missouri men immediately assembled to the number of upward of 2,000, forming three regiments with artillery, and marched to attack Lawrence, under command of a member of the Missouri legislature. Gov. Geary with a force of United States soldiers interposed between them and Lawrence, and finally prevailed upon them to retire. During their retreat a free-state man named Buffum was shot down by a man named Hanes almost in the presence of the governor, who subsequently caused the arrest of Hanes on a charge of murder. The United States district judge Lecompte, who was noted as an active partisan, liberated Hanes on bail, and afterward on *habeas corpus*. Thereupon Gov. Geary forwarded a representation to Washington demanding the judge's removal, and about the middle of December James C. Harrison of Kentucky was appointed in his place. Gov. Geary now reported to the president that peace and order were completely re-established in Kansas. On Jan. 6, 1857, the legislature elected under the Topeka constitution met at Topeka, and organized next day. The United States marshal immediately arrested the president of the senate, the speaker of the house, and about a dozen of the leading members, whom he carried prisoners to Tecumseh on the charge of "having taken upon themselves the office and public trust of legislators for the state of Kansas, without lawful deputation or appointment." The houses, being left without a quorum, met the next day and adjourned till June. Shortly

afterward the territorial legislature, composed entirely of pro-slavery men, chosen at an election in which the free-state men had declined to participate on the ground of its illegality, met at Lecompton, and among other acts passed one providing for the election of a convention to frame a state constitution for Kansas. Meanwhile the house of representatives at Washington had passed a bill declaring void all the enactments of the territorial legislature, on the ground that they were "cruel and oppressive," and that "the said legislature was not elected by the legal voters of Kansas, but was forced upon them by non-residents." The senate refused to pass the bill, and also to confirm the appointment of Harrison in place of Lecompte, who thus remained chief justice of Kansas, never having been actually dismissed. Upon this Gov. Geary resigned his office and quitted the territory. Robert J. Walker of Mississippi was appointed by President Buchanan his successor, with Frederick P. Stanton of Tennessee for secretary. The election for delegates to the constitutional convention was held on June 15. The free-state men generally took no part in it, on the ground that the legislature which ordered it had no legal authority, and that if they attempted to vote they would be defrauded and overborne by intruders from Missouri. About 2,000 votes were cast, while the legal voters in the territory by a recent census numbered about 10,000. At the territorial election held a few months later, the free-state men, being assured by Gov. Walker of protection from intruders, went to the polls and cast about 7,600 votes, to 3,700 votes thrown by the opposite party, electing Marcus J. Parrott delegate to congress, together with 9 of the 17 councilmen and 27 of the 39 representatives. An attempt was made to change this result by means of a false return from Oxford, Johnson co., a place containing 11 houses. It was alleged that at this place 1,624 persons had voted, and a corresponding roll of names was sent in, which on examination proved to have been copied in alphabetical order from a Cincinnati directory. This return, which if accepted would have changed the party character of the legislature by transferring from the free-state to the pro-slavery side eight representatives and three councilmen, was rejected by Gov. Walker as a manifest falsification. Soon after the territorial election the constitutional convention met at Lecompton and adopted a constitution, four sections of which related to slavery, declaring the right of owners to their slaves to be inviolable, and prohibiting the legislature from passing acts of emancipation. This provision alone was to be submitted to the electors at an election to be held on Dec. 21. The ballots cast were to be endorsed "Constitution with slavery" or "Constitution with no slavery," thus securing in any event the adoption of the constitution, several clauses of which, besides those thus submitted, were highly ob-



jectionable to a majority of the people. A provision was inserted in the schedule annexed to the constitution preventing any amendment of that instrument previous to 1864. The promulgation of this constitution caused great excitement in Kansas. Gov. Walker condemned it in the strongest manner, and proceeded at once to Washington to remonstrate against its adoption by congress; but before his arrival there the act had received the approval of the president. Gov. Walker soon after his arrival in Washington resigned, and J. W. Denver of California became governor. At the election of Dec. 21 for the adoption or rejection of the slavery clause, the vote returned was 6,226, more than half of which was from counties along the Missouri border, whose total number of voters by the census did not exceed 1,000. Against the slavery clause there were 569 votes, the free-state men generally abstaining from voting. The constitution being thus nominally adopted, an election for officers under it was to be held on Jan. 4. The territorial legislature at a special session passed an act submitting the Lecompton constitution to the direct vote of the people on the same day with the Lecompton state election, and the result was a majority of 10,226 votes against it. Congress after long discussion referred the matter to the people of Kansas at an election on Aug. 3, 1858, when the Lecompton constitution was again rejected by 10,000 majority. Meanwhile the territorial legislature had called another convention to meet in April to frame a new constitution, which was submitted to the people and ratified by a large majority, though by a small total vote. Shortly after the rejection of the Lecompton constitution by the people, Gov. Denver resigned, and Samuel Medary of Ohio was appointed in his place. The territorial legislature met in January, 1859, and passed an act submitting to the people the question of calling still another constitutional convention. The election was held April 4, and the result was a majority of 3,881 in favor of holding a convention. An election was accordingly held for delegates, and the convention thus chosen met at Wyandotte July 5, and adjourned July 27, after adopting a constitution by a vote of 34 to 18, prohibiting slavery. This constitution was submitted to the popular vote Oct. 4, and was ratified by a vote of 10,421 to 5,530. The first election under it was held Nov. 8, when a delegate to congress and members of the territorial legislature were elected. On Dec. 6, 1859, a representative in congress, state officers, and members of a state legislature were chosen, the governor being Charles Robinson. On Jan. 29, 1861, Kansas was admitted into the Union under the Wyandotte constitution, which with the several amendments since passed is still the supreme law of the state. During the early part of the civil war eastern Kansas suffered much from the irregular warfare, known there as "jay-hawking," which was carried on by confed-

erate raiders from Missouri and Arkansas and the unionists who opposed them. The most prominent of these disorders was the attack made upon Lawrence, Aug. 21, 1863, by a band of confederate guerillas under Col. Quantrell, which resulted in the loss of many lives and much property. During the war Kansas furnished to the federal army upward of 20,000 men.—See "Resources of Kansas," by C. C. Hutchinson (Topeka, 1871).

**KANSAS CITY**, a city of Jackson co., Missouri, the second in the state in population and importance, situated on the right bank of the Missouri river, just below the mouth of the Kansas river, and near the Kansas border, 185 m. W. N. W. of Jefferson City, and 235 m. W. by N. of St. Louis; pop. in 1860, 4,418; in 1870, 32,260, of whom 3,770 were colored and 7,679 foreigners; in 1874, estimated by local authorities at 40,000. The site, which was originally very rough and uneven, has been levelled, and now presents a moderately even appearance, except where a high bluff divides the upper or hill part of the city from the "bottom" or low lands where the railroad depots are. It is not regularly laid out, but the streets are wide, and are graded and sewered, provided with sidewalks, and lighted with gas. The buildings are chiefly of brick. Waterworks are in process of construction. The Missouri is here spanned by a bridge 1,387 ft. long, resting on seven piers, erected at a cost of \$1,000,000. Four lines of street railroad, with an aggregate length of 13½ m., run to various parts of the city and to the suburbs of Wyandotte, Kan., and Westport. The surrounding country is fertile, and abounds in coal, lead, iron, zinc, salt, gypsum, fire clay, and building stone. By means of seven railroads the city commands the trade not only of W. Missouri and Kansas, but also of N. Texas and part of Colorado and New Mexico. These lines, which centre at a common passenger depot, are the Hannibal and St. Joseph; Kansas Pacific; Kansas City, St. Joseph, and Council Bluffs; Leavenworth, Lawrence, and Galveston; Missouri River, Fort Scott, and Gulf; Missouri Pacific; and St. Louis, Kansas City, and Northern. The Kansas City and Memphis and the Kansas City, Wyandotte, and Northwestern railroads are in progress from the city, and the Kansas Midland line is expected to reach this point in 1874. The number of arrivals of steamboats in 1873 was 65. The organization of a system of barge navigation has been much discussed, and promises success. The sales of merchandise at wholesale in 1873 amounted to \$13,844,440; in 1873 to \$15,695,000; at retail in the latter year, to \$5,555,000. The trade in cattle (chiefly from Texas) and in hogs is one of the most important branches. The receipts of cattle in 1871 were 120,827 head; in 1872, 230,802; in 1873, 227,603, valued at \$3,415,035; of hogs in 1871, 41,036; in 1872, 104,639; in 1873, 290,936, valued at \$2,131,177 60. The receipts of horses in

1873 were 4,202; of sheep, 5,975. The packing business is extensive, and has increased with great rapidity. The number of hogs packed in 1868 was 13,000; in 1869, 23,000; in 1870, 36,000; in 1871, 83,000; in 1872, 180,000; and in 1873, 194,944, the products being valued at \$2,339,358. The number of cattle packed in 1872 was 20,500, value of products \$615,000; in 1873, 26,549, value of products \$796,470. There are four large packing houses, with capacity, during the season from Nov. 1 to March 1, for packing 480,000 hogs, and during the year 700,000. The receipts of grain in 1872 were 1,001,298 bushels; in 1873, 1,718,280, including 750,400 of wheat, 836,300 of Indian corn, and 105,200 of oats. The shipments in the latter year were 1,130,880 bushels; products of the mills, 98,500 barrels of flour and 100,000 bushels of corn meal. Manufacturing industry is limited, and with the exception of a few branches is confined to a single establishment of a kind. The principal items are cigars, tobacco, ale and beer, saddles and harness, furniture, brass castings, scales, soap, types, roofing, lightning rods, cooperage, carriages and wagons, crackers, bricks, and blank books. There are 12 banks and branches, with an aggregate capital of \$1,257,500.—The city is divided into six wards, and is governed by a mayor and a board of aldermen. It has a well organized fire department and an efficient police force. The valuation of property in 1872 was \$11,993,060; in 1873, \$12,687,875; taxation in the latter year, \$348,916 56; expenditures, \$836,387 97. There are a city hospital and a workhouse, an orphan asylum, a woman's home, and a Catholic hospital with a large building in process of erection. The public schools are in a flourishing condition. The number of school houses in 1873 was 14, of which 9 were owned by the city and 5 rented; number of schools, 14 (1 high, 10 district, and 3 colored); rooms occupied, 59; sittings, 3,056; teachers, 59; children of school age (5 to 21), 6,636; number enrolled, 4,259; average attendance, 2,224. There are two medical colleges (the Kansas City college of physicians and surgeons and the medical college of Kansas City), a Catholic female college (St. Teresa's academy), an opera house, 2 theatres, 4 daily (1 German), 2 tri-weekly, and 8 weekly (1 German) newspapers, and 1 bi-monthly periodical. The number of churches is 28, viz.: 2 Baptist, 1 Christian, 1 Congregational, 2 Episcopal, 1 German Evangelical, 2 Jewish, 2 Lutheran (1 German), 6 Methodist, 6 Presbyterian, 3 Roman Catholic, 1 Spiritualist, and 1 Unitarian.—Kansas City was laid out in 1830, but its growth was slow till 1856. Its progress was retarded by the civil war, but has since been remarkably rapid. Improved trade relations have recently been formed with Galveston and Houston, Texas, which are expected to enhance greatly the prosperity of the city.

**KANSUH**, a N. W. province of China, bounded N. and N. E. by the desert of Gobi and Mon-

golia, E. by Shensi, S. by Szechuen, and W. by the mountainous districts adjoining the Koko Nor; area, 86,608 sq. m.; pop. about 15,000,000. It comprises a large portion of the ancient kingdom of Tangut. The Hoang-ho traverses the province in a N. E. direction, and receives many affluents. The Peling and Singling mountains are in some places 10,000 ft. high, and on the S. border line of Kansuh and Szechuen are the Kiu-long-shan mountains. Coal exists in the E. part, and gold, silver, copper, and jade are said to be found in the mountains. The climate is cold, and the soil is not generally fertile excepting E. of the Hoang-ho, where the cereals are cultivated to some extent. The Tartars in this province maintain large flocks and herds of sheep and cattle, and wild animals abound. Capital, Lanchow.

**KANT**, Immanuel, a German metaphysician, born in Königsberg, April 22, 1724, died there, Feb. 12, 1804. He was of Scotch descent; his grandfather probably emigrated from Scotland near the close of the 17th century, and settled at Tilsit. His father, John George Cant, came to Königsberg in early life, and followed the trade of a saddler. His mother, Anna Regina Reuter, of German stock, was a woman of a refined and elevated character, and of deep religious feeling. The philosopher was the fourth of their 11 children. He tells us that when a boy he was idle and a truant; yet he also showed zeal in acquiring knowledge, and his parents gave him the best education their slender means would allow. Like Schelling and Hegel, he was first destined to the theological career. From his 8th to his 16th year he was a student in the *Collegium Fredericianum* of his native city, under the care of Dr. Schulz. Ruhnken the philologist was a fellow student, and they pursued together the study of the classics. Here, too, he felt the influence of pietism, then predominant in the college; and also learned the rudiments of the abstract philosophy of Wolf, which had the speculative ascendancy in philosophical and theological schools. But as yet he showed no metaphysical talent, though he was an indomitable worker. His character was influenced by the rigid morality and independence of his father and the piety of his mother. In 1740 he entered the university as a student of theology; but his first attempts at preaching met with such poor success, that he concluded that he was destined for a different career, and applied himself with earnestness to mathematics and the physical sciences. His first essay, written in 1746, at the age of 22, was on "The True Measure of Living Forces," and contained an acute criticism of the arguments of Leibnitz and Descartes, with an attempt to mediate between the German and French schools, by distinguishing between dead and living powers. His father died in 1746; he had lost his mother 11 years before; and, that he might not be a burden upon his uncle, who had already aided him, he was compelled from

that time until 1735 to become a tutor in private families. In the last of these, that of Herr von Kaiserling of Königsberg, his great talents and acquisitions were recognized, especially by the lady of the house; and here he was introduced into cultivated society, wearing off the bashfulness and reserve of a poor student. At length, in 1735, he was able to enter upon the career of academic instructor, for which he had been preparing himself by assiduous study and multifarious reading. His inaugural dissertations, as *magister legendæ*, were *De Igne* and on the "First Principles of Metaphysical Science." In the same year he published anonymously a treatise on the theory of the heavens, dedicated to Frederick the Great, and written in a clear and animated style. Here he prophesied the discovery of new planets, and that the nebulae would be resolved into stars, besides advocating the position that a mechanical construction of nature was not adverse to the belief in a God. Lambert in 1761 advanced similar views, which led (1765-70) to a correspondence between them. From the first Kant was a popular lecturer; several of his courses were always attended by many of the citizens of the active and thriving city of Königsberg, which had a high commercial and political as well as literary rank. His course on physical geography was begun in 1757, and continued to the close of his academic career, receiving fresh additions at each repetition. Kant himself never went beyond his native province, and as seldom as possible away from the city; but he was an eager student of voyages and travels, and extracted all possible information from every traveller he could come across. He also lectured on practical anthropology, the theory of teaching, natural law, the philosophy of religion, ethics, logic, and mathematics. In 1762 he published a treatise on the "False Subtlety of the four Syllogistic Figures," maintaining that only the first is "pure," the others being *ratiociniū hybridū*. The next year he wrote an essay for a prize proposed by the Berlin academy on the "Principles of Natural Theology and Ethics;" but Mendelssohn received the first and Kant the *accessit* prize. He here says that a "real system of metaphysics" had never yet been written; he was already busy with this task. In the same year appeared his work on the "Only Possible Ground of Demonstrating the Being of God," proposing a new form of the ontological proof, and rejecting the other three arguments. Existence, he says, is not a predicate conception, and therefore cannot be proved; but the non-existence of God contains a logical contradiction. The new mode of proof which he advocates, says Erdmann (*Geschichte der Philosophie*, vol. iii., p. 81), reverses the positions of the schools of Descartes and Leibnitz; instead of inferring the existence of God as a consequence from the possibility, he takes the possibility as a consequence, and reasons back to the existence as the ground; if

anything is possible, there is some being, the seat and source of that is possible. The year 1770 is marked by Rosenthal's *Geschichte der Kantischen Philosophie*, vol. xii. of Kant's works) the dividing line between the earlier or tentative period of his speculations and the speculative and systematic. In this year he became a professor at the university. For 15 years the boldest thinker of Germany had been struggling along in obscurity, filling subordinate posts; for example, that of a sub-librarian of the royal library for \$50 a year, conferred on him in 1756, as an "accomplished" and "useful" person. He was indeed offered the professorship of poetry in 1764; but this does not seem to have suited him. The professorship of logic and metaphysics was given him after he had declined invitations to Jena and Erlangen; his salary was to be \$300 per annum. He was content with his native city and university; he wanted to labor in quiet, and work on the great problems which were stirring his mind. His inaugural dissertation, *De Mundi Sensibilis atque Intelligibilis Forma et Principiis*, contains germs of his metaphysical system. It protests against the position that the knowledge of sense and that gained by the understanding are to be distinguished as respectively obscure and clear. There is, he says, a knowledge of sensible phenomena which is distinct, as there may be conceptions of the understanding which are confused. We must distinguish between the matter and the form of our knowledge of sensible objects; the form is given by the ideas of space and time, which are not objectively real, but pure intuitions; and these give us the basis of the sciences of mathematics and geometry. Intellectual knowledge is made up of pure or universal conceptions; as such as are abstracted from the phenomena of sense, but principles by which the understanding is guided, as those of necessity, possibility, causality, &c. Such are some of the positions in which he already arrays himself against materialism on the one hand and dogmatism on the other. In 1773 (Erdmann, *loc. cit.* 87) he wrote about his scheme of a transcendental philosophy, which he hoped to finish in three months; in 1776 it was to be completed the next summer; but not till 1781 did the *Kritik der reinen Vernunft* ("Criticism of the Pure Reason") make its appearance. For 11 years he had been writing and rewriting; the final draft was composed in a few months. He was already 67 years old. His system had been very slow in its growth; for a long time he was hardly conscious of what he was doing at. He was pressed on the one hand by the abstract metaphysics of the idealism of Leibnitz as developed by Wolf; on the other hand, Hume's skepticism, as he says, "awakened him from his dogmatic slumbers." His own work was intended to give their respective rights to both idealism and realism, to metaphysics and materialism; yet, at the same time,

serve as a new basis on which the architectonics of the whole world of knowledge is to be constructed. This system produced a revolution in the world of speculation. Partly on its profoundness, partly on account of novel nomenclature, it was at first slighted, and seemed in danger of lapsing into oblivion. But Kant was now thoroughly wakened, and eager in pressing the scheme, which was the product not only of his own mind but also of the chief systems which had preceded him. His philosophical productivity was as remarkable as had been his previous inactivity. In 1783 appeared his "Prolegomena to a very future System of Metaphysics claimable as a Science;" a more popular exposition and also a more complete analysis, of the notions and problems mooted in the "Critique of Pure Reason." He then endeavored to counteract the five results of the system of pure reason in *Grundlegung der Metaphysik der Sitten* (Metaphysics of Ethics, 1785), and *Metaphysische Anfangsgründe der Naturwissenschaft* (Metaphysical Elements of Natural Science, 1786), completing the exposition of his views on these two branches of philosophy. In 1787 a second edition of the "Critique of Pure Reason" was published, omitting the preface to the first edition, and altering it so as to avoid the charge of idealism which had been generally preferred against his speculation, identified, or rather confounded, by some commentators with the system of Berkeley. This second edition was afterward reprinted, with only verbal alterations, though considered as somewhat compromising the logic of his speculations; but in the two later editions of his works, by Hartenstein and Rosenkranz, the contents of the first edition are also included. The *Kritik der praktischen Vernunft* ("Critique of the Practical Reason," 1788) intended to give the positive aspect of new philosophy in relation to God, freedom, and immortality; it is a further exposition and application of what was given in outline in the "Metaphysics of Ethics," and it contended to give currency to his system among those who had been repelled by the apparently negative conclusions of the "Critique of Pure Reason." Such was the rigor and the vigor of the ethical scheme propounded that for a time it swept away the unmanly stoic ethics and the sentimental system of morality. Even those who thought they detected an inconsistency between the principles of Kant's "Pure Reason" and of the "Practical Reason," hailed the latter work as containing solid proofs of the real being of those supersensible objects which the critical idealism seemed to have reduced to subjective ideas. Its principles were made the basis of systems of divinity by such theologians as Tieftrunk, Stäudlin, Ammon, and what later by Gabler and Wegscheider. The ethical element, the "categorical imperative" was held as the one fixed and saving

point in the midst of the jarring and opposite principles of the different schools in philosophy and theology; and this led to that rationalism, on a moral basis, which for a long time characterized German theology, a very different form of rationalism from the one which subsequently prevailed. To these works, in 1790, Kant added his "Critique of the Judgment," which developed more fully the principles of the metaphysics of the natural sciences, and supplemented many positions in his other treatises, besides giving hints, and opening points of view, which were afterward used by those disposed to go beyond the principles of the critical philosophy.—With this work closed the productive metaphysical period of Kant's philosophic career. He was now 66 years old. In nine years he had put forth, in rapid succession, a series of works which revived the slumbering activity of German philosophy; combated equally the abstractions of the dogmatist and the doubts of the skeptic; set forth the transcendental grounds and elements of knowledge, and thus laid the foundation for a new metaphysics; and planted moral science upon a definite basis, giving it fixed and universal formulas, which already began to affect the construction of the science of Christian theology. His subsequent writings form, according to his own statement, the practical period of his career, applying to different special sciences the principles he had elaborated. His philosophy was already expounded by Kiesewetter in Berlin, Schmid in Jena, Jakob in Halle, Born in Leipzig, and many others in different parts of Germany. Its more definite conflict with the orthodox theology was aroused by the publication of his essays on "Religion within the Bounds of Mere Reason," contributed to the Berlin *Monatschrift*, then prohibited by the censor (re-established in 1788), and issued in a volume in 1793. Political influences were also concerned, for Kant was in sympathy with the French revolution. Frederick William II. sent to him a missive indicating his displeasure, and the philosopher was obliged to give a pledge that he would not lecture on religious subjects "so long as he should be a subject of his majesty," the promise being so worded that he considered himself released from it on the death of that monarch. But he was so irritated by this governmental interference, that in 1794 he gave up all his private lectures, and after 1797 no longer read in the university. In 1797 appeared his "Metaphysics of Ethics," in two parts, viz.: the "Metaphysical Elements of Right" (law), and "of Virtue." The "Strife of the Faculties" (1798) is a review of the controversy about his religious opinions, with the documents concerning it. His *Anthropologie in pragmatischer Hinsicht* ("Anthropology in a Pragmatic Point of View") was published the same year. After this his friends and pupils became the editors of his writings: Jäsche of his "Logic" (1800); Rink of his "Physical Geography" (1802) and

"Pedagogics" (1803). After his death Pölitiz published his lectures on the philosophy of religion (1817) and on metaphysics (1831), and Starke those on the human race (1831). He was disturbed in his later years by the symptoms of a new phase of speculation in the writings of Fichte (whom he had at first warmly welcomed, and whose work on revelation had been attributed to him), and sent forth an ineffectual protest in 1799; this showed a defect which he himself acknowledged in his power of appreciating other systems. An essay on which, in the decline of his faculties, he was for a long time employed, was found to be unintelligible, or only a repetition of what he had previously said upon the relation of physics to metaphysics. Speculation was already sweeping past the monuments he had reared.—To appreciate the character and position of the critical or transcendental philosophy of Kant, we must start with his own view of what philosophy had previously accomplished, and what he expected from his new method. In his own interpretation of the matter, it was the critical method which he instituted that formed the primary peculiarity of his scheme. All previous systems had led to dogmatism (Leibnitz and Wolf), or to skepticism (Hume). Dogmatism asserts the equal objective and subjective validity of its principles; metaphysical truths, like mathematical, hold both in reason and in fact. Skepticism, on the other hand, denies the objective validity of *a priori* truths; thus, for example, Hume could not find in experience anything corresponding to the principle of causality, for sense gives only succession of phenomena; and this truth of causality, says Kant, is only one of a class, to all of which Hume's criticism is equally applicable. Both the dogmatist and the skeptic examine ideas or truths directly, and can never agree. Is there no other way of approaching the matter? Yes, says Kant, there is also the critical method; instead of assuming that our knowledge is determined by the objects, let us see how far the objects are determined by our knowledge. He compared this method, with a proud consciousness, to that of Copernicus, who, finding that he could not explain the motion of the heavenly bodies by supposing that they revolved around himself, tried whether he could not do better by supposing that he moved and the stars stood still. The true way, then, is to start with a criticism of man's power of knowing. And since man has three prime faculties, reason, will (or impulse to action), and feeling, this criticism must be divided into three main parts: the criticism of the pure reason, the criticism of the practical reason (desire and will), and the criticism of judgment (having respect to feeling, or pleasure and pain). The first of these, however, contains the regulating principles for both the others, and gives the key to the system. The "Criticism of the Pure Reason" was not originally intended to be a system of metaphysics, but rather an inquiry into the

possibility of metaphysics; that is, it was intended to show that there are in the human mind *a priori* or transcendental elements of knowledge, and that these are found even in the perceptions of sense and the laws of the understanding. As against the dogmatist, Kant also intended to prove that even this transcendental knowledge does not attain with such certainty to the nature of things; it can neither demonstrate nor disprove the reality of objects corresponding to the ideas of reason. ("Transcendental" is used by Kant, not in respect to the objects of knowledge, but to the nature of the knowledge, as *a priori*.) Another, and in the strictest mode of stating the question and problem, is this: Are *a priori* synthetical judgments possible? An analytical judgment is one which simply explicates, in respect to any subject, what is contained in its very notion; it rests on the principle of identity. But such judgments give us no new knowledge. In a synthetical judgment, on the other hand, something is contained or asserted in the predicate, which is not necessarily implied in the subject; and such judgments extend the bounds of our knowledge. All *a posteriori* knowledge is of this character; and the metaphysical question is: Are such synthetical judgments also possible *a priori*? If they are, in any sphere (e.g., mathematics), sensualism is refuted; if they are not in the highest sphere (metaphysics), dogmatism is refuted. In conducting this inquiry Kant divides the human mind into the three functions of sense, understanding, and reason, and subjects each to a careful criticism. The general scheme, as carried out, is:

- I. Doctrine of the transcendental elements of knowledge.
  - A. Transcendental aesthetics (i. e., perceptions of sense).
  - B. Transcendental logic.
    - a. Transcendental analytics (the understanding).
    - b. Transcendental dialectics (reason, metaphysics).
- II. The transcendental method.

1. *The Transcendental Aesthetics*, or the transcendental knowledge involved in the perceptions of sense. In all knowledge there are two elements, the matter and the form. The one is given by experience, the other by the mind. Sensations without ideas are blind; ideas without sensations are empty. The dogmatist ignores the former, the materialist the latter. What is given us in sensation is ordered or arranged by the mind under the two ideas of space and time, which ideas are not the product but the regulators of the sensations. That is, even in respect to the objects of sense, we find the *a priori* ideas of space and time controlling them; and this knowledge too gives us the possibility of a science, viz., mathematics. But yet this space and time are not forms of the objects of sensation, but the subjective framework in which we put and must put all our sensations. We cannot, then, attain objectively to the knowledge of things as they are in themselves (*Dinge an sich*), because those forms by which we know them are subjective. This denial

the objective validity of space and time is starting point in the negative results of the criticism of the Pure Reason." In the first Kant threw out an intimation, within in the second, that the subject (*ego*) things-in-themselves are possibly one and same substance; this led to the subjective idealism of Fichte. 2. *Transcendental Analysis*. We pass here from the sense to the understanding, or the power of forming general notions. It is by such notions that we command and connect what is given in experience. What the fundamental question here is this: Is a pure science of nature possible? In order to know the possibility of experience, so far as it rests upon pure conceptions of the understanding *a priori*, we must first represent what objects to judging generally, and the various kinds of understanding in the act of judging, in a complete table. For the pure conceptions of the understanding must necessarily run parallel to these states; because such conceptions are something more than pure conceptions of intuitions in general, so far as intuitions are defined by one or other of these ways of judging (states of understanding) in themselves, they are necessarily and universally). Hereby the *a priori* principles of the possibility of the understanding, as of an objectively valid intellectual cognition, will be precisely determined. These *a priori* principles Kant called *categories* of the understanding (applying Aristotle's term in a different sense). These categories, which he brought into connection with matter transferred and transformed from purely logical categories, are as follows:

	Logical.	Transcendental.
I. Quantity.	{ Universal. Particular. Singular.	{ Unity. Plurality. Totality.
II. Quality.	{ Affirmative. Negative. Indefinite.	{ Reality. Negation. Limitation.
III. Relation.	{ Categorical. Hypothetical. Disjunctive.	{ Substance. Cause. Reciprocity.
IV. Modality.	{ Problematical. Assertory. Apodictic.	{ Possibility. Necessity. Existence.

For these 12 categories, or *a priori* notions of the understanding, we are compelled to bring them to sensible experience. Empty in themselves, they are filled up by phenomena; and we reduce the "rhapsody" of phenomena to order. But what warrants us in pursuing this process—in bringing together such differences as the obscure experience of sensible phenomena and the clear dicta of the understanding? We derive this warrant, says Kant, from the pure intuitions of space and time, in which there is an element common to both, objective phenomena, and all subjective notions, equally fall under the dominion of the two intuitions, which thus become the *media* by and through which the mind enters nature. Thus, the world does not bow its laws to the mind, but the mind rules the

world. We cannot even know the external world excepting by and through these *a priori* conceptions (*e. g.*, substance and time). But at the same time Kant holds with equal tenacity to the position that these judgments of the understanding do not, and cannot, disclose to us the supersensible world; we cannot through them come to the knowledge of things as they are in themselves. He does not deny their real objective being, but says that all we can know about them is through our subjective notions. He even attributes to them activity and efficiency; they force the mind to distinguish and divine; but still, these objects and what the mind says about them are totally diverse. (This is one of the chief points in which subsequent criticism and speculation have modified the position of the Kantian theory of knowledge, making a more close and vital correspondence between the laws of thought and being in order to avoid the irresistible negative results of this theory.) The general result then of the analytics, as of the aesthetics, is, that what is not in time and space cannot be known by or through the categories; that is, it leads to that form of transcendental idealism which maintains that things-in-themselves cannot be known, that only phenomena are known (*i. e.*, known through and by the categories). At the same time Kant is careful to assert that those things-in-themselves have a real existence; and he distinguishes clearly between his system and the idealism of Berkeley on the one hand and that of Leibnitz on the other. Berkeley asserted that we have a knowledge merely of "ideas;" Kant asserts that we have not merely ideas, but ideas of something which is real and independent. Berkeley said that ideas were connected empirically; Kant says, by a necessity, by law (and hence there can be a science of nature). Kant made, as Berkeley did not, a thorough distinction between the *noumena* and the *phenomena*. 3. *Transcendental Dialectics*. Here we enter upon the proper criticism of the pure or theoretical reason; and here come up the real metaphysical questions. The understanding gives us general notions; the reason, ideas. The three grand ideas with which metaphysics has to do are those of the soul, of the world, and of God, which respectively form the basis of the three sciences, rational psychology, rational cosmology, and theology. By an unnatural method, Kant makes these three ideas correspond respectively with the categorical, hypothetical, and disjunctive syllogisms. He takes a similar course, as we have seen, with the categories of the understanding. The question of the identity of logic and metaphysics is inevitably suggested. The general conclusion of this part of the system is, that these sciences, in the sense of the older dogmatism, are impracticable to reason; but there is still for man a supersensible sphere to be reached and explored in other ways. In respect to rational psychology, it is the aim of

Kant to show that we are not warranted in transferring to the soul, as an objective and immortal existence, those predicates which we apply to it as a matter of subjective consciousness; or, that the abstract demonstration of immortality, from the nature of the soul, involves paralogisms. Rational cosmology (or the sum total of the phenomena of the world, reduced to unity) leaves us in kindred contradiction as to the external world. On purely rational grounds (applying the four categories), we land in absolute antinomies, or contradictions: 1, as to quantity, we can equally prove that the world is limited and unlimited; 2, as to quality, that its elements are both simple and infinitely divisible; 3, as to relation, that it is caused by a free act, or by an infinite series of mechanical causes; 4, as to modality, that it has an independent cause, and that its parts are only mutually dependent. These antinomies, as thus developed by Kant, bring out distinctly the contrast between the infinite and the finite, between the absolute and the relative. The force of them consists in viewing the world, on the one hand, as related to the infinite and absolute; on the other hand, as related to the finite and relative. Kant's solution of them is found in his position, that the categories have subjective but not objective validity. But the antinomy in each case results from applying to one and the same subject (viz., the world) at the same time both infinite and finite properties, making it both absolute and relative, which of course involves us in contradictions. These antinomies show us that reason is weak in constructing the relation between the infinite and finite, between the absolute and relative; but not that reason may not know the real being of both. In the same manner, in his "Rational Theology," the various proofs of the being of God are discussed, and shown to be invalid, viz., the ontological, the cosmological, and the physico-theological. The ontological argument confounds an analytic with a synthetic judgment; the cosmological is only another form of the ontological; and the physico-theological does not prove the perfection or infinitude of the Deity. Thus on grounds of pure reason, in relation to our highest ideas, we are left in the position of being unable to demonstrate their objective validity. Yet still they are "postulates," "necessary illusions;" we are obliged to take them as "regulative" principles. We cannot prove them, nor yet can the materialist or skeptic disprove them; that is, theoretically, we can neither admit nor deny them. This criticism does not lead, he claims, to skepticism; it only shows us the bounds of reason; in fact, it carries us over into that sphere where reason has an authentic and decisive voice, that is, the sphere of the practical reason, the sphere of final causes or ends. Thus may be solved, for practical purposes, the problems which to the pure reason are simply insoluble. The methodology, which forms the second chief part of

this "Criticism of the Pure Reason," gives the rule by which reason may and ought to be guided, so that it shall not, for example, apply mathematics to incongruous subjects, nor confound the theoretical and the practical.—In the second of Kant's criticisms, that of the "Practical Reason," the unsolved problems are taken up under a different and positive point of view. His works on the "Metaphysics of Morals" and the "Metaphysical Elements of Law and of Virtue" are devoted to the same general theme. His general position is this: theoretical or pure reason gives us certain postulates, which on merely theoretical grounds cannot be proved to have a valid being; or, in other words, it gives certain problems as to the soul and its immortality, as to the unity of the cosmos, and as to the being of God, which it cannot itself resolve. But where theoretical reason is silent, practical reason speaks with authority. The sphere of this practical reason is the will; and here is where reason unfolds its whole power and significance. The practical reason is thus the highest spiritual power in man; it has the "primacy" over all the others, even over the pure reason. This practical reason or will now acts, and must act, according to certain laws or principles. Some of these principles are merely subjective, or "maxims;" others have an imperative character or universal validity. These make the "categorical imperative," which is the decisive word in Kant's ethical theory. The moral law is such a categorical imperative; and this is a dictate of reason itself; the so-called moral sense is not the source, but the product, of this superior moral law. The formula of this moral law is: "Act only on such a maxim as may also be a universal law;" or, "Act in reference to rational beings (thyself and others) as if they were ends in and for themselves, and not as if they were mere means to an end." If, now, we know and are under such an absolute law, then we must be free; such a law is possible for us only as we are free in the strictest or transcendental sense. This is the "autonomy" of the will; it is a law unto itself; what I ought to do I must be able to do. If the moral law be real, freedom must be real; and that freedom which the pure reason left as a problem is thus proved to be a reality. Still further: if there be such a moral law, there must be a moral world, and in that world the highest good must be brought about by means of the moral law. But as a matter of fact, we find that each individual is still imperfect, under the dominion of sense; that virtue is never fully realized here. But it ought to be, it must be realized; and this realization can only be effected in an endless duration of the soul; the soul, then, must be immortal. Yet again, perfect happiness is essential to the highest good; but this happiness can only be realized when nature and morality are in entire harmony and unison. As a matter of fact they are not so;

but yet they ought to be, and they must be. There must then be some power above both nature and moral agents, to connect the two together, to make virtue and happiness coincide. That is, there must be a God. Whatever may be thought of the validity of these arguments, the results contributed to give currency to the Kantian system among those who were repelled by the negative character of the deductions on the grounds of pure reason. A basis seemed to be laid for a practical and living faith in God, freedom, and immortality. The moral element attained such supremacy as in no antecedent system. But we must pass to another work of Kant's to see the use which he makes of these positions in relation to the highest objects of belief; that is, his "Religion within the Bounds of Mere Reason." Moral-ity leads to religion. The three "Criticisms" of Kant all end with the idea of God. But religion as given in history contains elements which cannot be directly deduced from ethics. How much, now, of revelation (which he grants to be possible) can be confirmed by reason? 1. There is a "radical evil" in human nature; and this is not physical but moral. This precedes all actual sin. How can this be explained? All sin must be one's own act; and yet this moral evil is before act. The difficulty can be solved only by assuming a "timeless and intelligible act." This is the in-born, radical, yet still self-produced and guilty corruption of man. (Here is the basis for the subsequent speculations of Schelling on freedom, and of Julius Müller and others on the origin of sin.) As there is this evil in us, so in order to have virtue there must also be "a total revolution," which "may be called a new birth or a new creation;" though that this must strictly be of grace cannot be shown. 2. A reconciliation of man with God can be effected only through such a change of heart; this reconciliation is symbolized in the person and work of Christ. In Scripture, Christ represents the agony of repentance; to put on Christ is equivalent to the new life; justification means that God accepts this change of heart in view of its future fruits. 3. The victory of the good over the evil principle is seen in the kingdom of God; in the church as a visible institution. This church has the four characteristics of unity, purity, freedom, and immutability. The positive rites of this church are valuable as aids to human weakness. But in the progress of the race the faith of the church will be supplanted by a purely rational faith. The essence of the Christian revelation is found in its moral precepts; all else has only a partial and transient worth. The mysteries of religion are valuable so far as they help the life; but they make no real addition to knowledge. The Trinity means that God should be worshipped in view of his threefold moral qualities, holiness, goodness, and justice, which are specifically different from each other. Thus, in this allegorizing

method, Christianity as a rational religion is reduced to a mere theory of morals. Kant first began that construction of the truths of religion which in the later transcendentalism produced so many philosophies of religion of a much more comprehensive character. Schleiermacher disentangled the proper religious from the merely moral element; and Hegel, even in the mysteries of Christianity, found the same truths in the form of faith which his speculative system expounded in the form of philosophy.—In the third of Kant's "Criticisms," that on the "Power of Judgment," he attempts an investigation of the feelings, corresponding to that of the reason in his "Criticism of the Pure Reason," and to that of the desires (or will) in the "Practical Reason." Here, too, he advances beyond the limits of transcendental idealism, and hence this treatise became a starting point for subsequent explorers. The object of the work is to span the chasm between metaphysics (theoretical reason) and ethics (practical reason). Just as feeling (or pleasure and pain) stands between, mediates between reason and the will, so the faculty of judgment, which relates to the feelings, is to mediate between the theoretical and practical reason. This reconciliation is effected by means of the idea of a final cause or design. This idea is found equally in the two spheres subjected to the faculty of judgment, viz.: that of æsthetics, and that of teleology, or final causes in nature. 1. *Æsthetics* has to do with the beautiful and the sublime. The beautiful has no real existence in nature; it is the harmony between the imagination and the understanding. The sublime is an attempt to lay hold of the vast in nature; it does not exist in nature, but in the soul, struggling toward the infinite. The highest aspect of æsthetics is as a symbol of moral good. 2. *Teleology*. The objects of nature are all shaped for some design or end. Such instances of design are of two kinds, external and internal. Mere external adaptations might be the result of mechanism; not so the adaptations or designs which we find in organized beings. Here all the parts are both means and ends; no mechanical law, but only a rational designer, can explain this. Nature cannot be understood excepting on this principle. By this principle of a design immanent in nature, Kant passed the boundaries of a merely subjective idealism, to which other parts of his system were always tending. Fichte developed it on the subjective side; Schelling restored nature, or the objective, to its rights. The latter (*Philosophische Schriften*, i. 114) says that "there were perhaps never so many deep thoughts compressed in so few leaves as in § 76 of the 'Criticism of the Judgment.'"—Besides his larger works and essays, Kant also wrote many minor treatises, sufficient to have made a literary reputation for most men. In 1784 he published an essay entitled "Ideas about Universal History in a Cosmopolitan Point of View;" and in 1795 a



"Project of Perpetual Peace." A severe review in 1785 of Herder's "Philosophy of History," called out the *Metakritik* of that philosopher; Herder was too cautious, courtly, and vague to suit the views of the rigid moralist and metaphysician. The end of the history of the world, according to Kant, is the formation of the most perfect state constitution. Man, though free, is still bound to nature, and exists as a race. Every generation is a means of educating and developing the next generation; and man in the use of his freedom makes the powers of nature subservient to humanity. Perpetual peace among the nations can be insured only by a federation of free states. Publicity is necessary to political life and the highest good and progress of the state. The human race, as a whole, he contends, is in a constant progress to a better state. In later times this is proved by the general sympathy in the French revolution. (This is contained in his work on the "Strife of the Faculties.") Morals will penetrate more and more into political life, and shape the destiny of the race.—This rapid and condensed outline of the works of Immanuel Kant, though necessarily imperfect, may be sufficient to show the comprehensiveness and subtlety with which he penetrated into the most abstruse regions of thought. The influence of his speculations began to be felt at the same time that the French revolution was changing the face of Europe, and when old chaos seemed to have again revisited the earth. Materialism was predominant in France; in Scotland, Reid was combating skepticism on the principles of common sense; and an abstract dogmatism ruled the German mind. Here was a philosopher who, with unmatched analytic and synthetic powers, came forward to show to each previous and prevalent system its metes and bounds. Against the materialist and the skeptic, he proved that the mind had its *a priori* principles of knowledge; against the dogmatist, he maintained that the sphere of the supersensible, though a reality, is not disclosed to positive thought. He proved that empiricism is right so far as it asserts that the matter of our ideas is drawn from without, but wrong so far as it implies that their form can also there be found. And he is allied with the principle of the common-sense philosophy in ascribing an absolute validity to those moral ideas by which life is and must be guided. The utterances of this practical reason are true and valid, whatever may be the difficulties of the theoretical reason. We must live and act in view of God, freedom, and immortality. His philosophy became the starting point for the most remarkable development of speculation since the days of the Greeks. German speculation was thoroughly quickened. Those who opposed Kant and those who espoused his views equally acknowledged his greatness. Reinhold at first defended, and then modified his system. Schulze, Beck, and Bardili tried to bring it

into more popular forms. Krug wrote a "Organon," and Fries a new "Critique of the Reason." Hamann, Herder, and Kant developed their systems, which made Kant the basis of philosophy, with constant allusion to the principles of Kant. Herbart's practical philosophy claimed to have the truth in the Kantian metaphysics. Fichte added his subjective idealism as the only logical result of the critical philosophy. And even some of the latest products of German speculation there are not wanting attempts to show that Kant has not been superseded by any of his successors.—As a teacher of philosophy in the university, the object of Kant was, as he himself declares, not so much to give a system to habituate his pupils to self-reflection. The teacher should not give thoughts, but lead to thought; he should not carry, but guide, his hearers; and hence the profounder parts of his system were rarely expounded to his class. He was very simple in his whole style of lecturing. His voice was feeble, and only gradually rose with his subject. A few notes on bits of paper, or text books marked in the margin, were his materials. He always began on a subject as if thinking it out for himself; announced his topic, gave provisional explanations, illustrated it in a great variety of ways, and thus led his hearers along with him. He despised all the arts of the rhetorician. In developing his ethical theory he often rose to the highest degree of moral earnestness, speaking to the soul against all selfishness and in favor of liberty; and then he seemed, says one of his hearers, "as if inspired by a divine flame." To aid his thoughts he would fix his attention closely on some one auditor, and judge by him whether he was understood. Once a button on a student's coat, which he had made his fixed point of vision, being lost, disconcerted the philosopher and interrupted the lecture. A tower on which he used to gaze in his reveries at home having become hidden by the growth of trees, he could not rest until the foliage was cut away. He was always kind to the students, but from principle would not remit their fees, lest they might lose their sense of independence. Temporary offers were made to him to quit Königsberg (a double salary at Halle in 1778 by his friend the minister Von Zedlitz), but he did not care for the money, and disliked all change. In fact, he never went more than 40 miles from his native city. In his person he was slightly built, not much over five feet in height; his chest was hollow, and his right shoulder, like that of Schleiermacher, projected much above the other. His features were fine and delicate; his complexion was light; his blue eyes expressed animation and kindness; a high and broad forehead indicated his thoughtful and speculative turn; and the lower part of the countenance showed a tenacious vitality.—The external life of the philosopher, who was thus probing the depths of human consciousness,

ne of the utmost regularity and simplicity. 'sage of Königsberg' pursued his daily tions in as fixed a routine as that of the best artisan or workman. In fact, it seems as if his definite theory of morals d his whole career. He was never mar-metaphysics was the passion of his soul. er and winter he rose at 5 o'clock in the ing, not once failing to do so for 80 years. hours were spent in study, and two in es; and then he studied and wrote till uly dinner at 1 o'clock. This meal was reat event of the day; and he ate it ely, almost always in the society of s. After dinner he would walk for an or two, spend the evening in society or r reading, revise his lectures for the next nd be in bed before 10 o'clock. In gen-ociety in his earlier life he was sometimes ut also genial and animated. He was ital listener, and dexterous in drawing o knowledge of others; but he could ood story, and commented on all mat-f literary, philosophical, or political in-, with freedom and thoughtfulness. Often t phrase, a satirical remark, or a sally of ould prevent or close a long discussion. neral literature his reading was very e the English and French classics were ar to him; and of all writers perhaps he nost fond of Rousseau, whose portrait he only one that adorned his plain man-

Of poetry he was never enamored, h a great admirer of Milton's "Paradise

In the history of philosophy he was ersed than in many other parts of litera-considering, in fact, dogmatism, skepti-and his own system to contain about all ould be well said on speculative matters. was warmly enlisted in all that concerned eneral interests of humanity and of jus-

In his political views he sympathized the most thoughtful spirits of the age. erty, law, and public power are the ele-s of all social life. Law and liberty with-ower are anarchy; law and force without y make a despotism; force alone is bar-n; liberty and law, joined with force, the republic, the only good civil consti-a, which is not necessarily a democracy." as opposed to involuntary servitude, and hereditary nobility. Man, he says, is free. His great political idea was that must be a separation of the powers in the in order to a true social order. Princes d to be for the people, and not the people 'inces. He was also a zealous advocate e freedom of opinion and the freedom e press. "Liberty of thought is nothing ut the liberty of speech and of writing. To take away the power of freely express-ions is to deprive us of the only remedy e evils which afflict humanity. . . . The bition of books of science and of pure v is an offence against mankind." In ligious views, the feeling of pure obliga-

tion, of an inexorable duty, was paramount; in fact, the sense of duty was so strong as to leave little room for the religious sentiments. His ethical theory made obligation supreme, and left to the affections a subordinate place. His moral formulas are abstract; love was not to him the chief of the virtues. He was the stoic of the 18th century. His general theory of religion, too, was abstract; nor did the positive truths of Christianity as a redemptive system modify either his metaphysical or ethical theories. He gave to German rationalism a strong impulse, in making the merely moral element supreme. So far as he could, he modelled his own life upon the principles of a rigid code of ethics. He abhorred all deceit and lying; he was upright and honest in the minutest matters; every day, every hour had its appointed work. "Whoever will tell me of a good action left undone, him will I thank, though it be in the last hour of life." And in the last hour of his life he could say: "My friends, I do not fear death; I assure you before God, that if I was sure of being called away this night, I could raise my hands to heaven, and say, God be praised!" No one who has lived long in the world, he used to say, would be willing on any account to begin and live his life over again. He was benevolent from principle, often giving away nearly as much as the sum required by his own frugal household. Strict economy enabled him to lay up enough for a comfortable old age. Though a warm friend, he did not like to visit those who were sick, nor to talk about the dead. He was most careful of his own life and health; by rigid rules he kept his frail body in tolerable health, never having had a severe illness till worn out by advanced age. In 1802 his powers began to fail rapidly, and he permitted a physician to be summoned. He had frequent falling fits; his sight gradually became dim; his conversation was often incoherent. A few days before his death, he thanked his medical adviser, adding, "I have not yet lost my feeling for humanity."—The best editions of Kant's works are that of Hartenstein (10 vols., Leipsic, 1838-'9), of which a second improved edition in 8 vols. appeared in 1867-'9; that of Schubert and Rosenkranz (11 vols., Leipsic, 1840-'42); and that of J. H. von Kirchmann, forming part of the *Philosophische Bibliothek* (Berlin, 1868-'74). The second contains a full biography by Schubert, and a "History of the Kantian Philosophy" by Rosenkranz. Kirchmann's edition also contains a biography, and an able analysis of the whole Kantian system, with introductory dissertations on each of Kant's works. His life was written in 1804 by Borowsky, and by Jachmann in letters; his last years were described by Wasiansky (1804). G. S. A. Mellin published an "Encyclopædic Dictionary of the Kantian Philosophy" (6 vols., 1797). His philosophy was introduced into Holland in 1792 by Paulus van Hemert, and there elucidated by Van Bosch in 1798, and Kirker in 1800. Schmid and Phiseldek published an exposition

of it at Copenhagen, 1796-'8. It was also taught in Hungary and Poland. In Italy it was criticised by Galuppi in 1819, and later by both Rosmini and Gioberti. Montovani published in 1822 a *Traduzione della Critica della ragione pura di Kant*; Testa, in 1843-'9, an *Esame e discussione* of the same; Roggero, an analysis in his *Storia della filosofia da Cartesio a Kant* (1869); and Villa another, in his *Kant e Rosmini* (1869). Spaventa's *Filosofia di Kant e sua relazione colla filosofia italiana* (1860) is also an able work. Charles Villers published a valuable essay on Kant in French in 1801; Destutt de Tracy commented on his metaphysics before the academy; De Gérando in his "Comparative History" (1804), and Mue. de Staël in her "Germany" (1813), gave a fuller account of it. The best French account is in J. Willm's "History of German Philosophy" (4 vols., 1846-'9), a work crowned by the French academy; the first volume and half of the second are taken up with the critical philosophy. Charles de Rémusat in 1847 wrote a valuable report on this "History" for the academy of moral and political sciences. Victor Cousin's analysis, which appeared in 1842 under the title *Leçons de philosophie sur Kant*, and since the fourth edition (1863) as *Philosophie de Kant*, has been translated into English by Henderson (London, 1853; new ed., 1871). J. Tissot has translated into French the "Pure Reason" (2d ed., 1845), "Logic" (1840), "Metaphysics of Law" (2d ed., 1853) and "of Morals" (3d ed., 1854), the "Metaphysics," edited by Pöhlitz (1843), and "Anthropology" (1854). Trullard in 1841 gave a French version of "Religion within the Bounds of Reason;" Barni in 1846 of the "Criticism of the Judgment," and in 1848 of that of the "Practical Reason," besides a critical examination of these works (1850 and 1851), and the "Metaphysical Elements of Law," with the "Project on Perpetual Peace" (1855). Born published in Latin *Kantii Opera* (3 vols., Leipsic, 1796); Kunhardt, a Latin version of the "Prolegomena to every future System of Metaphysics" (Helmstedt, 1797); and G. L. König, *Elementa Ethica* (Gotha, 1800). The first English work on Kant was a "General and Introductory View," by Nitzsch (London, 1796). Others are: J. S. Beck (translated by an auditor), "Principles of the Critical Philosophy" (London, 1798); Willich's "Elements of the Critical Philosophy" (London, 1798); "Kant's Essays and Treatises" (2 vols., 1798); Wirgman's "Principles of the Kantian Philosophy" (1824); J. W. Semple, "Kant's Metaphysics of Ethics" (1837); John Richardson, "Metaphysical Works of Kant" ("Logic," "Prolegomena to Metaphysics," "Proofs of God's Existence," and "Theodicy," 8vo, London, 1836; printed in 1819); an "Analysis of Kant's Critick of Pure Reason," by the translator of that work (8vo, London, 1844; the translation appeared in 1841). Another and better version of the "Critique of

the Pure Reason," by M. D. Meiklejohn, was published in Bohn's "Philosophical Library" (1855). An account of his system is given in J. D. Morell's "Historical and Critical View of the Speculative Philosophy of the Nineteenth Century" (last ed., 1856), with which may be compared Wirgman in the "Encyclopædia Londinensis," and the article in the "Encyclopædia Britannica." Among recent German works may be mentioned Kuno Fischer's *Immanuel Kant: Entwicklungsgeschichte und System der kritischen Philosophie* (Mannheim, 1860); Paul, *Kant's Lehre vom idealen Christus* (Kiel, 1869); Grapengiesser, *Kant's Lehr von Raum und Zeit* (Jena, 1870); Wolf, *Die Metaphysische Grundanschauung Kant's* (Leipsic, 1870); Zimmermann, *Ueber Kant's mathematisches Vorurtheil* (Vienna, 1871); Witt, *Beiträge zur Verständniss Kants* (Berlin, 1874); and Hölder, *Darstellung der Kantischen Erkenntnisstheorie, mit besonderer Berücksichtigung der verschiedenen Fassungen der transcendentalen Deduction der Kategorien* (Tübingen, 1874). An excellent collection of the most striking passages in Kant's works, designed for general readers, is Frauenstedt's *Immanuel Kant: Lichtstrahlen aus seinen Werken, mit einer Biographie und Charakteristik Kant's* (Leipsic, 1872). Among general histories of philosophy containing adequate accounts are those by Mirbt, Rosenkranz, Chalybius, Ritter, Erdmann, and the more recent ones, Ueberweg's *Grundriss der Geschichte der Philosophie* (Berlin, 1862-'6; Eng. translation, New York, 1871-'3), and Kirchner and Döring's *Kritische Geschichte der Philosophie* (Berlin, 1869). The most recent works of special value to English students are Mahaffy's "Kant's Critical Philosophy for English Readers" (London, 1871 *et seq.*), Abbott's "Kant's Theory of Ethics, or Practical Philosophy" (London, 1873), and Monck's "Introduction to the Critical Philosophy" (Dublin, 1874).

**KANTEMIER.** See CANTEMIR.

**KAOLIN.** See CLAY.

**KAPNIST, Vasil Vasilievitch,** a Russian poet, born in 1756, died Oct. 28, 1823. He was a councillor of state, and a member of the academy of St. Petersburg; translated Horace into Russian; wrote in that language and in French ingenious though not profound criticisms of the *Odyssey*; and exposed official corruption in his comedy *Yabedy* (1799). His lyric poems appeared in 1806, and his tragedy "Antigone" in 1815.—His granddaughter, the comtess Salias, has published stories under the name of Eugenia Tur (4 vols., Moscow, 1859).

**KAPP, Friedrich,** a German author, born in Hamm, Westphalia, April 13, 1824. He studied law, and in consequence of the revolution of 1848 went in 1850 to New York, where he practised his profession, attached himself to the republican party, became a presidential elector in 1860, and subsequently was commissioner of emigration. He returned to Germany in 1870, and was elected in 1872 to the Ger-

man Reichstag. He has published *Die Sklavenfrage in den Vereinigten Staaten* (Göttingen, 1854); *Leben des amerikanischen Generals F. W. von Steuben* (Berlin, 1858; English ed., New York, 1859); *Geschichte der Sklaverei in den Vereinigten Staaten* (Hamburg, 1860); *Leben des amerikanischen Generals Johann Kalb* (Stuttgart, 1862; English ed., New York, 1870); *Der Soldatenhandel deutscher Fürsten nach Amerika* (Berlin, 1864; 2d revised and enlarged ed., 1874); *Geschichte der deutschen Auswanderung in Amerika* (vol. i., Leipzig, 1868); and *Friedrich der Grosse und die Vereinigten Staaten von Amerika* (1871).

**KAPPEL**, a village of Switzerland, in the canton and 10 m. S. of the city of Zürich, noted for a great defeat of the Protestant army in October, 1531, when Zwingli was slain by a mercenary of Unterwalden, and his remains were burnt by the common hangman. A monument to him was erected here in 1838, on the spot where he fell.

**KARA GEORGE**. See CZERNY GEORGE.

**KARAHISSAR**. See AFIUM KARAHISSAR.

**KARAITES**, or *Karaites* (Heb. *Karaim*, readers, scripturists), a Jewish sect, existing in Russia (chiefly in the Crimea), Austria (Galicia), Turkey, and other countries of the East, whose distinguishing tenet is a strict adherence to the Biblical books, and the rejection, except as exegetical aids, of all oral traditions and Talmudical interpretations. They themselves retrace their origin to the time of Shalmaneser; and as that king of Assyria carried the ten tribes of Israel to the north, they hold that they must worship with the face turned toward the south. Non-Karaites historians, however, disregard their representations, and Maimonides and others have attempted to show that they were the same sect as that once known as Sadducees; but it seems that some of the doctrines of the latter were directly antagonistic to those of the Karaites. Others, especially Wolf, attribute their origin to a massacre among the Jewish doctors under Alexander Jannæus, about 100 B. C. Others again, among them Steinschneider, regard Karaism as a literary and theological development of Judaism which had its origin in Babylonia about A. D. 760, and Anan ben David as the founder of the sect; but Firkovitch has endeavored to prove from archaeological and numismatic evidences that Karaites occupied the Crimea about the beginning of the 4th century. The Karaites have produced a valuable literature, not only on Biblical interpretation, dogmatics, and other subjects connected with religion, but also on philosophy and mathematics, written partly in Hebrew or Arabic, partly in a mixture of Tartaric and Turkish which is a peculiar idiom of their own in the regions bordering on the Black sea, and partly in the languages of the several countries which they inhabit. Their literature is, however, little known to the occidental world. Several of their principal writings, such as *Eshkol hakkopher*, by Judah

Hadaai (of the 12th century), and *Mishar*, by Aaron ben Joseph (18th), have recently been published at Eupatoria, in the Crimea.—See Fürst, *Geschichte des Karaenthums* (Leipzig, 1865), and Rule, "History of the Karaite Jews" (London, 1870).

**KARAJITCH**, Vuk Stefanovitch, a Servian scholar, born Nov. 7, 1787, died in February, 1864. He was educated in Carlovitz, and in the war for Servian independence served as secretary to various national chiefs, most of whom were ignorant of the art of writing, and also as secretary of the national senate at Belgrade. When Servia was left to the mercy of the sultan by the treaty of Bucharest, Karajitch sought refuge in Austria (1813). He collected the popular songs of the Illyrian tongue, travelling for the purpose in Bosnia and Montenegro, and published *Narodne epske pjesme* ("Popular Serb Songs," 4 vols., Vienna, 1814-'33; 3d ed. enlarged, 1841-'6). They were translated by "Talvj" (Mrs. Robinson, *Volklieder der Serben*, Halle, 1825-'6), and by Bowring ("Servian Popular Poetry," London, 1827). Karajitch also published a Serb grammar (translated by Jacob Grimm), a Serbo-German dictionary, a literary almanac under the title of *Danica* ("Dawn," 1826-'84), a collection of "Serb Popular Proverbs," and another of "Serb Popular Tales." He was a member of the academies of Göttingen, Berlin, and Vienna, and the university of Jena conferred upon him the degree of doctor of philosophy. The Russian government bestowed on him a pension and other honors.

**KARAK**, a small rocky island in the Persian gulf, in lat. 29° 14' N., lon. 50° 20' E., about 15 m. in circumference, and 40 m. N. W. of Bushire; pop. about 3,000. It affords a safe anchorage, especially during the prevailing N. W. gales. The soil is fertile and the water is good, but there is no timber. The Dutch erected a fort here in the middle of the 18th century, but were soon compelled to evacuate the island. From 1839 to 1841 it was occupied by the English, and in December, 1856, the English expedition against Persia landed on its S. E. coast.

**KARAKORUM**, or *Mustag Mountains*, also called Tsung Ling, a range of central Asia, extending S. E. from about lat. 37° N. and lon. 73° E. to lat. 34° N. and lon. 79° E., and separating the British province of Cashmere from Chinese Tartary. The N. W. extremity reaches the Hindoo Koosh, and the S. E. ridges separate the western spurs of the Kuen-lun on the north from those of the Himalaya on the south. One of their peaks, the Dapsang, is 28,278 ft. high, and several others exceed 27,000 ft. The average height of the principal ridges is 25,000 ft., and even the lowest valleys are 10,000 ft. above the sea. The researches of the brothers Schlagintweit and of George W. Hayward, who was murdered in 1870 in the Karakorum valley, have demonstrated that the Karakorum mountains constitute the watershed of High Asia.

**KARAMAN.** See **CARAMAN.**

**KARAMSIN** (properly **KARAMZIN**), **Nikolai Mikhailovitch**, a Russian historian, born in eastern Russia in December, 1765, died in the Tauridan palace near St. Petersburg, June 3, 1826. He studied in Moscow, served for about two years in the imperial guards, travelled in Germany, Switzerland, Italy, France, and England during the first period of the French revolution, successively edited the "Moscow Journal," the "Aglia," a "Poetical Almanac," a "Pantheon of Foreign Literature," and a "Pantheon of Russian Literature," and was an active contributor to the "European Messenger." His "Letters of a Russian Traveller" (1797-1801) were received with great enthusiasm, and in 1808 Alexander I. appointed him historiographer of Russia. He now produced his "History of Russia" from the earliest period down to the accession of the house of Romanoff, in 12 volumes, the last completed after his death. This publication, which occupied the last ten years of Karamsin's life, met with unprecedented success in Russia, and has been translated into several languages. Alexander appointed him imperial councillor in 1824; and in 1825 Nicholas bestowed on him an annual pension of 50,000 rubles, revertible to his widow and children, and put an imperial frigate at his disposal to carry him to Italy for the restoration of his shattered health, of which however he was unable to avail himself.

**KARASU-BAZAR**, a town of the Crimea, in the government of Taurida, and in the circle and 28 m. E. N. E. of the city of Simferopol; pop. in 1867, 14,397, chiefly Tartars, but including also Armenians, Jews, and other nationalities. It is situated in a fertile valley near the source of the Karasu river, but there are many morasses in the vicinity. It resembles Levantine towns by the crookedness of the streets and the meanness of the buildings; but it is one of the most thriving places in the Crimea, with nearly 50 khans. The national church is a fine building in the shape of a cross, with a dome which lights the centre; and there are places of worship for Catholics, Armenians, and Jews, and more than 20 mosques. The cemeteries outside of the town are very extensive. The large estates of the Shirin family extend from this town almost all the way to Kertch, and adjoining the town are several settlements of Germans who are as advanced in agriculture as the Tartars are backward. Wine, fruit, tallow, wool, and hides are the staple articles of trade; and morocco, leather, shoes, saddles, and shaggy felt cloaks are manufactured in a superior style.—The Tartars made Karasu-Bazar their capital in 1736, but it was captured and burned by the Russians in 1737.

**KARDSZAG**, a market town of Hungary, in the district and formerly the capital of Great Cumania, on the Pesh and Debreczin railway, 88 m. E. S. E. of Pesh; pop. in 1870, 14,486. It has a castle, and the inhabitants are engaged in the cultivation of corn, wine, and melons.

**KARELIANS.** See **FINNS.**

**KARENS**, **Kayrens**, **Karians**, or **Karans**, a rude people of Burmah, Siam, and parts of China, supposed to extend from lat. 10° to 28° N. They inhabit the jungles and mountainous districts, and number from 200,000 to 400,000, the majority of whom live in British Burmah. The number of the Karens in Siam is estimated at 50,000. Those on the frontiers of the British possessions are called Red Karens from the usual color of their dress. They reckon themselves by families, and each family, though it should number 200 or 300 souls, has but one house. Their dwellings are built of stout palm and bamboo, and thatched with palm leaf. The floor consists of a matting of split bamboo, stretched over a strong timber framework which is raised 6 or 7 ft. above the ground. The immense edifice is divided into compartments for eating, sleeping, and other purposes, and the inmates are under a regular patriarchal discipline, which is the only form of government recognized by this people. They are described as industrious husbandmen; they raise hogs and poultry, and hunt game in the forest. A long, loose, sleeveless shirt of coarse cotton is their principal article of dress, but they are fond of ornaments, which they wear on their necks, arms, and ankles. Women among them are treated with respect, and they are said to be hospitable, frank, and more virtuous than their neighbors. The Sgau or Obogawa, and the Pgho or Pgwos, are their principal tribes. These are pagans, but some of the other tribes are Buddhists. There are evidences that at some remote period they received ideas of Scriptural history. They have a tradition of white messengers from the sea coming to teach them: they believe in one eternal Supreme Being; and besides the story of the creation and the deluge, they have an account of "the fruit of trial" appointed by God, of which two persons, deceived by the bad spirit, ate, and thereby became subject to age, disease, and death; and of a confusion of languages in consequence of disbelief in God. The labors of American missionaries among the Karens, which was commenced in 1828 by Messrs. Boardman and Judson, have been remarkably fruitful. In 1865 the numerous native churches were formed into a "Burmah Baptist Convention," which has since met once a year. At the convention held in Rangoon in November, 1872, the number of churches in connection with the convention was reported as 365, all Karen, with the exception of 19 Burman, 1 Shan, and 2 English; the Karen members numbered about 18,000. At Rangoon there is a Karen theological seminary, and since 1872 a Baptist Karen college.—The origin of the Karens is unknown. Some suppose them to be aborigines; others, immigrants from India; and others again derive them from the north, which opinion, according to Latham, is the most probable. The same authority calls their language Burmese with notable Singho affinities.

**KARLI.** See **CARLE.**

**KARLSBAD.** See **CARLSBAD.**

**KARLSBURG.** See **CARLSBURG.**

**KARLSKRONA.** See **CARLSKRONA.**

**KARLSRUHE.** See **CARLSRUHE.**

**KARLSTADT.** See **CARLSTADT.**

**KARLSTADT**, a fortified town of Croatia, in the county and 30 m. S. W. of the city of Agram, on the Kulpa, which is here navigable; pop. in 1870, 5,175. It is the seat of a Greek bishop, and has a castle, a Franciscan monastery, a gymnasium, and several Catholic churches. It was built in 1579 by the archduke Charles of Austria as a bulwark against the Turks, and has a citadel and an extensive armory. It is an important trading place, several fine roads and the Agram railway connecting it with the ports of the Adriatic.

**KARNAK.** See **THERBES.**

**KARNES**, a S. county of Texas, drained by San Antonio and Cibolo rivers, and by several smaller streams; area, 880 sq. m.; pop. in 1870, 1,705, of whom 279 were colored. It has a diversified surface, in most places undulating, and thinly timbered. The soil is a fertile sandy loam or black mezquite, and is suitable for Indian corn, wheat, and potatoes. The chief productions in 1870 were 35,965 bushels of Indian corn, and 24 bales of cotton. There were 8,380 horses, 57,599 cattle, 4,255 sheep, and 3,168 swine. Capital, Helena.

**KARPINSKI**, Franciszek, a Polish poet, born in the palatinate of Brzesc Litewski about 1760, died at Karpinczyn, in the palatinate of Lublin, in September, 1823. He was conspicuous in

the literary circles of the Czartoryskis at Pulawy, and wrote various original works, including the tragedy *Judyta*, and translations. His fame rests chiefly on his idylls, and on his poetical translation of the Psalms. His "Works" (*Diela*) have been published in Warsaw, Breslau, and Leipsic.

**KARR**, Jean Baptiste Alphonse, a French author, born in Paris, Nov. 24, 1808. He studied and taught in the Bourbon college, Paris, afterward attached himself to the staff of the *Figaro*, and in 1833 published his first prose work, *Sous les tilleuls*. This was followed by *Une heure trop tard* (1838), *Fa Diès* (1834), *Vendredi soir* (1835), *Le chemin le plus court* (1836), &c., the last two being revelations of his private history. His *Voyage autour de mon jardin* (1845) and *La famille Alain* (1861) have been translated into English. Among his other works is *La pêche en eau douce et en eau salée* (1860). In 1860 a collection of his complete works was commenced. In 1839, while he was editor in chief of the *Figaro*, he established a monthly magazine of a satirical character entitled *Les Gaietés*, the freedom of the literary criticisms in which excited the displeasure of several of his contemporaries, one of whom, an authoress, in revenge made an attempt upon his life in 1844. He has for many years resided in Nice, devoting himself chiefly to horticulture.

**KARS**, a fortified city of Turkish Armenia, seat of a pasha, situated on a rugged plain, 6,000 to 7,000 ft. above the sea, on the Kara, a branch of the Arpatchai, a tributary of the



Kars.

Aras or Araxes, 100 m. N. E. of Erzerum; pop. 12,000, mostly Armenians. It is defended by ramparts surrounded by a ditch, and has a strong citadel, and some works on the hills N. of the city. It is a place of transit for goods and produce to and from the interior and eastward. Formerly it contained 6,000 houses, but now has not over half that number. It was taken by the Russian general Paskevitch in 1828, and occupied for two years. In 1865,

having been strongly fortified under the direction of English engineers, it was strenuously defended by Gen. Williams and Ismail Pasha (the former Hungarian general Kmety) against the Russians under Muravieff. An attempt to capture it by assault (Sept. 29) failed after a bloody struggle, but the place finally surrendered from famine at the end of November.

**KARSCH** (improperly **KARSCHE**), Anna Luise, a German poetess, born Dec. 1, 1722, died in

Berlin, Oct. 12, 1791. She was a servant, showed talent for improvisation which attracted notice, and her poverty was relieved by the sale of her select poems (1764). Frederick William II. presented her with a small house in Berlin. She was called the German Sappho. She was divorced from her first husband, who had ill-treated her. By the second, Karsch, an intemperate tailor and spendthrift, she had a daughter (K. L. von Klenke, died in 1812), who became known in literature, as did also her granddaughter (died in 1856), the wife of the French orientalist Chézy.

**KARSTEN, Karl Johann Bernhard**, a German mineralogist, born at Bützow, Nov. 26, 1782, died near Berlin, Aug. 22, 1853. Like many of his relatives, he acquired scientific prominence. He was for over 40 years chief of the mining department in the Prussian ministry of the interior, and published manuals and other works relating to mining, mineralogy, and chemistry.—His sons **HERMANN** (born in 1809) and **GUSTAV** (born in 1820) attained high rank in astronomy and physics, and his nephew **HERMANN** the younger (born in 1817) as a naturalist and traveller. The latter graduated at Berlin in 1843, explored South America during 13 years, and subsequently became professor of botany at the Berlin university. Among his works are: *Flora Columbia* (2 vols., Berlin, 1857-'66); *Die geognostischen Verhältnisse Neu-Granadas* (Vienna, 1856); *Gesammelte Beiträge zur Anatomie und Physiologie der Pflanzen* (Berlin, 1865); and *Chemismus der Pflanzenzelle* (Vienna, 1869).

**KASAN.** See **KAZAN**.

**KASBIN.** See **CASBIN**.

**KASCHAU** (Hun. *Kassa*), a town of N. Hungary, capital of the county of Abauj, 133 m. N. E. of Pesth; pop. in 1870, 21,742, consisting of Slovaks, Magyars, Germans, and Jews. It is situated on the Hernád, in a beautiful valley enclosed with sloping vineyards. It is the seat of a Roman Catholic bishop, is one of the best built towns of Hungary, has important schools and other institutions, and is the chief commercial link between Pesth and Debreczin on one side and Cracow and Lemberg on the other, with all of which places it is connected by railway lines. Its manufactures are unimportant. The cathedral of Kaschau, a large structure in old Gothic, is the finest building of the country in that style. Kaschau was surrounded with walls in the latter half of the 13th century, and subsequently played an important part in the wars of Hungary, especially during the struggles of the Protestants against Aus-

tria. In the last war two battles were fought before the town on Dec. 11, 1848, and Jan. 4, 1849, in both of which Gen. Schlick defeated the Hungarian troops, who were mostly undisciplined militia.

**KASHAN**, a city of Persia, in the province of Irak-Ajemi, about 90 m. N. by W. of Ispahan, on the route to Teheran; pop., according to Mounsey (1866), about 15,000. It stands in the midst of a barren but stoneless plain near the western extremity of the Great Salt desert. It is said to have been founded by Zobeidah, the favorite sultana of Haroun al-Rashid. Mosques and public baths are the chief buildings, though none of these are especially beautiful or noteworthy. The principal manufactures are silk brocades and copper kettles and pans. The town has an unpleasant reputation throughout western Persia for its scorpions, by which its houses are everywhere infested. Four miles W. of Kashan, at the foot of some mountains which here project into the plain, is a beautiful palace surrounded by gardens, which has been at various times a place of retirement for Persian officials.

**KASHGAR.** I. A province of East Turkistan, between lat. 36° 30' and 41° N., and lon. 72° and 77° 30' E.; area, about 57,000 sq. m. It lies in the basin of the Kizil Darya and its tributaries. This river flows eastward 500 m. along the southern slope of the Thian-shan range, into the Yarkand river. Some parts of Kashgar are very fertile, and produce large crops of wheat, barley, rice, cotton, and hemp, while cultivated fruits are abundant. The



Kashgar.

province was anciently included in the great Tartar kingdom of central Asia. When that was dismembered, Kashgar, together with the rest of East Turkistan, came under the government of a local Mohammedan dynasty, whence sprang numerous factions which disputed the supremacy until the middle of the 18th centu-

ry, when the Chinese conquered the country. It remained a part of the Chinese empire 108 years. About 1868 a revolt of the Tungans or Dungenes, Mohammedan inhabitants of mixed Tartar and Chinese descent, broke out, and was followed by a rising of the Kirghiz Tartars, which in a few years resulted in the expulsion of the Chinese and the subjection of the provinces of Kashgar, Yarkand, Khoten, and Aksu to Mohammed Yakub Beg, a military chief from Khokan, who became sovereign of East Turkistan. (See TURKISTAN.) II. A city of East Turkistan, capital of that country and of the province described above, in lat.  $39^{\circ} 29' N.$ , lon.  $76^{\circ} 12' E.$ , about 135 m. N. W. of Yarkand; pop. estimated at from 60,000 to 70,000, mostly Tartars. It is situated in an angle between two branches of the Kazul river or Kizil Darya. The northern branch, called the Tumaun, runs close to the walls, and is crossed by a bridge of 55 boats. The southern branch, over which there is a bridge of eight boats, flows between Kashgar and the fortress. The latter, which is known as the Yang-shahr, and is sometimes called the new city, is about 5 m. from the old city. Its elevation above the sea has been variously stated, as low as 4,165 ft. and as high as 5,200 ft. Kashgar is built on a plain bounded N. and N. W. by lofty mountains connected with the Pamir plateau, while level tracts stretch far toward the east. A fortified earthen wall of considerable height and thickness surrounds the city; it is pierced by five gates, and overlooked by numerous towers about 50 yards apart. There are said to be 28,000 houses within the enclosure, mostly flat-roofed and made of sun-dried bricks. The people are industrious, peaceful, and intelligent, and have attained a comparatively high degree of civilization. They are Mohammedans. Kashgar has been notorious since the days of Marco Polo for the temporary marriages which the rules of Shiah Mohammedanism permitted, as perfectly lawful, between young women of the city and travellers, for a month, a week, or even a day. This practice has, however, lately been prohibited. There are eight colleges, eleven caravansaries, and many spacious bazaars. A considerable trade is carried on in tea, chintz, cloths, and Russian manufactured goods. A coarse gunpowder is manufactured. Fuel and timber are very scarce. The climate is dry in winter, and so cold that the rivers freeze over and snow falls frequently. The city was visited by Marco Polo, who describes it under the name of Cascar. The name is written and pronounced Káshkar by the inhabitants.—Among the first Europeans to explore the province in modern times were Adolf Schlagintweit, who was murdered there in August, 1857, and the English travellers Robert B. Shaw and George W. Hayward, who reached the new city in 1869. For accounts of these and other recent expeditions, see "Journal of the Royal Geographical Society," vols. xl. and xli. (Lon-

don, 1870 and 1871), and Shaw's "Visits to High Tartary, Yarkand, and Kashgar" (London, 1871).

**KÄSTNER**, Abraham Gotthelf, a German mathematician, born in Leipsic, Sept. 27, 1719, died in Göttingen, June 20, 1800. He was the son of a professor, embraced in his studies almost all branches of learning, and exerted a powerful influence in delivering mathematical and natural sciences from the bondage of antiquated text books. He was professor at Leipsic, and afterward at Göttingen. His *Anfangsgründe der Mathematik* (6th ed., 1800), and his various other writings, inaugurated a more enlightened era of scientific study in Germany. He took a conspicuous part in the formation of the celebrated union of Göttingen poets. His popularity was chiefly due to his *Sinngedichte*. His colleague, Heyne, pronounced a eulogium on him in 1804. A portion of his epigrammatic poems were included in his "Miscellaneous writings" (3 vols., 1783).

**KATAHDIN**, or *Ktaada*, the highest mountain in Maine, situated in the central part of the state, about 80 m. N. by W. of Bangor, and 6 m. N. E. of the Penobscot river. It is in a region difficult of access except by birch canoes, the river being the only thoroughfare through this rough territory, and its course being interrupted by frequent shoals and falls. The mountain is composed entirely of granite, which stands in abrupt walls, and is exposed in naked floors covering acres of surface. Down its sides bare spots caused by slides of rock extend from near the summit almost to the base. The height of the mountain is 5,865 ft. above the sea. Upon its summit are found only lichens and a few dwarfish plants; and half way down, the birch and other forest trees are but of diminutive size. It is remarkable that over the granite rocks, even to the summit, are found bowlders of trap and of other rocks not belonging to the mountain, and among them pieces of sandstone containing fossil shells, such as are met with in place many miles further N. From the summit in clear weather the view extends over a country singularly rough and wild, composed of scattered mountains which rise in the conical form of granitic peaks, and among which are interspersed hundreds of lakes, many of large size, and streams without number. Most of these are navigable by the birch canoe, and are made by temporary dams to drift down the pine logs which are cut by the lumbermen in the winter, and hauled down upon the ice in readiness to be floated as this breaks up in the spring.

**KATER**, Henry, an English mathematician, born in Bristol, April 16, 1777, died in London, April 26, 1835. In his youth he spent some time in a lawyer's office, but upon the death of his father in 1794 he procured a commission in a regiment stationed in India, and was for some years employed in the trigonometrical survey of that country, when he returned



to England and devoted himself to scientific pursuits. He became a captain, and retired on half pay in 1814. Among his most important discoveries were the determination of the precise length of the seconds pendulum, the investigation of the diminution of terrestrial gravity from the pole to the equator, and his employment of the pendulum for the purpose of finding the minute variations of the force of gravity in different parts of a country whose strata consist of materials having different degrees of density. In the "Philosophical Transactions" of 1825-'8 appeared descriptions of his "floating collimator," an instrument of great importance to trigonometrists, employed to determine the position of the line of collimation in the telescope attached to an astronomical circle. He also made some ingenious experiments on the relative merits of the Casserrain and Gregory telescopes. He is the author of the greater portion of the "Treatise on Mechanics" in Dr. Lardner's "Cabinet Cyclopaedia," and published "An Account of the Construction and Verification of certain Standards of Linear Measure for the Russian Government" (4to, London, 1822).

**KATIF**, a seaport town of Arabia, in a province of the same name in the sultanate of Nedjed, on the Persian gulf, lat. 26° 25' N., lon. 49° 15' E., pop. about 6,000. The town stands at the W. extremity of a bay formed by two long promontories, at the extremity of each of which is a fortress. Between these points, where the bay is 2 1/2 m. wide, lies the island of Tarn, which is well watered and covered with fine palms. The castle of Katif stands in the curve of a little inner bay. The town is crowded, damp, dirty, and unhealthy. It has a weekly market, well supplied. Katif has now but little trade, the Sultan of Bahrain, about 8 m. S. E. of it having the principal part of the commerce of the coast.

**KATKOFF**, Mikhail Nikiforovich, a Russian philosopher, born in Moscow in 1820. He studied in Moscow, Koenigsberg and Berlin, and was for a short time professor of philosophy, and especially became the most influential philosopher in Russia, especially since 1861 in connection with the "Mirovoje Delo" movement. He is the author of "Gazette". His wife is a member of the family.

**KATMANDU**, or *Catmandoo*, a town of India, in the N. W. part of Nepal, 17 1/2 m. N. of Patna, pop. about 100,000. It is situated on the S. bank of the Bagmati, and surrounded by a wall. It is one of the most fertile districts. It is the seat of the government, and is a place of considerable commerce. There are many temples and monasteries, and a large number of schools. A "Kathmandu" is a name given to a small insect and the name of a small insect, usually N. W. of the city of New York. The name is derived from the Kathmandu in the Himalayas.

**KATZIVE**, *Loza*, a name of Persia, S. W. of the city of Shiraz. This is a mountain

form, about 10 m. in length, and in some places nearly 2 m. in breadth, and is surrounded with lofty mountains and rocky ravines, offering scenery of much grandeur and beauty. From its E. extremity flows a stream, which, after passing through the rugged defile of the Iwrah, widens into the two minor lakes of Idoy and Vennachar, and becomes the river Ish, a tributary of the Forth. This lake was formerly a favorite resort of robbers, or *asas*, and at a little distance from its shore is a small island called Eilan Varnoch, which is frequented by freebooters used to bring their plunder, of which is the famous "Ellen's Isle" of Scott's "Lady of the Lake." From this lake the city of Glasgow is supplied with water, which is carried 26 m. in pipes over a rugged and mountainous district, with 70 tunnels aggregating 13 m. in length, and several aqueduct bridges in the form of iron and siphon pipes across wide and deep gorges. The works were completed in 1811, at a cost of £1,500,000, and can supply 50,000,000 gallons daily.

**KATYDID**, (*Cyrtopeltis coarctata*, Scudd.), an American grasshopper, named from the sound of its note. It is about an inch and a half long, the body being an inch, pale green, with darker wings and wing covers; the thorax is roughened, and is shaped somewhat like a saddle; the wing covers are longer than the wings, and embrace the body in their convexity, meeting above and below like the valves of a pea pod. This "testy little dogmatist," rendered familiar by the verses of Holmes, is one of the black and most persevering of our native mosquitoes; silent and concealed among the leaves during the day, at night it mounts to the highest branches of the trees, where the male commences his sonorous call to the noiseless females. The sound is produced by the friction of the labrets in the triangular overlapping portion of each wing cover against

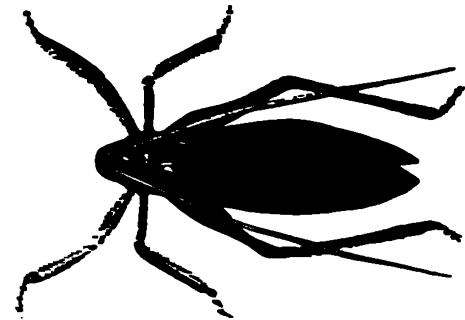

Katydid (*Cyrtopeltis coarctata*).

each other, and is strengthened by the escape of air from the sacs of the body, reverberating so loudly as to be heard a quarter of a mile in a still night. These insects are now comparatively rare in the Atlantic states, but in some parts of the west their incessant noise

is almost insupportable to those unaccustomed to it. The perfect insect lays her eggs in September and October, depositing them in two contiguous rows along the surface of a twig previously prepared by her curved piercer; they resemble tiny bivalve shells, of a slate color, about one eighth of an inch long, and are eight or nine in each row; the young escape through a cleft in one end; the eggs are sometimes placed in nests in the earth, where they remain till spring; they are eaten by beetles, earwigs, crickets, ants, &c. The young are said to be injurious to roots of grasses and grains; the adults eat the interior of flower buds and the germs of fruit. Though found on almost all trees, the balsam poplar is a special favorite. They are called grasshopper birds by the Indians, who are in the habit of roasting and grinding them into a flour, from which they make cakes, and are held by them as delicacies. The katy is interesting in captivity, and will live on fruit, for several weeks; like the grasshoppers, after the warm season they usually become old, the voice ceases, and all finally perish.

**KATZBACH**, a small river of Prussian Silesia, which joins the Oder on its left bank, 29 m. N. W. of Breslau, after a course of 35 m. It is noted for a victory of the Prussians and Russians under Blücher over the French commanded by Macdonald, achieved on its banks near Liegnitz, Aug. 26, 1813.

**KAUAI**, the principal N. W. island of the Hawaiian group, in lat. 22° N., lon. 159° 30' W.; area, 527 sq. m.; pop. in 1872, 4,961. It is irregularly circular, about 28 m. in diameter, and mountainous. Waialeale, the highest peak (about 6,000 ft.), is a little E. of the centre. West of this summit is a table land of nearly 40 sq. m. and about 3,000 ft. high; it terminates in a steep precipice on the coast. At other parts of the island the shore is generally a sandy beach interrupted by basaltic cliffs from 10 to 150 ft. high. The rock of the mountain is a compact ferruginous basalt. The shore ridges contain less iron and are more cellular; they vary in their structure from a compact phonolite to a heavy basalt. Crystals of quartz and iron pyrites are found in various parts. On the W. coast is a steep sand bank about 60 ft. high, known as the "barking sands," formed by the action of the wind, and constantly advancing on the land. Visitors slide their horses down the face of the bank, when a noise as of subterranean thunder is heard. The valleys are deep and numerous, and every ravine is a watercourse. Kauai has a larger proportion of arable land than any other of the Hawaiian islands, its lowlands being mostly on the windward or rainy side. In the valleys the soil is sometimes 10 ft. deep. Hanalei, on the N. side, is reputed to have a larger rainfall than any other place in the group. The leeward or S. W. districts are comparatively dry and barren. The largest river, the Hanalei, empties into a tolerable harbor of the same name; Ko-

loa (the principal town) and Nawiliwili have also good anchorage. Kauai is regarded, on account of the greater decomposition of its lavas, the degradation of its ridges, and the absence of recent volcanic products, as the oldest member of the Hawaiian group. The whole island, however, bears clear traces of its volcanic origin. In most parts the scenery is of extreme beauty. The chief product of Kauai is sugar; the raising of cattle is also a considerable business, hides, tallow, and wool being exported. Breadfruits, kalo, bananas, cocoanuts, oranges, and other tropical fruits grow abundantly. The native population of the island is decreasing.

**KAUFFMANN, Maria Angélica**, a Swiss painter, born in Coire, Oct. 30, 1741, died in Rome, Nov. 5, 1807. At the age of 15 she was taken to Milan and put under the best masters in music and painting, and in 1768 she accompanied her father to Rome. Winkelmann, whose portrait she painted, in a letter written in 1764, speaks in the warmest terms of her many accomplishments, and of her intimate acquaintance with modern languages. While in Rome she painted many portraits of distinguished people. In 1765 she accompanied Lady Wentworth to England, where she was received with every mark of attention. Upon the establishment of the royal academy she was chosen one of the 36 original members. In 1781 she married Signor Antonio Zucchi, an artist, and the following year returned to Rome, where she passed the rest of her life. Some years previous to this she had been betrayed into marriage with an impostor who assumed the title of Count Horn, from whom she procured a divorce. Many of her works were engraved by Bartolozzi. She retained her maiden name until her death.

**KAUFMAN**, a N. E. county of Texas, bounded S. W. by Trinity river, and drained by the E. fork of that stream; area, 950 sq. m.; pop. in 1870, 6,895, of whom 838 were colored. The surface is mostly undulating, and the S. E. part is well timbered, while the N. W. is occupied by prairies. The soil is generally good. The chief productions in 1870 were 179,658 bushels of Indian corn, 11,700 of sweet potatoes, and 1,910 bales of cotton. There were 2,605 horses, 25,643 cattle, 2,448 sheep, and 8,406 swine. Capital, Kaufman.

**KAUFMANN, Constantin Petrovitch**, a Russian general, born in the Baltic provinces about 1817. He is of humble origin, but early acquired distinction as a military engineer, and served for some time as chief of staff in the Caucasus. At a later period he held a post in the ministry of war, and cooperated in the thorough reform of the army. In 1864 he was appointed governor general of the military division of Wilna, including Lithuania, Livonia, and Courland; and in 1867 of the newly established division of Turkistan, which post he continued to hold in 1874 with the rank of lieutenant general. The progress of Russia in

central Asia is mainly due to his efforts. In 1873 he conducted the successful campaign in Khiva, which virtually placed that territory under Russian control by the treaty of peace which he signed with the khan on Aug. 25.

**KAUFMANN, Theodor**, an American painter, born at Uelsen, Hanover, Dec. 18, 1814. He served for several years as a mercantile apprentice, and studied painting in Hamburg, and under Hess in Munich. Implicated in the revolutionary movement of 1847-'9, he left Germany, and in 1850 settled in the United States. He served in the army during the civil war, and afterward resided in Boston. His works include "General Sherman near the Watch-fire," "On to Liberty," and "A Pacific Railway Train attacked by Indians." His "American Painting Book" was published at Boston in 1871.

**KAULBACH, Wilhelm von**, a German painter, born in Arolsen, Oct. 15, 1805, died in Munich, April 7, 1874. His mother was a superior woman, and his father was a skilful goldsmith and engraver. But the family was so poor that he and his sister were glad to accept even stale bread from the peasantry in exchange for the father's engravings; and this is said to have suggested to him his earliest work, "The Fall of Manna in the Wilderness." The sculptor Rauch procured his admission to the academy of Düsseldorf. He became the most distinguished pupil of Cornelius, and in 1825 followed him to Munich, where he spent the rest of his life, the last 25 years as director of the academy. Under the direction of Cornelius he designed (1825-'8) many frescoes for the new buildings at Munich, including "Apollo and the Muses," for the ceiling of the Odeon; designs from Klopstock's "Battle of Hermann," and from Goethe's and Wieland's poems, for the royal palace; purely classical illustrations of the story of Amor and Psyche, for the palace of Duke Max; and many allegorical figures for the arcades of the palace garden. These works established his reputation as the most admirable exponent of the idealistic school, while his "Lunatic Asylum," commenced at Düsseldorf, where he had taken a morbid delight in watching the insane, made him famous as an equally great master of realism. His next great work, the "Battle of the Huns," or "Spectre Battle," representing the legend of the continued combat in mid-air between the spirits of the Huns and of Romans who had fallen before the walls of Rome, exhibited on the largest scale his genius for the symbolical and allegorical. Count Raczynski commissioned him to paint the work in sepia, and he finished it in 1837. The king of Saxony now offered him the direction of the academy of Dresden, with a salary of 2,000 thalers; but Kaulbach preferred to remain in Munich, although he received only 800 florins from the king of Bavaria. In 1838 he finished his masterpiece, the "Destruction of Jerusalem by Titus," a colossal cartoon giving the fullest scope to his imaginative power and to

his wonderful capacity for idealizing history. It illustrates the fulfilment of the prophecies by the Roman eagle on the high altar of the temple, and by woe-stricken women and distracted priests committing suicide; the triumph of Christianity by angels who rescue the faithful from the scene of terror; and the punishment inflicted upon unbelievers by the wandering Jew pursued by demons. Having hitherto worked almost exclusively in fresco, he spent some time in Venice and a year in Rome to prepare himself for painting the cartoon in oil for the new Pinakothek, completing it in 1846. About the same time he commenced his famous designs illustrative of the history of mankind for the new museum at Berlin, which were executed by his pupils and completed in 1860. They consist of six frescoes, representing the "Tower of Babel," "Homer and the Greeks," the "Destruction of Jerusalem," the "Battle of the Huns," the "Crusaders at the gates of Jerusalem," and the "Age of the Reformation." Allegorical pictures of the progress of the various nations and figures of sages and heroes fill the surrounding compartments, and an extensive frieze running round the whole, with countless lovely boys, symbolizes in their childish sports the varied incidents of humanity since the dawn of time. A complete set of engravings of these frescoes, chiefly by Eichen, was published in 1874. To the same period belong his cartoons in the new Pinakothek of Munich, showing the progress of art during the present century, for which he incurred the censure of several artists, especially Schnorr, on account of its satirical tendency. His overflowing humor and sarcasm appear in many of his other works, especially in his designs for *Reineke Fuchs*, in which he also proves himself to be an excellent painter of animals. But the grotesque, though not unsuitable to this subject, was often mixed up with the sublime in his productions; and for this he was much blamed by rigid purists, while others compare his irrepressible disposition to present a comprehensive view of all the various phases of human character to the similar tendency in Shakespeare. His designs to Shakespeare indicate his sympathy with his genius, and his careful study of Hogarth is also attested in these illustrations, and in many others, including *Faust* and Schiller's *Verbrecher aus verlorenen Ehre*. Among his other works, besides many portraits, are the "Assassination of Caesar," the "Battle of Salamis," for the Maximilianum at Munich, and the "Opening of the Tomb of Charlemagne by Otho the Great," which he presented to the Germanic museum at Nuremberg. His paintings in private American galleries include a "Caritas," in possession of the Longworth family in Cincinnati, and the "Meeting of Queen Elizabeth with Mary Stuart," in that of Mr. George O. Wetmore of New York. His fervent Protestantism, which alienated him in the latter part of his life from Cornelius, who was as decided a Catholic, is

most strongly expressed in his "Don Pedro de Arbués, the Inquisitor," which, appearing at the time of the oecumenical council (1869-70), produced a great sensation, and gave rise to many controversies. Shortly before his death he was at work upon a large cartoon of "The Deluge;" and he had finished his "St. Michael, the Patron Saint of Germany," in the garb of a heavenly messenger with a radiant air of triumph, and with Napoleon III. and his son and several Jesuits cowering at his feet. This work has been characterized as a grand memorial of his nation's and of his own greatness. His death was mourned as a national calamity, and measures have been taken for the erection of a monument in his honor.—His cousin FRIEDRICH excels as a portrait painter; and he has also painted "Adam and Eve finding the Corpse of Abel," the "Coronation of Charlemagne," "Mozart performing his Requiem shortly before his Death," and other historical pictures.

**KAUNITZ, Wenzel Anton**, prince, count of Rietberg, an Austrian statesman, born in Vienna in 1711, died June 27, 1794. One of 19 children, he was destined for the church; but after the death of some of his elder brothers, he chose a secular career, studying at Vienna, Leipsic, and Leyden. He became a chamberlain of the emperor Charles VI., travelled for some years in Germany, Italy, France, and England, and in 1735 was appointed aulic councillor of the empire. By marriage he became the proprietor of the county of Rietberg. His influence rose under the daughter and successor of Charles, Maria Theresa, when, after various and successful diplomatic missions to Rome, Turin, and Brussels, and a short administration of the Austrian Netherlands till their occupation by the French in 1746, he signed for Austria the treaty of Aix-la-Chapelle (1748). Shortly after he became minister of state, but soon left this post, being sent as ambassador to France, where he secured the influence of Mme. de Pompadour for an alliance with Maria Theresa. This was effected in 1756, and the seven years' war began, after the conclusion of which Kaunitz, who in 1753 had been appointed chancellor, was elevated to the rank of prince of the empire. He accompanied Joseph II. to the interview at Neustadt in Moravia with Frederick the Great, when the two monarchs concerted the scheme of the first partition of Poland, but against the opinion of the minister. Frederick speaks disparagingly of him in his memoirs; and Joseph, whom he served without success in his schemes for the annexation of Bavaria, gradually withdrew his favor from the old statesman during his actual reign (1780-90). Kaunitz gained new influence during the short reign of Leopold II., but after the accession of his son Francis (1792) he resigned his offices. A taciturn and scheming diplomatist, Kaunitz was ceremoniously grave with his equals, fond of the French language, literature, and fashions, and

with much frivolity, vanity, and self-love united probity, affability toward inferiors, and fidelity to the interests of the empire.

**KAVANAGH, Julia**, a British authoress, born in Thurles, Ireland, in 1824. At an early age she accompanied her parents to France, where she was educated. In 1844 she took up her residence in London. She published in 1847 a tale for children entitled "The Three Paths." This was followed by "Madeleine" (1848), a story of peasant life in France, and in 1850 by a series of historical sketches, "Woman in France in the 18th Century." In 1851 appeared "Nathalie," a novel, in which the scene is also laid in France. Among her other works are: "Women of Christianity exemplary for Piety" (1852), "Daisy Burns" (1853), "Grace Lee" (1854) "Rachel Gray" (1855), "The Hobbies" (1857), "Adèle" (1858), "French Women of Letters" (1861), "English Women of Letters" (1862), "Queen Mab" (1863), "Sibyl's Second Love" (1867), and "Sylvia" (1870).

**KAVANAUGH, Hubbard Wade**, an American bishop, born in Clark co., Ky., Jan. 14, 1802. At the age of 15 he was apprenticed to a printer, was licensed as a local preacher of the Methodist church in 1822, and printed a secular journal at Augusta, Ky. He joined the Kentucky annual conference in 1823, and was employed on very extensive and laborious circuits, riding on horseback 200 miles, and preaching at 25 regular appointments, every 28 days. After five years given to this circuit service, he was engaged from 1828 to 1846 in the pastorate, in the superintending of public instruction, and in college agencies. In 1854, at the general conference of the Methodist Episcopal church south, he was elected bishop, which office he continued to hold in 1874.

**KAYE, John**, an English bishop, born in Hammersmith, London, in 1783, died in Lincoln, Feb. 19, 1853. He graduated at Christ's college, Cambridge, in 1804, was elected master of the college in 1814, and in 1815 was made D. D. by royal mandate. In 1816 he became regius professor of divinity. He was made bishop of Bristol in 1820, and was translated to Lincoln in 1827. His writings include "Ecclesiastical History of the Second and Third Centuries illustrated from the Writings of Tertullian" (1826); "Some Account of the Writings and Opinions of Clement of Alexandria" (1835); "Some Account of the Writings and Opinions of Justin Martyr" (1836; 8d ed., 1853); and "Account of the Government of the Church during the First Three Centuries" (1835). He also published anonymously "Remarks on Dr. Wiseman's Lectures," and "Reply to the Travels of an Irish Gentleman."

**KAYE, Sir John William**, an English author, born in 1814. After serving for some time as lieutenant in the army in India, he returned to England in 1845, and devoted himself to literature. In 1856 he entered the home civil service of the East India company, and upon the

transfer to the crown of the government of India, he was made secretary to the political and secret department of the India office. He was knighted in 1871. He has written "History of the War in Afghanistan" (4 vols., 1851-'3; new ed., 1874); "History of the Administration of the East India Company" (1858); "Life and Correspondence of Lord Metcalfe" (1854); "Life and Correspondence of Sir John Malcolm" (1856); "Christianity in India" (1859); "History of the Sepoy War" (2 vols., 1866-'71); and "Essays of an Optimist" (1870).

**KAZAN, or Kasan.** I. An E. government of European Russia, bordering on Viatka, Ufa, Simbirsk, and Nizhegorod; area, 28,727 sq. m.; pop. in 1867, 1,670,337. The surface is generally flat, but in parts undulating and hilly, the S. portion being traversed by inconsiderable branches of the Ural mountains. The

principal rivers are the Volga and its affluent the Kama. The forests are very extensive, covering nearly half the surface. The woods abound in bears, wolves, and feathered game. The soil is fertile, and yields large crops of grain, hemp, flax, &c., but is not generally well cultivated. The fisheries are productive, and there are numerous distilleries, tanneries, weaving and spinning establishments, &c. The Russians form nearly one half of the population; the Tartars number about 300,000; the rest of the inhabitants are Tschuvashes of Finnish origin, Tcheremisses, &c. Kazan, with the neighboring governments of Pensa, Simbirsk, Viatka, and Perm, formerly constituted part of the so-called Golden Horde, or the Kiptchak khate, the country having successively been occupied by Finns, Bulgarians, and Tartars. The khanate was for centuries the terror of Russia.



Semiozernoi Convent, Kazan.

and resisted that power until the middle of the 16th century, when it was conquered by Czar Ivan the Terrible, and annexed as a kingdom to Russia. II. A city, capital of the government and of a circle of the same name, situated on the Kazanka, about 3 m. above its confluence with the Volga, 430 m. E. of Moscow; pop. in 1867, 78,602, about one fourth of whom were Mohammedans. It consists of the fortified town (*Kreml*) and the town proper. It contains over 30 churches, 9 convents, and 16 mosques, and is renowned for its numerous educational and literary institutions, including a university, opened in 1814, which has a special importance from the attention given in it to the study of living Asiatic languages. It possesses many important manufactories of cloth, woollen, leather, soap, and iron, and an extensive trade, being the great emporium of

the commerce between Russia and Siberia. Near Kazan is the Semiozernoi convent, with a miracle-working madonna, the patroness of the city, which is annually in July brought in procession to the city and exhibited in the Kreml. Kazan was destroyed by fire in 1613 and again in 1842, but it has risen from its ashes more prosperous and better built than ever.

**KAZINCZY, Ferencz**, a Hungarian author, born in the county of Bihar, Oct. 27, 1759, died in that of Zemplén, Aug. 22, 1831. He pursued his classical studies from 1769 to 1779 at the college of Patak, and subsequently studied law at Kaschau. On the recommendation of Count Török he was made inspector of schools, but devoted himself chiefly to literature, and especially to the restoration of the Magyar language in its purity, and the development of all its literary capabilities. With Szabó and Ba-

csányi he edited the "Magyar Museum," and subsequently alone the "Orpheus," both literary magazines published at Kaschau. Having become implicated in the democratic conspiracy of the abbot Martinovics, he was suddenly arrested at the house of his mother in Lower Regmecz, on Dec. 14, 1794, carried to Buda, tried, and condemned to death; his sentence was commuted to imprisonment. He was kept in the dungeons of Buda, Brűnn, Kufstein, and Munkács, and released in 1801. He married the daughter of his former protector, Count Tőrök, and retired to a country residence in the neighborhood of Sátoralja-Ujhely, which he named Széphalom (Fairhill), and where he spent the remainder of his life, continuing to labor for the literary progress of his country. His works, which have twice been collected (Pesth, 1814, 1836), contain original epistles, epigrams, sketches of travel, a tragedy, &c., besides translations from Goethe, Lessing, La Rochefoucauld, Sterne, and others. He also edited the works of Zrinyi the poet, Baróczi, Dajka, and Kis, and a volume of "Hungarian Antiquities and Rarities" on grammatical subjects. In 1859 the centennial birthday of Kazinczy was celebrated throughout Hungary.

**KEAN. I. Edmund**, an English actor, born in London, March 17, 1787 (according to the suggestion of his biographer Mr. Procter, although other accounts make the year 1789 or 1790), died in Richmond, May 15, 1833. His father was a stage carpenter, and his mother, whose name he retained during his childhood, was Miss Ann Carey, by profession an actress, and a descendant of Henry Carey the poet. At two years of age he was taken in charge by a Miss Tidswell, who put him to school in London. A few years later his mother, who occasionally followed the business of an itinerant vender of perfumery, took him with her in her peregrinations, and brought him under the notice of a Mrs. Clarke. He had, almost as soon as he could walk, appeared at Drury Lane theatre as Cupid in the opera of "Cymon," and had subsequently taken children's parts on the stage. He made so favorable an impression upon Mrs. Clarke, that he remained for two years under her protection, and received instruction in dancing, fencing, and various other accomplishments. When about 12 years of age he enrolled himself in a strolling troop of which his mother was a member, and on one occasion at Windsor recited in the presence of George III. From the beginning of the century to the period of his first appearance in London in 1814, he was connected with strolling companies or provincial theatres, assuming every variety of character, from the leading parts in tragedy to harlequin in the pantomime, and by very slow degrees forcing his talents into notice. In 1808 he was married, and during several years experienced many vicissitudes of fortune, being frequently reduced with his family, consisting of his wife and two children, to the verge of starvation. In 1813 Dr. Drury, the

master of Harrow school, saw him act at Teignmouth, and was so impressed with his dramatic abilities that he procured him an introduction to the manager of Drury Lane theatre, by whom he was engaged for three years at a salary of £8, £9, and £10 per week for each successive year. He made his first appearance Jan. 26, 1814, as Shylock, before a meagre audience, not particularly predisposed in his favor; but so great were his powers and the vigor of his personation, that at the fall of the curtain he was greeted by applause such as had not for many years been heard in Drury Lane, his appearance, according to Hazlitt, being "the first gleam of genius breaking athwart the gloom of the stage." After his third performance of Shylock, a new engagement at a far higher salary was offered to him; and not long after he received from the committee of Drury Lane theatre a present of £500, besides numerous valuable gifts from private persons. He subsequently appeared as Richard III., Hamlet, Othello, Iago, Macbeth, Sir Giles Overreach, Sir Edward Mortimer, Lear, and in various other characters, with undiminished success, and for several years was the most eminent and popular actor on the British stage. In 1820 he made a professional tour in the United States, which at first was attended with great success; but in May, 1821, his refusal to complete an engagement in Boston, in consequence of the thinness of the houses, created an excitement which led to his abrupt departure from the city. Upon returning to England, he played his usual round of characters; but after the developments respecting his criminal connection with the wife of Alderman Cox, in the action of Cox v. Kean, January, 1825, in which a verdict of £800 damages was pronounced against him, he was hissed from the stage in Edinburgh and London. In 1825 he returned to the United States, and was at first received with riot and confusion wherever he attempted to act. Having tendered an apology, he appeared in New York and Philadelphia, but was not permitted to perform in Boston or Baltimore. During this visit he was elected a chief of the Tuscarora Indians by the name of Alantenouidet. Subsequent to his return to England in 1826 his health and spirits, undermined by habits of drinking, gave way rapidly, and it was only by the use of stimulants that he could still act his old parts. He was unable to master a new one, forgetting the words almost as soon as he acquired them. In February, 1833, he was announced to appear in "Othello" with his son Charles. On the night of the performance he succeeded with difficulty in getting through two acts of the play, but in the third act, while uttering the words, "Villain, be sure," &c., he fell exhausted into the arms of his son, who acted Iago, and was borne from the stage. This was his last appearance before the public. Kean was short of stature, but well formed and graceful, and his eyes were singularly black and brilliant.

His countenance was capable of wonderful variety and intensity of expression, and his action, which, as well as his conceptions of character, was the result of deep study, lifted him far above the ordinary heroes of the stage. He possessed vigor, pathos, sarcasm, and the power of communicating terror in the highest degree; and his intensity in expressing all the passions has never been excelled. His biography was written by B. W. Procter (Barry Cornwall) (2 vols. 8vo, London, 1835). **II. Charles John**, an English actor, son of the preceding, born in Waterford, Ireland, Jan. 18, 1811, died in London, Jan. 22, 1868. He was educated at Eton, whence he was withdrawn at the age of 16 in consequence of the refusal of his father to maintain him longer at school, the son having incurred his displeasure by declining the offer of a cadetship in India in order to look after the wants of his mother. In this emergency Charles Kean determined to adopt the stage as a profession, and on Oct. 1, 1827, made his debut at Drury Lane in the character of Young Norval. His success was not striking, and for several years he made no impression upon the public. In 1830 he visited the United States, and after his return to England in 1833 began by degrees to assume the position of a leading actor in London. In 1839 he revisited America, returning to England in the following year; and in 1842 he was married to the actress Ellen Tree. In 1845 he made a third visit to the United States, performing with his wife in the chief cities for upward of two years. For several years after his return he played engagements at the principal theatres in London and the provinces, and in 1850 he became the sole lessee of the Princess's theatre, where for a number of seasons he produced splendid revivals of "Macbeth," "King John," "Richard III.," "Richard II.," the "Tempest," and other Shakespearian plays. As an actor he held a respectable position. As a stage manager he exhibited good taste and abundant resources, and was for several years the director of the theatrical performances at Windsor castle. In 1863 he made with his wife a professional tour to Australia, returning in 1866 by way of California. In 1859 appeared the "Life of Charles Kean," by J. W. Cole (2 vols. 8vo, London). **III. Ellen (Tree)**, an English actress, wife of the preceding, born in London in 1805. She first appeared upon the stage at Covent Garden theatre, London, in 1823, and within a few years became one of the leading members of her profession, excelling both in comedy and tragedy. In December, 1836, she made her debut upon the American stage at New York, and subsequently acted with success in the chief cities of the United States and Canada. In 1842 she was married to Charles Kean, with whom she continued to appear down to the time of his death, when she retired from the stage. Among her most popular characters were Beatrice in "Much Ado about Nothing," Rosalind in "As You Like It," Portia in the

"Merchant of Venice," Viola in "Twelfth Night," Julia in "The Hunchback," and Mr. Haller in "The Stranger."

**KEANE, John**, first Lord Keane, a British general, born at Belmont, county Waterford, Ireland, in 1781, died at Burton Lodge, Hampshire, England, Aug. 24, 1844. He entered the British army as ensign in his 13th year, and during the campaign in Egypt acted as aide-de-camp to Lord Cavan. He served in Spain, where he gained the rank of major general. In the autumn of 1814 he was appointed to command the land forces destined to attack New Orleans, but was superseded by Sir Edward Pakenham, under whom however he continued to serve, and was twice severely wounded. From 1823 to 1830 he was commander-in-chief of the West Indian army, and during a part of that period administered also the civil government of Jamaica. In 1833 he was sent to India, and in 1839 captured the fortress of Ghuznee in Afghanistan, till then deemed impregnable. For this exploit he was raised to the peerage as Baron Keane, in December, 1839, and received from the East India company a pension of £2,000.

**KEARNEY**, a S. county of Nebraska, bounded N. by the Platte river; area, about 525 sq. m.; pop. in 1870, 58. A large portion is occupied by prairies. The Burlington and Missouri River railroad traverses it. Capital, Fort Kearney.

**KEARNY, L. Lawrence**, an American naval officer, born in Perth Amboy, N. J., Nov. 30, 1789, died there, Nov. 29, 1868. He entered the navy as a midshipman in 1807. When the war with Great Britain broke out he was first lieutenant of the *Enterprise*, and in her he was wrecked while on a cruise from New Orleans in 1812. After the war he distinguished himself in clearing the West Indies and the gulf coast of pirates. In 1827 he sailed as commander in the ship *Warren* for the Mediterranean, where he attacked the Greek pirates, broke up their rendezvous, and dispersed them. At one time he had more than 109 pirates in chains on board his ship. Becoming a captain in 1832, he took command of the East India squadron in 1841, greatly promoted American interests in China, and returned home in 1844. He was made a commodore in 1866. **II. Stephen Watts**, an American soldier, born in Newark, N. J., Aug. 30, 1794, died in St. Louis, Mo., Oct. 31, 1848. He entered the army in 1812, in 1833 became lieutenant colonel of dragoons, in 1836 colonel, and in June, 1846, a brigadier general. At the commencement of the Mexican war he commanded the "army of the West," which marched from Bent's fort on the Arkansas westward, and conquered New Mexico. Having established a provisional civil government in Santa Fé, he proceeded to California, and in December participated with his command in the battle of San Pascual, where he was twice wounded. He subsequently commanded the sailors and marines and a detachment of dragoons in the battles of San Gabriel

he plains of *Mesa*, Jan. 8 and 9, 1847. He appointed brevet major general, and was nor of California from March to June,

He was the author of a work on the "Maring of Dragoons" (1837), and of "Laws of Government of New Mexico" (1846). **Philip**, an American soldier, nephew of receding, born in New York, June 2, 1815, near Chantilly, Va., Sept. 1, 1862. He and law, but in 1837 accepted a commission and lieutenant in the 1st dragoons, commanded by his uncle. Being soon afterward to Europe by the government to study report upon the French cavalry tactics, he led the military school at Saumur, then to Algeria, joined the chasseurs d'Afrique volunteer, and received the cross of the of honor for his bravery. On his return home in 1840 he was appointed aide-de-camp to Gen. Macomb, and the next year to Scott, which appointment he held till

In 1846 he was made captain of dragoons. He furnished his men with equipments and arms from his private means, and his command formed the escort of Gen. Scott when he led Vera Cruz. He was brevetted major for his conduct at Contreras and Churubusco. He was in charge on the San Antonio gate at the city of Mexico when he lost his left arm. At the close of the Mexican war he was ordered to California and commanded an expedition against the Indians of Columbia river. In 1851 he resigned and returned to Europe, where he continued to study military studies. In the Italian war of 1859 he served as a volunteer aide on the staff of French general Maurier, was in the battle of Magenta and Solferino, and received from Napoleon III. for the second time the cross and legion of honor. On the breaking out of the American civil war he hastened home, was placed in command of a brigade, and was in command of a division in the army. He distinguished himself at the battles of Williamsburg, Seven Pines, and Frazier's Farm, and was made a major general of volunteers July 1862. He was prominent at the second battle of Bull Run. During the action at Antietam he rode forward in advance of his regiment to reconnoitre, and fell in with a Confederate soldier, of whom he inquired the position of the regiment. Discovering his mistake, he tried to ride away, when the soldier fired, and Keats fell mortally wounded.

**Keats, John**, an English poet, born in London 1795 or 1796, died in Rome, Feb. 27, 1821. He was sent at an early age with his mother to a school in Enfield, where he remained until his 15th year. He seems to have been careless of the ordinary school distinctions, and whatever authors attracted his fancy. He never advanced in his classical studies beyond Latin, and his knowledge of Greek mythology was derived from Lempriere's dictionary and Tooke's "Pantheon;" a singular fact considering the thoroughly Hellenic spirit which pervades some of his works. In 1810 he was re-

moved from school, and apprenticed for five years to a surgeon in Edmonton. His earliest known verses are the lines "In Imitation of Spenser." About the same time he became acquainted with Homer through Chapman's translation, and commemorated his emotions in the sonnet, "On first looking into Chapman's Homer." Upon the completion of his apprenticeship he removed to London to "walk the hospitals," and made the acquaintance of Leigh Hunt, Haydon, Hazlitt, Godwin, and other literary men, incited by whose praise he published a volume of poems, comprising sonnets, poetical epistles, and other small pieces, which excited little attention. He soon perceived that the profession of a surgeon was unfitted for him, both on account of his extreme nervousness in the performance of operations, and of the state of his health; and in the spring of 1817 he was induced by symptoms of consumption to make a visit to the country. During this absence he commenced his "Endymion," which, with some miscellaneous pieces, was published in the following year. Keats had allied himself with a political and literary coterie obnoxious to the "Quarterly Review" and "Blackwood's Magazine," and the appearance of a volume of poems by a new writer of the "cockney school" was the signal for an attack upon him by these periodicals, the bitterness of which savored more of personal animosity than of critical discernment. The insulting allusions to his private affairs and his family aroused in the poet no other feeling than contempt or indignation; and if we may judge from his letters, far from being crushed in spirit by the virulence of his reviewers, he would have been much more inclined to inflict personal chastisement upon them if he had met them. Byron in "Don Juan," and Shelley in "Adonais," have apparently confirmed the notion that his sensitive nature on this occasion received a shock from which it never recovered; but the effect of the criticism has been greatly exaggerated. His health was failing rapidly, but from other causes. His younger brother's death in the autumn of 1818 affected him deeply, and about the same time he experienced a passion for a lady of remarkable beauty, the effect of which upon a frame worn by disease was fatal. His little patrimony became exhausted, and he began to think of making literature his profession. While preparing a third volume for the press he was attacked with a violent spitting of blood. After a long illness he recovered sufficiently to think of resuming his literary avocations, but found his mind too unstrung by sickness and the passion which had such an influence over him. In this emergency he had nearly determined to accept the berth of surgeon in an Indian man, when a return of the previous alarming symptoms made it apparent that nothing but a winter in a milder climate would offer a chance of saving his life. Before his departure he published a volume containing his



odes on the "Nightingale" and the "Grecian Urn," the poems of "Lamia," "The Eve of St. Agnes," "Isabella," &c., and the magnificent fragment of "Hyperion." In September, 1820, Keats left England with Mr. Severn, a young artist and a devoted friend, who never left his bedside. He lingered a few months at Naples and Rome, and died at the latter place after much suffering. A few days before his death he said that he "felt the daisies growing over him." He was buried in the Protestant cemetery in Rome, near the spot where Shelley's ashes were afterward interred; and upon his tomb was inscribed the epitaph, dictated by himself: "Here lies one whose name was writ in water." His modest hope that "after his death he would be among the poets of England," has been more fully realized than he could have anticipated; and his influence can be traced in the poetic development of many later writers.—See "Life, Letters, and Literary Remains of John Keats," by R. M. Milnes (Lord Houghton) (2 vols., London, 1848).

**KEBLE, John**, an English poet, born near Fairford, Gloucestershire, April 25, 1792, died at Bournemouth, Hampshire, March 29, 1866. He graduated at Oriel college, Oxford, in 1810, obtaining a double first in classics and mathematics, a distinction never gained before that time, except in the instance of Sir Robert Peel in 1808. For some years afterward he was a fellow, master of the schools, examiner, and college tutor. In 1815 he was ordained, and in 1823 he resigned his Oxford employments to accept the curacies of Eastleach, Burthorpe, and Southrop, the united receipts of which did not amount to more than £100 a year. In 1824 he refused an archdeaconry in the West Indies, worth £2,000 a year, which was pressed upon him by William Hart Coleridge, bishop of Barbadoes; and a year afterward he accepted the curacy of Hursley. In 1832 he was made professor of poetry at Oxford, and he held that post for two periods of five years each. His lectures were in Latin, and were published under the title of *Prælectiones Academicæ* (2 vols., 1832-'40). In 1833 he was appointed to deliver the summer assize sermon at Oxford, which was subsequently published under the title of "National Apostasy," and was memorialized by Dr. Newman in his "Apologia" as "the start of the religious movement" of that time. Of the "Tracts for the Times" (Oxford, 1833-'41), Keble wrote Nos. 4, 13, 40, and 89. In 1835 he became vicar of Hursley and rector of Otterbourne, which livings he held till his death. His principal works are: "The Christian Year: Thoughts in Verse for the Sundays and Holidays throughout the Year" (2 vols., Oxford, 1827); "The Psalter, or Psalms of David in English Verse" (1839); "Lyra Innocentium: Thoughts in Verse on Children," &c. (1846); and several volumes of academical and occasional sermons. He edited and annotated the complete works of Richard Hooker (4 vols., 1836); in 1837, with Dr. New-

man, he edited "Froude's Remains;" in 1838, with Dr. Newman and Dr. Pusey, he began the editing and annotation of the Oxford edition of the "Library of the Fathers," which in a few succeeding years grew into a series of 39 octavo volumes. He is author of the much commended article on "Sacred Poetry" in vol. xxxii. of the London "Quarterly Review." "The Christian Year" is the most remarkable of his works. It was first published anonymously, and within 25 years 108,000 copies had been printed in 43 editions. Nine months after the author's death the 100th edition was reached, with a total circulation, in English editions and American reprints, of not less than 500,000 copies. It has appeared in all sizes and some editions, and separate poems, like the "Evening and Morning Hymns," have been profusely illustrated and illuminated. In 1867 M. Fyler produced in a quarto volume 686 illustrations of poetic imagery from "The Christian Year." A comprehensive and minute "Concordance" has been published. Charlotte Mary Yonge published "Musings on The Christian Year" (London, 1870). Keble retained his copyright till his death, and from the profits of the book, in 1846-'8, the ancient cumbrous brick church of Hursley was replaced by one of the most beautiful parish churches in the kingdom. The copyright expired March 29, 1873, and within five weeks ten different editions were issued by London publishers. Since his death Keble college, Oxford, has been founded in his honor. The best biography of Keble is by Sir John Taylor Coleridge (London, 1868; 4th ed., 1874).

**KECSKEMÉT**, or *Ketskemét*, a city of Hungary, in the county and 50 m. S. E. of the city of Pesth, on the railway to Szegedin; pop. in 1870, 41,195. It contains churches for the Roman Catholics, Protestants, and Greeks, a synagogues, a Catholic gymnasium, a Reformed lyceum, and various other educational institutions. It has soap manufactories and tanneries, a lively trade in horses and cattle, and five annual fairs.

**KEECHIES**, a tribe of Indians, originally in Texas, apparently the same mentioned by Spanish authorities about 1780 as the *Quitzeia*, and then north of Bucareli. They were a small tribe numbering less than 100 men able to bear arms. In 1822 they were on Trinity river to the number of 261. After Texas became part of the United States, the Keechies and other Indians were placed on a state reservation, and remained there quietly till 1859, when organizations were formed to destroy the Indians on the reservations. To save them the United States government removed them to lands leased from the Choctaws and Chickasaws. The Keechies settled on the Canadian river, and had just begun to prosper when the civil war broke out, and they were again exposed to their enemies, and removed to the Little Arkansas in great destitution. They were restored to the leased lands in 1867. In 1873

they were with the Wichitas on Washita river, near old Fort Cobb, to the number of 126. Their language shows that, like the Wichitas, they are of the same stock as the Pawnees.

**KEENE**, a city, capital of Cheshire co., New Hampshire, on the left bank of the Ashuelot river, at the junction of the Cheshire and Ashuelot railroads, 43 m. W. S. W. of Concord, and 80 m. N. W. of Boston; pop. in 1870, 5,971. It is pleasantly situated, well built, and laid out with great regularity, the principal streets radiating from a central square, near which stands a handsome court house. An active trade is carried on with the surrounding country, and there is a large number of manufacturing establishments, including woollen mills, machine shops, tanneries, and establishments for manufacturing carriages, chairs, furniture, sashes, doors, and blinds, earthenware, &c. The railroad repair shops employ a large number of workmen. There are three national banks with an aggregate capital of \$500,000, two savings banks, graded public schools, including a high school, two weekly newspapers, and seven churches. Keene was settled about 1735, and called Upper Ashuelot. It received its present name in 1753, and was incorporated as a city in 1874. The population is rapidly increasing.

**KEENE, Laura**, an American actress, born in England in 1820, died at Montclair, N. J., Nov. 4, 1873. She was distinguished on the London stage in light comedy, and excelled particularly as Pauline in "The Lady of Lyons." She first appeared in New York, Sept. 20, 1852, played in San Francisco in 1854, and afterward in Australia. In 1855 she assumed the management of the Varieties theatre in New York, and soon afterward of a new one called Laura Keene's theatre (now the Olympic); and in October, 1858, she brought out "Our American Cousin," with Jefferson as Asa Trenchard and Sothern as Dundreary. From 1860 to 1870 she managed a travelling company, reappeared in New York in 1870, and was last on the stage shortly before her death. Among her marked personations were Marco in "The Marble Heart" and Becky Sharp in "Vanity Fair."

**KEFF**, or **El-Keff**, a town of north Africa, in the regency and 88 m. S. W. of the city of Tunis; pop. about 6,000. It is the key of Tunis on the Algerian frontier, from which it is distant 27 m. It is built on an elevated plateau, and is surrounded by mountains and by forests of cedar and chestnut. The walls are kept in good repair, and the fortress mounts more than 130 cannon. The inhabitants include many warlike and occasionally troublesome mountaineers. The adjacent country is very fertile, and the scenery is beautiful. Keff possesses a Roman well and a statue of Venus. Inscriptions from here led to the supposition that it occupies the site of Sicca Veneria, a Numidian town, originally Phœnician, subsequently a Roman colony.

**KEHL**, a town of Germany, in Alsace-Lorraine, on the right bank of the Rhine, at its

junction with the Kinsig, opposite Strasburg; pop. about 4,000. It was fortified by the French toward the close of the 17th century, and was restored to Germany by the treaty of Ryswick (1697). Subsequently the fortifications were razed, and it became a thriving manufacturing and commercial place. During the revolution the fortifications were restored, and in 1815 again demolished, the town having been in the interval alternately in German and French possession, and endured many sieges and other vicissitudes. A new bridge over the Rhine, completed in 1861, placed Kehl in direct communication with the French railways, and trade prospered till 1870, when the Franco-German war injured the place. On July 22 the Germans began to blow up the railway bridge, and the French subsequently opened fire, destroying the handsome Gothic church, the custom house, the railway depot, and 40 private houses. Kehl belonged to the grand duchy of Baden till 1874, when it became part of Alsace-Lorraine.

**KEIGHLEY**, a town of England, on the Aire, and in the West Riding of Yorkshire, on the Liverpool and Leeds canal and the Preston and Leeds railway, 15 m. W. N. W. of Leeds; pop. in 1871, 15,965. It has a Latin school, a mechanics' institute, and manufactories of paper, linen, woollen, and cotton goods.

**KEIGHTLEY, Thomas**, a British author, born in Dublin in October, 1789, died near Erith, Kent, in December, 1872. He took his bachelor's degree at Trinity college, Dublin, in 1808, and devoted himself to literature in London. He assisted T. Crofton Croker in the "Fairy Legends of Ireland," published histories of Rome, Greece, and England, "Fairy Mythology," "Outlines of History," "Mythology of Ancient Greece and Italy," "History of India," "Scenes and Events of the Crusades," and other works, and edited the writings of Virgil, Horace, Ovid, and Sallust, and the "Life and Poems of Milton." Among his latest works was "The Shakespeare Expositor" (1867). In the latter part of his life he was pensioned by the government.

**KEILL, John**, a Scottish mathematician, born in Edinburgh, Dec. 1, 1671, died in Oxford, Sept. 1, 1721. He was educated at Edinburgh and Oxford, became assistant Sedleian professor of physics at Oxford in 1700, and was subsequently chosen fellow of the royal society of London. In 1709 he was appointed treasurer to the Palatines, German emigrants whom the government was sending to New England. On his return in 1710 he became Savilian professor of astronomy at Oxford. In 1711 he was appointed by Queen Anne decipherer of state papers. He was a fierce assailant of Burnet, Leibnitz, and the other opponents of the Newtonian theories. The most important of his many learned works are *Introductio ad Veram Physicam* (1701), and *Introductio ad Veram Astronomiam* (1718). The best edition of his works is that of Milan (1742).

**KEIM, Theodor**, a German theologian, born in Stuttgart, Dec. 17, 1825. He studied at Tübingen, and was connected with that university from 1851 to 1855, after having spent a year in Bonn. In 1857 he became deacon at Easlingen, in 1859 archdeacon, and in 1860 professor of theology at Zürich. He is prominent among liberal Protestant theologians. Among his works are several relating to the history of the reformation, and *Der geschichtliche Christus* (3d ed., Zürich, 1866).

**KEITH**, a S. W. county of Nebraska, recently formed, and not included in the census of 1870; area, 2,016 sq. m. It borders on Colorado, and is intersected by the forks of the Platte river. The Union Pacific railroad passes through it.

**KEITH, Alexander**, a British author, born at Keith Hall, Aberdeenshire, in 1791. He was educated in Scotland, and was a minister of the established church of Scotland, and after 1843 of the Free church, till ill health compelled his retirement from the pulpit. His principal work, "Evidences of the Truth of the Christian Religion, derived from the Literal Fulfillments of Prophecy" (Edinburgh, 1823), became a text book, passed through numerous editions, and has been translated into foreign languages; the later editions embody his personal investigations in the Holy Land.

**KEITH, J. George**, a Prussian diplomatist, born at Kincardine, Scotland, in 1685, died near Potsdam, Prussia, May 25, 1778. He was the tenth earl marischal, and the descendant of a race who had long been grand marischals of Scotland. Being outlawed and his estates confiscated for participation in the rebellion of 1715, he fled to Spain, and thence to Prussia, where he became a friend of Frederick the Great, who appointed him ambassador at Paris in 1751, governor of Neufchâtel in 1754, and envoy to Madrid in 1759. His estates were subsequently restored to him, and he also inherited in 1761 the entailed estates of the earls of Kintore. He died unmarried, and his eldest sister, wife of the earl of Wigtown, transmitted the Keith title to her daughter, who married Lord Elphinstone, and was the mother of Admiral Keith. **II. James**, brother of the preceding, born in Scotland, June 11, 1696, killed at Hochkirch, Oct. 14, 1758. He was likewise attainted of high treason on account of the rebellion of 1715, fled to France, where he studied mathematics under Maupertuis, and was admitted to the academy. In 1717 he went to Spain to serve the cause of the pretender, but the enterprise was unsuccessful, and he did not return to Madrid till 1720. He failed of obtaining employment, as he refused to abjure Protestantism. Subsequently he accompanied the duke of Leiria, the Spanish ambassador, to Russia, where he became a general, especially distinguishing himself in the war against Turkey (1734-7), and was severely wounded at the storming of Otchakov. He afterward aided in the victories over the Swedes, and after

the peace of Abo (1743) became Russian ambassador at Stockholm, and on his return to St. Petersburg was made field marshal. The service was made so irksome to him that he tendered his resignation, which was accepted on condition of his never fighting against Russia. He went to Hamburg (1747) and tendered his services to Frederick the Great, who grasped eagerly at the offer. He became governor of Berlin in 1749, and accompanied the king in many memorable campaigns, distinguishing himself on various occasions, especially in the retreat from Olmütz, and at Hochkirch. His success was the more remarkable as he was ignorant of the German language.—See *Leben des Feldmarschalls Jakob Keith*, by Varnhagen von Ense (Berlin, 1844).

**KEITH, George Keith-Elphinstone**, viscount, a British admiral, born at Elphinstone, East Lothian, Scotland, Jan. 12, 1746, died at his seat of Tulliallan, Perthshire, March 10, 1822. He was the youngest son of the tenth Baron Elphinstone, and entered the navy at an early age. He received the commission of post captain in 1775, and, in command of the frigate *Persous*, participated in the British attack on Bunker Hill, and in the capture of Fort Mifflin on the Delaware, in November, 1777. In 1793 he served under Lord Hood at Toules, and in 1795, as rear admiral of the white, took possession of Cape Town, and subsequently conquered Ceylon, Cochin, Malacca, and the Moluccas. He completed his services in the East by capturing, in August, 1796, off Saldanha bay, a Dutch squadron, which had been despatched for the recovery of the Cape Colony. Upon his return to England in 1797 he was created an Irish peer as Baron Keith of Stonchaven Marischal. In 1799 he took command of the fleet in the Mediterranean, and in March, 1800, blockaded Genoa, then occupied by a French army under Masséna, until its surrender to the Austrians. He subsequently cooperated with Abercrombie in the military operations in Egypt. He continued in active service until after the battle of Waterloo, and for several years held command of the channel fleet as admiral of the white. It was owing to his disposition of his cruisers along the coast of France that Napoleon was induced to surrender himself a prisoner. In 1814 he was created Viscount Keith of the United Kingdom, having been a baron since 1801. Previous to his elevation to the peerage he was on several occasions a member of the house of commons. His second wife, born in 1762, was the eldest daughter and co-heir of Henry Thrale, the friend of Dr. Johnson, from whom she received her education. She died March 31, 1857. He left no sons, but his title descended to his elder daughter by his first wife, Baroness Keith, wife of Count Flahaut. (See FLAHAUT DE LA BILLARDIERE.)

**KELAT**, the capital city of Beloochistan, and of a province of its own name, situated on the declivity of a hill called Shah Mirdan, about

6,000 ft. above the sea, 195 m. S. by E. of Candahar; pop. about 12,000. It is surrounded by an earth wall 18 ft. high, flanked by bastions. In the vicinity is a district that produces large quantities of fruit. A number of Afghan merchants reside at Kelat, and carry on a considerable trade with Sindh, Bombay, and Candahar. The chief manufactures are muskets, swords, and spears. Kelat was captured by the British in 1839, and again in 1840, and was evacuated by them in 1841.

**KELLERMANN.** I. *François Christophe*, duke of Valmy, a French soldier, born in Strasburg, May 30, 1735, died in Paris, Sept. 12, 1820. Enlisting as a private in 1752, he served during the seven years' war and obtained the rank of captain. In 1771 he was among the French officers sent to Poland to assist the confederates of Bar, and fought bravely. In 1785 he had reached the rank of brigadier general. On the breaking out of the revolution he espoused the popular cause, and in 1791 was appointed to the command of the army in Alsace. He succeeded in keeping the Austrians from that province and Lorraine; and having joined Dumouriez, he shared in the victory of Valmy (Sept. 20, 1792), by which the Prussians were expelled from the French territory. In 1793 he commanded the army of the Alps, and defeated the Piedmontese, thus bringing about the surrender of Lyons. Becoming unacceptable to the commissioners of the convention, he was dismissed from his command, arrested, and imprisoned for 13 months. After the 9th Thermidor, being reinstated in command of the army of the Alps, which amounted to but 47,000 men, he successfully opposed the repeated attacks of 150,000 Piedmontese and Austrian troops. In the following year he received an appointment in the military bureau at Paris. Bonaparte, after the 18th Brumaire, made him a senator; and on the establishment of the empire he was made a marshal, received the title of duke of Valmy, and held important commands from 1804 to 1813. On the restoration he evinced his readiness to serve the Bourbons, and took a seat in the chamber of peers, where he favored liberal measures. II. *François Étienne*, son of the preceding, born in Metz in 1770, died June 2, 1835. He early received a commission in a cavalry regiment. In 1791 he was attached to the embassy of the chevalier de Ternant in the United States, where he spent two years. He returned to France to become aide-de-camp to his father, and lost his post after the siege of Lyons; but his well known patriotism saved him from imprisonment, and he reentered the army as a private. On the 9th Thermidor he resumed his former rank, served as adjutant general under Bonaparte in 1796, and afterward, under Masséna, distinguished himself at Bassano, Arcole, and elsewhere, was sent to Paris to present the standards taken from the enemy to the directorial government, and was appointed brigadier general. In 1800 he ac-

companied the first consul to Italy at the head of a brigade of cavalry, and participated in the battle of Marengo, where by a well timed charge he decided the victory; he was rewarded by promotion to the rank of general of division. In 1805 he fought brilliantly at Austerlitz, where he was severely wounded. He served in Portugal and Spain from 1807 to 1812, in Germany in 1813, and in France in 1814, and finally distinguished himself in the engagements that preceded the battle of Waterloo. On the return of the Bourbons he withdrew from the service. He succeeded his father as a peer, and like him inclined to liberal opinions. He wrote two pamphlets about the battle of Marengo, and left *Mémoires*, upon which his son constructed a history of the campaign of 1800.

**KELLOGG,** *Cara Louisa*, an American singer, born in Sumter, S. C., of New England parents, in 1842. At the age of seven she was able to read difficult music at sight. She was educated in this country, and at the age of 18 sang at a private morning performance of *Il Poltuto* in the New York academy of music. Her first public appearance was made at the same place, Feb. 27, 1861, in the rôle of Gilda in Verdi's *Rigoletto*; and on March 19 she made her début in Boston in *Linda di Chamounix*. Her merits were quickly recognized, and her career almost from the first was one of assured success. In 1865 she entered into an engagement for three years with the manager of the Italian opera in New York, and during this period added constantly to her fame. The most notable of her impersonations were in the operas of *Crispino, Fra Diavolo*, and *Faust*. She sang in the first performance of the last named opera in America. On Nov. 2, 1867, she appeared successfully at Her Majesty's opera, London, in *Faust*. Returning to America in 1868, she remained here for four years, appearing again at the Drury Lane opera in the spring of 1872. In the winter of 1873-'4 she organized a company and appeared in English opera in the principal cities of the United States. Her voice is a pure high soprano, pleasing in quality, remarkably firm and correct in intonation, and of considerable power. Though she has appeared in tragic as well as in comic opera, and though Marguerite in Gounod's *Faust* is one of the best of her rôles, it is in comic opera that her talents as a singer and as an actress find their best expression.

**KELUNG**, a town of the Chinese empire, in the N. part of the island of Formosa, situated near the head of the harbor, and important only for the trade carried on with other Chinese ports, chiefly in rice, camphor, and tea. Coal, which is found in the neighborhood, was exported in 1870-'71 to the extent of \$500,000, chiefly to Shanghai. Kelung and Tanshui, or Tamsui, are the N. ports of the Chinese portion of the island which have been opened to foreign trade. There is also an island of Kelung, important as a landmark to the harbor, consisting of a mass of black rock 600 ft. high.

**KEMBLE**, the name of a family of British actors. **I. Roger**, the founder of the family, born in Hereford, March 1, 1721, died in 1802. He was during a great portion of his life an actor and the manager of provincial companies. He had 12 children, of whom the eldest was the celebrated Mrs. Siddons. (See **SIDDONS, SARAH**.) **II. John Phillip**, eldest son of the preceding, born at Prescott, Lancashire, Feb. 1, 1757, died in Lausanne, Switzerland, Feb. 26, 1823. He was educated at a Roman Catholic seminary in Staffordshire and at the English college in Douai, France, and made his first appearance upon the stage, for which he showed a remarkable inclination, in the tragedy of "Theodosius," Jan. 8, 1776. In 1783 he first acted at Drury Lane, of which theatre he became manager in 1790. From this time until his retirement he stood at the head of his profession. In 1803 he became a part owner of Covent Garden theatre, which he managed prosperously until its destruction by fire in 1808. The opening of the new theatre in the succeeding year under his management was the signal for a series of tumults, known as the O. P. ("old price") riots, excited by the increased prices required for admission. For upward of 60 nights Kemble and the members of his family were obliged to endure every species of insult; but a compromise was finally effected, and the theatre was liberally and successfully managed until Kemble's retirement from the stage, June 23, 1817, an occasion commemorated by the poet Campbell in one of his most finished odes. The latter part of his life was passed in Lausanne, whither he had retired for the benefit of his health. In the personation of the dramatic heroes, Cato, Coriolanus, King John, Wolsey, Macbeth, and Lear, he had no rival among contemporaneous actors; and in characters of a reflective cast generally he is probably still unequalled on the English stage. As a manager he distinguished himself by many splendid revivals of Shakespeare's plays. In private life he was highly esteemed. **III. George Stephen**, brother of the preceding, born at Kington, Herefordshire, May 3, 1758, died near Durham, June 5, 1822. He was intended for the medical profession, but, following his inclination, went upon the stage, and made his debut in London in September, 1783. For many years subsequently he was the manager of a provincial company. He was a good actor, but in the latter part of his life became so corpulent as to be almost incapacitated for any other part than Falstaff, which he frequently acted. **IV. Elizabeth** (Mrs. Whitlock), sister of the preceding, born in Warrington, Lancashire, April 2, 1761, died Feb. 27, 1836. She first appeared at Drury Lane theatre in February, 1783, as Portia. In 1785 she was married to Charles Edward Whitlock, a provincial manager and actor, and seven years later accompanied her husband to the United States, where they performed for many years in the principal cities. Mrs. Whit-

lock became the most popular actress of the day in America, and in Philadelphia frequently performed before President Washington and other distinguished persons. She returned to England in 1807 with a competency, and retired from the stage. In personal appearance and voice she is said to have strongly resembled her sister Mrs. Siddons. **V. Charles**, the 11th child of Roger Kemble, born in Brecon, South Wales, Nov. 27, 1775, died in London, Nov. 12, 1854. He was educated at the English college in Douai, and upon returning to England in 1792 received a situation in the general post office. He soon abandoned this for the stage, and, after several trials in the provinces, made his first appearance at Drury Lane in April, 1794, playing for the occasion Malcolm to John Kemble's Macbeth and Mrs. Siddons's Lady Macbeth. For several years he took only secondary parts, and by comparatively slow degrees indicated that he possessed the dramatic genius of the family. In 1800 he first appeared as a writer for the stage in an adaptation of Mercier's *Déserteur*, entitled "The Point of Honor," and subsequently he furnished many similar pieces from the German and French for the London theatres. He began meanwhile to acquire considerable repute in his profession, and was accounted one of the best genteel comedians of his time, excelling in such parts as Benedick, Petruchio, Archer, Ranger, Charles Surface, &c.; and also in that numerous class of serious characters represented by Faulconbridge, Edgar, Cato, Mark Antony, &c., for all of which his handsome person eminently qualified him. In 1809 he made a successful tour in the United States with his daughter, Miss Fanny Kemble, and in 1840 closed his career as an actor. Shortly afterward he was appointed examiner of plays in England. **VI. Frances Anne** (Mrs. Butler), best known as Fanny Kemble, daughter of the preceding, born in London in 1811. Her mother, long known on the English stage as Mrs. Charles Kemble, was originally a danseuse at the opera house, London, as Miss De Camp. She manifested no special predilection for the stage, but was induced, in consequence of the embarrassed circumstances of her family, to make her debut at Covent Garden, then under the management of her father, in October, 1829. On this occasion she played Juliet, her father taking the part of Romeo and her mother that of the nurse, with complete success, notwithstanding that six weeks previous she had no thought of embarking in a dramatic career. For the three succeeding years she performed leading parts in tragedy and comedy with great applause, distinguishing herself particularly in Juliet, Portia, Bianca in "Fazio," Julia in "The Hunchback" (the latter being originally personated by her), Belvidera, Isabella, Lady Teazle, and Louise de Savoy, in her own play of "Francis the First," written when she was 17 years old, and received with great approbation. In 1833 she accompanied her

o the United States, and met with an stic reception in the chief cities. In e was married to Mr. Pierce Butler of phia, and at the same time retired de; from the stage. Incompatibility of nd temperament having rendered the unhappy one, a separation took place id of a few years, and Mrs. Butler sub- y fixed her residence in Lenox, Berk- , Mass. Previous to this she had pub- er first work in prose, "A Journal of ence in America" (2 vols., London, hiefly devoted to a description of her ough the United States. It was followed by a drama entitled "The Star of Se- hich was acted with success; and in : published a collection of her poems, a of which only had previously appeared. she visited Europe, extending her trav- r as Italy, where her sister, Mrs. Sartol- ed, and in 1847 published an account of nder the title of "A Year of Conso-

Shortly afterward steps were taken re a divorce from her husband, which ated by the legislature of Pennsylvania after which she resumed the name of

In the winter of 1848-'9 she com- in Boston a series of Shakespearian , which drew crowded audiences; and the next two years she repeated the in some of the principal American In 1851 she returned to England, reap- for a brief period on the stage, and ving readings in London and other : the United Kingdom, made another ntinental tour. In 1856 she returned nited States, and continued at intervals readings in Boston and elsewhere, till y, 1860. She then returned to Eng- d while residing there in 1863 she pub- Residence on a Georgian Plantation -9," in which she gives from personal ion her impressions of the system of

In 1866 she returned to her former e in Lenox, Mass., in 1868 gave pub- ngs in various places, and in 1869 went pe. She returned in 1873, and has ided near Philadelphia. VII. **Adelalde**, sister of the preceding, born in Lon- out 1820, made a brilliant debut at Garden as an opera singer; but upon arried in 1843 to Mr. Edward Sartoris, red from the stage. In 1867 she pub- "A Week in a French Country House." , Algernon Charles Sartoris, was mar- Washington in May, 1874, to the daugh- resident Grant.

**LE, John Mitchell**, an English historian, on of Charles Kemble, born in London died in Dublin, March 26, 1857. He eated by Dr. Richardson, author of the h Dictionary," and afterward at Bury und's grammar school, and Trinity col- mbridge. In 1820 he visited Germany, his time commenced his study of the axon and kindred Teutonic dialects.

He became acquainted with Thiersch, the bro- thers Grimm, and other leading philologists and antiquaries of Germany. In 1880 he vis- ited Spain in order to coöperate with the Span- ish liberals against the government of King Ferdinand. Returning to England, he began to explore everywhere, in the British museum and in cathedral and collegiate libraries, for manuscripts of the Anglo-Saxon period, which he deciphered with remarkable skill. His first public effort was his lectures at Cambridge on the Anglo-Saxon literature and language in 1884-'5. About this time he published "The Anglo-Saxon Poems of Beowulf, the Travel- ler's Song, and the Battle of Finnesburgh, with a Glossary and Historical Preface," to the sec- ond edition of which he added a translation of Beowulf with a glossary and notes. From 1885 to 1844 he edited the "British and For- eign Review," to which he contributed many valuable anonymous articles, as he did also to the *Archæologia*, the "Cambridge Philological Museum," the "Foreign Quarterly," and lat- terly to "Fraser's Magazine." The article on "Jäkel's Comparative Philology" in the "For- eign Quarterly" is the best known of his con- tributions to periodical literature. In 1839 he commenced the publication of his collection of Anglo-Saxon charters, the *Codex Diplomat- icus Ævi Saxonici*. For some years he su- perintended the publication of several of the archæological works of the Ælfric and Cam- den societies. In 1849 appeared his "Saxons in England," a work which caused Jakob Grimm to say that Kemble was the first of his disciples. From July, 1849, to May, 1855, he resided in the north of Germany, where he prosecuted his studies, and, as he wrote Ger- man with as much facility as his native lan- guage, contributed many essays to the "Trans- actions" of the archæological society of Han- over. In 1854 he was employed by the anti- quarian society of Hanover to excavate the sepulchral barrows of pagan times on the heath of Lüneburg, resulting in large acces- sions to the Hanoverian museum. In 1857 ap- peared his last work, "State Papers and Cor- respondence illustrative of the Social and Po- litical State of Europe from the Revolution (1688) to the Accession of the House of Han- over." At the time of his death he was en- gaged by the managers of the Manchester ex- hibition to form a department of Celtic and Anglo-Saxon art. His unexpected demise caused the abandonment of this design.

**KEMENY, Zsigmond**, baron, a Hungarian au- thor, born in Transylvania in 1816. He was a liberal member of the upper house of the Tran- sylvanian diet, and in 1848 a representative in the diet of Pesth. After editing several other journals, he became in 1855 the editor of the *Pesti Napló*, which since the restoration of the Hungarian constitution has been the leading organ of the Deák party. Among his princi- pal novels are *Gyulai Pál* ("Paul Gyulai," 5 vols., Pesth, 1846) and *Zord idő* ("Rough

Times," 4 vols., 1861-'2). He is also the author of several political pamphlets and biographical sketches.

**KEMPELEN, Wolfgang**, baron, a Hungarian mechanic, born in Presburg, Jan. 23, 1734, died in Vienna, March 26, 1804. He entered at first upon an administrative career, and became aulic councillor. He was an excellent chess player, and was frequently invited to play with Maria Theresa, who was a passionate lover of the game. Having a great mechanical genius, he in 1769 astonished Europe with his automaton chess player. Taken to Paris in 1784, and afterward exhibited by Mr. Mälzel in England and the United States, the chess player caused an extraordinary excitement, and the problem was not explained for many years. (See AUTOMATON.) Kempelen also invented an automatic speaking human figure, which pronounced very distinctly several words; a curiosity several times successfully imitated, and of which the maker published an explanation in *Le mécanisme de la parole, suivi de la description d'une machine parlante, et enrichi de 27 planches* (1791). He wrote several German poems, *Perseus und Andromeda*, a drama, and *Der unbekante Wohlthäter*, a comedy. He was also councillor of finance to the emperor of Austria, director of the salt mines of Hungary, and referendary of the Hungarian chancery at Vienna. Full details of the mystery of the automaton chess player, with its later history, are given in an article by Prof. G. Allen of Philadelphia in "The Book of the First American Chess Congress" (New York, 1859).

**KEMPER**, an E. county of Mississippi, bordering on Alabama, and drained by affluents of the Tombigbee and other streams; area, 750 sq. m.; pop. in 1870, 12,920, of whom 7,214 were colored. The soil is mostly fertile. The Mobile and Ohio railroad and its Gainesville branch pass through it. The chief productions in 1870 were 218,350 bushels of Indian corn, 36,995 of sweet potatoes, 64,010 lbs. of butter, and 4,964 bales of cotton. There were 1,140 horses, 902 mules and asses, 2,118 milch cows, 4,475 other cattle, 3,174 sheep, and 10,316 swine. Capital, De Kalb.

**KEMPER, Reuben**, an American soldier, born in Fauquier co., Va., died in Natchez, Miss., in 1826. He was the son of a Baptist preacher, who emigrated with his family to Ohio in 1800. Reuben subsequently removed with two of his brothers to the territory of Mississippi, where they engaged in land surveying. They were the leaders in the movement to rid West Florida of its Spanish rule, and got up an expedition to Baton Rouge in 1808 from the adjacent counties of Mississippi, which failed. The Spanish authorities caused the Kempers to be kidnapped, but they were rescued by the commander of the American fort at Pointe Coupée. The Kempers pursued with great ferocity all who were engaged in this wrong upon them, inflicting severe personal chastisement and mu-

tiliation upon the parties. After these occurrences Reuben Kemper devoted himself to the task of driving the Spaniards from the American continent. He was engaged in an attempt to capture Mobile, which failed; and on the fitting out of the formidable expedition of Galtierrez and Toledo, in 1812, against the Spanish authority in Mexico, he was assigned the rank of major, and afterward chosen colonel of the force, 500 or 600 in number, which co-operated with the Mexican insurgents. The expedition advanced into Texas, fought several battles, in which Kemper and his Americans performed feats of valor, and won brilliant victories. Dissensions followed between the Mexicans and Americans, and the Spaniards taking advantage of them put the republicans to rout. The Americans, disgusted with their allies, then returned home. Kemper was engaged under Jackson in the defence of New Orleans, was detached for important and perilous duty, and added greatly to his reputation by his activity and efficiency. At the conclusion of the war he settled in Mississippi.

**KEMPIS, Thomas à**, a German ascetic writer, born at Kempen, near Cologne, in 1379 or 1380, died at Mount St. Agnes, near Zwolle, July 26, 1471. His family name was Hammerken, "Little Hammer" (Lat. *Malleolus*, a surname bestowed on him by several writers). At the age of 13 he entered the school conducted at Deventer by the "Brothers of the Common Life," and in 1396 became an inmate of the house of Brother Florentius Radewin, superior general of the order. In 1400 he began his noviceship at the monastery of Mount St. Agnes, near Zwolle, of which his brother John was prior, and in 1413 was ordained priest. It is thought that he composed about this time the short treatise on the eucharist which now forms the fourth book of the "Imitation of Christ." In 1425 he was elected sub-prior of the monastery, and was charged with the spiritual direction of the novices. In 1429 he and his brethren were forced to migrate to Lunckerke, in Friesland; but they returned to Mount St. Agnes in 1432, when Thomas became treasurer of the monastery. In 1448 he was again elected sub-prior, and held this post till his death. Like all his brethren, Thomas devoted himself in a special manner to the study of the Scriptures and the transcription of Biblical manuscripts. Besides his most famous work, *De Imitatione Christi*, and several ascetic treatises, he wrote the chronicle of the monastery of Mount St. Agnes down to 1471. The continuator of this chronicle says of him: "Brother Thomas à Kempis endured great poverty, labors, and trials from the foundation of this monastery. He transcribed the whole of our Bible, with many other books for our own use and for strangers. He also wrote for the benefit of young people several little treatises, in a plain and simple style, but rich in practical wisdom. During several years he applied himself lovingly to the contemplation of Christ's

passion, and was a great comforter of persons distressed or tempted." He owes his world-wide fame to the book entitled *De Imitatione Christi*, which has been many times translated into every civilized language, including Greek and Hebrew; there are upward of 60 different versions in French alone, and 500 different editions of it issued within the present century are found in a library at Cologne. The most remarkable modern edition is one in seven languages, Latin, Italian, Spanish, French, German, English, and Greek (Sulzbach, 1837). Its authorship has been ascribed to Jean Gerson, chancellor of the university of Paris, and to Gersen or Gesen, an Italian abbot; and the question has been debated somewhat with reference to national honor and the interests of ecclesiastical orders. The external evidences in favor of A Kempis are the facts that he is mentioned as the author by three writers nearly his contemporaries, that copies exist written in his own hand, and that in one ancient copy he is stated to be the author. There is said also to be a striking likeness in style and refined piety between this and the devotional works of which he is certainly the author. The first volume of the *Prolegomena* of a new edition of *De Imitatio Christi*, after the autograph of Thomas à Kempis, by Hirsche (Berlin, 1878), was followed in 1874 by the Latin edition itself; and a second volume of the *Prolegomena*, with facsimiles of documents, is in course of publication. This edition is regarded as finally settling the question of the authorship of the work in favor of A Kempis. The only complete edition of the writings of Thomas à Kempis is by the Jesuit Sommalius (3d ed., Antwerp, 1615). There is a German translation of his complete works by Silbert (4 vols., Vienna, 1834). The best biography is that of Mooren, *Nachrichten über Thomas à Kempis* (Crefeld, 1855). See also Silbert, *Gersen, Gerson oder Kempis?* (Vienna, 1828). (See GERSON.)

**KEMPTEN**, a town of Bavaria, in the district of Swabia and Neuburg, on the Iller, 64 m. S. W. of Munich; pop. in 1871, 10,982. It consists of the Lutheran Altstadt, which is situated in a valley and was formerly a free imperial town, and the Catholic Neustadt, on a hill. It has a castle, a gymnasium, a Latin school, an agricultural and an industrial school, and manufactories of paper and cotton.

**KEN, Thomas**, an English bishop, born at Berkhamstead, Hertfordshire, in July, 1637, died at Longleat, Wiltshire, March 19, 1711. He was educated at Winchester and Oxford, took orders, visited Rome in 1674 in company with his nephew, Izaak Walton, jr., and after his return in 1679 was nominated chaplain to Mary princess of Orange, whom he accompanied to Holland. He was chaplain to Lord Dartmouth during the expedition against Tangier, and in 1684 became chaplain to Charles II., who subsequently made him bishop of Bath and Wells. Ken attended the king in his last illness. Having refused to read in his church

the declaration of indulgence issued by the government of James II., he was with the other six recusants committed to the tower. When, however, after the revolution, Ken was required to swear allegiance to the new sovereign, rather than do so he suffered himself to be deprived of his bishopric, and retired into obscurity and comparative poverty. He was the author of many devotional writings, the most popular of which are his morning and evening hymns. An edition of his works, in 4 vols. 8vo, was published in 1721.—See his "Life," by G. L. Dnyckinck (New York, 1859).

**KENAIANS**, the name generally given to the division of the great Athabaskan family living in Alaska. The name is derived from Kenai, the peninsula between Cook's inlet and Prince William sound, but has been extended from the tribe dwelling there to include all the Indians N. W. of Copper river and W. of the Rocky mountains, except the Aleuts and the Esquimaux. They have lost greatly in numbers by wars with the Esquimaux, but as late as 1869 were estimated at 25,000. They resemble the Tartars in the practice of the Shaman religion, scarification, burning the dead, infanticide, caste, &c. As in many other nations, each tribe is divided into clans or families, there being among the Kenaians three, Chitaa, Matasa, and Ateetsa; no man can marry in his own clan, and his children belong to the mother's clan. They wear leather tunics, or pointed shirts (from which the term Chipeweyan is said to be derived), with trousers and shoes attached. The tunic of the women is rather longer, rounded in front, and trimmed with hyaqua shells. The men paint their faces and wear hyaqua shells in the nose, while the women tattoo lines on the chin. They collect wealth and have a system of barter, using hyaqua shells or beads as money. The men are fewer in number than the women, but better looking. On arriving at puberty girls are separated from the rest for a year, and wear a peculiar bonnet with fringes over the face. They generally burn their dead, collecting the ashes in a leathern bag, which is suspended on a painted pole, planted in a clear elevated spot; but some of the tribes now bury the dead or place them on elevated stages. The Kenaians embrace: 1, the Nehaunces, on the Lewis, Tahco, and Pelly, ignorant, barbarous, cowardly, and treacherous; including the Chilkahtena, the Abbatitena, and the Dahotena, the Sicanees of the *royageurs* and the Mauvais Monde or Slavé at Francis lake; 2, the Tutchonekutchin, which means Crow Indians, called also Gens des Foux, Caribous, or Mountain Indians, on both sides of the Yukon; 3, the Ahtena, S. W. of them, on the Atna or Copper river; 4, the Kenai, called by the Russians Ugalentzi, who use birch canoes, bury their dead, and place wooden tombs over them; 5, the Hunkutchin, next to the Crows on the Yukon; 6, the Tukkuthkutchin, south of Porcupine river; 7, the Vuntakutchin, that is,



Rat Indians, north of the Porcupine, called also Loucheux, Lake Indians, and Quarrellers; 8, the Natchekutchin, that is, strong people, migratory hunters, called also Gens de Large and Loucheux; 9, the Kutchakutchin, near the Porcupine and Yukon, called also Lowland people; 10, the Tenanakutchin or Gens de Butte, on Tenana river; and on the lower Yukon the Unokhotana, Coyukhotana, and Karyukhotana, a large tribe called by the Russians Ingalik, probably an Esquimaux name. These three tribes cannot converse with the Kutchins, though their language is similar.

**KENDAL**, or **Kirkby-Kendal**, a market town and parliamentary borough of Westmoreland, England, 40 m. S. of Carlisle, situated in a pleasant valley on the E. bank of the Ken; pop. in 1871, 13,442. Queen Catharine Parr was born here. Kendal is an important manufacturing town, and one of the oldest in the kingdom, the woollen manufacture having been established there by Flemish weavers, on the invitation of Edward III., in the 14th century. Its green cloth seems to have been celebrated in the time of Shakespeare. On an eminence E. of the town is the ruined castle of the ancient barons of Kendal.

**KENDALL**. I. A S. W. county of Texas, intersected by the Guadalupe river; area, 1,400 sq. m.; pop. in 1870, 1,536, of whom 101 were colored. Two thirds of the surface is covered with timber, and the remainder is prairie. It is one of the best counties for sheep raising in the state. The chief productions in 1870 were 51,245 bushels of Indian corn, 8,781 lbs. of wool, 26,458 of butter, and 381 tons of hay. There were 1,345 horses, 2,337 milch cows, 10,074 other cattle, 4,293 sheep, and 1,734 swine. Capital, Boerne. II. A N. E. county of Illinois, drained by Fox river and the sources of the Au Sable; area, 324 sq. m.; pop. in 1870, 12,399. It has an undulating surface, diversified by woodland and prairie. The soil is uniformly fertile. The Chicago, Burlington, and Quincy railroad passes through it, and the Chicago, Rock Island, and Pacific touches the S. E. corner. The chief productions in 1870 were 91,930 bushels of wheat, 681,267 of Indian corn, 468,890 of oats, 79,365 of potatoes, 39,884 lbs. of wool, 386,050 of butter, and 23,740 tons of hay. There were 7,275 horses, 5,988 milch cows, 8,835 other cattle, 12,236 sheep, and 14,892 swine; 12 manufactories of agricultural implements, 9 of carriages, 1 of printing paper, 5 flour mills, and 1 tannery. Capital, Oswego.

**KENDALL, Amos**, an American politician, born in Dunstable, Mass., Aug. 16, 1789, died in Washington, D. C., Nov. 11, 1869. Until the age of 16 he worked on his father's farm, and in 1807, after a little more than a year's preparation, he entered Dartmouth college, where in 1811 he graduated the first in his class, although a large part of his time had been occupied with teaching for a support. Having studied law and been admitted to the bar, in the spring of 1814 he

emigrated to Lexington, Ky. Finding his professional labors not immediately remunerative, he again resorted to teaching, and for several months was a tutor in the family of Henry Clay. Subsequently he established himself in Georgetown, where he was appointed postmaster, and in the intervals of his practice edited a local newspaper. In 1816 he was attached to the staff of the state journal at Frankfort, called the "Argus of Western America," and showed himself an able political writer. He was one of the earliest friends of common schools in Kentucky, and succeeded in procuring the passing of an act to district the state and to set apart one half the profits of the bank of the Commonwealth to constitute a school fund. He was a firm supporter of the election of Gen. Jackson, who in 1829 appointed him fourth auditor of the treasury department. In 1835 he was made postmaster general, and in one year reorganized the financial system of the department, and freed it from the debt with which it had been embarrassed. In 1836 he procured from congress a reorganization of the department on a plan suggested by himself, which has undergone no essential alteration since. He was retained in office by Mr. Van Buren, but retired from the cabinet in June, 1840, in order to further the interests of the democratic party in the presidential election of that year. He never afterward entered public life, although a foreign mission was offered to him by President Polk, but devoted himself chiefly to his profession. For many years he was embarrassed by a suit instituted against him by certain mail contractors, which was ultimately decided in his favor in the supreme court. In 1845 he assumed the entire management of Prof. Morse's interest in the American electro-magnetic telegraph. In 1845-'6 he travelled through Europe and visited Egypt and Palestine. He is the author of "Life of Andrew Jackson, Private, Military, and Civil," begun in 1843, but never completed. He founded and was first president of the deaf and dumb asylum in Washington, and was a liberal benefactor to other religious and educational institutions. His "Autobiography," edited by William Stickney, was published in 1872.

**KENDALL, George Watkins**, an American journalist, born in Amherst, now Mount Vernon, N. H., about 1807, died at Oak Spring, near Bowie, Texas, Oct. 21, 1867. He travelled extensively through the southern and western states, working at his trade as a journeyman printer. In 1835 he went to New Orleans, and not long afterward established there, in partnership with Mr. F. A. Lumsden, the "Picayune," the first cheap daily newspaper issued in New Orleans, which under his direction became a leading southern journal. He joined the Santa Fé expedition which in 1841 set out from Austin, Texas, and of which he published an account, embracing his own captivity and sufferings in Mexico, entitled "Narrative of the Texan Santa Fé Expedition" (2 vols. 1850,

1844). During the Mexican war he accompanied the American forces under Taylor and Scott, and witnessed the chief conflicts during the contest. After its termination he passed two years in Europe, superintending the publication of a costly illustrated work, which appeared in 1851 in a folio volume under the title of "The War between the United States and Mexico, embracing 12 Colored Plates of the Principal Conflicts, by Carl Nebel." In 1852 he established a large grazing farm in Comal co., central Texas, where he resided until his death.

**KENDRICK, Asabel Clark**, an American author, born in Poultney, Vt., Dec. 7, 1809. He went when about 13 years of age to Hamilton, N. Y., and in 1831 graduated at Hamilton college, Clinton. He was immediately appointed tutor in the literary and theological institution at Hamilton (now Madison university), and the next year was made professor of Greek and Latin. Released after a few years from the Latin department, he remained the Greek professor till 1850, when, on the establishment of the university of Rochester, he was called to the Greek professorship in that institution, where he still remains. In 1852 he visited Europe, attending the lectures in the university at Athens, and visiting several Italian and German universities, returning home in 1854. Though in clerical orders, he has never had a pastoral charge. In addition to the studies of his own department, he has paid much attention to oriental learning. Besides numerous contributions to magazines and reviews, and several sermons, he has published a revised edition of Olshausen's

"Commentary on the New Testament" (6 vols., New York, 1853-'8), translating some portions for the first time; "Echoes," a small volume of translations from the French and German poets (Rochester, 1855); "Life and Letters of Emily C. Judson" (New York, 1860); "Our Poetical Favorites" (New York, 1870); and numerous Greek text books, the last of which is an edition of Xenophon's *Analysis*, with notes and vocabulary (New York, 1873). In 1867 he translated and annotated the *Epistle to the Hebrews* for Lange's "Commentary." In 1868 he made a second visit to Europe. During the years 1865-'8, in addition to his duties in the university, he filled the chair of Hebrew and New Testament interpretation in the Rochester theological seminary. He is now (1874) one of the board of

New Testament revisers working in connection with the British committee appointed by the convocation of Canterbury.

**KENEH, or Gheeh** (anc. *Canopolis*), a city of Upper Egypt, on the right bank of the Nile, 33 m. N. of the ruins of Thebes; pop. about 10,000. It is an emporium of trade with the Arabian coast, and manufactures famous water jars and bottles.

**KENILWORTH**, a parish and village of Warwickshire, England, about equidistant (5 m.) from Leamington, Warwick, and Coventry, containing the splendid ruins of Kenilworth castle. Of the original structure only a massive tower called Caesar's tower is now standing; but there are considerable remains of subsequent additions. Among these is part of the



Caesar's Tower, Kenilworth.

great hall erected by John of Gaunt, 86 ft. in length by 45 in width, with windows on both sides, and fireplaces at either end. The walls of Caesar's tower are in some places 16 ft. thick. Kenilworth was founded by Geoffrey de Clinton, treasurer to Henry I., and, having passed to the crown, was bestowed by Henry III. on Simon de Montfort, earl of Leicester. When De Montfort was defeated and killed, his adherents held it for six months against the king, and at length made favorable terms of capitulation. Edward II. was prisoner in it for some time. Edward III. bestowed it on John of Gaunt, who built large additions to it. When his son Henry Bolingbroke became king, it was again vested in the crown, until Queen Elizabeth bestowed it on her favorite, Dudley, earl of Leicester. Elizabeth visited it

three times, the last in 1575, being the occasion so graphically narrated by Sir Walter Scott in his novel of "Kenilworth." The castle was dismantled in the time of Cromwell. After the restoration it belonged to the family of Clarendon, and is now the property of the family of Eardley-Wilmot.

**KENNEBEC**, a S. county of Maine, traversed from N. to S. by Kennebec river, and touched on the west by the Androscoggin; area, 1,050 sq. m.; pop. in 1870, 58,021. It has an undulating surface, diversified by numerous small lakes, and a very fertile soil. The Maine Central railroad and the Augusta division pass through it. The chief productions in 1870 were 25,822 bushels of wheat, 111,246 of Indian corn, 170,371 of oats, 122,627 of barley, 733,026 of potatoes, 137,231 lbs. of wool, 1,176,423 of butter, 154,727 of cheese, and 113,153 tons of hay. There were 7,563 horses, 13,252 milch cows, 5,481 working oxen, 12,163 other cattle, 31,975 sheep, and 4,086 swine; 11 manufactories of agricultural implements, 33 of carriages, 2 of cars, 4 of cotton goods, 4 of edge tools and axes, 6 of iron castings, 14 of machinery, 7 of marble and stone work, 5 of oil cloth, 3 of printing paper, 13 of saddlery and harness, 11 of sash, doors, and blinds, 2 of steel springs, 3 of stone and earthen ware, 14 of tin, copper, and sheet-iron ware, 4 of woollen goods, 35 saw mills, 6 flour mills, 19 tanneries, and 10 currying establishments. Capital, Augusta, which is also the capital of the state.

**KENNEBEC**, a river of Maine, and next to the Penobscot the most important in the state. Its principal source is Moosehead lake in the N. W. part of the state, on the boundary line between Somerset and Piscataquis counties. It issues from the lake on its S. W. shore, and after a course of 20 m. receives Dead river from the right. Its direction is then changed from S. W. to S., and from this course it has but one considerable deviation, namely, in the S. part of Somerset co., where it flows 12 m. E. It enters the Atlantic in Sagadahoc co., through Sheepscott bay, an irregular indentation of the coast studded with many islands. The largest tributary of the Kennebec is the Androscoggin, which joins it 18 m. from the ocean at Merrymeeting bay. The outlets of a number of small ponds, and Sebasticook and Sandy rivers, also flow into it. The most important towns on its banks are Bath, Richmond, Gardiner, Hallowell, Augusta, Waterville, and Norridgewock. It has falls at Waterville and at three points above, which afford excellent motive power. Its whole length is about 150 m., in which it has a descent of 1,000 ft. Large ships can ascend it to Bath, 12 m., steamboats to Hallowell, 40 m., and small craft to Waterville, 54 m. The influence of the tide extends to Augusta, 42 m. from the sea. A dam with locks has been constructed at Augusta for the purpose of improving the navigation above that point, and increasing the

water power. The river is closed by ice at Hallowell from the middle of December to about the 1st of April; below Bath it is open at all seasons except during severe winters.

**KENNEDY**. I. **Benjamin Hall**, an English clergyman, born at Summer Hill, near Birmingham, Nov. 6, 1804. He graduated at St John's college, Cambridge, in 1827, was elected fellow and classical lecturer in 1828, became assistant master at Harrow in 1830, and was appointed head master of Shrewsbury school in 1836. In 1841 he became prebendary of Lichfield, and in 1860 was appointed select preacher to the university. He resigned his head mastership in 1866, and was appointed regius professor of Greek at Cambridge, and the next year canon of Ely. He has published "The Psalter in English Verse" (1860), "Elementary Greek Grammar" (1862), and "Public School Latin Grammar" (1871). II. **Charles Rann**, an English barrister, brother of the preceding, born in Birmingham, March 1, 1808, died in 1867. He graduated at Trinity college, Cambridge, and was elected fellow, entered Lincoln's Inn, was called to the bar in 1835, and settled at Birmingham. Besides several law books, he published "Poems, Original and Selected" (1843); in conjunction with his father, the Rev. Rann Kennedy, the "Works of Virgil" in blank verse (2 vols., 1850); "Specimens of Greek and Latin Verse" (1853); "Orations of Demosthenes," translated into English, with notes, appendices, &c. (5 vols., 1841-'63); and "Hannibal," a poem, part i. (1866).

**KENNEDY, Grace**, a Scottish authoress, born in Ayrshire in 1782, died Feb. 28, 1825. She passed the greater part of her life in Edinburgh, and subsequent to 1811 was an industrious writer of works of fiction of a moral and religious character, which were greatly esteemed at home and abroad. Among the most successful were "Decision," "Father Clement," "Anna Ross," "Dunallan," "Jessie Allan," &c., nearly all of which have been translated into the French and other languages. Her works were all published under an assumed name.

**KENNEDY, John Pendleton**, an American author, born in Baltimore, Oct. 25, 1795, died in Newport, R. I., Aug. 18, 1870. He graduated at Baltimore college in 1812, and in 1816 was admitted to the practice of the law, which he followed successfully for 20 years. In 1816-'20, in connection with his friend Peter Hoffman Cruise, he published the "Red Book," a serial in prose and verse issued about once a fortnight. He was a member of the Maryland house of delegates in 1820-'23. He warmly espoused the cause of President J. Q. Adams, and strongly advocated the protective policy. In 1832 he published "Swallow Barn, or a Sojourn in the Old Dominion," descriptive of plantation life in Virginia; and in 1835 "Horse-shoe Robinson, a Tale of the Tory Ascendancy," the most successful of his writings. In 1838 he published "Rob of the Bowl, a Legend of

St. Inigoe's," relating to the Maryland province in the days of Cecilius Calvert. All three works, revised and illustrated, were republished in New York in 1852. Mr. Kennedy was elected to congress in 1838, and one of the whig presidential electors in 1840. He was re-elected to congress in 1841 and 1843, was defeated by a small vote in 1845, and in 1846 was returned to the Maryland house of delegates, and chosen speaker. In 1849 appeared his "Life of William Wirt, Attorney General of the United States." In 1852 President Fillmore appointed him secretary of the navy, in which position he warmly favored Perry's Japan expedition and Kane's second arctic voyage in search of Sir John Franklin. He retired in March, 1853. Of his occasional writings and addresses, the best known are "Quodlibet" and "Defence of the Whigs." During the civil war he wrote "Mr. Ambrose's Letters on the Rebellion" (New York, 1865). At his death he was provost of the university of Maryland, vice president of the Maryland historical society, chairman of the trustees of the Peabody academy, and a member of various literary and scientific institutions. His "Life," by H. T. Tuckerman, was published in 1871.

**KENNET, White**, an English bishop, born in Dover in 1660, died in Peterborough in 1728. He was educated at Oxford, and was made bishop of Peterborough in 1718. He left a number of works, among which are: "Ecclesiastical Synods and Convocations historically stated and vindicated against Dr. Atterbury" (London, 1701); "The Case of Improvements, and of the Augmentation of Vicarages and other insufficient Cures, stated by History and Law" (1704); "History of England, from the Accession of Charles I. to that of Queen Anne," published in the collection of English histories compiled by John Hughes (1706); "*Bibliotheca Americana Primordia*, an attempt toward laying the Foundation of an American Library" (1713); and "A Register and Chronicle, Ecclesiastical and Civil" (1728). His "Life" was published in 1730. He left a valuable collection of manuscripts, purchased by Lord Shelburne, and now part of the "Lansdowne manuscripts" in the British museum.

**KENNICOTT, Benjamin**, an English clergyman, born in Totness, Devonshire, April 4, 1718, died in Oxford, Sept. 18, 1783. He was of humble parentage, and certain gentlemen contributed funds to send him to Oxford in 1744. Here he so distinguished himself by the publication of two dissertations on the "Tree of Life" and the "Oblations of Cain and Abel," that he obtained his degree of B. A. before the regular time. Soon afterward he was chosen fellow of Exeter college, and in 1767 he became keeper of the Radcliffe library at Oxford. He undertook to purify the Hebrew text of the Old Testament, maintaining, in an essay entitled "The State of the Hebrew Text of the Old Testament considered," that the extant MSS. contained important errors, and that the

text of the standard Hebrew Bible was in many parts corrupt. The publication of this dissertation excited a violent controversy. Among his opponents were Rutherford, professor of divinity at Cambridge, Bishop Warburton, and Horne, afterward bishop of Norwich. At Kennicott's suggestion a subscription of £10,000 was raised to defray the cost of making a collation of all extant MSS. of the Old Testament. Several eminent scholars engaged in the work, Kennicott himself examining and collating all the MSS. of Great Britain and France, and Prof. Brunns those of Germany, Switzerland, and Italy. The task occupied nine years, during which 16 Samaritan and over 600 Hebrew MSS. were either wholly or in part collated; and the materials resulting from this investigation filled when transcribed 30 folio volumes. As the result of this labor, Kennicott published his *Vetus Testamentum Hebraicum cum Variis Lectionibus* (2 vols. fol., Oxford, 1776-'80), founded chiefly on the text of Van der Hooght.

**KENOSHA**, a S. E. county of Wisconsin, bounded E. by Lake Michigan and S. by Illinois, and drained by Des Plaines and Fox rivers; area, 806 sq. m.; pop. in 1870, 18,147. It has a level and thinly timbered surface, with a fertile soil resting on beds of limestone. The Kenosha and Milwaukee divisions of the Chicago and Northwestern railroad pass through it. The chief productions in 1870 were 214,567 bushels of wheat, 269,086 of Indian corn, 359,348 of oats, 45,478 of barley, 134,463 of potatoes, 18,377 of flax seed, 895,670 lbs. of flax, 242,611 of wool, 480,599 of butter, 808,600 of cheese, and 44,404 tons of hay. There were 4,707 horses, 7,169 milch cows, 7,150 other cattle, 49,277 sheep, and 6,290 swine; 8 manufactories of carriages, 4 of cheese, 2 of iron castings, 1 of machinery, 2 of malt, 3 of saddlery and harness, 2 breweries, 3 tanneries, 3 currying establishments, and 2 flour mills. Capital, Kenosha.

**KENOSHA**, a city and the county seat of Kenosha co., Wisconsin, on Lake Michigan and on the Kenosha and Milwaukee divisions of the Chicago and Northwestern railroad, 80 m. S. of Milwaukee; pop. in 1870, 4,309. It is built on a bluff, and has a good harbor with piers extending into the lake. It has an extensive trade in the products of the surrounding country, which is fertile and well cultivated. The manufactures are important. The principal establishments are two founderies, three tanneries, two breweries, three malt houses, marble works, a flax mill, a planing mill, a machine shop, three manufactories of hardware, one of telegraph insulators, one of cheese boxes, two of ploughs, eight of boots and shoes, one of fanning mills, three of cabinet ware, three of sash and doors, and one of pumps. There are a national bank, three public schools including a high school, a female seminary, two weekly newspapers, and 10 churches. Kenosha was settled in 1836.

**KENRICK. I. Francis Patrick**, an American Roman Catholic prelate, born in Dublin, Dec. 3, 1797, died in Baltimore, July 8, 1863. He received a classical education in the schools of his native city, and at the age of 18 was sent to Rome to study. He spent two years in the house of the Lazarists and four at the college of the Propaganda, where he was ordained priest. In 1821 he came to the United States, having been chosen on the recommendation of the Propaganda to conduct an ecclesiastical seminary just established at Bardstown, Ky. In the duties of this office he passed nine years, visiting also from time to time the scattered missions of the diocese. He published in 1828 "Letters of Omicron to Omega," in reply to the Rev. Dr. Blackburn, who had attacked, under the signature of Omega, the Roman Catholic doctrine of the eucharist. On June 6, 1830, he was consecrated at Bardstown bishop of Arath *in partibus infidelium*, and coadjutor to the Rt. Rev. Dr. Conwell, bishop of Philadelphia, with powers of administrator. On Dr. Conwell's death in 1842 Bishop Kenrick became his successor. During the anti-Catholic riots in 1844, he caused an address to be posted up throughout the city calling upon the Catholics to preserve peace and charity, and made every exertion to calm the agitation of both parties. He founded the theological seminary of St. Charles Borromeo in Philadelphia, and in 1849 introduced into his diocese the sisters of the Good Shepherd, who devote themselves to the care of Magdalen asylums. In 1851 Bishop Kenrick was appointed archbishop of Baltimore, in place of Archbishop Eccleston, deceased. The pope named him "apostolic delegate" to preside over the first plenary council of the United States, convened at Baltimore in May, 1852, and in 1859 conferred upon him and his successors the "primacy of honor," which gives them precedence over all other Roman Catholic prelates in this country. At the beginning of the civil war Archbishop Kenrick labored earnestly to inculcate peace and submission to the laws and the constituted authorities. Until his death he read publicly in his cathedral the prayer for the president of the United States. His theological works are regarded as classical in America, and used as text books in several seminaries. In Europe they are also held in great esteem, and referred to as standard authorities in all religious questions that are purely American. At the time of his death he was engaged on a revised English translation of the Bible, with copious notes, and had published the whole of the New Testament and the greater part of the Old. His principal works are: *Theologia Dogmatica* (4 vols. 8vo, Philadelphia, 1839-'40; 2d ed., 3 vols. 8vo, Mechlin, 1858, with valuable additions); *Theologia Moralis* (3 vols., Philadelphia, 1841-'3; 2d ed., Mechlin, 1859); "The Primacy of the Apostolic See Vindicated" (4th ed., Baltimore, 1865); "The Catholic Doctrine on Justifica-

tion explained and vindicated" (Philadelphia, 1841); "Treatise on Baptism" (New York, 1843); "Vindication of the Catholic Church" (Baltimore, 1855); "The New Testament" (2 vols., New York, 1849-'51); "The Psalms, Book of Wisdom, and Canticle of Canticles" (Baltimore, 1857); "Job and the Prophets" (Baltimore, 1859); and "The Pentateuch" (Baltimore, 1860). He also wrote the article on the "Roman Catholic Church" in the "New American Cyclopaedia." **II. Peter Richard**, archbishop of St. Louis, brother of the preceding, born in Dublin in 1806. He was educated at Maynooth, and, having been ordained priest in Ireland, he came to Philadelphia, where his brother was already coadjutor. Mr. Kenrick was there employed in pastoral and literary labor; the "Catholic Herald," at the period of its highest reputation, was under his charge, and he wrote a number of translations and original works. He was also promoted to the rank of vicar general, and was consecrated bishop of Drasa *in partibus infidelium*, and coadjutor of St. Louis with right of succession, Nov. 30, 1841. By the death of Bishop Rosati two years after (1843), Dr. Kenrick became bishop of St. Louis; and in 1847 he became the first archbishop of that city. At the commencement of his administration Bishop Kenrick found the finances of his diocese in a deplorable condition; but by skilful measures he gradually extricated the diocese from this situation, and finally rendered it one of the most flourishing in the United States in a financial point of view. The archbishop also received in 1858 a large bequest, which has enabled him to accomplish many beneficial enterprises. The hospital under the care of the sisters of charity, by his munificence, has been made free, and dispenses its benefits alike to all, without distinction of faith, creed, or color. The orphanage of St. Philomena, the convents of the Visitation and the Good Shepherd, and numerous other institutions either of charity or education, attest the prosperity of the church under his government. He has adorned the environs of St. Louis with a cemetery which in beauty and extent of the grounds is one of the finest in the world. Archbishop Kenrick was present at the Vatican council, and was one of the foremost of the American prelates in maintaining the inopportune nature of defining the doctrine of papal infallibility. The speech which he had prepared was published in Naples in 1870, and in New York in 1872. He however acquiesced in the definition, and promulgated it, together with the other decrees of the council, in his diocese. Besides a number of translations, and editions of devotional works, he has published "The Holy House of Loreto, or an Examination of the Historical Evidence of its Miraculous Translation" (12mo), and "Anglican Ordinations" (8vo). The latter work elicited several rejoinders; by Roman Catholics it is generally regarded as conclusive in the controversy.

**KENSETT, John Frederick**, an American artist, born in *Cheshire, Conn.*, March 22, 1818, died in *New York*, Dec. 16, 1872. He studied engraving under his uncle *Alfred Daggett* of *New York*, and for several years executed vignettes for bank notes, occasionally attempting painting as a recreation. In 1840 he visited *England*, and in the spring of 1845 exhibited in the royal academy, *London*, his first picture, a distant view of *Windsor castle*, the purchase of which by a prize holder of the *London art union* encouraged him to persevere in his new profession. He subsequently passed two winters in *Rome*, sending home occasionally pictures of *Italian scenery*, several of which became the property of the *American art union*. His "View on the *Anio*" and "Shrine," exhibited at the academy of design in *New York* in 1848, first brought him prominently before the public, and established his reputation. After an absence of about seven years he returned to *America*, and settled in *New York*. He produced many representations of *American scenery* under various aspects, those in which rocks, trees, or water are prominent features being among his most characteristic and successful works. The mountainous regions of *New England* and *New York*, the rivers and lakes of the middle states, and the seashore furnished him with frequent subjects. Among his most popular works are his "View of *Mt. Washington* from *North Conway*" (1849), "*Franconia Mountains*" (1853), "*October Day* in the *White Mountains*" (1855), "*Hudson River* from *Fort Putnam*" (1856), "*Falls of the Bashpish*," "*Sunset on the Coast*" (1858), "*Eagle Cliff, Manchester, Mass.*" (1859), "*Sunset in the Adirondacks*" (1860), and subsequently numerous views on the *Genesee* and *Hudson* rivers and *Lake George*, and several taken in the vicinity of *Newport, R. I.* In 1859 he was appointed a member of the national art commission having the direction of the ornamentation of the capitol at *Washington*, and the superintendence of the works of art deposited there. In 1848 he was elected an associate and in 1849 a member of the national academy of design.

**KENT.** I. A central county of *Rhode Island*, bounded E. by *Narragansett bay*, and W. by *Connecticut*; area, 186 sq. m.; pop. in 1870, 18,595. It has a diversified surface and a good soil, and is drained by *Flat, Pawtuxet, Moosup*, and *Wood* rivers. The *Hartford, Providence*, and *Fishkill*, and the *Stonington* and *Providence* railroads pass through it. The chief productions in 1870 were 5,152 bushels of rye, 31,707 of *Indian corn*, 4,955 of oats, 94,035 of potatoes, 103,227 lbs. of butter, and 10,234 tons of hay. There were on farms 1,081 horses, 2,380 milch cows, 1,882 other cattle, 1,509 sheep, and 2,001 swine; 9 manufacturing of clothing, 23 of cotton goods, 9 of drugs and chemicals, 2 of iron castings, 4 of cotton and woollen machinery, 5 of tin, copper, and sheet-iron ware, 4 of woollen goods,

4 print works, 2 bleaching and dyeing establishments, 17 saw mills, and 5 flour mills. Capital, *East Greenwich*. II. A central county of *Delaware*, bounded E. by *Delaware bay*, and W. by *Maryland*; area, 640 sq. m.; pop. in 1870, 29,804, of whom 7,164 were colored. It has an undulating surface and a fertile soil, and is drained by *Choptank* and *Marshy Hope* rivers. It is traversed by the *Delaware*, the *Delaware* and *Maryland*, the *Smyrna* branch, and the *Junction* and *Breakwater* railroads. The chief productions in 1870 were 321,954 bushels of wheat, 885,178 of *Indian corn*, 145,238 of oats, 81,788 of *Irish* and 25,418 of sweet potatoes, 15,195 lbs. of wool, 221,212 of butter, and 7,239 tons of hay. There were 5,232 horses, 1,436 mules and asses, 6,223 milch cows, 1,274 working oxen, 5,285 other cattle, 5,316 sheep, and 11,421 swine; 6 manufacturing of agricultural implements, 4 of baskets, 6 of bricks, 21 of carriages, 8 of canned and preserved fruits, 6 of iron castings, 1 of sash, doors, and blinds, 5 of tin, copper, and sheet-iron ware, 3 tanneries, 2 currying establishments, 18 saw mills, and 6 flour mills. Capital, *Dover*, which is also the capital of the state. III. A N. E. county of *Maryland*, bounded E. by *Delaware* and W. by *Chesapeake bay*, and drained by *Sassafras* and *Chester* rivers; area, 240 sq. m.; pop. in 1870, 17,102, of whom 7,732 were colored. The surface is slightly diversified, and the soil moderately fertile. The *Kent County* railroad passes through it. The chief productions in 1870 were 473,601 bushels of wheat, 723,824 of *Indian corn*, 143,653 of oats, 44,008 of potatoes, 26,550 lbs. of wool, 155,974 of butter, and 4,380 tons of hay. There were 4,533 horses, 3,518 milch cows, 5,218 other cattle, 6,154 sheep, and 12,866 swine; 2 manufacturing of packing boxes, 5 of carriages, 3 flour mills, and 1 saw mill. Capital, *Chestertown*. IV. A W. county of the S. peninsula of *Michigan*, drained by *Grand, Rouge*, and *Thornapple* rivers; area, 900 sq. m.; pop. in 1870, 50,403. The surface is moderately uneven, and the soil, which is very fertile, consists of deep vegetable loam on a substratum of clay. It is well timbered, and contains limestone, gypsum, and salt. It is traversed by six railroads. The chief productions in 1870 were 704,089 bushels of wheat, 405,281 of *Indian corn*, 343,556 of oats, 480,999 of potatoes, 251,721 lbs. of wool, 25,944 of hops, 86,336 of maple sugar, 862,309 of butter, and 47,983 tons of hay. There were 8,386 horses, 9,095 milch cows, 2,009 working oxen, 8,586 other cattle, 63,360 sheep, and 13,199 swine. There were 45 saw mills, 18 flour mills, 7 iron founderies, and many other manufacturing establishments, chiefly in *Grand Rapids*, the capital.

**KENT.** L. A S. W. county of *Ontario, Canada*, bounded S. E. and S. by *Lake Erie*, W. by *Lake St. Clair*, and N. W. by *Big Bear creek*; area, 951 sq. m.; pop. in 1871, 40,634, of whom 12,581 were of *English*, 8,893 of

Irish, 7,452 of Scotch, 8,693 of French, 3,969 of African, and 2,788 of German descent. It is traversed by the Great Western and Canada Southern railways, and intersected by the river Thames. The surface is generally level, and the soil, especially in the river bottoms, is fertile. Wheat, maize, oats, and tobacco are the principal productions. Capital, Chatham. II. An E. county of New Brunswick, Canada, bordering on the gulf of St. Lawrence and Northumberland strait; area, 1,720 sq. m.; pop. in 1871, 19,101, of whom 10,701 were of French, 3,041 of Scotch, 2,564 of Irish, and 2,486 of English descent. The Richibucto and Cocagne or Cocayne are the principal rivers. The coasts are broken by several good harbors, which afford excellent opportunities for ship building. Nearly half the county is unsettled, and the most valuable production is timber, which is exported in large quantities to England. Capital, Richibucto.

**KENT**, a maritime county of England, forming the S. E. extremity of Great Britain, bordering on Essex (from which it is separated by the Thames and its estuary), Middlesex, Surrey, Sussex, the North sea, and the strait of Dover; area, 1,624 sq. m.; pop. in 1871, 847,507. The northern border is skirted by broad marshes; and the N. E. coast is made very irregular in outline by the estuaries of the Thames and Medway. A large peninsula projects between the two, its northern portion forming the district called the Isle of Grain. A branch of the Medway, called the Swale, cuts off from the mainland a large tract known as the Isle of Sheppey. The E. end of the county, separated from the rest by the narrow river Stour, forms the Isle of Thanet, terminating in the North Foreland, and having an area of about 40 sq. m. The surface of the county is hilly, the range terminating at many points on the E. and S. E. coast in high chalk cliffs. Elsewhere (especially in Pegwell bay and at Romney marsh, near the S. end of the county) the shore is low. Both the N. E. and S. E. coasts are rendered dangerous by outlying sand banks, the best known and most dreaded being the celebrated Goodwin Sands, lying off the shore between the Isle of Thanet and the South Foreland, a cape projecting into the strait of Dover. The county has several important ports, the chief of which are Dover, Folkestone, and Gravesend. The Downs, between the Goodwin Sands and the mainland, furnishes the most frequented roadstead of the English coast. Several of the minor coast towns are well known watering places, among them Margate and Ramsgate. The Medway is the principal river having its entire course in the county; of the smaller streams, the Swale and Stour are important from their positions. Kent is mainly an agricultural county, its alluvial soil and pleasant climate insuring a large production. Hops are raised to a great extent. Estates are small, and are mostly inherited equally by all the sons of intestates,

under the Saxon law of gavelkind, now nearly peculiar to this county. The chief towns, besides the ports already named, are Canterbury, Rochester, Greenwich, Maidstone, and Chatham.—The authentic history of Kent extends further back than that of almost any other part of England. The Romans made their first landing on the coast of this county, and the region, called by them by the Latinized form (Cantium) of its name, was regarded with special favor and included their earliest settlements. Later, the legendary Saxon chiefs Hengist and Horsa are said to have landed in Pegwell bay; and the earliest battles of the Saxon invasion were undoubtedly fought in Kent, which afterward constituted one of the kingdoms of the heptarchy. It was again the scene of important battles at the Norman invasion, against which the Kentish men made a desperate and long continued resistance. The insurrections of Wat Tyler and Jack Cade broke out in Kent; it was the scene of important events during the wars of the roses; and a third rebellion, that of Sir Thomas Wyatt, arose here under Queen Mary. The county is very rich in Roman and Saxon antiquities, historic buildings, and ruins; and its ecclesiastical edifices, including Canterbury cathedral, Aylesford priory, and others, are of great celebrity and beauty.

**KENT**, Edward Augustus, duke of, fourth son of George III. of England, and father of Queen Victoria, born Nov. 2, 1767, died Jan. 23, 1820. He joined the army, and was under the command of Sir Charles Grey in the attack on the French West India islands, where he was noticed for his bravery; and in compliment to him the name of Fort Royal in Martinique was changed to Fort Edward. Soon afterward he was made governor of Nova Scotia, created duke of Kent and Strathearne, with a seat in the house of lords, and appointed commander-in-chief of the British forces in North America. The island of St. John changed its name in his honor to Prince Edward island, which it still retains. In May, 1818, he married the widow of the prince of Leiningen, youngest daughter of the duke of Saxe-Coburg. Alexandra Victoria, now queen, was the only child of this union.

**KENT**, James, an American jurist, born in Philippi, Putnam co., N. Y., July 31, 1764, died in New York, Dec. 12, 1847. His grandfather, the Rev. Elisha Kent, whose family was early established at Suffolk, Conn., became in 1740 the Presbyterian clergyman of Philippi. His father, Moss Kent, Esq., was a lawyer, and for some years surrogate of Rensselaer co. James Kent graduated at Yale college in 1781, studied law, was admitted in 1785 as an attorney, and in 1787 as a counsellor, and commenced the practice of his profession in Poughkeepsie. He soon became remarkable among his contemporaries for his legal learning and literary attainments. He was elected successively in 1790 and 1792 a member of the leg-

lature for Dutchess co. The country was then excited by political discussions, arising from the adoption of the federal constitution, and Mr. Kent became an active and leading federalist, attracting the notice and confidence of Hamilton and Jay. It was by Hamilton's counsel that the reading of the young lawyer was directed to the doctrines of the civil law, and the treatises of the jurists of continental Europe; and thus he acquired the deep knowledge of the works of Pothier, Emerigon, and other civilians, which is to be traced throughout his own writings. In 1793 he was an unsuccessful candidate for a seat in congress for Dutchess co., and in the same year removed to New York, and was appointed by Gov. Jay one of the two masters in chancery for that city. In 1796 he was elected a member of the legislature, and also professor of law in Columbia college. Three of his lectures in the latter capacity, forming together an introduction to his general course, were published, in 1797, and attracted the favorable notice of the legal profession. In 1797 he was appointed recorder of the city, an officer then administering a court of civil jurisdiction; and the extraordinary ability he exhibited in the office induced Gov. Jay in 1798 to nominate him a judge of the supreme court of the state. He continued a member of this tribunal till 1814, having been from 1804 chief justice. The supreme court at that time was formed after the model of the English king's bench, being composed of five judges, who rode the circuits to try jury cases, and convened during the year at four appointed terms to decide reserved questions of law. Both the court and the law itself were in a rudimental state. There were no American law books, and no reports of American decisions, except those of Mr. Dallas, which were just commenced. The proceedings of the court were languid and dilatory; and resort was had for rules of procedure and principles of law almost exclusively to English precedents and decisions. The accession to the bench of a young, energetic, and able judge produced a striking change. It was the difficult task of the court to expound the principles of the common law as applicable to American institutions; to define and limit our new constitutional provisions; to construe recent statutes; to bring the principles of commercial law to bear upon transactions of trade and commerce; to devise rules of practice; and in short to adapt to a young and rising nation a complicated yet practical code of laws. That this work was well accomplished, and that a large portion of its success must be attributed to the unremitting energy and talent of the chief justice, will appear from the reports of Mr. Parsons, and the 14 volumes, entitled "Johnson's Cases" and "Johnson's Reports," of the decisions of the supreme court during the time of Mr. Justice Kent. By the constitution of New York as it then existed an important political duty was imposed on the ju-

diary of the state. The judges of the supreme court and the chancellor formed with the governor a council of revision, possessing a qualified veto on the acts of the legislature. This council was abolished by the constitutional convention of 1822, the judges themselves acquiescing in the change. They felt that, though the council was often a salutary check upon hasty and unwise legislation, the effect upon the judiciary was unfavorable, as exposing it to the influence and excitements of political parties. The subsequent publication of the proceedings of the council of revision displays Mr. Kent as prominent and efficient in the discharge of his political, as he had been in performing his judicial duties. In 1814 Chief Justice Kent was appointed chancellor. Up to that time the court of chancery had been of secondary importance in the jurisprudence of the state. This was partly owing to the nature of its business. Complicated trusts and intricate settlements of property, which form the peculiar subjects of chancery jurisdiction, belong to an advanced period of national growth. But the proceedings of the court had been dilatory; its mode of practice was circuitous and expensive, and the court was regarded with disfavor both by the profession and the community. The change effected by Chancellor Kent was aptly described in an address presented to the chancellor by the members of the bar, on his retirement from the office after nine years' administration of its duties. They compared him to Lord Nottingham, the English chancellor, who was described by Blackstone as the founder of the equity system of England, and who was "enabled in the course of nine years to build a system of jurisprudence and jurisdiction upon wise and national foundations." The seven volumes of Johnson's "Chancery Reports" contain the decisions of Chancellor Kent, and present a profound and extended exposition of the whole system of equity law. In 1822 he was elected a member of the convention called to revise the constitution of the state. He took an active part in the discussions of this body, and displayed a power of debate remarkable for one so long retired from forensic discussions. His opinions were strongly conservative. He opposed without success the extension of the right of suffrage, and other democratic innovations; but his personal influence and character preserved for the time the court of chancery, which he believed to be a useful means of administering justice. In 1823 his official term ended; and, having attained the age of 60, he found himself, by the then existing constitution of the state, prevented from holding judicial office. Still in vigorous health, he soon formed for himself new occupations. Returning to the city of New York, whence he had removed on becoming a judge, he was reelected professor of law in Columbia college, and for several years he delivered courses of lectures on law to numerous classes, which were embodied in his "Com-



mentaries on American Law" (4 vols. 8vo, 1826-'30). This work has since passed through many editions, and has acquired a world-wide celebrity. It has assumed in the United States the position long filled in England by Blackstone's "Commentaries on the Laws of England." It embraces not merely the jurisprudence of the federal Union, but the municipal law, written and unwritten, of the several states. Vast and comprehensive in plan, elaborate and minute in research, the beauties of its style and its historical learning commend it to the general reader, while it has been proved to be the best guide to the law student, and a valuable aid to the practical lawyer. The last years of Chancellor Kent's life were passed in tranquil pursuits, in enlarging and correcting his "Commentaries," in giving opinions on legal subjects, in advising and deciding on controversies submitted to him, and performing all the duties of an active and patriotic citizen. In 1836 he wrote and published, at the request of the common council of the city, a compendious treatise on the charter of New York and the powers of the municipal officers.—His son WILLIAM, born in 1802, was prominent as a lawyer and judge in New York, and in 1846-'7 was professor of law in Harvard university. He died at Fishkill, N. Y., Jan. 4, 1861.

**KENT, William**, an English artist, born in Yorkshire about 1685, died April 12, 1748. He was apprenticed to a coach painter, but found patrons who enabled him to study in Rome, where in 1716 he met the earl of Burlington, with whom he returned to England, and whose guest he remained during the rest of his life. He was much employed as an artist, but neither as a painter nor sculptor rose above mediocrity. He became, however, the founder of modern landscape gardening in England, by laying out Kensington gardens in accordance with principles of perspective and light and shade, thus putting an end to the bad taste which had up to that time disfigured English pleasure grounds. As an architect he is said to have designed the admirable structures, Holkham house and the temple of Venus at Stowe.

**KENTON**, a N. county of Kentucky, separated from Ohio by the Ohio river, and bounded E. by Licking river; area, 140 sq. m.; pop. in 1870, 36,096, of whom 1,657 were colored. The surface is very uneven, but the soil is fertile. Much of it is laid out in market gardens, whose products are sold in Cincinnati. The Kentucky Central and the Louisville and Cincinnati railroads pass through it. The chief productions in 1870 were 33,564 bushels of wheat, 30,870 of rye, 374,165 of Indian corn, 69,489 of oats, 80,545 of potatoes, 360,983 lbs. of tobacco, 16,538 of wool, 226,128 of butter, and 3,875 tons of hay. There were 2,847 horses, 2,698 milch cows, 2,558 other cattle, 5,598 sheep, and 13,838 swine; 2 manufactories of agricultural implements, 7 of brick, 5 of carriages, 9 of cooperage, 2 of cordage and twine, 1 of glass ware, 4 of iron forged and cast, 3 of

marble and stone work, 5 of saddlery and harness, 2 of sash, doors, and blinds, 5 of tin, copper, and sheet-iron ware, 9 of tobacco and snuff, 1 of wire work, 4 distilleries, 4 breweries, 1 saw mill, and 2 flour mills. Capitals, Independence and Covington.

**KENTON, Simon**, an American pioneer, born in Fauquier co., Va., April 3, 1755, died in Logan co., O., April 29, 1836. At the age of 16 he had an affray with a young man arising out of a love affair; and believing he had killed his adversary, he fled beyond the Alleghanies and became a companion of Boone and the other early pioneers of Kentucky. For a time he acted as a spy of Gov. Dunmore, and subsequently participated in the warfare waged against the British and the Indians west of the Alleghanies, showing remarkable courage, sagacity, and endurance. In 1782, learning that his rival was living, he returned to his native place, and soon after removed with his father's family to Kentucky. He was frequently engaged in Indian warfare, until the expedition under Wayne in 1793-'4 restored tranquillity to the western frontier. As the country began to fill up with settlers, his lands, to which, in consequence of his ignorance of or indifference to legal forms, he had never secured perfect titles, were taken from him, and by repeated lawsuits he was reduced to penury. He nevertheless took up arms in the war of 1812, and fought with the Kentucky troops at the battle of the Thames. In 1824 he appeared in Frankfort in tattered garments to petition the legislature of Kentucky to release the claim of the state upon some mountain land owned by him. His appearance at first excited ridicule, but upon being recognized he was treated with much distinction; his lands were released, and a pension of \$240 was procured for him from congress. He died near the spot where, 58 years previous, he had narrowly escaped death at the hands of the Indians.

**KENTUCKY**, an interior state of the American Union, and the second admitted under the federal constitution, between lat. 36° 30' and 39° 6' N., and lon. 82° 2' and 89° 40' W. It is bounded N. W. and N. by the Ohio river, which separates it from Illinois, Indiana, and Ohio; E. by West Virginia and Virginia, from which it is separated by the Big Sandy river and the Cumberland mountains; S. by Tennessee, along a conventional line mostly on the parallel of 36° 35' N.; and W. by the Mississippi, separating it from Missouri; greatest length E. and W. 350 m., greatest breadth 178 m.; area, 37,680 sq. m., being 1.28 per cent. of the whole surface of the United States (excluding Alaska). The state is divided into 116 counties, viz.: Adair, Allen, Anderson, Ballard, Barren, Bath, Bell, Boone, Bourbon, Boyd, Boyle, Bracken, Breathitt, Breckenridge, Bullitt, Butler, Caldwell, Calloway, Campbell, Carroll, Carter, Casey, Christian, Clarke, Clay, Clinton, Crittenden, Cumberland, Daviess, Edmonson, Elliott, Estill, Fayette, Fleming, Floyd, Frankla.

Fulton, Gallatin, Garrard, Grant, Graves, Grayson, Green, Greenup, Hancock, Hardin, Harlan, Harrison, Hart, Henderson, Henry, Hickman, Hopkins, Jackson, Jefferson, Jessamine, Johnson, Kenton, Knox, Laurel, La Rue, Lawrence, Lee, Letcher, Lewis, Lincoln, Livingston, Logan, Lyon, McCracken, McLean, Madison, Magoffin, Marion, Marshall, Martin, Mason, Meade, Menifee, Mercer, Metcalfe, Monroe, Montgomery, Morgan, Muhlenburg, Nelson, Nicholas, Ohio, Oldham, Owen, Owsley, Pendleton, Perry, Pike, Powell, Pulaski, Robertson, Rock Castle, Rowan, Russell, Scott, Shelby, Simpson, Spencer, Taylor, Todd, Trigg, Trimble, Union, Warren, Washington, Wayne, Webster, Whitley, Wolf, and Woodford. Louisville (pop. in 1870, 100,753) is the largest city and the commercial emporium of the state; Frankfort (5,396) is the capital; Lexington (14,801) is the most important inland city. Maysville (4,705), Covington (24,505) and New-

native and 63,898 foreign-born. Of the colored, 177,499 were blacks and 44,711 mulattoes, and there were 108 Chinese. Of the natives, 875,415 whites, 205,583 colored, and 83 Indians were born in the state, 12,877 in North Carolina, 19,533 in Ohio, 49,952 in Tennessee, and 44,102 in Virginia and West Virginia. The foreign-born comprised 30,318 born in Germany, 21,642 in Ireland, 4,173 in England, 2,052 in France, 1,147 in Switzerland, and 1,019 in Scotland. The density of population was 35.33 to a square mile. There were 232,797 families, with an average of 5.67 persons to each, and 224,969 dwellings, each containing an average of 5.87 persons. The increase in the aggregate population from 1860 to 1870 was 14.30 per cent., while there was a loss of 5.91 per cent. in the colored population. The number of male citizens 21 years old and upward was 282,305. There were 249,567 persons 10 years old and upward who were unable to read, and 332,176 could not write. Of the 201,077 white illiterates, 57,766 were from 10 to 15 years of age, 86,760 were from 15 to 21, and 106,551 were 21 years old and over, of whom 43,826 were males and 62,725 were females. There were 131,050 colored illiterates, of whom 24,958 were from 10 to 15 years old, 24,926 were from 15 to 21, and 81,166 were 21 and over, of whom 37,889 were males and 43,277 females. There were also 49 Indian illiterates. Among male adults the percentage of illiterates to the total number was 28.23; among female adults, 37.08. The number of paupers supported during the year ending June 30, 1870, was 2,059, at a cost of \$160,717. Of the total number (1,784) receiving support June 1, 1870, 1,080 were white and 704 colored. The number of persons convicted of crime during the year was 603. Of the total number (1,067) in prison June 1, 1870, 624 were white and 443 colored. The state contained 978 blind, 723 deaf and dumb, 1,245 insane, and 1,141 idiotic. Of the total population 10 years of age and over (930,136), there were engaged in all occupations 414,593; in agriculture, 261,080, of whom 127,911 were agricultural laborers, and 131,598 farmers and planters; in professional and personal services, 84,024, including 1,080 clergymen, 41,368 domestic servants, 24,961 laborers not specified, 1,552 lawyers, 2,414 physicians and surgeons, 2,961 teachers not specified; in trade and transportation, 25,292; and in manufactures and mechanical and mining industries, 44,197. The total number of deaths from all causes in 1870 was 14,345; there were 2,500 deaths from consumption, the number of deaths from all causes to one from consumption being 5.7; the deaths from pneumonia numbered 1,514, there being 11.7 deaths from all causes to one from that disease; 334 deaths resulted from intermittent and remittent fever, 661 from enteric fever, and 880 from diarrhoea, dysentery, and enteritis.—The western part of Kentucky is nearly level, the broad plains being varied



State Seal of Kentucky.

port (15,087), on opposite sides of the mouth of Licking river, and facing Cincinnati, Ohio, Henderson (4,171), and Paducah (6,866) are the most important cities on the Ohio river, all of which are the termini of railroads from the interior. The other cities of the state, according to the census of 1870, are Franklin, with 1,808 inhabitants; Hopkinsville, 3,136; Owensboro, 3,437; and Paris, 2,635. Harrodsburg and Boonesborough are the oldest towns.—The population of the state at decennial periods has been as follows:

U. S. CENSUS.	White.	Free colored.	Slave.	Total.	Rank.
1790.....	61,133	114	11,890	73,077	14
1800.....	179,571	741	40,348	220,565	9
1810.....	324,287	1,713	80,561	406,511	7
1820.....	434,644	2,941	126,782	564,317	6
1830.....	517,757	4,917	165,213	687,917	6
1840.....	590,258	7,317	182,258	779,833	6
1850.....	761,418	10,011	210,981	982,405	8
1860.....	919,484	10,684	225,483	1,155,651	9
1870.....	1,098,622	222,210	.....	1,321,011	8

Of the total population in 1870, 665,375 were males and 655,336 females; 1,257,613 were

by gentle undulations. The southeast is broken by the Cumberland mountains and their offshoots. Narrow, deep, and gloomy valleys intervene between the ridges. None of the summits attain a greater altitude than 3,000 ft., and their mean elevation does not exceed 2,000 ft. The whole of this region is well wooded, especially the foot hills and valleys. N. and W. of the hilly region lies what may be called an upland, which extends from the Big Sandy river to lon.  $86^{\circ}$  W., and comprehends more than half the whole area of the state. Its surface is gently undulating, but it is intersected by numerous narrow and deep valleys in which the rivers run. Though this upland is sparingly provided with spring water, its soil is of the first quality and equal to any in the Union. It is included in the tract of blue limestone which extends from the Ohio river, between a point about 40 m. above Louisville and the eastern limits of Mason co., about 10 m. above Maysville, southwardly to the Cumberland river, and is known as the "blue grass region." The W. portion of the state is divided between the "barrens" and a country which is partially hilly. The barrens, which occupy chiefly the tract between the Green and Cumberland rivers, in their natural state are generally destitute of trees, resembling in this respect the prairies N. of the Ohio river; but the level surface is diversified by low round-topped hills, called "oak knobs" on account of the trees which cover them. This tract was formerly considered the least fertile portion of the state, but the value of its red calcareous soils has greatly increased. The alluvial bottoms between these hills and the Ohio and its affluents are exceedingly rich. On the north and west the barrens are margined by a more broken and hilly country, which gradually passes to the low flats which skirt the Ohio and Mississippi rivers. This tract is superior in fertility to the barrens, but cannot be compared with the upland country.—Kentucky is amply provided with noble streams. The Mississippi forms its W. limit for 80 m. Along the N. W. and N. boundary runs the Ohio in a winding course for nearly 600 m., navigable throughout, and affording with its chief affluents water communication to all parts of the state. The Mississippi receives from Kentucky only a few inconsiderable tributaries. Of the streams which flow into the Ohio, the most eastern is the Big Sandy, which has its sources in Virginia and West Virginia; where it approaches Kentucky it turns nearly due N., and continues in that direction to its outlet, forming the boundary between Kentucky and West Virginia; it is navigable only for a short distance, owing to falls which occur where it issues from the mountain region. The Licking rises in Floyd co., flows with many windings in a N. W. direction for more than 200 m., and falls into the Ohio between Covington and Newport, opposite Cincinnati; in winter and spring it is navigable for about 70 m. The dif-

ferent branches of the Kentucky river rise in the Cumberland mountains, and form by their union a considerable stream, which flows first N. W., then S. W., and at last N. N. W.; its course is about 260 m., and though very rapid it may be navigated by steamboats 80 m. to a point 20 m. above Frankfort, and by small boats for 100 m. higher. Green river rises in the W. districts of the upland region, and flows W. for a great part of its course, to its junction with its chief affluent, the Big Barren, where it turns N. W. and finally N., joining the Ohio about 50 m. above the Cumberland; its length is about 300 m., and it is navigable for steamboats to Greensburg, 200 m., and for boats nearly to the heads of the stream. Navigation was obstructed by falls about 50 m. above its mouth, but a lock and dam at that point has obviated the difficulty. Cumberland river rises in the valley between the Cumberland and Laurel mountains; it traverses both the mountain and the upland regions, generally in a westerly direction, but on approaching the barrens it turns S. and enters Tennessee, where it makes a large bend and then reenters Kentucky with a N. W. course, and so continues to the Ohio, which it enters about 10 m. above the mouth of the Tennessee; it is nearly 600 m. long, and as its current is comparatively gentle it offers an easy navigation for sloops and steamboats as far up as Nashville, Tenn., 200 m. from its mouth, and at high water to Burkesville, Ky.; for boats of 15 tons it is navigable for 300 m., and for river boats much higher. The Tennessee flows only about 70 m. through Kentucky; it admits steamboats to Florence, Ala., 300 m. from its mouth.—Kentucky lies wholly in the great region of stratified rocks of the west. These traverse the state in layers so nearly horizontal, that often over broad districts no dip is perceptible to the eye. Through the central portion of the state, from N. to S. the Silurian groups, which are here almost exclusively calcareous, thus overspread the surface for nearly 100 m. in width, and form the great central axis of the lowest rocks. At Louisville they disappear by reason of their very gentle westward dip, and pass beneath the limestones of the Devonian age, which here lie exposed in horizontal strata, forming the bed of the river and the reefs which occasion the falls at this place. They are succeeded by the carboniferous limestone; and still farther W. the coal measures, commencing at Rome on the Ohio river, are traced almost to the mouth of this river. This is the southern end of the coal field of Illinois and Indiana, which extends S. nearly across the western portion of Kentucky. (See COAL.) In this portion occurs the Breckenridge coal, formerly extensively used in the manufacture of kerosene. To the east, about 100 m. from Louisville, the same repetition of the formations is encountered, as the Silurian rocks dip E. on this side of the axis; and the coal measures

which occupy the whole eastern portion of the state are a part of the great Appalachian coal field which overspreads western Virginia and Pennsylvania. The limestones abound in fossil remains, and those of the falls at Louisville are especially famous for their remarkably fine coralline productions. The hydraulic limestone is found here, and largely used in the manufacture of cements. When the river is low the rocks in its bed appear like the coral reefs produced by living zoöphytes, the softer portions being worn away, so that the hard calcareous corals stand out in relief precisely as if they were living. Fine selected specimens being placed in juxtaposition with others of recent growth, none but a zoölogist would be able to guess which were ancient and which modern. These limestones also abound in caves, some of which are among the most remarkable of these curiosities. Upon their walls are found incrustations of saltpetre, which in some instances have been profitably collected. The Mammoth cave, near Green river, in Edmonson co., is the largest in the world. It has been explored through winding passages more than 10 m. (See MAMMOTH CAVE.) In some of the superficial depressions of the limestone are found the low swamps known as "licks," frequented by deer and elk, and in ancient times by the buffalo, and in a still more distant epoch by the extinct species of elephant, horse, mastodon, megalonyx, &c., whose bones are occasionally found near the saline springs of these quagmires. One of the most remarkable of these localities is the Big Bone lick, 23 m. S. W. of Cincinnati. Lead ores have been worked to a small extent heretofore, but considerable efforts are now in progress for their development. Salt springs occur in many places among the sandstone rocks, and sulphur, saline, and chalybeate springs are numerous. On Goose creek in Clay co., and in Meade co., salt is largely manufactured from brine procured by boring. The "hanging rock" iron region comprises a portion of N. E. Kentucky and of S. Ohio; it is about 15 m. wide, and extends about 80 m. from the Ohio river into Kentucky, and about 50 m. N. into Ohio. The ores of this region are mostly brown hematite; they lie in strata which dip to the east with a slight deviation to the south. There are two clearly defined strata, the lower being from 10 to 30 in. thick and yielding block ore. Above this, at distances varying from 30 to 75 ft., lies the stratum known as the limestone ore, which is from 12 to 50 in. thick. These ores contain from 40 to 65 per cent. of iron, which is found to be remarkably well adapted for the manufacture of car wheels. Numerous iron furnaces are in operation in this region. Besides iron ores, large deposits of superior coal, fire clay, moulding sand, limestone, building stone of superior quality, potter's clay, and sand suitable for making glass are found. Extensive deposits of hydrated oxides of iron exist in the S. W. counties, bordering on the Ten-

nessee and Cumberland rivers; and different ores of iron are found all through the coal fields and in the slate and subcarboniferous limestone regions.—The blue limestone region, which was originally covered with forests of large trees and a dense undergrowth of reeds, contains the richest soil in the state, and that part of it between the Ohio and the vicinity of Lexington is commonly called the "garden of Kentucky." The barrens are thinly wooded with trees which have grown up almost wholly since the settlement of the state, but produce good pasturage, so that the average fertility of Kentucky may be considered equal to that of any other state in the Union. The climate is remarkably pleasant, but variable. The mean annual temperature is about 55° F.; in winter the thermometer frequently falls to 30° or 15°, and occasionally below zero, and in summer rises to 94° or 100°. Winter sometimes continues from late November to early April, but snow seldom lies long on the ground, and cattle and sheep are abroad throughout the coldest seasons. In spring and summer S. W. winds prevail, and the weather is delightful. The N. W. wind produces the greatest winter cold. Rain falls abundantly in winter and spring, but is sometimes scanty in summer and autumn, the weather in those seasons being characteristically dry and constant.—There are still extensive forests in Kentucky. In the mountain and upland region are found chiefly tulip trees, elm, oak, ash, hickory, walnut, cherry, &c.; those of the barrens are chiefly oaks, chestnuts, and elms. Among the most useful trees are the sugar maple, black and honey locust, wild cherry, and the several varieties of oak and walnut, which in the early settlement of the state furnished household staples of great value. The principal fruit trees are the apple and peach. Besides being a great grain-growing state, Kentucky produces more than half of the hemp grown in the Union, and four sevenths of the flax. In the S. W. districts, along the Tennessee, Cumberland, and Mississippi rivers, some cotton is raised; and the tobacco grown in these regions and in the rich soil further E. supplies a valuable material to the commerce of the state. As an agricultural state Kentucky holds a very high rank. Of the total production of hemp (12,746 tons) in the United States in 1870, as reported by the federal census, 7,777 tons were contributed by Kentucky; while of the entire yield of tobacco in the United States (262,735,341 lbs.) 105,305,869 lbs. were the product of this state. In the same year only five states produced more Indian corn, four more rye, two more honey, and three more wax, and only three contained more swine. According to the census of 1870, there were in the state 118,423 farms; of these, 38,939 contained between 20 and 50 acres, 29,781 between 50 and 100, 25,490 between 100 and 500, 616 between 500 and 1,000, and 164 contained 1,000 acres and over. The

average size of farms was 158 acres. The total amount of land in farms was 18,660,106 acres, of which 8,103,850 were improved and 10,556,256 unimproved, 9,134,658 acres of the latter being woodland; the percentage of unimproved to total land in farms was 56.6. The cash value of farms was \$311,238,916; farming implements and machinery, \$8,572,896; total amount of wages paid during the year, including value of board, \$10,709,382; total (estimated) value of all farm productions, including betterments and additions to stock, \$87,477,374; of orchard products, \$1,231,385; of produce of market gardens, \$527,329; of forest products, \$574,994; of home manufactures, \$1,683,972; of all animals slaughtered or sold for slaughter, \$24,121,861; of all live stock, \$66,287,343. The chief agricultural productions were 38,532 bushels of spring and 5,690,172 of winter wheat, 1,108,933 of rye, 50,091,006 of Indian corn, 6,620,103 of oats, 238,486 of barley, 3,443 of buckwheat, 119,926 of peas and beans, 2,391,062 of Irish and 802,114 of sweet potatoes, 2,551 of clover and 35,896 of grass seed, 14,657 of flaxseed, 204,399 tons of hay, and 7,777 of hemp, 1,080 bales of cotton, 105,305,869 lbs. of tobacco, 2,234,450 of wool, 237,268 of flax, 11,874,978 of butter, 115,219 of cheese, 1,345,779 gallons of milk sold, 49,073 of maple and 1,740,453 of sorghum molasses, 62,360 of wine, 269,416 lbs. of maple sugar, 1,171,500 of honey, and 32,557 of wax. There were on

farms 317,034 horses, 99,230 mules and asses, 247,615 milch cows, 69,719 working oxen, 382,993 other cattle, 936,765 sheep, and 1,838,227 swine. In 1870 16 states ranked higher than Kentucky in the total value of manufactured products. In distilled liquors, the state ranked first in the number of establishments, second in the amount of capital invested, and fourth in the value of products, as appears from the following statement:

STATES.	No. of establishments.	Capital.	Product.
Kentucky .....	141	\$2,670,700	\$4,582,730
Illinois .....	45	2,513,000	7,594,721
Ohio .....	68	2,829,700	7,022,654
Pennsylvania .....	108	2,504,557	4,615,239

The manufacture of distilled liquors is almost wholly confined to whiskey, the amount of highwines made being very small. The total number of manufacturing establishments reported by the census was 5,390, using 1,147 steam engines of 31,928 horse power, and 459 water wheels of 7,640 horse power, and employing 30,636 hands, mostly male adults. The total amount of capital employed was \$29,277,809; wages paid during the year, \$9,444,524; materials consumed, \$29,497,535; products, \$54,625,809. The chief industries are shown by the following table:

INDUSTRIES.	Number of establishments.	Steam engines, horse power.	Hands employed.	Capital.	Wages paid.	Value of materials.	Value of product.
Agricultural implements.....	44	270	624	\$693,025	\$257,500	\$673,176	\$13,437
Bagging .....	11	180	1,225	750,000	301,340	1,077,340	1,722,129
Blacksmithing .....	1,092	23	1,970	463,735	248,321	443,200	1,794,973
Boots and shoes.....	420	.....	1,150	430,271	310,256	490,944	1,144,641
Carpentering and building.....	845	86	1,696	292,690	319,113	841,769	1,691,776
Carriages and wagons.....	325	23	1,230	577,405	469,016	440,170	1,529,969
Clothing (men's).....	193	.....	801	462,132	227,998	568,178	1,468,254
Flouring and grist mill products.....	916	9,019	1,646	2,690,863	823,247	6,429,234	7,949,774
Furniture.....	90	346	967	750,355	412,873	543,472	1,668,977
Glass wares.....	3	19	436	370,000	238,631	130,259	447,000
Iron blooms.....	1	50	50	100,000	37,500	50,000	34,500
" forged and rolled.....	2	1,450	376	1,123,000	582,248	1,367,064	2,464,923
" bolts, nuts, washers, and rivets.....	2	14	27	24,000	10,750	5,394	35,200
" pigs.....	19	2,370	1,565	2,979,000	417,948	1,223,694	2,142,643
" castings not specified.....	25	572	895	1,457,431	494,063	1,359,249	2,394,473
" stoves, heaters, and hollow ware.....	7	106	493	583,000	288,000	370,000	554,770
Leather, tanned.....	100	237	293	566,424	76,969	741,192	1,000,396
" curried.....	62	40	135	157,016	41,544	156,963	699,695
Liquors, distilled.....	141	2,696	1,083	2,670,700	257,733	1,892,096	4,392,739
" malt.....	35	222	168	354,900	102,699	363,613	638,339
Lumber, planed.....	17	587	239	238,625	123,474	314,139	563,672
" sawed.....	562	9,443	2,497	1,724,696	442,693	1,463,291	2,892,366
Saddlery and harness.....	212	16	635	468,343	193,455	468,619	1,073,536
Tin, copper, and sheet-iron ware.....	127	83	381	370,710	278,081	463,749	1,031,036
Tobacco, chewing, smoking, and snuffing.....	32	174	900	662,691	212,732	823,153	1,671,607
" cigars.....	70	.....	389	197,840	140,569	187,648	468,000
Wool carding and cloth dressing.....	89	635	193	117,547	17,023	311,069	623,000
Woolen goods.....	36	796	453	688,102	142,350	330,619	597,667

—Kentucky has little direct foreign commerce, but its domestic commerce is very extensive. The chief commercial places are Mayaville, Covington, Louisville, Owensboro, Henderson, and Paducah, on the Ohio, Columbus on the Mississippi, and Lexington in the interior. The principal exports are hemp, flax, tobacco, horses, mules, hogs, cattle, bagging, and rope. There

are two United States customs districts, of which Louisville and Paducah are the ports of entry. The total number of vessels registered, enrolled, and licensed in 1873 was 53, of 13,807 tons, at Louisville, and 15, of 2,878 tons, at Paducah. Of those at Louisville, 44 were steamers and 11 barges, while the entire number at Paducah were steamers. Boat building

is carried on at both of these points; 24 boats were built in 1873, including 17 steamers at Louisville and 4 at Paducah. Internal improvements have been well attended to, and several of the large rivers have been rendered navigable for considerable distances above their natural heads of navigation; the works on the Kentucky and Green are the most important. The completion of the Louisville and Portland canal around the falls of the Ohio at Louisville

enables boats 300 ft. long and 80 ft. wide to pass through nearly the whole year. As early as 1841 Kentucky had 28 m. of railway. The mileage had increased to 549 in 1861, 852 in 1869, and 1,128 in 1871. In 1873 the total number of miles of main track in the state was 1,228, and other roads were in process of construction and projected. The railways, with their termini and the number of miles in operation in 1873, were:

CORPORATIONS.	TERMINI.	Miles in operation in the state in 1874.	Miles between termini when different from preceding.
Cincinnati Southern (in progress).....	Cincinnati and Chattanooga, Tenn.....	...	...
Eastern Kentucky .....	Riverton and Grayson .....	28	...
Louisville, Paducah, and Southwestern .....	Louisville and Paducah .....	280	...
Elizabethtown, Lexington, and Big Sandy .....	Lexington and mouth of Big Sandy river .....	84	120
Kentucky Central .....	Covington and Nicholasville .....	112	...
Louisville, Cincinnati, and Lexington .....	Louisville and Lexington .....	94	...
Branches.....	Lexington Junction to Newport.....	81	...
Louisville, Nashville, and Great Southern.....	Anchorage to Shelbyville .....	19	...
Memphis division.....	Louisville and Nashville, Tenn.....	189	185
Branches.....	Memphis Junction to Memphis, Tenn.....	46	299
	Lebanon Junction to Livingston .....	110	...
	Richmond Junction to Richmond .....	84	...
	Bardstown Junction to Bardstown .....	17	...
	Glasgow Junction to Glasgow .....	11	...
Marysville and Lexington .....	Paris and Mayaville .....	15	50
Mobile and Ohio .....	Columbus and Mobile, Ala.....	20	473
Nashville, Chattanooga, and St. Louis.....	Hickman and Chattanooga, Tenn.....	8	321
Owensboro and Russellville.....	Owensboro to Tennessee state line.....	85	116
Paducah and Memphis .....	Paducah and Memphis, Tenn.....	50	105
St. Louis and Southeastern .....	East St. Louis, Ill., and Nashville, Tenn.....	103	316
Branch .....	Shawneetown, Ill., to Madisonville.....	43	...

In 1873 there were 36 national banks in operation, with a paid-in capital of \$8,263,700 and an outstanding circulation of \$7,021,900. The entire bank circulation of the state was \$7,637,900, being \$5.78 per capita. The ratio of circulation to wealth was 1:3, and to the bank capital 81:4.—The present constitution of Kentucky was adopted in 1850. Every free male citizen 21 years of age, who has resided in the state two years, in the county one year, and in the precinct 60 days next preceding an election, is entitled to vote. The general election is fixed by law on the first Monday in August, and voting is *viva voce*, except in the election of representatives to congress, when it is by ballot. The legislature consists of a senate of 38 members, and a house of representatives of 100. Senators must be 30 years of age, and are chosen for four years, one half every second year. Representatives must be 24 years of age, and hold office two years. The sessions of the legislature are biennial, beginning on the first Monday of December in every odd year, and lasting not longer than 60 days unless by vote of two thirds of both houses. Members are paid \$5 a day, and 15 cents a mile for travel. The governor is chosen for four years. He must be 35 years of age, a citizen of the United States, and have been resident in the state for six years. He is ineligible to the office for the four years succeeding his term. A majority vote in each house is sufficient to pass a bill

over the governor's veto. The lieutenant governor, auditor, attorney general, register of land office, and superintendent of public instruction are also elected for four years. The lieutenant governor, with the same qualifications as the governor, is *ex officio* president of the senate. If a vacancy occurs in the office of governor during the last half of the term, the lieutenant governor, and failing him the speaker of the senate, acts as governor; but if during the first half of the term, then a new election is held. The treasurer is elected by the people every two years. The secretary of state is appointed by the governor, by and with the advice and consent of the senate, and holds office during the governor's term. The official salaries are: for the governor \$5,000, secretary of state \$1,500, auditor \$2,500, register of land office \$2,000, treasurer \$2,400, and superintendent of public instruction \$3,000. The secretary of state, auditor, and register of the land office also have certain fees. The pay of the lieutenant governor is \$8 a day during attendance at the legislative session. The judiciary consists of the court of appeals, which has appellate jurisdiction only, circuit and county courts. The state is divided into four appellate judicial districts and 16 circuit court districts. Louisville has separate chancery and common pleas courts, and additional courts have been established in several districts. The court of appeals consists of a chief justice and three judges, a clerk, sergeant, and

reporter. The judges have each \$5,000 a year, and the attorney general \$500 and fees. The Louisville chancery court consists of a chancellor (salary \$3,000), a clerk, and a marshal (fees). The judges of circuit are paid \$3,000, and attorneys \$500 and fees. The judges of the Louisville courts are paid in addition \$1,000 each by the city. All judges and other officers of courts are elected by the people. Judges of the court of appeals and the circuit courts must have had eight years' experience in law to be eligible to the bench. Kentucky is represented in congress by two senators and 10 representatives, and is therefore entitled to 12 votes in the electoral college. According to the federal census of 1870, the assessed value of real estate was \$311,479,694, and of personal \$98,064,600; total assessed value of property, \$409,544,294; true value of real and personal estate, \$604,318,552. The total taxation not national amounted to \$5,730,118, including \$2,254,413 state, \$1,307,833 county, and \$2,167,872 town, city, &c. The total receipts into the state treasury during the fiscal year were \$2,107,149, the most important sources being: direct taxes, \$1,491,775; corporations, banks, and insurance companies, \$332,992; and licenses, \$78,551. The total disbursements amounted to \$1,824,892. The bonded debt of the state in 1872 was \$986,394. In 1874 it was entirely free from debt except the amount due the school fund, \$1,628,123 08, which is made by the constitution a permanent debt of which the interest only is to be paid. A direct tax of 45 cents on every \$100 in value of real and personal property is annually collected for various purposes of state government, of which 20 cents goes to the school fund and the remainder to general purposes. Stock in banks and other moneyed corporations is taxed 50 cents on each share of \$100. Railroads are taxed for the benefit of the state, on a valuation of \$20,000 a mile, at the rate of 45 cents on every \$100. The same rate of tax is also paid by toll bridge, mining, manufacturing, gaslight, street railroad, and waterworks corporations. Express, telegraph, and turnpike companies are also taxed.—The superintendent of public instruction is required to set forth in his annual report the condition of the institutions for the blind, the deaf and dumb, and the feeble-minded. The asylum for the education of the blind in Louisville, opened in 1842, is intended to afford board and tuition free of charge to the blind of the state between the ages of 7 and 17 years. Not only the totally blind, but those whose eyesight is so defective that they cannot see to read, may be received and educated at the expense of the state. Besides the ordinary branches, instruction is given in industrial pursuits. In 1873 there were 5 teachers and 59 pupils. The institution for deaf mutes in Danville, organized in 1823, is open to all persons of this class in the state, without charge for board or tuition. Pupils supported by the

state are expected to remain five years. The average number of pupils in 1873 was 78, instructors 5; number of pupils received since the opening of the institution was 590, of whom 344 were males and 246 females. Provision is made by the state for the education of feeble-minded persons in the institution for this class in Frankfort, which has been in existence since 1860. It is designed for the education of imbecile children, and not as an asylum for hopeless idiots. Those unable to pay may be educated free of charge. The whole number of pupils in 1874 was 104. The state penitentiary in Frankfort, in 1874 had 650 convicts. In 1873 the legislature passed an act vesting the management of each of the charitable institutions of the state, except that for the deaf and dumb, in a board of nine commissioners, who are appointed by the governor and senate, and must be residents of the county where the institution is situated. It was also provided that the asylum for the insane at Lexington should be known as the first Kentucky lunatic asylum, that at Hopkinsville as the second Kentucky lunatic asylum, the institution for the education of feeble-minded children as the third Kentucky lunatic asylum, and the state house of reform for juvenile delinquents at Anchorage as the fourth Kentucky lunatic asylum. The two institutions first named are to be devoted to the treatment of "lunatics afflicted with acute mania," and the other two to cases of "chronic mania or epilepsy."—Under the new school law of 1873, the general educational interests of the state are intrusted to a board of education, comprising the superintendent of public instruction, secretary of state, and attorney general, together with two professional teachers to be elected by them. The more immediate supervision of the schools is vested in the superintendent of public instruction (who is elected by the people for four years, and receives an annual salary of \$2,000), a commissioner of common schools in each county, and a trustee for each school district; only teachers who have obtained certificates are employed. The annual revenue of the common school fund comprises the interest at the rate of 6 per cent. per annum on the state school bond of \$1,827,000, the dividends on 735 shares of the stock of the bank of Kentucky, the annual tax of 20 cents on each \$100 in value of the property of the state, and certain fines and forfeitures. This income is distributed each year among the counties and districts according to the number of white children between the ages of 6 and 20 years. The amount available in 1873 was nearly \$1,000,000. The *pro rata* amount to each child during the year ending June 30, 1874, was \$1 60, and \$2 20 for the preceding year. The entire income of the school fund is devoted to educating white children. The legislature of 1873-'4 passed an act establishing a system of common school education for colored children, to be under the supervision of the

superintendent of public instruction and the state board of education. The funds for its support are derived chiefly from the annual revenue tax of 25 cents, and 20 cents in addition on each \$100 in value of the taxable property owned or held by colored persons, which tax shall be applied to no other purpose whatever; a capitation tax of \$1 on each male colored person above the age of 21 years; and all the fines, penalties, and forfeitures imposed upon and collected from colored persons due the state, except the amount thereof allowed by law to attorneys for the commonwealth. The act in effect appropriates all taxes levied on colored people or their property to the education of colored children. The total taxable property of the colored people of the state in 1873 was \$3,569,040, and the number of male colored persons over 21 years of age was 45,604. The number of colored children of school age reported to the auditor in 1873 was 41,289. In 1873 the whole number of persons of school age in the state was 416,763, and the number of schools 5,381. The state teachers' association meets annually, and teachers' institutes are held at intervals during the year. According to the census of 1870, the total number of white children in the state between the ages of 5 and 18 years was 454,589, and of colored 78,720. Of the latter, only 7,702 were attending school. There were 5,149 educational institutions, public and private, with an aggregate of 6,346 teachers, of whom 3,972 were males and 2,374 females, and 245,189 pupils, of whom 125,734 were males and 119,405 females. The total income of all these institutions was \$2,538,429, of which \$393,015 was derived from endowment, \$674,992 from taxation and public funds, and \$1,470,422 from tuition and other sources. There were 4,727 public schools, with 5,351 teachers and 218,240 pupils; the income amounted to \$1,150,451, of which \$24,885 was from endowment, \$604,905 from taxation and public funds, and \$520,661 from tuition and other sources. The number of colleges was 42, having 223 teachers and 5,864 pupils; and there were 95 academies, with 286 teachers and 6,224 pupils, and 195 private schools, with 302 teachers and 7,948 pupils. Kentucky has (1874) no state normal school, but efforts have been made for the establishment of one. Normal instruction, however, is afforded by several colleges. The Kentucky university, established in 1858, embraces a college of arts, the agricultural and mechanical college, the college of the Bible, a commercial college, and a college of law. Each college is under the immediate government of its own faculty and presiding officer. The general supervision of the university is committed to the regent, who is chosen from the curators. In 1865 the agricultural and mechanical college, established by means of the congressional land grant, was made a part of the university, and the citizens of Lexington having given \$100,000 for the purchase of an experimental and model farm and the erection of buildings for the agricultural college, the university was removed to that city. The tract of land occupied by the agricultural college contains 433 acres, and embraces Ashland, once the home of Henry Clay. The endowment and real estate of the university amount to about \$800,000. Students are employed in industrial pursuits at a good rate of compensation. The Kentucky military institute in Frankfort, organized in 1846, is under the direction of a board of visitors appointed by the governor. Among the most prominent educational institutions are Berea college, at Berea, at which students are received without regard to sex or color; Bethel college (Baptist), at Russellville; Cecilian college (Roman Catholic), at Elizabethtown; Centre college (Presbyterian), at Danville; Eminence college, at Eminence, open to both sexes; Georgetown college (Baptist), at Georgetown; and St. Mary's college (Roman Catholic), at St. Mary's Station. The leading institutions for the education of women are Daughters' college (Christian), at Harrodsburg; Georgetown female seminary (Baptist); Lebanon female college; Logan female college (Methodist Episcopal), at Russellville; Hocker female college (Christian); Lexington Baptist female college, St. Catherine's academy (Roman Catholic), and Christchurch seminary (Episcopal), at Lexington. Instruction in theology is afforded by St. Joseph's seminary (Roman Catholic), at Bardstown, Western Baptist theological institute at Georgetown, college of the Bible, Kentucky university, and the theological departments of Georgetown and Bethel college; in medicine, by the medical department of the university of Louisville and by the Louisville medical college.—According to the census of 1870, there were 80 newspapers and periodicals published in the state, having an aggregate circulation of 197,130, and issuing 18,270,160 copies annually. There were 6 daily, with a circulation of 31,000; 4 tri-weekly, circulation 3,500; 4 semi-weekly, circulation, 4,100; 68 weekly, circulation 137,930; and 7 monthly, with a circulation of 19,700. In 1873 the publications were 9 daily, 6 of which issued also weekly editions, 1 tri-weekly, 4 semi-weekly, 80 weekly, and 9 monthly. The total number of libraries in 1870 was 5,546, containing 1,909,230 volumes; 4,374, with 1,590,245 volumes, were private, and 1,172, with 318,985 volumes, were other than private, including two state libraries, with 9,200 volumes; 10 town, city, &c., with 13,436; 218 court and law, with 61,590; 18 school, college, &c., with 20,675; 717 Sunday school, with 160,377; and 207 church, with 53,707. The principal libraries in 1874 were that of the Kentucky university at Lexington, which had 10,000 volumes; the Lexington library company's, 18,800; the state library in Frankfort, 7,000; Danville theological seminary, 7,000; public library of Kentucky, at Louisville, 31,250; St. Joseph's college and seminary in Bardstown, 5,000; Centre college



in Danville, 5,000; Georgetown college, 5,000; Episcopal theological library 2,000; and Louisville library association, 5,690. The museum of natural history of Kentucky university contains more than 40,000 specimens, and the museum attached to the public library of Kentucky contains over 100,000, which, however, are only partially classified. The total number of religious organizations was 2,969, having 2,696 edifices, with 878,039 sittings, and property valued at \$9,824,465. The leading denominations were as follows:

DENOMINATIONS.	Organi- zations.	Edi- fices.	Sittings.	Property.
Baptist .....	1,004	962	288,986	\$2,023,975
Christian .....	490	436	141,535	1,046,075
Episcopal, Protestant .....	23	25	15,800	570,300
Evangelical Association .....	5	5	3,000	159,000
Jewish .....	8	8	1,500	184,000
Lutheran .....	7	7	1,650	16,000
Methodist .....	973	818	244,913	1,854,565
Presbyterian, regular .....	289	270	97,150	1,273,400
"    other .....	17	15	8,600	17,000
Roman Catholic .....	180	125	72,550	2,604,900
Shaker .....	2	2	1,600	28,000
Unitarian .....	1	1	1,000	8,000
Universalist .....	2	2	400	5,900
Unknown (union) .....	8	15	4,650	28,750

—The earliest exploration of Kentucky was made by John Finley and a few companions from North Carolina in 1767. In 1769 Daniel Boone, Finley, and four others visited the region, and in 1770 Col. James Knox, with a party from S. W. Virginia, explored the country along the Cumberland and Green rivers. In 1773-'4 a party locating bounty warrants extended their surveys to the north fork of the Licking, up the Kentucky as far as Dix river, and over a considerable territory near the falls. In 1774 James Harrod built a log cabin on the present site of Harrodsburg, and the next year he established a station there. The fort at Boonesborough was built by Daniel Boone in 1775. The country of Kan-tuck-kee, "the dark and bloody ground," was not occupied by the aborigines except as a common hunting ground for the tribes north and south of it. The intrusion of white settlements met with determined and bloody opposition. In March, 1775, Boone concluded a treaty with the Cherokees at Wataga, by which Kentucky was sold to Col. Richard Henderson and his company. As it lay within the charter limits of Virginia, that state would not recognize Henderson's purchase, but finally compromised by giving him 200,000 acres at the mouth of Green river. In 1776 Kentucky was made a county of Virginia, and in 1777 the first court was held at Harrodsburg. In 1779 the Virginia legislature passed a law which caused a great influx of population. In 1783 Kentucky was formed into one district, and a district court established. The conclusion of the war of independence left the settlers in constant danger of Indian outrage, and the citizens found themselves obliged to undertake their own protection. Richmond, Va., the

capital, was too far distant to be relied on for assistance in times of need, and hence the conventions held at Danville in 1784-'5 recommended a peaceable and constitutional separation from Virginia. The third convention sent a petition to Richmond, and in 1786 an act was passed by the legislature complying with the desires of Kentucky; but from several causes the separation was not then completed, chiefly from an inclination of the people to obtain an independent nationality. A fourth convention only served to inflame the people against the central government; and a report having gained currency that Mr. Jay, when minister to Spain, had ceded the navigation of the Mississippi to that country, the utmost ill feeling was aroused. A fifth convention met, and on petition Virginia allowed the Kentuckians to send a delegate to congress; but the constitution having in the mean while been adopted, the whole subject was referred to the new government. Taking advantage of this position of affairs, Spain clandestinely proposed through her minister peculiar commercial favors to Kentucky in case of her forming an independent government. These propositions met with some favor; but after a sixth and a seventh convention were assembled, an address to congress was ultimately voted. Two more conventions were subsequently held, and the question was determined by Kentucky becoming in 1790 a separate territory, and its admission into the Union on June 1, 1792. The population at this time was about 75,000. Indian wars continued to disturb the frontiers, and complaints of the inefficiency of the federal government were again heard. The whisky tax also became oppressive, and the American policy toward the French republic was denounced in every cabin. The old idea of independence was again mooted, but the storm passed over. In the 10 or 12 years which succeeded, and which included the period of negotiation for the navigation of the Mississippi, and then for the purchase of Louisiana, Kentucky was again agitated. The treaty of 1795 with Spain gave to the United States the right of deposit at New Orleans and the freedom of the river. Pending the negotiations the governor of Louisiana had approached some leading Kentuckians with a view to a different treaty; but action on these promises was stayed by federal interference, and the faithlessness of the Spaniards soon became evident. Seven years now passed in comparative quiet and prosperity, when the whole nation became excited by the intelligence that the Spaniards had violated the treaty of 1795 by a denial of the rights secured by its provisions, and it became known that even Louisiana had been retroceded to France. Its subsequent purchase by the United States put an end to all pending troubles. In the war of 1812 Kentucky took an active part. Upward of 5,000 volunteers were called into active service, and at one time more than

7,000 Kentuckians are said to have been in the field. After the treaty of 1814 Kentucky was undisturbed by any stirring events. The progress of the state, however, was rapid, and the development of agriculture and other branches of industry within her borders signally well sustained. The second constitution took effect in 1800, and continued in force until the adoption of the present one in 1850. At the beginning of the civil war, Kentucky, favoring an amicable adjustment of the difficulties between the north and the south, assumed a position of neutrality, and determined to resist the invasion of the state by either the federal or the confederate forces. At the presidential election in 1860, 66,058 votes had been cast for Bell, 53,148 for Breckenridge, 25,651 for Douglas, and 1,364 for Lincoln. In February, 1861, the legislature, refusing to call a state convention to consider the subject of secession, passed resolutions appealing to the southern states to stop the revolution, protesting against federal coercion, and favoring the calling of a national convention for proposing amendments to the constitution of the United States. The requisition upon Kentucky for volunteers, made by the secretary of war immediately after the attack on Fort Sumter, was met by a refusal on the part of Governor Magoffin to furnish any troops. However, Lieut. William Nelson of the navy, a native of the state, began to recruit volunteers for the national service, and toward the end of July established a camp of organization in Garrard co., which he called Camp Dick Robinson. Volunteers rapidly assembled, and by the end of September three full regiments of infantry and one of cavalry were ready for service, besides one full regiment of refugees from East Tennessee, and one nearly full. Recruiting for the national service was carried on during the same time at other points. Governor Magoffin protested against this, and urged the general government to withdraw these forces from the state. President Lincoln refused to do so, on the ground that he "did not believe it was the popular wish of Kentucky that this force should be removed beyond her limits." At elections held in May and June it was shown that a great majority of the people were in favor of the Union. Early in September the state was invaded by a strong confederate force from Tennessee, under Gen. Polk, who occupied and fortified Hickman and Columbus, important points on the Mississippi river. About the same time a confederate force under Gen. Zollicoffer advanced from Tennessee into southeastern Kentucky, and Bowling Green was occupied by a large body of confederate troops under command of Gen. Buckner. Federal forces also began to concentrate at several points in large numbers. Gen. Robert Anderson was appointed to the command of this department, but was soon succeeded by Gen. Sherman, upon whose resignation Gen. Buell assumed command. During the latter part of 1861 there were numerous

skirmishes and unimportant engagements between the opposing forces in the state. In November 200 persons, not elected by any constituency, but coming from 51 counties of the state, assembled in convention at Russellville, then within the confederate lines, and organized a provisional government consisting of a governor, legislative council of ten, a treasurer, and auditor. George W. Johnson was chosen for governor. He was subsequently killed at the battle of Shiloh, and Richard Hawes was chosen in his place. In January, 1862, Gen. Buell, having concentrated a large army at Louisville, sent a division under Gen. George H. Thomas to attack the confederate force in southeastern Kentucky, which had been reinforced by the division under Gen. Crittenden. In the battle of Mill Spring (Jan. 19) which ensued, the confederate forces were defeated, and Gen. Zollicoffer was killed. At the same time a large force was concentrated at Paducah, Cairo, Ill., and St. Louis, Mo., under command of Gen. Halleck, for operations in Kentucky and Tennessee. After the success of the expedition under Gen. Grant against Forts Henry and Donelson in February, the confederate forces abandoned Bowling Green and Columbus and withdrew from the state. Governor Magoffin resigned in August, and was succeeded by James F. Robinson, speaker of the senate. In September Gen. Bragg at the head of a large confederate force invaded the state from East Tennessee, and advanced rapidly toward Louisville, to which place the governor and legislature retired with the state archives. By forced marches Gen. Buell succeeded in getting between Louisville and Bragg's army, and on Oct. 8 a battle was fought at Perryville, Boyle co., with heavy loss on both sides. Bragg then withdrew his forces from the state, having meanwhile occupied Frankfort and all the country north of the Kentucky river, apparently threatening Cincinnati. Steps had been taken for inaugurating the provisional confederate state government at the capital, but the ceremonies were interrupted by the advance of the Union troops, and that organization disappeared. The state continued to be disturbed by raids, and martial law was declared by President Lincoln, July 5, 1864. The civil authority was restored by President Johnson on Oct. 18, 1865. In 1869 and in 1870 the legislature refused by a large majority to ratify the 15th amendment to the federal constitution.

**KENTUCKY**, a river of the state of the same name, rising in the Cumberland mountains on the S. E. frontier. Its principal feeders are the North, Middle, and South forks, which unite in Lee co., near the village of Proctor. The stream then takes a N. W. direction to the S. boundary of Fayette co., where it turns S. W. After keeping on this course for 15 or 20 m. it resumes its former direction, and preserves it until it enters the Ohio in Carroll co. Its length from the junction of its head streams

to its mouth is 260 m., but the distance in a straight line between these two points is only 108 m. The scenery on the banks is famous for its romantic beauty. For a great part of its course the river flows between perpendicular limestone rocks, through which it appears to have gradually worn its way. The Kentucky has no large tributaries. It is navigable by means of locks and dams by steamboats 40 m. above Frankfort (62 m. from its mouth), and by flatboats 100 m. higher. Cannel and other kinds of bituminous coal, iron ore, and an excellent variety of marble are found along the banks of the river.

**KENYON, John**, an English poet, born in the island of Jamaica about 1783, died at Cowes, in the isle of Wight, Dec. 3, 1856. His father was a wealthy planter, and he graduated at Peterhouse college, Cambridge. He cultivated the acquaintance of Coleridge, Southey, and Wordsworth, and in 1815 visited Italy and other parts of the continent of Europe. After his return to England he married Miss Caroline Curteis, whom he addresses as "Nea" in the "Verses written in a Churchyard," and whom he survived many years. His first volume of poetry, entitled "A Rhymer's Plea for Tolerance" (1838), was followed in 1838 by "Poems, for the most part Occasional." His last work was entitled "A Day at Tivoli, with other Verses." He used his large fortune with great generosity, and is said to have left legacies to 80 persons, many of whom were his old literary friends, including B. W. Procter (Barry Cornwall) (£6,000) and Mr. and Mrs. Robert Browning (£10,000).

**KENYON, Lloyd**, lord, a British jurist, born at Gredington, Flintshire, Oct. 5, 1732, died in Bath in 1802. He was the son of a Welsh squire, and after a very imperfect education at a free grammar school was articled to an attorney at Nantwich in Cheshire. Being disappointed in his expectation of becoming a partner in the business of his master, he went to London, entered the Middle Temple, and in 1756 was called to the bar. He attended the courts at Westminster regularly, and went the North Welsh circuit, but at the expiration of ten years was so little advanced in professional repute that he was desirous of taking orders. At this juncture Dunning, who had been his fellow student, and who was now in the enjoyment of a lucrative practice, employed him, and opinions written by Kenyon, which Dunning never read, were signed by the latter as his own. As it gradually became known that Dunning's opinions were prepared by Kenyon, the attorneys began to employ him, and cases soon came to him in large numbers. His rise out of his chamber seclusion was probably in consequence of some useful observations which he made as *amicus curiæ* in the presence of Lord Thurlow, then attorney general, who thereafter promoted his advancement in various ways. To this powerful friend he owed his appointment to the chief justiceship of

Chester. The sneers of Kenyon's rivals at this appointment incited his patron to push his fortunes still further. In 1782 he was made attorney general, and two years after master of the rolls. Finally, on the retirement of Lord Mansfield, he was made by Pitt chief justice of the king's bench, with the title of Lord Kenyon, baron of Gredington. This appointment, which he held until his death, was not popular with the bar, and during his whole judicial career he was disliked for his overbearing disposition, and his irritating and even insolent manners. On the other hand, he was in high favor with the public on account of the rigid impartiality of his decisions. He was deeply learned in the law, and successfully resisted Lord Mansfield's attempts to bring about a fusion of law and equity. He accumulated by his professional labors a fortune of £300,000. His memoirs are contained in Lord Campbell's "Lives of the Chief Justices." A new life, by his grandson, George J. Kenyon, the design of which is to free the character of Lord Kenyon from the alleged injustice of Lord Campbell, has been published (London, 1873).

**KENYON COLLEGE.** See GAMBIER.

**KEOKUK**, a S. E. county of Iowa, drained by Skunk river; area, 576 sq. m.; pop. in 1870, 19,484. The surface consists partly of prairie, interspersed with groves of timber, and the soil is generally fertile. The Sigourney branch of the Chicago, Rock Island, and Pacific railroad terminates at the county seat. The chief productions in 1870 were 342,676 bushels of wheat, 1,297,459 of Indian corn, 236,410 of oats, 97,943 of potatoes, 91,718 lbs. of wool, 517,665 of butter, and 35,633 tons of hay. There were 11,253 horses, 21,458 cattle, 27,551 sheep, and 32,325 swine, 11 carriage factories, 2 woollen factories, 3 flour mills, and 9 saw mills. Capital, Sigourney.

**KEOKUK**, a city of Lee co., Iowa, situated in the S. E. corner of the state, at the foot of the lower or Des Moines rapids of the Mississippi, here crossed by a railroad and wagon bridge, and 2 m. above the mouth of the Des Moines, 205 m. above St. Louis, and 185 m. S. E. of Des Moines; pop. in 1850, 2,478; in 1860, 8,136; in 1870, 12,766. It is built partly at the foot and partly on the summit of a bluff 150 ft. high, which contains excellent limestone, and has broad regular streets with many handsome houses. It is the terminus of the Des Moines Valley railroad; and the Toledo, Wabash, and Western, the Toledo, Peoria, and Warsaw, the Chicago, Burlington, and Quincy, the Mississippi Valley and Western, and the Missouri, Iowa, and Nebraska railroads also centre here. The Keokuk and Kansas City and Keokuk and Mt. Pleasant railroads are in course of construction. The rapids in the Mississippi, extending 12 m. with a fall of 24 ft., render Keokuk the natural head of navigation for steamers of the largest class, and furnish abundant water power. The United States is now constructing a canal around them. The city was made

a port of delivery in 1854, and has an important trade. The business of pork packing is carried on to some extent, and there are flouring mills, iron foundries, &c., three banks with an aggregate capital of \$400,000, and a savings bank. The college of physicians and surgeons, established in 1849, in 1872 had 10 professors and instructors and 105 students. The Keokuk library association possesses 7,000 volumes. The public schools, including a high school, are well organized and largely attended. There are two daily and three weekly (one German) newspapers, and 17 churches.

**KEPLER, Johann**, a German astronomer, born at Magstatt, near Weil, Württemberg, Dec. 27, 1571, died in Ratisbon, Nov. 15, 1630. He was a sickly child, and during his whole life suffered periodically from fevers and other ailments. His father, a man of noble origin and at one time a soldier in the Netherlands under the duke of Alva, having been reduced by the loss of his property to the condition of an inn-keeper, young Kepler was during a portion of his childhood employed by him in a menial capacity. In 1586 he entered the monastic school of Maulbronn, whence he was transferred to the university of Tübingen, where in 1591 he took his degree of master. Subsequently he devoted himself to the study of astronomy under Möstlin, a disciple of Copernicus, and in 1594 was called to the professorship of mathematics in the university of Gratz in Styria. Here in the same year appeared his first publication, an almanac for 1595, followed in 1596 by his "Cosmographical Mystery," containing a fanciful theory regulating the order of the heavenly bodies. In 1597 he married a young widow named Barbara Muller von Mulech, and soon after, in consequence of domestic dissensions, and of religious troubles which threatened the safety of the Protestant professors in Gratz, of whom he was one, he accepted Tycho Brahe's invitation to go to Prague and assist him in the preparation of a new set of astronomical tables. The work was done by order of the emperor Rudolph II., who intended to substitute tables having his own name for those calculated on the Ptolemaic and Copernican systems. Tycho shortly afterward died, and Kepler succeeded him as principal mathematician. He was thenceforth constantly involved in pecuniary difficulties, in consequence of the inability or neglect of the emperor to pay him the full amount of his salary. For this reason he was obliged to eke out a subsistence by casting nativities and writing popular almanacs. In his "Principles of Astrology" (1602) he describes the power of certain harmonious configurations of suitable planets to control human impulses. In his day such a belief was regarded as in accordance with just conceptions of the attributes of the planets, and Kepler's most profitable employment at this time was drawing the horoscopes of the princes. In his optical treatise, "A Supplement to Vitellio," published in 1604 at

Prague, although unable to discover the precise law of refraction, he was nevertheless singularly successful in his inquiries respecting vision, and in analyzing the structure of the eye. In this work he also described the mode of calculating eclipses which obtains at the present day. In his subsequent work on optics, entitled "Dioptrics" (Augsburg, 1611; reprinted in London, 1653), which, according to Sir David Brewster, "laid the foundation of the science," he explained the method of tracing the progress of rays through transparent bodies with convex and concave surfaces, and of determining the foci of lenses, and of the relative positions of the images which they form and the objects from which the rays proceed. Hence he was led to describe the astronomical telescope, having two convex lenses, by which objects are seen inverted. These discoveries, however, are obscured by the greatness of those announced in his "New Astronomy, or Commentaries on the Motions of Mars" (Prague, 1609), which were founded on the astronomical data prepared by Tycho. After many fruitless attempts to represent the orbit of Mars by combinations of uniform circular motion (that is, by epicyclic curves), he discovered, by comparing together seven oppositions of that planet, that its orbit is elliptical, whence he concluded that the orbit of each planet is an ellipse, with the sun placed in one of its foci. Having next ascertained the dimensions of the orbit of Mars, he found that the radius vector, or line joining the planet and the sun, described equal areas in equal times, and that the same was true of the other planets. These results constitute the first two of the three great laws of planetary motion known as Kepler's laws, the third of which was discovered nine years later. The labor and patience with which Kepler conducted these investigations will be best appreciated when it is considered that the calculations were made without the assistance of logarithms, which were a later invention, and that each calculation of an opposition of Mars, filling 10 folio pages, was repeated 10 times, so that 7 oppositions produced a folio volume of 700 pages. In view of such difficulties, the remark of Prof. Playfair is particularly pertinent, "that the discoveries of Kepler were secrets extorted from nature by the most profound and laborious research." Notwithstanding the reputation which these brilliant discoveries gained for him, his worldly circumstances showed no signs of improvement. Not only did his arrears of salary remain unpaid, but the emperor Rudolph refused to allow him to accept the professorship of mathematics at Linz; and to add to his embarrassments, his wife died and his children were attacked by the smallpox, which proved fatal to the eldest. At this time also Prague was occupied by Austrian troops, and the plague devastated the city. Upon the accession of the emperor Matthias, in 1612, he was allowed to accept the professorship at Linz, and three years later he

was married for the second time, chiefly for the sake of his children. It has been well remarked by Sir David Brewster, that the narrative of Kepler's search for a wife "is one of the most curious chapters in his history. No fewer than eleven ladies were presented to his choice," his patient scrutiny of their respective claims being comparable with his analysis and successive rejection of the epicyclic theories of Mars. In a jocular letter to Baron Strahlendorf he describes their various characters, and the negotiations preceding his marriage. During the preparations for the wedding, his wine-merchant having incorrectly measured the contents of the wine-casks, Kepler investigated the matter and produced his work on gauging; the first in which the modern analysis is employed. About the same time he presented to the diet at Ratisbon his views on the reformation of the calendar, the substance of which he published in a short essay. In 1616 appeared his *Ephemerides* 1617-1620, the expense attending the preparation of which he confessed he had been obliged to defray "by composing a vile, prophesying almanac, which is scarcely more respectable than begging, unless from its saving the emperor's credit, who abandons me entirely, and would suffer me to perish from hunger." He nevertheless declined an invitation to fill the mathematical chair in Bologna, preferring poverty and the limited degree of freedom of speech and opinion he enjoyed in Germany, to the prospect of bettering his fortune in Italy. Between 1618 and 1622 appeared the seven books of his "Epitome of the Copernican Astronomy," which was placed by the inquisition on the list of prohibited books; and in 1619 he published his "Harmonies of the World," dedicated to James I. of England, which is memorable in the history of science as containing the third of his celebrated laws, viz.: that the squares of the periodic times of the planets are proportional to the cubes of their mean distances from the sun. Such was the transport with which this discovery, which for 17 years had baffled all his skill and patience, filled him, that he marked the day and year. May 15, 1618, when it became known to him; and, speaking of the book which promulgated it, he said: "It may well wait a century for a reader, as God has waited 6,000 years for an observer." The accession in 1619 of the emperor Ferdinand II., who promised to pay the arrears of his salary, and to furnish the means of publishing the Rudolphine tables, seemed to open a more favorable era for the prosecution of Kepler's scientific labors; but such were the drains upon the imperial treasury caused by the religious wars which then began to convulse Germany, that it was not until several years afterward that he was enabled to collect even a part of the sums promised him. In 1620 he was strongly urged by Sir Henry Wotton, the English ambassador at Venice, to take up his residence in England,

but declined the offer. Finally in 1627, after more than a quarter of a century's delay and amid difficulties of all kinds, the Rudolphine tables were published in Ulm. They were the first ever calculated on the theory of the ellipticity of the planetary orbits, and are so remarkable a monument of patience and industry, that had Kepler done nothing more than compute them, he would be regarded as one of the benefactors of science. In 1629, for the sake of avoiding the religious dissensions which distracted Linz, at the invitation of Wallenstein, he removed with his family to Sagan in Silesia, and soon afterward secured a professorship in the university of Rostock. In the following year he went to Ratisbon, and made a final but fruitless effort to obtain from the imperial assembly his arrears, which now amounted to 8,000 crowns. The vexation which this occasioned, combined with fatigue of mind and body, brought on a fever which proved fatal. His remains were interred in St. Peter's churchyard, Ratisbon, and in 1803 a monumental temple to his memory was erected on the spot by the prince bishop of Constance. The following epitaph, composed by himself, was engraved on his tombstone:

Mensus eram celos, nunc terra-metior umbra:  
Mens celestis erat, corporis umbra jacet.

—The ardor and patience with which Kepler pursued science have found few parallels among modern philosophers. Ever prone to indulge in fanciful theories, he never lost sight of the precise object of his search, and ingeniously renounced any hypothesis that he could not reconcile with his advancing knowledge of phenomena. Of his manifold attempts in various branches of science Delambre says: "Those which have failed seem to us only fanciful, while those which have been more fortunate appear sublime." The history of science presents no discoveries more original, or which were deduced with so little assistance from the speculations of preceding philosophers, as his three celebrated laws, from which the discoveries of Newton subsequently sprung, thus completing the great chain of truths which constitute the laws of the planetary system. He computed correctly the transit of Mercury on Nov. 7, 1631 (observed by Gassendi), and announced a transit of Venus in the same year, which was not observed, as it occurred during the night. (Sir David Brewster is mistaken in asserting that "the transit did not take place.") The transit of Venus in 1659 Kepler failed to announce, but that of 1761 he predicted. It is a sufficient evidence of his industry as an author that between 1594 and 1630 he published 33 works, besides leaving 23 volumes of manuscripts, 7 of which contain his epistolary correspondence. The latter was published in 1 vol. fol. in 1718, by Gottlieb Hansch; but the enterprise proving unsuccessful, he was obliged to part with the remaining volumes, which are now in the possession of the imperial

library of sciences in St. Petersburg. A complete edition of the works of Kepler, including all his unedited manuscripts, was published at Frankfort (8 vols., 1858-'70.)

**KEPPEL.** I. *Augustus*, viscount, an English admiral, son of the second earl of Albemarle (a title conferred in 1695 on Arnold Joost van Keppel, lord of Voorst, a Dutch general who accompanied William of Orange to England in 1688), born April 2, 1725, died in Suffolk, Oct. 2, 1786. He entered the navy in 1740 under the auspices of Lord Anson, with whom he circumnavigated the globe. In 1744 he became a post captain, and for many years rendered important services as commander of single ships or of squadrons, being almost uniformly successful in the expeditions he undertook. In 1762 he was made rear admiral of the blue; and in July, 1778, being then admiral of the red, and in command of a large fleet of ships of the line, he had an indecisive conflict with the French squadron under D'Orvilliers off Ushant. The British fleet having hauled off to repair damages, a signal was given by the admiral to renew the battle; but the failure of Sir Hugh Palliser, who commanded the rear, to obey it, enabled the French to escape. Palliser subsequently brought articles of accusation against Keppel, which upon investigation by a court martial were declared unfounded, while the conduct of Keppel was approved. He was subsequently at different times first lord of the admiralty, and in April, 1782, was created Viscount Keppel of Elvedon in Suffolk, having for many years previous been a member of the house of commons. II. *George Thomas*, sixth earl of Albemarle, born June 13, 1799, succeeding his brother, the fifth earl, in 1851. He entered the army, and was at the battle of Waterloo. In 1846 he became one of the secretaries of Lord John Russell, and sat in the house of commons, in the interest of the liberal party, from 1832 to 1835, and again from 1847 to 1851. He has written "Journey from India to England" (2 vols., 1827), "Journey across the Balkan" (2 vols., 1831), and "Memoirs of the Marquess of Rockingham" (1852). III. *Sir Henry*, an admiral, brother of the preceding, born June 14, 1809. He entered the navy at an early age, and was made lieutenant in 1829 and commander in 1833. He commanded one of the vessels of the expedition against China in 1842, and assisted Sir James Brooke in Borneo. He commanded a division of boats at the destruction of the Chinese war fleet in the Fatshan creek, June 1, 1857, for which service he was made a K. C. B. In May, 1860, he was appointed to the Cape of Good Hope as naval commander-in-chief, and was subsequently transferred to the Brazilian station. In 1867 he went to the China and Japan station as vice admiral and commander-in-chief. In 1869 he returned to England on attaining the rank of full admiral, and in the following year he was made D. C. L. of Oxford. He has written "The Expedition to Borneo of H. M. S. Dido"

(3 vols., 1847), and "A Visit to the Indian Archipelago in H. M. S. *Mesander*" (2 vols., 1853), both of which contain extracts from Brooke's diary.—His brother, the Rev. *Thomas Robert Keppel* (born 1817, died 1863), wrote the "Life of Admiral Keppel" (2 vols., 1842).

**KÉRATRY.** I. *Auguste Hilarion de*, a French statesman and author, born in Rennes, Oct. 28, 1769, died in November, 1859. He inherited the title of count, but never used it, and though sympathizing with the revolution was twice arrested. He became a deputy in 1818, and again in 1822 and 1827, and warmly supported liberal measures, publishing vigorous pamphlets against the restoration of the censorship; and he was one of the principal promoters of the overthrow of Charles X. and of the accession of Louis Philippe, who made him a peer in 1837. In 1849 he was once more chosen to the legislative assembly, where he exasperated the radicals by his opening address as the oldest member. He strenuously opposed Louis Napoleon, and was among those who were arrested Dec. 2, 1851, but was soon released. His principal works are: *Inductions morales et philosophiques* (Paris, 1817); *Du beau dans les arts d'imitation* (8 vols., 1822); *Les derniers des Beaumanoir, ou la tour d'Helvin*, a romance (4 vols., 1824); *Du culte, &c.* (1825); *Frédéric Styndall*, a novel (5 vols., 1827); *Saphira, ou Paris et Rome sous l'empire* (8 vols., 1835); and *Une fin de siècle, ou Huit ans* (2 vols., 1840). II. *Emile de*, count, a French politician, son of the preceding, born in Paris, March 20, 1832. He served in Algeria, the Crimea, and Mexico, and retired from the army in 1866. In 1869-'70 he was prominent in the corps législatif as an active opponent of Napoleon, though he approved of the war against Prussia. Subsequently he was successively prefect of police, general under Gambetta for the organization of recruits, and prefect at Toulouse and Marseilles; but his quarrelsome disposition involved him in difficulties almost everywhere. He has published plays and miscellaneous writings, several relating to the Mexican expedition, and has been often connected with periodical literature, and lately with the newspaper *Le Soir*.

**KERGUÉLEN**, or *Desolation Island*, an uninhabited island of the Indian ocean, in about lat. 49° S., lon. 70° E., about 100 m. long and 50 m. wide. It contains many bays and inlets, the most important being Christmas harbor, shaped like a horseshoe and with steep rocks rising in a series of terraces to a height of 1,000 ft. This harbor is at the N. extremity of the island, where the soil is entirely volcanic, and the mountains toward the N. E. and S. W. are from 500 to 2,500 ft. high. Sea fowl abound, but seals, once numerous, have disappeared, and there are no land animals. There is scarcely any vegetation. The British exploring vessel *Challenger* endeavored in vain to effect a landing here in 1874. Kerguelen was selected in that year as one of the Ameri-

can and British stations for the observation of the transit of Venus.

**KERGUÉLEN-TRÉMAREC, Yves Joseph de**, a French navigator, born in Brittany in 1745, died in March, 1797. He early entered the navy, became a lieutenant in 1767, and received command of a frigate sent to protect the fisheries on the coasts of Iceland. Going to Norway for provisions, he sailed N., crossing the parallel of 69° on Aug. 17. In 1769 he had a like commission, and on his return related his adventures to Louis XV. In 1771 he was sent on a southern exploring expedition, and the following year discovered an antarctic territory which he called Kerguelen land. He revisited it in 1774, but was unable because of storms to explore it thoroughly, and on his return home he was accused of misconduct and imprisoned. He was soon released, and afterward served against England. He published accounts of his voyages.

**KERMAN**, or **Kirman**. I. A province of Persia, the ancient Caramania, bounded N. by Khorasan, E. and S. E. by Afghanistan and Beloochistan, S. by the Persian gulf, and S. W. and W. by Laristan and Farsistan; area, 75,730 sq. m.; pop. about 300,000. It is intersected from E. to W. by a mountain chain called Jebel Abad. N. of this chain the country, with the exception of the district of Nurmanshir, is a barren wilderness; S. of it, generally an alpine region of alternate hill and vale. The valleys and some of the plains are fertile, and yield crops of oats, maize, and barley. The white rose is extensively cultivated for its attar, and the mulberry tree for the breeding of silkworms. The chief manufactures are woollen cloths, carpets, goats' and camels' hair shawls, coarse linens, and matchlocks. The most important minerals are iron, copper, and sulphur. The inhabitants of the coast are mostly engaged in fishing, but the pearl fishery, which once employed a considerable portion of them, is no longer prosecuted. II. A city, capital of the province, 345 m. S. E. of Ispahan; pop. about 30,000. It is surrounded by a wall of earth, and has a citadel in which the governor of the province resides. Its bazaars are large and well furnished. It was once the great centre of trade between the Persian gulf and the inland regions; but since the rise of Bushire it has declined. In 1794 it was taken and pillaged by Asa Mohammed Khan, great numbers of its inhabitants being massacred, and 30,000 enslaved by the captors.

**KERMANSHAH**, a town of Persia, capital of a district of the same name in the province of Irak-Ajemi, on the S. W. declivity of a mountain range, 80 m. W. S. W. of Hamadan; pop. about 25,000. It is situated at the edge of a fine plain watered by three considerable streams, which on their junction further south take the name of Kerkha or Kara-su, and discharge into the Shat-el-Arab, N. of Bassorah. It is surrounded by an earthen wall nearly 3 m. in circumference, and is said to be a flourishing

town. In the neighborhood are the rock inscriptions of Behistun. (See *СЪСКРІВЪ ИСКРІПЦІОНЪ*.) The celebrated Persian carpets are manufactured here.

**KERMES INSECT.** See **COCHINEAL**.

**KERMES MINERAL**, a compound of the tersulphide with the teroxide of antimony. The secret of its preparation was purchased in 1729 by the French government and made public. It is prepared either in the dry or wet way by treating the tersulphuret of antimony with carbonated soda or potash. The official process is to boil 1 oz. troy of the pulverized sulphuret of antimony with 23 oz. troy of carbonate of sodium in 16 pints of water for an hour, and after filtering to allow the liquor to cool slowly in an earthen vessel. The kermes subsides in 24 hours. It is then collected on a filter, washed with boiled water, and dried without heat. It is a purplish brown, tasteless powder. Kermes mineral, as containing more oxide, is a more active drug than the precipitated sulphuret. It has been used to produce the depressing action of antimony upon the heart, and has consequently been considered antiphlogistic. It is the active ingredient in what is known as James's powder, the *pulvis antimonialis* of the pharmacopœia. Of late years it has been much less employed than formerly.

**KERN**, a S. county of California; area, 8,000 sq. m.; pop. in 1870, 2,925, including 143 Chinese. It is mostly devoted to grazing. The agricultural and mineral resources are little developed. Some parts are very fertile, but the greater portion is dry and unproductive. It contains the S. terminus of the great valley of California, the junction of the Coast range and Sierra Nevada mountains, and a portion of the desert region E. of the latter. It is watered by several streams, and Kern lake is in the W. part. The chief productions in 1870 were 13,700 bushels of wheat, 3,575 of Indian corn, 26,270 of barley, 6,050 of potatoes, 1,643 tons of hay, and 281,100 lbs. of wool. There were 1,685 horses, 6,373 cattle, 90,200 sheep, and 753 swine; 2 flour mills, 4 saw mills, and 3 quartz mills. Capital, Havilah.

**KERNER**, Andreas Justinus, a German physician, born in Ludwigsburg, Württemberg, Sept. 18, 1786, died at Weinsberg, Feb. 21, 1862. After completing his school education he served an apprenticeship in a cloth factory. In 1804 he went to the university of Tübingen, where he studied medicine and formed an intimacy with the poet Uhland. After some years of preliminary practice he settled in 1818 in the little village of Weinsberg. Some of his lyrics, for which Schumann has written melodies, have attained a popularity scarcely inferior to those of Uhland. The first volumes of his poems were published in 1826 and 1848; another collection at Stuttgart in 1853, entitled *Der letzte Blütenstrauß*; and another in 1859, entitled *Winterblüthen*. He was a close investigator of the phenomena of animal magnetism and somnambulism, and among

the results of his observations is a remarkable book, *Die Seherin von Prevorst* ("The Seeress of Prevorst," Stuttgart, 1829), translated into English by Catharine Crowe, which produced an immense sensation. He wrote a number of other books on the same subject. His novel *Reiseschatten* is considered his best work in prose. Having been obliged in 1851 to resign his profession from a total loss of sight, he received a pension from the king of Württemberg, and also one from the ex-king Louis I. of Bavaria.

**KEROSENE** (from Gr. κηρός, wax), a term originally employed as a trade mark for a mixture of certain liquid hydrocarbons used for purposes of illumination. It has been prepared from bituminous coal, bituminous shales, asphaltums, malthas, wood, rosin, fish oil, and candle tar; but it is now almost exclusively obtained from petroleum. It is produced in greater or less quantity during the destructive distillation, at moderate temperatures, of nearly all organic and mineral substances containing carbon and hydrogen. It has been obtained for commercial purposes in enormous quantities from the petroleum of Pennsylvania, Ohio, West Virginia, Rangoon in India, the Caucasus, and other localities, and in less quantities from the canal coals of England and the United States, the Boghead shale of Scotland, the albertite of New Brunswick, the asphaltum of Trinidad, and common rosin. It has been prepared in small quantities from the malthas of southern California, and from menhaden oil. For the details respecting its preparation from petroleum, see **PETROLEUM PRODUCTS**.—Kerosene consists of a mixture of many hydrocarbons, the whole having the consistence of the essential oils, a burning taste, and aromatic odor. When properly prepared it is nearly colorless by transmitted light, but is slightly opalescent by reflected light. Its density as compared with water should be about .810, or 43° of Baumé's hydrometer. When heated it should not yield inflammable vapors below 110° or 120° F., and should extinguish a lighted match as readily as water at the ordinary temperature of our apartments. As the temperature of this oil in a burning lamp seldom or never exceeds 100° F., it is obvious that such an oil is perfectly safe, as it would never yield any vapor below 110° which, by mingling with the air above the oil in the lamp, could form with it an explosive mixture. Chemically considered, kerosene is a mixture of the less volatile members of the marsh gas series of the hydrides of the alcohol radicals ( $C_nH_{2n+2}$ ), of a second homologous series isomeric with the first, having higher boiling points, together with members of the ethylene or olefiant gas series ( $C_nH_{2n}$ ).—The manufacture of this product as an article of commerce has developed into enormous proportions. Its unsurpassed qualities as an illuminating agent, together with its cheapness when compared with other substances used for that purpose,

has caused it to penetrate to every region whither its transportation is possible. Like many other of the great industries of the world, it has arisen from repeated and very small beginnings. The extraction of oil from bituminous substances, as shales, coals, asphaltum, &c., is no new discovery. The first announcement that oil might be thus procured is contained in the specification of a patent granted in England in 1694 to Martin Eele, Thomas Hancock, and William Portlock, for "a way to extract and make great quantities of pitch, tar, and oyle out of a sort of stone, of which there is a sufficient found within our dominions of England and Wales." The stone proved to be a bituminous shale; but no practical results appear to have followed the discovery and the patent. In 1716 the Messrs. Betton of Shrewsbury patented a process for extracting oil from the black, pitchy, flinty rock commonly found overlying the coal beds. This must have been the bituminous shales; and their method was to grind them to powder and subject the material to destructive distillation. The product was used only as a medicine, and was noticed as such in 1761 in Lewis's "Materia Medica," under the name of British or petroleum oil, "extracted by distillation from a hard bitumen or a kind of stone coal found in Shropshire and other parts of England." The substance and the method of procuring it received occasional notice in the scientific journals; the earliest paper of much interest containing an account of Dr. Clayton's experiments was published in the "Philosophical Transactions" of January, 1789. But it was about 90 years after this before any decided advance was made in adding to our knowledge of the products of the slow distillation of organic bodies. Those products, however, were known only as oily fluids, possessing no interest except as empirical medicines, when Reichenbach of Moravia undertook to investigate their properties, and extended his researches to the great variety of products of the destructive distillation at both high and low temperatures of organic bodies, of animal as well as vegetable origin. The mixture of the several hydrocarbons, such as constitute the purified coal oils, he called eupione (Gr. εἰ, very, and πῶν, fat). He recognized the superior illuminating quality of these oils, and observed that a cheap method of separating them from the tarry residues was alone required to bring them into extensive use for domestic purposes. The great number of new substances which he thus discovered, together with the promise that several among them might be applied to useful purposes, gave great interest to the accounts of his investigations which appeared in the *Journal für Chemie und Physik* of Schweigger-Seidel, the *Neues Jahrbuch der Chemie und Physik*, and Erdmann's *Journal für praktische Chemie*, for 1830-'31. They attracted the attention of scientific and practical chemists in other parts of Europe, some of whom, in France particu-



larly, were already engaged in the extraction of the oils from bituminous substances, a patent for which had been granted in 1824 to the MM. Chervau. In 1832 Blum and Monouse patented the application of these oils to illuminating purposes. The latter had a factory near Autun in the department of Saône-et-Loire for treating the bituminous shales of that district; the chemist Laurent was at this time engaged in conducting the operations, and a year or two afterward was succeeded by Selligie. The papers published by these chemists, and especially the specifications of the patents taken out by the latter from 1834 to 1845, published in the *Brevets d'invention*, present full details of the operations, which they had already brought to such a state of perfection that the subsequent improvements introduced consisted merely in comparatively unimportant modifications of the apparatus employed. Up to the year 1861 no treatise upon the subject had appeared at all comparable to that in the specification of the patent of March 19, 1845 (*Brevets d'invention*, new series, iv. 30). Of this an English translation is recorded in the specification of the patent of Du Buisson, No. 10,726 of the English patent office. (See also a paper on the history of this manufacture by F. H. Storer, in the "American Journal of Science," vol. xxx., pp. 121 and 254, 1860.) In this specification Selligie describes first the apparatus employed in the distillation, in one form of which he makes use of superheated steam. The products of the distillation are then enumerated, which were as follows: 1, a very limpid whitish volatile oil, almost without odor, useful as a solvent or for illumination in suitable lamps, and sometimes known as naphtha; 2, a straw-colored oil, somewhat volatile, of specific gravity 0.84 to 0.87, almost odorless, and suitable for burning in lamps in which the oil is kept at the same level, and which are provided with a double current of air, with a chimney, and proper burner; 3, a heavier oil adapted for lubricating machinery; 4, a red coloring matter extracted from the different varieties of the oils; 5, paraffine; 6, a grease for lubricating machinery, being evidently a mixture of paraffine in little oil; 7, a black pitch, the residue of the distillation, suitable for coating wood, metals, &c., for their preservation; 8, an alkaline soap prepared by treating the oil with alkalis; 9, sulphate of ammonia; 10, fertilizing mixtures prepared with the ammoniacal liquors; 11, sulphate of alumina. The crude oil obtained from his retorts, which were like those of the gas works, he treated either before or after its being redistilled with a quantity of acid (sulphuric, muriatic, or nitric), and caused the mixture to be thoroughly agitated. This operation being continued for some time, the tarry matters were partially freed from the oil, and on the mixture being left to repose they subsided with the acid, so that the purified oil could be drawn off from the top, bringing with it but little of the acid.

This was neutralized by addition of an alkali, as the lye of soap boilers, and after the mixture had been well agitated again, more or less coloring matter subsided, from which the oils were separated by decanting again and redistilling. By a series of fractional distillations the several sorts of light oils were obtained in a pure state.—In 1846 Abraham Gesner made oil from coal in Prince Edward island, and was the first to give it the name kerosene. In England the establishment of the coal-oil manufacture was due to the enterprise of James Young of Glasgow. In 1847 his attention was directed to the extraction of a lubricating oil from petroleum, which exuded from a coal mine in Derbyshire; and having exhausted the supply of this, he next applied to the same purpose the Torbanehill mineral or Boghead cannel, a material which was first ascertained in 1850 to possess an unusual proportion of bitumen, and to be capable of affording large quantities of gas. Mr. Young found it still better adapted for the manufacture of oil, and succeeded so well that in 1854, as he testified in a lawsuit for establishing his patent, his production of oil amounted to about 8,000 gallons a week, which sold for 5s. a gallon. For the year the sales reached about £100,000, a large proportion of which was profit. Such success soon led others to undertake the manufacture, and coal-oil works rapidly increased in England, and were introduced into the United States. The first factory of the kind in this country was that of the kerosene oil company, on Newtown creek, Long Island, opposite the upper part of New York city, which went into operation in June, 1854. It was designed to work the Boghead cannel or other materials of similar character that might be brought to New York from New Brunswick or Nova Scotia, or from the western coal mines; and the operations were to be conducted under the patent of Mr. Young, granted to him in this country as well as in England, for the exclusive use of coal for this manufacture. His claim, however, was not recognized at other works of later date in the United States, and was never enforced. In 1856 the Breckenridge coal-oil works at Cloverport, Ky., on the Ohio river, were producing oil from the cannel coal of the vicinity, which somewhat resembled the Boghead cannel in appearance and in its rich bituminous character; and the same year a factory was built in Perry co., Ohio. The cannel coals of this region proving to be well adapted for this application, several other factories were soon constructed, particularly in the vicinity of Newark, Licking co., Canfield, Mahoning co., and in Coshocton co.; and at the close of the year 1860 the total number in Ohio was probably not less than 25, and there were also many in other states. The processes pursued in the different works were essentially the same. The only distinctions of importance were in the forms of the apparatus, and particularly in the retorts. The common form in

use for some time was that of the gas retort, long cast-iron boxes, with an opening at the end that projected from the furnace in which they were set, and shaped in their section like the letter  $\Omega$ . Others were made of cylindrical form, were set upright in the furnace, made to be charged at the top and discharged at the bottom, and furnished with exit pipes for the volatile products either at the top or at different heights. Earthenware retorts were substituted in some works for those of cast iron, as in the manufacture of gas. In the use of all of them a loss resulted from the unequal degree in which portions of the charge were heated, a part being rapidly overheated so as to produce gaseous matters, while other parts were acquiring the heat necessary for the generation of the oily products. This defect was however corrected by means of a revolving retort which was invented in France, and which produced a more uniform distribution of heat. Methods of distillation were also in use by which an external fire was dispensed with, and the heat required for the expulsion of the volatile matters was produced by the combustion of a portion of the material, as in the process of making charcoal. Near Wheeling, Va., this plan was in operation, the coal being collected in pits of 100 tons' charge, and covered with earth. Other forms of kiln were in use, but as the process of obtaining kerosene from coal is abandoned, more than the above notice is superfluous. In 1860 the establishments on the Atlantic coast alone produced about 200,000 barrels. At that date, according to the census returns, the total value of all the kerosene produced in the country was estimated at \$2,142,693. The marvellous production of petroleum during the years immediately following led to the abandonment of coal as a crude material. Those establishments then using coal rapidly changed to petroleum refineries, and many new refineries were erected at different points. (See PETROLEUM PRODUCTS.)

**KERR**, a S. W. county of Texas, watered by Guadalupe and Medina rivers; area, 818 sq. m.; pop. in 1870, 1,042, of whom 90 were colored. The surface is diversified, and much of the soil of superior quality. The chief productions in 1870 were 45,781 bushels of Indian corn, 10,963 lbs. of wool, 19,095 of butter, and 236 tons of hay. There were 486 horses, 2,511 milch cows, 10,128 other cattle, 4,848 sheep, and 2,620 swine. Capital, Kerrsville.

**KERRY**, a S. W. county of Ireland, in the province of Munster, bordering on the Atlantic, the estuary of the Shannon, and the counties Limerick and Cork; area, 1,811 sq. m.; pop. in 1871, 196,014, of whom a considerable proportion speak only the Irish tongue. The coast is much indented with bays and inlets, the principal being Brandon, Valentia, Kenmare, Dingle, Tarbert, and Tralee bays. Numerous small islands lie off the coast. The chief rivers are the Feale, Maine, Laune, and Roughty. Many beautiful lakes are hid-

den among the hills, including the famous lakes of Killarney, the two lakes of Carra, Currane, Derryana, and Lanan, and the Devil's Punch Bowl, near the summit of Mangerton. The surface in the north is open and undulating, in the southwest wild and mountainous. Carn Tual, the highest mountain in Ireland, is 3,414 ft., and several others are 2,000 and 3,000 ft. Minerals have been but partially explored, yet copper, marble, and roofing slate are worked, and lead and iron are known to exist. Agriculture is in a backward condition. The soil is inferior, except in the central lowlands, where it is a rich loam, resting on limestone. The climate is the mildest in Ireland. The fisheries of the Kerry coast are important. The chief towns are Tralee, Killarney, Dingle, Listowel, Caherciveen, and Kenmare.

**KERSHAW**, a N. county of South Carolina, drained by Wateree river; area, 776 sq. m.; pop. in 1870, 11,754, of whom 7,945 were colored. It has a hilly surface. The soil of the uplands is sandy, but susceptible of profitable cultivation, and the river bottoms are remarkably fertile. The Camden branch of the South Carolina railroad terminates at the county seat. The chief productions in 1870 were 6,889 bushels of wheat, 108,420 of Indian corn, 11,161 of peas and beans, 16,595 of sweet potatoes, 4,161 bales of cotton, and 30,530 lbs. of rice. There were 501 horses, 651 mules and asses, 1,432 milch cows, 2,214 other cattle, 1,247 sheep, and 4,224 swine. Capital, Camden.

**KERTCH** (anc. *Panticapæum* or *Bosporus*), a city of Russia, in the Crimea, on the strait of its name or of Yenikale, commanding the entrance to the sea of Azov, lat. 45° 20' N., lon. 36° 28' E., 112 m. E. N. E. of Simferopol; pop. in 1867, 19,616. The place as it now stands is of recent date. It is handsomely built of stone, with wide and regular streets. It has been a free port since 1822, and is rapidly growing. The inhabitants are mostly engaged in commerce. The exports are building stone, soap, candles, salt in large quantities, and herring and sturgeon, the produce of the coast fisheries. The government has a foundery and ship yard here. The harbor is good, and is fortified.—Panticapæum, the capital of the ancient kingdom of Bosporus, was founded by Milesians in the 6th century B. C., and was annexed to Rome by Pompey, 63 B. C. The Huns seized it about 375, and the Genoese in 1280. They were compelled to abandon it by the Turks in 1475. These were displaced by the Russians in 1771, to whom the place was formally ceded in 1792. It surrendered to the allied forces of France and England May 25, 1855, and was restored to Russia by the treaty of Paris, March 30, 1856. Kertch is still called Bospor (Vosfor) by the inhabitants of the Crimea. In the Italian charts of the middle ages it is called Pandico or Pondico, as well as Bospro or Vospro. Foundations of ancient buildings and heaps of brick and pottery are still scattered over the hill of Mithridates, on

which Panticapæum was situated, and at the foot of which Kertch now stands. Among the



Kertch

numerous tumuli in the vicinity, the most extraordinary are those situated at the mountain called by the Tartars Altun-Obo. One of these is 165 ft. in diameter; a vestibule 6 ft. square leads into a tomb 15 ft. long and 14 ft. broad, which formerly contained the bones of a king and queen, golden and silver vases, and other ornaments. Below this tomb is another, and from the two 120 lbs. of gold ornaments are said to have been carried away at the conquest of the place by the allies in 1855. It is supposed that it was erected not later than the 4th century B. C.

**KESTREL**, a European falcon, of the genus *tinnunculus* (Vieill.), much resembling the

Kestrel (*Tinnunculus alaudarius*).

American sparrow hawk. This bird (*T. alaudarius*, Briss.) has the form and proportions of

the falcons proper, except that the tarsi are longer and the toes

less stout. The length is about 14 in., and the extent of wings 28, the female being a little larger than this; the closed wings are about 2 in. shorter than the tail. In the male the general color above is light grayish blue, the back and wing coverts pale red with triangular dark spots; the tail with a subterminal broad black bar; the lower parts light yellowish red, with long longitudinal dark lines and spots. In the female, the upper parts are light red, with transverse dark bars and spots; the young resemble the female. The kestrel hovers in search of prey at a height of 30 or 40 ft. from which it pounces upon small birds, mice,

moles, reptiles, and sometimes worms and beetles, which it finds in the open fields; from its peculiar manner of hovering, it has received the popular name of wind-hover; it occasionally pursues birds in open flight. When not in search of food, the flight is high, with rapid flaps and occasional sailings. Silent when hovering after prey, it is very noisy in the breeding season; it breeds on cliffs near the sea, in trees in the woods, in ruined buildings or high towers in towns, and in the deserted nests of the crow family; the eggs, three to five, are reddish white, with irregular dots and patches of dull brownish red. This is one of the most common birds of prey in Great Britain, in almost all districts except the interior heaths. When taken from the nest, kestrels may be trained to pursue quails, snipes, larks, and birds of similar size. Their numbers are greatly diminished during winter, and they are said to migrate to northern Africa. Though persecuted by gamekeepers often for the sake of the sparrow hawk, it is of positive benefit to man by destroying great numbers of mice. It is found throughout Europe. There is a smaller kestrel (*T. cucullaria*, Naum.), with longer wings, fewer spots, in eastern and southern Europe. The kestrel swallows small mammals whole, but removes the feathers from its bird prey. There is considerable variation in the plumage.

**KESWICK**, a market town of Cumberland, England, on the S. bank of the Greta, 23 m. S. S. W. of Carlisle; pop. in 1871, 2,777. It is well built, contains two museums, chiefly of minerals, and has manufactures of linsey-woolsey stuffs, cutlery, and black-lead pencils. Lying within one mile of the foot of Skiddaw and half a mile from Derwentwater, it is much resorted to by tourists, for whose accom-

modation there are several hotels. The vale of Keswick is renowned for its picturesque scenery, in respect to which it is surpassed by few spots in England. Greta Hall, formerly the residence of Southey, is near the town.

**KETONES**, or *Acetones*, a class of bodies composed of an acid radical united with an alcohol radical. Nearly all the ketones now known consist of the radical of a fatty acid combined with one of the corresponding alcohol radicals, their general formula being  $C_nH_{2n+1}$  and  $C_nH_{2n-1}O$ , where  $m$  may be either greater or less than  $n$ . When  $m=0$ , the ketone becomes an aldehyde,  $H \cdot C_nH_{2n-1}O = C_nH_{2n}O$ ; the ketones may be therefore regarded as aldehydes in which one atom of hydrogen is replaced by an alcohol radical. Ketones are either simple or compound. In the simple,  $m=n-1$ , so that their general formula is  $C_{n-1}H_{2n-1}$ ,  $C_nH_{2n-1}O = C_{n-1}H_{2n-2}O$ . Acetic or common acetone, or methyl acetyle, where  $n=2$ , is  $OH \cdot C_2H_5O$ . Both the simple ketones are produced by heating the barium or calcium salts of the fatty acids, whereby two atoms of the salt are decomposed in such a manner that the acid radical of one of them is resolved into the next lowest alcohol radical and carbonyl.

**KETTLER**, Wilhelm Emanuel von, baron, a German prelate, born in Münster, Westphalia, Dec. 25, 1811. After studying law and being engaged in the civil service at Münster for several years, he qualified himself for the priesthood, was ordained June 1, 1844, and became chaplain at Bockum, and in 1846 curate at Hopsten. In 1848, as a member of the Frankfort parliament, he delivered a remarkable speech at the funeral of Liehnowsky and Auerswald, who had been murdered by the mob, Sept. 18, and advocated during the debates on the constitution the independence of the church from the state. In 1849 he was made provost of the Berlin Hedwigskirche, and next year bishop of Mentz. He became known as a most enterprising ultramontanist, founded various institutions and religious orders and communities with the view of controlling education and charitable works, and exerted himself for the protection of Roman Catholic interests in the ecclesiastical province of the Upper Rhine and in Germany generally. With the support of the Roman Catholic grand duchess of Hesse-Darmstadt and the prime minister Dalwigk, he secured, in virtue of a secret convention of Aug. 23, 1854, special prerogatives for his diocese; and although this conven-

tion was subsequently abrogated, he retained these privileges, even after the overthrow of the Dalwigk cabinet in 1871. After having opened an asylum for the Jesuits, and identified himself with the most extreme ultramontane measures, he surprised the world by questioning the expediency of the declaration of papal infallibility, though he sympathized with the principle of the dogma; but as soon as the decrees of the Vatican were passed, he united with other bishops in submitting to them. He was elected in 1871 to the first German Reichstag, and became the ablest ultramontane leader in that assembly. His principal works are: *Das Recht und der Rechtsschutz der Katholischen Kirche in Deutschland* (5th ed., 1854); *Freiheit, Autorität und Kirche* (7th ed., 1862); *Die Arbeiterfrage und das Christenthum* (3d ed., 1864); *Deutschland nach dem Kriege von 1866* (6th ed., 1867); *Die wahren Grundlagen des religiösen Friedens* (3d ed., 1868); *Das allgemeine Concil und seine Bedeutung für unsere Zeit* (5th ed., 1869); and *Die Anschauungen des Cultusministers Herrn Dr. Falk über die Katholische Kirche, nach dessen Rede vom 10. December, 1873* (1874).

**KEW**, a village and parish of Surrey, England, on the S. bank of the Thames, 7 m. S. W. of St. Paul's, London, famous for the royal botanic gardens, the richest in the world, comprising 75 acres, and open gratuitously to the public daily, including Sunday. They contain a palm house 362 ft. long, 100 ft. wide, and



The Museum at Kew.

64 ft. high, houses for cacti, tanks for the *Victoria regia* water lily, and a most extensive collection of Australian trees and plants. The old palace of Kew was the residence of George III. and his family. The surrounding pleasure grounds cover an extent of 245 acres, tastefully laid out. The observatory is chiefly used as a meteorological station.

**KEWAUNEE**, an E. county of Wisconsin, bordering on Lake Michigan and drained by Kewaunee and Red rivers; area, 360 sq. m.; pop. in 1870, 10,128. It has a rolling surface and a fertile soil, and is well wooded. The chief productions in 1870 were 120,065 bushels of wheat, 21,123 of rye, 73,554 of oats, 58,866 of potatoes, 20,636 of peas and beans, 124,091 lbs. of butter, and 5,110 tons of hay. There were 842 horses, 2,407 milch cows, 1,040 working oxen, 2,582 other cattle, 1,546 sheep, and 3,865 swine; 3 breweries, 5 flour mills, and 10 saw mills. Capital, Kewaunee.

**KEWEENAW**, a N. W. county of the upper peninsula of Michigan, occupying the extremity of Keweenaw point, which is surrounded by Lake Superior on all sides except the S. W., and including Isle Royale; area, about 575 sq. m.; pop. in 1870, 4,205. The surface is hilly, and near the centre mountainous. Sandstone underlies a portion of it. It is productive of copper, and mining is the principal occupation of the people. In 1870 there were 6 mines, producing to the value of \$823,447, 6 quartz mills, and a manufactory of explosives and fireworks. In 1872 the yield was 1,836 tons of ore. Capital, Eagle River.

**KEWKIANG**, or **Klukiang**, a town of China, in the province of Kiangsi, on the Yangtse, near the N. end of Lake Poyang, 227 m. S. W. of Nanking. It takes its name from the nine rivers which flow from the adjacent mountains. This situation, commanding the trade of Lake Poyang, induced Lord Elgin in 1860 to propose the place as an open port, it being the nearest outlet of the green tea district, of which the export rose in 1868 to 9,000,000 lbs., and of black tea to nearly twice as much. The shipments subsequently declined considerably, and the total exports in 1871 did not exceed the value of \$4,000,000, the imports, however, reaching \$12,000,000. The town suffered greatly from the Taiping rebellion, and was almost entirely destroyed when it was recaptured by the imperial troops; but it soon recovered. The overflow of the Yangtse in several consecutive seasons had filled the place in 1870 with fugitives from inundated districts, and with vagabonds and Mohammedan fanatics, who destroyed missionary chapels, but were put down with the aid of war vessels. The British settlement fronts the river, and the remains of the Chinese town are back of it, with a new temple built by the emperor, containing a memorial of a general who fell in the siege. The American house of Russell and co. maintains here a fine fleet of river steamers, and controls the carrying trade on the Yangtse and on Lake Poyang. The shipping in 1871 comprised 320 American and 92 English steamers, and 23 American and 65 English sailing vessels. Kewkiang is only a subsidiary port of Shanghai, and the navigation is liable to be impeded by low water and sand bars, requiring the transshipment of cargoes at Hukow, 16 m. below Kewkiang, at the mouth of Lake Poyang.

**KEY, Francis Scott**, an American poet, born in Frederick co., Md., Aug. 1, 1779, died in Baltimore, Jan. 11, 1843. He was educated at St. John's college, Annapolis, and commenced the practice of the law in Frederick City. Subsequently he removed to Washington, where he was for many years district attorney of the District of Columbia. As a song writer he is chiefly known by "The Star-Spangled Banner," a popular national lyric, suggested and partially written while the author was detained in the British fleet during the bombardment of Fort M'Henry, near Baltimore, of which he was an anxious and interested witness. A collection of his poems was published in New York in 1857. In 1874 James Lick of San Francisco gave \$150,000 for a monument to Key in that city.

**KEY, Thomas Hewitt**, an English scholar and educator, born in Southwark, March 20, 1779. He graduated at Trinity college, Cambridge, in 1821, and for two or three years was engaged in studying medicine in Guy's hospital, London. In 1824 he accepted the professorship of mathematics in the university of Virginia, but, the climate not agreeing with his health, he returned to England in 1827. The next year, on the founding of the university of London, he was elected to the chair of Latin, and held the post for 13 years. He then became head master of the school in the university, and professor of comparative grammar, which positions he still occupies (1874). He has contributed largely to philological literature in the way of reviews, pamphlets, essays, &c.; he had a spicy controversy with Donaldson in regard to the latter's "Varronianus;" and he was engaged for many years on a new and full "Latin-English Lexicon." He has also published a "Latin Grammar" (1843-'6), "Philological Essays" (1868), and "Language, its Origin and Development" (1874).

**KEY ISLANDS**, or **KL**, a group of islands in the Indian archipelago, 50 m. W. of the Arrau islands, in lat. 6° S., lon. 133° E. The largest are the Great Keys, with mountains 3,000 ft. high, which are supposed to contain gold. Little Key and other smaller islands are level and fertile. Along the coast is a mixture of races, the Malays predominating. The interior is inhabited by the Haraforas, who are laborious agriculturists. The islands are annually visited by coasting vessels from the Moluccas and other islands for the shipment of tortoise shell, birds' nests, and other products. The Dutch resident at Amboyna occasionally superintends the affairs of the islands, though they are virtually independent. They were explored in 1870 by the Italian navigator Cerrette.

**KEYSER, Nealse de**, a Belgian painter, born in Sandvliet, province of Antwerp, in 1813. He is the son of a peasant, and was enabled by the generosity of a lady who recognized his talents to pursue his studies at the academy in Antwerp. His first picture was a "Christ on the Cross," painted in 1834, for a Roman

Catholic church in Manchester, England. His works consist chiefly of battle pieces and historical subjects.

**KEYS OF FLORIDA.** See **FLORIDA KEYS.**

**KEY WEST** (Sp. *Cayo Hueso*, Bone Key). I. An island forming part of Monroe co., Florida, one of the Florida Keys, 60 m. S. W. of Cape Sable, the S. point of the state; pop. in 1850, 2,367; in 1860, 2,832; in 1870, 5,016, of whom 989 were colored and 2,288 foreigners; in 1874, about 7,000. It is 7 m. long by from 1 to 2 m. wide, and is 11 ft. above the sea. On the S. W. point there is a lighthouse with a fixed light 72 ft. above the water, guiding vessels to the city, and another on the N. W. passage, showing a fixed light, 40 ft. above the water. The island is of coral formation, and has a shallow soil, consisting of disintegrated coral with a slight admixture of decayed vegetable matter. There

are no springs, and the inhabitants are dependent on rain or distillation for water. Adjacent to the city is a salt pond, where the greater part of the salt used on the island is manufactured, and considerable quantities are shipped to neighboring keys and the mainland. The natural growth is a dense but stunted chaparral, in which various species of cactus are a prominent feature. Tropical fruits are cultivated to some extent, the chief varieties being coconuts, bananas, pineapples, guavas, sapodillas, and a few oranges. The air is pure and the climate healthy. The thermometer seldom rises above 90°, and never falls to freezing point, rarely standing as low as 50°. The island has suffered repeatedly from violent hurricanes. Excepting the Cubans, a large proportion of the population of Key West consists of natives or descendants of natives of the Bahama islands.



Key West.

They are a hardy and adventurous race, remarkable for their skill in diving. The language commonly spoken is Spanish or a patois of that tongue. II. A city, port of entry, and United States naval station, occupying about three eighths of the island, capital of Monroe co., Florida, and the southernmost town of the United States, 430 m. S. by E. of Tallahassee, and 110 m. N. by E. of Havana; lat. 24° 32' N., lon. 81° 48' W.; pop. about 5,000. The streets are broad, and for the most part are laid out at right angles with each other. The residences are shaded with tropical trees, and embowered in perennial flowers and shrubbery, giving the city a very picturesque appearance. The buildings, however, are mostly small, and are constructed of wood, except the Western Union telegraph office, those belonging to the United States government, and one other, which are

of brick. The public buildings are the custom house, naval storehouse, marine hospital, county court house, county jail, a masonic hall, an opera house, and a hotel capable of accommodating from 50 to 75 guests. Another hotel, to accommodate 200, is about to be erected. The United States court house, the post office, and the city hall occupy leased buildings. Near the naval storehouse is a monument of dark gray granite, erected in 1866 to the memory of the sailors and soldiers who died in the service on this station during the civil war. Key West has a fine harbor, accessible through several channels by vessels drawing 22 ft. of water. Being the key to the best entrance to the gulf of Mexico, it is strongly fortified. The principal work of defence is Fort Taylor, built on an artificial island within the main entrance to the harbor. It has 120 guns mounted and

40 more ready for mounting; but work upon the brick and stone batteries or forts that were projected has been suspended, and sand batteries are in process of construction. The barracks are large and commodious, and are garrisoned by 60 men. There is a United States dock, with cisterns to catch rain water, a condensing and distilling apparatus, and a machine shop and foundery. Key West is connected with New York and New Orleans by weekly lines of steamers, and with Baltimore by a semi-monthly line. The New Orleans line also connects the city with Cedar Keys, the gulf terminus of the Florida railroad, and with Havana. There are telegraph cables to Cuba and to the mainland. The value of the imports from foreign countries for the year ending June 30, 1873, was \$389,054; exports to foreign ports, \$939,880; the number of vessels entered was 384, with an aggregate tonnage of 68,828; cleared, 383, of 58,661 tons. In the coastwise trade the entrances were 337, of 201,942 tons; clearances, 278, of 198,517 tons; belonging to the port, 103 vessels, with an aggregate tonnage of 3,374. Among the principal industries are turling, sponging, and the catching of mullet and other fish for the Cuban market. The value of sponges annually obtained is about \$100,000. About 30 vessels with an aggregate of 250 men are engaged in wrecking on the Florida reef. The manufacture of cigars employs about 775 hands, chiefly Cubans. About 25,000,000 cigars are manufactured annually. An establishment for canning pineapples is in successful operation. The value of real estate and improvements on the island in 1874 was \$2,600,000. The city is governed by a mayor and a board of nine aldermen elected annually. The United States courts for the S. district of Florida are held here. There are two public schools for white children, with 500 pupils, and one for colored children, with 198 pupils. The Catholic convent has a school connected with it, and there are eight private schools, containing in all 225 pupils. Two weekly newspapers (one Spanish) are published. The city has Baptist, Episcopal, Methodist, and Roman Catholic churches.—Key West was settled about 1822, but it long remained a mere village. During the civil war the attention of the government was more particularly directed to it.

**KHAN**, a Tartar word, signifying sovereign or chief. It is used by sovereign princes in all the Tartar countries, and is one of the titles of the Turkish sultan. The title khan is given in Persia to officers of various grades, but is generally expressive of high rank, and is especially applied to the chiefs of the nomad tribes of that country.—Khan is also the Turkish word for caravan-ary or hotel. These edifices are very numerous in Constantinople. They are commonly in the form of a square, with an interior court surrounded by three ranges of galleries, one above another, from which open small unfurnished chambers which travellers occupy without charge. Some have been

founded by private individuals, but they have mostly been built at the expense of the sultana.

**KHANDEISH**. See CANDEISH.

**KHANIA**. See CANEA.

**KHANPOOR**, or *Khanpoor*, a town of N. W. Hindostan, in the native state and 89 m. S. S. W. of the city of Bhawalpoor; pop. about 10,000. It is connected with the Indus, about 50 m. distant, by a navigable canal, and though once of considerable importance, it contains only a few houses of brick, a spacious bazaar, and a slightly mosque. There is also a ruinous mud fort. Between the town and the Indus the land is fertile, and the district very populous, but to the east and south lies a desert.

**KHARESM**, or *Khorasana*, in the middle ages a designation of the khanate of Khiva, and in more recent times of the central portion of it. According to eastern legends, Kai Khoru in pursuit of the army of Turan, crossing the Oxus and beholding the field of battle, exclaimed, *Kharesemibud*, "I have my desire," and the plain has ever since been called Kharesem. The name of its inhabitants seems, however, to be identical with that of the ancient Chorasmi or Chorasmsini mentioned by Herodotus, Strabo, Pliny, and others. During the middle ages Kharesem was for a time subject to the Seljuks, and subsequently formed an independent kingdom, and the Kharemsians were formidable enemies to the Persians until both peoples were conquered by Genghis Khan. An invasion of Syria by a horde of Kharemsians (Carizmians, or Corasmians), flying from the Mongols, about 1242, is related by the chroniclers of the crusades, and also by the Arabian historians.

**KHARKOV**. I. A S. government of European Russia, in the province of Ukraine, bordering on Kursk, Voronezh, the land of the Don Cossacks, Yekaterinoslav, and Poltava; area 21,016 sq. m.; pop. in 1867, 1,681,486. It has an elevated but flat and monotonous surface, partly covered with forests, and a fertile soil, which is generally loamy and here and there sandy. It is traversed by the Donetz, the Bekol, its chief tributary from the north, and tributaries of the Dnieper. None of these are navigable for any considerable distance. The chief vegetable productions are the various species of grain, flax, hemp, tobacco, hops, and potatoes. Besides agriculture, the rearing of cattle (which are excellent), horses, and bees forms the principal occupation of the inhabitants, who are for the most part Little-Russians and Cossacks. The principal towns are Kharkov, Akhtyrka, and Bogodukhor. II. A city, capital of the government, situated at the confluence of two small affluents of the Donetz, and at the junction of railway lines to Moscow, Odessa, and Taganrog, 400 m. S. by W. of Moscow; pop. in 1867, 59,968. It is mostly built of wood, but contains a cathedral, many churches, two convents, and a theatre; a university founded in 1804, with a botanical garden, museum, and a library of 20,000 volumes;

and numerous other educational institutions. The manufactures of Kharkov consist chiefly in felt hats, carpets, soap, brandy, and leather. The winter fairs are numerously attended by traders from all parts of the empire. It is the see of an archbishop.

**KHARTOOM**, a town of Sennaar, Africa, the centre of government of Egyptian Soudan, situated on the banks of the Bahr el-Azrek or Blue Nile, nearly at its junction with the White Nile; lat. 15° 36' N., lon. 32° 38' E.; pop. about 20,000. It is about 1,450 ft. above the sea, but the inundations of the White Nile frequently reach the earthen wall by which it is surrounded. The houses are mostly constructed of millet stalks, and scattered over a wide area; but the town has recently been much altered. Dr. Schweinfurth, on his return from his expedition into the heart of Africa in 1871, saw in it "a large number of



Khartoum.

new brick buildings, a spacious quay on the banks of the Blue Nile, and some still more imposing erections on the other side of the river." There are extensive gardens and rows of date palms planted nearly half a century ago. The defective drainage of the portion of the town built below high-water level renders it very unhealthy. The inhabitants are a mixture of Egyptians, Berbers, Arabs, Turks, Jews, Europeans, and negroes. They have a Coptic church, and a Catholic mission. Khartoum carries on an extensive ivory trade, mostly in the hands of six of the larger merchants, which facilitates also the operations of the regular slave traders, who pour into the negro countries annually by thousands, on the roads over Kordofan and Darfour. The merchants of Khartoum maintain a great number of settlements in districts as near as possible to the present ivory countries, and among peaceful races devoted to agriculture. They have ap-

portioned the surrounding territory among themselves, and have brought the natives to a condition of vassalage. They are represented by agents who command the armed men of the country, determine what products the natives shall pay as tribute, appoint and displace the local managers, carry on war or make alliances with the chiefs, and once a year remit the collected stores to Khartoum. Vessels are built of *Sunt acacia*, a wood harder and heavier than oak, but from want of skill and proper tools they are exceedingly clumsy.

**KHEMNITZER.** See CHEMNITZER.

**KHERASKOFF, Mikhail**, a Russian poet, born Oct. 25, 1733, died in Moscow, Sept. 27, 1807. He served in the army, and was at one time director of the Moscow university. He was a copious writer in prose and poetry; but he is now remembered only as the author of the "Rossiad" (Moscow, 1785), an epic in 12 cantos on the conquest of Kazan by Ivan the Terrible; and of the "Vladimir" (Moscow, 1786), in 18 cantos, on the conversion to Christianity of the czar of that name.

**KHERSON, or Cherson. I.**

A S. government of European Russia, bordering on the governments of Kiev, Poltava, Yekaterinoslav, and Taurida, the Black sea, and Bessarabia; area, 27,475 sq. m.; pop. in 1867, 1,497,995, consisting of Russians, Cossacks, Poles, Bulgarians, Tartars, Greeks, Armenians, Jews, gypsies, and many foreign settlers, mainly Germans, who form a large number of colonies. With the exception of the N. W. and N. E. borders, where there

is some wood, and some extensive forests in the neighborhood of Elisabethgrad, the whole country consists of an immense plain with but few trees. The soil, however, is covered with grasses and other plants, and produces in the interior rich pastures. The principal rivers are the Dnieper, the Bog, and the Dniester. Wild animals are very numerous, especially wolves and wild cats. The most common tame animal is the sheep. Oxen and buffaloes are numerous and used for draught; the horses (of which many are wild) are spirited and noted for their swiftness. The fisheries are important, especially in the Dniester. The minerals are freestone, slate, chalk, talc, saltpetre, agates, and garnets. The northern part of the government possesses many distilleries and tallow manufactories; rope walks and tile works are scattered all over the country, and much linen is manufactured. The products are wheat, hemp, flax, tobacco, mustard, saffron, and wine.



The chief seat of manufacture as well as of trade is Odessa. II. A city, capital of the government, situated at the head of the embouchure of the Dnieper, 50 m. E. of the Black



Kherson.

sea, and 90 m. E. by N. of Odessa; pop. in 1867, 45,926. It is divided into four quarters, and is the seat of the provincial government and of several learned institutions. Kherson was founded in 1778 by Potemkin, whose tomb is in the cathedral, and was destined by Catharine II. to become the southern St. Petersburg of the empire. But the bad climate of the town has proved unfavorable to its growth, and the vicinity of Odessa has still more contributed to reduce its importance. The imperial dockyards have been removed to Nikolayev. The small amount of trade of the town is almost entirely in the hands of the Greeks. John Howard the philanthropist died in Kherson, and a monument was dedicated to his honor by Alexander I.

**KHIVA.** I. A khanate of Independent Turkistan, central Asia, between lat. 36° and 44° N., and lon. 51° and 62° 30' E., bounded N. W. and N. by Russia, N. E. and E. by Bokhara, S. by Afghanistan and Persia, and W. by the Caspian sea; area, about 30,000 sq. m.; pop. estimated at 1,500,000. The Bokharian-Russian boundary under the recent treaty (the czar having ceded the territories occupied E. of the river to the khan of Bokhara) follows the Amoo Darya (Oxus) from Kuketli to the junction of the westernmost branch, which it follows to the Aral sea; and from Cape Urgu, on the latter, the line continues along the E. slope of the Ust-Urt plateau and the so-called old bed of the Oxus to the Caspian. The whole of Khiva is supposed to have been at some time the bed of an immense shallow inland sea, of which only the Caspian and Aral remain. It is now a level expanse of plain alternating between sand and gravel, in which only the

hardest of plants can flourish, and which is relieved in spots by low, barren, slaty mountains. In the middle of this desert is the oasis of Khiva, which has a length of about 200 m.,

with an average width of 75 m., and contains a population of nearly 1,000,000. The Amoo Darya is connected with this oasis by a large number of canals partly formed by the river itself, and partly artificial, and covering the whole land under cultivation with a net. The climate of the oasis of Khiva is variable. The greatest cold is in December, when the Amoo and the sea of Aral are usually covered with ice. Frosts continue till April, and then the heat increases so rapidly as to become insupportable in June. In October night frosts set in again. Vambéry speaks in the most enthusiastic terms of the

fertility of the abundantly watered soil, and of the admirable quality of its fruits and vegetables, especially apples, peaches, pomegranates, and the incomparable melons. The other principal products are corn, rice, cotton, and *ryyan*, a kind of root prized for the red dye extracted from it. The finest silk comes from Shah-Abat and Yeni Urgan. Sheep, goats, horses, asses, and camels are raised in large numbers. The principal manufactures are articles in brass, earthenware, woollen goods, silk, and linen. Trade is chiefly carried on with Russia. Caravans consisting of nearly 2,000 camels go to Orenburg in the spring and to Astrakhan in the fall, and bring back cast-iron vessels, chintz (a favorite ornament of the women), fine muslin, calico, sugar, guns, and fancy goods. There is a great export trade in fish, but the Russians have their own fisheries on the sea of Aral. With Persia and Afghanistan the trade is small, as the routes are occupied by the Turkomans. With Bokhara they exchange woollen gowns and linen for teas, spices, paper, and fancy goods. From Astrabad they obtain boxwood and naphtha.—The khanate is peopled by Uzbecks, Turkomans, Kirghiz, Sarts (or Tajiks), and Persians. The Uzbecks, the predominant race, live in settled villages and towns, and are mostly engaged in agriculture. They are fond of music and poetry, mimic battles, wrestling and horse races. The Turkomans are represented mainly by the Yomuts, who inhabit the borders of the desert from Kunya Urgenj to Gazavat. There are now very few Kirghiz. The Sarts are the ancient Persian population of Khiva, and though they have lived five centuries together, very few marriages have taken

between them and the Uzbecks. Before recent war there were 40,000 Persians, of them slaves. The Khivan constituents of Mongol origin. At the side of the stand a number of dignitaries whom he remove from office. Other officials only in time of war. Justice is administered by *kazis* and *muftis*, either in their own or in the mosques. The political divisions of the khanate correspond to the number of the cities, which have their own beys or lords. The most interesting cities are the capital, Yeni (New) Urgenj, and (Old) Urgenj, famous for having long been the capital of the khanate. Other towns of importance are Hazar-asp, Kungrad, Tash-Gurlen, Khoja Ili, Shah-Abat, Kiliy-bay, and Kiptchak, mostly within a short distance from the banks of the Amoo Darya.—The khanate of Khiva anciently formed part of the Persian empire, and included the provinces of Chorasmia, Sogdiana, and Bactria. The shores of the sea of Aral were at that time ruled by the Massagetae, who, it is said, flourished 529 B. C. North of the old course of the Oxus, which united the Caspian and Aral lakes, lived the Aspariatae, a Scythian tribe, which probably formed part of the Parthian empire at the time of Arsaces VI. (or Mithridates), about 150 B. C. The tribes succeeded in throwing off the Parthian yoke between A. D. 100 and 100. From the 3d to the 10th century it was connected with Persia. It became an independent kingdom under the name of Khovaresm or Kharesm, until conquered by Genghis Khan early in the 13th century. At the end of the 14th it was taken by the Timurians, and remained part of the kingdom of Samarcand until the beginning of the 17th century. Eventually it came under the rule of the Uzbecks, a Turkish tribe, who reformed the khanate or kingdom of Khiva. In 1717 the Great Mogul sent an army under Gen. Nizam Khan against the Khivans in 1717, which was defeated. Since that time the khans have every opportunity to display hostile feelings against the Russians. Prominent among the khans, for his military skill and wise administration, was Rahim (1802-26). Allah Khan (1826-41) toward the end of his reign successfully resisted a large Russian expedition under the command of Gen. Perovsky. He expelled also the tribe of the Goklens, whom he expelled into his territory. His son Rahim Khan (1841-53) settled 10,000 tents of Jemal, a Persian tribe, on the bank of the Amoo Darya, near Kiliy. His brother defeated the khan of Bokhara, and usurped the throne at Bokhara. Mohammed Emin (1843-55) expelled his territory by conquering the land of the Bukharians and the Tekkes, who dwelt near the city of Akhal. In a subsequent expedition some of his enemies entered his tent, struck off his head, and sent it to the shah of Persia. His troops called to the throne Abdallah, who was slain in a rebellion

of the Yomuts (1856). He was succeeded by his younger brother Kutlug-Murad, who reigned only three months. His successor, Seid Mohammed, allowed the Yomuts to devastate the land, and the colonies founded by the previous khan became depopulated. Then a pretender to the throne, Mohammed Penah, instigated a rebellion, and implored the protection of Russia, for which he was finally murdered by his own partisans. The expedition undertaken by the Russian government against Khiva toward the close of 1872, under pretext of repressing brigandage and securing redress of grievances, met at first with a serious reverse. A body of Khivans surprised the advancing Russians, and compelled them to retreat. The Khivan success, however, roused the Russians to new efforts. An army was sent out in two main divisions, one advancing against Khiva from Turkistan on the east, and another from Orenburg and the Caucasus on the west. The principal column was under the orders of Gen. Kaufmann, the commander-in-chief of the whole expedition. On May 20, 1873, Kungrad was attacked and captured, and on June 10 the Russians entered the capital of Khiva. The khan had fled, but a few days afterward he returned, signified his submission, and signed a treaty of peace, which compelled him to pay an indemnity of 2,000,000 rubles by instalments extending over seven years, the Russian troops in the mean time occupying Shurakhan and Kungrad. The independence of the khan was to be recognized, but the E. boundary of the territory was reduced to the river Amoo Darya. Slavery and the slave trade were prohibited in the khanate. Subsequently it was added that the khan should have no right to make treaties with foreign powers without Russian sanction. The population of the ceded territory may be roughly estimated at 6,000 houses of settled inhabitants, and 37,000 kubitkas of nomads and semi-nomads; and taking the usual estimate of five persons to a house, with about 5,000 Persians previously slaves, the ceded population probably amounts to about 220,000. II. A city, capital of the khanate, situated in the most fertile portion of the valley of the Amoo Darya, about 30 m. from its W. shore; lat. 41° 20' N., lon. 60° E.; pop. about 6,000. The environs of Khiva are beautifully cultivated, but the city itself is declared to be inferior to a Persian city of the lowest rank. The houses are built of mud, and stand in the most irregular manner. The city is divided into Khiva proper and the citadel, which can be shut off from the outer city by four gates. The palace of the khan is an inferior building, and the bazaars are not equal to those of other oriental cities. Tim is the principal bazaar, where the articles imported from Russia, Bokhara, and Persia are exposed for sale. There are few mosques of much antiquity or artistic construction. The Polvan-Ata is an edifice about four centuries old, consisting of one large and two small

domes, and contains the tomb of Polvan, the patron saint of the city. The mosque attached to the khan's palace has a high round tower ornamented with arabesques. Among the *medreses* (colleges), that of Mohammed Emin Khan is probably the largest. It was built in

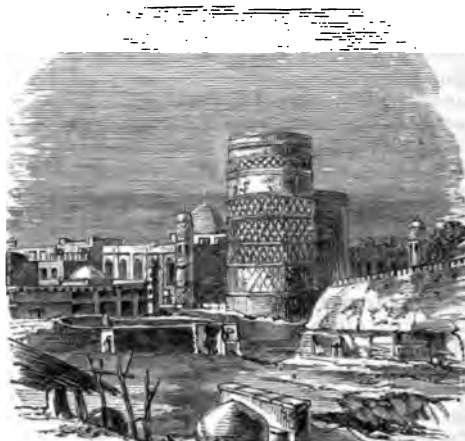

The Mosque of the Palace of Khiva.

1843 by a Persian architect after the model of a Persian caravansary. It has accommodation for 300 students.—See Stumm, *Aus Chiwa* (Berlin, 1874); Veniukoff, *Die Russisch-Asiatischen Grenzlande* (translated from the Russian by Kramer, Leipzig, 1874 *et seq.*); Vámbéry, "Central Asia and the Anglo-Russian Frontier Question" (London, 1874); Spalding, "Khiva and Turkestan" (London, 1874); and MacGahan, "Campaigning on the Oxus, and the Fall of Khiva" (London, 1874).

**KHODAVENDIGHIAR**, a vilayet of Asiatic Turkey, bounded N. by the sea of Marmora; pop. about 1,100,000. It is traversed by lofty mountains, including the Keshish Daghi (anc. *Olympus*), and by tributaries of the Sakaria river, and has numerous lakes, that of Abullonia being the most remarkable. It abounds in grain and fruit, and produces cotton and silk. It comprises the S. part of ancient Bithynia, Mysia, and the western portions of Phrygia. Capital, Brusa.

**KHOL**, a town of Persia, in the province of Azerbaijan, situated in a fertile valley watered by the Kotura, an affluent of the Aras, N. of Lake Urumiah, 70 m. N. W. of Tabriz; pop. about 20,000. It is strongly fortified and one of the most attractive Persian towns, with many mosques, a fine caravansary, and a khan's palace. There is a considerable caravan trade to Erzerum. Woollen and cotton goods are manufactured, and the principal products are grain, cotton, and fruits. The Persians, numbering 30,000, were overwhelmed here by a Turkish army of 180,000 men in 1514.

**KHOKAN**, or **Kokand**. I. A country of central Asia, one of the three great khanates of

West Turkistan or Independent Tartary, lying between lat. 39° and 43° N., and lon. 69° and 75° E.; bounded S. W., W., N., and N. E. by the new Russian province of Sir Darya, E. and S. E. by East Turkistan, and S. by the Pamir plateau and Karateghin. It is enclosed by lofty snow-covered mountain ranges on the south and southeast, dividing the basin of the Amoo Darya or Oxus from that of the Sir Darya (the ancient Jaxartes), which is the principal river of Khokan, receiving all its streams. The precise area of the khanate is unknown, but it is largely comprised in an almond-shaped valley about 165 m. long and with an extreme width of 65 m. Prior to the Russian advance in 1864, the fertile valley of the Sir Darya as far N. W. as Tashkend was included within its boundaries, but at present the western frontier of Khokan crosses the river between the capital and the city of Khojend. The general elevation of the country exceeds 1,500 ft. above the sea level. The winter is severe in the mountainous tracts, but a milder climate prevails in the main valley, where but little snow falls. In summer the heat is excessive during the day, but the nights are cool. The most fertile portion of the khanate is the rich territory about the city of Andijan, near the centre of the country, formerly known as the province of Ferghana; but irrigation is extensively practised, and the soil throughout the country is extremely productive. The cereals are wheat, barley, and rice; there is a large cotton crop; and hemp, flax, sorghum, peas, beans, madder, and tobacco are also cultivated. Khokan is noted for the excellence and variety of its fruits. The manufacture of a fine quality of silk is a leading branch of industry. In 1872 the chief articles of export were cotton, of which about 8,000,000 lbs. were sent to Russia, and silk, of which the same country received about 200,000 lbs. Many districts afford pasturage for large and thriving herds of horses, asses, horned cattle, sheep, and camels. Coal, iron, naphtha, and petroleum are known to exist in the mountains; turquoises of an inferior quality and greenish hue are also found. The population is estimated at 3,000,000, and includes Chebeka, who are the military and dominant class, Tajiks, Kirghiz, and Kiptchaks. A commercial treaty between Khokan and Russia was negotiated in 1868, and the khanate is virtually under Russian protection and control. (See **TURKISTAN**.) II. A city, capital of the khanate, situated in a beautiful valley a short distance S. of the Sir Darya, about 220 m. E. N. E. of Samarcand, 1,540 ft. above the level of the sea. According to Vámbéry, it is three times as large as Bokhara and six times as large as Khiva. Estimates of the population vary from 30,000 to 60,000. There are few stone mosques in the city, and numerous bazaars in which Russian goods are sold, as well as native silks and woollens, and handsome leather equipments for riding.

**KHORASAN**, or *Khorassan*, a N. E. province of Persia, between lat.  $31^{\circ} 30'$  and  $38^{\circ} 40'$  N., and lon.  $52^{\circ} 40'$  and  $61^{\circ} 20'$  E., bounded N. by Khiva, E. by Afghanistan, S. and W. by the Persian provinces of Kerman, Fars, Laristan, and Irak-Ajemi; area, 124,400 sq. m.; pop. estimated at 850,000. A large portion of the surface is covered by the great salt desert, called by the natives Kubir. The N. W. and N. E. districts are fertile, with numerous oases, mostly of small extent, but containing several populous towns. The Elburz mountains stretch along the north of the province, and throw off ramifications to the southward. The products of the cultivated districts are grain, cotton, hemp, tobacco, aromatic plants, and drugs, including asafœtida, manna, and gum tragacanth. The manufactures are silk, woollen, and goats' hair stuffs, carpets, muskets, and sword blades. Meshed is the capital of the province, and the other chief towns are Yezd, Tabas or Tubus, and Nishapur. About 40 m. N. W. of Nishapur are famous turquoise mines. Two thirds of the inhabitants are Persians, resident in towns, the remainder being nomadic Turkomans and Kurds. The prevalent religion is Mohammedanism of the sect of Ali.—The province comprises the ancient territories of Parthia, Margiana, and Aria. After its having formed part of the empire of Alexander the Great and of the Seleucids, a portion of it was incorporated with Bactria. The Arsacides of Parthia, the Sassanides of Persia, and the caliphs ruled over the entire province. Its governor Taher revolted in 813, and he and his successors continued independent. The Saffarides regained possession of it, but lost it to the Samanides and their successors in power, the Ghuznevides. The Seljuks also occupied it for a while, losing it periodically to the people of Kharesm and Ghore, and finally Genghis Khan conquered it. About 1383 it fell into the hands of Tamerlane, and in the reign of his son it enjoyed great prosperity. After much suffering from the inroads of the Uzbecks, it was seized by Ismael, and has formed since 1510, with the exception of Herat, a province of Persia.

**KHOTIN**, or *Chotin*, a fortified town of Russia, in Bessarabia, on the right bank of the Dniester, nearly opposite Kamenetz, near the frontier of Galicia; pop. in 1867, 20,917. It is surrounded by hills, which lessen the strategical value of the fortifications. It is the seat of an archbishop of the Greek church. The industry consists chiefly in furnishing supplies for the army. It was anciently a Moldavian city, and became afterward an important stronghold of the Turks against the Poles. The latter, however, achieved here two celebrated victories. In 1621 Gen. Chodkiewicz repulsed here vigorous Turkish assaults on his fortified camp; and in 1673 John Sobieski routed an army of Mohammed IV. in a battle of scarcely two hours. Strengthened by new fortifications since 1718, the place was taken by the Russians in 1739, but restored to the Turks; taken again in

1769, and restored in 1774; taken by the Austrians in 1788, but not held; and finally ceded by the peace of Bucharest to Russia in 1812.

**KHUZISTAN** (anc. *Susiana*), a province of Persia, bounded N. and N. E. by Laristan, S. E. by Fars, S. by the Persian gulf, and W. by the Turkish vilayet of Bagdad; area estimated at 89,000 sq. m.; pop. about 400,000. Its surface is hilly, the Bakhtiyari mountains rising on its N. E. frontier, and lesser eminences being scattered over the N. part of the province. In the south it is more level. The Shat-el-Arab (the united stream of the Tigris and Euphrates) forms part of its W. boundary. Several of the branches which form its delta empty into the Persian gulf through this province. The principal rivers which traverse the interior are the Kerkha (anc. *Chaspos*) and the Karun (anc. *Eulvus*). Khuzistan contains extensive grazing lands on which vast herds are pastured, and produces rice, maize, barley, cotton, sugar cane, dates, and indigo. The silkworm is reared, and trade is carried on with Bagdad, Bassorah, and other places. Its principal towns are Shuster, Dizful, Ahwaz, and Mohammerah. The inhabitants are Tajiks, Sabian Christians, Lurs, Erdelans, and Arabs, all of whom except the Sabians are Mohammedans. The province contains the ruins of Susa, one of the ancient capitals of Persia. (See *ELAM*, and *SUSIANA*.)

**KIAKHTA**, or *Kiakhta*, a town of Siberia, near the Chinese frontier, in the Russian province of Transbaikalia, lat.  $50^{\circ} 20'$  N., lon.  $106^{\circ} 30'$  E., about 100 m. S. of Lake Baikal, on a small stream of its own name, 2,500 ft. above the sea; pop. in 1867, 4,286. It consists of the fortress, where the custom house and the government buildings are established, and of the lower town or town proper, where the merchants live, many of them in elegant houses. Kiakhta is a great emporium of trade between Russia and China, the Chinese settlement Maimachin being less than half a mile from the lower town. In 1727 a free commercial intercourse was established between China and Russia, to be carried on at the common boundary on the Kiakhta. Fairs were formerly held annually, at which Russian productions were bartered for Chinese, especially tea, a great amount of which was forwarded to the fair of Nizhni-Novgorod. The trade of Kiakhta, formerly estimated at \$8,000,000 a year, has decreased since the treaty of Peking, Nov. 14, 1860, which opened for traffic the whole line of the Russian-Chinese frontier.

**KIANGSI**, a S. E. province of China, bordering on Hupeh, Nganhwui, Chihkiang, Fokien, Kwangtung, and Hunan; area, 72,176 sq. m.; pop. about 23,000,000. It is watered chiefly by the Kan-kiang, which flows into Lake Poyang, and its numerous affluents. East of the lake are large coal mines. Green tea is produced chiefly in the E. and black in the W. part of the province. The other products include cereals, rice, cotton, sugar, indigo, and

silk. Excellent porcelain and nankeen cloth, besides other articles, are manufactured. A large portion of Kiangsi was flooded in 1870-71 by the Yangtse, more than 300,000 persons taking refuge on the high ground near Kewkiang. This created poverty and disturbances, resulting in movements against missionaries and foreigners generally. Capital, Nanchang.

**KIANGSU**, a province of China, on the N. E. coast, bordering on Shantung, Honan, Nganhwui, Chihkiang, and the Yellow sea; area, 44,500 sq. m.; pop. about 38,000,000. It is generally level, and abounds in marshes, but is one of the most fertile regions of China, owing to its many lakes, rivers, and canals. The principal lake is the Hungtsih, about 200 m. in circumference, which is connected with the Hoang-ho. It exports more rice than any other Chinese province, and cereals, cotton, tea, and silk are produced. Fisheries thrive on Lake Taihu and other waters. The people are among the most intelligent in China, and the province contains many fine towns. Capital, Nanking.

**KICKAPOOS**, a tribe of the great Algonquin family, first found by the French missionaries toward the close of the 17th century on the Wisconsin, not far from the Maskoutens, a kindred tribe, who seem to have ultimately merged in the Kickapoos. They probably lived previously on the Mississippi, above the Wisconsin. They were closely allied to the Miami, but roved in bands over a large territory. Though professing friendship to the French, they killed a Franciscan, Father Gabriel de la Ribourde, who was attached to La Salle's party. They took part in the general peace of 1700, but in 1712 joined the Foxes to attack Detroit, and were their allies in the long series of hostilities that ensued. By 1718 they were chiefly on the Rock river, Illinois. In 1728 they captured the Jesuit Father Guignas, and held him captive for several months. Peace was finally restored about 1747, when the Kickapoos are said to have been reduced to 80 warriors; but they were still hostile to the Illinois. When the English conquered Canada, in 1763, they found 180 Kickapoos on the Wabash. The tribe joined Pontiac, and in 1765 attacked Croghan on the Ohio, killing and wounding several of his men; but they made peace at Detroit in October. They were soon hostile again to the English, and in 1779 readily supported Col. Clark in his operations against the English. They soon, however, partook of the general hostile feeling against the new government, besides warring on the Chickasaws. In June, 1791, Gen. Scott carried the Kickapoo town on the Wabash, and in August Wilkinson burned another of their villages. Peace was nominally made in 1792, but they did not really yield till the treaty of Greenville, Aug. 3, 1795, after Wayne's great victory. They then ceded part of the land they claimed for \$500 a year in useful goods; and they made further cessions in 1802, 1803, and 1809. Though warned by Gov. Harrison, they joined Tecumseh, and

fought at Tippecanoe in 1811. After that they sought to treat, but Harrison declined. The war with England gave them hopes, and the Kickapoos with others attacked Fort Harrison, where Zachary Taylor defeated them. In October, 1812, Russell surprised a Kickapoo town on the Illinois, killing many; and in November Hopkins destroyed another town on Wildcat creek. They then sued for peace, and Little Otter met Harrison. The treaties of Portage des Sioux (Sept. 2, 1815), Fort Harrison (June 4, 1816), and Edwardsville (July 30, 1819), ceded a large part of the lands which they claimed by descent from their ancestors, by conquest from the Illinois, and by 60 years' possession. Many of the tribe had already gone beyond the Mississippi, and the United States agreed to pay them \$2,000 a year for 15 years, and assigned them a large tract on the Osage. In 1822, 1,800 had removed, only 400 remaining in Illinois. About 1830 Kennekan, or the prophet, a leading chief, set himself up as a teacher, preached with eloquence, and taught the people to pray morning and evening, the form being symbolically cut on maple sticks. Provision was made for schools by the treaty of Castor Hill, Oct. 24, 1832; but the labors of the Jesuits, followed by the Methodists, Presbyterians, and Friends, failed to convert the tribe or establish education among them. Some few settled down to cultivate; more rambled off to hunt on the grounds of southern tribes, entering even Texas and other Mexican states. This band was very troublesome, plundering on all sides. They were sent out of the Chickasaw country in 1841, but were allowed on the Creek territory for a time. They made constant inroads into Texas, killing and horse stealing. In 1854 they killed an Indian agent of the United States. In 1838 the agency band numbered 725; the next year only 419. In 1845 this band had increased to 516, and they were then in a thriving condition, raising enough vegetables and grain to support themselves, and supply Fort Leavenworth. In 1854 they were removed to a reservation in Atchison co., Kansas, part of their large tract being ceded for \$300,000. Soon after the tribe lost greatly by smallpox, Kennekuk the prophet being one of the victims. Though unaffected by the civil war, they steadily declined in numbers, and in 1863 there were only 343 on the reservation, the southern or wild band appearing only when the annuities were to be paid. At this time the Atchison and Pike's Peak railroad obtained the right to purchase their lands at \$1 25 an acre, and steps were taken to give individual members of the tribe separate lands, and make them citizens. Great discontent arose, and Nokohwart led 100 to Santa Rosa, Mexico, where a large number of Kickapoos had settled and were protected by the Mexicans. In 1865, under a new treaty, 30 families took lands in severalty, 160 acres being allotted to each head of a family; 79 families, form-

ing the Prairie band, preferred to have lands in common. The sale of the remaining lands gave a fund of which the United States was to pay \$10,000 in 1873 and a similar amount yearly till the whole is accounted for. The tribe has also \$5,000 a year for schools. The roving part has given much trouble to the more civilized and to government. They have gathered mainly at Santa Rosa and its vicinity, and, as they defend the Mexicans against the Apaches, and bring in considerable by their raids, are encouraged in their roving habits. In 1871 Miles, the agent of the Kickapoos, went to Mexico to endeavor to induce the whole body there to return to the United States and settle on a reservation. The Mexican government thwarted his plans, and at once spent \$10,000, long previously appropriated, for agricultural implements and other valuable articles for the Kickapoos. The depredations of these Indians across the frontier led to a dash into Mexico by Gen. Mackenzie, in which the Indians were severely punished. These Mexican Kickapoos numbered fully 1,000; but in 1873 300 or 400 returned, and were placed in the Indian territory, west of Arkansas river. In 1873 the Kickapoos on the reservation in N. E. Kansas numbered 274. There were 46 children in their school, and a boarding school was in progress. These Indians have ceased to be or consider themselves warriors. Their annual produce was valued at \$12,000, and their stock was worth about \$18,000.

**KIDD, William**, a pirate, born in Scotland (probably in Greenock), executed in London, May 24, 1701. He is said to have been the son of John Kidd, a nonconformist minister. He followed the sea from his youth, and toward the end of the 17th century was a bold and skilful shipmaster from New York. He distinguished himself as a privateersman against the French in the West Indies, and in 1691 received £150 from New York for protecting the colony against pirates. In 1695 a company for the suppression of piracy was organized in England, by the earl of Bellamont and others, who hoped to derive a profit from recaptures. The Adventure Galley, a new ship of 287 tons and 34 guns, was bought, and at the suggestion of Robert Livingston of New York, one of the shareholders, her command was given to Kidd, who received two commissions, one dated Dec. 10, 1695, from the commissioners of the admiralty, empowering him to act against the French, the other dated Jan. 26, 1696, under the great seal, authorizing him to cruise against pirates. One tenth part of all booty was to be set aside for the king, and the remainder was to be divided between the shareholders and Kidd in certain specified proportions. A share was also appropriated to the crew, who were to receive no regular pay. Kidd sailed from Plymouth on April 23, 1696, captured a French fishing vessel off Newfoundland, and arrived in New York with his prize about July 4. He remained there until Sept. 6, when he sailed

with a crew of 154 men for Madagascar, then the chief rendezvous for pirates, and arrived there in January, 1697. In 1698 rumors became prevalent in England that Kidd himself had turned pirate, and on Nov. 23 of that year orders were sent to the governors of all the English colonies to apprehend him if he came within their jurisdiction. In April, 1699, he arrived in the West Indies, in a ship named the Quidah Merchant, secured her in a lagoon in the island of Saona, at the S. E. end of Hayti, and set sail northward with about 40 men, in the San Antonio, a sloop of 55 tons. He made a landing in Delaware bay, sailed up the coast to Long Island sound, and went into Oyster bay. Here he took on board James Emott, a New York lawyer, and running across to the Rhode Island coast set him ashore and sent him to Boston to Bellamont, who had become governor of the colonies, to ascertain how the latter would receive him. During his absence Kidd buried some bales of goods and some treasure on Gardiner's island. Bellamont answered evasively, and after some correspondence persuaded Kidd to go to Boston, where he landed on July 1, 1699. He was examined before the council, and, according to Bellamont, gave trifling answers to interrogatories, and on July 6 the governor ordered his arrest. He was sent to England, and after a grossly unfair trial, in which he was allowed no counsel, and was not permitted to send for papers and witnesses, he was found guilty of piracy and of the murder of William Moore, one of his crew, whom he struck on the head with a bucket during an altercation, and was hanged at Execution dock, with nine of his associates. Kidd asserted his innocence to the last; averred that Moore was mutinous when he struck him; and claimed that his men forced him to take the Quidah Merchant against his will. Bellamont equipped a ship to go in search of that vessel, but heard before she sailed that the latter had been stripped and burned by the men left with it. He secured the treasure buried on Gardiner's island, which, together with that found in Kidd's possession and on the San Antonio, amounted to 1,111 oz. troy of gold, 2,353 oz. of silver, 17 oz. of jewels (69 stones), 57 bags of sugar, 41 bales of merchandise, and 67 pieces of canvas, of the total value of about £14,000. There are no grounds for the popular belief that he buried other treasures, although frequent search has been made for them along the N. E. coast, in the lower part of the Hudson, and elsewhere, till a very recent period.

**KIDDER**, a N. county of Dakota, recently formed, and not included in the census of 1870; area, about 1,700 sq. m. It is occupied by the "Plateau du Coteau du Missouri," and contains several alkaline lakes. The Northern Pacific railroad crosses it.

**KIDDER, Daniel Parish**, an American clergyman, born at Darien, N. Y., Oct. 18, 1815. He graduated at Wesleyan university, Middletown,

in 1836, entered the Genesee conference, and was stationed at Rochester, N. Y. In 1837 he went as missionary to Brazil, and during 1839 traversed the whole eastern coast from San Paolo to Pará. He introduced and circulated the Scriptures in the Portuguese in all the principal cities of the empire, and preached the first Protestant sermon on the waters of the Amazon. He returned to the United States in 1840, and in 1844 was appointed official editor of the Sunday school publications and tracts, and corresponding secretary of the Sunday school union of the Methodist Episcopal church, a post he held for 12 years. Besides editing the "Sunday School Advocate," he compiled and edited more than 800 volumes of books for Sunday school libraries. He was likewise the organizer of the conference Sunday school unions, and one of the originators of Sunday school conventions and institutes. In 1856 he was appointed professor of practical theology in the Garrett Biblical institute at Evanston, Ill., where he remained till 1871, when he was called to a like chair in Drew theological seminary at Madison, N. J., where he still remains (1874). His publications include a translation from the Portuguese of the work of Feijo entitled "Demonstration of the Necessity of abolishing a constrained Clerical Celibacy" (Philadelphia, 1844); "Mormonism and the Mormons" (1844); "Sketches of a Residence and Travels in Brazil" (2 vols., 1845); conjointly with the Rev. J. C. Fletcher, "Brazil and the Brazilians" (1857); "Homilies" (New York, 1868); and "The Christian Pastorate" (1871).

**KIDDERMINSTER**, a municipal and parliamentary borough of Worcestershire, England, situated on the Stour, 13 m. N. of Worcester; pop. of the municipal borough in 1871, 19,463; of the parliamentary borough, 31,747. The streets are irregularly built and the houses are generally small. The most important manufacture is of carpets, for which Kidderminster has long been famous; but worsted and other woollen goods, damask silks, leather, &c., are made. The Stafford and Worcester canal, and the Oxford, Worcester, and Wolverhampton railway, pass through the town. The manor of Kidderminster was once the property of the poet Waller. Here for many years Richard Baxter officiated as pastor.

**KIDNAPPING**, the stealing and carrying away or secreting of any person. It is regarded by the law as an aggravated species of false imprisonment, and includes the legal elements of that offence. At the common law kidnapping is a misdemeanor, and punishable by fine and imprisonment. The same punishment is adopted by the state statutes in this country.

**KIDNEY**, a special organ in vertebrated animals, whose office is to separate from the blood certain effete substances, to be thrown out of the system in the urine; it has no direct connection with any of the nutritive operations concerned in digestion. Taking these organs

in man as typical, the kidneys are situated in the lumbar region, one on each side of the spine, on a level with the last two dorsal and the first two lumbar vertebrae; they are of a brownish red color, bean-shaped, flattened from before backward, and grooved on the interior border for the great vessels; the anterior surface is in relation on the right with the duodenum and the ascending colon, and on the left with the descending colon, the posterior surface is imbedded in fat, resting against the muscles; the upper extremity is embraced by the supra-renal capsules; the lower extremity, which is somewhat smaller than the upper, projects a little further downward upon the right side than the left. The kidneys are well supplied with blood, in accordance with the importance of their function; the renal arteries come directly from the aorta, and the large veins terminate in the vena cava; the nerves



Human Kidney, in Vertical Section.

a. Cortical substance. b. Medullary substance. c. Coils of bundles of the medullary substance. d. Membranous ducts, into which the coical bundles are received. e. Pelvis of the kidney. f. Ureter. g. Renal artery. h. Renal vein.

come from the renal plexus of the sympathetic system. They are covered by a thin, firm, transparent cellular envelope; internally they are composed of two substances, an exterior or cortical and an interior or medullary. From the researches of Bowman, Gerlach, Kölliker, and others, it is ascertained that the cortical substance, the seat of the greater part of the secretory process, is made up of a great number of uriferous tubes, much convoluted and inosculating with each other, and lined with epithelial cells of a spheroidal and projecting form; scattered through the plexus formed by these tubes and the blood vessels are dark points which have been called *corpora Malpighiana* from their discoverer; these last are convoluted masses of minute blood vessels included in flask-like dilatations of the uriferous tubes, forming a close relation between the circulating and the secreting systems.

The medullary substance is composed principally of tubes passing nearly straight inward to the central receptacle of the secretion. Both these substances are imbedded in interlacing

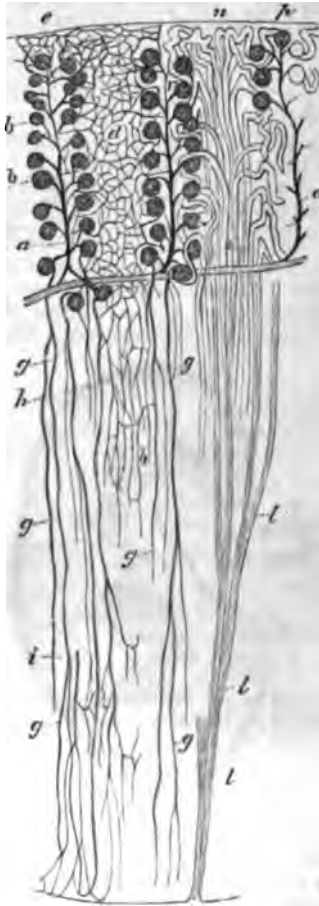

Vertical Section through a portion of the Medullary and Cortical Portions of the Rabbit's Kidney.

a. Small arteries of the cortical portion. b. Corpora Malpighiana. d. Capillary blood vessels of the cortical portion. c, n, p. External surface of the kidney. g, h, i. Blood vessels of the medullary portion. l. Straight uriniferous tubes of the medullary portion, becoming convoluted in the cortical portion.

fibres, most abundant in the medullary. In mammals the kidneys are supplied with blood directly from the arterial system, but the renal artery divides very soon after entering the organs into minute twigs which pierce the capsule of the Malpighian tufts: from the convolutions of these tufts arise the efferent vessels which surround the uriniferous tubes, and from which the renal veins are formed; thus the urinary secretion is produced from blood which has passed through the Malpighian capillaries, the efferent trunks from which have been compared to a portal system within the

kidney. The uriniferous tubes end in from 12 to 18 conical bundles, pointing toward the interior, and there embraced by 6 or 12 membranous ducts received into the central reservoir or pelvis of the kidney, from which arises the ureter, the membranous tube which conducts the renal secretion to the bladder. Without entering upon physiological questions which will be more properly treated under URINE, it



Malpighian Tuft from near the base of one of the Medullary Cones. a. Arterial branch. q. Afferent vessel. m. Malpighian tuft. r. Efferent vessel; s. its branches, entering the medullary cone. (Magnified 70 diameters.)

will be sufficient to state that the kidneys serve to regulate the quantity of water in the system, a large amount of which may be got rid of through their agency. As the skin and lungs, the other channels through which superfluous water is removed from the blood, are liable to be greatly affected

by external circumstances, the kidneys perform a very important office in relation to that fluid. Hence the quantity of the renal secretion will depend on the amount of fluid passed off by the skin, being greatest when the cutaneous secretion is least, and *vice versa*; the amount of solid ingredients being dependent on the amount of waste and the excess of nitrogen in the system. The kidneys serve to free the blood from highly nitrogenized compounds formed from the decomposition of the albuminous and gelatinous tissues and from some portions of the food; they also remove certain excrementitious compounds, of which carbon is a principal ingredient, abnormally increased when the liver and the lungs do not act freely; by them the superfluous water and various saline matters in excess, and foreign substances introduced into the blood as medicines or otherwise, which would be injurious if retained, are carried off. The kidneys are subject to many painful and dangerous diseases, which can only be alluded to here; among these are vascular congestion, inflammation, fatty and waxy degeneration, and diseased states produced by retention of urine, by calculi, external violence, and extension from other organs. Bright's disease is one of their most common and fatal affections, the so-called granular degeneration, consisting in the distention of the tubules, the surrounding tissue, and the Malpighian capsule, with exudation matter, and the subsequent atrophy of portions or even the whole of the cortical substance. Invertebrates have special organs for the secretion of urine, opening into the intestines or into the branchial cavity. In fishes





Kiel.

stein), situated on the Kieler Hafen, a fine harbor of the Baltic, 52 m. N. by E. of Hamburg; pop. in 1871, 31,747. It is walled, well built, contains the Glücksburg palace, four churches, and a university founded in 1665, with an observatory, a library of 140,000 volumes, a botanic garden, and 250 students. Kiel is important as the great harbor of the fleet of the German empire. The harbor is about 10 m. long and 1 m. wide, and is defended by several forts. The government is building extensive wharves and arsenals, which are to be completed in 1878. The naval academy of Berlin was transferred in 1868 to Kiel, and a special school for deck officers and sub-engineers was connected with it. An academy for the instruction of naval officers is in the course of erection. It is proposed to connect the Baltic with the North sea by a new canal terminating in the harbor of Kiel. The Eider canal, which forms that connection at present.

sequently belonged to the Hanseatic League. A treaty of peace between Denmark and Prussia was concluded here in 1814. An insurrection in favor of the independence of Schleswig-Holstein took place, and a provisional government was formed, March 24, 1848. A convention of Gastein, Aug. 14, 1865, transferred Kiel, unlike the rest of Holstein, was to be annexed to Prussia as a German federal harbor.

**KIELCE.** 1. A government of Europe, in the kingdom of Poland, bordering on the governments of Piotrków and Radom. It is situated on Austrian Galicia; area, 3,623 sq. m. in 1867, 470,300. It is slightly mountainous in the north, where it is traversed by the Lysa Góra, and hilly in the south. It has mines of iron and copper, and produces rye, wheat, and fruits. It is separated by the Vistula, which separates Austrian Galicia, by its affluent the Nida, and the Pilica, which partly separates it from 1

spit of land between a river and a bay; pop. about 200,000. There is a considerable coasting trade with Canton and Macao. Kienchow is one of the ports open to foreigners, though there is not as yet any English settlement. The rocky coast is infested by pirates and wreckers, in consequence of the numerous casualties, but the inhabitants generally treat the shipwrecked people with kindness.

**KIEPERT, Heinrich**, a German geographer, born in Berlin, July 31, 1818. He studied under Ritter, explored Asia Minor in 1841-'2, and was director of the geographical institute at Weimar from 1845 till the end of 1852, when he returned to Berlin, and became a member of the academy of sciences and a lecturer, and in 1859 a professor in the university. In 1865 he joined the statistical bureau. He published, with the assistance of Ritter, the *Atlas von Hellas und den hellenischen Colonien* (Berlin, 1840-'46; revised ed., 1866). His other works include maps for Robinson's "Biblical Researches in Palestine" (Halle, 1843); a celebrated map of Asia Minor (1843-'5); *Historisch-geographische Erläuterung der Kriege zwischen dem oströmischen Reiche und den persischen Königen der Sassaniden-Dynastie*, which won a prize from the French institute in 1844, though not yet published; eight maps to Lepsius's "Monuments of Egypt and Ethiopia" (Berlin, 1849-'59); *Historisch-geographischer Atlas der alten Welt* (16 maps, Weimar, 1848; 15th ed., 1861); *Neuer Handatlas der Erde* (40 maps, Berlin, 1857-'61; enlarged ed., 1866 et seq.); *Grosser Handatlas des Himmels und der Erde*,

with C. F. Weiland and others (43d ed., 72 sheets, Weimar, 1871); and a large number of minor publications.

**KIESEWETTER, Rafael Georg**, a German author, born at Holleschau, Moravia, Aug. 29, 1773; died near Vienna, Jan. 1, 1850. He was for many years referendary of the aulic military council at Vienna. His works include *Geschichte der europäisch-abendländischen, das heisst unserer heutigen Musik* (Leipsic, 1834; 2d ed., 1846), which has been translated into English. He also wrote works on Dutch, modern Greek, and Arabic music. He published a catalogue (2 vols., Vienna, 1847) of his collection of ancient music, which latter he bequeathed to the imperial library at Vienna.

**KIEV, Kieff, or Kiow.** I. A S. government of European Russia, bordering on Minsk, Tchernigov, Poltava, Kherson, Podolia, and Volhynia; area, 19,682 sq. m.; pop. in 1867, 2,144,276. Kiev is the most fertile part of the Ukraine or Little Russia. Its surface is a plain, here and there undulating, and near the river courses intersected by low ranges. It is watered by the Dnieper, which forms its boundary on the side of Tchernigov and Poltava, and its western affluents, the Pripet, Ros, and others, the streams which take their course to the Bog or southern Bug being unimportant. There is abundance of grain of all kinds, of hemp, flax, honey, wax, and tobacco, excellent timber, and cattle of very good breed, the latter forming a principal article of export. The climate is generally very mild and dry; excessive heat prevails in summer. Agriculture and cat-



Kiev—the Peteriskoi Ministry.

tle breeding are the chief occupations of the inhabitants, who consist mainly of Little-Russians. The manufactures are unimportant. Trade is in part carried on by Jews, who are

numerous in the adjoining western governments. II. A city, capital of the government, on the right bank of the Dnieper, 270 m. N. of Odessa; pop. in 1867, 79,591. It consists of

four parts, the old town, the Petcherskoi or new fort, both on steep hills, the Podol or low town, between the hills and the river, and the Vladimir town, which was added to the former by the empress Catharine II. The old town, which in the times preceding the conversion of the Russians to Christianity, under Vladimir the Great, was the principal seat of Sarmatian and Russian heathen worship, now contains, besides several other churches, the cathedral of St. Sophia, a magnificent structure of the 11th century, and the palace of the Greek metropolitan. The fort contains the great Petcherskoi monastery from which it received its name, and which, together with the bastions and walls of the place, and the glittering gilt and colored cupolas of the churches on the neighboring eminences, makes a strong impression upon the traveller who approaches the city from the other side of the Dnieper. This division embraces the barracks of the garrison, the arsenals and magazines, the houses of the officers, the palace of the governor, numerous churches, and the renowned catacombs of St. Anthony, consisting of excavations in a precipitous cliff on the banks of the river, which attract numberless pilgrims from all parts of Russia through veneration for the saints whose bodies are there preserved. Adjoining are the catacombs of St. Theodosius, which contain a smaller number of saints. The Podol, which is the commercial part of the city, is regularly laid out, and embellished with gardens. Kiev has a large university, founded in 1834, to which are attached a library and cabinets of medals, zoology, mineralogy, and botany. There are also various other institutions of learning, of which the Greek theological academy in the Petcherskoi monastery is the best endowed and most frequented. The manufactures and trade of the city are not important. Railways connect it with Moscow and St. Petersburg, Odessa, and Lemberg. A magnificent bridge, recently constructed, spans the Dnieper.—The earliest history of Kiev is traced by some to the time of the Greek colonies near the N. coast of the Black sea; others place its foundation in the 5th century. In the last quarter of the 9th century it became the residence of the princes of Novgorod. As the capital of Christianized Russia, it was adorned in the 11th century with a great number of churches. After the middle of the 12th, however, it was deprived of its rank, and subsequently suffered by the devastations of the Tartars, the Lithuanian and Polish wars, the plague, and fires. After having been for about three centuries in the hands of the Poles, it was reannexed to Russia by the peace of 1667.

**KILAUEA**, a volcano in the E. part of the island of Hawaii, in lat. 19° 25' N., lon. 155° 20' W. It is a pit or sunken plain 8 m. in circumference, bounded by steep or perpendicular walls, and varying from 800 to 1,500 ft. in depth as the floor of the crater is raised or lowered by volcanic action; eruptions drawing

off the accumulated lavas from beneath and causing it to sink. Near the S. W. extremity of the pit is a lake of melted lava in a state of constant ebullition, called by the Hawaiians the Hale-man-mau, or "house of everlasting fire," and formerly regarded as the residence of their principal divinity, the goddess Pele. From this caldron, which is not infrequently a third or a half mile in diameter, the foam overflows in times of special volcanic activity, spreading out upon the cooled lava which forms the bottom of the crater; or it bursts out at new points of this nearly level tract. The crater presents in consequence quite different appearances at different times, being especially changed by the occurrence of eruptions. These are generally preceded by a rise in the floor of the crater. When the lateral pressure of the accumulating lava becomes sufficiently great, it forces its way through the side of the mountain, often accompanied by violent earthquakes, and breaks to the surface at a distance of 5, 10, or 20 m. from the great crater, which is usually emptied to a depth of 400 ft. The lava continues to flow seaward incessantly for several days, weeks, or months. These eruptions are generally independent of those which take place from the crater upon the summit of Mauna Loa, 10,000 ft. higher than Kilauea, though the two craters are but 16 m. distant from each other. The lavas are very fluid, and contain much iron and augite. The greatest recorded eruption of Kilauea took place in June, 1840. The lava forced its way for 77 m. mostly underground, marking its course by rending the rocks above it, and sometimes splitting the trunks of large trees so as to leave them standing astride of the crevices. The lava stream showed itself occasionally upon the surface of the ground, or in the pits of old craters; and finally it broke from the ground in a resistless flood, at the distance of 12 m. from the coast, and rolled shoreward, sweeping forests, hamlets, and plantations before it, until, leaping a precipice of 40 or 50 ft., it plunged with loud detonations into the sea. Its entire course was 40 m. in length; its depth, owing to the extreme roughness of the country over which it flowed, varied from 12 to 200 ft., and its width from 500 ft. to 3 m. The flow continued for three weeks, and for a fortnight the light of it was so brilliant that at Hilo, 40 m. distant, fine print could be read at midnight. The coast was extended into the sea a quarter of a mile; hills of scoria and sand were formed, one 300 ft. high; the sea was heated for 20 m. along the coast, and multitudes of fish were killed. This eruption poured out 12,000,000 cubic feet of lava, which is probably about the average amount of the eruptions of Kilauea. Eruptions occurred in 1789, 1822, 1832, 1840, and 1866. The crater is not difficult of access, and is generally visited from Hilo.

**KILBOURNE**, James, an American pianist, born in New Britain, Conn., Oct. 19, 1774, died in Worthington, O., April 9, 1850. He

necessively employed as an apprentice, merchant, and manufacturer. Having had a competence, he became a priest in the Protestant Episcopal church, declined several advantageous calls to vacant parishes, and for the purpose of promoting western emigration in 1801-'2 organized the Scioto company, whose auspices a colony of about 100 persons, under his lead, was in 1803 established at what is now the township of Worthington in Ohio. He retired from the ministry in 1806 and was appointed a civil magistrate, and a member of militia on the N. W. frontier, and proprietor of a large portion of the public lands. In 1812 he was one of the commissioners to settle the boundary between the public lands and the great Virginia reservation, and also commissioned as a colonel in the frontier regiment; and in 1818 he entered congress, of which he remained a member till 1817. He was for 35 years president of the board of trustees of Worthington college.

**DARE**, an inland county of Ireland, in the province of Leinster, bordering on Meath, Dublin, Wicklow, Carlow, Queen's, and King's counties; area, 654 sq. m.; pop. in 1871, 84,198. The surface is flat or undulating, and, with the exception of the bogs, has a fertile clayey soil. The bogs are less subdivided in this county than in most of the others. Kildare has a considerable export of grain and flour by means of the river Liffey and the Royal and Grand canals and their branches. The rivers Liffey and Boyne traverse a portion of the county, and two rivers intersect it. Cotton and woollen fabric and paper are manufactured to a limited extent. Near the centre of the county is a tract of 4,858 acres, the property of the government, and called the Curragh of Kildare, used for military camps of exercise, and having one of the best race courses in the kingdom.

The principal towns are Naas, the capital, and Kildare.

**DEER**, an American plover, so called from its cry, which resemble the sounds "kildee, kildee, dee, dee, dee;" it is the *Charadrius vociferus*.

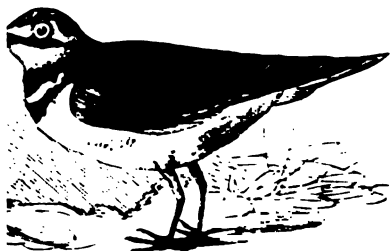

Killdeer (*Charadrius vociferus*).

(Linn.) or the genus *agialitis* (Boie). The Killdeer is about 10 in. long, with an extent of wings of 20, the bill 1 in., and the weight 6 oz. The head is small, the neck short, body rather slender, wings reaching to the end of the long tail, and hind tibia bare con-

siderably above the joint, and toe wanting. The bill is black, the edges of the lids bright red, the iris dark brown, and the feet grayish blue; the head above and upper parts of the body light brown with a greenish tinge; rump and upper tail coverts rufous; lower parts white; ring on neck and wide band on breast black; quills brownish black, with about half their inner webs white; white spots on the shorter primaries, and the secondaries edged with the same; the four middle tail feathers white tipped, with a wide subterminal black band, and the lateral ones widely tipped with white; the whole upper plumage is sometimes edged with rufous. The bird is common throughout North America, most abundant inland, going to the south in winter, and to the islands of the Atlantic and Pacific. It is very wary, the small flocks when feeding posting a sentinel to warn them of danger; when alarmed it is very noisy, uttering rapidly the notes which have given it its name. Its chief resorts are newly ploughed fields, the banks of clear rivers, and elevated worn-out grounds, where it feeds on worms, grasshoppers, beetles, small crustaceans, and snails; toward winter it approaches the seashore, and at the south is fond of the sugar, cotton, and rice fields, and of marshes, mud flats, and oyster beds. The flight is strong and rapid, whether at high or low elevations, and the speed in running is such as to have become proverbial; the large eyes indicate its habit of feeding by night as well as by day. It breeds in the southern states about the beginning of April, and a month later in the middle states; the nest is either a hollow in the earth or is made of grass on the ground; the eggs, usually four, are 1½ by 1¼ in., cream-colored with irregular purplish brown and black blotches; the parents adopt various devices to divert attention from their nest. The flesh, unless of the young in early autumn, is indifferent, though it is eaten at all seasons of the year.

**KILIMANJARO** (properly *Kilima Njaro*, snow mountain), the highest known mountain in Africa, situated in the Jagga country, on the border of Zanguebar, about 180 m. from the coast, in lat. 3° 40' S., lon. 86° E. It is crowned with perpetual snow, and its summit is 20,065 ft. above the level of the sea. It was discovered in 1848 by Rebmann.

**KILKENNY**. I. An inland county of Ireland, in the province of Leinster, bordering on Queen's, Carlow, Wexford, Waterford, and Tipperary counties; area, 796 sq. m.; pop. in 1871, 109,802. The surface is generally level, but diversified with some hills, which rise to the altitude of 1,000 ft. The county is intersected by the river Nore, and bounded respectively E. and S. by the rivers Barrow and Suir. The soil is mostly a light fertile loam. Anthracite coal of inferior quality abounds. Fine black marble is quarried near the town of Kilkenny. Various stone piles of the pagan era, cromlechs, and cairns are found in this county,

chiefly on the summits of hills. It is divided into ten baronies. II. A city, capital of the county, and a county in itself, situated on the



St. Canice's Cathedral, Kilkenny.

river Nore, 63 m. S. W. of Dublin, and 30 m. N. by W. of Waterford; pop. in 1871, 15,609. It is well built, paved, lighted, and supplied with water. The principal buildings are the cathedral of St. Canice or Kenny, erected in the 12th century, and having a round tower 100 ft. high adjoining its S. transept; a Roman Catholic cathedral, two Episcopal parish churches, six Catholic chapels, two monasteries, a convent, several Presbyterian and Methodist places of worship, the ruins of a Franciscan monastery, prisons, work-house, barracks, and a castle built by Strongbow. Its educational institutions include the Kilkenny college or grammar school, where Swift, Congreve, Farquhar, Bishop Berkeley, and other distinguished persons studied; and St. Kyran's Roman Catholic seminary for the education of young men destined for the priesthood.

**KILLARNEY**, a market town and parish of Ireland, county Kerry, 44 m. N. N. W. of Cork; pop. of the town (which lies partly in the parish of Aghadoe) in 1871, 5,187. It is an unattractive place, containing several hotels, a nunnery, a dispensary, a fever hospital, an almshouse, and several churches and chapels, including a handsome Roman Catholic cathedral. It is situated about 1½ m. E. of a chain of three lakes famous for their picturesque beau-

ty, and much resorted to by tourists. The upper or southernmost lake is 2½ m. long ½ m. wide. It contains 12 islets, and is intersected by a circuitous stream with the mill Muckcross, or Torc lake, 1½ m. long. The lakes communicate by three passages with the lower lake, called also Lough Leane, which is 4 m. long and 2 m. broad, and contains several islands. On the peninsula between the middle and lower lakes are the picturesque ruins of Ross castle, a fortress of the 15th century, and the remains of Muckcross abbey. On the W. and S. E. shores rise high mountains, intersected by wild ravines, through which flow several beautiful springs. O'Sullivan's cascade, on the W. shore of Lough Leane, consists of several distinct falls between high overhanging rocks.

**KILLIGREW**. I. Sir William, an English nobleman, born at Hanworth, Middlesex, in 1605, died in London in 1693. He was educated at St. John's college, Cambridge, and became governor of Pendennis castle in Cornwall, and after that gentleman usher to Charles I. When the civil war broke out he was made a captain in the royal horse guards, and at the restoration gentleman usher to Charles II., and subsequently first vice chamberlain, which office he held for 22 years. He was buried in Westminster abbey. He wrote "The Siege of Urban," "Selindra," "Ormasdes, or Love and Friendship," and "Pandora," dramas published at Oxford in 1666, and much praised by Waller. In his old age he wrote "A Midnight Thought," &c., and "Midnight Daily Thoughts." II. Thomas, an English dramatist, brother of the preceding, born at Hanworth in 1611, died in London in 1680. After visiting France, Spain, and Italy, he



Ruins of Ross Castle, Killarney.

came page of honor to Charles I., and was afterwards restoration groom of the bedchamber to Charles II., whose exile and privations he had sh-

and over whom, by his coarse licentious wit, he had acquired great influence. He was the author of 11 plays, a complete edition of which appeared in 1664. **III. Henry**, an English divine, brother of the preceding, born at Hanworth in 1612; the date of his death is uncertain. He was educated at Christchurch, Oxford. When only 17 years old he wrote a tragedy called "The Conspiracy" (reprinted in 1653 under the title of "Pallantus and Eudora"). After the restoration he became almoner and chaplain to the duke of York. **IV. Anne**, daughter of the preceding, born in London in 1660, died in June, 1685. She was noted for her virtues, beauty, and accomplishments, but is still better known by the ode which Dryden wrote to her memory. She was "excellent in the sister arts of poesy and painting," and painted a portrait of the duke of York (afterward James II.) and his duchess, to whom she was a maid of honor. A volume of her poems was published in 1686.

**KILMARNOCK**, a parliamentary and municipal borough of Ayrshire, Scotland, 12 m. N. N. E. of Ayr, 20 m. S. W. of Glasgow, and 8 m. from the seaport of Troon, with all of which it is connected by railway; pop. in 1871, 22,952. The town possesses some handsome public buildings, 18 churches, an academy, several public libraries, a picture gallery, a mechanics' institute, &c. It is famed for the manufacture of woollen shawls, carpets, worsted goods, gauzes, muslins, hosiery, and shoes.

**KILOGRAMME**. See **GRAMME**.

**KILWA**, or **Quilwa**, a town of E. Africa, on an island off the coast of Zanguebar, in lat. 8° 57' S., lon. 39° 37' E.; pop. about 7,000. It is tributary to the sultan of Zanzibar, and has much declined in importance and population since its devastation by the Portuguese early in the 16th century. It is now chiefly known as one of the principal ports for the exportation of slaves; nearly 100,000 were sent in the five years 1862-7 to Zanzibar and other places, and about 15,000 were exported in the year ending August, 1869. These statistics were submitted at a public meeting held in London, June 5, 1874, for the suppression of the slave trade in accordance with Sir Bartle Frere's negotiations in 1873 with the sultan of Zanzibar. The name Kilwa is also applied to the island and to other adjacent localities, and the surrounding region is watered by many important rivers and noted for its unhealthy character.

**KIMBALL, Richard Barleigh**, an American author, born at Plainfield, N. H., Oct. 11, 1816. He graduated at Dartmouth college in 1834, studied law, and after visiting Europe, and spending some time at the continental universities, he entered upon the practice of law, first at Waterford, N. Y., and then in New York city. His works, besides lectures, pamphlets, and contributions to periodicals, are: "St. Leger, or the Threads of Life" (New York and London, 1849); "Letters from England;" "Letters from Cuba" (New York, 1850);

"Cuba and the Cubans" (1850); "Romance of Student Life abroad" (1853); "Under-currents of Wall Street" (1862); "Was He Successful?" (1863); "In the Tropics" (1863); "The Prince of Vashna" (1865); "Henry Powers, Banker" (1868); and "To-day" (1869).

**KIMBLE**, a W. county of Texas, drained by the head waters of Llano river; area, about 1,400 sq. m.; pop. in 1870, 72. It has a rugged surface, with an alternation of narrow valleys and rocky highlands, and abounds in limestone and other building materials. The soil is of good quality, but better adapted to grazing than tillage. Good timber is abundant.

**KIMHI**, or **Kimchil, David**, a Hebrew scholar of southern France, born probably at Narbonne, flourished in that city in the earlier part of the 18th century. He was the son of Rabbi Joseph Kimhi, a distinguished Biblical commentator, and the younger brother of Moses Kimhi, an eminent grammarian. Both of them were eclipsed by David, whose exegetical and linguistic writings are to this day considered standard works by Hebrew students. They include a Hebrew grammar (*Sepher mikhalol*, Constantinople, 1583; Venice, 1545, &c.), a Hebrew dictionary (*Sepher hashshorashim*, Naples, 1491; Venice, 1529, &c.), a defence of Maimonides, and commentaries on the prophets, the Psalms, and some other portions of the Scriptures, which have appeared in various Bible editions.

**KINCARDINESHIRE**, or **The Mearns**, a maritime county of Scotland, bordering on Aberdeenshire, Forfarshire, and the North sea; area, 394 sq. m.; pop. in 1871, 34,651. Geographically the county is divided into the Grampians or hill district, Deeside, the valley or "howe" of the Mearns, and the coast side. Mount Battock, the highest point of the Grampians in Kincardineshire, is 2,500 ft. high. The principal rivers are the Dee, North Esk, Bervie, and Dye. The county is mainly agricultural. There are manufactures of linen and of a peculiar kind of woollen tartan wares of beautiful workmanship. On the coast there are about a dozen fishing villages. Capital, Stonehaven.

**KINDERGARTEN**. See **INFANT SCHOOLS**.

**KINESIPATHY**. See **LING, PETER HENRIK**.

**KING** (Ger. *König*; A. S. *cyng* or *cynig*), a title of dignity designating the supreme ruler of a nation or country. The etymology of the word is far from being settled, some deriving it from the old Gothic *kuni*, family or (noble) race; others from roots like *know*, *can*, *ken*, denoting ability; while others compare it with *khan* and other eastern terms of similar meaning. The Romance languages all use words little altered from the Latin *rex* (ruler), which was the title of the first seven sovereigns of Rome, while those who followed the fall of the republic assumed that of *imperator* (commander), now altered into our emperor. The difference between king and emperor, and between kingdom and empire, is not always one

of power or extent, but is sometimes the result of historical developments. Thus Louis XIV. and Louis Philippe were satisfied with the title of king, while the sovereign successor to the unaltered dominions of the latter, Napoleon III., assumed that worn by the conqueror from whom he derived his historical claims to power. Soulouque of Hayti, who like both Napoleons paved his way to the throne by a *coup d'état*, also chose the title of emperor. In Europe there were 12 kingdoms in 1874: Great Britain and Ireland, Italy, Sweden and Norway, Belgium, Portugal, Holland, Denmark, Greece, Prussia, Bavaria, Saxony, and Würtemberg; the last four, however, being included in the German empire. Besides these there are other kingdoms in Europe which, having in various degrees lost their independence, have maintained their title, adding it to those of the other possessions of their rulers. Thus the emperor of Russia is king of Poland, and the emperor of Austria king of Bohemia, while Hungary forms as a kingdom a constituent half of the latter empire. There are also some titles preserved by houses who have lost the possessions to which they were attached. The emperor of Austria styles himself king of Jerusalem, and the king of Sweden also king of the Vandals. The royal dignity in Europe is now everywhere hereditary. Formerly there were elective kings of Poland, Hungary, and other countries; those of Poland were little more than presidents for life of a republic. The successor elect of the German emperors was called king of Rome; the same title was bestowed by Napoleon I. on his son. The period of Napoleon was productive of new kingdoms, of which some, as Westphalia and Etruria, were short-lived.

**KING**, a N. W. county of Washington territory, bounded E. by the Cascade mountains, and W. by Admiralty inlet; area, 1,800 sq. m.; pop. in 1870, 2,120. It has numerous harbors. The principal rivers are the White, Snoqualmie, Dwanish, and Green, which are bordered by good agricultural land. Lake Washington is a large body of fresh water, bordered by lands rich in coal, which is mined. The W. part is interspersed with prairies, forests, and lakes. The Snoqualmie pass, 3,700 ft. high, crosses the Cascade range in this county. The falls of Snoqualmie attract many tourists. The chief productions in 1870 were 3,872 bushels of wheat, 14,135 of oats, 2,817 of barley, 42,981 of potatoes, 34,755 lbs. of butter, and 1,884 tons of hay. There were 305 horses, 628 milch cows, 947 other cattle, and 891 swine; 1 brewery, 1 planing mill, 1 flour mill, and 2 saw mills. Capital, Seattle.

**KING, John Crookshanks**, an American sculptor, born at Kilwinning, Ayrshire, Scotland, Oct. 11, 1806. He was educated as a practical machinist, emigrated to the United States in 1829, and was employed for several years in Cincinnati and Louisville as superintendent of a factory. In 1834, at the suggestion of Hiram

Powers, he made a model in clay of the head of his wife, and the success with which the work was accomplished encouraged him to adopt the profession of a sculptor. From 1837 to 1840 he resided in New Orleans, and modelled a number of busts of public men and made cameo likenesses. Subsequently he removed to Boston, where he now lives. He has executed several busts of Daniel Webster, also those of John Quincy Adams, Dr. Samuel Woodward, Professor Agassiz, Ralph Waldo Emerson, and other men prominent in public life or literature. Since 1860 he has executed for the city of Boston a bust of Chief Justice Shaw; but with the exception of a few busts of private individuals, he has mainly been engaged on cameos of Webster, Franklin, Grier-son, Audubon, Com. Morris, J. Q. Adams, Horace Greeley, Sumner, Lincoln, Washington, and others, and is now (June, 1874) executing a cameo of Agassiz.

**KING, Peter**, lord, an English chancellor, born in Exeter in 1669, died at Ockham, Surrey, July 22, 1734. His mother was a sister of the philosopher Locke. He studied at Leyden, was called to the bar, was elected to parliament in 1699 for Beer-Alston, Devonshire, was appointed in 1709 one of the managers to conduct the impeachment of Sacheverell, and a few years later acted as counsel in defence of Whiston. Soon after the accession of George I. he was made chief justice of the common pleas, and a privy councillor; and in June, 1723, on the removal of the earl of Macclesfield, he became lord chancellor, with the title of Baron King of Ockham. He held office till November, 1733, when ill health compelled him to resign. More of his decrees are said to have been set aside than of any former chancellor. He wrote "Inquiry into the Constitution, Discipline, Unity, and Worship of the Primitive Church" (London, 1691), and "Critical History of the Apostles' Creed" (1702).

**KING, Philip Parker**, a British admiral, born on Norfolk island, Dec. 13, 1793, died at Grantham, near Sydney, Australia, in February, 1855. He was the son of a naval officer, and entered the navy in 1807. In 1817 he was intrusted with the conduct of an expedition to Australia, returning to Europe in 1823, when he published the results of his survey of the inter-tropical and western coasts; the atlas to this work was issued by the hydrographical office at the admiralty. In 1825 he was appointed to survey the S. coast of America, from the entrance of the Rio de la Plata round to Chiloe, and of Tierra del Fuego, and published in 1832 "Sailing Directions to the Coasts of Eastern and Western Patagonia, including the Straits of Magelhaen and the Sea Coast of Terra del Fuego." Afterward he returned to Australia, where he was elected to the legislature in 1861. Shortly before his death he was appointed rear admiral of the blue, being the first instance of a native of Australasia rising to so high a rank in the navy.

**KING, Rufus**, an American statesman, born in Scarborough, Me., in 1755, died in Jamaica, L. I., April 29, 1827. His father, Richard King, a successful merchant, gave him the best education then attainable. He was admitted to Harvard college in 1773, graduated in 1777, and went to Newburyport to study law under the direction of Theophilus Parsons. In 1778 he served as aide-de-camp to Gen. Glover in the brief and fruitless campaign in Rhode Island. He was admitted to the bar in 1780, and at once entered upon a successful practice in Newburyport. He was an ardent patriot, and in 1782 was chosen a member of the general court or legislature. In that body, to which he was repeatedly reelected, he took a leading part, and successfully advocated, against a powerful opposition, the granting of a 5 per cent. impost to the congress, as indispensable to the common safety and the efficiency of the confederation. In 1784 he was chosen by the legislature a delegate to the continental congress, then sitting at Trenton. He took his seat in December, and in March, 1785, moved a resolution: "That there be neither slavery nor involuntary servitude in any of the states described in the resolution of congress of April, 1784, otherwise than in punishment of crime whereof the party shall have been personally guilty; and that this regulation shall be made an article of compact and remain a fundamental principle of the constitution between the original states and each of the states named in said resolves." This resolution was, by the vote of seven states (New Hampshire, Massachusetts, Rhode Island, Connecticut, New Jersey, Pennsylvania, and Maryland) against four (Virginia, North Carolina, South Carolina, and Georgia), referred to a committee of the whole, where for the time it slept. The ordinance offered by Thomas Jefferson in the previous year (April, 1784) proposed the prospective prohibition of slavery in the territories of the United States after the year 1800; Mr. King's proposition was for its immediate, absolute, and irrevocable prohibition. When, two years afterward, the famous ordinance of freedom and government for the N. W. territory was reported by Nathan Dane of Massachusetts (July 11, 1787), Mr. King, who was a member of that congress (then sitting in New York), had gone to Philadelphia to take the seat to which he had been elected by Massachusetts as a member of the convention for framing a constitution for the United States; but his colleague embodied in the draft of his ordinance the provision, almost word for word, which Mr. King had laid before congress in March, 1785. While occupied with his duties as a member of congress, he was designated by his state as one of the commissioners to determine the boundary between New York and Massachusetts, and was empowered with his colleague to convey to the United States the large tract of lands beyond the Alleghanies belonging to his state. On Aug. 14, 1786, Rufus King and James Monroe

were appointed a committee on behalf of the congress to wait upon the legislature of Pennsylvania and explain to them the embarrassments of the finances of the United States, and to urge the prompt repeal by that state of the embarrassing condition upon which it had voted its contingent of the 5 per cent. impost levied by the congress on all the states. The speech of Mr. King on this occasion, though no notes of it remain, is commemorated as most effective and brilliant. On May 25, 1787, he took his seat in the federal convention. The journals of the convention and the fragments of its debates which have come down to us attest the active participation of Mr. King in the important business before them; and, although one of the youngest members of that body, he was selected as one of the committee of five to which it was finally referred to "revise the style of, and arrange the articles" agreed on for the new constitution. Having signed the constitution as finally adopted, Mr. King went back to Massachusetts, and was immediately chosen a delegate to the state convention which was to pass upon its acceptance or rejection. Fierce opposition was made in that convention to this instrument, Mr. King successfully leading the array in defence. In 1788 he took up his permanent residence in New York, where in 1786 he had married Mary, daughter of John Alsop; and in the following year he was elected a representative of that city in the assembly of the state. In the summer of the same year he was chosen by the legislature the first senator from the state of New York under the new constitution, having for his colleague Gen. Schuyler. In this body he took rank among the leaders of the federal party. In the bitter conflict aroused by Jay's treaty he was conspicuous in its defence, both in the senate and as the joint author with Alexander Hamilton of a series of newspaper essays, under the signature of Camillus. In 1795 he was reelected to the senate, and while serving his second term was nominated by Washington minister plenipotentiary to Great Britain, having previously declined the office of secretary of state, made vacant by the resignation of Edmund Randolph. He embarked with his family at New York in July, 1796, and for eight years ably fulfilled the duties of the office. No foreign minister was probably more sagacious in ascertaining or divining the views and policy of nations, or more careful in keeping his own government well informed on all the public questions of the day. His diplomatic correspondence is a model both in style and in topics. The federal party having lost its ascendancy in the public councils, Mr. King, shortly after Mr. Jefferson's accession, asked to be recalled. He was however urged by the president to remain, as he had in hand important negotiations. The recurrence of war in Europe, consequent upon the rupture of the peace of Amiens, leaving little hope of success on the point to which his efforts had been chiefly directed, that of so-



curing our seamen against impressment, he renewed his request to be relieved; and accordingly a successor was appointed, and Mr. King returned to his country in 1804, and withdrew to a farm at Jamaica, L. I. In 1813, during the war with Great Britain, he took his seat for the third time as United States senator. Yielding no blind support to the administration, and offering to it no partisan opposition, he yet was ever ready to strengthen its hands against the common enemy. When the capitol at Washington was burned by the British forces, he resisted the proposal to remove the seat of government to the interior, and rallied the nation to defend the country and avenge the outrage. His speech on this occasion in the senate was one of those that marked him as a great orator. At the close of the war he applied himself to maturing the policy which should efface its evils as speedily as possible, and build up permanent prosperity. To a bill, however, for a United States bank with a capital of \$50,000,000, he made earnest opposition. He resisted the claim of Great Britain to exclude us from the commerce of the West India islands; and to his intelligent exposition of the laws of navigation and of the mercantile interests and rights of the United States we are indebted for the law of 1818. He likewise early discerned the danger of the sales on credit of the public lands, and by his bill substituting cash payments and a fixed but reduced price for these lands, and stipulating a remission of interest and of a portion of the principal of the debt then due therefor, he averted a great political peril, and gave order and security to the receipts from the sale of those lands. In 1819 he was reelected to the senate, as in the previous instance by a legislature of adverse politics to his own. In 1816 he had been, without his knowledge, named as the candidate of the federal party for governor of New York. He reluctantly accepted the nomination, but was not elected. Shortly afterward the so-called Missouri question began to agitate the nation. Mr. King was pledged against the extension of slavery; and when therefore Missouri presented herself for admission as a state with a constitution authorizing the holding of slaves, he was inexorably opposed to it. The state of New York, by an almost unanimous vote of its legislature, instructed him to resist the admission of Missouri as a slave state; and the argument made by Mr. King in the senate, though but partially reported, has been the repertory for almost all subsequent arguments against the extension of slavery. He also opposed the compromise introduced by Mr. Clay, which partially yielded the principle, and voted to the last against it. His fourth term in the senate expired in March, 1825, when he took leave of that body, and as he hoped of public life, in which for 40 years he had been engaged. One of his latest acts was to present a resolution, Feb. 16, 1825: "That as soon as the portion of the existing

funded debt of the United States for the payment of which the public land of the United States is pledged shall have been paid off, then and thenceforth the whole of the public land of the United States, with the net proceeds of all future sales thereof, shall constitute and form a fund which is hereby appropriated, and the faith of the United States is pledged that the said fund shall be inviolably applied, to aid the emancipation of such slaves within any of the United States, and to aid the removal of such slaves and the removal of such free persons of color in any of the said states, as by the laws of the states respectively may be allowed to be emancipated or removed to any territory or country without the limits of the United States of America." The resolution was read, and, on motion of Mr. Benton of Missouri, ordered to be printed. John Q. Adams, now become president, urged Mr. King to accept the embassy to England, with which country unadjusted questions of moment were pending, and which the president believed Mr. King was specially qualified to manage. He reluctantly accepted the mission: but his health gave way, and after a few months spent in England, where he was warmly welcomed, he resigned and came home.—His son JOHN ALSOR, born in New York, Jan. 3, 1798, was several times elected to the state legislature, was a member of congress in 1840-51, and governor of the state in 1857-9. He was for many years president of the state agricultural society, and died in Jamaica, Long Island, July 8, 1867.—His second son, CHARLES, born in March, 1789, was for some time a merchant, member of the legislature in 1813, from 1833 to 1845 editor of the "New York American," afterward associate editor of the "Courier and Enquirer," and from 1849 to 1864 president of Columbia college. He died in Frascati, Italy, Sept. 27, 1867. He was the author of a "Memoir of the Croton Aqueduct" (1843), "History of the New York Chamber of Commerce," "New York Fifty Years Ago," and other historical pamphlets.

**KING, Thomas Starr**, an American clergyman, born in New York, Dec. 16, 1824, died in San Francisco, March 4, 1864. He was preparing to enter Harvard college when the sudden death of his father left the family in a measure dependent upon him, and from the age of 13 to 20 he was employed either as a clerk or schoolmaster, devoting his leisure hours to theological studies. In September, 1845, he preached for the first time in the town of Woburn, and in 1846 he was settled over his father's former parish in Charlestown, whence he was called in 1848 to the Unitarian church in Hollis street, Boston, with which he remained connected until the early part of 1860. In April of the latter year he sailed for San Francisco, to take charge of the Unitarian congregation in that city. Apart from his labors in the pulpit, he acquired an extended reputation as a lecturer, and for 15 years addressed large audiences every

winter in nearly all the northern states. When California seemed in danger of seceding, he travelled over the state, speaking enthusiastically in favor of the Union; and her loyalty is largely attributed to his eloquence. He also labored earnestly and effectively in behalf of the sanitary commission. He published "The White Hills, their Legends, Landscape, and Poetry" (4to, illustrated, 1859), and a number of articles in reviews, pamphlets, and sermons. A volume of his writings, entitled "Patriotism and other Papers," was published in 1864, and Richard Frothingham wrote "A Tribute to Thomas Starr King" (Boston, 1864).

**KING, William**, an Irish bishop, born in Antrim in 1650, died in Dublin, May 8, 1729. He was educated at Trinity college, and ordained in 1674. In 1688 he became dean of St. Patrick's, but having taken a prominent part in the controversies of the time, and in opposition to the policy of the government, he was, after the revolution and the landing of James II. in Ireland in 1689, imprisoned in Dublin castle. On the departure of James he was liberated and restored to his deanery. In 1691 he was promoted to the see of Derry, and in 1702 became archbishop of Dublin. He was the author of many theological and controversial works, the most important of which is his treatise *De Origine Mali* (1702), which provoked attacks from several formidable antagonists, among whom were Leibnitz and Bayle.

**KING, William Rufus**, an American statesman, 13th vice president of the United States, born in Sampson co., N. C., April 6, 1786, died in Dallas co., Ala., April 17, 1853. He entered the university of North Carolina at the age of 12, graduated in 1803, and was admitted to the bar in 1806. He was elected to the legislature in 1806, and was reelected in 1807; but at the meeting of the legislature he was appointed state solicitor for the Wilmington circuit, which office he held for two years, when he resigned. In 1809 he was again elected to the legislature. In 1810 he was elected to congress, and was twice reelected. In congress he united himself with Clay, Calhoun, and others, who advocated the war policy of Mr. Madison's administration, and voted for the declaration of war in June, 1812. In the spring of 1816 he resigned his seat to become secretary of legation to Naples under William Pinckney, whom he accompanied in the same capacity to St. Petersburg. In the autumn of 1818 he returned home, and removed to Dallas co., Ala., where he continued to reside until his death. In 1819 he was elected to the convention to form a constitution and a state government for Alabama, and was chosen one of the United States senators from the new state, drawing the short term of four years. He was successively reelected in 1823, 1828, 1834, and 1840. During all this time he acted uniformly with the democratic party. In April, 1844, he was appointed by President Tyler minister to France. The proposition for

the annexation of Texas was then pending, and Mr. King successfully exerted himself to prevent a joint protest of France and England against it. He returned to the United States in November, 1846. In 1848 he was again elected United States senator to fill a vacancy, and in 1849 for a full term. In 1850, on the accession of Vice President Fillmore to the presidency after the death of Gen. Taylor, Mr. King was unanimously elected president of the senate. In 1852 he was elected vice president of the United States, at the time Franklin Pierce was elected president. In January, 1853, he went to Cuba for the benefit of his health, and by a special act of congress the oath of office as vice president was administered to him by the American consul general at Havana. In April he returned home.

**KING AND QUEEN**, an E. county of Virginia, bounded S. W. by Mattapony and York rivers, and E. by the Piankatomk; area, 835 sq. m.; pop. in 1870, 9,709, of whom 5,488 were colored. The surface is moderately uneven. The soil is not very fertile, but may be improved by the application of marl, of which the county contains large quantities. The chief productions in 1870 were 28,172 bushels of wheat, 204,906 of Indian corn, 19,771 of oats, and 30,733 lbs. of butter. There were 770 horses, 1,600 milch cows, 1,289 working oxen, 1,830 other cattle, 2,036 sheep, and 5,754 swine. Capital, King and Queen Court House.

**KING AT ARMS.** See HERALDRY.

**KING BIRD**, an American flycatcher of the genus *tyrannus* (Cuv.), and species *T. Carolinensis* (Baird) or *T. intrepidus* (Vieill.); other names given to it are tyrant flycatcher and bee martin. This bird is 8½ in. long, with an extent of wings of 14¼; the bill is stout, shorter than the head; the wings long and pointed,



King Bird (*Tyrannus Carolinensis*).

the outer primaries abruptly attenuated near the end; tail shorter than the wings, slightly rounded; on the crown a concealed patch of vermilion feathers edged with white and orange, capable of erection as a crest. The color above is dark bluish ash; below white, tinged

with bluish ash on the sides of the throat and across the breast; the wings dark brown, the greater coverts and quills edged with white; tail broadly margined and tipped with white. It is found throughout eastern North America to the Rocky mountains, and in Washington territory. According to Audubon, the king bird arrives in Louisiana from the south about the middle of March; it proceeds gradually to the north, going back about the last of August. It prefers orchards, fields of clover, and the vicinity of houses, being seldom found in woods; the flight is rapid, performed by alternate flappings and sailings, much in the manner of our robin. The intrepidity of the king bird is remarkable, as it does not hesitate to attack the crow, vultures, hawks, eagles, and even cats and other animals approaching the nest, plunging upon their backs and striking with the bill; it is the farmer's friend in protecting eggs from the crow and chickens from the hawk, and in devouring noxious insects; and yet on account of its eating a few bees, raspberries, and figs, it is very generally persecuted. The nest is made in trees, and the eggs, four to six, are reddish white with irregular spots of brown. The notes are tremulous and sharp, and uttered continuously during flight. Many are shot in the southern states, where their flesh is considered a delicacy.

**KING CRAB**, or **Horse-shoe Crab**, a common name for the limuloid group of the entomostreacan order of crustaceans, from their large size and peculiar form. This order is the lowest of the class, as the segments and feet are fewer than in the other orders. In the genus *limulus* (*xiphosura*, Milne-Edwards), the tail is reduced to a mere spine, and the bases of the first six pairs of legs, being rough with points, perform

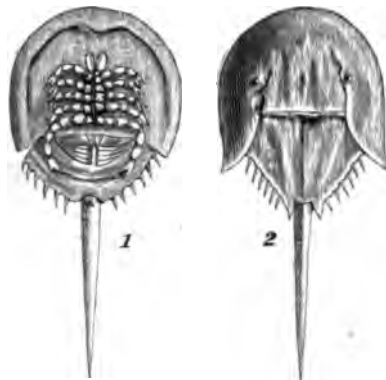

King Crab—1. Lower surface. 2. Upper surface.

the functions of jaws, their free extremities ending in nipping claws. The whole upper surface is protected by a kind of buckler, made up of an anterior semicircular shield, and a posterior hexagonal plate, to the hinder margin of which is jointed the long sharp spine of the

tail; the branchial appendages are on the under surface of the posterior plate. The *Limulus* king crab attains a size of 2 to 3 ft., and both eggs and flesh are eaten by the Malays; the spine attached to a spear makes a formidable weapon. Our common species (*limulus polyphemus*) also grows very large on the Atlantic coast of the middle states, and is of a blackish brown color; its flesh is sometimes given to pigs and poultry, but, while it fattens them, imparts a bad flavor to their meat; on the New England coast the size is small, and their delicate yellowish cast-off shells are frequently thrown upon the beaches. The legs are feeble, and the use of the tail seems to be to enable it to turn over by a kind of spring, should its wide flat body be thrown by the waves upon its back; the anterior limbs in the male are short, stout, and swelled, with nippers for holding the female. The eggs, fertilized in summer as they are extruded, are placed in a hole excavated in the sand on the edge of high tide, the sand at once covering them; their hatching is thus aided by the heat of the sun until the tide rises again. The eggs of the king crabs are very tenacious of life. The extinct *eurypterids* are closely allied, and some, as *pterygotus*, attained a length of 6 ft. Dr. Packard, in the "Memoirs and Proceedings of the Boston Society of Natural History," 1870-72, and "Proceedings of the American Association for the Advancement of Science," 1870, has shown that the larva, which hatches in about six weeks, bears a striking resemblance to the trilobites; he therefore regards the *pacilloptera*, or the king crab and its allies, as a subdivision of the branchiopods. Prof. Van Beneden, on the contrary (1872), thinks that the king crabs are not crustaceans, having none of their characteristic phases of development, but show the closest resemblance to scorpions and other arachnids; and that trilobites, *eurypterids* and *pacilloptera*, must form with the arachnids a distinct division. Considering the paleozoic trilobites as the lowest, the next series in time and in rank would be such forms as *eurypterus* and *pterygotus*, the *limulus* or king crab being the highest, and beginning to appear as the trilobites were dying out; some forms of trilobites had a spiny tail like *limulus*.

**KING FISH**, the common name of the perch-like, sciænioid fishes of the genus *umbra*, especially the *U. nebulosa* (Storer) or *U. alburnus* (De Kay), the former being regarded by Storer as the northern and the latter as the southern species. It is of a dull gray color, with silvery reflections on the sides and irregular dark bars, one broad, one extending straight backward from the end of the pectorals to the tail: beneath, yellowish; extremities of first dorsal, pectorals, and ventrals white, rays black, second dorsal and base pectorals and ventrals yellowish. Body elongated, snout blunt, lips fleshy, jaws with numerous small card-like teeth; small fleshy cirrus under chin; length 16 to 17 in.; weight 1 to 2 lbs. It is a deep

mer and a good table fish, and is often whiting. It is rare on the New Eng-



King Fish (*Umbrina nebulosa*).

coast, but common in the waters of the States.

**KINGFISHER**, an extensive family of birds, a lengthened, generally straight bill, broad base with acute tip, rounded wings, short strong and short tarsi. The family includes, according to Gray, the subfamilies *bucconinae* or puff birds of tropical America; the *tinamou* or jacamars, also South American, usually treated; *halcyoninae* or kinghunters, going to the old world; and the *alcedininae* kingfishers, distributed the world over. The family of kingfishers contains the genera *Alcedo* (Linn.), *alcyon* (Swains.), and *ceryle* (Linn.), with a long, straight, and slender bill, the culmen sloping to the acute tip. In the kingfishers the wings are short, with the first quill as long as the second and third, which are equal and longest; tail short, broad, and rounded; tarsi very short and robust; toes unequal, the middle one longest, and the inner short; the claws short and curved. The species of this genus are found in most parts of the old world, where they frequent fresh-water rivers and lakes, perching solitary on an overhanging branch, or skimming near the surface in pursuit of their fish prey; they



European Kingfisher (*Alcedo ispida*).

sometimes plunge from a branch, and at others times hover over a spot, suddenly pouncing on a fish

as it rises to the surface; they catch the fish with the bill, and swallow it whole, head foremost, unless it be too large, in which case they beat it to pieces and swallow the separate fragments. The nest is made at the end of a long gallery which they excavate in the sandy or clayey banks of rivers by their bill and feet, and the eggs, six or seven in number, are placed on ejected pellets of fish bones. The common kingfisher of Europe (*A. ispida*, Linn.) is about 7 in. long, with a long sharp bill, stout body, and short wings; it possesses many of the brilliant colors of tropical birds, the upper back being dark green, the lower back and rump bright blue; the upper part of the head, wing coverts, and stripe on each side of neck, green with numerous light blue spots; throat and neck stripe yellowish white, and lower parts pale chestnut. The eggs are pinkish white, and are placed in holes in river banks. The bird is the halcyon of the ancients, from whose period and habits of incubation arose the term "halcyon days."



Belted Kingfisher (*Ceryle alcyon*).

Some of the older writers even attributed to the kingfisher the power of arresting the violence of the waves. In some parts of Europe it is still believed that the breast of a kingfisher suspended by the bill will always be turned to the north, that when accurately balanced the bill will point in the direction of the wind even within doors, and that its head and feathers protect against witches and storms at sea, and are a sure means of securing the affections of a loved object. The flight is direct and rapid, and its note sharp and piercing and emitted on the wing. The genus *alcyon* (Swains.) has no inner toe; its few species are found in Australia and the Indian archipelago; their habits are the same as in the preceding.—The common kingfisher of this country belongs to the genus *ceryle* (Boie); this comprises several species, many of which are found in Africa and India; the tail is long and rounded, the tarsi uncommonly short and stout, and the inner toe much longer than the hinder. The belted kingfisher (*C. alcyon*, Boie) is found

throughout North America; the length is about 13 in. and the extent of wings 22; the head has a long crest; the color is blue above, without metallic lustre; a concealed band across the back of the head, a spot before the eye, and the lower parts white; a band across the breast, and the sides under the wings, blue like the back; primaries white on the basal half; tail transversely banded and spotted with white. In the young birds there is a light chestnut band on the breast below the blue one, which last is more or less tinged with chestnut. Specimens from the Pacific coast are considerably the largest. It is a constant resident in the southern states; its flight is rapid, and it often suddenly stops like a sparrow hawk and hovers over the water, dashing headlong after its prey, which it carries to the nearest stump or tree and swallows instantly. It follows the course of rivers even to the cascades of their sources, and its presence near a stream is good evidence to the angler that fish are there abundant; it is fond of resorting to mill ponds, where the stillness of the water enables it easily to detect its prey. Its notes are very sharp, rapid, and rattling. The nests are made in holes dug to the horizontal depth of from 4 to 6 ft. in a bank, the entrance being just large enough to admit a bird, and the end rounded like an oven; the eggs are generally six, and pure white, and incubation lasts about 16 days, being performed by both parents; the eggs are considered good eating, though the flesh of the bird is fishy and tough. According to Audubon, this bird occasionally plunges into the sea after small fry.—The subfamily of *halcyonine* or kinghunters have the aspect and general habits of kingfishers, from which they differ principally in the broader and stouter bill. The genus *halcyon* (Leach) is found in Australia and Papua; the species are not shy, and one, the *D. gigas* (Bodd.), is 18 in. long; they go into the woods, and feed indiscriminately on any animals of suitable size, whether quadruped, bird, reptile, fish, insect, or crustacean; the colors are handsome, and the flight quick and noiseless; their powerful bills render them formidable, and they can successfully resist the smaller birds of prey; some of the species have a peculiar screaming laugh at sunrise and sunset, which has caused the name of "laughing jackass" to be given to them in Australia. The genus *halcyon* (Swains.), with about 50 species, inhabits Africa, Australia, India and its archipelago, and the South sea islands; some of these birds are very handsome, green and blue predominating; they build their nest in the hollow trunks of trees.

**KING GEORGE**, an E. county of Virginia, bounded N. and E. by the Potomac river and S. by the Rappahannock; area, 176 sq. m.; pop. in 1870, 5,472, of whom 2,812 were colored. The surface and soil are both diversified. The chief productions in 1870 were 34,463 bushels of wheat, 144,807 of Indian corn, 11,452 of oats, and 29,322 lbs. of butter. There were 848 horses, 2,706 cattle, and 2,440 swine. Capital, King George Court House.

**KINGLAKE**. I. **Alexander William**, an English author, born in Taunton in 1802. He was educated at Eton and at Trinity college, Cambridge, was called to the bar in 1837, and in a few years acquired an extensive chancery practice in London. Not long after his admission to the bar he made an extensive tour in the East, of which he wrote home many graphic descriptions. Upon his return to England he was induced to revise his letters for publication; but having attempted in vain to find a publisher, he threw the manuscript aside, and for some years thought no more upon the subject. Happening one day to be conversing with a publisher on the recent appearance of a book of travels, he offered to give him his manuscript if he would print it. The offer was accepted, and the work, published under the title of "Eöthen" (1844), was universally pronounced one of the freshest and most entertaining books of travel of the day. In 1857 he was returned to parliament for the borough of Bridgewater, and in 1860 took an active part in denouncing the annexation of Nice to the French empire. In 1868 he was again returned for Bridgewater, but was unseated on petition. After "Eöthen" he published nothing, except an article in the "Quarterly Review" on the political uses of the Mediterranean, till 1863, when the first two volumes of his history of "The Invasion of the Crimea" appeared; two more volumes were published in 1868, and a fifth in 1874, bringing the history down to and including the battle of Inkerman, the work being still unfinished. II. **John Alexander**, an English lawyer, cousin of the preceding, born in Taunton in 1805. He was educated at Eton and Cambridge, was called to the bar in 1830, made a serjeant at law in 1844, and at the same time appointed recorder of Exeter, and in 1856 of Bristol. For many years, up to 1870, he was a member of parliament for Rochester, and an extreme liberal in politics, being in favor of the vote by ballot, the abolition of church rates, and other popular measures. He has contributed articles to the reviews, and the authorship of "Eöthen" has frequently been erroneously attributed to him.



PAGE		PAGE		PAGE
	Huntsville, Texas	76	Hyperbola	184
	Hunyady, János	76	Hyperborans	185
	Huppasoli, Francesco	76	Hyparides	185
	Hurd, Richard	77	Hypertrophy	185
	Hurdwar	77	Hypasia. See Panjaub.	
	Hurlbert, William Henry	77	Hypochondriasis	186
	Hurlbut, Stephen Augustus	77	Hypophosphites	187
	Huron co., Ohio	78	Hyposulphates	187
	Huron co., Mich.	78	Hypothecation	188
	Huron co., Canada	78	Hyrax	188
	Huron, Lake	78	Hyrkania	188
	Hurons	79	Hyrnanus, John	188
	Hurricane	80	Hyrnanus II.	189
	Hurst, John Fletcher	84	Hyrri, Joseph	189
	Hurter, Friedrich Emanuel von	84	Hysop	189
	Husband and Wife	84	Hysteria	189
	Husbandry, Patrons of	89	Hythe	140
	Husbands, Herman	89		
	Hush	90	<b>I</b>	
	Huskisson, William	90	I	140
	Huss, John	90	Iamblichus	141
	Hussars	92	Ibarrá	141
	Husites	92	Iberia	141
	Hutcherson, Francis	92	Iberia parish	142
	Hutchinson co.	92	Iberus. See Ebro.	
	Hutchinson, Anne	92	Iberville parish	142
	Hutchinson, John (two)	98	Iberville co., Canada	142
	Hutchinson, Thomas	98	Iberville, Pierre le Moyne, Sieur d'	142
	Hutton, Ulrich von	94	Ibex	142
	Hutton, Charles	95	Ibicui	142
	Hutton, James	96	Ibis	142
	Huxley, Thomas Henry	96	Ibn Batuta. See Batuta.	
	Huy	97	Ibrahim Pasha	144
	Huygens, Christian	97	Ibraila. See Braila.	
	Hyalinth	99	Ibycus	145
	Hyacluthé, Père. See Loyson, Charles		Ica	145
	Hyaclinthus	100	Icarus. See Dardalus.	
	Hyades	100	Ice	146
	Hymna	100	Icebergs	148
	Hybla	102	Iceland	149
	Hybrid	102	Iceland, Language and Literature of	154
	Hydrasps. See Jhyllum, and Punjaub.		Iceland Moss	156
	Hydatids. See Entozoa, vol. vi., p. 668.		Ice Plant	157
	Hyde co., N. C.	104	Ichneumon	157
	Hyde co., Dak.	104	Ichneumon Fly	158
	Hyde, Edward. See Clarendon.		Ichthyology	158
	Hyde, Thomas	104	Ichthyosaurus	162
	Hyde de Neuville, Jean Guillaume, Baron	104	Ichmilk. See Iona.	
	Hyderabad	104	Ichnium. See Konich.	
	Hyder Ali	105	Ichnoclasts	163
	Hydra. See Hercules.		Ictinus	165
	Hydra, an island	106	Ida co.	165
	Hydrabad	106	Ida (two)	165
	Hydrangea	106	Idaho	165
	Hydrastis. See Puccoon.		Idaho co.	168
	Hydrates	107	Ideler, Christian Ludwig	169
	Hydraulic Ram	107	Ides	169
	Hydraulics. See Hydromechanics.		Idiocy	169
	Hydrocephalus. See Brain, Diseases of the, vol. iii., p. 197.		Idocrase	176
	Hydrochloric Acid	109	Idria	176
	Hydrocyanic Acid	110	Idumaea. See Edom.	
	Hydrodynamics. See Hydromechanics.		Iesi. See Jesi.	
	Hydrofluoric Acid. See Fluorine.		Iffland, August Wilhelm	176
	Hydrogen	111	Iglau	176
	Hydrography	112	Iglesias	176
	Hydroids	114	Iglesias de la Casa, Josef	176
	Hydromechanics	115	Ignatius, Saint, Theophorus	177
	Hydrometer	124	Ignatius, Saint, patriarch	177
	Hydrophobia	125	Ignatius Bean. See Strychnia.	
	Hydrophobia. See Hydromechanics.		Ignis Fatuus	177
	Hydrostatics. See Hydromechanics.		Iguanada	179
	Hydrosulphuric Acid	180	Iguans	179
	Hydruntum. See Otranto.		Iguanodon	179
	Hyères	180	Ihre, Johan	179
	Hygiea	180	Ili	179
	Hygiene	180	Iliad. See Homer.	
	Hygrometry	181	Iliiza, Pyramids of	179
	Hyksos. See Egypt, vol. vi., p. 460.		Ilion	180
	Hylosaurus	183	Iliussus	180
	Hylos	184	Ilium. See Troy.	
	Hymen	184	Ilyate	180
	Hymenoptera	184	Ilikeston	180
	Hymettus	184	Ile-et-Vilaine	180
	Hvosyanus. See Henbane.		Illinois, Indians	180
	Hyppatia	184	Illinois	181
			Illinois, a river	181
			Illuminat.	183
			Illyria	198
			Ilopango	194
			Image Worship. See Iconoclasm	
			Imbert, Barthélemi	194
			Immaculate Conception	194
			Immermann, Kari Lebrecht	196
			Immortelles	196
			Imola	197
			Imola, Innocenzio da	197
			Impachment	197
			Imphee. See Sorghum.	
			Inachus	199
			Inca. See Peru, and Quichua.	
			Incense. See Frankincense.	
			Incest	199
			Inchbald, Elizabeth	199
			Inclodon, Benjamin Charles	199
			Incunabula	199
			Independence co.	199
			Independence, Texas	199
			Independence, Iowa	199
			Independence, Mo.	199
			Independents	199
			Index Librorum	199
			India	200
			India, Races and Languages of	201
			India, Religions and Religious Literature of	201
			Indiana	201
			Indiana co.	200
			Indianapolis	200
			Indian Archipelago	200
			Indian Bean. See Catalpa.	
			Indian Corn. See Maize.	
			Indian Cress. See Nasturtium.	
			Indian Cucumber	200
			Indian Dye. See Puccoon.	
			Indian Fig. See Cactus.	
			Indian Hemp	200
			Indian Languages, American. See American Indians, Languages of the.	
			Indian Ocean	201
			Indiana	201
			Indian Poke. See Hellebore.	
			Indiana. See American Indians.	
			Indian Shot	200
			Indian Territory	200
			Indian Tobacco. See Lobelia.	
			India Rubber. See Caoutchouc.	
			Indictment	200
			India, East. See East India, and India.	
			India, West. See Antilla, and West India.	
			Indigo	200
			Indigo Bird	200
			Indium	200
			Indo-China	200
			Indo-Chinese Races and Languages	200
			Indo-European Races and Languages. See Aryan Race and Language, and Germanic Race and Language.	
			Indore	201
			Indorsement. See Exchange, Promissory Note, and Negotiable Paper.	
			Indre	201
			Indre-et-Loire	201
			Indri. See Lemur.	
			Indulgence	201
			Indus	201
			Industrial Exhibitions	201
			Ines de Castro. See Castro, Ines de.	
			Infallibility	201
			Infant	201
			Infante	201
			Infante, José Miguel	201
			Infantry	201
			Infant Schools	201
			Inflammation	201
			Infuenza. See Bronchitis, vol. II., p. 312.	
			Information	201
			Infusoria	201
			Inghert	201
			Inglow, Jean	201
			Ingramm, Bernhard Severin	201
			Ingenbous, Johannes	201
			Ingermannland. See Ingrina.	
			Ingersoll	201
			Ingersoll, Jared	201

CONTENTS

iii

	PAGE
II, Charles Jared	379
II, Joseph Reed	380
co.	380
Charles C.	380
mi, Tommaso	380
Clement Mansfield	380
idt.	380
m, Duncan Nathaniel	380
m, Joseph H.	381
Jean Dominique Auguste	381
s.	381
ius	381
an	381
ion	381
282	382
irrigation	382
Irvine	382
Irvine, William	382
Irving, Edward	382
Irving, Theodore	382
Irving, Washington	382
Irwin co.	382
Isaac	382
Isaac I, Comnenus	382
Isaac II, Angelus	382
Isabella co.	382
Isabella I.	382
Isabella II.	382
Isabella of England. See Edward II. and III.	382
Isabella of Valois. See Elizabeth of Valois	382
Isabeau, Jean Baptiste	382
Isabeau, Eugene Louis Gabriel	382
Isacus	382
Isaiah	382
Isanti co.	382
Isar	382
Isare, Clemence	382
Isauria	382
Ischia	382
Ischl	382
Isenheim	382
Iselin, Henri Frederic	382
Isere	382
Isere co.	382
Isere-shire	382
Ishtar	382
Isure	382
Isidore Mercator	382
Isidorus of Charax	382
Isidorus of Seville	382
Isinglass	382
Isis	382
Isle, José Francisco de	382
Islam	382
Island co.	382
Islay	382
Isle of France. See Mauritius	382
Isle of Man. See Man	382
Isle of Pines. See Pines	382
Isle of Wight England. See Wight	382
Isle of Wight co.	382
Isle Royale	382
Isles of Shoals	382
Islington. See London	382
Ismaelians. See Assassins	382
Ismael	382
Ismailla	382
Ismael Pasha	382
Ismid	382
Isnard, Maximin	382
Isocrates	382
Isomerism	382
Isometric Projection	382
Isomorphism	382
Isopods	382
Isothermal Lines. See Climate	382
Isphahan	382
Israel. See Jacob	382
Israelites. See Hebrews	382
Israels, Josef	382
Isaquena co.	382
Isafore	382
Isoudun	382
Issue, in law	382
Issue, in pleading	382
Issus	382
Itapa	382
Itapa	382
Itar. See Danube	382
Ithmian Games	382
Istria	382
Isturia, Francisco Xavier de	382
Itacolumite	382

	PAGE
Irkutsk	384
Iron	385
Iron co., Mo.	385
Iron co., Utah	385
Iron-clad Ships	385
Iron Manufacture	389
Iron Mask, Man in the	404
Iron Mountain	404
Iron Ores	406
Irons, William Josiah	411
Ironton	412
Iroquois	412
Iroquois co.	414
Irawaddy	414
Irrigation	414
Irvine	416
Irvine, William	416
Irving, Edward	417
Irving, Theodore	419
Irving, Washington	419
Irwin co.	421
Isaac	421
Isaac I, Comnenus	421
Isaac II, Angelus	421
Isabella co.	422
Isabella I.	422
Isabella II.	423
Isabella of England. See Edward II. and III.	423
Isabella of Valois. See Elizabeth of Valois	423
Isabeau, Jean Baptiste	424
Isabeau, Eugene Louis Gabriel	424
Isacus	424
Isaiah	424
Isanti co.	424
Isar	424
Isare, Clemence	425
Isauria	425
Ischia	425
Ischl	425
Isenheim	425
Iselin, Henri Frederic	425
Isere	425
Isere co.	425
Isere-shire	425
Ishtar	425
Isure	425
Isidore Mercator	425
Isidorus of Charax	425
Isidorus of Seville	425
Isinglass	425
Isis	427
Isle, José Francisco de	427
Islam	428
Island co.	428
Islay	428
Isle of France. See Mauritius	428
Isle of Man. See Man	428
Isle of Pines. See Pines	428
Isle of Wight England. See Wight	428
Isle of Wight co.	428
Isle Royale	428
Isles of Shoals	429
Islington. See London	429
Ismaelians. See Assassins	429
Ismael	429
Ismailla	429
Ismael Pasha	429
Ismid	429
Isnard, Maximin	429
Isocrates	429
Isomerism	429
Isometric Projection	429
Isomorphism	429
Isopods	429
Isothermal Lines. See Climate	429
Isphahan	429
Israel. See Jacob	429
Israelites. See Hebrews	429
Israels, Josef	429
Isaquena co.	429
Isafore	429
Isoudun	429
Issue, in law	429
Issue, in pleading	429
Issus	429
Itapa	429
Itapa	429
Itar. See Danube	429
Ithmian Games	429
Istria	429
Isturia, Francisco Xavier de	429
Itacolumite	429

	PAGE
Italic Races and Languages	428
Italy	440
Italy, Language and Literature of	455
Italy, Wines of	467
Ivard, Jean Marie Gaspard	469
Itasca co.	469
Itasca, Lake of	469
Itawamba co.	469
Itch	469
Ithaca, N. Y.	471
Ithaca, an Island	471
Ittenbach, Franz	471
Iturbide, Augustin de, Emperor	471
Itza, Lake of. See Peten	471
Itzmes	473
Ivan, Czars. See Russia	473
Ivanoff, Alexander Andreyevitch	473
Ives, Levi Silliman	473
Ivory	474
Ivory, James	475
Ivory Coast	475
Ivrea	476
Ivry-la-Bataille	476
Ivry-sur-Seine	476
Ivy	476
Ixion	477
Ixtlixochitl, Fernando de Alva	477
Izalal	478
Izalco, a volcano	478
Izalco, a town	478
Izard co.	478
Izard, Ralph	478
Izacchualt	478

J

	PAGE
J	479
Jabiru	479
Jablonski, Paul Ernst	479
Jacamar	479
Jacana	480
Jacmann, Eduard Karl Emanuel	481
Jack co.	481
Jackal	481
Jackdaw	481
Jackson co., Va.	482
Jackson co., N. C.	482
Jackson co., Ga.	482
Jackson co., Fla.	482
Jackson co., Ala.	482
Jackson co., Miss.	482
Jackson parish, La.	482
Jackson co., Texas	482
Jackson co., Ark.	482
Jackson co., Tenn.	482
Jackson co., Ky.	482
Jackson co., Ohio	482
Jackson co., Ind.	482
Jackson co., Ill.	482
Jackson co., Mich.	482
Jackson co., Minn.	482
Jackson co., Iowa	482
Jackson co., Mo.	482
Jackson co., Kansas	482
Jackson co., Oregon	482
Jackson, Mich.	482
Jackson, Miss.	482
Jackson, La.	482
Jackson, Tenn.	482
Jackson, Andrew	482
Jackson, Charles	482
Jackson, James	482
Jackson, Patrick Tracy	482
Jackson, Charles Thomas	482
Jackson, John	482
Jackson, Samuel	482
Jackson, Thomas	482
Jackson, Thomas Jonathan	482
Jackson, William	482
Jacksonville, Fla.	482
Jacksonville, Ill.	482
Jamel	482
Jacob	482
Jacobean Lily	482
Jacob, Bibliophile. See Lacroix, Paul	482
Jacobi, Abraham	482
Jacobi, Friedrich Heinrich	482
Jacobi, Johann Georg	482
Jacobi, Maximilian	482
Jacobi, Karl Gustav Jakob	482







	PAGE		PAGE		PAGE
Kalamazoo River	734	Kästner, Abraham Gotthelf	771	Kent co., Md.	772
Kalekreuth, Friedrich Adolf von, Count	734	Katahdin	771	Kent co., Mich.	772
Kaleldoscope	735	Kater, Henry	771	Kent co., Ont., Canada	772
Kaleridis, Demetrius	735	Katif	772	Kent co., N. B., Canada	772
Kalgan	735	Katkov, Mikhail Nikiforovitch	772	Kent	772
Kalevala. See Finland, vol. iii., p. 293.		Katmandu	772	Kent, Edward Augustus, Duke of	772
Kaldasa	735	Katrine, Loch	772	Kent, James	772
Kalisch. See Kalisz.		Katydie	772	Kent, William (two)	772
Kalisch, David	736	Katzbach	772	Kenton co.	772
Kalispels	736	Kaul	772	Kenton, Simon	772
Kalkaska co.	736	Kaufman, Maria Angelica	772	Kentucky	772
Kalkbrenner, Christian	736	Kaufman co.	772	Kentucky, a river	772
Kalkbrenner, Friedrich	736	Kaufmann, Constantin Petrovitch	772	Kenyon, John	772
Kahn, Peter	737	Kaufmann, Theodor	772	Kenyon, Lloyd, Lord	772
Kahnar. See Calmar.		Kaulbach, Wilhelm von	772	Kenyon College. See Gambier.	772
Kahnia	737	Kaunitz, Wenzel Anton, Prince	772	Keokuk co.	772
Kalocsa	737	Kavanagh, Julia	772	Keokuk	772
Kaluga	738	Kavanaugh, Hubbard Hinde	772	Kepler, Johann	772
Kalw. See Calw.		Kaye, John	772	Keppel, Augustus, Viscount	772
Kama	738	Kaye, Sir John William	772	Keppel, George Thomas	772
Kameela	738	Kazan	772	Keppel, Sir Henry	772
Kamehameha, Kings	738	Kaziney, Ferencz	772	Kerstry, Auguste Hilarius de	772
Kamenetz	738	Kean, Edmund	772	Kerstry, Emile de, Count	772
Kamenz. See Camenz.		Kean, Charles John	772	Kerugelen	772
Kames, Henry Home, Lord	739	Kean, Ellen (Tree)	772	Kerugelen-Tremarce, Yves Joseph de	772
Kamieniec. See Kamenez.		Keane, John, Lord	772	Kerman	772
Kammin. See Cammin.		Kearney co.	772	Kermanbah	772
Kamotraska co.	740	Kearny, Lawrence	772	Kermes Insect. See Cochineal.	772
Kampen	740	Kearny, Stephen Watts	772	Kermes Mineral	772
Kampen, Nikolaas Godfried van	740	Kearny, Philip	772	Kern co.	772
Kämpfer, Engelbrecht	740	Keata, John	772	Kerner, Andreas Justinus	772
Kampitz, Karl Albert Christoph Heinrich von	740	Keckemet	772	Kerosene	772
Kamtchatka	740	Keechles	772	Kerr co.	772
Kanabec co.	741	Keene	772	Kerry co.	772
Kanagawa	741	Keene, Laura	772	Kershaw co.	772
Kanawha co.	741	Keff	772	Kertch	772
Kanawha River. See Great Kanawha		Kehl	772	Kestrel	772
Kandiyohi co.	741	Keighley	772	Keswick	772
Kane co., Ill.	741	Keightley, Thomas	772	Ketones	772
Kane co., Utah	742	Keilm, Theodor	772	Ketteler, Wilhelm Emanuel von Baron	772
Kane, Elisha Kent	742	Keith co.	772	Kew	772
Kane, Sir Robert	742	Keith, Alexander	772	Kewaunee co.	772
Kanarow	742	Keith, George	772	Keweenaw co.	772
Kankakee co.	742	Keith, James	772	Kewling	772
Kano	742	Keith, George Keith-Elphinstone, Viscount	772	Key, Francis Scott	772
Kansas	742	Kelet	772	Key, Thomas Hewitt	772
Kansas, Indians	742	Keller, Francois Christophe	772	Key Islands	772
Kansas City	742	Kellermann, Francois Etienne	772	Keyser, Nicolas de	772
Kansu	742	Kellogg, Clara Louisa	772	Keys of Florida. See Florida Keys	772
Kant, Immanuel	742	Kelung	772	Key West	772
Kantemir. See Cantemir.		Kembie, Roger	772	Khan	772
Kaolin. See Clay.		Kembie, John Phillip	772	Khandeish. See Candesh.	772
Kapnist, Vasil Vasilievitch	742	Kembie, George Stephen	772	Khania. See Canes.	772
Kapp, Friedrich	742	Kembie, Elizabeth	772	Khanjoor	772
Kappel	742	Kembie, Charles	772	Kharacm	772
Kara George. See Czerny George.		Kembie, Frances Anne	772	Kharkov	772
Karabissar. See Adum Karabissar		Kembie, Adolalde	772	Khartoom	772
Karaites	742	Kembie, John Mitchell	772	Khemnitz. See Chemnitz.	772
Karajitch, Vuk Stefanovitch	742	Kennedy, Zeigmond, Baron	772	Kheraskoff, Mikhail	772
Karak	742	Kempelen, Wolfgang, Baron	772	Kherson	772
Karakorum	742	Kemper co.	772	Khiva	772
Karaiman. See Caraiman.		Kemper, Reuben	772	Khodavendighar	772
Karametin, Nikolai Mikhailovitch	742	Kempis, Thomas a.	772	Khol	772
Karasu-Bazar	742	Kempton	772	Khokan	772
Karlsburg	742	Ken, Thomas	772	Khorasan	772
Karlsburg. See Carlsburg.		Kennians	772	Khotin	772
Karlskrona. See Carlskrona.		Kendal	772	Khuzistan	772
Karlsruhe. See Carlsruhe.		Kendall co., Texas	772	Kiakhta	772
Karlstad. See Carlstad.		Kendall, Amos	772	Kiangai	772
Karlstadt	742	Kendall, George Wilkins	772	Kiangau	772
Karnak. See Thebes.		Kendrick, Asahel Clark	772	Kikapoo	772
Karnes co.	742	Ken-h	772	Kidd, William	772
Karolinska. See Finns.		Keneb	772	Kidder co.	772
Karstens, Karl-Johann Bernhardt	742	Kennebec co.	772	Kidder, Daniel Parish	772
Kasan. See Kazan.		Kennebec	772	Kidderminster	772
Kasbin. See Casbin.		Kennedy, Benjamin Hall	772	Kidnaping	772
Kaschau	742	Kennedy, Charles Rann	772	Kidney	772
Kashan	742	Kennedy, Grace	772	Kiel	772
Kashgar	742	Kennedy, John Pendleton	772	Kielee	772
		Kennet, White	772	Kienchow	772
		Kenneott, Benjamin	772	Kiepert, Heinrich	772
		Kenosha co.	772	Kiesewetter, Rafael Georg	772
		Kenosha	772	Kiev	772
		Kenrick, Francis Patrick	772	Killanea	772
		Kenrick, Peter Richard	772	Kilbourne, James	772
		Kensett, John Frederick	772	Kildare co.	772
		Kent co., E. I.	772	Kildeer	772
		Kent co., Del.	772	Kilmanjaro	772
				Kilkenny co.	772
				Kilkenny	772

CONTENTS

vii

	PAGE		PAGE		PAGE
<b>Kilbarney</b> .....	832	<b>Kincardineshire</b> .....	833	<b>King, William</b> .....	837
<b>Kilgrew, Sir William</b> .....	832	<b>Kindergarten. See Infant Schools.</b>		<b>King, William Rufus</b> .....	837
<b>Kilgrew, Thomas</b> .....	832	<b>Kinesipathy. See Ling, Peter Hen-</b>		<b>King and Queen co.</b> .....	837
<b>Kilgrew, Henry</b> .....	833	<b>rik.</b>		<b>King at Arms. See Heraldry.</b>	
<b>Kilgrew, Ande</b> .....	833	<b>King</b> .....	833	<b>King Brd.</b> .....	837
<b>Kilmarnock</b> .....	833	<b>King co.</b> .....	834	<b>King Crab</b> .....	838
<b>Kilgramme. See Gramme.</b>		<b>King, John Crookshanks</b> .....	834	<b>King Fish</b> .....	838
<b>Kilwa</b> .....	833	<b>King, Peter, Lord</b> .....	834	<b>Kingfisher</b> .....	839
<b>Kinball, Richard Burielgh</b> .....	833	<b>King, Philip Parker</b> .....	834	<b>King George co.</b> .....	840
<b>Kinble co</b> .....	833	<b>King, Rufus</b> .....	835	<b>Kinglake, Alexander William</b> .....	840
<b>Kinbl, David</b> .....	833	<b>King, Thomas Starr</b> .....	836	<b>Kinglake, John Alexander</b> .....	840

14

14

THIRTEEN YEARS OF THE WORLD'S HISTORY!

NOW READY, UNIFORM WITH THE PRECEDING VOLUMES, THE THIRTEENTH  
VOLUME OF

APPLETONS'  
AMERICAN ANNUAL CYCLOPÆDIA.

---

THE ANNUAL CYCLOPÆDIA stands alone among the successful literary enterprises of the day, and supplies a widely-extended want among all classes of readers that is not met by any other publication, native or foreign. Year-books are numerous in Europe; they are published in every language; but the best of them are merely compilations of statistics or government directions, while in those most widely circulated, as the "*Almanach de Gotha* ; or, *The Statesman's Year-Book*," no space is generally given to the great public events, political, social, and industrial, that have everywhere occupied the minds of men during the year. In the United States numerous almanacs and other special periodicals are issued, but, excepting the one under consideration, there is no publication that aspires to the general character of an annual cyclopædia, giving fresh and much-sought information on all topics of public interest. The ANNUAL CYCLOPÆDIA has, then, no rival and no competitor, and, in issuing the first volume of this work in 1861, the publishers established an enterprise which met a wide-felt want, while the liberality and ability which have characterized the issue of each succeeding volume have been promptly recognized by a rapidly-extending list of subscribers.

It is important here to note the difference between the ANNUAL CYCLOPÆDIA and another work published by this house, and bearing the somewhat similar title of the AMERICAN CYCLOPÆDIA. Excepting this similarity of name, and the fact that both are general books of reference issued by the same publishers, these works have nothing in common. Not only are they under totally distinct and independent editorial supervision, each with an organization of writers wholly distinct from that of the other, but the plans and purposes of the two are entirely different. The publication of the NEW AMERICAN CYCLOPÆDIA was begun in 1857 and completed in 1863, in sixteen volumes. The first volume of a new edition, under the title of the AMERICAN CYCLOPÆDIA, appeared in July, 1873. In May, 1874, six volumes had been published, and the remaining ones will be issued bi-monthly until the completion of the entire work in sixteen volumes.

The **ANNUAL CYCLOPÆDIA** is published every year, and deals entirely with the present. Its recording pen is never still. While treating current events, its aim is to cover the entire domain of human activity, to gather promptly the results of men's thoughts and actions in every field, and to give them to the world year by year. That this statement is fully warranted in its widest sense is shown by an analysis of a single volume. Each volume contains about eight hundred octavo pages, and presents not less than two hundred and fifty general subjects, occupying from a few lines to one hundred pages, which is the space generally allotted to the article on the **CONGRESS OF THE UNITED STATES**. The range of these subjects is as wide as human knowledge.

In geography and political science—measures of the cabinet and movements in the field—every country in the world is represented; not only our own and the leading powers of Europe, but also the farthest countries of the South, the East, and the North, the political divisions of South and Central America, the half-civilized districts of Africa, the older governments of Asia and the Orient, and the sparsely-inhabited sections of northern latitudes. In each of these, all important political and military events, the social condition of the people, religion, schools, public institutions, financial measures, movements of commerce, progress of art, literature and industry, and enterprise of every character, are promptly recorded from the latest official material by writers thoroughly conversant with each subject.

In science no fact or result is neglected which is necessary to keep the reader abreast of the scientific thought and progress of the day. All the most recent observations and investigations, by eminent scientists in every country, are presented at length, in a style which is found clear by the general reader and accurate by the professional inquirer, in the articles **ASTRONOMICAL PHENOMENA AND PROGRESS**, **CHEMISTRY**, **GEOGRAPHICAL EXPLORATIONS AND DISCOVERIES**, **METALS**, **METEOROLOGY**, and many others, in which special subjects are treated.

The busy activity in the world of authorship, American and foreign, is recorded in the article **LITERATURE AND LITERARY PROGRESS**, which comprises from thirty to fifty pages, in which are given the titles of the new books of the year, with a brief account of the character and contents of the more important ones in the various departments of science and philosophy, history, biography, poetry, essays and criticism, theology and religion, geography, travel and adventure, fiction, politics and sociology, law, medicine, the useful arts, text-books, juveniles, illustrated works, re-publications, etc. Not only is this important branch treated with reference to classified subjects, but also according to countries, so that the literary work and progress of each nation during the year may be seen at a glance.

Another most important feature of the **ANNUAL CYCLOPÆDIA** is the care and impartiality with which subjects relating to religion are treated. In this department all denominations, all sects and branches, are represented under a system which knows no sectarianism, the object being to afford the latest and most accurate information concerning the condition and doings of every denomination. For this purpose the proceedings of conventions, synods, councils, etc., membership, property, progress of opinions and numbers, and whatever of general interest has transpired during the year concerning the various branches of the Church, are prepared from official sources, and find a place in its pages. Special prominence is also given to the subjects of Biography and Necrology. The list of Obituaries, American and foreign, contains notices of all persons of note in any part of the world who have

died during the year; while, in the case of persons of marked eminence in any field of labor, or in any country, the career, public services, and achievements of the deceased, are set forth at such length as the importance of the subject, or the general interest, may demand. Thus among the most illustrious of the dead of 1873 were Napoleon III., Chief-Justice Chase, Agassiz, John Stuart Mill, and Dr. Livingstone, each of whom, as well as many others, forms the subject of an extended biographical notice in the ANNUAL CYCLOPEDIA for 1873. In some instances biographical sketches of living men have been given, and it is proposed hereafter greatly to extend this feature so as to present notices of all of the more prominent men in the world. Notwithstanding the wide range of the subjects above indicated, and the fullness with which they are treated in each volume of the ANNUAL CYCLOPEDIA, the prominence given to matters more especially pertaining to the United States gives to this work a value possessed by no other publication. In the article CONGRESS a clear and comprehensive summary of the proceedings and discussions of that body, during an entire session, on all the great political questions before the people, is given, embracing the votes thereon and the pith of the speeches by the leading members. All important state papers, messages, orders, treaties, committee reports, platforms of national parties, official correspondence, etc., between the Government of the United States and foreign nations, are given entire in the articles DIPLOMATIC CORRESPONDENCE, and FOREIGN RELATIONS, and PUBLIC DOCUMENTS. Information on military and naval affairs is afforded by the articles ARMY and NAVY. The important subjects relating to finance, the resources and expenditures of the Federal Government, the decrease of the public debt, and the reduction of taxation, are treated with great care in the article FINANCES. A careful watch is likewise maintained of the general commercial and industrial interests of the country, the movements of commerce, progress of manufactures, agriculture, and mines, measures for increased transportation facilities, foreign and internal, and public improvements of every character, all of which receive due consideration in the articles on the several States and under such heads as COMMERCE, COMMERCIAL CONVENTIONS, AGRICULTURE, RAILROADS, TELEGRAPHS, IMMIGRATION, COTTON, etc.

Besides the above general titles, and that of the UNITED STATES, the affairs of each State and Territory are treated under separate heads. The proceedings of the Legislature, the finances of the State, its debt and resources, the progress made in relation to educational, charitable, and penal institutions, the various political conventions of the year, with their nominations and platforms, election results, internal improvements, and whatever has occupied the attention of the people of the State during the year, may be found recorded from official sources year by year in the ANNUAL CYCLOPEDIA. Here, also, appears a clear and impartial account of any public excitement or political agitation that has disturbed the quiet of the State during the year. Thus the volume for 1873 contains a clear and impartial account of the political warfare in Louisiana and Texas, the excitement consequent upon the disclosures of senatorial corruption in Kansas, the great uprising of farmers in the Northwestern States, and their contest with the railroad corporations in Illinois, and other public movements of a similar character. Due prominence is also given to other matters less exciting, perhaps, but not less important—such as the provisions of the new constitution in Pennsylvania, the improvements in the Fox and Wisconsin, and other Western rivers, the construction of the bridge over the Mississippi River at St. Louis, the completion of the Chesapeake & Ohio Railroad, thus affording another great



channel of communication between western waters and the Atlantic seaboard, and the opening of the Hoosac Tunnel in Massachusetts, etc.

The above sketch may serve to illustrate how indispensable each volume of this work is to every reader who desires to keep informed of the progress of men's thoughts and actions in every civilized country. No public speaker or writer can afford to be without it; for, as the office of such persons is to instruct and inform others, their first duty is to be informed themselves. Here the political speaker, whether in the halls of Congress, or on the popular stand, will find his most effective weapons—facts—while the academic or lyceum orator may here gather the most instructive lessons and illustrations to grace his rhetoric. The importance of the work to the journalist need not be pointed out, and those who would be eminent as teachers of religion, or in the law or medicine, must also see the importance of keeping abreast of the progress made in those departments in other fields of labor. Besides the general reader and those engaged in professional pursuits, two classes of persons will find the *ANNUAL CYCLOPEDIA* especially serviceable in the performance of their duties. The first includes all public officials in States, such as members of the Legislature, executive and judicial officers, and officers of educational and other State institutions; for such persons may find here, in a convenient form for reference, not only what has been done during the preceding year in their own State, in which they themselves were actors, but what has been accomplished in the same department in other States, embracing matters of legislation, public improvements, movements of parties, progress of schools, experiments in charitable and reformatory institutions, prison discipline, judicial decisions, etc. The other class comprises those engaged in commerce, manufactures, agriculture, transportation, or any department of industry or trade, for the treatment of these subjects is a prominent feature of the *ANNUAL CYCLOPEDIA*, which neglects nothing of importance showing the condition and progress of invention, the yield of the field and the mine, the products of the workshop, the extension of transportation facilities, the movements of imports and exports, and, in general, those matters which have a prominent influence upon the regulation of supply and demand. Each volume has a full index, so that the reader may at once be referred to the page where any subject is treated. The text of the *ANNUAL CYCLOPEDIA* for 1873 is illustrated by a large number of maps and cuts, besides steel portraits of the Czar of Russia, the President of Mexico, and the Hon. Charles Sumner.

*Price, per volume, in Cloth, \$5.00; Library Leather, \$6.00; Half Turkey, \$6.50; Half Russia, \$7.50.*

D. APPLETON & CO., PUBLISHERS,

549 & 551 Broadway, New York.

# HOW A CYCLOPÆDIA IS MADE.

THE WORK OF REVISING APPLETONS'.

AND BY WHOM THE WORK IS DONE.

*Editors, Associate Editors, Revisers, and Contributors.*

VARIOUS PROCESSES OF THE WORK.—THE THOROUGHNESS WITH WHICH IT IS DONE.—IMPORTANT CHANGES MADE.

PROGRESS OF REVISION THUS FAR.

(Correspondence of the Chicago Tribune.)

making of a first-class cyclopædia is a gigantic undertaking for a single publishing-house to take up in addition to its general business, and carry through to completion; and the work of the establishment of the APPLETONS, of New York, is now engaged, is one of the greatest of the age. Nominally, it is a revision of the old cyclopædia, but virtually it is the preparation of a more complete, carefully wrought, and exact book than the original. This revision is not a mere retrenchment of passages here and there, but a filling of the space so gained with new matter, but a thorough overhauling of every page, the deletion of articles, which the maturer judgment of the age has deemed superfluous in a work of the kind, have been altogether suppressed; other articles have been brought within smaller compass; many new ones have been introduced. A large part of the old articles, which are retained in the new, are entirely rewritten, and every one is thoroughly revised. Whatever of later or more accurate information can be had is obtained at what cost, and no pains are spared to make the work a correct record of all such general information as is available, and the worker in the various callings in which it is at any time stand in need of.

#### THE WORKSHOP.

The principal part of the work of preparing the cyclopædia is carried on in the fourth story of the publishing-house of the Appletons, on Broadway. Entering the front-door, you pass through a long aisle lined high with books on either hand, until you reach the rear of the store, on Mercer Street, two hundred feet from the entrance. In trusting your baggage to the elevator, you are carried to the fourth story, where you again traverse the entire length of the building to the front, and find the workshop of the cyclopædist. It is divided off by low partitions from the rest of the floor, and is fully

lighted by the large windows on the Broadway front. It is a room about fifty feet square, in which some twenty-five or thirty men are constantly occupied. Through the middle runs a long desk, with places for writers along both sides, and an elevation in the middle, with pigeon-holes for documents and materials. All about the room are other desks at every available point, and day after day may be found there the plodding workmen at the herculean labor, which had been going on for nearly two years before the first volume made its public appearance. One side of the room is entirely taken up by a series of book-shelves, filled with all the necessary reference-books, in various languages, besides reports, volumes of statistics, histories, official almanacs, etc. Every desk, too, is burdened with documents obtained for special work, and with manuscript material secured by correspondence with living authorities. Manuscript springs into existence, passes through the ordeal of revision, and goes forth to the printer, who is located over the river, in the part of Brooklyn familiarly known as Williamsburgh; and back come proofs in piles, for thorough correction.

#### THE EDITORS.

Chief among the workers in this literary hive is George Ripley, well known for his vast and critical information on all manner of subjects, and his high and liberal culture. He is a graduate of Harvard College, was the prime mover in the famous co-operative enterprise known as the Brook-Farm colony, which drew in so many of the choice intellects of the last generation in Massachusetts, and has crowned his later years with wide and varied experience by extensive travel, constant study, and association with the active men of the living world. He is still, as he has been for many years, the literary editor of the *Tribune*, and displays in that position, not only the erudition and grace that come from large culture, but an activity and enterprise that would do credit

languages, devotes himself chiefly to Eu-  
rography, geography, and history. Pro-  
xander J. Schem is distinguished for his  
e of European statistics. Richard A. Pro-  
English astronomer, is the reviser in the  
science in which he is distinguished; and  
the regular staff of revisers have special  
topics to which they chiefly confine their  
There are, however, several who devote  
re attention to the large class of miscel-  
laneous subjects which are left when all the special-  
been assigned. These are invariably men of  
culture and intellectual attainments and lit-  
erature. Among the regular revisers in  
are Messrs. John D. Champlin, Jr., and  
orris, the latter a skillful mathematician  
rit scholar.

ohn Milner, the secretary, has charge of  
mass of books and documentary and man-  
aterials, as well as of the copy and proofs  
atter which is in process of preparation.  
a complete journal of every thing that is  
He has on record the name of every  
e matter that each has in hand, date on  
was given out and returned, and the exact  
ritten or revised by each. The coming in  
is also recorded by him; and, by turning  
oks, the exact condition of the work at  
can be ascertained.

#### OUTSIDE CONTRIBUTORS.

orps of outside writers who are employed  
a large number of the leading scholars of  
ry, and many of them are the highest au-  
thorities on the subjects with which they deal. For  
Mr. Henry Carey Baird, of Philadelphia,  
e leading American authorities on political  
economy and finance, prepared the article on banks,  
aged for all similar topics of first-class im-  
portance.

Prof. Rossiter W. Raymond, well known  
for his official reports and literary works on mining,  
prepares articles pertaining to those  
subjects. Prof. W. D. Whitney writes on Oriental  
languages; and scores of other well-known men con-  
tribute their learning and information. The num-  
ber of outside contributors to the first volume  
seventy, and new ones are employed as the  
work advances.

#### COLLECTION OF MATERIAL.

The library contains all the existing cyclopædias,  
etymological and other dictionaries of modern  
languages, besides a large collection  
of works on various subjects. There are  
of congressional and parliamentary reports,  
minutes, books, reports of expeditions and surveys,  
geographical works, histories, travels, etc. Whenever an  
article needed which is not in the library, it is im-  
mediately obtained. A costly book will oftentimes  
be bought, though of no use save in one compar-  
atively small article. All census reports and other  
statistical matters are obtained from official sources  
at the earliest moment. In the early stages of the  
work on the United States census-tables were obtained  
before they were published—in the earliest  
stage, and some even in manuscript—the expense  
of being paid, of course, by the Appletons.

#### THE PROCESS OF REVISION.

The process of revision is begun by one of the  
chief editors going over the volumes of the old

edition, and drawing a pencil-mark through articles  
to be omitted, indicating on the margin that others  
are to be shortened, and noting new titles to be in-  
troduced. The columns are then cut out and pasted  
in the middle of half-sheets of foolscap paper.  
These form the foundation for the work of the re-  
visers. All articles which are to be given out to  
special writers, whether in the office or outside, are  
checked off, and the leaves distributed from time to  
time among the regular revisers. The special titles  
are assigned to the writers whose qualifications best  
fit them to handle the various topics. Whenever  
any man outside of the office is known to be better  
qualified than any one else to deal with an impor-  
tant scientific or technical subject, his services are  
secured, if possible. The original article is sent to  
him, and he is engaged to revise, correct, or wholly  
rewrite it, according to his judgment. No trouble  
or expense is spared to secure the services of the  
most thorough master of the subject. It is no un-  
common thing to send to foreign countries to some  
person specially qualified for a difficult task. For  
instance, the subject of the Chinese language and  
literature was sent to Dr. A. Wylie, who has been  
for many years a missionary in the Celestial Empire,  
has written several works on Chinese matters, and  
is, doubtless, one of the greatest living scholars in  
that special department. The Chinese letters, which  
illustrate the article, are printed from type sent by  
Dr. S. Wells Williams from Canton.

The secretary has charge of the great mass of  
copy while it is in course of preparation, receiving  
the articles as fast as they are prepared. As soon  
as the material that comes from the various writers  
is consecutively complete, it goes through editorial  
revision. The first part of this work is divided be-  
tween Mr. Carter and Dr. Guernsey, who read the  
matter all through carefully, making such correc-  
tions in statement or expression as they see fit, and  
curtailing or modifying wherever it is demanded.  
Mr. Ripley and Mr. Dana are all the while keeping  
an eye to this copy, examining articles, making  
suggestions, and looking out for flaws and imper-  
fections. Finally, Mr. Teall takes the matter in  
hand, and prepares it for the printer. He settles  
all matters of orthography, punctuation, etc., and  
exercises his judgment freely as to the form and  
substance of the articles. After his castigation is  
complete, it goes to the printing-office.

Presently it returns in "galley-proofs," which  
Mr. Teall receives and corrects. These are then  
sent to Mr. Heilprin, who makes all his revision in  
the proofs. He not uncommonly fills the broad  
margins with changes and corrections, even after  
the matter has been through so many competent  
hands in copy. The chief editors also look over the  
proofs to guard against the possibility of an error  
getting beyond recall. These proofs, with the cor-  
rections and changes, are then sent over to the  
printing-office and the corrections made in type.  
Fresh proofs are then sent back for further improve-  
ments, and again returned. The matter is then  
made up into pages, and "page-proofs" taken and  
sent to the editors. Finally, after the pages have  
been cast into plates, another set of proofs is taken,  
sent to the office, and pasted into large folios for refer-  
ence. Still the book is open for correction or improve-  
ment up to the last moment before being put to  
press. If any new event of importance occurs, or  
new and valuable material comes to light, there is  
no hesitation in destroying plates and having this

new matter incorporated. As an instance, the first volume was all ready for the press, when the first news of the Polaris Expedition was received; but the work upon it was stopped at once in order that the result of Captain Hall's investigation might be embodied in the article on "Arctic Discovery."

#### PROGRESS MADE.

At this moment the advance-guard of general revisers, who are working on the miscellaneous articles left, after all specialties are taken out, are busy in the fourteenth volume, down in the letter "S." The work of special writers is at all stages of completeness throughout the preceding four volumes. The editorial revisers have in hand matter belonging to the tenth and eleventh volumes.

#### IMPORTANT CHANGES.

The transformation of the "Cyclopædia," after undergoing this process, is complete, and justifies the claim that it is substantially a new work. Many articles in biography, history, geography, etc., which were of little significance, are omitted. All terms merely requiring definition, such as it is the function of a dictionary to give, are suppressed. Every thing is retained which is believed to be of sufficient moment to the scholar or the seeker for information in any line to induce such person to resort to a "Cyclopædia" for light upon it. Many of the old articles which went unnecessarily into detail, or were unduly elaborated in style or construction, are condensed.

It is a principle rigidly adhered to in this edition that there shall be no waste of space. What is required is a clear, concise, and forcible statement of all the facts worth stating. Vigor and elegance in articles which admit of these qualities are appreciated, but no verbiage is tolerated.

Not only is there a vast amount of later information incorporated into the articles, bringing them down as nearly as possible to the present moment, but the changes of the last fifteen years have brought a large number of new subjects into prominence in history, geography, biography, and science.

#### THE CARE THAT IS TAKEN.

From what has been already said, it will be seen that the utmost care is taken to attain complete accuracy and perfection. In fact, no time or expense conscientiously expended in perfecting the work is grudged by the editors or by the publishers. Every man is encouraged to secure the best material at whatever cost, and spend all the time that may be necessary to the most complete and accurate results.

The magnitude and expense of this undertaking were probably never equaled by any literary enterprise carried out by a single private firm without subsidiary aid. The expense approximated to one hundred thousand dollars before the first volume made its appearance and there was any prospect of returns; and the current expenses for literary work alone amount to about fifteen hundred dollars per week. This takes no account of the cost of illustrating, printing, and binding. The printing is more expensive than in ordinary books, owing to the vast amount of changing and correction that is made after the matter has been put in type.

#### THE ILLUSTRATIONS.

The illustrations demand a word by themselves. The work of the engraving, under the direction of Mr. Filmer, is of the best quality. Mr. John D. Champlin, Jr., who has general supervision of this department, allows nothing to pass which is not in every way creditable to the work. The designs are obtained from any trustworthy source that is available. Many of them, especially those illustrating scientific articles, are taken from the best standard works; some are found in official reports, others in the books of travelers, and very many are from photographs and drawings obtained especially for the "Cyclopædia."

In conclusion, permit me to give it as an unbiased opinion that, for practical use, this will be the best "Cyclopædia" in existence—not only because all the most valuable facts of existing reference-books will be found in it, together with the best information from all other available sources, but because it is gotten up with a care and fidelity very rarely exercised in any literary work.

The work is sold to Subscribers only, payable on delivery of each volume. It will be completed in sixteen large octavo volumes, each containing about 800 pages, fully illustrated with several thousand Wood-Engravings, and with numerous colored Lithographic maps.

#### Price and Style of Binding.

In extra Cloth, per vol., . . . . .	25.00
In Library Leather, per vol., . . . . .	6.00
In Half Turkey Morocco, per vol., . . . . .	7.00
In Half Russia, extra gilt, per vol., . . . . .	8.00
In Full Morocco, antique, gilt edges, per vol., . . . . .	10.00
In Full Russia, per vol., . . . . .	10.00

Eight volumes are now ready. The ninth volume will be ready November 1, 1874. Succeeding volumes, until completion, will be issued once in two months.

\* \* \* Specimen pages of the "AMERICAN CYCLOPEDIA," showing type, illustrations, etc., will be sent gratis on application.

#### FIRST-CLASS CANVASSING AGENTS WANTED.

Address the Publishers,

**D. APPLETON & CO., 549 & 551 Broadway, New York**



1  
2  
3  
4  
5  
6  
7  
8  
9  
10  
11  
12  
13  
14  
15  
16  
17  
18  
19  
20  
21  
22  
23  
24  
25  
26  
27  
28  
29  
30  
31  
32  
33  
34  
35  
36  
37  
38  
39  
40  
41  
42  
43  
44  
45  
46  
47  
48  
49  
50  
51  
52  
53  
54  
55  
56  
57  
58  
59  
60  
61  
62  
63  
64  
65  
66  
67  
68  
69  
70  
71  
72  
73  
74  
75  
76  
77  
78  
79  
80  
81  
82  
83  
84  
85  
86  
87  
88  
89  
90  
91  
92  
93  
94  
95  
96  
97  
98  
99  
100



1









