



This is a digital copy of a book that was preserved for generations on library shelves before it was carefully scanned by Google as part of a project to make the world's books discoverable online.

It has survived long enough for the copyright to expire and the book to enter the public domain. A public domain book is one that was never subject to copyright or whose legal copyright term has expired. Whether a book is in the public domain may vary country to country. Public domain books are our gateways to the past, representing a wealth of history, culture and knowledge that's often difficult to discover.

Marks, notations and other marginalia present in the original volume will appear in this file - a reminder of this book's long journey from the publisher to a library and finally to you.

Usage guidelines


Google is proud to partner with libraries to digitize public domain materials and make them widely accessible. Public domain books belong to the public and we are merely their custodians. Nevertheless, this work is expensive, so in order to keep providing this resource, we have taken steps to prevent abuse by commercial parties, including placing technical restrictions on automated querying.

We also ask that you:

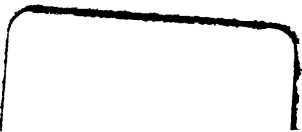
- + *Make non-commercial use of the files* We designed Google Book Search for use by individuals, and we request that you use these files for personal, non-commercial purposes.
- + *Refrain from automated querying* Do not send automated queries of any sort to Google's system: If you are conducting research on machine translation, optical character recognition or other areas where access to a large amount of text is helpful, please contact us. We encourage the use of public domain materials for these purposes and may be able to help.
- + *Maintain attribution* The Google "watermark" you see on each file is essential for informing people about this project and helping them find additional materials through Google Book Search. Please do not remove it.
- + *Keep it legal* Whatever your use, remember that you are responsible for ensuring that what you are doing is legal. Do not assume that just because we believe a book is in the public domain for users in the United States, that the work is also in the public domain for users in other countries. Whether a book is still in copyright varies from country to country, and we can't offer guidance on whether any specific use of any specific book is allowed. Please do not assume that a book's appearance in Google Book Search means it can be used in any manner anywhere in the world. Copyright infringement liability can be quite severe.

About Google Book Search

Google's mission is to organize the world's information and to make it universally accessible and useful. Google Book Search helps readers discover the world's books while helping authors and publishers reach new audiences. You can search through the full text of this book on the web at <http://books.google.com/>

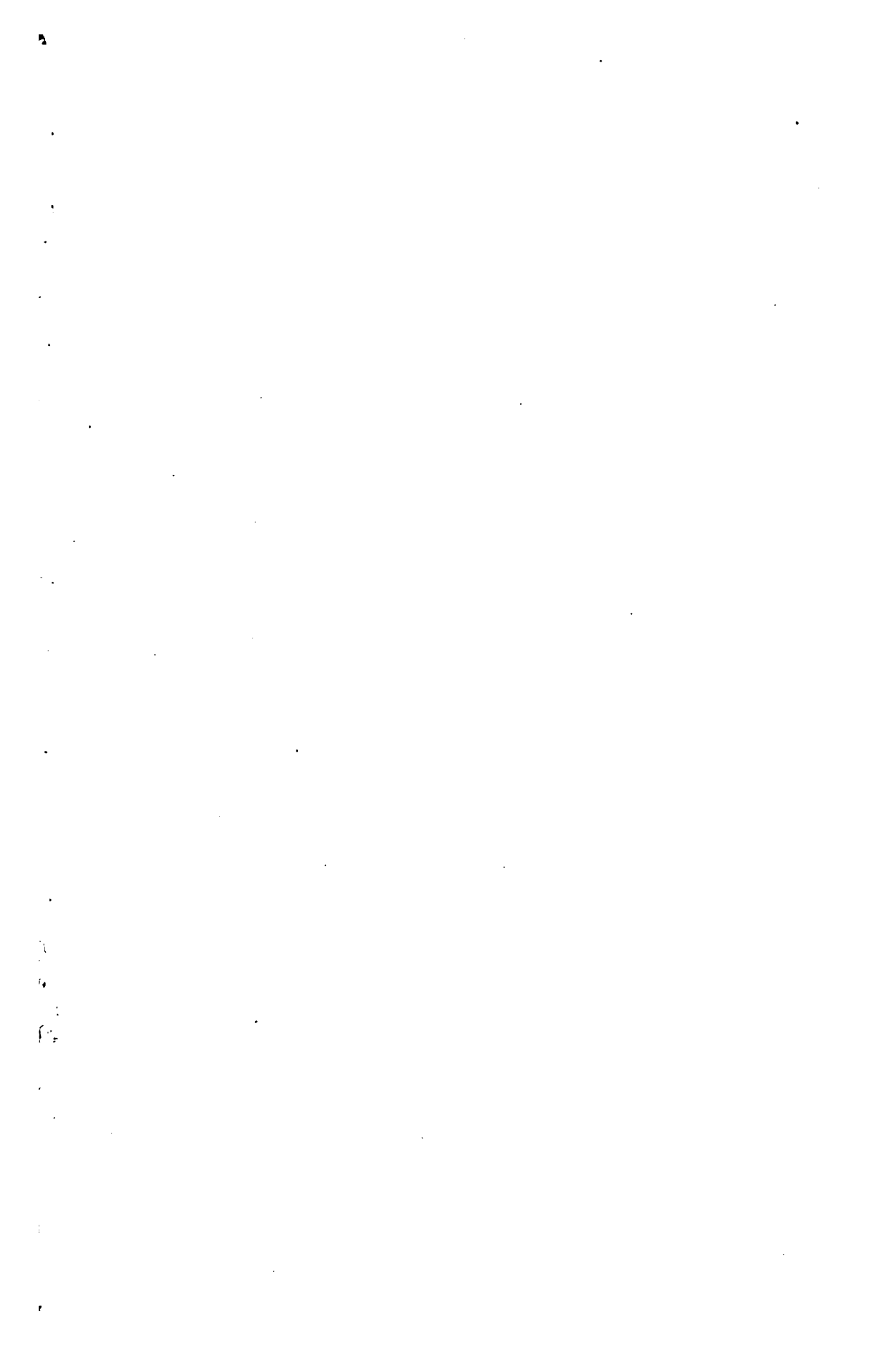


From the Library of the
Fogg Museum of Art
Harvard University





From the Library of the
Fogg Museum of Art
Harvard University



FA 1.454(2) 1886

THE
AMERICAN
JOURNAL OF ARCHÆOLOGY
AND OF THE
HISTORY OF THE FINE ARTS

VOLUME II

BALTIMORE
1886

THE AMERICAN JOURNAL OF ARCHÆOLOGY AND OF THE HISTORY OF THE FINE ARTS is the official organ of the ARCHÆOLOGICAL INSTITUTE OF AMERICA, and will aim to further the interests for which the Institute was founded.

Advisory Editor: Prof. CHARLES ELIOT NORTON, of Harvard University.

Managing Editor: Prof. A. L. FROTHINGHAM, Jr., of Princeton College.

Editorial Contributors: Dr. A. EMERSON; Dr. H. N. FOWLER, of Harvard University; Prof. ALLAN MARQUAND, of Princeton College; Prof. A. R. MARSH, of Kansas University; Prof. A. C. MERRIAM, of Columbia College; Dr. CHARLES WALDSTEIN, of Cambridge University, England; Mr. JUSTIN WINSOR, of Harvard University; Prof. J. H. WRIGHT, of Johns Hopkins University.

The following writers have contributed or promised early contributions:

UNITED STATES.

Dr. FRANCIS BROWN,	Miss I. F. HAPGOOD,	Mrs. Z. NUTTALL,
Mr. LUCIEN CARR,	Mr. H. W. HENSHAW,	Prof. F. W. PUTNAM,
Mr. JOSEPH T. CLARKE,	Mr. W. H. HOLMES,	Mr. D. W. ROSS,
Mr. W. H. DALL,	Mr. T. H. LEWIS,	Mr. RUSSELL STURGIS,
Mr. F. B. GODDARD,	Mr. W. P. P. LONGFELLOW,	Prof. CYRUS THOMAS,
Mr. WM. H. GOODYEAR,	Mrs. LUCY M. MITCHELL,	Dr. W. HAYES WARD, <i>etc.</i>

EUROPE.

M. E. BABELON, attaché au Cabinet des Médailles, National Library, Paris.
Dr. A. A. CARUANA, Librarian of the public Library, Malta.
L'Abbé L. DUCHESNE, Professor of Christian Archæology, Catholic Institute, Paris.
M. ÉMILE DUVAL, Director of the Musée Fol, Geneva.
Dr. A. FURTWÄNGLER, Professor of Archæology in the University of Berlin.
Mr. ERNEST A. GARDNER, of Cambridge, England.
Prof. W. HELBIG, Secretary of the German Archæological Institute, Rome.
Prof. HANS HILDEBRAND, Director of the Museums, ed. of *Tidskrift*, *etc.*, Stockholm.
Dr. G. HIRSCHFELD, Professor of Archæology in the University of Königsberg.
Dr. F.-X. KRAUS, Professor at the University of Freiburg-im-Breisgau.
Dr. SPYRIDION P. LAMBROS, of Athens, Greece.
Comm. RODOLFO LANCIANI, Director of excavations and antiquities, Rome.
Comte de MARSY, Director of the Soc. Franc. d'Archéologie, *Bulletin Monumental*, *etc.*
Prof. ORAZIO MARUCCI, member of Comm. Archæol. Commission of Rome, *etc.*
Prof. G. MASPÉRO, former Director of Antiq., Egypt; Prof. at Collège de France, Paris.
M. JOACHIM MÉNANT, of Rouen, France.
Prof. ADOLPH MICHAELIS, of the University of Strassburg.
Mr. WALTER MILLER, member of the Amer. School of Classical studies at Athens.
M. ÉMILE MOLINIER, attaché au Musée du Louvre, Paris.
M. EUGÈNE MÜNTZ, Librarian and Conservator of the École des Beaux-Arts, Paris.
Prof. F. PIPER, Professor of Christian Archæology in the University of Berlin.
Mr. W. M. RAMSAY, Professor in the University of Aberdeen.
Dr. FRANZ V. REBER, Professor in the University and Polytechnic of Munich, *etc.*
M. SALOMON REINACH, attaché au Musée National de St. Germain.
Comm. GIO. BATT. DE ROSSI, Director of the Vatican and Lateran Museums, Rome.
Dr. THEODOR SCHREIBER, Professor of Archæology in the University of Leipzig.
Mr. ROBERT SEWELL, Madras Civil Service, F. R. G. S., M. R. A. S.
Sig. ENRICO STEVENSON, member of the Comm. Archæol. Commission of Rome, *etc.*
M. F. TRAWINSKI, sous-chef à la Direction des Beaux-Arts, Paris.
Hon. JOHN WORTHINGTON, U. S. Consul at Malta.

CONTENTS OF VOLUME II, 1886.

No. 1. JANUARY—MARCH.

	PAGE.
I.—A proto-Ionic capital from the site of Neandreaia, (I) (figs. 1-9), by JOSEPH T. CLARKE,	1
II.—Notes and Inscriptions from Asia Minor (II), . . . by W. M. RAMSAY,	21
III.—Law Code of the Kretan Gortyna (II), . . . by A. C. MERRIAM,	24
IV.—Notes on Oriental Antiquities. I. Two Babylonian seal-cylinders (figs. 10-12), by WM. HAYES WARD,	46
V.—Unpublished or imperfectly published Hittite monuments. I. The façade at Eflatûn-Bûnar (plate I), by WM. HAYES WARD,	49
Note on plate v, 2, of volume I, by A. FURTWÄNGLER,	52
Recent archaeological discoveries in Persia, . . . by ERNEST BABELON,	53
CORRESPONDENCE:	
Excavations upon the Akropolis at Athens, . . . by WALTER MILLER,	61
The "Monumental Tortoise" mounds of "De-coo-dah" (plate II), by T. H. LEWIS,	65
REVIEWS AND NOTICES OF BOOKS:	
S. Reinach, <i>Traité d'Epigraphie Grecque</i> : . . . by A. C. MERRIAM,	70
H. Schliemann, <i>Tiryns</i> : by RUSSELL STURGIS,	75
Th. Schreiber, <i>Unedirte römische Fundberichte</i> : by A. L. FROTHINGHAM, Jr.,	77
ARCHÆOLOGICAL NEWS:	
AFRICA (Egypt, Tunisia); ASIA (China, Annam, Asia Minor, Kypros); EUROPE (Greece, Italy, France, Belgium, Germany, Turkey, Russia, Great Britain); AMERICA (United States, Canada, Mexico),	79
SUMMARIES OF PERIODICALS:	
Archäologische Zeitung—Bullettino di Archeologia Cristiana—Bullettino della Commis. arch. comunale di Roma—Bulletin de Correspondance Hellénique— <i>Ἐφημερίς Ἀρχαιολογική</i> —Gazette Archéologique—Journal of Hellenic Studies—Revue Archéologique,	101

No. 2. APRIL—JUNE.

I.—Notes and Inscriptions from Asia Minor (III), . . . by W. M. RAMSAY,	123
II.—A Hittite Cylinder in the Musée Fol at Geneva (figs. 13, 14), by EMILE DUVAL,	132
III.—A proto-Ionic capital from the site of Neandreaia (II) (fig. 15), by JOSEPH T. CLARKE,	136
IV.—Egyptian Antiquities. I. Two Ptolemaic Inscriptions; II. Mummy Tablets; by A. C. MERRIAM,	149

	Page.
v.—Notes on Oriental Antiquities. II. Two seals with Phœnician inscriptions (figs. 16, 17), by WM. HAYES WARD,	155
VI.—The terracotta heads of Teotihuacan (plates III, IV: figs. 18–27), by ZELIA NUTTALL,	157
NOTE:	
An American Expedition to Magna Grecia,	179
CORRESPONDENCE:	
Excavations at Naukratis, by ERNEST A. GARDNER,	180
REVIEWS AND NOTICES OF BOOKS:	
Ch. Waldstein, <i>Essays on the Art of Pheidias</i> : by A. R. MARSH,	182
J. Ménant, <i>La Glyptique Orientale</i> : by A. L. FROTHINGHAM, JR.,	187
J. H. Middleton, <i>Ancient Rome in 1885</i> : by RUSSELL STURGIS,	196
J. Quicherat, <i>Archéologie au Moyen Age</i> : by A. L. FROTHINGHAM, JR.,	199
Th. Schreiber, <i>Kulturhistorischer Bilderatlas</i> : by A. EMERSON,	201
ARCHÆOLOGICAL NEWS:	
AFRICA (Egypt); ASIA (Siam, Hindustan, Turkestan, Afghanistan, Palestine, Asia Minor); EUROPE (Greece, Italy, France, Germany, Austria-Hungary, Roumania, Great Britain and Ireland); AMERICA (United States, Mexico); <i>Addendum</i> (Hindustan),	203
SUMMARIES OF PERIODICALS:	
Archäologische Zeitung—Bullettino della Commis. arch. comunale di Roma—Bulletin de Correspondance Hellénique—Bulletin Trim. des Antiquités Africaines—Journal of Hellenic Studies—Mittheilungen d. deutschen archäol. Inst.,	234

No. 3. JULY—SEPTEMBER.

I.—Oriental cylinders of the Williams Collection (plate v, vi), by J. MENANT,	247
II.—Notes on Oriental Antiquities. III. A god of Agriculture (figs. 28–32), by WM. HAYES WARD,	261
III.—A Doric shaft and base found at Assos (figs. 33–37), by JOSEPH T. CLARKE,	267
IV.—Intailles antiques de la collection de Luynes (plate VII), by ERNEST BABELON,	286
V.—The lost mosaics of Rome (I) (plate VIII), by EUGÈNE MÜNTZ,	295
VI.—Two marble heads in the Museum at Constantinople (plate IX), by SALOMON REINACH,	314
VII.—The terracotta heads of Teotihuacan (II) (figs. 38–46), by ZELIA NUTTALL,	318
VIII.—Procès-verbal de l'ouverture de deux momies royales au Musée de Boulaq, by G. MASPÉRO,	331
CORRESPONDENCE:	
Recent excavations in Rome, by ORAZIO MARUCCI,	334
REVIEWS AND NOTICES OF BOOKS:	
M. Collignon, <i>Phidias</i> : by W. P. P. LONGFELLOW,	342
A. de Champeaux, <i>Dictionnaire des fondeurs</i> : by A. L. F., JR.,	347
P. Delattre, <i>Archéol. Chrét. de Carthage</i> : by A. L. F., JR.,	349
E. de Ruggiero, <i>Dizionario Epigrafico</i> : by A. L. F., JR.,	351

CONTENTS.

V

	PAGE.
SUMMARIES OF PERIODICALS:	
Bullettino di Archeologia Cristiana—Bulletin de Correspondance Hellénique—Bulletin Monumental— <i>Ἐφημερίς Ἀρχαιολογική</i> —Gazette Archéologique—Jahrbuch d. deut. archäol. Instituts—Mittheilungen d. deut. archäol. Instituts: Athenische Abth.—Ditto: Römische Abth.,	353
NECROLOGY:	
Charles C. Perkins,	381

No. 4. OCTOBER—DECEMBER.

I.—Unpublished White Lekythoi from Attika (plates X, XI, XII—XIII), by JOHN HENRY WRIGHT,	385
II.—The Portraiture of Alexander the Great: a Terracotta Head in Munich (I), by ALFRED EMERSON,	408
III.—Notes on Christian Mosaics. II. The Portico of the Lateran Basilica (plate XIV), by A. L. FROTHINGHAM, JR.,	414
NOTES:	
Law Code of the Kretan Gortyna, by A. C. MERRIAM,	424
An Inscription from Kedraei, by A. C. MERRIAM,	425
A MS. of the Minnesinger and an early Christian Cemetery at Trèves, by F. X. KRAUS,	425
Notes on Biblical Archæology, by FRANCIS BROWN,	428
CORRESPONDENCE:	
Archæological Congresses in France in 1886, by X.,	433
Permanent Fund for the American School at Athens, by THOMAS W. LUDLOW,	459
REVIEWS AND NOTICES OF BOOKS:	
Friederichs-Wolters, Bausteine: by RUSSELL STURGIS,	437
A. J. Butler, Ancient Coptic Churches of Egypt: by A. L. FROTHINGHAM, JR.,	443
A. A. Carnana, Megalithic Antiquities of Hagiar-Kím, Malta: by JOHN WORTHINGTON,	451
L. de Clercq and J. Ménant, Collection De Clercq; Antiquités Assyriennes: by A. L. FROTHINGHAM, JR.,	455
P. Cavvadias, Les Musées d'Athènes: Fouilles de l'Acropole: by A. L. F., JR.,	457
ARCHÆOLOGICAL NEWS:	
AFRICA (Egypt, Algeria, Tunisia); ASIA (Java, Ceylon, Hindustan, Arabia, Palestine, Phœnicia, Armenia, Asia Minor, Kypros); EUROPE (Greece, Italy, Spain, France, Belgium, Germany, Austria-Hungary, Roumania, Russia, England); AMERICA (United States, Mexico);	460
SUMMARIES OF PERIODICALS:	
Gazette Archéologique—Jahrbuch d. deut. archäol. Instituts—Journal of Hellenic Studies—Mittheilungen d. deut. archäol. Instituts: Athenische Abth.—Ditto: Römische Abth.—Revue Archéologique,	507

ALPHABETICAL TABLE.

	PAGE.
ARCHÆOLOGICAL NEWS ,	79, 203, 460
Afghanistan, 211—Algeria, 464—Annam, 82—Arabia, 476—Armenia, 477	
—Asia Minor, 83, 212, 477—Austria-Hungary, 230, 500—Belgium, 96, 499	
—Canada, 99—Ceylon, 466—China, 82—Egypt, 79, 203, 460—England,	
97, 231, 501—France, 95, 227, 498—Germany, 96, 229, 499—Greece, 84,	
216, 478—Hindustan, 207, 233, 472—Ireland, 231—Italy, 88, 217, 481—	
Java, 465—Kypros, 83, 478—Mexico, 100, 232, 506—Palestine, 211, 476—	
Phœnicia, 477—Roumania, 230, 500—Russia, 97, 501—Scotland, 231—	
Siam, 207—Spain, 498—Tunisia, 81, 464—Turkestan, 211—Turkey, 97—	
United States, 98, 232, 504.	
BABELON (Ernest) . Recent archæological discoveries in Persia,	53
——. <i>Intailles antiques de la Collection De Luynes</i> ,	286
BROWN (Francis) . Notes on Biblical archæology,	428
CLARKE (Joseph Thacher) . A proto-Ionic capital from the site of Neandreaia, 1, 136	
——. A Doric shaft and base found at Assos,	267
CORRESPONDENCE ,	61, 180, 334, 443
DUVAL (Émile) . A Hittite cylinder in the Musée Fol at Geneva,	132
EMERSON (Alfred) . The portraiture of Alexander the Great: a terracotta	
head in Munich (I),	408
——. Notice of <i>Kulturhistorischer Bilderatlas</i> , by TH. SCHREIBER,	201
——. Summaries of Periodicals,	105, 236
FOWLER (Harold N.) . Archæological News,	79
——. Summaries of Periodicals, 101, 106, 234, 242, 366, 376, 377, 378, 509, 514, 517	
FROTHINGHAM (Arthur L. Jr.) . Notes on Christian Mosaics. II. The por-	
tico of the Lateran Basilica,	414
——. Note: An American Expedition to Magna Grecia,	179
——. Notice of <i>Unedirte römische Fundberichte</i> , by TH. SCHREIBER,	77
——. Review of <i>La Glyptique Orientale</i> , by J. MÉNANT,	187
——. Review of <i>Archéologie du Moyen Age</i> , by J. QUICHERAT,	199
——. Review of <i>Dictionnaire des Fondateurs, etc.</i> , by CHAMPEAUX,	347
——. Review of <i>Archéologie Chrétienne de Carthage</i> , by DELATTE,	351
——. Notice of <i>Dizionario Epigrafico</i> , by E. DE RUGGIERO,	351
——. Review of <i>Ancient Coptic Churches of Egypt</i> , by A. J. BUTLER,	443
——. Review of <i>Catal. de la Collection de Clercq; Antiquités Assyriennes</i> , by	
DE CLERCQ and MÉNANT,	455
——. Notice of <i>Les Musées d'Athènes, Fouilles de l'Acropole, etc.</i> , by P. CAV-	
VADIAS,	457
——. Archæological News,	79, 208, 460
——. Summaries of Periodicals, 102, 103, 112, 235, 238, 353, 354, 362, 373, 507	
FURTWÄNGLER (A.) . Note on plate v. 2, of volume I,	52
GARDNER (Ernest A.) . Excavations at Naukratis,	180
KRAUS (F. X.) . A MS. of the Minnesinger, and an early Christian cemetery	
at Trèves,	425
LEWIS (T. H.) . The "Monumental Tortoise" mounds of "De-coo dah,"	65
LONGFELLOW (William P. P.) . Review of <i>Phidias</i> , by MAX. COLLIGNON,	342

ALPHABETICAL TABLE.

vii

	PAGE.
LUDLOW (Th. W.). Letter: Permanent Fund for the American School at Athens,	459
MARQUAND (Allan). Summaries of Periodicals,	118, 518
MARSH (Arthur R.). Review of <i>Essays on the Art of Pheidias</i> , by CH. WALDSTEIN,	182
———. <i>Archæological News</i> ,	79
MARUCCHI (Orazio). Recent excavations in Rome,	334
MASPÉRO (Georges). Procès-verbal de l'ouverture de deux momies royales au Musée de Boulaq (Seti I et Sequenra-Tafaaqen),	331
MÉNANT (Joachim). Oriental Cylinders of the Williams collection,	247
MERRIAM (Augustus C.). Law Code of the Kretan Gortyna (II),	24
———. Egyptian Antiquities. I. Two Ptolemaic inscriptions: II. Mummy tablets,	149
———. Note on <i>Law Code of the Kretan Gortyna</i> ,	424
———. Note on An inscription from Kedraei,	425
———. Review of <i>Traité d'Épigraphie Grecque</i> , by S. REINACH,	70
———. Summaries of periodicals,	115, 241, 511
MILLER (Walter). Excavations upon the Akropolis at Athens,	61
MUNTZ (Eugène). The lost mosaics of Rome (I),	295
NUTTALL, (Zelia). The terracotta heads of Teotihuacan,	157, 318
RAMSAY, (W. M.). Notes and Inscriptions from Asia Minor (II, III),	21, 123
REINACH (Salomon). Two marble heads in the Museum at Constantinople,	314
STURGIS (Russell). Review of " <i>Tiryns</i> ," by H. SCHLIEMANN,	75
———. Review of <i>Bausteine, etc.</i> , by FRIEDERICH-WOLTERS,	437
SUMMARIES OF PERIODICALS,	101, 234, 353, 507
<i>Archäologische Zeitung</i> ,	101, 234
<i>Bullettino di Archeologia Cristiana</i> ,	102, 353
<i>Bullettino della Commis. arch. Com. di Roma</i> ,	103, 235
<i>Bulletin de Correspondance Hellénique</i> ,	105, 236, 354
<i>Bulletin Monumental</i> ,	362
<i>Bulletin Trim. des Antiquités Africaines</i> ,	238
<i>Ἐφημερίς Ἀρχαιολογική</i> ,	106, 366
<i>Gazette Archéologique</i> ,	112, 373, 507
<i>Jahrbuch d. deut. archäol. Instituts</i> ,	376, 509
<i>Journal of Hellenic Studies</i> ,	115, 241, 511
<i>Mittheilungen d. deut. archäol. Instituts: Athen. Abth.</i> ,	242, 377, 514
<i>Mittheilungen d. deut. archäol. Instituts: Röm. Abth.</i> ,	378, 517
<i>Revue Archéologique</i> ,	118, 518
WARD (Dr. Wm. Hayes). Notes on Oriental Antiquities. I. Two Babylonian seal-cylinders,	46
———. Notes on Oriental Antiquities. II. Two seals with Phœnician inscriptions,	155
———. Notes on Oriental Antiquities. III. A god of Agriculture,	261
———. Unpublished or imperfectly published Hittite monuments. I. The façade at Eflatûn-Bûnar,	49
WORTHINGTON (John). Review of the <i>Megalithic Antiquities of Hagiar Kîm, Malta</i> , by A. A. CARUANA,	451
WRIGHT (John Henry). Unpublished White Lekythoi from Attika,	385
X. Archæological Congresses in France in 1886,	433

COPYRIGHT, 1887, BY A. L. FROTHINGHAM, JR.

**JOHN MURPHY & CO., PRINTERS,
BALTIMORE.**

AMERICAN JOURNAL OF ARCHÆOLOGY.

VOL. II.

No. 1.

A PROTO-IONIC CAPITAL FROM THE SITE OF NEANDREIA.

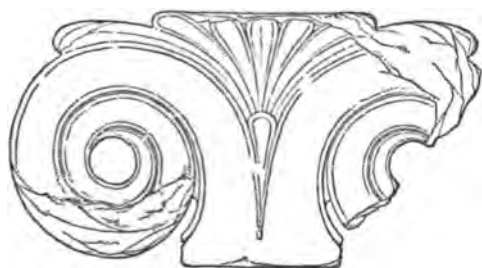


FIG. 1.—*Present condition of the block.*

I.

This capital,—the most primitive memorial of the Greek Ionic style as yet brought to light,—was found by the writer, Sept. 24, 1882, upon the summit of Mount Chigri, in the Troad. Chigri is midway between Assos and Ilion, opposite Tenedos, and ten kilometres from the coast of the Aegean. The extensive ruins upon the site are, as will be shown, in all probability those of the ancient Neandreaia. They have never been disturbed by excavations, and for more than 2,000 years this remote and precipitous height has been uninhabited. During previous surveys, in 1881 and the spring of 1882, no sculptured stones or architectural members were to be seen above the surface of the ground. But in the summer of the latter

year Turkish masons from the neighboring village of Yailadjiq, in search of squared building-stones, had dug a shallow trench within the city enclosure, exposing a corner of this block, which escaped destruction because of its irregular shape. It was easily freed from the soil, and was afterwards removed by Mr. Frank Calvert to the farm of Akchi-Kieui (Thymbra), where it was carefully examined and drawn. Together with it were discovered various fragments of archaic terra-cotta,—portions of a leaved kyma, decorated with a dark purple and black glaze like that found upon the most ancient terra-cottas of Sicily.

The stone is a fine-grained volcanic tufa, of a light reddish-gray color, obtained from a formation occurring in various parts of the western and southern Troad. At Assos this material is employed only in the oldest works, such as the lion's head which formed one of the gargoyles of the chief temple,¹ and a scroll believed to be part of an akroterion of the same building. Tufa is never found among later remains, and thus bears the same relation to the archaic architecture of the Troad as poros does to that of the Peloponnesos and Sicily. The first Greek stone-cutters required a material more easily worked than andesite, or even marble, and made up for the roughness of the stone by priming the surface with stucco and painting it with body color.

The capital remains in a state of preservation so good, that no doubt can exist concerning any detail of the design. Some of the corners have been split off, nearly half of one of the volutes being missing; but in view of the friable nature of the tufa, and its long exposure to the weather, the sharpness of the remaining tooled edges is surprising (*fig. 1*). The building to which the capital belonged must have been a ruin twenty-two centuries ago, and the block, when found, was not protected by any great depth of earth; yet the surface has not been at all affected by a decomposition like that which has so obliterated many of the sculptures and mouldings of the harder and coarser stone used at Assos.

The excellence of the design can have resulted only from an acquaintance with many spiral prototypes; and the admirable character of the technical execution is proof of a long practice in the

¹Now in the Boston Museum of Fine Arts: No. S. 1162. Cf. the writer's *Report on the investigations at Assos, 1881*. Boston, 1882, p. 94, pl. 12.

carving of similar details. The capitals of the later ages of Greek art are of a higher and more organic development, better serving in æsthetic respects as functional members of the columnar system; but they are rarely of better proportion, or of a more firm and graceful outline (*fig. 2*). Too much emphasis cannot be laid upon the fact,

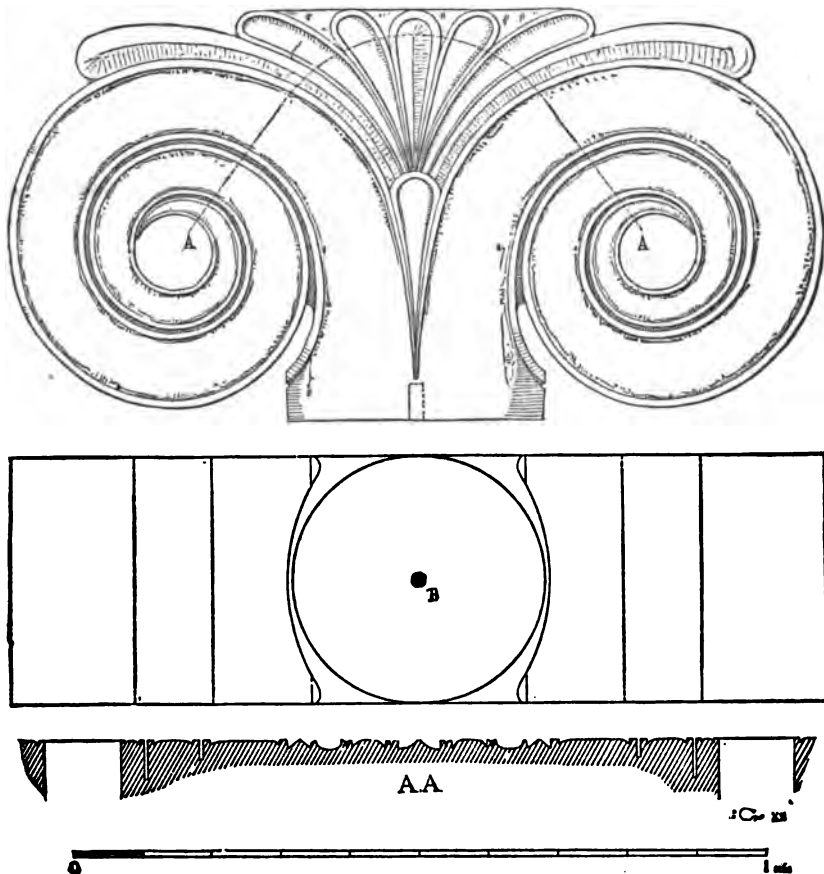


FIG. 2.—Restored view: plan and section of capital.

thus evident, that this capital is by no means a first experiment in the application of spiral forms to the upper member of a column, but is rather to be considered as a link in the long chain of architectural development which gradually led to the perfect forms of the capitals of the Erechtheion.

The helix is exact, and seems to have been determined by unwinding a cord, to the free end of which was attached a chisel-point, from a cylinder about 0.03m. in diameter, or perhaps,—for so great a refinement is not inconsistent with the character of the design,—from a slightly diminished cone as the evolute, fixed in the centre of the perforation. The bordering fillets of the spiral vary in width from 17mm. to 3mm., and are perfectly accurate to their very termination. The intelligent skill of the designer is especially to be seen in the manner in which the leaves of the anthemion have been profiled: their plane-angular, fluted, reeded, and concave-angular sections securing a play of light and shade such as no geometrical drawing can indicate (section AA, *fig. 2*). The incisions which separate the surfaces of the volutes are deepened as they retreat from the centre, gradually increasing from a shallow notch to a cut not less than 0.11m. deep. The spiral line thus varies in appearance from a light grey to a perfectly black shadow. The circular perforation in the centre of the volute,—the *ὀφθαλμῶς* of the Erechtheion inscription,²—measures 0.125m. in diameter. It probably served for the insertion of disks of some brilliant material, such as colored marble, glass, or metal. This method of decoration had been common in the Oriental prototypes from which the most characteristic features of the Ionic style were derived, and, though seldom adopted by the Greeks of a later period, was still employed in the volutes of the fully-developed Ionic capital,³ as well as in the eyes of the parotides and guilloche mouldings. The hole is cut completely through the stone, for what purpose is not clear.

The capital, at its point of juncture with the shaft beneath, is not exactly circular in plan; the diameter from side to side being 0.01m. greater than from front to back. The summit of the shaft must consequently have been slightly elliptical. This irregularity of the stone-cutting is very remarkable in view of the perfection of the spirals and mouldings; and, as the excess is in the axis of the epistyle, it may have resulted from the capital, or more probably the shaft, having been cut from a block not sufficiently thick to allow one of the dimensions to equal the diameter determined by the

² II. 42. Hence termed *oculus* by Vitruvius (III. 5, 6), whose technical terms are, for the greater part, translated from the Greek.

³ As for instance in the Erechtheion, in the great temple of Ephesos, in that of Sardis, etc.

designer. The capital was attached to the drum adjoining it by a cylindrical dowel, the hole for which (B, in plan *fig. 2*), 0.02m. in diameter and 0.055m. deep, is bored with great nicety. This pin must have served as an axis for the grinding of the capital upon the subjacent stone, during the last rubbing down of the bed surfaces. The top of the capital, which is tooled to a perfect plane, shows no traces of dowels or clamps. The reverse of the stone is, in all the main features of the design, the same as the front, but the details are somewhat less elaborate and the execution less careful. The scroll of the back is slightly rounded in profile, but has no bordering fillets, while the anthemion leaves are of simpler section, and without rims.

It is a question of much importance whether the shaft, to which the capital belonged, was placed close to a wall as a stele, or was employed as a constructive support in a building. The small diameter of the column, and, especially, the fact that one side of the capital was evidently not exposed to close inspection, seemed at first to favor the former view. After careful examination, however, the writer became convinced that the capital surmounted a tall column, probably standing *in antis* and supporting a wooden epistyle.

Notwithstanding the great projection of the volutes,—the width of which far exceeds that customary in the steles of Greece,—the bearing of the imposed weight is limited to the middle leaves of the anthemion. If the block had been the capital of a stele, intended, for instance, as a stand for inscribed stones or votive offerings, advantage would naturally have been taken of the console-like projection of the scrolls by a bearing upon the outermost leaves. This restriction of the abacus to a surface less than half as broad as the capital itself must have been determined by the consideration that, otherwise, the slightest sagging of the epistyle-beam would have crushed the sides of the volutes. From the extreme care taken to disengage the outermost leaves of the anthemion from contact with the lintel, it is evident that this precaution was held in mind.

The great projection of the volutes, as well as their shape, was derived from traditional models. The form, originally determined by the exigencies of a timbered construction, was here retained as a mere decoration, filling out the corners between the vertical support and the horizontal lintel. Thus, all the leaves of the anthemion and the backs of the volutes approach very nearly to the soffit of the epistyle, which, in the most closely related prototype (*fig. 7*), they

had actually adjoined. That the precaution was taken to restrict the weight of the entablature to a part of the capital but little larger than the upper diameter of the shaft, proves it to have formed part of a constructive framework. The lack of dowellings between this support and the imposed mass is, so far as it goes, in favor of the same conclusion. The stones of Greek steles, because of their liability to be displaced by lateral pressure, were commonly joined together by metallic fastenings cast in lead; but, for evident reasons, the abacus of a true column is not often thus connected with the lintel above it.

The most conclusive argument, however, is to be derived from the size of the block. A calculation based upon the proportions of monuments of the fully-developed Ionic style leads to the assumption, that the shaft and base belonging to the capital would, together with it, reach a height of between four and four and a half metres. Even this is considerably more than the height of the columns of many prostyle temples; and a building with columns *in antis* must necessarily be assumed to have been of modest dimensions, especially in the Troad.⁴ But it is probable that the actual size of the shaft was greater than we should be led to expect from such a comparison. The columns of primitive Greek architecture were, in general, more diminished than those of the perfected styles; the ratio of the upper diameter to the lower, and to the height of the shaft, would consequently have been smaller than that assumed. The fact that the back of the capital is not treated with the same elaboration and care as the front is explained by the assumption that it was situated at some height, in a dark and narrow pronaos *in antis*, so that a good view of the inner side could not be obtained.

All these points,—the excessive projection of the volutes, resembling the original wooden prototype of the console-capital, the precautions taken to prevent the edges from being injured by a sagging of the epistyle-beam, the fragile nature of the stone, and the small diameter of the shaft,—lend weight to the supposition that the entablature was formed, not of blocks of stone, but of timbers and joists, such as those imitated in the fascias and dentils of the later Ionic style.

The width of the capital is exactly twice its height, the volutes being drawn in squares the sides of which are, as nearly as could be

⁴The Heroön of Assos, a Doric prostylos, has columns 3.6m. high.

measured without instruments of precision, 0.594m. long (1 ft. 11 $\frac{3}{4}$ ins.). This dimension may with much probability be supposed to equal two feet of the measure used by the designer, the result being a unit of 0.297m. ($\frac{1}{3}$ of an inch less than one English foot). The thickness of the block is 0.357m., three-fifths of its height, or three-tenths of the assumed unit. The question of the metrological importance of these dimensions, and the decimal division of the foot employed throughout the Troad in the earliest historical ages, should not be entered upon until the stone has been measured with metrological exactness.

The exceptional interest of our capital lies in its historical significance. It is one of the few memorials of the earliest period of architectural development among the Greeks that have not been swept away in the construction of the noble buildings erected soon after the Persian wars, or of the showy edifices of the Diadochi. The history of Neandreaia will explain the circumstances which secured the preservation of those remains not easily removed from the site during ancient times. The capital cannot be ascribed to a later date than the sixth century B. C. It is one of the many experiments made by the Greeks of Asia Minor to determine the forms which, according to the tradition preserved by Pliny⁵ and Vitruvius (iv. 1, 7), were first employed in connection with a peripteral plan in the primitive temple of Ephesos.

The testimony of antiquity is unanimous in the assertion, that the Ionic style, as its name signifies, was derived by the European Greeks from the eastern coast of the Aegean.⁶ Discoveries of the present age have, further, made it evident, that the most characteristic features of this style passed through the earliest stages of development, neither in Greece nor in Asia Minor, but in Mesopotamia.

Before the application of the historic method to the study of the derivation of architectural forms, the determination of the influences which led to the adoption of the Ionic details was nothing but hope-

⁵ Pliny's words (xxxvi. 56), in *Ephesia Dianae aede primum columnis spirae subditae et capitula addita*, can only be referred to capitals, as well as to bases, of the Ionic style.

⁶ Nothing can be more at fault than Boetticher's statement (*Tektonik der Hellenen*. Berlin, 1874, second edition, vol. i. p. 165) that the Ionic style originated in Attica. The entire position of this remarkable work in regard to questions of architectural history is a warning against the misleading influence of æsthetic theories.

less conjecture. It is not long since, that scholars literally believed, or at all events seriously considered, the explanation of the origin of the style given by Vitruvius (IV. 1, 7), who relates that the Ionic column imitated the proportions of a woman,—the volutes of the capital representing the curled locks of hair; the flutes and fillets of the shaft, the folds of the wide draperies; and the base, the sandals. Thiersch,⁷ who occupied a position of the highest eminence among classical scholars during the first half of the present century, gave this picture a touch of reality by his identification of the Ionic woman as a priestess with curled tainias tied about her ears. Whatever may be the truth of the Vitruvian simile, as characterizing the lightness and grace of the Ionic in comparison with the virile proportions of the Doric, modern writers, in following the example of the Roman *maestro muratore*, have not restricted their comparisons to such pretty themes.

Winckelmann⁸ suggested that coiled snakes may have served as models for the volutes. Stackelberg⁹ argued that the twisted horns of rams, suspended on the walls of primitive sanctuaries, or on the corners of altars, were imitated by the original designer of the Ionic capital. This idea was elaborated by Raoul-Rochette,¹⁰ and particularly by Carelli,¹¹ passing into the text-books through K. O. Mueller.¹² Wolff¹³ believed that the bark of trees, placed upon the top of the Doric echinos "before it had an abacus," by curling round the block had provided the starting point for the helix; while Hahn¹⁴ took the spirals of marine shells as his model. Among the advocates of such absurd prototypes we may note no less an authority than

⁷ F. W. Thiersch, *Ueber die Epochen der bildenden Kunst unter den Griechen*. (Second edition) Halberstadt, 1829.

⁸ J. J. Winckelmann, *Versuch einer Allegorie, besonders fuer die Kunst*. Dresden, 1766.

⁹ O. M. von Stackelberg, *Der Apollotempel zu Bassae*. Frankfurt am Main, 1826.

¹⁰ D. Raoul-Rochette, *Monuments inédits d'Antiquité*. Paris, 1834.

¹¹ F. Carellius, *Dissertazione esegetica intorno all'origine ed al sistema della sacra architettura presso i Greci*. Napoli, 1831.

¹² K. O. Mueller, *Handbuch der Archaeologie der Kunst*. (Third edition) Stuttgart, 1878, 54, 3.

¹³ J. H. Wolff, *Aesthetik der Baukunst*. Leipzig, 1834. This explanation has been reiterated, during the past year, by H. Jennings, *Phallicism, celestial and terrestrial, heathen and Christian*. London, 1884.

¹⁴ G. von Hahn, *Motive der Ionischen Saule*. Wien, 1862.

Viollet-le-Duc,¹⁵ who conceived the Ionic volute to have been copied from curled shavings left by the primitive carpenters upon the sides of their wooden posts, illustrating this tasteless theory by a cut that shows forms which wood could not assume under any treatment. Even less satisfactory are those conceptions of an idealized spring, taking the shape of an elastic cushion, which, placed upon the Doric capital in the direction of the epistyle, is supposed to have been squeezed out by the superimposed weight of the entablature so as to curl again around the edges of the echinos. Chief among the professors of this view is Guhl.¹⁶ This list might be greatly extended. Marini¹⁷ gives the names of no less than twenty-six writers upon the Ionic capital previous to the publication of his own work in 1825. Some of the early treatises, such as those of Selva¹⁸ and De Rossi,¹⁹ display an ingenuity and a learning worthy of a better cause.

All these labored explanations of the significance and derivation of the Ionic capital have fallen to the ground,—all this misdirected antiquarianism has become a fit subject for ridicule,—upon the recognition of the fact that a capital of anthemions and volutes, essentially of the same character as that of the Ionic style, was customary in Mesopotamia for centuries previous to the development of Greek architecture, and is to be traced through Kappadokia, Phrygia, and Phœnicia, to the coast of Asia Minor occupied by the Hellenes. A great variety of terminal ornaments were formed by the designers of Assyria in imitation of the radial leaves of the palmetto. The ends of quivers, the plumes of horses' trappings, and other unweighted tips, appear of precisely the same shape as the conventional representations of palm-trees upon Mesopotamian reliefs. When these palmettos were so bound together as to form the so-called Tree of Life, or such branches of flowers as are held by certain deities, the ends of the connecting ribbons or the bracts were curled at the base, taking the place of the bunches of dates seen under the palm-trees of the reliefs. In architectural details this form was adopted, almost without change, for the apex of steles. Among the ruins of the palace

¹⁵ E. E. Viollet-le-Duc, *Entretiens sur l'architecture*. Paris, 1858-72. Fig. 6.

¹⁶ E. Guhl, *Versuch ueber das Ionische Kapital*. Berlin, 1845.

¹⁷ L. Marini, *Sul ritrovamento da me fatto dell' metodo di descrivere la voluta Ionica Vitruviana*, in the *Atti dell' Accademia Romana di Archeologia*. Roma, 1825, vol. II.

¹⁸ G. Selva, *Dissertazione sulla voluta Ionica*. Padova, 1814.

¹⁹ G. de Rossi, *Esercitazione sulla voluta del capitello Ionico*. Firenze, 1817.

of Khorsabad²⁰ a square post has been preserved, in all respects like the anthemion steles of Greece, the terminating palmetto being the same as that continually occurring upon Greek vases²¹ and the antefixes of early Greek temples.

It is with the higher development of these forms, through their connection with the functional capital, that we are at present concerned. By the adoption of the palmetto as an ornament intermediate between a support and an imposed weight, the spread of the leaves was necessarily much restricted. An increased importance was thus assigned to the projections adjoining the shaft. It was natural that this should have been made in the shape of a volute. The spiral was, in every way, the form most pleasing to the early Mesopotamian decorators. Not only did the ends of bows, the hilts of swords, the carved ornaments of furniture, and the embroidered



FIG. 3.—Ivory-carvings from the north-western palace of Nimroud.

trimmings of robes assume this shape, but the spiral served in the pictorial art of Assyria to represent objects really of entirely different outline, such as entwined stems and leaves of plants, curls of the human hair and beard, and even ripples of water. In short, the spiral was as universal in the designs of Mesopotamia as were the triangle and the zig-zag in those of Egypt.

Out of the ornamental spirals and palmettos of Assyria were gradually developed the volutes and the anthemion of the Ionic style. Semper,—most suggestive of writers upon the architectural forms of the ancients,—displayed the extraordinary intuition for

²⁰ V. Place, *Ninive et l'Assyrie*. Paris, 1867-70, vol. III. pl. 34.

²¹ One among many: Attic lekythos, with a representation of Orestes at the tomb of Agamemnon, from the collection of Count Pourtales-Gorgier, published by Raoul-Rochette in his *Monuments inédits d'Antiquité*, pl. XXXI. A.; and also by A. Maisonneuve, in his *Introduction à l'étude des vases antiques*. Paris, 1817, pl. xxx.

which he is remarkable, when he declared the evolution of the Ionic capital to exhibit a *stufenweise Umbildung des zuerst nur eine leichte Palmette tragenden Volutenkelches in den balkenbelasteten Saulenknopf*.²² The capabilities of this combination for conventionalized development led to its frequent employment in the details of various architectural decorations. Several ivory-carvings from pieces of furniture, found in the north-western palace of Nimroud and now in the British Museum, clearly show the Assyrian form of this capital²³ (fig. 3). That marked A is not, strictly speaking, an architectural detail. A lateral connection, visible beneath one of the volutes, shows it to have formed part of such ornamental foliage as that before referred to. The palmetto is consequently predominant and of a semi-circular outline. B and C, on the other hand, show the form as adapted to a functional capital. The leaves have decreased in size and elaboration; they have become a simple anthemion, and are terminated by the straight line of an epistyle. The volutes occupy three quarters of the height; they are of more independent formation and better proportion. The horizontal lines at the base are multiplied and emphasized, forming a division between the capital and the shaft similar to the annulets of the floral columns of Egypt. The absolute similarity between these two examples proves that the shape was a definitely determined type of decoration. There is every reason to believe that these ivories are exact representations of a capital systematically employed in Assyrian architecture. They are essentially the same as the early Greek capital of Mount Chigri, from which they differ only in the imperfect spiral

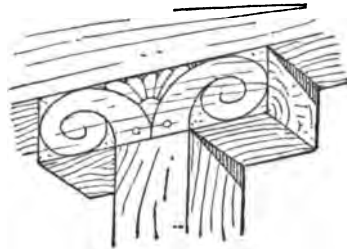


FIG. 4.—Supposed decoration of the original wooden capital.

²² G. Semper, *Der Stil in den technischen und tektonischen Kuensten*. (Second edition) Muenchen, 1878. Compare, also, J. Braun (*Geschichte der Kunst*, Wiesbaden, 1856-58), "*Der Ionische Stil gehoert Niniveh, vielleicht bereits Babylon an; denn er ist der gemeinsame Stil Asiens schon in unberechenbar aller Zeit—er ist ein maechtiger Stil, dessen Sendboten wir durch ganz Kleinasien und ueber die phoenikische Kueste nach Karthago und ins innerste Afrika verfolgen koennen.*"

²³ That marked A is shown in a small and inexact vignette serving as the tail-piece to the list of illustrations in Layard, *Discoveries in Nineveh and Babylon*. London, 1853. The others have not hitherto been published.

of the volute, and in the triangle masking the convergent lines at the base.

Owing to the nature of the building-materials of Assyria, the columns of that country were of wood,²⁴ and but few vestiges of them have been preserved. Fragments of wooden shafts, encased in scales of bronze, have, however, been found,²⁵ and these suffice to give certainty to the conclusions derived from the representations of columns upon Mesopotamian reliefs.

No doubt can exist as to the origin of the spiral capital from the application of the above-described forms to the details of such wooden supports. As is the practice in every rational construction of timber, a horizontal block, projecting in the direction of

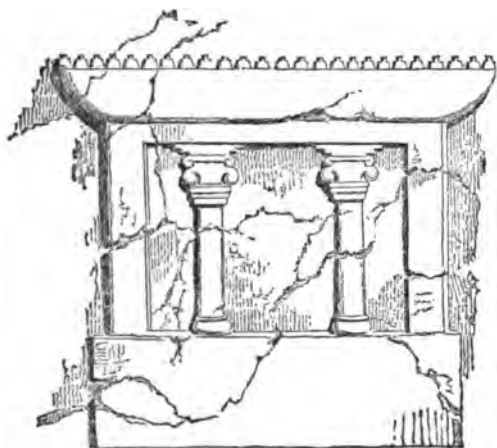


FIG. 5.—Assyrian aedicula from a relief. Khorsabad.

the imposed beam, was placed between the support and the epistyle (*fig. 4*). This intermediate member lent itself readily to a decoration of anthemion leaves and lateral volutes. Spirals were drawn upon the projecting sides, either in color or in incised lines. Wooden columns with capitals of this kind, similar in design to the ivory-carvings before described, seem

to have been universal in Assyria, and to have formed, so to speak, the only columnar order of the architecture of that country. They appear in the well-known representations of aediculas, like that

²⁴ Layard's workmen kindled their watch-fires with the timbers employed nearly three thousand years ago in the construction of the palaces of the Assyrian kings. Strabo (739), in an interesting passage relating to the buildings of Babylon, remarks that both beams and columns were made of the trunks of palm-trees, the latter, in the dwellings of the poorer classes, being wound around with twisted wisps of straw, coated with stucco and painted. A more monumental method of this revetment, referred to in Note 25, imitated the scales of the palm-tree in sheets of bronze.

²⁵ A cylindrical column of cedar wood was found and published by Place, *Ninive*, vol. I. p. 120, and vol. III. pl. 73.

standing in a royal park, upon a relief from the northern palace of Koyundjik,²⁶ and that on the bank of a river, from Khorsabad²⁷ (*fig. 5*). The fact, that the spirals are, in these instances, so doubled that four volutes appear between the shaft and the epistyle, does not affect the fundamental character of the capital, this duplication being due to the adoption of two transverse blocks of wood, instead of one.

Even more exact information concerning the appearance of the Mesopotamian capital is to be obtained from the Sippara stone, dating from about 900 B. C., now in the British Museum. Upon it is shown one side of a tabernacle under which a deity sits enthroned, and it is believed by Assyriologists that the artist has here imitated details of the chief sanctuary of Sippara. The column is represented with the greatest care. The slender shaft, evidently of wood, appears to be covered, in imitation of the bark of a palm-tree, with scales like those discovered by Place, and the capital is of a spiral form, very similar to the ivory-carvings (*fig. 6*). The volutes spring from the shaft, from which they are separated by three annulets. They bear a bud of semi-circular outline, of the same general form as the anthemion, and precisely like that of a Phœnician capital found in Kypros (*fig. 7*), this abbreviation of the palmetto having been rendered necessary by the cramped space between the scrolls, which did not allow an indication of the separate leaves. The appearance of these details upon the base, as well as upon the capital, of the Sippara column is the clearest possible evidence of the timbered construction: the intermediate block of carved wood being as much needed between the base of the post and the sill, as between its summit and the epistyle beam. The adoption of forms originally thus determined does not, of course, disprove the assumption of Perrot,²⁸ that the capital of



FIG. 6.—Upper part of a Babylonian column from the Sippara stone.

²⁶ A. H. Layard, *Nineveh and its Remains*. London, 1849, vol. II. Published also in G. Rawlinson, *The Five Great Monarchies of the Ancient Eastern World*. (Second edition) London, 1871, vol. I.; and in many other text-books.

²⁷ Botta et Flandin, *Monuments de Ninive*. Paris, 1849–50, pl. 114. The illustration is taken from this work.

²⁸ Perrot et Chipiez, *Histoire de l'Art dans l'Antiquité*. Vol. II. *Assyrie*. Paris, 1883. The author, however, certainly goes too far when, in the subsequent volume of the

Sippara was itself executed in sheet bronze, either soldered or beaten to shape. The prototype,—the member to which the helix and anthemion were first applied as a decoration,—was certainly of wood.

The forms of the baluster, from its first appearance until the present day,—during well-nigh three thousand years,—have never overcome the one-sidedness resulting from this original timbered construction. Contrary to the Doric and Corinthian capitals of the ancients, to the trapeze-shaped capital of the Byzantines, and to the cube capital of the Romanic style, the Ionic volutes, like the consoles of such Indian piers as those of the grôtto of Ajanta, are chiefly developed in the direction of the epistyle. When we, today, employ the spiral capital,—whether placing the volutes vertically, like those of Pompeii, or horizontally, according to Vignola's textbook of the Renaissance,—we make use of forms which can be traced back to the details of Mesopotamian ornament: in the same way that so many of the words which we utter are derived, through many transformations, from the primitive speech of our Indo-European ancestors.

Long before the Greeks had built in the Ionic style,—while the stone walls of the primitive fanes of Hellas still supported the beams imitated in the Doric entablature,—the races inhabiting the plateaus of Kappadokia, Lykaonia, and Phrygia, in Asia Minor, had derived the chief features of their architecture from Mesopotamia. The spiral capital of Assyria appears in Kappadokia in a city probably destroyed as early as the time of Kroisos;²⁹ the Assyrian palmetto has recently been found as the termination of a column in the great necropolis of ancient Phrygia;³⁰ and the celebrated tombs of Lykia, especially those of Antiphellos, Myra, and Telmessos, exhibit, together with

history, he assumes that the form of the volutes was suggested by a sphyrelaton model.

²⁹ Identified with Pterion in G. Perrot, *Exploration archéologique de la Galatie et de la Bithynie, d'une partie de la Mysie, de la Cappadoce et du Pont; exécutée en 1861*. Paris, 1862-72. Compare a general view of the Ionic style given by the same author in an essay on *l'Art de l'Asie Mineure, ses origines, son influence*, reprinted from vol. xxv. of the *Revue Archéologique* in his *Mémoires d'Archéologie, d'Épigraphie et d'Histoire* (Paris, 1875); and in his short note *Sur l'origine de l'Ordre ionique*, in the *Bulletin de la Société Nationale des Antiquaires de France*, année 1871.

³⁰ W. M. Ramsay, *Some Phrygian Monuments*. Reprinted from the *Journal of Hellenic studies*, 1882, pl. xlx.

late and debased forms, such primitive features as to place it beyond doubt that this province was an important station in the advance of the Ionic style from Mesopotamia to the Aegean. The most striking examples of the intermediate stages of development, however, are the Phœnician works brought to light in Syria, Malta, and especially in Kypros. All the varieties of the Assyrian volute are recognizable among these remains. A capital discovered at Trapeza, near Famagusta, Kypros, now in the Louvre,³¹ (*fig. 7*), is of precisely the same type as that represented by the ivories of Nimroud, and the capital of Chigri. The clearest possible understanding of the development of the Ionic volutes is gained by a comparison of this work with the conventional decorations of Mesopotamia on the one hand, and the

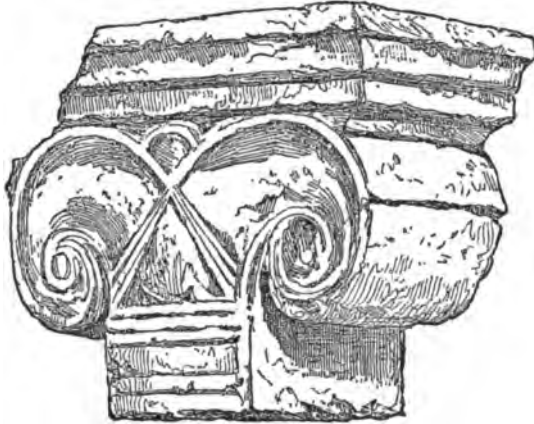


FIG. 7.—*Phœnician capital found at Trapeza, Kypros.*

primitive Greek capital on the other, between which it forms a connecting link. The designers of Phœnicia, in adopting the forms of Assyrian art, served rather to perpetuate than to perfect. In architectural history the importance of this commercial people consists in their having spread abroad methods of artistic expression derived by them from older civilizations, rather than in any great progress of their own. The capital of Trapeza is an improvement upon the Assyrian model, in that the volutes occupy the entire height between

³¹ Perrot et Chipiez, *Histoire de l'Art dans l'Antiquité*. Vol. III. *Phénicie-Chypre*. Paris, 1885. The illustration is taken from this work. The height of this capital is 0.75, the thickness 0.30, the length of the abacus 1.22m.

the abacus and the annulets, and approach more closely to the true curve of the helix. But in other respects the changes are few and by no means advantageous. The square plan of the original wooden post has been retained, together with the broad annulets and the triangle of hard lines, which are connected with the base of the volutes in a most inorganic fashion. The high abacus of long and narrow plan, borrowed from the capitals of another style, restricts the development of the spiral projections and cramps the anthemion to a mere knop, of still less importance than that of the Sippara capital.

Even before the discovery of the capital from Mount Chigri, the representations of Ionic details upon the most ancient Greek vases made it evident that the primitive form of this member must have had a much greater projection than that customary in the perfected examples, and that the volutes did not lie upon an echinos moulding, but grew directly from the shaft, bearing between them an anthemion.



FIG. 8.—Ionic capital from an archaic vase.

An archaic amphora from Volcei, now in the British Museum,³³ clearly shows this formation (*fig. 8*). The painted and incised outline upon this vase might be a direct imitation of such a capital as that now brought to light, with which it agrees even in proportions. Another archaic vase of the same collection (No. 480) shows a very similar capital. The architectural details of such paintings were

³³ The painting on this vase is published by E. Gerhard (*Auserlesene griechische Vasenbilder*. Berlin, 1839-58, vol. IV. taf. CCXLI) but without sufficient accuracy for architectural comparison. Capitals of the kind are by no means uncommon: compare F. Inghirami, *Pitture di Vasi*. Firenze, 1852-56. Vol. III. Tav. 384.

In rare instances volute capitals of primitive form were executed in relief. One of the most remarkable examples is the detail of terra-cotta,—possibly the handle of a large vase,—found during the excavations at Assos. Its upright scrolls and clumsy abacus are touched with white, the rest of the red clay being covered with a dull-red surface-priming. This fragment is now in the collection of antiquities from Assos, in the Boston Museum of Fine Arts, and is numbered P. 4121.

It is probable, also, that the heraldic sphinxes of Assos, upon the epistyle of the chief temple of that place, rest their paws upon a diminutive Ionic stele, in the same manner as the lions of the gate of Mykenai face an inverted proto-Doric column. The surface of the stone has been so obliterated by weathering that the spirals cannot be traced upon either of the reliefs; still, it is plain, from that in Boston numbered S. 1158, and especially from that shown by pl. 19 of the Assos Report, that the sculptor has here represented the outline of the volutes, and even of the middle anthemion, of an archaic Ionic capital.

declared by Hittorff to be *les seuls souvenirs qui nous restent d'édifices sacrés sur lesquels les notions historiques ont entièrement disparu.*³³

The discovery here published supplies the actual archaic example hitherto wanting.

The Chigri capital shows a great improvement, even upon those works most closely related to it which have been found in the interior of Asia Minor and in Kypros. Hellenic genius, brought to bear upon this architectural member, at once manifests its superiority in technical respects. The deformed volutes of the Kypriote capital have become perfect spirals, while the anthemion leaves, as before explained, are of great subtlety of design. The disturbing triangle at the base of the volutes has been omitted; and the annulets, if still employed, are transferred to the shaft. A decided progress is noticeable in the omission of the Phœnician abacus, and the restriction of the epistyle-bearing to a small part of the capital. In this point the style has here already attained to its final perfection.

In other regards, it is still far removed from the most primitive Ionic capitals of Greece hitherto known. The excessive projection, considerably greater upon either side than the diameter of the shaft, betrays the close dependence of the capital upon the forms of a wooden construction. In striking contrast to the square termination of the Doric column, the plan of this member is so oblong that the front is more than three times as long as the side. A lateral projection so disproportionate, not only could never have originated in the stone terminations of a round shaft, but it would be difficult to believe from the drawing (*plan, fig. 2*) that the capital was executed in that material.

So one-sided a capital could only have been employed *in antis*. With the subsequent introduction of the peripteral plan it became necessary to render the proportions of front and side more nearly equal, in order to adapt the volutes to the corner column,—which always presented the chief difficulty of this style.³⁴ The important

³³ Hittorff et Zanthe. *Architecture antique de la Sicile*. (Second publication) Paris, 1870.

³⁴ The assertion of Lohde (*die Architektonik der Hellenen*, Berlin, 1862; reprinted in J. M. von Mauch, *Die architektonischen Ordnungen der Griechen und Römer*. Seventh edition, Berlin, 1875), that the forms of the Ionic style originated in connection with the peripteral and dipteral (!) plan is utterly incorrect, and would be beneath criticism, were it not that it is made in a popular text-book.

combination peculiar to the perfected Ionic capital, the conjunction of an echinos with the volutes, was one of the means chosen to effect this end. The front of the capital from Chigri is as entirely without projection, as is that of the hypothetical wooden support given in figure 4 to illustrate the first application of the helix to the termination of a column. In the Erechtheion, however, the length of the capital in proportion to its depth is found, when compared with that of Chigri, to have been reduced by very nearly one half, the ratio of the baluster to the front of the volutes being about 4 to 7.

The impossibility of allowing the epistyle to rest upon any part of such volutes as those of the Chigri capital, and the desire to emphasize the horizontal lines of the termination, led to a further change of much significance, namely, the inversion of the scroll in such a manner that the two spirals no longer proceeded from the shaft, but were connected by a horizontal band, upon the back of which rested the narrow abacus and the epistyle-beam. This arrangement is unquestionably of great antiquity, appearing upon the before-mentioned relief of Kappadokia and in archaic vase-paintings from Kypros. It was destined to wholly supersede the upright volutes. But, as in the Doric style some primitive features were retained in the antae-capitals, so, even in the latest periods of Greek architecture, the principle of the vertical volutes continued to be employed in the capitals of pilasters, as for example in those of the great temple of Miletos, and of that of Athena Polias at Priene. With this change in the position of the volutes the anthemion ceased to be a constituent member of the Ionic capital; yet so entirely had it been identified with the style, that it remained persistently in use as a subordinate decoration: appearing not only in antefixes, simas, and decorated bands, but in the inner corners of the spirals, and in the Attic necking of the capital itself. In the archaistic capital of the temple of Bassae, the anthemion even assumes its original position between the two volutes in the middle of the face.

There is but a single example known to illustrate the stages of development intervening between the capital from Chigri and those of the peripteral Ionic temples, namely, the fragmentary capital from the Heroön of Selinous, probably referable to the sixth century B. C. (*fig. 9*). Unfortunately, so little remains of this, that it is not even certain whether the volutes were vertical or horizontal; probabilities favor the assumption of the latter arrangement, but in this respect

no great weight can be attached to the restoration given by Hittorff.³⁵ The helix, though it has more numerous turns, is very similar in general character to that of the Chigri capital. The relative thickness of the member is, however, much greater, and it is especially remarkable that the roll, although not contracted as in all later balusters, has been decorated with a pattern of scales. Apart from the too numerous convolutions of the spiral, the most immature feature of the design is the excessive projection of the abacus, the edge of which is ornamented with an egg-and-dart moulding. From this it appears that the change in the position of the volutes led, at first, to an extension of the bearing. This was again reduced in

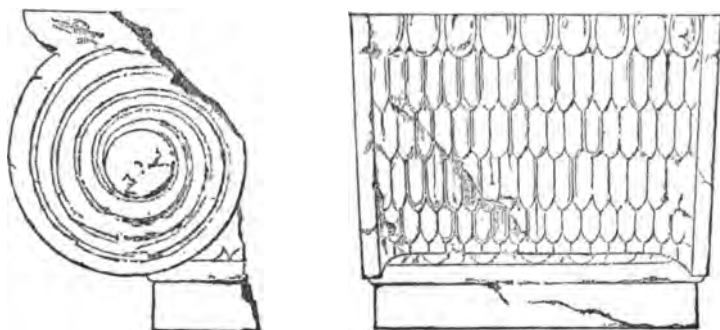


FIG. 9.—Fragment of an archaic Ionic capital from Selinous.

subsequent times, the front of the strip receiving the same carved ornaments as the side.

It is worthy of note, as an evidence of the tentative methods of this period of advance, that the Ionic capital was, as in the Heroön of Selinous, often employed together with the Doric entablature of triglyphs and metopes: the capital developed upon the tall palm-shafts of Asia thus being combined with the entablature derived from the wall-plates and beams of primitive Hellas. It is not strange that, among the few remains of this earliest period, but one

³⁵ J. I. Hittorff, *Restitution du temple d'Empédocle à Selinonte* (Paris, 1851, pl. vi.), and the work before quoted on the ancient architecture of Sicily. The illustration is taken from the latter publication.

monument of so imperfect an arrangement should have been preserved until the present day. But the number of examples furnished by the paintings of archaic Greek vases³⁶ may be taken as an indication that the forms of the volute-capital had come into general use at a period when the Ionic zophoros and dentils had not been introduced into Greek architecture, or, at least, had not been developed into a system.

The same elements that formed the capitals of the Erechtheion constituted the terminations of the weak and overladen shafts of Persepolis; the spirals and palmettos of semi-barbarous Mesopotamian decorations were employed as architectural details by the designers of Persia, as well as by those of Attica. Yet the decadence evident in the architecture of Persia is contemporary with the highest development of the Ionic style among the Greeks. No better illustration is possible of the truth, that growth, and not involution, is the principle of all progress in ancient art.

The builders of the present age have to deal with a confusion of decorative forms and constructive methods similar to that which prevailed throughout the ancient world before the rise of Greek architecture. Hence, the most direct and practical service of archæology to architecture must consist in a historical elucidation of those principles of artistic selection and evolution which were followed by the Greeks in their progress toward the incomparable perfection of Attic monuments.

JOSEPH THACHER CLARKE.

[*Conclusion in next number.*]

³⁶As, for instance, the archaic vase in the British Museum, No. 480, and that published by Inghirami, before referred to. Many others have been collected by Hittorff. It may be assumed, with great probability, that the combination of the triglyph-frieze with the Ionic capital, observable in such later structures as the tomb of Theron at Akragas, the Tomb of Absalom near Jerusalem, and several rock-cut façades in the great necropolis of Kyrene, is due to a reminiscence of the primitive employment of these features upon the same building. It will be observed that these monuments of Sicily, Syria, and Northern Africa are, although late, decidedly provincial, and hence might naturally be expected to preserve barbarous and immature traits which had wholly disappeared from the art of Greece itself.

NOTES AND INSCRIPTIONS FROM ASIA MINOR.

VII.—HADRIANOPOLIS—STRATONIKEIA.

Stratonikeia, a city on the borderland between Lydia and Mysia, or, to use the nomenclature of late Roman and Byzantine custom, between Lydia and Hellespontos, has, through a curious fate, almost disappeared from the knowledge of modern geographers. It was a place of some note: it struck coins, it has left some inscriptions. But it has been completely merged in the more important and famous Karian Stratonikeia: its coins have been attributed to the Karian city; the surname Hadrianopolis, with which Hadrian honored it on his first journey through Asia Minor, has been applied to the Karian city, which Hadrian in all probability never saw: and an inscription found at Kirkagatch in the valley of the Kaikos, on or near the actual site of the northern Stratonikeia, has exercised the ingenuity of its editor to explain how it travelled so far from Karia.¹ The inscription, Lebas and Waddington, No. 1043, is as follows:

*Ἡ βουλὴ καὶ ὁ δῆμος Ἀδριανοπολιτῶν Στρατονικέων Διδώρου Νεικάνδρου Φιλομήτορα ἐτίμησαν;*² to which the following note is added: *Stratonicée en Carie avait pris le nom d'Hadrianopolis On ne voit pas pour quel motif cette inscription a pu être placée dans un édifice public de Germé Il est possible qu'il y ait quelque erreur dans la note communiquée par Borrell.*

The correct interpretation of the inscription is, that there were two cities named Stratonikeia, one in Karia and one in Lydia. The inscription shows (1) that Stratonikeia of Lydia was at or near the modern village of Kirkagatch, (2) that this northern Stratonikeia, and not the Karian city, assumed the name Hadrianopolis, and struck coins with the legend

ΑΔΡΙΑΝΟΠΟΛΕΙΤΩΝ ΣΤΡΑΤΟΝΙΚΕΩΝ

¹ This is one of the very few cases in which later research has found a mistake in the admirable commentary from which I quote.

² "The Senate and the People of Hadrianopolis Stratonikeia honored Diodoros Philometor, son of Neikandros."

The *Notitiæ Episcopatum* mention Stratonikeia regularly as in the province of Lydia, and the lists of bishops present at the Councils of Chalkedon (451), Ephesos (431), etc., include the bishop of the Lydian city. Le Quien alone among modern writers correctly distinguishes the two cities. Hierokles appears to omit the Lydian city, but he gives it in the province of Hellespontos. Kirkagatch is near the frontier of the two provinces, and was by Hierokles included in the northern province. The name in Hierokles is very corrupt, for the great part of his list of Hellespontos is so disfigured that the names are hardly recognizable. Some *Notitiæ* mention the bishopric *Στρατονικείας ἡτοι Καλάνδου*, showing that Kalandos and Stratonikeia were neighboring towns, administered by the same bishop.³ In Hierokles the two names have been corrupted to *Σκέλευτα*, i. e., *εἰς Κάλανδα*, and *Εἰος Τράδος*, i. e., *εἰς Στρατον[ικεῖαν]*. Both are in Hellespontos.

Ptolemy and Strabo omit the Lydian Stratonikeia entirely, and the epitomizer of Stephanos Byzantios mixes up the cities in one confused note: *Στρατονίχεια πόλις Μαιονίας πλησίον Καρίας*. There is no doubt that the epitomizer has here confused the account of two cities given in the original work, and that he would have more correctly represented the original, if he had said *Στρατονίχεια, πόλις Μαιονίας· β' Καρίας πλησίον Μυλασοῦ*.

I shall not here try to show that the Lydian Stratonikeia lay on the route taken by Hadrian on his first journey through Asia Minor, and that probably he did not pass near the Karian city on either of his journeys. Even without this proof, which I shall give elsewhere, the inscription just quoted is sufficient evidence that the coins of Hadrianopolis-Stratonikeia must be classed to the Lydian city. This city also struck coins with the simple legend *Στρατονικέων*, for Mr. B. V. Head informs me that the river-god ΚΑΙΚΟΣ appears on a coin of Stratonikeia in the cabinets of the British Museum.

I may add that Germé, which M. Waddington considers to have been situated at Kirkagatch, was in all probability on the northern side of the Kaikos: the river was almost certainly the boundary between the two provinces, Lydia and Hellespontos, and Germé belonged to the northern province.

³ A good example of the custom is given by Hirschfeld, *Reisebericht*, in *BEEL. MONATSBER.* 1879, p. 315.

VIII.—A HYRGALEAN VERB.

I found the following inscription engraved on a small marble stele in the village of Khanchallar, a mile and a half north of Demirdji Keui, which is the chief town of the Tchal Ova. This part of the Tchal Ova is, as has been proved in the *Journal of Hellenic Studies* (1883, p. 386), the *Hyrgaletici campi* of Pliny (N. H., v. 29), or according to the native fashion τὸ κοινὸν τοῦ Ἵργαλέων πεδίου.⁴

ΜΕΛΤΙΝΗ ΚΑΙ
ΓΛΥΚΩΝΚΑΙΕΛΕΥΘΕΡΟΣ
ΜΕΝΑΝΔΡΩΠΑΤΡΙΓΛΥ
ΚΥΤΑΤΩΜΝΕΙΑΣΧΑΡΙΝ
ΕΙΔΕΤΙCΤΗΝCΤΗΛΗΝ
ΚΑΘΕΛΕΙΗΜΑΝΙCΕΙΕΞΕΙ
ΤΟΥCΘΕΟΥCΕΝΑΝΤΙΟΥΞ⁵

Μελτίνη καὶ Γλύκων καὶ Ἐλεύθερος Μενάνδρω πατρὶ γλυκυτότῳ μνησίας χάριν· εἰ δέ τις τὴν στήλην καθελεί ἢ μανίσει, ἔξει τοὺς θεοὺς ἐναντίους.

The only point of interest in the inscription is the verb *μανίζω*, of which I find no other example. The adjective *μανός* is not uncommon: it is said to be Attic for *ἀραιός*. The sense appears to be "make less, injure." The future *ἐλῶ* occurs in later Greek.

The inscription is probably not later than the first century after Christ; at a later date we should hardly find so many names purely Greek with no mixture of Roman.

I may add that one more mention of the very rare name Hyrgalea occurs in an inscription published by M. P. Paris in the *Bulletin de Correspond. Hellén.* 1884, p. 248. M. Paris reads Ὀργαλεύς, and refers it to a hypothetical *petite ville riveraine de l'Orgas*, a small tributary of the Maeander close to Apameia. He should have read Ὀργαλεύς, a by-form of Ἵργαλεύς.

W. M. RAMSAY.

⁴"The Federation of the Hyrgalean Plain."

⁵"Meltine and Glykon and Eleutheros (erected this stele) to their sweetest father Menander *in memoriam*; and if any one shall destroy or injure the stele, he will have the Gods against him."

LAW CODE OF THE KRETAN GORTYNA.¹

II.

TEXT.

VI.

¹ *Ας* *κ'* ὁ πατήρ δόση, τῶν τῶ π-
 ατρὸς χρημάτων πὰρ υἱέος | μὴ ὠνήθθαι μηδὲ καταθίθ-
 5 εθθαί· διτι δέ *κ'* ἀπὸς πάσητ'αι ἢ ἀπολάχη, ἀποδοθῆθω,
 αἶ κα λῆ. μηδὲ τὸν πατέρα τὰ τῶν τέκνων, διτι *κ'* αὐτοὶ πάσων-
 10 ται ἢ ἀπολάχωντι, μηδὲ τὰ τῶν γυναικῶν τὸν ἄνδρα ἀπο-
 δόθαι μηδ' ἐπισπένσαι μηδ' | υἱὸν τὰ τῶν ματρῶν. αἱ δ-
 ἐ τις πρίατο ἢ κατάθειτο ἢ ἐπισπένσατο ἄλλα δ' ἔγρατ-
 15 τα] ἢ τάδε τὰ γράμματα ἔγ[ρατται, τὰ] μ[ε]ν
 χρήματα ἐπὶ τῆ ματρὶ ἤμιν *κ'* ἐπὶ τῆ γυναικί, ὁ δ' ἀπο-
 20 δόμενος ἢ καταθὲνς ἢ ἐπισπένσανς τῶν πριαμένων
 ἢ καταθεμένων ἢ ἐπισπενσαμένων διπλῆ καταστα-
 σεῖ καὶ τί *κ'* ἄλλ' ἀτάση τὸ ἀπλόον· τῶν δὲ πρόθθα μὴ ἐν-
 25 δικον ἤμιν. αἱ δέ *κ'* ὁ ἀντίμολος ἀπομολῆ ἀνφὶ τὸ χρ-
 εος ᾧ *κ'* ἀνφισπολίωντι, μὴ ἤμιν τῶν ματ[ρ]ῶν ἢ τῶ-
 30 ς γυναικῶν, μολῶν ὅπη *κ'* ἐπιβάλλη πὰρ τῶν δε[κ]αστῶν
 ἢ **Φέκαστο** ἔγρατται. αἱ δέ *κ'* ἀποθάνη μάτηρ τέκνα καταλειπό-
 νσα, τὸν πατέρα καρτερόν ἤμιν | τῶν ματρῶν, ἀποδοθῆθαι δὲ μὴ
 35 μηδὲ καταθέμεν, αἶ κα μὴ τὰ τέκνα ἐπαινέση δρομέες ἰόντε[ς·
 α]ἱ δέ τις ἄλλα πρίατο ἢ κατάθειτο, τὰ μὲν χρήματα ἐπὶ τοῖ-
 40 ς τέκνοις ἤμιν, τῶν δὲ πριαμένων ἢ καταθεμένων τὸν ἀποδο-
 μένον ἢ τὸν καταθέντα τῶν | διπλείαν καταστῆσαι τῶν τ-
 μιῶν καὶ τί *κ'* ἄλλ' ἀτάση, τὸ ἀπλόον. αἱ δέ *κ'* ἄλλαν ὀπιύη, τὰ τ-

VI. 1. (δ) F.—23. ἀτάση F., Blass; ἀτας ἢ C., BZ., BB.—31. **Φέκαστο** F., BB.; **Φεκάστο** C., BZ., Blass.—36. ἐπαινήση C.—42. διπλείαν C.

¹ Continued from vol. I. of JOURNAL, p. 350.

TRANSLATION.

As long as a father lives, no one shall purchase any of his property from a son, or take it on mortgage; but, whatever the son himself may have acquired or obtained by inheritance, he may sell if he will: nor shall the father sell or promise the property of his children, whatever they have themselves acquired or succeeded to, nor the husband that of his wife, nor the son that of the mother. And, if any one should purchase, or take on mortgage, or accept a promise, otherwise than as written in these writings, the property shall still belong to the mother and the wife, and the one who sold or mortgaged or promised shall pay to the one who bought, or accepted the mortgage or promise, two-fold, and, if he shall have caused any other loss, he shall pay one-fold in addition; but, as regards transactions under earlier laws, there shall be no ground for action. But, if the defendant shall contend in court, in relation to the matter about which they are disputing, that it does not belong to the mother or the wife, the case shall be adjudicated as is proper before the judge, as each thing is written.

If a mother die leaving children, the father shall be trustee of the mother's property, but he shall not sell or mortgage unless the children assent, being of age; and, if any one should otherwise purchase or take on mortgage, the property shall belong to the children; and to the purchaser or mortgagee the seller or mortgagor shall pay two-fold the value, and, if he shall have caused any other loss, one-fold. But, if he wed another wife, the children shall have control of the mother's property.

*Property
Rights.*

- 45 ἐπ[α τῶ]ν [μα]τρῶϊων καρτερόν|[ς] ἤμεν. Αἱ κ' ἐδ θυ(σ)[πραξίας] φέ-
 ρ(α)[ται] ἐξ ἀλλοπολίας ὑπ' ἀν|άνκας ἐχόμενος κ' ἐλο[μ]ένω τι-
 50 ς λύσῃται ἐπὶ τῷ ἀλλυσαμέν||φ ἤμεν πρίν κ' ἀποδῶ τὸ ἐπιθά-
 λλον. αἱ δὲ κα μὴ ὁμολογίωσι| ἀμφὶ τὰν πληθύν ἢ μὴ ἐλομέ-
 ν]ω αὐτῶ λύσασθαι, τὸν δικαστῶν ὁμῶντα κρίνεν πορτὶ τὰ
 55 μ]ολόμ[ε]να]. οεκειθεροτ(?)ονΔΓ
- VII ἐπὶ τὰν ἐλευθέραν ἐλθὼν ὀπιή, | ἐλεύθερ' ἤμεν τὰ τέκνα, αἱ δὲ κ'
 ἄ ἐλευθέρα ἐπὶ τὸν δῶλον, δῶλ' ἤμ|εν τὰ τέκνα. αἱ δὲ κ' ἐς τῆς αὐτ-
 5 ᾶς ματρὸς ἐλεύθερα καὶ δῶλα | τέκνα γένηται, ἢ κ' ἀποθάνη ἄ
 μᾶτηρ, αἱ κ' ἢ χρήματα, τὸν ἐλευθέρους ἔχεν· αἱ δ' ἐλεύθεροι
 10 μὴ ἐξέειν, τὸν ἐπιβαλλόν||ταν ἀναλῆθαι. Α[ἱ] κ' ἐξ ἀγ-
 ορῆς πρ[α]μ[ε]νος δῶλον μὴ πειραιώσῃ τῶν Φεζήκοντ' ἄμ-
 ερῶν, αἱ τὰ κα πρόθ' ἀδική|κη ἢ ὕστερον, τῷ πεπαμέν-
 15 φ ἔνδικον ἤμεν. Τὰμ πα|[τ]ρω[ῶ]χο[ν] ὀπιέσθαι ἀδελφι-
 φ τῷ πατρὸς τῶν ἰόντων τῷ | πρεγ[ἱ]στφ· αἱ δὲ κα πλῆες πατ-
 20 ρωῶχοι ἴωντι κ' ἀδελφι[ο]ἰ τῷ πα|[τ]ρό[ς, τ]ῷ ἐπιπρεγίστω ὀπιέ-
 εσθαι· αἱ δὲ κα μὴ ἴωντι ἀδελφι[ο]ἰ τῷ π[α]τρὸς, υἱέεδ δὲ ἐξ ἀδελ-
 φιῶν, ὀπιέσθαι ἰφ τῷ [ἑ]ς τῷ π|ρεγίστω· αἱ δὲ κα πλῆες ἴωντ-
 25 ι πατρωῶχοι κ' υἱέες ἐξ ἀδελφιῶν, ἀλλφ ὀπιέσθαι τῷ ἐπ-
 ἰ τῷ ἐς [τ]ῷ πρεγ[ἱ]στφ. μίαν δ' | ἔχεν πατρω[ῶ]χον τὸν ἐπιθά-
 30 λοντα, πλῆαδ δὲ [μ]ή. ἄδ δὲ κ' ἀν||ωρος ἢ ὁ ἐπιθάλλων ὀπιέειν ἢ
 ἄ πατρωῶχος, [σ]τέγαν μὲν αἱ | κ' ἢ ἔχεν τὰν πατρωῶχόν, τῷ
 δ' ἐπικαρπίας παντὸς τὰν ἡμ|ίαν ἀπολανχάνεν τὸν ἐπιθ-
 35 ἄλλοντα ὀπιέειν. αἱ δὲ κ' ἀπό|δρομος ἰὼν ὁ ἐπιθάλλων ὀπι-
 εῖν, ἡβίωον ἡβίονσαν μὴ λῆ ὀπιέειν, ἐπὶ τῷ πατρωῶχφ ἡμε-
 40 ν τὰ χρήματα πάντα καὶ τὸν κ||αρπὸν πρεῖν κ' ὀπιέειν· αἱ δὲ κα
 δρομεὺς ἰὼν ὁ ἐπιθάλλων ἡ|βίονσαν λείονσαν ὀπιέ-
 εσθαι μὴ λῆ ὀπιέειν, μολῆν τῶς | καδεστᾶν τῶς τῆς πατρφ-

VI. 46-47. αἱ κ' ἐδου περ ἐξ F.; αἱ κ' ἐδ θυ(σ)[μηνία γᾶν]? περ(ᾶ)[ε
 τι](ς) ἐκς C.; ἐδ θυ[σμενίας] περ[ῶθῆ] BB.; θυ(σ)[πραξίαν](?)—52. ἢ μὴ and space
 for letter, F.; ἡμε[ν] C.; μῆσ(?)—55. οεκειθεροτ(?)ονΔΓ copy; [Αἱ δὲ κ' ὁ ἐλεύθερος]
 F.; ὁ ἐ(λ)ε(ν)θερωτ(ς) α(ι)[κ' C.; ὁ ἐκεῖθ' ἐρωτῶν α[ἱ κ'] BZ.; ὁ ἐκεῖθ' ἐροῖον ἐ BB.

VII. 9. τὸνς C.—13. ἀδικηκίη F.; ἀδικ' ἐκη ἢ ὕστερον C.; ἀδικήκη ἢ: so D., BZ.,
 BB.—20. ἐπὶ πρεγίστω C.

If any one be brought out of misfortune from sojourn abroad (where he has been) held by force, and one have released him at his desire, he shall be in the power of the one who released him until he pay what is proper; but if they do not agree upon the amount, or he did not himself request (the other) to release him, the judge shall decide according to the pleadings.

*Ransomed
prisoners.*

If a free (?) man going to a free woman shall wed her, the children shall be free; but if the free woman to a slave, the children shall be slaves; and if from the same mother free and slave children be born, if the mother die and there be property, the free children shall have it; but, if free children should not be born of her, her relatives shall succeed to the property.

Miscegenation.

If a person should purchase a slave from the market-place, and should not complete the transaction within 60 days, in case he shall have done any wrong before (the 60 days have expired) or after, there shall be ground for action against the one who has acquired him.

*Responsibility
for the acts
of a slave.*

The heiress shall marry the brother of her father, the eldest of those living; and, if there be more heiresses and brothers of the father, they shall marry the eldest in succession. But if there be no brothers of the father, but sons from his brothers, she shall marry the first one from the eldest (brother); and if there be more heiresses and sons from brothers, they shall marry the sons of the eldest in succession. The groom-elect (relative to whom she belongs by right) shall have one heiress, but not more. As long as the groom-elect is too young to marry, or the heiress, a house, if there be one, the heiress shall have, but the groom-elect shall receive half of the income of all the property. And if the groom-elect be still under 17 but above puberty, and the heiress also, but he do not wish to marry her, all the property shall belong to the heiress, and the income, until he marry her. But if he, being of age (above 17), do not wish to marry the heiress, now of proper age and willing to marry him, the relatives of the heiress shall bring the matter to trial, and

*Rights and
Obligations of
heiresses.*

- 45 ὡχω, ὁ δὲ [δ]ικα[σ]τ[άς] δικ[αζά]τω ὀπιέν ἐν τοῖ[ς] δ[υ]οῖς μη-
 νσί· αἱ δὲ κα μὴ ὀπιή, ἧ ἔγρα|ται, τὰ χρήματα πάντ' ἔχονσα-
 50 ν αἶ χ' ἧ ἄλλος, τῷ ἐπιβάλλοντ|ε, αἱ δ' ἐπιβάλλων μὴ εἶη, τῶς
 φυλᾶς τῶν αἰτιόντων ὀτιμί κα λῆ ὀπιέθαι. αἱ δὲ κα τῶ-
 ε ἐπιβάλλοντι ἡβίονσα μὴ λῆ|ε ὀπιέθαι ἢ ἄνωρος ἧ ὁ ἐπι-
 βάλ[λ]ων [κα]ῖ μ[ῆ] λῆ μέν]εν
- VIII ἁ πατρῶχος, στέγαμ μὲν | αἶ χ' ἧ ἐν πόλι τὰμ πατρῶχο-
 ν ἔχεν χ' ἄτι χ' ἐνῆ ἐν τῷ στέγ|α, τῶν δ' ἄλλων τὰν ἡμέσαν δ-
 5 ιαλαχόνσαν ἄλλῳ ὀπιέθ|αι τῶς φυλᾶς τῶν αἰτιόντων
 ὀτιμί κα λῆ· ἀποδατῆθαι δ|ὲ τῶν χρημάτων ἰῶ. αἱ δὲ μὴ
 10 εἶεν ἐπιβάλλοντες ταῖ (παι) π||ατρῶχῶ ἀ[ε] ἔ|γρατται, τὰ χρ-
 ῆματα πάντ' ἔχ[ον]σαν τῶς φυλᾶς ὀπιέθ[α]ε ὀτιμί κα λῆ.
 αἱ δὲ τῶς φυλ[ᾶ]ς μῆτις λείοι δ[π]υίεν, τῶς καδεστάνς
 15 τῶς τῶς πατρῶ[ώ]χῳ Fe[ε](π)αι χ|ατά [τὰν φυλ]άν, ὅτι οὐ (λ)[ῆ] ὀπ-
 ἰέν τις; καὶ μὲν τίς [χ' ὀ]πιή, εἶν ταῖς τριάκοντα, ἢ κα Feίπων-
 20 τι· αἱ δὲ μ(ῆ), ἄλλῳ ὀπιέθαι ὀτι||μί κα νύναται. αἱ δὲ κα πατρὸ-
 ς δόντος ἢ ἀδελφῶ πατρῶ|χος γένηται, αἱ λείοντος ὀπ-
 υίεν ῶ ἔδωκαν, μὴ λείοι ὀπιέθαι, αἶ χ' ἐστετέκνωται, δια-
 25 λαχόνσαν τῶν χρημάτων ἧ ἔ|γρατται, [ἄλλ]ῳ ὀπιέ[θαι τᾶ]ς φ-
 υ[λ]ᾶ[ς]· αἱ δὲ τέκνα μὴ εἶη, πάντ' | ἔ[χ]ου[σ]αν τῷ ἐπιβάλλον[τ]ε ὀπ-
 30 ἰέθαι αἶ χ' ἧ, αἱ δὲ μῆ, ἧ ἔγραττ|αι. ἀνήρ αἱ ἀποθάνοι πατρῶ-
 ῶχῳ τέκνα καταλέπων, αἶ κα [λ]ῆ| ὀπιέθω τῶς φυλᾶς ὀτιμί κα ν-
 ύναται, ἀνάγκη δὲ μῆ· αἱ δὲ τέ|κνα μὴ καταλείποι ὁ ἀποθανών,
 35 ὀπιέθαι τῷ ἐπιβάλλοντι ἧ|ε ἔγρατται. αἱ δ' ὁ ἐπιβάλλων τ-
 ἀν πατρῶχον ὀπιέν μὴ ἐπ|ίδαμος εἶη, ἁ δὲ πατρῶχος
 40 ὠρίμα εἶη, τῷ ἐπιβάλλοντι ὀ||πιέθαι ἧ ἔγρατται. πατρῶ-
 χον δ' ἡμεν, αἶ κα πατῆρ μὴ ἧ ἢ ἀ|δελφίδος ἐς τῷ ἀ[υ]τῶ πατρός, τῶν
 δὲ χρημάτ[ων κα]ρτερὸνς ἡμεν τ[ᾶ]ς Feρ[γ]α[σ]ία[ς] τῶς] πατρῶανς '

VII. 45. δικαδότη C.—51. ὀτιμί: so C.; ὀτιμί F.—55. ὀπιέν [ῆ? F.; [ὀπ]ό(κα) [ἐτ' ἡβησ]εν C.; μέν]εν BZ., BB.

VIII. 4. ἡμί(ν)αν C.—9. π(αι)ατρ. F.; τᾶι πατρῶώκω C.—15-16. ε . . . αι κατα ανοτω ὀπιέν F.; text C.—17. τις? [ὀ]πιή F.; τίς [κ' ὀ]πιή C.—20, 32. νύναται F., BZ., BB.; κ' ἀνάναται C.—21. δόντος F.; δόντος C., BZ., BB.—38. ἐπιδάμωσειε C.—41. ἁ C.—ῆ: so C.; εἶη F.

the judge shall order him to marry her within two months; and, if he do not marry as is written, she with all the property shall wed the next in the succession, if there be another; but, if there be none, she may marry any one she wishes, of the tribe, that may demand her hand.

And if she, being of age to marry, do not wish to marry the groom-elect, or the groom-elect be too young and the heiress do not wish to wait, a house, if there be one in the city, the heiress shall have, and whatever there is in the house, but, sharing half of the remaining property, she may marry another, whomsoever she wish of her tribe demanding her hand; and they shall portion off (the half) of the property to the first one.

If the heiress should have no kinsmen within the limits prescribed, holding all the property she may marry any one of the tribe she wishes. But, if no one of the tribe desire to marry her, the relatives of the heiress shall proclaim throughout the tribe "Does no one wish to marry her?" and, if any one will marry her, (it shall be) within the 30 days, as they shall have declared; and, if not, she shall wed another, whomsoever she may be able to.

If she become an heiress after her father or brother shall have given her in marriage, in case she do not wish to marry the one to whom they gave her, though he be willing, if she have borne children, sharing (with him) the property as is written, she shall wed another of the tribe; but, if she have no children, with all the property she shall marry the groom-elect if there be one, but, if not, as is written.

In case a husband should die leaving children to an heiress, if she wish, let her wed any one of the tribe she may be able to, but it is not compulsory. If the deceased should leave no children, she shall marry the groom-elect as is written. If the one to whom it falls to marry the heiress should not be in the country, and the heiress be of age to marry, she shall wed the (next) in succession as is written. She shall be an heiress if she have no father, or brother from the same father, and the father's relatives shall have control of the work-

45 καὶ τῆς ἐπικαρπίας δε[αλ]α[νχά]ν|εν [τ]ὰν ἡμίαναν, ἄς κ' [ἀνωρο]ς ἱ.
αὶ δ' ἀν[ώ]ρω ἰάττη μὴ εἶη ἐπιβόλων, τὰν πατρῶχον καρ-
50 τεράν ἡ[μ]εν τῶν τε χρημάτων κ|αὶ τῶ καρπῶ, κἄς κ' ἀν[ω]ροσ ἱ. :-
ρόφειαι [πᾶ]ρ τῆ ματρί. αὶ δὲ μ|άτηρ μὴ [εἶη, πᾶρ τ](ο)ἶ[ς μ]άτρωσ.
τράφειθ[αι]. αὶ δὲ τις ὀπυίοι τὰ|ν πατρῶχον ἄλλα δ' [ἐγ]ρατται

IX τὸν ἐπιβα[λλόνταν, αἶ κ' | ἀποθανών τις πα]τρῶχον κα-
ταλίπη, ἢ αὐ[τὸν] τὰ χρήματα | ἀρτύεν ἢ πᾶρ τὸ]ν ματρώων-
5 ς-καταθέμεν· [αὶ δ' ἄλλω ἀπόδοιντο | ἢ καταθεῖεν, μὴ] δικάϊαν ἡμεν :-
ἀν ὄναν καὶ τὰν κα[τάθεσιν· αὶ δ' | ἄλλοσ πρί]αυτὸ τις χρήματα ἢ
10 κατάθετο τῶν τῆσ πα[τρῶχω, τ]|ἰά [μ]έν [χρή]ματα ἐπὶ τῆ πατρῶχ-
φ ἡμεν, ὁ δ' ἀποδόμενοσ ἢ κατ|αθένσ τῶ πριαμένω ἢ καταθε-
μίνω, αἶ κα νικαθῆ, διπλῆ κα|ταστασεῖ, καὶ τί κ' ἄλλ' ἀτάση τ-
15 ὁ ἀπλόον ἐπικαταστασεῖ, ἀ|ε [τά]δε τὰ γ[ράμ]ματ[α] ἐγρατται· τ-
ῶ[ν δ]ὲ πρόθα [μὴ ἐν]δικον ἡμεν. | αὶ δ' ὁ ἀντίμολοσ ἀπομ[ολ]ί-
20 ε ἀ[ν]φ[ι]εὶ τὸ χρέοσ, φ' κ' ἀνφιμολί|ωντι, μὴ τῆσ πατρῶχω [ἡ]μεν,
ὁ δ[ικ]αστᾶσ ὀμνὺσ κρινέτω· αὶ | δὲ νικάσαι, μὴ τῆσ πατρ[φ]ώχ-
ω ἡ[μ]εν, μολῆν δη κ' ἐπιβάλλη ἢ | Φέκαστο ἐγρατται. Αἶ ἀ[ν]φ[ι]ε-
25 ἀ[μ]ενοσ ἢ νενικαμένο[ς ἢ ἐνκ]ιωτᾶνσ ὀφέλω[ν] ἢ διαβαλό[μ]ε-
νοσ ἢ διαφεπάμενοσ ἀπο[θ]ά|νοι, ἢ τούτφ ἄλλοσ, ἐπιμολ-
30 ισά(τ)ω πρὸ τῶ ἐνιαυτῶ, ὁ δὲ δικα||στᾶσ δικαδδέτω πορτί τὰ [δ]ποφ-
ωνιόμενα, αὶ μέν κα νίκασ ἐπ[ι]μολῆ, ὁ δικαστᾶσ κ' ὁ μνάμων
αἶ κα δῶη καὶ πολιατεύη, οἱ δὲ μ|αίτυρεσ οἱ ἐπιβάλλοντεσ· ἀνδοχ-

VIII. 45. τ](ᾶς) [δ' ἐπικαρπ]ίας C.—52. μὴ [ἦ παρ] τῶ[ι]ς μ]ατρῶσι C.; [εἰη ἐ]πι
μάτρωσι F.—55. ἰέ[θ]ω ἐ[ναν]τι κόσ[μ]ω C.

VIII. 55.—IX. 1-8. (?) ιε ??? . . . τι κοσ ? || τὸνσ ἐπιβα[λλόντανσ] ἔκεν τὰ κ|ρε
ματα . αὶ κα πα|τρῶχον κα|ταλίπη, ἔ αὐ[τοὶ κρέματ'] ἔκοντι, | τὸσ πατρῶσ καὶ τὸ]νσ ματρώωνσ
καταθέμεν [καὶ ἀποδόθαι τὸν || F ὄν αὐτὸν καὶ] δικάϊαν ἔμεν τ|ὰν ὄναν καὶ τὰν κα[τάθεσιν].
ἀλλα δ' αὶ πρί]αυτο BB.

IX. 1-2. ἐπιβα[λλόντανσ, αὶ κα πατήρ ἢ ἀδελπίδσ πα]τρῶχον C.—3-4. αὶ[τῶν μὴ
ἰόντων, τὸνσ πατρῶσ καὶ τὸ]νσ C.—5-6. [ἢ ἀποδόθαι τὰ κρήματ'] αὶ κ' ἦ καὶ] C.—7-8.
κα[τάθεσιν. αὶ δ' ἄλλαι πρί]αυτο C.—14. ἄτασ ἦι C.—17. το[ιδὸ] δ' C.—24. Φέκαστω C.—
25. νενικαμένο[ς] οἰότανσ F.; [ς τις] C.; [ἢ ἐνκ]ιωτᾶνσ Blass, BB.—ὀπέλων BB,
Blass.—28-29. ἐπιμολίσαι (τ)ῶ πρώτω F.; ἐπιμολ(έν) αἶ ὁ πρώτω C.; ἐπιμολησάτω πρὸ
τῶ Blass, BB.—32. ἐπιμολῆ ὁ δικαστᾶσ C.—34-35. ἀνδοχᾶ(δ) δ' ἔκεν κῖοιτᾶν F.; ἀνδοκα
δ' ἔκεν κ' οἰσᾶν, καὶ διὰ βωλᾶσ C.; text Blass, BB.

ing of the property, and share half the proceeds, as long as she is unmarried. In case there be no groom-elect while she is unmarried, the heiress shall have possession of the property and the income, and as long as she is unmarried she shall be brought up by her mother; but, if she have no mother, she shall be brought up among her mother's relatives. And if any one should marry an heiress, while it is written otherwise . . .

If any one dying leave an heiress, the kinsmen shall either themselves manage the property or mortgage it among the mother's relatives; and, if they should sell or mortgage it to any other, the sale and mortgage shall not be legal; and, if anyone else should purchase the property or take a mortgage (on any part) of that of the heiress, the property shall belong to the heiress, and the seller or mortgagor to the buyer or mortgagee, if he be convicted, shall pay double, and if he have done any further harm, he shall pay an equivalent besides, as these writings are written; but, in case of previous transactions, there shall not be ground for action. But, if the defendant should contend, in relation to the thing about which they are disputing, that it does not belong to the heiress, let the judge under oath decide; and, if he should gain his case, to the effect that it does not belong to the heiress, suit (for ownership) shall be tried, as is proper, according as each thing is written.

If a person should die who has become a surety, or lost a suit, or owes a loan, or has defrauded any one, or has entered into an agreement, or another (hold like relations) towards him, the case shall be reviewed before the close of the year, and the judge shall decide according to the testimony; if indeed the case be renewed in relation to a judgment (against the deceased), the judge and the clerk of the court, if he be alive and a citizen, and the witnesses who are

*Actions in
some special
cases.*

35 α(δ) δὲ κ' ἐνοικωτῶν καὶ διαβολῶς καὶ δερῆσιος, μαίτιρες οἱ ἐπιθ-
 άλλοντες ἀποφωνόντων. ἡ δὲ κ' ἀποφείποντι, δικαδδέτω ὁμό-
 40 σας τὰ αὐτῶν καὶ τὸν ματῦραν ναῆν τὸ ἀπλόον. Ἰῦς α-
 ἴ κ' ἀνδέξῃται ἄς κ' ὁ πατῆ(δ) δῶν, | αὐτὸν ἀλῆθαι καὶ τὰ χρήματα
 ἀτι κα πέπαται. Αἴ τίς κα πέραει συνπλ(ε)[ίχ]ση ἢ ἐς πέρ[αν] ἐπι-
 45 θέντι μὴ ἀποδιδῶ, αἰ μὲν κ' ἀποφωνίοντι μαίτιρες ἡθίοντ-
 ες, τῶ ἑκατονστατήρῳ καὶ πλίονος τρέες, τῶ μείονος μέττ' ἐ-
 50 ς τὸ δεκαστάτηρον δ[ύ]ο, τῶ μεῖλλονος εἶνα, δικαδδέτω πορ[τ]ι τὰ
 ἀποφω[ν]όμενα· αἰ δὲ μαί[τ]υρει[ς] μὴ [ἀπ]οφ[ων]ίοντι, ἢ κ' ἐ[λ]θη ὁ σ-
 ναλλάξ[α]ν[ς], ὄτερόν κα ἔλη[τα]ι ὁ | μενφό[μ]ενος ἢ ἀπομόσαι ἢ συν-

X

11 χρεος - - - - - [ἀ]ποδόν-
 τανς το - - - - - Ματρι
 15 δ' υἱ[ν] ἢ ἀνδρα γυναικὶ δόμεν ἐ]κατὸν στατήρα[ν]ς ἢ μ]εῖον, π-
 λιον δὲ μῆ· αἰ δὲ πλῖα δοίη, αἴ | κα λείωντ' οἱ ἐπιθάλλοντες τ-
 20 ὄν ἀργυρον ἀποδόντες τὰ χρ[ῆ]ματ' ἐχόντων. Αἰ δὲ τις ὀφέ-
 λων ἀργυρον ἢ ἀταμένος ἢ μολοιόμενας δίχας δοίη, αἰ
 μῆ εἴη τὰ λοιπὰ ἄξια τῶς ἀτας, μηδὲν ἐς χρεός ἦμεν τὰν
 25 δόσιν. *Αντρω[π]ον μὴ ὠνῆθα[ι] κατακείμενον, πρὶν κ' ἀλλύσ-
 ηται ὁ καταθένς, μηδ' ἀμφίμολον, μηδὲ δέξασθαι μηδ' ἐπισ-
 30 πένσασθαι μηδὲ καταθέσθαι· αἰ || δὲ τις τούτων τι φέρξαι, μηδ-
 ἐν ἐς χρεός ἦμεν, αἰ ἀποφωνίοντι δύο μαίτιρε[ς].
 *Ανφανσιν ἦμεν ὅπω κά τιλ | λῆ. ἀμφαίνεθαι δὲ κατ' ἀγορᾶν
 35 καταφελμένων τῶμ πολιταῶν ἀπὸ τῶ λάω ὧ ἀπαγορεύοντι.
 ὁ δ' ἀμφανόμενος δότω τῶ ἐταιρεία τῶ φᾶ αὐτῶ λαρε-

IX. 37. ἡ: so C.; ἡ F., BZ., BB.—38. ὁμόσαντα αὐτὸν BZ., Blass.—42. (ἀγ)έθαι C., BZ., BB.; ἀγῆθαι Blass.—43—44. περα ἐπιθέντι F.; πήραι συν[ναλλάκ]ση ἢ ἐς πῆρ(αν) ἐπιθέντι C.; συν[ναλ]λ[άκ]η[ν]τι ἐ ἐς π[έ]ρ[α]ς BZ.; συνπλη[ρῶ]ση ἢ ἐς πέρ[αι] Blass; συνα(λ)λ[άκ]η[ν]τι ἐ ἐς πέρ[α]ς BB.—48. μήττες C.—49. τὸ δ) F.; τὸ C.—50. με-
 ἰονο(δ) (δ' ε)ν(ς) C.—52—53. ἐ[λ]θη ὁ συναλλάξ[α]ν[ς]. στερρον [ἀν ?]ελέ[θαι] F.; ἐ[λ]θη ὁ
 συναλλάξ[α]ν[ς] ὄτερον (μ)ῆ λῆι, (ἀ) C.; text, Blass.

X. 10—14. BB. insert the fragment found by Halbherr: [στατῆρῶ]ν || κρεός. [τὸς
 δ' ἐπ]ειβα[λλόν]τανς, | αἰ ὁ ἀνὲρ π[λ]ῖα δ[οί]η, ἀ]ποδόν[τ]ανς τὸ [ἀργύ]ρον [ἔ]κεν τὰ κ[ρ]έματ[α],
 αἰ κ]α λῆι[όν]τι.—14—15. πᾶρ] ματρι δ' υἱ[ν] (ς) [αἰ κα λῆι, καταθέμεν] C.—21. ἀτάμενος, F.,
 C.; ἀτάμενος BZ., BB., Blass; -ἐμωλιόμενος C.—26. κατῆνηται F.; κ' ἀρτί(σ)ηται C.;
 text BB.—33. ὀπόκα C.—36. λαῶ ὁ ἀπαγορεύοντι C.—39. λαρείων καὶ προκῶν C.

heirs (shall testify); while in a case of surety, and loans, and fraud, and agreement, the heirs shall testify as witnesses; but, if they refuse, let the judge under oath pass upon their case and declare that (their opponents) have judgment against the witnesses in the amount in question. If a son should become surety while his father is living, he shall be held, himself and the property which he owns.

If any one have a dispute about a venture at sea, or do not reimburse one who has contributed to a venture, should witnesses of age testify,—3 in a case of 100 staters or more, 2 in a case of less down to 10 staters, 1 for still less,—let the judge decide according to the testimony; but, if witnesses do not depose, in case the contracting party comes, whichever of the two courses the complainant may choose, either to make oath of denial, or . . .

A son may give to a mother or a husband to a wife 100 staters or less, but not more; if he should give more, his heirs shall have the property, (only) paying the money if they wish.

*Legality of
Gifts.*

If any one owing money, or under obligation for damages, or during the progress of a suit, should give away anything, unless the rest of his property be equal to the obligation, the gift shall be null and void.

One shall not buy a man while mortgaged until the mortgagor release him, nor one in dispute, nor accept him (as a gift), nor accept a promise or mortgage upon him; and, if one should do any one of these things, it shall be void if 2 witnesses should testify.

Adoption may take place whence one will; and the declaration shall be made in the market-place, when the citizens are gathered, from the stone from which proclamations are made. And let the adopter give to his *hetaireia* a victim and a *prochoös*

Adoption.

- 40 Ἴον καὶ πρόχοον Φοίνω. καὶ || μὲν κ' ἀνέλγται πάντα τὰ χρή-
ματα καὶ μὴ συννῆ γνήσια τέκνα, τέλλεμ μὲν τὰ θῖνα καὶ
τὰ ἀνθρώπινα τὰ τῶ ἀφαναμέ|νω κ' ἀναλιῖθαι ἄπερ τοῖς γ-
45 νησίοις ἐγ[ρ]ατται· αἱ [δ]έ κ[α μ]ῆ | λῆ τέλλεν ἄ ἐγρατται, τὰ χ[ρ]ῆ-
ματα τὸν ἐπιβαλλόνταν ἐχε|ν. αἱ δέ κ' ἦ γνήσ[ε]α τέκνα τῶ ἀν-
50 φαναμένω πεδὰ μὲν τῶν ἐρσ||ένων τὸν ἀμφαντὸν ἄπερ αἱ θ-
ῆ[λε]ια ἀπὸ τῶν ἀδελφιῶν λαυχά|νοντι. αἱ δέ κ' ἐρσενες μὴ ἴων-
τι, θήλειαι δέ, [F]ισΦόμοιρον ἦ-
XI μεν τ|ὸν ἀμφαντὸν καὶ μὴ ἐ|πάνανκον ἦμεν τέλλεν τ[ὰ τ-
ῶ ἀν]φαναμένω καὶ τὰ χρήμα|τ' ἀναλιῖθαι, ἄτι κα κατα[λίπ-
5 η ὁ ἀν]φανάμενος, πλίι δέ τὸν | ἀμφαντὸμ μὴ ἐπιχωρῶν. [αἱ δ'
ἀπο]θάνοι ὁ ἀμφαντὸς γνήσια | τέκνα μὴ καταλεπών, πὰρ τὸ[ν]ς τ-
10 ῶ ἀν]φαναμένω ἐπιβαλλόνταν||ς ἀνωρῶν τὰ χρήματα. αἱ δ[έ] κα
·λῆ?], ὁ ἀφανάμενος ἀποΦεπ[άθθω κατ' ἀγορὰν ἀπὸ τῶ λά[ω, ὦ
ἀπα]γορεύοντι, καταΦελμέν|ων τῶν πολιατῶν. ἀνθέμε[ν δέ
15 δέκα σ]γατήρανς ἐδ δικαστῆ|ριον, ὁ δέ μνάμων π[ρ]ὸ ξεν-
ίω ἀποδότω τῶ ἀπορρηθέντι. | γυνὰ δέ μὴ ἀμφανέθθω μῆδ'
20 ἀνηθος. χρῆθαι δέ τοῖδδε ἄ||ι τάδε τὰ γράμματα ἐγραφε,
τῶν δέ πρόθθα ὄπα τις ἐχῆ ἢ ἀ|μφαντυῖ ἢ πὰρ ἀμφαντῶ μὴ ἐτ' ἐ-
νδικον ἦμεν. | Ἄνθρωπον ὅς κ' ἀγῆ πρὸ δίκας,
25 αἰεὶ ἐπιδέχεθαι. | Τὸν δικαστάν, ὅτι μὲν κατὰ
ματύρανς ἐγρατται δικάδδ|εν ἢ ἀπώμοτον, δικάδδεν ἄ ἐ-
30 γρατται, τῶν δ' ἄλλων ὀμύνυτ||α κρίνεν πορτὶ τὰ μοκόμεν-
α. Αἱ κ' ἀποθάνη ἀργυρον | ὀφέλων ἢ νευκαμένως, αἱ μέ-
ν κα λείωντι οἷς κ' ἐπιβάλλη | ἀναλιῖθαι τὰ χρήματα, τὰν ἀ-
35 ταν ὑπερκαιστώμεν καὶ τὸ | ἀργύριον οἷς κ' ὀφέλη, ἐχόντ-
ων τὰ χρήματα· αἱ δέ κα μὴ λείωντι, τὰ μὲν χρήματα ἐπὶ τοῖ-
40 ς νικάσανσι ἦμεν ἢ οἷς κ' ὀ|φέλη τὸ ἀργύριον, ἄλλαν δέ
μῆδεμίαν ἄταν ἦμεν τοῖς ἐπιβάλλονσι. ἀ[λ]ῆθαι δέ ὀ-

X. 50. ἀπερ F.; ἀπερ C.—53. ἐχεν F.; ἦ[μεν τ]ὸν C.

XI. 4. ἀναλι(ῆ)θαι C.—πλίι F.; πλίι C.—6. [αἱ δέ κ'] F.; [αἱ κ'] C.—10. αἱ δ[έ μὴ λῆ] ὁ C.—12. λα[ῶ ὁ] C.—14—15. ἀνθέμ[εν σ]γατήρανς C.; ἀναθέμε[ν δέ σ]γατήρανς F.—16. ὁ τῶ κσενίω C.—22. ἀμφαντυῖ F.—24. κα λῆ C.—25. αἱ ἦ, F.; αἰεὶ: 80 C.—42. ἀ[λ]ῆθαι F.; ἀ[γ]έθαι C.

of wine. And if he (the adopted) receive all the property and there be no legitimate children, he shall fulfil all the divine and human obligations of his adoptive father, and receive as is written for legitimate children; but, if he be not willing to do as is written, the kinsmen shall have the property. If there be legitimate children of the adoptive father, the adopted son shall receive with the males just as the females receive from the brothers. But, if there be no males, but females, the adopted son shall have an equal share, and it shall not be compulsory upon him to pay the obligations of the adopter and accept the property which the adopter leaves, for the adopted shall succeed to no more (than an equal share with the daughters). If the adopted son should die without leaving legitimate children, the property shall return to the heirs of the adopter. If he wish, the adopter may renounce him in the market-place, from the stone from which proclamations are made, when the citizens are gathered. And he shall deposit ten (?) staters with the court, and the clerk of the court shall pay it to the person renounced as a parting gift of hospitality. A woman shall not adopt, nor a person under puberty. These things shall (now) be transacted as (the law-giver) has written these writings, but in previous cases, however one hold (property), whether by adoption or from an adopted son, it shall still not be void.

If one take action by seizure against a man before trial, (the defendant) shall always receive him under his surety. *Supplemental provisions.*

Whatever is written for the judge to decide according to witnesses or by oath of denial, he shall decide as is written, but touching other matters he shall decide under oath according to the pleadings.

If a person die owing money or having a judgment against him, if those to whom it belongs to receive the property desire, they can pay the damages in behalf of the deceased, and the money to whom it is owing, and then have the property; but, if they do not wish to do so, the property shall belong to those who have won the suit or to those to whom the money is owing, and there shall be no other

πὲρ μ[ε]ν τῷ [πα]τρὸς τὰ πατρώϊα, ὑπὲ(δ) δὲ τῶν ματρὸς τὰ μα-
 45 τρώϊα. | Γυνὰ ἀνδρὸς δ κα κρίνηται,
 ὁ δικαστὰς ὄρκον αἴ κα δικάσῃ, ἐν ταῖς **Ἑκατι** ἀμέραις ἀ-
 50 πομοσάτω παρίοντος τῷ δικαστῆ· ὅτι κ' ἐπιχαλῆ προ**F**[ε]πάτ-
 ω [ὁ κατ?]ἀρχων τῷ(δ) δίκας τῆ γυναῖκι καὶ τῷ δικαστῆ καὶ [τ]ῷ
 [μνᾶμ]ονι προτέταρτον ἀντὶ μ-

XII

[ατύρων] - - - - -
 15 **Ματρὶ** υἱὸς ἢ ἀ[ν]ήρ γυναῖκι | **χρήματα** αἰ ἔδωκε ἢ ἔγρατ-
 το πρὸ τῶνδε τῶν γραμμάτων | **μὴ** ἐνδικὸν ἤμεν, τὸ δ' ὕστε-
 20 ρον δίδομεν ἢ ἔγρατται. || Ταῖς πατριώχοις αἴ κα μὴ
 ἴωντι ὄρφανοδικαστῆ δ[ς] κ' ἀνωροὶ ἴωντι, **χρῆθαι** κατὰ
 τὰ ἐγραμμένα. **δη** δὲ κα | πατρ[φ]ῶχος, **μὴ** ἰόντος ἐπι-
 25 θάλλοντος **μηδ'** ὄρφανοδικαστῶν, **πάρ** τῆ **ματρὶ** τράφη-
 ται, τὸν **πάτρω** καὶ τὸν **μάτρω** τὸν ἐγραμμένον τ-
 30 **ὰ** **χρήματα** καὶ τὰν ἐπικαρπίαν ἀρτύν **δπα** κ' ἀνῶνται κά-
 λιστα πρὶν κ' ὀπιήται. ὀπιέθαι δὲ **δυωδεκα** **ἑτεία** ἢ **πρεί-**
γωνα.

XI. 47. ὄρκων C.—48. δικάσῃ ἐν τ. F. ἀμέραις, C.—49. δικαστῆ, C.—51. [τὸν δ'] ὄρκοντα δίκας C.; [τὸ ἐπ]ᾶρκον BZ.; [δ' ὁ ἐπ]ᾶρκων BB.—53. προτέταρτον: so C.; πρὸ τετάρτων F.

XII. 15. υἱὸς C.—23. δη: so C.; δη[ε] F.—30. κα (νύ)νανται F., BZ., BB.; κ' ἀναντῆ C.

COMMENT.

COLUMN VI. 13. **πρίατο** ἢ **κατάθειτο**: **πριάμενοι** καὶ **θέμενοι**, Is. 5, 21; Dem. 1249; Ditt. S. I. G. 63, 40.

14. **ἄλλα** . . . **ἔγρατται**: A clumsy expression indeed (cf. viii, 54; Cauer, 119, 42).

33. At Athens the property, whether of mother or father deceased, fell to the sons as soon as they became of age; until that time it was administered by their guardians. Here the father, if living, still retains control of it after they are above 17, unless a stepmother is brought into the family (vi, 45), in which case Charondas also put a stigma upon the father (Diod. xii, 14).

46—47. **δυσπραξίας**: τὴν τούτου **συμφέραν** . . . **συναχθεσθεὶς** ἐπὶ τῇ **ἀτυχίᾳ** τῆ **τούτου**, of Nikestratos ransomed from slavery by Apollodoros, Dem. 1248.

loss to the heirs-at-law. The property of the father may be seized in behalf of the father, as also the mother's in behalf of the mother.

If a wife be separated from her husband, in case the judge decide upon an oath, let her take the oath of denial within 20 days in the presence of the judge: whatever he charges let the beginner of the suit announce to the woman and the judge and the clerk of the court, 4 days before in the presence of witnesses . . .

If a son have given property to his mother, or a husband to his wife, as was written before these writings, it shall not be illegal; but, hereafter, gifts shall be made as here written.

If heiresses have no *orphanodikastai* while they are unmarried, they shall be treated as written. And where, in default of a groom-elect or *orphanodikastai*, an heiress is brought up by the mother, the father's and mother's relatives that have been described shall manage the property and the income as they can best increase them until she marry. And she shall marry at 12 years or older.

The Athenian law was, τοῦ λυσαμένου ἐκ τῶν πολεμίων εἶναι τὸν λυθέντα, ἐὰν μὴ ἀποδιδῶ τὰ λύτρα, Dem. 1250. I feel no confidence that the correct reading has yet been recovered here.—ἀλλοπολλας: cf. ἀλλοθημία [so C.]—ὅπ' ἀνάγκας ἐχόμενος: ὅπ' ἀνάγκης ἢ ὑπὸ δεσμοῦ καταληφθεὶς = ὑπὸ ἀνάγκης τινὸς καταληφθέντα, Dem. 1133, 14–16; Od. δ 557.—ἐλομένω: cf. Suidas, Φαίδων· ἐντυγῶν δὲ Σωκράτει ἠράσθη τῶν λόγων αὐτοῦ καὶ αἰτεῖ λύσασθαι.

52. τὰν πληθὸν: τὸ πλῆθος τοῦ ἀργυρίου, Cauer, 121, C. 36.

55. The reading here, as given by the copy, is so strange that it is impossible to determine what is meant. Attention is drawn by BZ. to the contrast between the groom's "going" to the free woman (vii, 1), and the free woman to the slave, as implying a difference of condition dependent on the house maintained or accepted by the free woman; and the Roman law, and examples from the "Syr.-Rom. Rechtsbuch," are cited to show a somewhat similar regulation elsewhere.

COLUMN VII. 3. Cf. ἡ γυνή πρὶν ὡς Ἐφοβὸν ἐλθεῖν, of marriage, Dem. 873.

9. ἐξεῖεν: Hm. v, 130: ἐξῆν· ἐξεγέροντο, Hesych.

12. περαιώσῃ: περαιωθῆναι· τελειωθῆναι, Hesych. Plato, Legg. 849. E. discountenances all credits, like the Thurians, Stob. II. Nom. 22. Cf. Plato, Legg. 936 D. E. [Non lasci passare, C.; ne l'a pas vendu, D.; nicht Ziel setzen lässt, BZ.; ins Ausland verkauft, Blass, BB.]

16. The law was the same at Athens (though sometimes violated, Is. 10, 5). The obligation to marry, however, did not cease with the father's brothers and sons, but was determined simply by the laws of consanguinity, Is. 1, 39, 3, 64, 10, 5; Plato, Legg. 924. If the heiress was poor, the next of kin could refuse to marry her, but was bound to give her a marriage-portion corresponding to his own fortune. "Regulations concerning heiresses were an object of chief importance in the ancient legislations, on account of their anxiety for the maintenance of families, as in that of Androdamos of Rhegium (Arist. Pol. ii. 12, 14), and in the code of Solon (Plut. Sol. 20), with which the Chalcidean laws of Charondas appear to have agreed in all essential points (Diod. xii, 18)." (Müller, Dorians, iii, 10, 4; Eng. ed.). Likewise the Spartan and many others, Aryan and non-Aryan. In the event of several heiresses, the Athenian law gave each an equal share in the property, as our code does, and they were severally married to relatives, the nearest having the first choice (Smith, *Dict. Antiq.*, "Epiclerus"). But, if the heiresses were poor (θῆτες), only one need be wedded or portioned (Dem. 1068).

23. ἰψ̄: Used by Hm. in a series, like πρῶτος; π 173, § 435-6; BB.

27. μίαν: This seems added in consequence of the inadequate and clumsy expression of the preceding clause. [A second heiress cannot be married by the same person, if the first one has died. C.]

30. ὁ ἐπιβάλλων οὐκ οἶεν: For this technical expression Herodotos (vi, 57), speaking of Sparta, uses ἐς τὸν ἰκνέται ἔχειν; Pollux (3, 33), ὁ ταύτη προσήκων, and Andokides (Myst. 117), of the heiresses, ἀ ἐγίγοντο εἰς τε ἐμὲ καὶ Λέαγρον: cf. εἶτε κατὰ δύσιν αὐτῶ προσῆκεν εἶτε κατὰ γένος, Dem. 1136.

35-50. The minimum marriageable age (ἡβίονσα) for the heiress is 12 (xii, 32), for the groom-elect probably 14 or 15 (ἡβίων), from which time till 17 he was called ἀπόδρομος. During this period he was expected to marry, and if he refused he was deprived of his share of the income of the heiress's estate. But on coming of age (17, δρομεύς), if he still refused, while she was willing, he was summoned before the judge (as the archon at Athens, Dem. 1068) by the heiress's relations and ordered to marry her within two months, at the peril of forfeiting all right to her property. From Strabo, 482, it would seem that such early marriages were necessary only in the heiress-relationship; for he says that, after their release from the ἀγέλαι, the young men were required to marry; and this age is calcu-

lated at 27 or 28 (Schoemann, *Ant.* p. 306). An early age, however, is indicated by Strabo for the bride, by his statement that she was not taken to the home of the groom until she was competent to manage a household. The bride of the Athenian Ischomachos was not yet 15 (Xen. Oik. vii, 5; cf. Dem. 814, 857); and from Demosthenes (1009) we have the case of a youth married at 18.

40. *πρὲν*: Though elsewhere *πρὶν*: this is to be compared with *πρετ-γυς*, *πρείγωνα* (xii, 32); cf. Curt. Et. 472.

51. *φυλᾶς*: "The civic body which bore rule in the states of Crete was without doubt, here as elsewhere, split up into tribes and subdivisions of tribes; but on this we have no particular information, except that we find the Dorian tribal name Hylleis mentioned in Cydonia (Hesych.)" (Schoemann, p. 300). To this scanty evidence should be added the word *ἐμφύλοι* (Cauer, 119, 15), which is supplemented by this code (viii, 6, 11, 13, 26, 32). [Halbherr's collection of inscriptions shows other names of tribes; C. on v, 5.]

COLUMN VIII. 7. *ἀποδατῆθαι . . . ἰῶ*: This supplies the deficiency of the expression *διαλαχόνσαν* preceding.

9. According to Plato's provision (Legg. 925), "If there be a lack of kinsmen in a family extending to grandchildren of a brother, or to the grandchildren of a grandfather's children, the heiress may choose, with the consent of her guardians, any one of the citizens willing to accept her hand." Our code is measurably more generous to the heiress than the Athenian or the Platonian, as indeed the position of women in general is more independent, as it was at Sparta. Plato, while following the ordinary principles of Greek law in relation to heiresses, is yet fully sensible of their oppressiveness and hardship (Legg. 925-6), and acknowledges that there will be cases in which the parties will refuse to obey, and be ready to do anything rather than marry, when there is some bodily or mental malady or defect, especially insanity, in one party or the other. He accordingly provides that such cases may be brought before the guardians of the law or the court for adjudication.

20-29. *νόναται*: I connected this with *νο-στάζω*, in the sense of "consent" (*ἐκούσιον ἐκουσία*, Plat. Legg. 925 A); but the adj. *νονατόν* in C.'s minor inscription seems to demand the sense of "able," as if for *δυνατόν* (*δύναται*). At Athens a daughter without brothers was regarded as an heiress (*ἐπίκληρος*), as well during her father's lifetime as after his decease (Pollux, 3, 33). In the Gortynian code she is not so, till the death of her father, nor then if she have brothers. The text here contemplates her having been married off by her father, or after his death by a brother. In the first case, she would become heiress at her father's decease if she had no brothers, in the second, after the brother's death. In the latter

event, at Athens her previous marriage could be dissolved directly by judicial decision, her hand being demanded in court by the nearest of kin, as was often done (Is. 3, 64; Dem. 863, 867) whether there were children of the marriage or not. The claimant, however, could forego his rights, if he pleased (Is. 10, 5). Here, on the contrary, it appears that the marriage was regarded as dissolved by the very fact of her thus becoming an heiress, and, if children had been born, it rested with herself and husband to remarry, or, if she pleased, she might wed anyone else of the tribe, by surrendering half the property to the husband and children—a provision which again exhibits the humanity of our lawgiver in striking contrast even to Plato.

36–40. Cf. ἀποτεισάντων οἱ ἐπιδάμοι τῶν κόσμων, Cauer, 119, 33. Sojourn abroad (ἀποδημία) is given in Isaios (2, 12), as a reason why a brother at home should be selected for adoption in preference to the absentee. Plato would give permission to the heiress to select some one who has gone forth to a colony and bring him back, provided she had no kinsmen (Legg. 925).

42. Plato admits the brother by the same mother among those whom the heiress is to wed, if he has no allotment of land in the community (Legg. 924 E).

45. διαλαγχάνειν: BB. would take the subject from the following clause. In any event the moiety that passes into the hands of the πατρώων goes to the groom-elect (vii, 29–35).

47. ἰάττα: The Dorians of southern Italy used ἔασσα (Ahrens, ii, p. 325). [So C., et om.]. The partic. here represents the temporal clause preceding (cf. Hm. θ 461).

51. According to Diodoros (xii, 15) the Katanian lawgiver Charondas wrote, that the nearest kinsmen of the father should manage the property of orphans, but that they should be brought up with the mother's relatives (cf. Diog. Laert. Solon, ix; and the old Scotch and French law). The historian praises this regulation highly, because the relatives on the mother's side are not heirs to the property and will therefore not plot against the orphans' lives; while the father's kinsmen are unable to do so, since the orphans are not entrusted to their care. On the other hand, the property which may fall to them by the death of the orphans they will manage with the greater care, in the hope that it may ultimately come into their possession. According to the hypothesis of Is. 10, the father's brother was the legal guardian of the children of the deceased at Athens; cf. Is. 1, 9; Dem. 814.

COLUMN IX. 5. Lysias, as cited by Suidas (ἔγγειον), quoted a law at Athens to the effect, that all money belonging to orphans should be vested in mortgages, but in no other security. [C.'s reading is opposed to the

general principle of the code as enunciated vi, 7-23. Whatever may correctly supply the lacunae here, it cannot be that the guardians would be permitted to sell property forbidden to a father. BB. have rightly seen this.]

18. See Plat. Legg. 914 C., and the inscription from Zeleia, Ditt. S. I. G. 113, 18-21: ἦν δέ τις ἀμφισβητῆ φᾶς πρίασθαι ἢ λαβεῖν κυρίως παρὰ τῆς πόλεως, διαδικασίην αὐτῷ εἶναι, καὶ εἰδὼν φανῆ μὴ ὀρθῶς ἐκτεμῆνος, τὴν τιμὴν αὐτὸν ἐπτίνειν ἡμιολίην.

26. ἐκοιωτάνος (ix, 35; Blass, BB.) relieves this passage of much difficulty. At the best we can do no more than guess at the meaning as a whole. ἐκοιωτάνος is referred to the Hesychian gloss, κοῖον· ἐνέχυρον, money for which a pledge is given.—διαβαλλόμενος: defraud; Ionic and old Attic. BZ.

32-33. δικαστᾶς: Cf. Dem. Neair. 40: τούτων αὐτὸν μάρτυρα ὑμῖν τὸν τότε πολέμαρχον παρέξομαι.—μνάμων: This word, occurring in inscriptions from Halikarnassos, Iasos, etc., is described by Aristotle (Pol. vii, 8), as the title of the officer before whom all private contracts and the decisions of the courts of law have to be registered, indictments laid, and preliminary proceedings in a lawsuit taken.—πολιατεύη may refer to the possibility of his being abroad at the time of the case coming up again (cf. οἱ ἐπιθάμιοι τῶν κύσμων, Cauer, 119) [so Blass], or of his having suffered ἀτιμία; or, if a mere scribe, of his being a slave. But it may be doubted if any written records of the court were actually kept; none seem here implied. We are reminded of the Homeric supercargo who was φόρτου μνήμων, θ 163. In the Gortynian inscription, Bull. Cor. Hellén. 1885, p. 19, the μνάμων of the κοσμοὶ is the brother of the eponymous κοσμος. The ordinary Greek γραμματεὺς occurs in the Drierian inscription, Cauer, 121.

36. ἀποFεῖπωντι: Cf. xi, 11, and Is. 2, 33: αὐτοὺς παρέξομαι μάρτυρας, εἰδὼν ἐθέλωσιν ἀναβαίνειν (εἰσὶ γὰρ τούτων οἰκεῖοι); Dem. 850; Is. 9, 18; Aischin. Tim. 71.

40. νικῆν: Cf. νίκης, τὴν μιν ἐγὼ νίκησα, Hm. λ 545.

41-43. Is this a penalty, or a restriction? Cf. iv, 29-30.

44. πέραι = πείρα C.; cf. χρέος, χρεῖος, as συμπλεῖξ for συμπλέξη (cf. πλίσσεται, plicare).

47. μέττ': μέστα occurs in the Kretan inscription, Cauer, 120, 40, and the Arkadian, 457, 30.—Plato recommends that a transaction in cases of surety, be witnessed by 3 persons if the sum be under 1000 drachmas, five if above (Legg. 953). If contributions to ventures abroad are really meant in this passage, the feature which contemplates the possibility of a single drachma is truly interesting.

COLUMN X. 15-18. Cf. xii, 15.—λείωντ': The emphatic position seems to throw the stress here. The heirs need not pay a legacy above 100 staters, unless they wish. Plato is more peremptory in the case of the gift

of a fixed sum for marriage garments, which, if exceeded, shall be forfeited to Hera and Zeus, and a fine of equal amount exacted, Legg. 774 D.

20-24. In the Delphian inscription, Ditt. S. I. G. 462, it is said of a slave emancipated under certain conditions: *εἰ δέ τινι ζῶων δόσιν ποίετο τῶν ἰδίων Σῶσος, ἀτελής ἂ ἀνά ἔστω.*

25-28. To make ἄνθρωπον subject is contrary to the spirit of the language of the code.—*δέξασθαι*: Cf. *εἴ γε μηδὲ δοῦλον ἀκρατῆ δεξαίμεθ' ἄν*, Xen. Mem. i, 5, 3. Second mortgages were not forbidden at Athens (Dem. 930), except by special contract (Dem. 926), nor at Ephesos, Ditt. S. I. G. 344, 34.

33. Adoption at Athens could take place from any citizen's family, though usually confined to relatives, and only when the adoptive father had no legitimate male children (Hypoth. Is. 10), or had renounced those he had, though he might adopt in his will, the act to take effect in the event of his sons dying before they reached their majority, or in the event of his having none at all. If he died childless and intestate, the next of kin became a *quasi* adopted child. After taking the adopted son to his house, on a certain day, regularly that of the *Thargelia* (Is. 7, 15), he brought him before the *phratores*, offered a sacrifice, and swore on the altar that the adopted son was an Attic burgher, and he called his *phratores* to witness that he adopted him as his son. Enrolment then took place in the register of the phratry, as later in that of the deme (Meier and Schoemann, *Att. Proc.* p. 437; Isaios, *passim*). The adopted son succeeded to all rights and responsibilities of legitimate children, the *sacra* (Is. 2, 10, 36-7, 46), payment of debts, etc. If there were natural sons born to the father after adoption, the adopted received an equal share with the son (Is. 6, 63). Were there daughters of the family into which he was adopted, he was expected to marry one of these, and probably adoption could not take place without this provision (Is. 10, 13). If the act took place by will, he might be directed to receive only a part of the estate, as a third or half (cf. *Dikaiogenes*, Is. 5). In this case he was probably compelled to pay at least his share of the father's debts (cf. Dem. *Lakr.* 4); if not, the custom would be something like that of our code where there are daughters, when the adopted son was at liberty to decline the obligation. According to Greek sentiments, one would hardly expect him to be relieved of the *sacra*, though they were often costly and troublesome. That he could decline these, is not distinctly stated, though it seems implied, in this code (xi, 2-3). As here, so at Athens, no woman or minor could adopt (Is. 10, 10).

The first 15 lines of column xi, though published in 1863, were not properly explained till 1878, by Bréal (*Rev. Arch.* xxxvi). There could

have been no difficulty with it, if the preceding part had come to light at the same time.

36. ἀπαγορεύοντι : ἀπαγορεύει ἀποφαίνεται, Hesych.

38. ἑταιρεία : Dosiadas (Athen. 143) says that all Kretan citizens were divided into ἑταιρείαι, and these were also called ἀνδρεία, which is the old Dorian word for mess-companies (*sysitia* at Sparta, in the historic period). Each citizen contributed one-tenth of the produce of his land to his *hetaireia*, and this body made over the total amount of all these contributions to the state treasury, or rather to that division of it from which the expenses of the *sysitia* were to be defrayed (Schoemann, p. 307). In the Drerian inscription, fines laid on the *kosmoi* for the non-performance of duty are also to be divided among the *hetaireiai*. Such regulations support the keen-sighted remark of Hoeck (*Kreta*, iii, p. 126), that these *hetaireiai* formed close mess-companies, at the foundation of which probably lay an earlier tribal division and distinction of family (Dass dieser Einrichtung eine frühere uns unbekannt gebliebene Stammeintheilung und ein Geschlechter-Unterschied zum Grunde lag, wird wahrscheinlich). This becomes still clearer from the fact that in matters of adoption the *hetaireia* corresponded to the Athenian *phratría*. The frugal supply of wine, a small pitcher full, points again to an early period, as the victim at Athens was called μέτρον (Pollux, 3, 53). It is true that frugality in meats and drinks, especially wine (Plat. Min. 320), was a characteristic of the Kretan people; but at the ordinary meals a bowl of wine was placed on the table, and then a second, after the meal was over (Athen. 143).

42-3. θίνα καὶ ἀνθρώπινα : θείων καὶ ἀνθρωπίνων, Kretan inscription, C. I. G. 2554 (new reading from the stone, θίνων καὶ ἀνθρωπίνων, Comparetti, Museo Italiano, i. p. 144); θείων καὶ ἀνθρωπίνων, Cauer, 118.

COLUMN XI. 5-6. πλῖνι : More than the daughters,—to houses, cattle, etc., as a son would (iv, 31-43). [C. conceives the meaning to be "the adopted son shall not transmit it further by adoption."]

10. So at Athens, Dem. 1100.

11. The Athenian ἀποκήρυξις, admissible at least in case of legitimate sons (Dem. 1006, Plat. Legg. 929; ἀπίνασθαι, Hdt. i. 59). Repudiation of an adopted son was also permitted, even after his marrying a daughter of the adoptive father, as seen in the case of Leocrates, Dem. 1029.

15. I have supplied δέκα as double the gift of ii, 52, where it is the amount presented to the wife when renounced by the husband.—[δικαστήριον : probably the building on whose walls the code was inscribed, BZ.]

16. ξενίω : This may correspond to the Homeric ξενίον, as the gift of hospitality presented to the guest at parting, and would thus be an assurance that the repudiation was done in all friendly feeling (cf. Cauer,

118, 15: *δόμην αὐτοῖς ξένια ἀργυρίω μῶν*); or it may be read *Ξένια* "in propitiation of Zeus Xenios"; cf. Athen. 143, f. [C., reading τῶ *ξενίω*, refers it to a tribunal, *Ξενικὸν δικαστήριον*, Pollux, 8, 62.]

20. *ἔγραψε*: For *ἐγράφη*, by assimilation, C.

21. *ἀφαντοῖ*: Dat. of *ἀφαντός*, as *ἀρχηστός*, etc. [So also Blass; and Dittenberger, *Hermes*, 1885, p. 577.]

24. It will be noticed that the remainder of the code is mainly explanatory and supplementary to the preceding, as if it was originally intended to stop here, but additional provisions were found necessary or advisable, as in the Twelve Tables at Rome.

25. *ἐπιδέχεται*: I understand this as supplying a fact that seems taken for granted in i, 2-25, but is now distinctly enjoined, namely, that the slave, when set at liberty after seizure by the complainant, shall be received by his master, who shall be responsible for him till the decision of the judge; and, in the case of the free man, the *assertor in libertatem* shall do likewise, as implied in *ὁ ἔχων*, i, 24. "Toute personne qui voudra transiger avant jugement sera toujours reçue à le faire," D.; "L' uomo che voglia (ammettere quanto reclama chi lo cita in giudizio) ammetta in ogni caso prima del processo," C.; "Einen Menschen, wer ihn wegführt vor dem Rechtsstreit, nehme man immer an sich," BZ.

45-53. Notwithstanding the expression *γυνὰ ἀνδρός* (which, however, is to be compared with iii, 41), this appears a mere supplement to iii, 5-7, where the husband has brought suit against the wife for recovery of property claimed to have been wrongfully taken. If the judge decide that she may take her oath of exculpation, it shall be done within twenty days, but 4 days previously the complainant shall announce his charges. [So BZ., Blass; C. and D. of the woman suing for divorce from husband, of which we know so little at Athens.]

53. *προτέταρτον*: This seems preferable to F.'s *πρὸ τετάρτων*, although singular. [So C., *et om.*] Cf. *προσκαλεσάμενος πρόπεμπτα*, Dem. 1076, 75; *πρότριτα*, Thuk. ii, 34, Arist. Pol. vii, 8, 7 (1321). If *πρό* be retained as a separate preposition, its usage in this sense at so early a date finds support from Hdt. vii, 130, 138; cf. Cauer, 119, 42.

COLUMN XII. 16. *ἔγραττο*: Clear evidence that a written code preceded the present one, as that of Drako before Solon's; and like Drako's it was in great part superseded by the one we now have, in matters of private relations.

21. *ὄρφανοδικασταί*: One would naturally expect this word to be equivalent to the *ὄρφανισταί* of Photios: *ἀρχὴ ἐπὶ τῶν ὄρφανικῶν· ἵνα μηδὲν ἀδικῶνται*; or Xenophon's *ὄρφανοφύλακες* (Vectig. 2, 7), or the Archon Eponymos at Athens (Dem. 1076). But what kind of a public office could be that in which an interregnum during an heir's minority would

be conceived to exist? It seems to me more likely that these are guardians appointed by the father before his death. Plato (Legg. 924 B) prescribes that, if a father die intestate, the next of kin, two on the father's and two on the mother's side, and one of the friends of the deceased, shall have the authority of guardians (cf. 766 C). Or it may mean the grandfather, who might be alive during the youth of the heiress. [Not public officials; probably appointed by father, C.]

27. *πάτρωα*: According to the requirements of the case, this cannot mean the father's brother, as elsewhere, but must be some more distant relation on the father's side (cf. *μάτρωα* in Pindar and Eur.). [Grandfather, C.]

28. *τόνς ἐγγραμμένονς* should refer to viii, 44-52, ix, 1-4.

30. *ἀνᾶνται*: *ἀνη· ἄνουσις*, Hesych.; hence *ἀνάω· ἄνουσις· ἀδξησις*, Hesych. *τὸ τοίνυν χωρίον τὸ ἐκείνου πατρῶον ὁ πατήρ ὁ ἐμὸς* (as guardian) *ἐφύττυσε καὶ ἐγεώργει καὶ ἐποίησε διπλασίον ἄξιον*, Is. 9, 28.

AUGUSTUS C. MERRIAM.

NOTES ON ORIENTAL ANTIQUITIES.

TWO BABYLONIAN SEAL-CYLINDERS.

The two seals, of which the accompanying figures (10 and 11) are copies, are of a type extremely rare, if we may judge from the fact that it is not, so far as I am aware, represented among the hundreds



FIG. 10.

of seal-cylinders found in Cullimore's, Lajard's, Ménant's, and other collections and publications. Both are engraved somewhat less than



FIG. 11.

the natural size.¹ The larger of the two (fig. 10) belongs to Dr. A. Blau, a merchant in Mesopotamia, who was good enough to allow

¹The height of fig. 10 is $1\frac{1}{8}$ in., that of fig. 11 is $1\frac{1}{2}$ in.

me to take a wax impression of it, with the privilege of publication. It is of black marble, and in a state of perfect preservation.

The other (fig. 11) I have never seen, but I obtained ink impressions of it on paper, done in the oriental style by a dealer in antiquities in Baghdad, in whose possession it once was. These impressions give an imperfect idea of the condition of the seal, but I judge it to be well preserved, and presume it also is of black marble.

A single fine cylinder figured (enlarged) in Lajard's *Culte de Mithra*, pl. XII. 5 (fig. 12), may throw light upon these cylinders. The material and ownership is given as unknown to M. Lajard, who received a copy of it from Constantinople. The composition is entirely different: the subject belongs wholly to common life; the figures are arranged in an upper and a lower register, and we miss



FIG. 12.

the remarkable figure of the man astride of the bird. On the other hand, the free composition, and the sheep and goats headed by the human figures, are sufficient to show that the three belong to the same period and school of art. Indeed, the gate in fig. 12, so well drawn, out of which the sheep are driven, is probably represented in fig. 10 by the gridiron-shaped object to which the flock is being led.

The correspondence between the first two cylinders is very marked. Observe that the group formed by the man astride the bird, and the dogs under him, is precisely the same in both. In each a kneeling man holds a tablet. In one a seated man, and in the other two seated men are before a vase. In each, a man is driving a flock of sheep led by a goat. In each, a man stands with uplifted right hand, holding an object in his left hand. The bird in the tree, the

lions, one kneeling figure, and the common Babylonian seven stars are peculiar to the larger cylinder. The two were possibly made by the same artist.

Babylonian literature and art, so far as I can recall, give no explanation of the bird bearing the man. The Zu Bird, described in Smith's *Chaldean Genesis*, seems to have no relation to it. It reminds me rather of Ganymede and the eagle, or of the mighty roc of Arabic fable, which may very possibly have been inherited from such a Babylonian original as is figured here. The bird with outspread wings, but unmounted, occurs, especially with goats, in a number of curious cylinders.

The very freedom of the design suggests an early and not a late period. The art of the early Chaldean period of the discoveries of Telloh, and of King Gudea, was much less conventional than that of a later period. This indication is supported by the inscription on fig. 12, which is in the most archaic Babylonian style. Niffer, from which the first cylinder is said to have come, is one of the very oldest sites in Babylonia. Black marble is a favorite material of the older cylinders, and the shape and large size are further indications of great antiquity. I am inclined to believe that the three cylinders belong to Southern Babylonia, and to a period from two to three thousand years before Christ.

WILLIAM HAYES WARD.

UNPUBLISHED OR IMPERFECTLY PUBLISHED
HITTITE MONUMENTS.

I.

THE FAÇADE AT EFLATÛN-BUNAR.

[Plate I.]

In an article published in the *Revue Archéologique* for May 1885, M. Perrot gives a drawing of the remarkable monument of Eflatûn-Bunar, with an account of it by Dr. M. Sokolowski of Cracow, who visited it while on a scientific expedition to explore ancient Pamphylia. M. Perrot, in a foot-note, states that he has seen, in a report of a trip in Asia Minor made by Dr. Sterrett and Mr. Haynes, that they took a photograph of this monument, and he asks that a copy of the photograph may be sent to him. As Mr. Haynes, now of the Central Turkey College at Aintab, who went with Dr. Sterrett on his trip for the purpose of taking photographs, has placed in my hands, for such use as I might make of them, copies of his photographs of this remarkable monument, it seems best that a fully trustworthy representation of it should be published.

The monument was long ago imperfectly known by the description of Hamilton, who, in his *Researches in Asia Minor*, pp. 351, 352, gave an unsatisfactory account of it, saying that he knew nothing like it in Asia Minor. Its location is given by Hamilton and Sokolowski with sufficient exactness, as on the edge of a small sheet of water at the head of a stream flowing into Lake Bei-sheyer, and about nine miles north of that lake. It lies about fifty miles a little north of west of Konieh, the ancient Ikonion. It consists of a façade of fourteen stones of reddish brown trachyte, and faces almost exactly south. Its size is given by Hamilton as 22 feet 5 inches long, by 11 feet high, and 2 feet 6 inches in thickness. It appears to have been the front of a structure the rear of which, now torn away, once rested against the neighboring cliff.

There can be no question that this monument belongs to that primitive period in the history of Asia Minor which we are now coming to call "Hittite," although its construction, as seen in the plate, is quite different from any other known monument. For making out the details, the plate should be compared with the drawing of Dr. Sokolowski, who says that it is so worn that, in order to make out the position of the figures, it must be seen from different points of view.

It will be seen that an immense winged circle, here a half-circle, typical of the supreme deity, and cut in a single block, spreads its general protection over all the figures represented. The wings are very long, and show the wing-coverts separate, and are turned up at the ends. Beneath the central part of this winged circle, on a single stone, are two other smaller circles, the wings of which meet. The circle is complete, the wing-coverts do not appear, and the short wings turn up strongly at their ends. Beneath the centre of each of the two minor winged circles is a colossal human or divine figure, the left one of which wears a long pointed cap, and lifts the arms straight up on each side of the cap. Ten smaller human figures are seen, symmetrically arranged and holding up their two arms, as if, like Atlas, supporting a universe. Two of these, the upper one on each side, have one leg advanced and uncovered, and wear square caps, a girdle and sword.

The winged circles, representing the protection of the supreme deity, are common to Egypt, Babylonia, Assyria, Persia, Phœnicia, and the so-called Hittite race of Asia Minor, though foreign to Greek art. The wings, slightly upturned at the point, are characteristically Hittite, as seen in the remarkable sculptures of Boghaz-keui, where the emblem occurs several times. The high, peaked cap of the left of the two colossi is also in a common Hittite style, as seen in forty of the Boghaz-keui sculptures, in the two figures called pseudo-Sesostris, at the Karabel Pass, and in an unpublished relief at Jerablus (Carchemish), representing two men standing on a crouching lion. Square or round head-dresses, such as are worn by the other figures, are common on Hittite monuments, but are less characteristic. The condition of this stone does not allow us to decide whether the toes are turned up, as is so frequent in Hittite figures.

The most remarkable thing about this monument, and one to which I know of no parallel, is the presence of three winged circles, as if there were three supreme gods. If we may judge from the universal use of this symbol, three gods cannot be intended, although one's first thought naturally is of a supreme triad, like the Assyrian Assur, Hea, and Bel. We may, perhaps, conjecture with more plausibility, that this monument, built, like the Assyrian effigies of their kings, at the sacred head-waters of lake and river, celebrates not the victory of one king, but the alliance, perhaps after war, of two kings. These would appear in the two colossi, which are differently attired, whose size indicates them to be the principal figures, and each of whom is appropriately placed under the supreme divine protection. They are accompanied by attendants, and they all lift up their hands in adoration, as they are all once more represented as together under the protection of this same supreme power, this time figured as a still larger disk with longer stretch of wings.

It is not unexampled, to find three or more winged disks, near together, in Persian sculptures, where, however, they have been reduced almost to the condition of a decorative motive.

The number of places in Asia Minor where Hittite remains have been found is rapidly increasing. This, at Eflatûn-Bunar, would seem to belong to a highway from Carchemish towards Smyrna, by way of the great Hittite centre about Marash and Aintab, through Tarsos and Ibreez. These remains appear to be especially abundant about Kappadokia and Lykaonia. Another monument, not far off, somewhat less important than ours, but yet interesting, found by Dr. Sterrett on his expedition of last summer, awaits publication. A number of others from Marash, Carchemish, etc., not yet published, I hope to give in future numbers of this Journal, as part of the fruit of the Wolfe Expedition to Babylonia.

WILLIAM HAYES WARD.

NOTES.

NOTE ON PLATE V, 2, OF VOLUME I.

On p. 153 sqq. of the preceding volume of the JOURNAL, Dr. Alfred Emerson has quite correctly brought out the fact, that the relief of Herakles drawing the bow, published by Rayet in his *Monuments de l'Art Antique* (reproduced in pl. v, 2), and attributed by him to the end of the VI or the beginning of the v century, does not correspond in the least with the pure style of archaic Greek art. The conclusion, however, which Dr. Emerson draws from his observations, that the relief is a modern forgery, seems to me hardly justified. It is certainly not archaic, but it is archaistic; that is, it belongs to that class of reliefs of a late period which imitate in a very refined but exaggerated manner certain peculiarities of the archaic style, introducing, however, some practices of the later and freer style.

I have not seen the original of the bas-relief, but I am well acquainted with another which is its exact counterpart, and about which there cannot be the least doubt. It represents Herakles with his knee on the stag's neck. The style of the two reliefs is absolutely identical: even the type of the beardless hero is the same in each, and is, in fact, strongly related to that of the Harmodios (in Naples). It is quite probable that both reliefs are derived from statuary groups of the series of Kritios and Nesiotes. The relief with the stag was sold at Rome in 1884, at the auction of the collection of Alessandro Castellani (No. 1093 of Fröhner's catalogue), and is now in a private collection in Rome: a cast of it is owned by the Berlin Museum. It is 33 centim. high; and Rayet gives the height of the relief published by him as "environ" 35 centim.; so that they are of the same height: the width is different, on account of the subject, as the fallen stag required far greater width than the standing archer. Both reliefs must have belonged to one and the same series of representations of the labors of Herakles. Of course, the relief of Herakles as archer must have been immediately followed by a slab representing his adversary. Both these works should be ranked among the very best examples of archaistic art, and may belong to the first century B. C.

A. FURTWÄGLER.

BERLIN.

RECENT ARCHÆOLOGICAL DISCOVERIES IN PERSIA.

I.

The attention of archæologists has recently been drawn to the antiquities and monuments of Persia, through the researches and discoveries of M. Dieulafoy, charged by the French government with a mission to the East. For about three centuries numerous travellers have visited Persia and have signalized the important ruins which cover the southern provinces of the country; but no one, until now, had studied and classified scientifically the ancient monuments of Iran, or carried on methodical excavations on sites that promised to yield interesting discoveries.

This is hardly the moment to recall the principal travellers who have been attracted by the archæological riches of Persia. As early as the close of the xvi century, the Bolognese architect Sebastiano Serlio, on the strength of reports of Catholic missionaries, thought himself able to make a tentative restoration of the palaces of Persepolis. A little later, Don Garcias de Sylva de Figueroa (1574-1628), ambassador of Philip III to the Shah Abbas the Great, visited the ruins of Persepolis, in describing which he dwelt particularly on the cuneiform inscriptions. In 1602, Stephen Kakasch, ambassador of the Emp. Rudolph II, wrote a description of Persia, the text of which has quite recently been published by M. Schefer, under the title *Iter persicum* (Paris, Leroux, 1877). In 1621, a Roman, Pietro della Valle, brought back from Persepolis to Father Kircher the copy of a fragmentary cuneiform inscription: probably the first cuneiform letters seen in Europe. About thirty years later, Thévenot visited Persia and described it; but none of these travellers had the critical sense of Chardin (1681), or showed as much care in the description of the ruins. After him may be hastily enumerated: Struys in 1681; Flower in 1693; Hyde in 1700; Cornelius Van Bruyn in 1704; Tavernier in 1712; Kœmpfer in 1712; Otter in 1748; Niebuhr in 1765; and, at the end of the last or the beginning of this century, Ouseley; abbé de Beauchamp; Jaubert; Dupré (1808); more recently, Ker-Porter in 1818; Tessier in 1840; Coste and Flandin in 1841; W. Loftus in 1852; and finally the Comte de Gobineau.

In 1874 the German government sent to Persia an epigraphic and archæological expedition under the direction of Dr. Andreas, of Kiel, and Dr. F. Stolze. The scientific results of the German mission are, as yet, only very incompletely known. Still, the fifth international Congress of Orientalists, held at Berlin, decided that the archæological photographs taken by Messrs. Andreas and Stolze should be published. The first volume of the extensive publication appeared in 1882¹: it must be confessed that it is a real deception as well for archæologists as for Orientalists. The photographs are defective, and were evidently taken by persons with very little care for archæology. But little account is to be taken of this album, as costly as it is useless.

A peculiar contrast is the book which M. Dieulafoy has devoted to the ancient art of Persia, where the author codifies the results of his observations in the province of Fars, along the Persian Gulf.² In Farsistan are grouped the most important monuments of the ancient civilizations that flourished in Persia: there lie overthrown the palaces of Persepolis, of Murghâb, of Shiraz, of Shahpûr, of Darabgerd, of Naksh-i-Rustam, and of Firuzabad. Travellers have many times described these ruins, but what was still necessary was to ascertain their exact age, their architectural characteristics; to clearly disengage what, in these monuments, belongs to each one of the dynasties that succeeded each other in the country. M. Dieulafoy starts with the valley of Polvar-Rûd, the ancient Medos, where, in the neighborhood of Meshed-Murghâb and Mader-i-Suleiman, villages on the road from Ispahan to Shiraz, are the remains of a city built by the first Akhæmenid dynasty, anterior to Darius I. It was after his victory over Astyages that the great Cyrus built the palace of Meshed-Murghâb and the sepulchral monuments, such as the tomb of his father Cambyses I and the Gabr-i-Mader-i-Suleiman, "the tomb of the mother of Solomon," in the valley of Polvar, situated on the borders of Persia proper and recently subdued Media. The city of Cyrus was abandoned when Darius founded Persepolis, a little further on, in the plain of the Merdash. The ruins of the Polvar valley represent, then, the most ancient period of Persian art, and the first questions that arise are: Where did this art come from? In what was it original?

¹ *Persepolis. Die achæmenidischen und sassanidischen Denkmäler und Inschriften von Persepolis, Istakhr, Pasargadae, Shahpur, zum ersten male photographisch aufgenommen, von F. Stolze, in Anschluss an die epigraphisch-archæologische Expedition in Persien von F. C. Andreas. Herausgegeben auf veranlassung des fünften internationalen orientalistischen Congresses zu Berlin, mit einer Besprechung der Inschriften von Th. Nöldeke. Erster Band, Berlin, Asher, 1882, in f°.*

² *L'Art antique de la Perse. Achéménides, Parthes, Sassanides, par Marcel Dieulafoy. Paris, Des Fossez, 1884. Four out of five parts have already appeared.*

What did it borrow from other civilizations, and what are these civilizations?

Whatever originality is shown by Persian art under Cyrus is conditioned by the peculiarities of soil and climate under which it was produced and developed. There is no water in Persia, and this explains the scarcity of trees and, consequently, the lack of wood for building purposes. In the mountainous districts an intense cold prevails, and in the plain a tropical heat unequalled, perhaps, in the world. The natives were therefore constrained to build dwellings suited to protect them from both extremes: they succeeded in doing so without the use of wood, by means of vaults and terraces. "These special conditions of soil and climate," says M. Dieulafoy, "gave rise to a special architecture, and as it prevented the development of any foreign importation which was not adapted to local requirements, exaggerated in Persia that law of immutability which seems to have been imposed by destiny on all the nations of the East." Now, the geological and climatic conditions of Persia led the inhabitants to construct their dwellings on artificial terraces, and to cover them with brick vaults and cupolas. It was the Iranians who invented the cupola with pendentives and the vaulted naves, long before the architects of Byzantium or the West. Their constructions, doubtless, are quite rude, but contain all the principles which it was sufficient to develop in order to attain to the marvellous cupolas of Santa Sophia.

The terrace, the vault and the cupola are, then, at all periods and through all revolutions the essentially original and invariable characteristics of the popular architecture of Persia, as opposed to the official architecture, with its imported foreign elements. But, as early as the time of the first Akhæmenid dynasty, there exist in Persia artistic or architectural elements that are not prescribed by the natural conditions of the country, and are consequently of foreign origin. An analysis of the monuments of Meshed-Murghâb discloses the fact that they bear the closest affinity to Greek monuments, especially to those on the coast of Asia Minor. Some, like the Takht, the Gabr, the ruined palace, resemble Greek constructions; others, like the sepulchral towers, recall Lykian constructions. No sign of the influence of Egypt and Assyria; not a profile, not a detail of the mouldings, not the least ornament the prototype of which can be found on the banks of the Euphrates or the Nile. Even the idea of building on an artificial platform belongs as much to Lykia and Asia Minor, as it does to Elam or Chaldæa.

But are the monuments of Meshed-Murghâb the prototypes of the Greco-Lykian edifices, or did the Akhæmenids borrow their architecture from the inhabitants of the coast of Asia Minor? It is easy to prove, historically, that the Akhæmenids were the imitators. Before the reign

of Cyrus, the Persians had never had direct and continued relations with the Greeks, from whom they were separated by the Assyrian Empire; the processes and laws of Greek architecture could have reached the valley of the Polvar only by a slow and gradual propagation through Asia Minor and the Assyrian Empire. In this case, we should necessarily find in Assyria monuments similar in their art to the Greek and Akhæmenid constructions. Nothing of the sort has been found: we must then conclude, with M. Dieulafoy, that "the nation that owed to the other its processes of construction, borrowed them only on the day when the Aryans of the South and the Hellenes met for the first time on the battle-fields of Lydia."

Long before the capture of Sardis by Cyrus, we find in Greek monuments, such as the temples of Egesta and Selinous in Sicily, and of Samos, the essential elements of the architecture of the palaces of Meshed-Murghâb; a certain proof that the Persians learned from the Ionian Greeks the secret of their art: the towers of Meshed-Murghâb and of Naksh-i-Rustam show the strongest analogies with the tombs of Myra, of Antiphellos, and with the tomb of the Harpies, at Xanthos in Lykia.

The constructions of the Polvar-Rûd valley are anterior to the expedition of Cambyses to Egypt, for they bear no traces of Egyptian influence. The trilingual inscriptions in Persian, Median and Assyrian, found there, prove, on the other hand, that the language of Nineveh had already obtained an official position at the court of the king of Persia at the time of the construction of the palace at Meshed-Murghâb; it follows, that these buildings are posterior to the taking of Babylon by Cyrus, and the king who built them was in reality the Great Cyrus, and not Cyrus the younger as some had supposed. At the same time a confirmation is given to the genealogy of the Akhæmenids, who reigned in two branches over Persia, the branch of Cyrus, and that of Darius. The archæological studies of M. Dieulafoy are, then, useful for history, as well as for archæology. I will not speak of the question of the geographical identification and the establishing of the sites of the two Pasargadæ, a subject of considerable importance but rather beyond my scope.

Persepolis, on the other hand, belongs entirely to the second Akhæmenid dynasty, that of Darius. The latter prince transported the capital of the Empire from Murghâb, in the Merdash plain, to the south of the gorges of Polvar-Rûd; and the ruins of the palaces and tombs raised by his dynasty have given fame to the modern localities of Takt-i-Jemshid, Istakhr, Naksh-i-Radjeb, Hadj-Abad, Naksh-i-Rustam. The Persepolitan palaces are built of brick, with the exception of the columns, doors, windows and staircases; there still remain standing cannellated columns about twenty metres high: the great throne-hall (*apadana*) of the palace

of Xerxes had a hundred columns; the walls were covered with revetments of differently-colored enamelled bricks and decorated with bas-reliefs. "Persepolitan architecture differs from that of Meshed-Murghâb only in the addition of Egyptian motifs, transferred to stone by a school of sculptors imbued with the best Greek traditions." It is certain that Egyptian influence was introduced into Persepolis in consequence of the conquest of Egypt by the Persians. Though in the construction of the palaces it is met with only in details, it produces, on the other hand, a radical revolution in the sepulchral architecture, which experienced an abrupt change between the first and second Akhæmenid dynasties. Under Cyrus and his successors it takes the form of isolated square tombs like those of Lykia; after Darius, the kings excavated *hypogea* in the face of the rocks, like those of the Pharaohs. We will not follow M. Dieulafoy in his attempt to define what might be called the *Persepolitan order*—the Greek volutè surmounted by the bicephalic Egyptian capital—or in his study on the origin of the Greek orders, to which he brings a contingent of new elements and ingenious views.

The fifth part of M. Dieulafoy's important work is still to be published, and will include the Parthian and Sassanid monuments and sculptures, and the origin of Mussulman art. The author will doubtless show that the Arabs borrowed all the elements of their architecture from the monumental art of Iran under the Akhæmenids and Sassanids. In the mean time, we will follow M. Dieulafoy in another field, and speak of the results of the excavations which he has undertaken for the French government in the ruins of Susa, the ancient capital of Elam.

II.

In 1851 General Williams and Sir William K. Loftus visited the ruins of Susa, and commenced excavations which were interrupted after a few days by the hostility of the inhabitants. Loftus has given an account of his journey and its scientific results in his interesting volume, *Travels and researches in Chaldæa and Susiana* (London, 1857, in 8vo.). Since then, although the mounds have been visited by different travellers, no excavations have been attempted: they are made difficult both on account of the extreme heat and the fanaticism of the Shiis, who hold in great veneration the neighboring so-called *Tomb of Daniel*.

M. Dieulafoy solicited and obtained from the French government the mission of resuming and carrying out the work only sketched out by the English travellers. We trust that fanaticism will not prevent him and his brave companions from prosecuting the perilous enterprise which he has begun with success. Susa is, with Nineveh and Babylon, one of the

most ancient cities of the world, and the study of the monuments that must be found among its ruins cannot fail to throw quite a new light on the origin of the ancient civilizations of the East. After a successful campaign, during last winter, M. Dieulafoy has made known the first results of his mission in a summary report,³ from which is taken the greater part of the following details.

The citadel and palaces of Susa form to-day a rhomboid tumulus of about one hundred square hectares (= 200 acres). One of the numerous mounds, which together form this tumulus, represents an Akhæmenid monument, the palace of Artaxerxes. In the trench opened on this site there were found all the fragments of a bicephalic capital of colossal dimensions, which, when erected in the galleries of the Louvre, will be the only example of Persepolitan architecture, adequate and exceptionally beautiful, that exists in a European museum.

The special object, in this first campaign, was to reconnoitre the ground, sink shafts in the ruins, and lay bare the walls that determine the arrangement of the palaces and fortifications. This preliminary work has already brought to light a large number of objects in ivory, bronze, alabaster and terracotta. Of especial interest are eighty-eight Elamite seals in *pietra-dura*. "The most beautiful of these intagli is a conical seal of a grayish violet opal. It is of rare beauty, and was doubtless engraved for an Akhæmenid king, Xerxes or Artaxerxes I. . . . The medallion of the king, surmounted by the supreme divinity Ahura-Mazda, is placed between two sphinxes wearing the white crown of Upper-Egypt."

From one of the trenches came an enormous quantity of enamelled bricks, or rather squares of enamelled concrete, from the revetment of a palace wall. On being joined together they were found to form a superb lion in bas-relief, 1.75 met. high, placed between two flowered friezes, on one of which was painted a cuneiform inscription of Darius. Other fragments of the same nature showed that there was originally a procession of nine lions in bas-relief set off by lively and decided colors, which formed the external decoration of an Akhæmenid portico.

In the fortifications of the Elamite gate, that is to say in constructions dating from the earliest civilization that had its centre in Susa, there was found a fragment of a panel of enamelled bricks possessing the greatest historical interest. "These bricks belonged to a panel on which was represented a figure richly dressed in a green robe, overlaid with yellow, blue, and white embroidery, and in a tiger's skin; and carrying a golden cane or lance. The most singular point is that the figure, of which

³*Revue Archéologique*, July-August, 1885.

I have found the lower part of the face, the beard, neck and hand, is black. The lip is thin, the beard abundant, and the embroideries of the garments, most archaic in character, seem to be the work of Babylonian workmen." Other enamelled bricks have been found: "two feet with gilt shoes; a well-drawn hand, with a wrist covered with bracelets and fingers that grasp the long bâton which became under the Akhæmenidæ the emblem of supreme power; another piece of a robe emblazoned with the arms of Susa, partly hidden under a tiger's skin; finally, a flowered frieze with a brownish background. The head and feet were black, and it was even apparent that the entire decoration had been planned so as to accord with the dark tone of the figure."

M. Dieulafoy even recognizes in the physiognomy of this black king of Susa, for it is unmistakably a king, the characteristics of the Ethiopian race. Now this discovery is of capital importance: it connects itself with a tradition preserved among the Greeks and even the Romans, and to which modern criticism has always refused to accord the least historical value. In the *Odyssey* we find, twice cited, a person by the name of Memnon, called "the Son of the Dawn" and "the handsomest of warriors." He is given as the son of Tithonos, the brother of Priam, and he comes from the East with Sarpedon to the assistance of Troy besieged by the Greeks. Hesiod calls Memnon "king of the Ethiopians," that is, king of the men with dark faces.⁴

Besides, we know positively that for the Greeks there were two Ethiopias, one in Asia, beyond the Tigris, that is to say in Elam itself; the other in Africa, at the sources of the Nile. It is hardly necessary to recall the poems of Pindar and Simonides, that sing the fabulous exploits of the black king Memnon, the hero of Asiatic Ethiopia. We will only remark, borrowing the expression of Letronne, that "the kingdom of Memnon was placed in Susiana where his father Tithonos had built Susa; which accords with the tradition followed by Aiskylos, as, according to this poet, Kissia, the country of which Susa was the capital, was thus named from Kissia, the mother of Memnon. According to another tradition, Tithonos was but a satrap of Persia, subject to the king of Assyria Teutamos, who held Troy under his sovereignty. This satrap sent his son Memnon at the head of a hundred thousand Ethiopians, as many Susianians, and ten thousand chariots, to assist Priam, who was his tributary."

In Ovid, the adjective *memnonius* is synonymous with *black*, and classical tradition, represented by Aiskylos and Ktesias, attributes to Memnon the construction of superb palaces. The excavations of M. Dieulafoy at

⁴See Letronne, *Œuvres choisies*, publiées par E. Fagnan, t. II. p. 60 sqq.

Susa will, it seems, prove that these Greek and Roman fables have a serious historical foundation: an Ethiopian race, perhaps connected with the Trojans, ruled at Susa; and Memnon the Ethiopian is not simply a puerile conception of the Greek fancy. It will soon be scientifically established that this hero, like Nimrod, personifies a race, and that he must figure, on this account, in the first chapter of the history of ancient Oriental civilizations.

ERNEST BABELON.

CORRESPONDENCE.

EXCAVATIONS UPON THE AKROPOLIS AT ATHENS.

The excavations undertaken upon the Akropolis, toward the end of the year just closed, were begun near the Propylaea, and were carried along the massive poro-stone foundations of a long and narrow ancient building, extending against the outside wall of the Akropolis, already discovered by the French in 1879-80, but not fully exposed until now: the building probably belongs to the epoch of Perikles but its identity has not yet been established. The excavations have been carried to within fifteen paces of the Erechtheion, and have stopped at a cross-wall running at a right angle with that of the Akropolis. Among a large number of objects found, many being of great value, the following are the more important, and I have arranged them under the categories of bronzes, marbles, pottery, and inscriptions.

I. **BRONZES:** These, though numerous, are mostly formless scraps, but there are some animals, as lions, horses, etc.; a few winged human figures, with legs spread apart, in rapid flight; and two or three female figures: all of the most rude and primitive workmanship.

II. **MARBLES, ALL ARCHAIC:**—1. *Small bas-relief of a horse*, badly broken; head, legs and hind parts wanting; finely modelled, veins and muscles carefully executed; mane represented almost entirely with colors.—2. *Female fore-arm*, without hand. This fragment of an archaic female statue is one of the most interesting of the pieces found. About the wrist is clasped a round bracelet, and above this hangs a piece of himation, richly painted. This painting is preserved with remarkable distinctness: about the edge is a dark-brown, almost black, stripe, and the border so formed is cut, also with dark hues, into small quadrangular fields, about an inch and a half on each side; each of these fields has a red square within it, inside this square a circle of dark spots, inside this circle another dark square, and in the centre a very small red circle. The folds, falling in the characteristic rhythm of the labored archaic style, have a bright border of stripes: red, green, white and this dark-brown color, the brilliant red predominating.—3. *Female torso*, about 2½ feet high. The head was made of a separate piece and is lost. The dress

consists of a soft woollen chiton, buttoned together at the shoulder into short sleeves, and over this a carefully executed himation: the left hand holds the dress at the thigh in the archaic manner.—4. *Female statue*. The body of this statue, though somewhat larger, is an exact repetition of the one just described; probably they are from the same hand, and were set up side by side as parts of one and the same votive offering. The head, which was broken off when found, is adorned with a *στεφάνη*, back of which the hair was not indicated plastically, but painted upon the smoothly chiselled surface. In front of the *stephane* the hair falls in waves ending in a single row of cork-screw curls about the forehead. In the *stephane* itself are fastened ornamental ringlets of bronze. In the top of the head is an upright bar of bronze for the support of the umbrella-like disk, often copied in vase-paintings. The back-hair covers the neck and falls, in four long curls on either side, about the shoulders. The face bears a striking resemblance to the Athena of Aigina; the chin is exceptionally pointed; and the almond eyes and the archaic smile are prominent features. The epidermis is well preserved in its original smoothness, and it is, on the whole, a rather fine specimen of archaic sculpture.—5. *Equestrian statue*. Probably the most ancient work of its kind, but unfortunately much broken. Almost the whole of both legs, the head, and the arms are wanting. Of the horse the head and neck, the rump and many small pieces have been found. The statue is of a youth or, more exactly, a *μελλέφηβος*. It does not show all the stiffness of the earlier archaic sculptures, but evidently belongs to a time when they had begun to introduce a little softness and ease, though in this respect our statue is still much inferior to the so-called Strangford Apollon. This feeble attempt at softness of form is seen most plainly in the slight furrow marking the outlines of the stomach, instead of the usual harsh angles. The horse, as we always find animals at this time, is much better executed than the rider.—6. *Draped female statue of the Spes-type*. A large, well-preserved statue of the strictly archaic type. Only the feet and fore-arms are wanting; the nose is slightly injured. The hair is adorned with a *στεφάνη* and is arranged in unbroken waves about the forehead, combed back behind the ears, and falls in long curls about the shoulders. She wears three garments: over a fine woollen chiton, visible only at the breast, is thrown the himation, fastened lightly at the right shoulder and passed under the left arm; it reaches to her feet and is held in the left hand at the thigh; and over this is a short shawl-like mantle. The painting is well preserved. The chiton was red, the girdle green, and the border of the himation had stripes of green with somewhat indistinct decorations of red. The border of the chiton is a row of green spots with a red and green stripe on either side. The

folds which fall from the right arm, and those from the girdle to the left hand, are painted in a maeander of green and red. Besides this the whole dress is dotted with bright-green crosses.—7. *Small female statue.* Arms and feet are wanting. The features are quite beautiful, and the whole makes a pleasing impression. The hair is arranged just as in the preceding, but is much finer and more beautiful. The drapery is arranged upon the left side, but otherwise is like the preceding. No traces of painting remain.—8. *Small female statue.* Almost all of both arms and the feet are wanting. The workmanship is rough and primitive. The hair runs in three separate rows quite around the forehead, and back of these is laid in furrows toward the neck, falling in three curls on either side about the shoulders. Around the neck are only two creases to mark the chiton; there are no folds at all in the mantle above the breasts, and below this is an himation almost devoid of folds, held at the thigh in the right hand.—9. *Male torso.* The execution is hasty. The figure wears a mantle, painted red, covered, except on the right breast, by a long garment thrown over the left shoulder. The collar was painted with a maeander of green and red. Only a small part of the chiton is visible, at the right arm.—10. *Marble copy of a ξόανον.* Only the lower half has been found. Deep folds at the sides, and the ends of the girdle falling from the waist, divide the front into three parts; in the middle field are traces of a red stripe, in the outer fields vertical stripes of green. The right hand rested upon the side, and from the point of contact another slight fold runs to the bottom. The himation extends almost to the feet. About its border is a red stripe an inch in breadth, with green decorations, and above this is a red maeander. Just as represented in vase-paintings, this has no feet but a sort of basis not more than an inch thick, marked off by a deep groove.—11. *Fragment of a statue of Nike.* This is by far the finest piece among the recent discoveries, but, unfortunately, it consists of only the neck and the right half of the upper part. The hair, though still conventional, is more natural, and the folds in the drapery are arranged in excellent taste. The chiton was painted red, with a blue collar; on the mantle are scanty remains of red and green. Back of the shoulders are large holes for fitting on marble wings.—12. *Colossal female statue.* Both arms and the lower half are wanting. The head is adorned with a στέφανη, behind which the surface is smooth and was probably painted. About the forehead the hair is arranged in three parallel rows of cork-screw curls. The eyes are the exceptional part: they consist of gems inserted in sockets (the right one is broken out), but what the stones are can not be determined with certainty until the statue is well cleaned. It is very beautiful, and the treatment of the rich drapery marks it as a work of the

ripe archaic period.—13. *Female statue*. Arms and legs are wanting. This statue is much more ancient than the one just described, and the proportions much less correct. This head, too, is decorated with a στεφάνη, and the hair was painted red. There are circular concave cavities for the eyeballs; and on close examination we find a small hole in each corner of the right eye, probably made for fastening the inserted eyeball.—14. *Female statue of Parian marble*. This fragment includes only the part from the neck to the waist. It seems to be an almost exact repetition of the so-called Hera of Samos, now in Paris. The dress appears to be only an himation thrown shawl-like about the shoulders and buttoned several times at the right arm. The left hand, which though broken off has been found, rested upon the breast, just as in the Paris copy, and holds between the thumb and first two fingers a pomegranate. These are probably duplicate copies of some famous work; perhaps the *Theodoros* of one of the inscriptions found was the author of both, and is identical with the famous Samian sculptor of that name (cf. Paus. VIII. xiv. 8; IX. xli. 1; X. xxxviii. 5; etc.: also, Mitchell, *History of Ancient Sculpture*, pp. 199, 200).

It is, of course, impossible to name all these statues. From the inscriptions found they would seem to be votive offerings; but whether they represent the divinities to whom they were set up, or the priests and priestesses, or the persons who set them up, there is no means of determining: several of them are evidently statues of Athena. They are all very ancient, and all, except the one characterized as Samian, belong to the so-called Delian school. They were probably buried where they were found, about the time the wall was built, that is, under Kimon. Something new is found almost every day, and these new additions to our comparatively scanty store of archaic sculptures are hailed with delight.

III. POTTERY: There have been but two or three vases found unbroken, and these were only small lekythoi of no special worth. There are bushels of pieces, but of little else than the black-figured vases of the earliest times, and none of the fine red-figured vases. The best pieces of this class are little *πινάκια*, votive offerings to some divinity. They are all small but one, and represent a great variety of scenes, as, for example, a woman washing clothes, a soldier standing in position of parade, etc. A very small fragment represents the birth of Athena: Zeus sits with his left hand extended before him, and from his head the goddess springs in full armor. The colors are peculiar: there is no black used, but the hair, the uncovered parts, except the faces, and parts of the dress are of a light blue, while the faces and other parts of the clothing are of a deep red. What has attracted more attention than anything else is a *πινάκιον* of this same kind, but much larger. It is about 2½ inches thick, and

somewhat more than two feet wide. The bottom is broken away, but its height was probably greater than its breadth. About the picture are drawn, as a frame, two lines, one black, the other a dark red. Inside this frame is a warrior armed with helmet (the plume of which as well as the metal part is not colored), spear, and shield. The design on the shield is a dancing black satyr with a long, red tail. Besides his armor, the warrior wears a red chiton and over this a black himation. The ideas of perspective, both in the relative position of the arms and the shield, are very much confused. Above, on a level with his head, are two words; the one on the right is distinct and reads *καλός*; the other may be *Παλαμίδης* but cannot be read with certainty.

IV. INSCRIPTIONS. Quite a number of archaic inscriptions, on fragments of columns and on bases, have been found: they are partly metrical, formulæ of dedication to Athena, etc.

ATHENS, GREECE, Feb. 12, 1886.

WALTER MILLER,
*Member of American School
of Classical studies.*

THE "MONUMENTAL TORTOISE" MOUNDS OF "DE-COO-DAH."

[Plate II.]

In the year 1853 a very queer book was published at New York, entitled *Traditions of De-coo-dah and Antiquarian Researches*, etc. The author was one William Pidgeon, a former trader among the Indians of the upper Mississippi. The book contained many drawings of symmetrical and intricate earthworks in the north-western States and Territories of the Union, together with a key to the history and signification of the same as given by De-coo-dah himself—"the last prophet of the Elk nation." The illustrations, however, were so novel, the classification of the mounds so elaborate and fantastic, and the traditions so wholly unsupported, that the work was not at that time, nor for years afterwards, recognized as authoritative; and was not mentioned by compilers of American pre-historic matters, such as Baldwin, Foster, etc. The fact is, that inspection of the best-known works on American antiquities, like those of Atwater, Squier and Davis or Whittlesey, showed but little, if anything, to justify the formal and significant shapes and positions of Pidgeon's embankments and effigies, and nothing at all to confirm the systematic arrangements of ordinary round mounds pictured so liberally in his book.

It sometimes happens, as students of cartography and geography well know, that a mistake made by some one is so often copied, unwittingly, by

others, that it becomes to the world at large an established fact. In like manner, Mr. Pidgeon's statements, which were not accepted by the Smithsonian Institution, the American Antiquarian Society, and other authorities of thirty years ago, are now gradually appearing in standard works on American archæology. Conant, in his *Footprints of Vanished Races* (1879), evidently accepts Pidgeon's earthworks, for he copies five diagrams of the geometrical kind and three of the effigy-shaped ones, not to mention a large part of the traditional matter. Bancroft, in Vol. 4 of his *Native Races of the Pacific States*, places Pidgeon and Lapham on an equal footing, as the original discoverers of the "effigy mounds." Ellen Russell Emerson, in her *Indian Myths, etc.*, of the Aborigines of America (1884), quotes largely from "De-coo-dah," laying much stress on the symbolism. In Nadaillac's *Pre-historic America*, seven of the diagrams are given, as furnishing authentic information; but, curiously enough, although Pidgeon is accredited with having, in 1853, first brought the subject of animal-mounds to the notice of the public, this information has been obtained indirectly through the work of Conant above referred to. The expert bibliographer now conducting Sabin's *Dictionary* (1885), though deploring Pidgeon's "baseless hypotheses and unreliable traditions," seems not to doubt the value of the "very clear illustrations of many remains of Indian structures." With such conspicuous bell-wethers, doubtless other writers will, like unsuspecting sheep, take a like course, unless some one cry, Halt! Even Lucien Carr, a stout champion of the theory that the North-American mounds and inclosures "were the work of the red Indians of historic times, or of their immediate ancestors," writing in one of the publications of the Kentucky Geological Survey, narrowly escapes the precipice, for he thinks that the mounds can be sufficiently well treated under three heads, with the possible "exception of the animal-mounds, about which nothing definite is known," "unless (as he adds in a foot-note) the explanation given in that curious book, 'The Traditions of De-coo-dah,' should be accepted as authority, and this is scarcely advisable in the present state of our knowledge."

I do not want to be understood as charging Mr. Pidgeon with a deliberate and intentional fabrication of arrangements and conformations of earthworks which are entirely without example; but I have reason to know that it is not safe to quote his statements as authority, having personally examined many of the localities described by him. I will now treat of a particular point in "De-coo-dah," as a justification for writing this letter.

In chapters 5 and 8 of the book in question, among other things, will be found an account of a group of mounds on the Minnesota River (then St. Peter's River), visited by Pidgeon in 1840. According to his

narrative, he, in company with some French traders, ascended the river about sixty miles, when they arrived in the neighborhood of an Indian village, situated some two miles from the river, or presumably from their landing place; the natives there informed him that not far distant from them, up the river, were many mounds; he went to the spot and ascertained, by their agreement with De-coo-dah's description, that they were the mounds of which he was in search,—the "Title mound of the Black Tortoise" with its accompanying symmetrically arranged tumuli and embankments, erected to commemorate "the title and dignity of a great king or potentate," and for sepulchral purposes. Naturally enough, my curiosity was excited on reading about so wonderful a place, and I determined to make thorough search for it whenever a surveying trip should lead me in that direction, as the distance given by Pidgeon indicated a definite locality, namely, a point not far from the mouth of High Island Creek, a stream entering the Minnesota River from the west.

In October 1884, therefore, being in this vicinity, I took occasion to hunt up this "Black" or "Monumental Tortoise" collection of earthworks, in order to verify Mr. Pidgeon's account of it. After a thorough search, I found there but one group of mounds, which was situated on the N. W. quarter, section 26, Township 113, of Range 26, having on the north and west the valley of the creek above mentioned. Between this site and the Minnesota River was once an Indian village; and a great battle is said, on good authority, to have once taken place between the Dakotas and the Ojibways in that neighborhood. Under these circumstances, together with the fact that one of the mounds near the centre of this group corresponded to the "Black Tortoise" itself, I had no hesitation in coming to the conclusion that these earthworks were the same ones that Mr. Pidgeon described.

I now surveyed the entire group, taking the relative position of each mound with its diameter by tape line, and ascertaining its height by spirit-level. In order to make plain the difference between the appearance in the plan of the mounds most nearly central in position, as given by Mr. Pidgeon, and that which they actually present on the ground, I have prepared two outline diagrams for comparative study (*plate II*).

Figure 1 is copied from the original plate in "De-coo-dah," the shape of the mounds there given being exactly reproduced by the full lines. As, however, some of the dimensions found in the text vary from the engraving as scaled, a dotted line is added in such cases to indicate the variation in form thus produced. These differences, however, may arise from clerical errors, or perhaps be the fault of the draughtsman or engraver.

Figure 2 is plotted from my own field-notes, and, in order to show the mounds surrounding the "Tortoise," covers a somewhat larger space than the area pictorially occupied by Mr. Pidgeon's group.

It will be noticed that the central figure of both diagrams is practically the same; but there the resemblance ceases—unless we identify his council-chiefs' mound with my No. 37. The relative positions of the mounds to each other, also, were probably, in the first case, merely sketched as they appeared, or seemed to appear, to Mr. Pidgeon from a given point. His heights and dimensions were undoubtedly mere estimates, and very poor ones at that. But how account for mounds of shapes so radically different from those that any other man ever heard of before or since our author's time? Or why so many more mounds represented than actually exist immediately around this central mound or tortoise?

Another puzzling point to be considered is the great disproportion between the heights and diameters of the mounds described in "De-coodah." For instance, the author describes the "prophets' burial-mounds," situated next the central figure, on the east and west, as being twelve feet long, six feet wide, and four feet high. The following table gives the height and diameter of the principal mounds of the group, according to the book, together with the deduced ratios of the two dimensions.

Name or Kind.	Cross-section.		Ratio.		Position on plan (Fig. 1).
	Height.	Diameter.	Height.	Diameter.	
Monumental Tortoise,	12	27	44	100	In centre.
Mounds of extinction,	6	7	86	"	{ Immediately N. and S. of centre.
Mourning mounds,	12	27	44	"	At the four corners.
Points of royal honor,	8	12	67	"	{ Outside line, E. and W. of centre.
Prophets' burial-mounds,	4	6	67	"	{ Immediately E. and W. of centre.
War-chiefs' burial-memorial,	12	27	44	"	Outside line, S. of centre.
Council-chiefs' memorial,	4	22	18	"	Outside line, N. of centre.

Any one at all familiar with the works of the Mound-builders will see, at a glance, that mounds thus proportioned (except the last one) are improbabilities, to say the least; as the figures of the first six lines imply angles, with a horizontal plane, of from 41 to 60 degrees. For my part, I can state that of the six largest conical mounds measured by me in various localities, ranging between 12 and 18 feet in height, the ratio of height

to base was from 15 to $19\frac{1}{2}$ to 100, equivalent in angle to from $16\frac{1}{2}$ to $21\frac{1}{2}$ degrees. In the case of a seventh, however, a truncated mound twelve feet high, situated on the Crow River, Minnesota, the proportion was 28 to 100, or an angle of $29\frac{1}{2}$ degrees with the horizon. If such departures from all likelihood existed in this instance only, they could be overlooked: but they occur in the descriptions of all the groups that Pidgeon mentions as having been surveyed by him in the North-West, and cannot be ascribed to blunders made in connection with the publication of his book.

Besides the Minnesota River group, I have visited and critically examined other localities described by our author in south-western Wisconsin and north-eastern Iowa, and in addition have made many inquiries, of old settlers, concerning him and his claims. At Trempeleau, Wisconsin, I talked with the daughter of his one-time host, the Kentuckian who had a squaw wife. The result of all my researches in this respect is to convince me that the Elk nation and its last prophet De-coo-dah are modern myths, which have never had any objective existence; and that, consequently, the ancient history in the volume is of no more account than that of the Lost Tribes in the Book of Mormon.

T. H. LEWIS.

ST. PAUL, MINNESOTA, December 23, 1885.

REVIEWS AND NOTICES OF BOOKS.

TRAITÉ D'ÉPIGRAPHIE GRECQUE, par SALOMON REINACH, précédé d'un Essai sur les Inscriptions Grecques, par C. T. Newton. Paris, E. Leroux, 1885. 8vo, pp. xliv, 560.

Let us suppose that the student of Greek has decided to extend his knowledge of the language and life of Hellas, beyond the limits of our literary sources, into the domain of inscriptions, where the faults of centuries of copyists and the chances of transmission no longer stand between us and the original utterance, and where the splendid apparel of literary form is for the most part doffed, and we see the people themselves with garments girt ready for the busy activities of every-day life. With such determination, the student will provide himself with certain books that are absolutely essential. Hicks' *Greek Historical Inscriptions*, and Dittenberger's *Sylloge Inscriptionum Graecarum*, will furnish him with a large body of material arranged chronologically and accompanied by a series of most helpful commentaries. Cauer's *Delectus Inscriptionum Graecarum*, and Collitz's *Griechische Dialekt-Inschriften*, will serve his purposes for the study of dialectology, free from the admixtures of the eclectic poet; and Kaibel's *Epigrammata Graeca* will exhibit to him Greek poetry hobbling on her lame foot. If he should have at hand Boeckh's great *Corpus*, and the *Corpus Inscriptionum Atticarum*, he will be fortunate indeed. He will not content himself with the texts themselves, but will proceed at the outset to take a careful survey of the origin, growth, and changes of the alphabet, that he may be able to fix the date of an inscription, and often its place of discovery or origin, within reasonable limits, at first sight. For this purpose, Roehl's *Inscriptiones Graecae Antiquissimae* will be necessary for the fuc-similes, and Kirchhoff's *Geschichte des Griechischen Alphabets*, or Taylor's *The Alphabet*, for proper guidance. Setting to work with this material, he will soon find how difficult a task it is, to acquire a comprehensive view and arrive at the criteria that guide the masters of the art in their determination of minute points; and he will be compelled to resort to the numberless special articles in periodicals and monographs, where many of the recent inscriptions have been published or made the subject of discussion. Even here he is referred from one

treatise to another, each more difficult or impossible to obtain, till he is inclined to abandon the search, with information incomplete and fragmentary.

The great desideratum has been a manual which should offer a survey of the whole field, and present the chief results obtained by all the laborers in the past, arranged and reduced to order by a practical epigraphist who has made it his business to study all the special articles and treatises with this view. The *Elementa* of Franz is still a work of considerable value, but it is out of print and difficult to procure, as well as costly. But, more than this, it is now nearly half a century since it was published, a period in which the number of known inscriptions has been fairly trebled, and the foundations of the art of interpretation have been reconstructed and built upon a base so broad and firm, that it is not likely to be greatly disturbed, as a whole, by future discoveries. Publishers as well as epigraphists have perceived the need of supplying its place, and we are told that the great masters in the art have declined to risk their reputations upon the venture: but M. Reinach has at last, to borrow his own expression, leaped, like another Curtius of Roman story, into this chasm in the forum of erudition, with the hope of closing it successfully, for our generation at least.

As an introduction to the minute study of the subject, he has translated Mr. Newton's *Essays on Greek Inscriptions*, originally published in the "Contemporary Review" and the "Nineteenth Century," and more recently embodied in his *Essays on Art and Archaeology*, 1880. Mr. Newton has here described and given the substance of the most important of the inscriptions relating to historical events, to temples, rituals and ministers of religion, religious associations and clubs, dedications, and sepulchral monuments; and thus offers a general survey of extreme value for subsequent work. To these essays M. Reinach has wisely added, in foot-notes, the originals of the most important inscriptions discussed, and he has embodied in the text, among other things, an account of the great Delian inventory and a full translation of the Epidaurian stele of miraculous cures. This occupies 174 pages of M. Reinach's work, which then proceeds to the history of the alphabet, with its chronological tables and tables of abbreviations. Lenormant is followed for the most part in this chapter, and especially in the derivation of the supplementary letters of the alphabet, though the views of others are given. The second chapter is of especial interest to the grammarian and orthographist, whose subjects are treated at considerable length upon the basis of Attic inscriptions, covering much the same ground as the excellent work of Meisterhans, which appeared in time only to be referred to by Reinach in his appendix. The varied contents and usefulness of the succeeding portion may be seen

from some of the headings, as follows: The mode of engraving inscriptions, the material on which they were cut, and the places where they were exposed to view; the engravers (whose designation in Greek is not known), the various secretaries who are directed to superintend the cutting, the expense of engraving, errors of the cutters; the treaty cited by Thukydides (v. 47) and the original stele; headings of inscriptions, formulas of Attic decrees and those of other states, proxenian and honorary decrees; consecrations, statues, dedications, ex votos, oracles, letters; judicial, choragic and ephebic inscriptions; epitaphs, imprecations, signatures of sculptors; inscriptions on vases, pottery and engraved stones, lead and ivory. The last chapter is devoted to that difficult and perplexing study, Greek eras, years and months, to Greek proper names, and to a considerable list of Latin terms relating to the administration of government under the Romans, with their Greek equivalents, taken for the most part from inscriptions. We can touch upon the detailed treatment of only a few of these general heads.

On the subject of hiatus and movable ν , M. Reinach speaks with no uncertain sound. He contends that the old Attic sought for that which became hiatus in the new, concurrent vowels being elided or fused, so as to present no hindrance to the flow of speech, while ν ephelestikon was employed to prevent the deadening of short final syllables, and to please the ear with an assimilation which bound the words more closely together. Hence, he formulates the following rules, true in principle though subject to many exceptions: 1. So long as the pronunciation assimilated the consonants and the vowels at the end and beginning of words, the forms in ν were employed before consonants, those in vowels before vowels. 2. As soon as the pronunciation ceased to assimilate the consonants and the vowels, the language began to use the forms in ν before vowels, those in vowels before consonants. This latter tendency, which appears from the fourth century B. C., is not rigidly regarded even in the last epoch of the language. In accordance with the first rule, the text of Thukydides should be constituted, always, for instance, employing $\mu\acute{\epsilon}\chi\rho\iota$ instead of $\mu\acute{\epsilon}\chi\rho\iota\varsigma$, as shown by the inscriptions. In metrical inscriptions ν is sometimes employed where it destroys the metre, while vowels to be elided are occasionally left undisturbed. Of the last, in addition to the examples cited by Reinach, we may instance two cases in the halting lines of Kleo's dedication embodied in the Epidaurian stele of miraculous cures, a fact which may have hindered Kabbadias from recognizing them as metrical. $\acute{\epsilon}\delta\omicron\zeta\epsilon\nu\ \tau\eta\ \beta\omicron\upsilon\lambda\eta$ is always written in inscriptions, even in the earliest Attic decree now known, not that of C. I. A. i. 1, in the British Museum, but one earlier by more than a century, published by Koehler in the *Mitthei-*

lungen (ix. p. 117) and relating to the occupation of Salamis by Kleruchs in the time of Solon.

The errors of copyists of manuscripts have been made a special study by many, and M. Edon has performed this task for Latin-epigraphy; but for Greek it was left to M. Reinach to examine and catalogue the errors of engravers of inscriptions, and thus place this important subject in its proper light. Many have sounded portentous warnings against the acceptance of inscriptional forms as criteria for our literary texts, and prefer rules of their own devising. It is true that stone-cutters had their errors, as well as copyists, and corrections are occasionally found in the stones themselves, while other errors remain unnoticed. In one case (C. I. A. ii. 17), belonging to the year 378 B. C., ten letters are written over a line in a later hand among which occurs the lunar formed E. This form of E and ξ is noted by Reinach (p. 207) as not appearing in Athenian official epigraphy before the single example of the years 48-42 B. C. Surely, the ϵ of the Attic boundary-stone, 305 B. C., (Dittenberger, S. I. G., No. 435) should have been mentioned, though it is not in an official inscription. A distinction is very properly made between the documents engraved for the State by competent handicraftsmen under the supervision of educated secretaries, and those which were made for private persons at their own expense. M. Reinach has given a table of the most frequent confusions of letters, from which he concludes that those of M and N (μ confounded with η , ν , π : ν with μ , σ) prove that the writing of the originals, furnished by the secretaries to the engravers to copy from, differed considerably, in several letters, from the uncials of the Hyperides MS., and approached more nearly to the cursive and minuscule. Especially, the confusion between M, N, and ξ shows that the lunar sigma must have been almost unknown in this chirography, when it was employed in our most ancient uncial MSS. Almost all errors of suppression are explainable by the vulgar pronunciation or by the influence of neighboring letters or words. Additions are more rare than suppressions, and are in general due to the same causes. In fine, the errors of the engravers, even when most numerous, are of an importance wholly secondary, and can never render the texts worthy of rejection or disregard: they are errors purely mechanical, for which the eye and the hand alone are responsible, and which have not been at all increased by the literary or exegetical pretensions of a reviser. Under these conditions it is rash to attempt violent conjectures in an epigraphic text; for example, to expel a word or change the order of a phrase; but it is permissible to alter certain letters when their presence in a word renders a well-known form either barbarous or inexplicable.

On the other hand, our author comes to the defence of our literary texts with little less vigor. After pointing out the differences which exist between the treaty in Thukydides (v. 47) and on the stele which has been preserved of it, he continues: "However numerous may be the errors in detail committed by the copyists of our MSS., it seems to us contrary to good sense, in reliance on the comparison which precedes, to refuse almost all authority to the manuscripts, and to throw the text of Thukydides, like a victim without defence, a prey to the aggressive instincts of verbal criticism (*emendatio*). On the contrary, if one will examine dispassionately the differences that have been shown, he will perceive that they are of little importance after all, and that, exactly where the extremists have seen reason for the unreserved condemnation of the copyists, one can find a proof of their care and relative exactness. If one were to believe certain critics, a text, after having been copied twice, would be altered to the point of being unrecognizable, since, by their showing, copyists are surrounded by so many temptations and chances of error; but one is quite astonished, on comparing the original with a copy made sixteen centuries later, to find so few differences of detail and so perfect an agreement in substance."

M. Reinach devotes a considerable part of his introduction proper, to the traveller who sets out with the intent to discover and copy inscriptions. Such a traveller should first inform himself, as far as possible, touching all the inscriptions that have heretofore been obtained from the region to be visited, and should carry with him a pocket *Corpus* of all such, transcribed for use in determining whether any stone he meets with has or has not already been copied, or in order that, with the original before him, he may decide whether the errors of his predecessors will justify him in spending the time necessary to copy it. Then follow, minute directions for guidance in taking impressions, copies and photographs, and as to the materials and instruments that have been found most efficacious; warnings gathered from the unhappy experience of the past; rules for reducing a copy to the proper form for publication and comment; and so on, altogether forming an admirable field-book of epigraphy. We are glad to see that he urges strongly the custom adopted by the American Institute of Archæology, namely, to present a translation as an accompaniment to every new inscription published, a custom which editors are sometimes quite content to honor in the breach.

In a treatise upon a subject where a new discovery at any moment may alter some matter of detail, M. Reinach has strenuously essayed to lay before us the latest results, almost to the day of publication; and he even refers to articles yet to appear in the periodicals. Nor has he neglected anything of special value in the past. He has not only ransacked the

four corners of the subject, but has shown himself possessed, withal, of an unwearied diligence in laborious painstaking, combined with a happy faculty of extracting the vital point of a complicated discussion, and of turning the brightest facets of his diamonds towards us. If the man deserves well of his country who makes two blades of grass grow where there was but one before, signal is his merit who arranges, classifies, and reduces a great subject, and thereby diminishes so vastly the labor of acquirement in the ever widening and ever overburdening field of learning.

AUGUSTUS C. MERRIAM.

TIRYNS: The Prehistoric Palace of the Kings of Tiryns, the Results of the latest Excavations, by DR. HENRY SCHLIEMANN, Hon. D. C. L. Oxon., &c., &c., &c. The Preface by PROFESSOR F. ADLER, and Contributions by DR. WM. DÖRPFELD. New York, Chas. Scribner's Sons, 1885: pp. lxiv-385, twenty-seven plates, a map and panoramic view, and 178 cuts in text.

This interesting book has been brought out with exceeding promptness. The "latest excavations" described in it are those of 1885, from the middle of April until the middle of June: that is to say, that no magazine article, with illustrations, was ever prepared and put through the press more quickly than these final chapters. The natural result is, that the book is a series of reports rather than a treatise. We are told of interesting finds in the spring of 1884, and of others in the spring of 1885. The pottery and other moveables are well described, the earlier found by Dr. Schliemann, the others by Dr. Ernst Fabricius; but these are detached papers. The remains of buildings, as explored in 1884, are taken to mean that which it was quite clear in 1885 that they did not mean; Dr. Dörpfeld in the frankest manner leaving his first statement standing with his later views to contradict it, for all the world as if published in successive numbers of a review. We have, then, the curious result that the big and costly book does not contain the definitive discussion, nor even the complete and final account, of the discoveries at Tiryns; and that for these we must look to the review articles of the future, since another book upon the subject is hardly to be hoped for,—at least from Dr. Schliemann and his coadjutors.

Professor Adler's preface is of fifty-four solid pages, and contains a very interesting summing up of the discoveries, and especially of the remains of buildings,—but only as they were revealed to him by the inadequate excavations of 1884. This, however, is an extremely intelligent analysis

and comparison of fortress with fortress, Mykenai and "Troy" with Tiryns, and is full of suggestion. It appears, too, that the author foresaw the important discovery of the free use of clay mortar in the "cyclopean" walls of Tiryns, and was of opinion (page xi) that "all so-called cyclopean walls" would be found to have "a strong mortar of loam or potter's clay . . . used as bedding material . . . but dried up afterwards . . . and washed away." This preface is well worth study. Dr. Schliemann next takes 176 pages to describe, in the first chapter, the excavations in general, with chat about the country and the people, the daily habits of the exploring party, and their bill of fare, including *resinata*, which they seem to have liked; in the second chapter, the topography of the country, and the history and conjectural history of Tiryns; in the third chapter, the vessels and utensils of pottery and hard-stone (for there were none of metal, and almost none of glass or bone) found in the exploration of the "oldest settlement" on the Tiryns akropolis; and, in the fourth chapter, the far more numerous remains found in the débris of the later buildings. The pottery found here is of very great interest, and is well described in the text and well illustrated by colored plates and numerous wood-cuts. But, besides pottery and certain rough utensils in different stones, there is little. The pieces of bronze found were few and not very important, and there is just one piece of gold, one of silver, and one of iron, in all the Tiryns collection. With this chapter ends Dr. Schliemann's own part of the book, and the reader is left with the impression, that he has made the best use of very limited resources; that the work at Tiryns has only been begun, and that more is left than has yet seen the light: while, on the other hand, Dr. Schliemann's extensive knowledge of archaic pottery has enabled him to fill up the somewhat meagre list of new discoveries with interesting comparisons and analyses.

The rest of the book—just half—is made up chiefly of Dr. Dörpfeld's two important and careful chapters: first, the buildings of Tiryns as explored in 1884; and, second, the farther discoveries of 1885. The importance of these discoveries will hardly be denied. The distribution of the many courts, rooms and stairways is generally unmistakable; the positions of altars and sacrificial pits and the hearths in the great rooms, are generally satisfactorily ascertained. But there exists no wall which is more than a metre in height, and therefore there is no trace of windows; nor, in the débris, is there any indication of what the roofs were like; and it seems to be from external evidence that our authors decide for flat clay roofs, like some of modern times. Most important of all would be, if we could but obtain it, some trace of the former defensive dispositions of the outer walls. Dr. Dörpfeld seems hardly to be aware of the immense interest of this enquiry. Of early Grecian defensive warfare the wildest

nonsense has been talked, nor can any one pronounce upon it with any authority. Even a few roughly shaped stones, found at the foot of the outer walls of Tiryns, might begin a new investigation into this unsettled question.

On the whole, the most important discoveries recorded in this book are the wall-paintings on plaster, and the floors of concrete mosaic in patterns; these, and the already mentioned and indisputable gain made in the discovery of the free and general use of mortar in these rough walls. These discoveries are worth all they have cost; and this book probably does full justice to the designs of floor and wall decoration. Otherwise, we leave the book with the feeling that it was made too hastily and brought out too soon. Our hopes of getting finally from Tiryns all that can be got must depend upon the care the Greek government will take of the now exposed remains, until a more patient and complete examination of them can be made.

RUSSELL STURGIS.

UNEDIRTE RÖMISCHE FUNDBERICHTE aus italiänischen Archiven und Bibliotheken veröffentlicht von THEODOR SCHREIBER. 8vo, pp. 80. Leipzig, 1885 [Aus den Berichten d. K. Sächs. Gesell. d. Wissenschaften, Phil.-hist. Classe 1885].

For a number of years an important share in the formation of the C. I. L. has been taken by the MS. collections of inscriptions made at various times by lovers of archæology and antiquities; collections of which we find examples in the earliest Middle Ages and in Carlovingian times, and from that period in a continuous array up to the great antiquarians of the early and late Renaissance. These collections, made generally by travellers, were lying, unknown or forgotten, on the shelves of libraries; but are now studied and edited with the greatest care. To Comm. de Rossi we owe the opening of this new and fruitful field of research, of which he has also thoroughly availed himself for his *Corpus* of early-Christian inscriptions.

At almost the same time another interesting branch of research was begun: the study of MS. descriptions of antiquities found and collected during the preceding three or four centuries, especially in Italy. This study has been developed on two lines; the first, and perhaps the more important, being the inventories of the classic antiquities forming the collections of distinguished patrons of art of the xv, xvi and xvii centuries, a truly inexhaustible mine of riches. This study has not merely a retrospective value: it often enables archæologists to detect and trace

back to the time, place, and circumstances of their discovery many works in our present collections of hitherto unknown provenance, whose value has thus been greatly enhanced.

A second, kindred and hardly less interesting, field for investigation was found in the accounts of discoveries and excavations in Italy, especially in Rome, of which a great part still remain inedited. Prof. Th. Schreiber's pamphlet is an important contribution to the knowledge of these documents. A careful study of the important text of Flaminio Vacca (*Berichte*, 1881, p. 43 seqq.), published in a careless and arbitrary manner by Fea (*Miscellanea filologica critica e antiquaria*, Rome, 1780-1836), led him to the discovery, in the libraries and archives of Rome and other Italian cities, of a great number of documents relating to archæological discoveries (in the Holy City), a part of which he here publishes. First in importance comes Francesco Valesio (1670-1742), whose shrinking and modest nature made him but little appreciated during his lifetime, but who industriously collected, in a diary of eleven tomes, notices of all the discoveries made from 1700 to 1742, the year of his death: a few specimens are published by Prof. Schreiber.¹ Card. Francesco Vettori (1710-1770) and Giovanni Bottari (1689-1775), both Florentines and devotees to archæology, corresponded regularly with the noted Francesco Gori (1691-1759), to whom they communicated all the important archæological news from Rome: many interesting extracts from these letters are here given. One of the most important of the Roman collections in the xvii cent. was the *Museo Puteano*, founded by Cassiano Dal Pozzo (1588-1657), and enlarged by his brother Carlo Antonio, who also kept an archæological diary of considerable interest and extent. Of quite a different character is Cipriani's (c. 1660) work on the restoration of the Pantheon, including a minute description of all the discoveries which this restoration led to, especially those made during the reconstruction of the system of drainage throughout the Campus Martius.

A. L. FROTHINGHAM, JR.

¹ Valesio speaks of the discovery, near S. Luigi dei Francesi, of a large column of Oriental granite, and notes that three similar columns, placed in the portico of the Pantheon, were found in the same place. Another of these columns was found a few years ago, when digging on this site for the obelisk which was thought by some, from a passage of the *Mercurio Errante*, to be buried at this spot.

ARCHÆOLOGICAL NEWS.

SUMMARY OF RECENT DISCOVERIES AND INVESTIGATIONS.

	Page.		Page.		Page.
ANNAM,	82	FRANCE,	95	MEXICO,	100
ASIA MINOR,	83	GERMANY,	96	RUSSIA,	97
BELGIUM,	96	GREAT BRITAIN,	97	TUNISIA,	81
CANADA,	99	GREECE,	84	TURKEY,	97
CHINA,	82	ITALY,	88	UNITED STATES,	98
EGYPT,	79	KYPROS,	83		

AFRICA.

EGYPT.

M. MASPERO left Cairo, January 10, on his annual archæological tour in Upper Egypt. The probable site of Amu, the city of Apis, the capital of the third nome of Lower Egypt has been discovered, at Kom-el-Husn, three hours south of Naukratis (Kom Gaief), by means of two inscriptions.—*Academy*, Jan. 2.

Stele of Amenophis III.—In a letter to the London *Academy*, dated Jan. 4, 1886, and written at Siût, Prof. A. H. Sayce mentions the discovery by him, close by the famous tomb of the Colossus, of a stele of Amenophis III, dated the 2nd(3?) day of the month Payni, in the first year of his reign, stating that on this day the quarries had been opened by the king under the patronage of Thoth, the lord of Eshmunén, in order that he might embellish “the house of the feast of the new year,” at Eshmunén. Amenophis is represented as standing before Thoth and Amun, to whom he is making an offering. The quarries, thus opened by Amenophis III, extend, from a point about a mile to the south of his stele, northwards to the cliffs above the ruins of Antinoöpolis. They include the line of quarries above Dêr Abu Hannes; and some belong to the age of the Ptolemies, others to Roman times.

The quarries above Dêr Abu Hannes, so full of remains of the early Coptic Church, have been carefully explored by Prof. Sayce, who is able to trace a history of the locality from the fourth century, when the hermits Victor, Kolluthos, Silvanus, Makarios, etc., took up their residence

in the old quarries, to the time when pilgrimages were made to their tombs, and two of the quarries were turned into churches. The frescos here and in one of the chapels are earlier than the Arab conquest; and the internal arrangement of the churches is full of interest.—*Academy*, Jan. 23.

EGYPT EXPLORATION FUND.—At the third annual meeting, held in London Oct. 28, 1885, Mr. John Evans, F. R. S., moved "that this meeting presents to the Fine Art Museum, of Boston, U. S. A.,—with sincere thanks to Rev. W. C. Winslow, Vice-President of the Egypt Exploration Fund,—a selection of antiquities discovered by Mr. Petrie and M. Naville." The motion was seconded by Miss Amelia B. Edwards, and thanks were given by Mr. Phelps, American Minister to England.—*Academy*, Nov. 7. These antiquities have recently arrived in Boston, and have already been placed in the Museum: a description of them may soon appear in the *JOURNAL*.

ABYDOS.—Prof. Maspero has cleared away the rubbish from the external walls of the temple of Seti on the southern and western sides.—*Academy*, Feb. 13.

CAIRO.—The famous Sphinx, which had been entirely covered up with about 20,000 cubic metres of sand, is being disengaged, and will be surrounded by a platform and a high wall to prevent further encroachments.—*Cour. de l'Art*, Feb. 26.

EKMEEN.—Prof. Sayce found here, in a tomb, three portrait figures, painted in the Roman costume, and about a foot and a half high, equal to the best paintings in the Pompeian collection at Naples.—*Academy*, Feb. 13.

KANOPOS.—Lieutenant Middlemass Bey has discovered in the ruins of Kanopos, near Abookeer, a well-preserved colossal red granite statue in a standing position, on the left of which is carved a pillar with the bust of a child. It has been uncovered, and Middlemass Bey has offered to transport it to Alexandria. As the hieroglyphs have not yet been deciphered, the identity of the statue has not been established.—*Egyptian Gazette*, Dec. 28; *Amer. Architect*, Feb. 20.

LUXOR.—The *Journal des Débats* of Dec. 6, 1885, gives a letter from M. Maspero, from which the *Courier de l'Art* makes the following extract: "J'ai de bonnes nouvelles de Louqsor. M. Scott Moncrieff a décidé le Conseil des Ministres à considérer le déblayement comme une œuvre d'utilité publique. Un commissaire a été nommé pour exproprier les quelques maisons encore debout dans l'enceinte du temple et pour en indemniser les propriétaires aux frais de l'État. L'argent qui me reste de la souscription organisée par le *Journal des Débats* sera donc suffisant pour achever le gros œuvre et pour payer notre travail de cette année.

Il ne restera plus qu'à décider les cheikhs de la mosquée à s'en aller, ce qui ne sera peut-être aussi difficile qu'on pourrait le croire à première vue."

The work of uncovering the great temple is proceeding rapidly: some colossal granite statues of Rameses II have been brought to light, one being of exceptional finish and workmanship.—*Academy*, Feb. 13.

NAUKRATIS.—This season's excavations at Naukratis have already attained important results both in respect to topography and archæology. A colossal statue has been found with the inscription *Aam*, thus confirming the identification of the place with the chief of the Libyan Nomes. The excavation of the Greek cemetery has brought to light little beyond terracotta coffin-ornaments. A burial-place for animals has been found. The temples of Aphrodite and the Dioscuri are not yet completely excavated. Four columns of the temple of the Dioscuri have been found. They are of unburnt clay adorned with painted cattle. Also parts of the incrustation of the walls have come to light. In the temple of Aphrodite several votive vases of local manufacture were found.—*Berl. phil. Woch.* Jan. 16.

The excavations here were continued by Mr. Gardner, when Mr. Petrie left for his work in the eastern part of the Delta. The work on the temple of Aphrodite has led to the discovery that the two temples, whose different levels were found, were built on the walls of a yet earlier structure, which must take its place among the primitive Greek temples of Naukratis. In a trench, cut here, were found the finest specimens of Naukratis ware yet known. The great altar of the earliest temple was found in place.

The cemetery has lately been yielding finds of great interest: it is full of graves of all periods, from the sixth to the third century B. C. The coffins are either of earthenware or wood. Mirrors and lamps have, in several cases, been found; small vases too in great number, but not many of fine work. Later work on the temple of Aphrodite has led to the finding, among the strata of archaic pottery, of numerous archaic statuettes of terracotta or soft stone, all of which seem to belong at latest to the beginning of the VI century B. C.—*Academy*, Jan. 30 and Feb. 6.

TUNISIA.

During their exploration in Tunisia, in March and April of 1885, MM. Reinach and Babelon (cf. *JOURNAL*, vol. I. p. 222) discovered the sites of four ancient cities: *Uccula*, at Aïn-Durat, 18 kil. N. W. of Medjez-el-Bab; *Municipium Septimum liberum Aulodes*, 10 kil. N. of Uccula; *Thibar*, at Henchir-Hammâmet near Mt. Gorra; *Thimbure*,

at Kourbaria, 12 kil. from Thibar, on the road to Teboursouk.—*Revue Archéologique*, Sept.—Oct., 1885, p. 238.

MESHERASFA.—*Christian inscriptions.*—Three Christian inscriptions have been copied here by M. Poinssot:—(1) *C. Vetti. Auni et . . . ei. soro|ribus . qui ante dormilerunt et . Iuliae maximae ma|tris ve valente . aci . . . dan. ccc|x et g III.* Its date is 369 of provincial era, corresponding to 408 A. D. The formula *qui ante* [me (or nos) in pace] *dormilerunt* is new. (2) *De Di et Xpi Umbrius Felix. mag|fecit votum reddidit Do preca|tur pro suis peccatis salvi|ficetur ap ccc|x et g III.* Date the same. (3) *D M S De Dei et Christi voluntas|pius Demetri una cum Domitias|sorens marti V Lucciosa fecerunt . . . |patri sui Donati s. a anno* M. de Villefosse proposes to read, at the beginning of the two latter inscriptions, *De donis Dei*. Another interesting inscription of the year 419 comes from Arbal: *D. M. | L. Eppidius Cassus | qui nos precessit in p(ace) | et viciit an(nos) p(hus) m(inus) LXXIII | Uxor una cum filio feclerunt an(no) p(rovinciae) CCCLXXX.* Observe the *D. M.* and the *tria nomina.*—*Bulletin Trim. des Antiq. Africaines*, Oct., pp. 188–91.

ASIA.

CHINA.

Roman Coins.—It is reported that the curious discovery has been made, in the province of Shang-Si, of a collection of Roman coins embracing not less than thirteen reigns, between Tiberius and Aurelian.—*Cour. de l'Art*, Feb. 5.

ANNAM.

In the last number of the *JOURNAL* (vol. I, p. 423) the importance of M. Aymonier's researches in Cambodia was signalized. The inscriptions copied by him in Annam are still more interesting. He brought back from Quinhu rubbings of about fifty inscriptions, taken in the provinces of Binh Thuan, Kanh Hoa, Phu Yen and Binh Dinh, all belonging to the ancient kingdom of Champa (known to Marco Polo as Ciampa or Cyamba), which extended as far as Tonkin, and from which the Annamites issued to conquer the whole east coast of the Indo-Chinese peninsula. Its civilization was derived from India, including the introduction of several forms of Brahmanism and Buddhism. Some of the inscriptions are in Sanskrit, some in an old form of the Cham language, which is still spoken in the province of Binh Chuan; and the characters used are the alphabet of Southern India. The names are given of twenty kings, all terminating in —*varman*, whose reigns extend from 706 to

1358 of the Saka era: i. e., from 784 to 1436 A. D. Other inscriptions, which are not dated and which are written in a character much more archaic, probably go back to the seventh century A. D., and possibly even earlier. The dated inscriptions are full of historical evidence relating to the wars waged by the kingdom of Champa with Java, with Cambodia, with China, and with Annam.—*Academy*, Jan. 2.

ASIA MINOR.

The results of the two expeditions sent out at the expense of Count Lanckoronski for the archæological exploration of Pamphylia and Pisidia are beginning to be known. The first visited and explored in 1884 especially the sites of Adalia, Sylleion, Aspendos and Side, Selge and Sagalassos. The second expedition visited, during last summer, Termessos, Kremna, Perge, Sagalassos, Aspendos and Side. The results have been, a far more perfect map of Pamphylia, reaching as far north as the lake of Ejerdin; careful plans of cities; numerous architectural surveys (e. g., theatres of Aspendos, Side, Perge, Termessos, Sagalassos; odeums, gymnasiums, public fountains, temples, tombs); about 300 new inscriptions, mostly Greek, some in early dialects and having traces of the early native language in the proper names. An important work embodying all these discoveries is about to be published.—*Berl. phil. Woch.*, Feb. 13.

EPHESOS.—It was known, from a Latin and Greek inscription published by Mr. Wood (*Ephesus*, Inscr. p. 2), that the wall surrounding the Augusteum was built in the year 6 B. C. under the proconsul C. Asinius Gallus. The following interesting inscription relating to it has recently come to light. 'Υπὲρ τῆς τοῦ [κυρίου ἡμῶν] | Αὐτοκράτορος Τ[ίτου Καί]σαρος ὑγιῆς καὶ διαμονῆς τῆς | 'Ρωμαίων ἡγεμονίας ἀποκατεστάθη τὸ βλαβὲν περιτέχισμα τοῦ Αἰγίουστῆου, διατάξαντος Μάρκου Οὐλπίου Τραϊανοῦ τοῦ ἀνθυπάτου, ἐπιμεληθέντος Πομπωνίου Βάσσου τοῦ πρεσβευ[τοῦ], τῆς ἐπιχορηγίας γενομένης ἐκ τῶν | [ἱερῶ]ν προσόδων, γραμματεύοντος Λου[χίου] 'Ερενίου Περεγρέιου ἀγροῦ τὸ β. This inscription tells us that the wall, having been damaged, was repaired under Titus by order of the proconsul M. Ulpius Trajanus (proconsul of Asia 79–80), father of the Emperor Trajan, through his legate Pomponius Bassus.—*Bulletin de Corresp. Hellénique*, Feb. 1886, p. 95.

MYTILENE.—The Turkish Governor, Fakry Bey, is engaged in clearing out the amphitheatre of Mytilene, which is said to have been the model of the Colosseum at Rome. He is also conducting archæological explorations on the island.—*Athenæum*, Jan. 16.

KYPROS.

The excavations carried on by Mr. Ohnefalsch Richter on the island of Kypros during 1885 have been of considerable importance, and,

though not yet fully published, a detailed report has been made, from Richter's materials, by M. Reinach in the *Revue Archéologique*. This report comprises all the work of Mr. Richter since 1880, but we will confine ourselves to that of 1885, at Idalion-Dali, Nikosia, and Tamassos.

IDALION-DALI.—The temple belongs to the Greco-Phœnician period, and must have been destroyed several centuries before our era. It comprised (1) the sanctuary; (2) the vestibule, containing the ex-votos; (3) the precinct for sacrifices. The sanctuary was consecrated to Aphrodite, and nearly all the statues found were female. Several hundred terracottas of many types were found: (1) praying female figures with raised arms, of Phœnician type (cf. figs. 376, 394-396, 403, of Perrot and Chipiez's third vol.); (2) female musicians; (3) priestesses, etc. All these are rudely made by hand. A *second class* of similar character are made partly from a mould and have hand-made arms and attributes added. A *third class* are entirely from a mould and represent especially the goddess in various aspects: the earliest represent her robed; and only where Phœnician influence was in the ascendant over the native was the undraped figure used. The most primitive terracottas of Dali are proto-Babylonian, then Assyrian, and finally Egyptian or Greco-Oriental; while the earliest statues in calcareous stone are Egyptian in style, those influenced by Phœnician art being later and inferior. The large terracottas are all richly colored, while the stone statues have only some red, and seldom yellow, coloring.

NIKOSIA.—*Necropolis of Hagia Paraskévi.*—Here were found most of the Kypriote vases now at Constantinople, and also a fine Assyro-Babylonian cylinder. Excavations were carried on here in August and September. Of the several hundred vases found only four are painted: all the others are without decoration, or have ornaments incised or in relief. The vases with reliefs form a most interesting group, which does not yet show any Phœnician influence and belongs to a very early age.

TAMASSOS.—Mr. Richter hopes to have discovered at *Hagios Janis tis Malluntias* (near Nikosia) the necropolis of Tamassos; gold jewelry, diadems, earrings, but no glass, have been found. Most of the vases are unpainted. The excavations are to continue.—SALOMON REINACH in the *Revue Archéologique*, 1885, II, pp. 340-364.

EUROPE.

GREECE.

ATHENS.—*Distribution of Antiquities.*—The Minister of Education has determined to distribute the antiquities stored in his office, as general

superintendent of antiquities. Some he will give to the Archæological Society, others to the Patissia Museum. There are sculptures, as well as terracottas, bronzes, and vases. The most famous piece is the so-called Lenormant Athena, discovered in 1859 west of the Pnyx. The collection has especial value for students, since the source of most of the pieces is officially established.—*Athenæum*, Nov. 21.

Museums.—Up to the present time antiquities have been distributed among a number of museums: (1) that on the Akropolis; (2) the Central or Patissia Museum; (3) the collection of the Archæological Society at the Polytechnikon. Beside these there were smaller collections in various places, and the collection of coins at the university. A new decree entirely changes this arrangement, and orders all antiquities, large and small, of every description, found in or brought to Athens, to be placed in the Central Museum, where they are to be chronologically arranged, and catalogues of them are to be printed. A select collection of casts from foreign museums is to make the series more complete. The only exception is made for antiquities (except inscriptions) found on the Akropolis: these are to be placed in the Museum of the Akropolis. An important change is the daily opening of all the museums; and an entrance-fee of 1 franc is charged, except on Saturdays and Sundays when the entrance is free. Archæologists, artists and students can obtain cards for free admittance.—*Athenæum*, Jan. 9.

The meeting of the Congress of Prehistoric Archæology and Anthropology, which was to take place in Athens this spring, has been definitely postponed. The Minister of Education, having been informed of this decision by the late Minister in Berlin M. Rangabé and Dr. Schliemann, has caused all preparations to be stopped.—*Athenæum*, Nov. 21.

AKROPOLIS.—*The recent discoveries.*—Toward the centre of the northern part of the Akropolis, between the Erechtheion and the Propylæia, the foundations of a building of unknown character had been partly uncovered by the French School some years ago. On Feb. 5th and 6th discoveries were made here of the greatest importance for the history of early Greek art. The most important are an entire series of painted statues of Athena belonging to the VI century B. C. Among other objects are several steles and three fluted columns with inscriptions giving several names of early sculptors. These discoveries have made a great sensation, and the *Pall Mall Gazette* by telegraph secured photographs, and obtained an article from the pen of Dr. Charles Waldstein, director of the Fitzwilliam Museum (Cambridge). Accounts have appeared in the *Ἀκρόπολις* of Athens, the *London Times* (March 12), the *Courrier de l'Art* (Feb. 26); but the most complete is given in this issue of the

JOURNAL (pp. 61-5) by Mr. W. Miller, a member of the American School of Classical studies in Athens.

A colossal bronze statue has been found on the Akropolis. It is a draped female figure holding up her right hand as if taking an oath. Also a terracotta slab, 55 mm. thick, 51 cm. wide and 385 mm. high, upon which, in high relief, is the figure of a man wearing a breastplate and helmet. Traces of color are preserved. Above the head of the man is a very early inscription ΚΑΛΟΞ.—*Berl. phil. Woch.* Jan. 2.

Painting of the v cent. B. C.—Recent excavations on the Akropolis have brought to light a painting representing a warrior with helmet, shield and spear, accompanied by an archaic inscription. It is said to date back to the v cent. B. C.—*Cour. de l'Art*, Feb. 5.

Early Temple of Athena.—Dr. Doerpfeld opposes the universally accepted theory, that the great temple of Athena in early times stood on the site of the present Parthenon and was destroyed by the Persians before it was finished. Between the Parthenon and the Erechtheion, and by the latter, is a plateau 45 met. long by 22 wide, in which are remains of walls. In these walls Doerpfeld recognizes the remains of this great early Temple of Athena destroyed by the Persians. It was built of poros-stone and was peripteral in form: it has resemblances to the old temple of Dionysos in Athens and to that of Eleusis. The Erechtheion was built partly over this temple.—*Mittheilungen*, 1885, III, p. 275-77.

Prof. Rhusopulos has found a cup, on the white ground of which is Antigone in the act of rendering the last duties to her brother Polynikes who lies on the ground. The head of Antigone is of great beauty and in perfect preservation.—*Cour. de l'Art*, Feb. 5; *Berl. phil. Woch.* Feb. 20.

Church of St. Dionysios.—Excavations have recently been made about the old Christian church of St. Dionysios the Areopagite. The purpose of the digging was to find the old floor of the building. Many graves have been laid bare, containing colored-glass vases and a fragment of an old Greek relief. Two Doric, and one Byzantine, columns were found.—*Athenæum*, Nov. 21.

BOIOTIA (PERDIKOVRYSI).—*Temple of Apollon Ptoos.*—The statue found here, and mentioned in the JOURNAL (vol. I, p. 433), is illustrated in the *Bull. de Corr. Hellén.* (Jan. 1886) by M. Holleaux. It is of a greyish-white marble, and is broken below the knee, the present height being 1.30 met. It represents a man standing erect in a fixed attitude and is of the same type as the so-called Apollos of Orchomenos, Thera, Tenea, Delos, etc. These statues are divided into two groups, the one headed by those of Thera and Tenea, the other by that of Orchomenos. This statue of Perdikovrysi belongs to the latter group, but marks a great progress over the Apollon of Orchomenos. An entire series of statues similar in type,

some more ancient, some later than the one described, have been found, all belonging to the early Theban school. The earliest fragment appears to be the copy of a wooden ξόανον, of which only the lower part remains, with a fragmentary votive inscription: . . . [ρ?]ον ἀνέθεκε τοῖ Ἀπόλλωνι τοῖ Πτοιαῖ| . . . στος ἐποίησε. The third line contained the name of the sculptor. It is probably a work of the VII cent. B. C.

In the February number of the *Bulletin*, M. Holleaux illustrates a remarkable archaic head in white marble, slightly larger than natural size, which, he thinks, belongs to the earliest period of stone sculpture in Boiotia, when the technique was the same as that of the sculptors in wood; dry, hard and angular. It is similar to, though perhaps a little later than, the Apollon of Orchomenos.

The excavations in Boiotia have lately brought to light two bronze lions of archaic style and in good preservation, as well as an archaic stone statue of Apollon, and some *boustrophedon* inscriptions from which it appears that near the temple of the Ptoian Apollon was a sanctuary of Athena.—*Berl. phil. Woch.* Jan. 2.

DELOS.—The important discoveries made here by the French School were mentioned in the last number of the *JOURNAL* (I, p. 433). In the last number of the *Bull. de Corr. Hellénique* (Feb. 1886, pp. 102–135) M. Durrbach published some very important decrees of the III and II centuries, found there in July and August. The first, in honor of the Rhodian Athenodoros, is a new proof of the close relations that existed, after Alexander, between the two islands of Rhodos and Delos: while others show the extent of the sovereignty of Rhodos over the archipelago and the littoral at the close of the III and during the II century. The fourth stele contains (1) a decree of Delos, according to the Makedonian Admetos a crown and two bronze statues; (2) another, specifying that one statue should be placed at Delos, the other at his birthplace, Thessaloniké; (3) a decree of Thessaloniké, in accordance with the preceding. According to the text, one of these statues was to be placed at Delos in the interior of the temenos of Apollon, by the side of the altar of Zeus Polieus: the base of this statue has been found, thus determining an interesting point of Delian topography.

EUBOIA.—G. Lämpakis, guardian of antiquities in Eretria and Chalkis, has made in his district some important discoveries, including several inscriptions and a life-size marble statue.—*Berl. phil. Woch.* Nov. 28.

KRETE.—The Greek Society of Herakleion has commenced excavating at the so-called *Zeus Grotto*, where an inscription has come to light which runs thus: Διὶ Ἰδαίῳ εὐχὴν Ἀστήρ Ἀλεξάνδρου.—*Athenæum*, Nov. 21.

ITALY.

PREHISTORIC AND CLASSICAL ANTIQUITIES.

ALLUMIERE.—To the N. of *Poggio della Pozza*, and near the esplanade where the tombs of the first iron age were found, there has come to light, part way down Monte Rovello, a stratum of débris including many fragments of pottery of the Villanova type: this shows the vicinity, at a very early period, of an important centre of population connected with a metal-foundry. The discovery was made by Mr. A. Klitsche de la Grange.—*Bull. d. Istituto*, Oct. 1885.

CASTIGLIONE DEL LAGO.—In a hall-tomb some very interesting objects have been found, which have been bought for the Museum of Florence: (1) a cinerary urn of black ware in the shape of a rectangular temple, in evident imitation of wooden Etruscan buildings; the triangular pediment is decorated at the summit with a ram's head; in the centre of the rib of the roof is a panther's head: (2) another cinerary urn, partly of Korinthian and partly of Etruscan type: (3-8) cups, kyathoi and skyphoi of various types, Italo-Pelasgic, Etruscan proper, and Greco-Oriental: (9-10) two proto-Korinthian vases, alabastron and aryballos: (11-17) bronzes: (18-19) objects in bone. These objects were placed in a main chamber cut in the tufa and in two accessory cells or niches. The first cinerary urn is of especial importance, as it fixes the period of the use of urns in the shape of temples. This period is that of the first relations of North Etruria with Magna Grecia and Greece (600-550 B. C.?).—*Not. d. Scavi*, 1885, p. 500-502.

CHIUSI.—In a tomb *a camera* were found several articles accompanying a female skeleton. Encircling its head was a gold crown of laurel ornamented with gold leaves: on each side is stamped a group of figures. In a wooden box were (1) a circular mirror with a graffito of Perseus cutting off Medusa's head in the presence of Minerva; (2) a situla or small bucket in cast bronze with figured reliefs—quite a rarity. It is similar to that found at Bolsena (now in the *Museo Etrusco*, Florence), and is decorated with three scenes. The probable date of these objects is the III century B. C.—*Bull. d. Istituto*, 1885, p. 200.

MONTE CAVO.—Three small objects of Egyptian workmanship were found here: (1) an amulet in blue majolica with the symbol Ded, to be placed around the neck of a mummy; (2) a figure of the demon Amset, and (3) one of the goddess Nephthys; both belonging to the toilet of a mummy. Dr. Erman considers them to be purely Egyptian works and not Phœnician imitations.—*Bull. d. Istituto*, 1885, p. 182.

ORVIETO.—The excavation of archaic tombs at the necropolis of the *Cannicella* has been continued, but without any very important results,

the finds being of a character similar to those of previous excavations.—*Not. d. Scavi*, Dec. 1885, p. 502.

PERUGIA.—Excavations have recently been undertaken at two points outside the city. Near the Porta del Bulagaio, were opened some tombs containing Roman objects, some anterior some posterior to the Hannibalic war. Near Monte Vile is a place called, from the numerous Etruscan tombs, *Le Grotte*. A single small *hypogeum* has been discovered intact, on whose tufa bench were found fourteen cinerary urns with short inscriptions showing them to belong to the Vibia family. The tomb seems to belong to the II cent. B. C. Several of the urns have bas-reliefs.—*Not. d. Scavi*, 1885, pp. 497–500.

PISA (near).—Under the fortress of Verruca was found a group of objects (*paalstab ad alette*) belonging probably to the pure bronze age; this is of all the more importance for Etruria that it proves the existence of an archæological stratum no traces of which had been furnished by the cemeteries or isolated tombs of that region.—*Bull. di Paletnologia Ital.* 1885, No. 11–12, p. 192.

POMPEII.—The excavations carried on from July to December were in reg. VIII, is. 2; and the most interesting building explored was the so-called *casa di Giuseppe II*, first discovered in 1767 and 1769. Several frescos, mostly in poor condition, were found.—*Not. d. Scavi*, 1885, pp. 532–539.

QUINTO FIORENTINO.—*Ancient tomb.*—Under the casino of a villa called *la Mula*, between five and six miles from Florence, exists a very early unique Etruscan tomb, noticed and described by Prof. Helbig. It consists of a circular construction, about 10 met. in diameter, surmounted by a cupola constructed in horizontal strata: out of this leads a corridor. Both are built of huge quadrangular blocks of calcareous stone fitted without cement and without any trace of tools (cf. similar tombs on gulf of Argos and at Menidi in Attika). It belongs to an advanced but somewhat early stage of Etruscan civilization, and is attributed by Helbig to the VI century B. C.—*Bull. d. Istituto*, 1885, pp. 193–199.

REMEDELLO (near Reggio d'Emilia).—These excavations have been continued from last year by the Signori Bandieri and Ruzzenenti. Towards the N. were found a group of Gallic tombs: towards the W. another group of 17 tombs of the *eneo-lithic* period.—*Bull. di Paletnologia Ital.* 1885, pp. 133–146.

RIVA SAN VITALE (Lake Lugano).—An inscription found here belongs to the class of mortuary foundations ordering periodical *rosalia*. It is thus restored by Prof. Mommsen: *D. M. Caji Romati C. f. . . . IIII viri i(ure) d(icundo) Como, . . a Martina cum filiis c. k. qui largitus est . . . primo Subinatibus [sextert. mille] a quibus petivit ut coitione sua memoriam*

matris eius per annos colant amaranto vel rosis profundant. Quod si neglexerint facere quadruplum eos heredis heredi. Romati ave.—Berl. phil. Woch. Jan. 30.

ROME.—*Inscriptions.*—The following important inscriptions are published by Lanciani in the *Notizie degli Scavi*:—

1. Of year 219 A. D., on a cippus; *Herculi Magusano | obredium Domini nostri | M. Aureli Antonini Pii | Felicis Aug Equites Singulares | Antoniniani ejus cives | Batavi sive Thraces adlecti | ex provincia Germania | inferiore votum solverunt | libentes merito III Kal. Oct | imp Dn Antonino Aug II et | Tineio sacerdote II cos.*

2. Of year 241 A. D., on a cippus; on the face, *I O M | Deo Sabadio sacrum | Julius Faustus Dec N̄ | Eq̄q̄ sing Dn̄ ex votum | posuit et conalarium | nomina inseruit | ex ala prima Darda prov Moesiae inf.* On the left side, a list of 13 names; on the right side: *Dedicata | III Non Aug | Domino N Gordiano Aug | II et Pompeiano cos.*

3. Of year 142 A. D., on a cippus; *Herculi et Genio | Imp. Titi Aeli Hadriani | Antonini Aug Pii P. P. | Veterani missi honesta | missione ex numero equitum | sing. aug. quorum nomina in | lateribus inscripta sunt laeti | libentes posuerunt statuum marm | cum sua basi Quadrato et Rufino cos, etc.* On the right and left sides, a list of 40 names of *equites singulares*.

4. Of year 141 A. D., on a cippus; *Jovi . optimo | maximo . Junoni | Minervae . Marti | Victoriae . Herculi | Fortunae . Mercurio | Felicitati . salutifatis | campestribus . Silvano | Apollini . Dianae . eponae | matribus . sulevis et | genio . sing . Aug | ceterisque . Dis . immortalib | veterani . missi | honesta . missione . ex . eodem | numero . ab . Imp . Hadriano | Antonino . Aug . P . P . P . | Priscino . et . Stloga . cōs | L . L . M . V . S.—Not. d. Scavi, Dec. 1885, p. 524.*

Another *Mithræum* has been found, on the site of the church of S. Caio, with traces of a fine fresco representing Mithras *tauroktonos* between the two genii of the solstices. This had been, at an early period, covered up by a similar group in stucco relief.—*Not. d. Scavi*, Dec. 1885, p. 527.

Horrea Galbae.—The building—docks or warehouses—of the *Horrea Galbae* has come to light. In plan it is identical with the docks of Ostia and Porto, consisting of a series of rectangular courts surrounded by wide porticos. It begins near the Arco S. Lazaro, and stretches along the plain as far as the foot of Monte Testaccio on one side, and the ruins of the Emporium on the other.—*Athenæum*, Jan. 23.

Mausoleum of Galba.—Below the basilica of San Paolo, and near the Emporium, has been discovered the tomb of the founder of the *horrea*, Sergius Sulpicius Galba, son of Sergius, consul in 646 u. c. The tomb is built in the severe style of the Republic (cf. tomb at Palazzuolo attrib. to

Corn. Scipio Hispalus). The inscription reads: *Ser · Sulpicius · Ser · F | Galba · Cos | Ped · Quadr · xxx* (Sergius Sulpicius Sergii filius Galba consul. Pedes quadrati xxx). The basement is built of large blocks of *peperino*, then follows a cornice of *pietra sperone*, upon which rises the rectangular body of the mausoleum built of reddish tufa. It is 20 ft. below the present level, and will be rebuilt in another place, and a square made around it.—*Athenæum*, Jan. 23; *Cour. de l'Art*, Feb. 26.

Mosaics.—On the Coelian Hill, where the military hospital is to stand, a discovery has been made of a very large and fine mosaic, measuring 12 by 8 metres. The mosaic seems to belong to the time of the last emperors, and must have formed the pavement of a room in some palace. It closely resembles the mosaic found in the Via Nazionale before the Palazzo Colonna, and now preserved in the Capitol. The design of the recently discovered mosaic is of rose-work surrounded by allegorical figures.—*Cour. de l'Art*, Dec. 4.

Some metres below the surface of the soil, in the Piazza della Cancelleria, during the demolition of the Palazzo Pagnoncelli, a fine mosaic was found, made of different colored marbles, and with designs of geometrical figures and other objects, in a good style. The archæologists who have seen it, say that it goes back to the first years of the Empire.—*Cour. de l'Art*, Oct. 30 and Nov. 6.

Terminal Stone.—In that part of the city which lies between the Aventine and the Tiber (S. Prati del Testaccio) extensive excavations are being made for municipal purposes. Here one of the terminal stones of the sacred area of Rome has been found. The stone—*cippus pomoerii*—belongs to the amplification made by Claudius A. D. 49, as is shown by the inscription.—*Athenæum*, Jan. 23.

TARQUINII-CORNETO.—No full account had as yet been given of the excavations carried on here with so much success since 1881. This lack has finally been supplied by a report made by Sig. A. Pasqui and published in the *Notizie degli Scavi*, 1885, Nov.–Dec. It will be necessary here only to add to the report which was given in the *JOURNAL* (vol. I. p. 440) the more recent investigations: our report ended Feb. 1. In March and April a number of tombs were opened which furnished objects of especial interest. They belong to various periods: some are archaic Etruscan, others yielded works of pure Greek style: among these were a large number of painted vases. More important is a memoir by Sig. Pasqui on the site of the ancient Tarquinii, which proves it to be not on the height called *Civita*, as had been supposed, but on the site of the modern Corneto.—Pasqui in *Not. d. Scavi*, 1885, pp. 505–524; Helbig in *Bull. d. Instituto*, Nov. 1885, pp. 209–222.

TERNI.—A necropolis of the first iron age has been discovered in the suburbs of Terni, at a place called *Sant' Agnese*. The tombs are for inhumation, and in them were found bronzes of the greatest interest, which are related to those of the well-known find of Piediluco, in the territory of Terni.—*Bull. di Paletnologia Ital.* 1885, p. 174.

VENICE: ISLAND OF TORCELLO.—An important discovery of objects belonging to the stone age, made by the director of the Museum of Torcello, Sig. Battaglini, shows this to have been a centre of population at that early period. These objects, over 140 in number, comprise "palchi" and poniards in bone of reindeer, deer and other ruminants; arms; necklaces; amulets; "mazzuoli"; edge-tools; etc.—*Bull. di Paletnologia Ital.* 1885, No. 11-12, pp. 190-191.

VETULONIA.—On p. 447 of vol. I of the JOURNAL, the archaic necropolis of the *Poggio della Guardia* was described. Since its discovery, however, another vast necropolis of the same Villanova type has been more thoroughly explored on the hill of Colonna, in an almost opposite direction to the first, of which it seems to be also the immediate continuation in point of time. Already, on p. 447, it had been noticed how, over the entire hill, there were scattered *tumuli* or *cuccumelle*, for burial by inhumation, belonging to the best Etruscan period. The greater number are ranged along a street of tombs to the N., which descends to the marsh of Castiglioni, skirting the necropolis of the *Poggio della Guardia*, towards the plain. This street, however, continues on the opposite side of the hill, towards the river *Aliena* or *Linca*, through a narrow gorge. In their midst, and on the *colle Baroncio*, exists the second archaic necropolis, similar in form to the first. The tombs are all for cremation, and are excavated in the rock in the form of wells: they are judged to be posterior to those of the *Poggio della Guardia* on account of the greater accuracy of construction, and the greater abundance and variety of the contents. A notable peculiarity is the superposition of one well over another; but this does not imply separate strata of different ages. Often the tombs were placed so close together that the upright slab which formed one of the walls served also the same purpose for the neighboring tomb.—The *cuccumella del Diavolino* is one of the largest *tumuli* near Colonna, being 14 met. high, and 260 in circumference: excavations resulted in the discovery, along a line of 18 met., of a horizontal terrace of great slabs of granite in a double row.—Further excavations have been made in the necropolis of *Poggia della Guardia*, without adding anything to what was already known.—*Not. d. Scavi*, 1885, p. 398 sqq.

CHRISTIAN ANTIQUITIES OF ITALY.

FLORENCE.—*Church of Santa Trinità*.—With the consent of the Minister of Public Instruction, Professor Cosimo Conti has made several attempts to uncover the mediæval frescos on the walls of this church. So far Prof. Conti has proved that all the exterior lunettes of the family chapels, as well as numerous portions of the interior of these chapels, had historical, religious, and ornamental decoration.—*Cour. de l'Art*, Dec. 4.

ROME.—*Catacomb of Santa Felicità*.—Some years ago Com. de Rossi identified some subterranean excavated under the Vigna Carcano, one mile outside of Rome on the Via Salaria, as the cemetery of Felicità, martyred under Marcus Aurelius. This has just now been confirmed by the discovery of important works: a hall or crypt containing a painting of the VII cent. in Byzantine style representing, above, the half-figure of the Saviour blessing the figures beneath. In the centre is Sta Felicità with a nimbus; on her left are four of her sons (inscriptions *Philippus, Martialis*), and on her right the other three (insc. *Januarius, Silvanus*): all are crowned, and the scene represents their glorification. This crypt opens on the right, about half-way down, of an ancient stairway, on each side of which are the usual rows of loculi and the diverging galleries. An unusually large number of terracotta lamps were found. At the bottom of the staircase was a species of well, surmounted by an arch containing traces of paintings, which seems to have been used by the early Christians for baptism by immersion: such a baptistery is of very rare occurrence in the catacombs. The inscriptions as yet found are not of special importance. Excavations are prevented by the building placed over the cemetery.—Orazio Marucchi in the *Nuova Antologia*, Feb. 1, pp. 409–421.

Apse of St. John Lateran.—The new apse is nearly finished, and the solemn opening is to take place on the fête-day of John the Baptist. The frescos and the decoration of the ceiling are being finished. All the old mosaics have been replaced in the new apse.—*Cour. de l'Art*, March 12. [When it was decided, five or six years ago, to lengthen the choir of the basilica and build a new apse, the important mosaics of the V and XIII centuries which filled the old apse, in the semi-dome and between the windows, had to be removed. Before doing this an exact tracing was made of them, cube by cube, and was then colored in fac-simile. This has made the reconstitution of the mosaics a matter of comparative ease to the skilled mosaicists of the *Fabbrica* of St. Peter. Their archæological value, however, has been much diminished, as the different restorations and changes they have undergone can no longer be traced; but it is to be hoped that a careful study of this kind was made before the removal. ED.]

VANDALISM IN ROME.—*Ara-Cœli.*—Among the buildings on the Capitol to be destroyed by the preliminary works for the national monument of Victor Emmanuel, are the convent of Ara-Cœli, and the tower of Paul III. The latter building is interesting as one of the few remaining monuments of Rome as it was before the Florentine and barocco schools changed the entire appearance of the city.—*Cour. de l'Art*, Nov. 27.

Church of S. Stefano sopra Cæco.—This early church, which preserves its basilical form, consists of three naves supported by fourteen antique columns, and contains a fresco by Pierino del Vaga, is to be destroyed and replaced by a casern.—*Revue de l'Art Chrétien*, 1885, p. 553.

VENICE.—The scaffolds have just been removed from the Loggetta di Sansovino, at the foot of the Campanile, in the piazza of San Marco. The restoration of the building has been going on for several years, and has caused fierce criticism. It is said that the work is extremely well done, the ancient fragments being put into place, and the gaps carefully repaired.—*Cour. de l'Art*, Nov. 6.

The paving of the piazza of San Marco having to be renewed, the opportunity has been taken to upturn the soil, in order to discover the original dimensions of the square, and to find, if possible, traces of the walls of the church of San Geminiano, and of the wall built in 900 A. D. to resist the pirates.—*Cour. de l'Art*, Dec. 4.

Last July a hole was dug at the N. W. angle of the campanile, with the object of finding out the materials and construction of the foundations. At the depth of 2 ft. 5 in. an older pavement of "herring-bone" brickwork was found. This is the pavement represented in Gentile Bellini's picture of the square, painted just before 1500 A. D. The campanile, which is of brick, rests on a plinth of stonework, with three offsets or footings, visible above the level of the present piazza. Two other offsets are hidden between the present and the old pavement. Below this once-visible plinth are seven courses of massive stone blocks, finishing at the bottom with a course nearly 3 ft. thick, which rests on a double layer of stout oak planks, laid crosswise. This oaken floor rests on a mass of closely driven piles, formed of posts only about eight inches in diameter, not of oak, but of the soft white poplar which grows near the Venetian lagunes. The area of the wooden platform is only a few inches larger than that of the stone base of the campanile, and depends for its solidity on the extreme density of the clay into which the piles are driven.

Signor Giacomo Boni, who has charge of the works, says that at an early period the Venetians used local woods, but, later on, the fine conifers from the lower Alps came into use. The foundations of the Doge's palace, built in the XIV cent., rest on a double layer of red-larch-wood from Cadore. It is noticeable that the foundation of the Doge's palace

does not rest on piles, but the weight of the building is distributed by projecting footings.—*Academy*, Nov. 7.

Mr. C. H. Blackall, who made the above examination, published the results of his work, in detail and with illustrations, in the *American Architect*, vol. xviii. No 505, pp. 101-2.

FRANCE.

ANTIBES.—*Cathedral.*—M. Félon, while restoring a chapel, rediscovered a series of frescos representing, in seventeen compartments, the Life of Christ. On the principal composition, which is a masterpiece, he found the date 1315. The others of greatest merit are the Garden of Olives, the Bearing of the Cross, the Ascension, Pentecost, the Assumption, and Calvary. They appear to be the work of some Italian master and his pupils, as the execution is unequal.—*Revue de l'Art Chrétien*, 1885, p. 554.

ARTRES.—*Merovingian Jewelry.*—At the sitting of the *Acad. des Insc. et Belles-Lettres* held Jan. 29, M. Ch. Robert described the contents of a Merovingian tomb of a woman, composed of vases, objects for the toilet, and jewelry, of which the latter only were preserved. They are among the most curious specimens of the kind of jewelry which the Franks and Goths did not borrow from the Romans, and which was probably of Oriental origin.—*Temps*, Feb. 1.

MOINT (Loire).—A treasure of Roman objects has been found in a vase. It includes 1285 coins of the reign of Trajan, lamps, rings, and other precious objects. Remains of ancient substructures have also been discovered on the site. See the report of M. Robert at the sitting of the *Acad. des Insc. et Belles-Lettres* on Feb. 19.—*Cour. de l'Art*, Feb. 26.

PARIS.—*Amphitheatre.*—Some time since, a portion of ground at the corner of the Rue Monge and the Rue Navarre was purchased by the Paris municipality, as this site was known to be above a part of the ancient amphitheatre of Lutetia. Excavations have thus far disclosed an arena girt by a *podium* about 2 met. high, from which rise the usual tiers of seats. Within the *podium*, and concentric therewith, are traces of a second, low but very thick, wall, which may have enabled the circus to be used for sea-fights. Among the débris are portions of seats on which are inscribed the names of personages for whom they were reserved. It is expected that the land which covers the rest of the ruin will also be bought.—*Athenæum*, Jan. 16.

Cluny Museum.—One of the inner courts of the Museum has been transformed into an exhibition-hall by the addition of a glass roof. The works to be exhibited are already being arranged, and the hall will be open in June.—*Cour. de l'Art*, Feb. 19.

BELGIUM.

MALDEGEM (near) (East Flanders).—The *Messenger des sciences historiques* announces the discovery, during excavations made to find the ruins of the Abbey of Zoetendaele (destroyed in XVI cent.), of the foundations of an early mediæval castle (27 by 12 met.). At one corner was a triangular tower, a very rare feature in the military architecture of Belgium.—*Bull. Monumental*, 1885, p. 545.

JOURNAL.—*Cathedral church of St. Nicholas*.—See vol. I. p. 456 of the JOURNAL. The restoration is being continued, and has brought to light, among other things, (1) a sculptured sepulchral slab of 1380, (2) a sculptured relief of Baudouin d'Hainin († 1420), and (3) a polychromatic relief of the entire family of Arnould de Gueldres at the feet of the Virgin, dating from 1560.—*Revue de l'Art Chrétien*, 1885, p. 553.

GERMANY.

Roman remains.—In digging the canal along the Main, remains have been found of Roman bridges near Gross-Crotzenburg and Nied. Also, a Roman grave near Niederrad.—*Berl. phil. Woch.* Jan. 9.

ABUSINA.—See vol. I. p. 247 of JOURNAL. Extensive excavation by the Rev. W. Schreiner, the happy discoverer of this great Roman fortress at Eining on the Danube, has laid bare, not only the military works and buildings, but also over seventy large civil structures situated between the northern and southern *Castra*. The fine fortifications of the southern camp, its walled escarps and towers, its praetorium and gates, the double circle of forts around the town, justify Mr. Schreiner's opinion that Abusina was the Paris of Roman South-East Germany. It was thrice taken, but always rebuilt. The county of Lower Bavaria has undertaken to preserve the ruins, and, wherever necessary, has acquired the sites on which they stand. The collections resulting from the discovery embrace some 2500 specimens,—pottery; bone-carvings; armor; and ornaments in bronze, silver, gold, and precious stones.—Munich *Fremdenblatt*, Nov. 15.

BONN.—In the Roman Castrum has been found a beautiful bronze statuette, of the best period of Roman art, representing a winged Victory standing on the globe. It has been purchased by Prof. Aus'm Weerth.—*Berl. phil. Woch.* Jan. 30.

CAMPODUNUM.—The identity of Kempten, Bavaria, with this Keltic-Roman town is accepted. The exact situation of the *castrum* was not known before the discovery, last summer, of a group of ruins 64 by 125 metres. The bricks bear no legionary stamp. The southern half of the group consists of a great hall (27 by 16 m.) flanked by smaller rooms. Its semi-circular projection suggests the basilica. The central hall in the

northern portion has a rectangular projection, and is flanked by larger apartments. A suite of fourteen chambers runs along the western side of the whole edifice, which may have been a praetorial residence.—*Allgemeine Zeitung*, Oct. 26.

TURKEY.

CONSTANTINOPLE.—The Trojan pottery and other treasures in the museum of Constantinople have been bought from the Turkish government for Dr. Schliemann, who proposes to present them to the Schliemann museum in Berlin.—*Berl. phil. Woch.* Nov. 14.

RUSSIA.

KIEW.—A prehistoric tomb belonging to the cut-stone age has been found near Gloubotphigu. The Russian archaeologists, professors Feofeltow and Kiboltchitch, intend to report on it to the Society of Naturalists.—*Cour. de l'Art*, Feb. 5.

GREAT BRITAIN.

ENGLAND.—Mr. A. S. MURRAY has succeeded Prof. C. T. Newton as Director of Greek and Roman antiquities at the British Museum. The directorship of Oriental antiquities, vacated a short time ago by the death of Mr. S. Birch, has been given to M. LE PAGE RENOUF. Mr. Sidney Colvin has resigned the Slade professorship, and Mr. I. H. MIDDLETON has been elected in his place.—*Berl. phil. Woch.* Feb. 27.

PROF. C. T. NEWTON is delivering during the current term at University College (London) two courses of lectures: (1) on "Greek Inscriptions," with Dittenberger's *Sylloge Insc. Graec.* and Hick's *Man. of Greek Inscr.* for his text-books; and (2) on "Greek myths illustrated by fictile vases and other monuments." These lectures began on January 8, and are bi-monthly.—*Academy*, Jan. 9.

DEERHURST.—*Saxon Chapel*.—At a short distance from the well-known Saxon parish church, an ancient chapel has been found. The outline of the walls has been traced, and the building found to have a small nave and chancel of very early work. A dedication-stone of the altar to the Holy Trinity has been found, and Mr. Birch, who announced the discovery at a meeting of the British Archæological Association, points out the resemblance to the inscription in the Ashmolean Museum recording the dedication of a church at Déerhurst by Earl Odda in 1056.—*Athenæum*, Nov. 28.

WHITLEY CASTLE AND SOUTH SHIELDS.—*Roman Inscriptions*.—Mr. W. Thompson Watkin reports the discovery of two Roman inscriptions. The first was found at the Roman station of Whitley Castle, near Alston.

Only the right-hand lower corner of the tablet remains. On it is the following:

°S III VI | O · LEG · | S · PR · BR ·

Mr. Watkin fills out the inscription as follows: *co(n)s(ul) III. Vi(ri)o (Lup)o Leg(ato) Aug(usti) co(n)s(ulari) Pr(ovinciae) Br(itanniae)*. *Sub* must be understood before *Virio*. The third consulate of Septimius Severus was A. D. 202; and, as he was never consul a fourth time, the numeral *III* followed the abbreviation *cos* in all inscriptions in which his name occurred after that date, and in which his consulships are mentioned. Virius Lupus was legate in Britain, as we know from other sources, in 197 A. D.; but we find L. Alfenius Senecio holding that title in 205 A. D. Mr. Watkin thinks that from this inscription it may be gathered that Lupus was in the island from 197 to at least 202.

The other inscription was on a small altar, 2 ft. 3 in. high, found at South Shields [discovered during sewerage operations on the site of the Roman *castrum*, and just within the eastern rampart.—*Athenæum*, Oct. 24]. It is inscribed on the front:

D · ESCVLAP · | P · VIBOLEIVS | SECVNDVS | ARAM | D · D ·

There is a *præfericulum* sculptured on the right side, and on the left a *patera*. The expansion is *D(eo) Esculap(io)*. *P(ublius) Viboleius Secundus, Aram D(onum) D(at)*. It is the fifth dedication to Aesculapius found in Britain, so far as is recorded.—*Academy*, Nov. 7.

AMERICA.

UNITED STATES.

CINCINNATI.—*Museum and Art-School.*—In 1880, Mr. Ch. W. West offered \$150,000 for the erection of a Museum, and this sum was increased to \$316,000 by public subscription. The building was commenced in 1882, and is now completed: it will be opened in the Spring. It has an income of \$10,500 from a further donation of \$150,000 from Mr. West. An Art-School will soon be erected in connection with the Museum: Mr. Sinton and Mr. Springer have given \$95,000 for the building, and Mr. Longworth has left \$371,000, the income of which, about \$15,000, will be devoted to its support.—*Amer. Architect*, Jan. 9.

WASHINGTON.—*National Museum.*—A notable event in the history of the Museum is the opening to the public of the hall of Aboriginal-American pottery. The collection is unsurpassed in the number and beauty of its specimens. It embraces upwards of 20,000 pieces, about one-half of which will be placed on exhibition. The great wall-case,

nine feet in height and with a total length of two hundred feet, is devoted to the handsome wares of the modern Pueblo Indians. A central case, of the same height and twelve feet square, contains the ancient Pueblo series, chronologically arranged. Beginning with the most archaic form on the lower tier of shelves, we ascend through the three succeeding groups to the earlier historic forms at the top. The remaining floor-space will accommodate about forty of the standard Museum cases, a number of which are now completed. These cases will contain selected series of the various groups of ancient ware. The Mississippi valley, Mexico, Costa Rica, Chèriqui, Peru, and Brazil, are exceptionally well represented. The Curator, W. H. Holmes, is engaged on the preparation of an exhaustive work upon native American keramics, for which upwards of one thousand engravings are already made.

The fine series of models of ancient Pueblo ruins prepared for the New Orleans exhibition by the Bureau of Ethnology is now placed in the hall of Mexican antiquities, where it forms a most attractive and instructive feature.

Bureau of Ethnology.—A valuable collection of relics from a mound in Eastern Tennessee has recently been acquired by Dr. Thomas' section of the Bureau. Most interesting are a number of engraved shell gorgets. The designs are similar in type to those published in the *Second Annual Report* of the Bureau, but exhibit new features in the treatment of birds and of bird-men. The conception and execution of the figures is so superior as to awaken the suspicion that they were made by the ancient Mexicans or by early European traders in imitation of native work, but there is no feature in the designs themselves to give support to such an hypothesis.

Dr. Washington Matthews' studies of the mythologic sand-paintings of the Navajoes, are among the most novel and important contributions recently made to our knowledge of aboriginal art. Much additional matter was obtained during the fall months by Mr. and Mrs. James Stevenson, who were given free access to the nine-days' ceremonies of the *ye-bi-chai* dance, a favor never before accorded to strangers. The numerous duties of the Navajo pantheon with all their symbols and paraphernalia are delineated, and with great skill, in brilliantly colored sands upon the floors of the sacred enclosures. [*Communicated by W. H. Holmes.*]

CANADA.

Manitoba Mounds.—The exploration of the ancient mounds in Manitoba promises interesting results. It appears, from surveys made during the past summer, that the northern limits of the mound-builders lie

beyond the Red River of the North. Along this river and Lake Winnipeg, mounds were found identical in structure with the famous ones of the Ohio and Mississippi valleys.—*Science*, Feb. 26.

MEXICO.

Former visitors to the City of Mexico and archæologists will be glad to know that the great Calendar-stone has been removed from the site it occupied for the period of 95 years, against the west wall of the Cathedral, and is now under shelter in the large new hall on the ground-floor of the National Museum. The monoliths commonly known as the "Sacrificial Stone" and the goddess "Teoyasmiqui" have been taken from the open courtyard of the building and also placed in the hall. From Mazatlan comes the news that the publication of *Los Aztecas* by the Rev. Pbro. Dámas. Sotomayor is suspended on account of certain difficulties in having the plates for illustration made there. The printing of the text, however, is in active progress. [*Communicated by Mrs. Z. Nuttall from private correspondence.*]

A. L. FROTHINGHAM, JR.

A. R. MARSH.

H. N. FOWLER.

SUMMARIES OF PERIODICALS.

ARCHÄOLOGISCHE ZEITUNG. 1885. No. 3.—1. FR. MARX, *A new Ares-myth.* By comparison of a cista from Palestrina (*Mon. dell' Inst.* IX. tav. LVIII; *Annali*, 1873, p. 221 seqq.) with two Etruscan mirrors (Gerhard, *Etr. Spiegel* II. taf. CLXVI and III. 2, taf. CCLVII, B), it is shown that a myth existed which made Ares the son of Athena and a mortal. According to one version (that of the mirrors) she gave birth to triplets (hence Tritogeneia?), according to another to Ares alone. To make him immortal she anointed him with ambrosia, and dipped him in the water of the Styx, which was brought in a large vase. This bath is represented on the monuments discussed. The analogy of the myth of Achilles is evident.—2. P. J. MEIER, *Contributions to the List of Greek Vases with Artists' Signatures* (pls. 10, 11). Cf. *Arch. Ztg.* 1884, p. 237. To the vases with the inscription *Λεαγρος καλός* (Klein, *Meistersignaturen*, p. 57) is added (9 b) one from Orvieto, in the collection Bourguignon at Naples (pl. 10). A naked satyr is represented in red upon a black ground. We read the inscriptions, *Ἀθηνόδοτος καλός*, *Λεαγρος καλός*, and a third *καλός*. The work is ascribed to Euphronios (Klein, p. 59), as is also vase No. 515 of the Munich collection (pl. 11), which is ornamented with scenes from the palaestra, in red upon a black ground. This vase bears the inscription *ὁ παῖς καλός* twice, *Ναίει καλός* once. The letters on both these vases are, of course, of the Attic alphabet.—3. F. WINTER, *Vases with Outline Drawings* (pl. 12). On plate 12 are published the paintings from (1) a vase in Bonn, (2) a vase in the British Museum, formerly No. 392 of the Hamilton collection, (3) a marble stele in Berlin (Conze, *Verzeichniss der antiken Sculpturen*, 734). As cuts in the text, three heads are published from vases in the British Museum. By comparison of these drawings and others which are mentioned, it is shown that the transition from the vases with black figures to those with red figures was effected in part by an intermediate stage in which drawings were made in outline. These drawings were mostly mere heads, and are found mainly upon shallow dishes (as well as upon white lekythoi). The passage in Pliny (N. H. xxxv. 56) about Kimon of Kleonai is discussed.—4. W. M. RAMSAY, *Bas-relief of Ibriz* (pl. 13). A more accurate publication and description is given of a bas-relief at Ibriz in the Taurus mountains, already published in Ritter's *Kleinasion*, vol. I.

pl. 3; and in Davis' *Life in Asiatic Turkey*, p. 252. The relief is of the class commonly called Hittite. It represents a priest worshipping the god of nature. Beside the figures are hieroglyphs.—5. K. WERNICKE, *Life of a Child in representations on sarcophagi* (pl. 14). Reliefs from two sarcophagi in the Louvre are published (Fröhner No. 397 = Museo Campana No. 324, and the sarcophagus of M. Cornelius Statius). With these seventeen other reliefs are compared, and the development of the scenes depicted upon them is explained.—6. A. FURTWÄNGLER, *Prometheus*. An intaglio upon a scarabæus in Odessa represents Hephaistos chaining Prometheus to the rock. This is published as a vignette heading the text. Its relation to other representations of Prometheus bound is discussed.—7. MISCELLANIES. K. WERNICKE, *The Childhood of Zeus*. Cuts are given of the ends of a sarcophagus in the Uffizi (Dütschke, III. 377). The reliefs are said to represent the childhood of Zeus, and this interpretation is supported by mention of other similar representations.—A. MICHAELIS, *Theseus or Jason?* In opposition to Purgold (*Bullettino*, 1879, p. 76; *Arch. Ztg.* 1883, p. 163), Robert (*Arch. Ztg.* 1883, p. 261), and Lehnerdt (*Arch. Ztg.* 1884, p. 117), Michaelis maintains that he was right (*Arch. Ztg.* 1877, p. 75), in explaining the painting of a vase in St. Petersburg (No. 2012; *Antiq. du Bosph. Cimm.* pl. 63 a, 2) as Theseus contending with the Marathonian bull in presence of Medeia.—8. REPORTS. *Acquisitions of the British Museum in the year 1884.* H. N. FOWLER.

BULLETTINO DI ARCHEOLOGIA CRISTIANA. Rome, 1884-5. Nos. 2, 3.—G. B. DE ROSSI, *Recent Explorations on the lower level of the cemetery of Priscilla*. In 1880 (*Bull.* pp. 5-54) the writer demonstrated that the principal crypts of the cemetery were, to all appearance, on two levels; the more ancient, on the upper one, the more recent (contemp. w. Diocletian), on the lower. The lower story, in which the excavations were made last winter, is constructed, with extraordinary regularity, of a network of many parallel galleries intersecting, at right angles, a very long central ambulacrum which is sustained at regular intervals by a series of arches. Boldetti visited this part of the cemetery, and published fifteen inscriptions found there. De Rossi publishes 21, which he considers earlier than the IV century. A comparative study of the inscriptions of the upper story, belonging to the earliest period of Christianity in Rome, and those of the lower story, will yield most important chronological results. A fragment found completes the following important funeral epitaph of Agape, anterior to the IV century: *Dixit et hoc Pater omnipotens cum (pelleret Adam) | De terra sumptus terrae traderis hu(mandus). | Sic nobis sita filia e(s)t Agape Christ(umque secuta?) | Bis denos septemque annos eme(n)sa (resurget): | Haec illi per Christum fuerat sic (plena*

senectus).—*Eucharis est mater, Pius et pater est (mi). | Vos precor o fratres, orare huc quando veni(tis) | Et precibus totis Patrem Natumque rogatis, | Sit vestrae mentis Agapae carae meminisse, | Ut Deus omnipotens Agapen in saecula servet.* A chapter is devoted to the use of the name Petrus in the early inscriptions of this catacomb.—*Fragment of a glass adorned with biblical scenes in intaglio* (pl. v-vi). This was found in 1884 on the Esquiline (Cf. Lanciani, in *Not. d. Scavi*, 1884, p. 220; and *Bull. Arch. Com.* 1884, p. 272). The subjects appear to be (1) the sacrifice of Isaac, (2) Daniel between the lions, (3) the Israelites guided by the cloud. This rare kind of work in glass has been lately several times illustrated (De Rossi, *Bull.* 1868, p. 36; 1873, 141; 1874, 153; 1876, 1; 1878, 147. H. de Villefosse, *Rev. Arch.* 1874, pp. 281-289. Especially the dissertation by Padre L. Bruzza, *Bull. Arch. Com.* 1882, pp. 180-190).—*Christian Sepulchral inscriptions recently discovered in Capua* (pl. iv). Of interest is the following epitaph: (*h*)ic requiescit *Sucessa c(larissimae) m(emoriae) f(emina) (i)n somno pacis cum (s)igno fidei quae vixit ann(os) (plus) m(inus) LXXVII d(e)posita die xvii Kal* The formula “*cum signo fidei*” is unique.—*The bishop Augustine and his mother Felicita, martyrs under Decius, and their records and monuments in Capua.* This paper deals mainly with the interesting mosaics of the apse and cupola of the church of S. Prisco at Capua, which were destroyed in 1766, but of which some drawings remain (Monaco, *Sanctuarium Capuanum*, 1630, p. 1321; Granata, *St. d. Chiesa di Capua*, II. p. 67; and esp. Garrucci, *St. dell' Arte Crist.*, tav. 256, 257). The personages portrayed in them, De Rossi shows to have been, not, as Garrucci thought, victims of the Vandal persecution in the v century, but early martyrs venerated by the Church in Capua, whose bodies doubtless rested in the cemetery of S. Prisco, and who were honored in the basilica erected afterwards on the site. The writer considers that the characteristics of the mosaic agree better with the v than with the vi century.

A. L. F., JR.

BULLETTINO DELLA COMMISSIONE ARCHEOLOGICA COMUNALE DI ROMA. 1885. No. 2, Apr.-June.—W. HENZEN, *An inscription found near Monte Testaccio* (pl. vi). Erected by a *collegium salutare* of persons belonging to the imperial household and living in the *predi Galbani*, which appear to have been imperial property.—G. B. DE ROSSI, *Fragment of a glass adorned with biblical scenes in intaglio* (pl. vii. viii). See, above, the analysis of *Bull. di Arch. Crist.*—D. GNOLI, *On some unknown or little-known topographical plans of Rome* (pls. ix-xv). The writer is forming in the National Library a collection of plans of Rome, which already amount to over 150. He here publishes some of the earliest and rarest: that by Leon Battista Alberti, the first printed plan

(1490); that of Münter's *Cosmografia Universale*; and finally a part of the great plan made under Paul V, and forming an album of 48 sheets.—C. L. VISCONTI, *A plan of Rome in the XIV century published by M. Eugène Müntz* (pl. XVI). See analysis of M. Müntz's article, *JOURNAL*, I. p. 473. The writer identifies a number of buildings on this plan.

No. 3, July-Sept.—L. BORSARI, *Topographical observations on the IX Region, CIRCUS FLAMINIUS* (pl. XVII). The writer seeks to demonstrate that the IX region as understood by present authorities is too much confined, and that, "besides extending itself further to the N., i. e. up to the Piazza del Popolo, it must also have reached out on the right, thus finding certain and natural limits in the slopes of the Pincian hill, as it had on the South in those of the Capitoline and Quirinal.—R. LANCIANI, *Supplement to the VI volume of the Corpus Inscriptionum Latinarum*.—G. GATTI, *A fragment of inscription containing the Lex horreorum* (pl. XVIII). Only the right half of this important monument remains: the writer attributes it to the Emp. Hadrian, and reads it as follows, with a tentative restoration:

in · hORREIS | imp · hadriani · cAESARIS · AVG · LOC |
cellae · frumentar · et · uinAR · ARMARIA · ET · LOCA |
cum · operis · cellARAR · EX · HAC · DIE · ET · EX · | idib ·
dec · primis · LEX HORREORVM

quisquis in his horreis conductum habet cellam armarium aliudve · QVID · ANTE · IDVS · DEC · PENSIONE · SOLVTA · RENVNTIET · QVI · NON · | renuntiauerit et cum horreario de renouanda locatione pro INSEQVENTE · ANNO · NON · TRANSEGERIT · TANTI · HABEBIT · QVANTI · EIVS · GENER · | res eo anno in his horreis locari solent si modo alii locatum NON · ERIT · ¶ QVISQVIS · IN · HIS · HORREIS · CONDVCTVM · HABET · ELOCANDI · ET · | utendum dandi ius non habebit si elocauerit uel utendum dederit ei custodia · NON · PRAESTABITVR ¶ QVAE · IN · HIS · HORREIS · INVECTA · INLATA | importata fuerint horreario pignori erunt pro pensionibus de quibus · SATIS · EI · fact · non · fuerit · ¶ QVISQVIS · IN · HIS · HORREIS · CONDVCTVM · HABET · ET · SVA | impensa refecer · ornaver · tollendi quod adiecit ius non habebit nisi ei data FVER · VENIA ¶ quisqvis · IN · HIS · HORREIS · CONDVCT · HABET · PENSIONE · SOLVTA · CHIROGR · | horrearii sibi dari curet et res inlatas efferat si post impletum conductionis annum · HORREVM · SVASQ · RES · RELIQUER · ET · CVS · TODI · NON · ADSIGNAVER · HORREARIVS · SINE · CVLPA · ERIT ·

This is an important document for an acquaintance with the system of public granaries in imperial times.—R. BUTI, *On some Subterraneans discovered in the Gardens of Sallust* (pl. XIX-XXI).

A. L. F., JR.

BULLETIN DE CORRESPONDANCE HELLÉNIQUE. Athens and Paris, 1885. **May-Nov.**—G. COUSIN and F. DURRBACH, *Inscriptions from Nemea*. Noteworthy, among the inscriptions found, are documents showing (1) the survival, in the III century B. C., of the ancient Argive tribes Hylleis, Dymanes, Pamphyloi, and Hyrnathioi; (2) the existence of a popular assembly called *haliaia* in a Dorian state; (3) the Doric form of the acc. plur. (τῶν ἐνβάταν) now become familiar through the code of Gortyna.—B. HAUSSOULLER, *An inscription from Thebes*. A list of farmers of public and temple lands.—E. POTTIER, *Excavations in the Akropolis of Myrina conducted by M. A. Veyries*. I. *Dancing satyr carrying the infant Dionysos* (pls. x, XIII). During his short administration of the excavations at Myrina, broken off by his early death at Smyrna in December 1882, V. had the satisfaction of unearthing a series of remarkable terracottas. The style of the group reproduced greatly resembles that of the little bronze satyr recently found at Pergamon, and now in Berlin. It appears, indeed, to be itself a retouched moulding from a bronze, very probably a Pergamene original of the same III century.—E. EGGER, *Inscription from the island of Leuke*. The first found in the island.—S. REINACH, *Servius Cornelius Lentulus, praetor pro consule at Delos*. Historical elucidation of an inscription of 169 B. C.—P. FOUART, *Inscriptions from Asia Minor*.—P. FOUART, *Inscriptions from Boiotia*.—G. RADET and P. PARIS, *Two new provincial governors*.—CH. DIEHL and G. COUSIN, *Senatus consultum from Lagina, of 81 B. C.* Found on stones from the wall of the temple of Hekate: a decree rendered in behalf and at request of Stratonikeia, in Karia, and preceded by a letter from L. Cornelius Sulla to that city. It is full of the Latinisms common in the Greek versions of such decrees, which are official translations made at Rome, according to the probable conjecture of Foucart and Mommsen.—M. HOLLEAUX, *Excavation of the Temple of Apollon Ptoos*. First report of discoveries at Akraiphia in Boiotia: sufficient remains of the temple for theoretical restoration; a marble statue much resembling the Apollon of Tenea at Munich; sundry other fragments of archaic sculpture; twenty-three inscriptions, of which twelve in the Boiotian dialect; broken vases and terracottas in large numbers.—REVIEWS: Haussouiller's *Municipal life of Attica*, and Dubois' *Aitolian and Achaian leagues*.

Dec.—E. POTTIER and S. REINACH, *Excavations in the necropolis of Myrina: elephant trampling a Gaul* (pl. xi). Of mediocre execution, but of interest as possibly the only antique terracotta that commemorates an historical event; unless we except a naked Gaul with sword and shield found at Myrina itself. War-elephants played a decisive part in the victories of the kings of Syria and Pergamon over the Gaul in the III and II centuries B. C. This little elephant, then, is to be classed with so

famous works, of similar origin and intention, as the Apollon of the Belvedere, the dying Gaul of the Capitol, and the altar-frieze of Pergamon.—J. MARTHA, *Inscriptions from Nazos*. Two very ancient ones in *boustrophedon* writing.—M. CLERC, *Excavations at the Heraion in Samos*. Part of the great temple, some remains of a primitive sanctuary underneath its foundations, and some remains of a small structure near by, were laid bare. From the soil under the pavement of the large temple was extracted a broken bas-relief of tufa that must have belonged to the old temple of Hera; the subject is a man with a sword. Three vase-handles in the form of griffons' heads proved the most interesting among the bronzes unearthed.—F. DURRBACH, *Inscriptions from the Peloponnesos*.—M. HOLLEAUX, *Excavations about the temple of Apollon Ptoos*. The work was resumed in October 1885 by the cutting of trenches below the sanctuary, which stood on a hill; this resulted in the discovery of numerous marbles and bronzes of early style representing both men and beasts, besides vases and inscriptions.—REVIEWS: Hauvette-Besnault, *The Athenian strategoi*.
ALFRED EMERSON.

ΕΦΗΜΕΡΙΞ ΑΡΧΑΙΟΛΟΓΙΚΗ. JOURNAL OF THE ARCHÆOLOGICAL SOCIETY IN ATHENS. 1885. No. 1.—P. KABBADIAS, *Inscriptions from Epidaurus*. The first of these inscriptions (No. 80) is a continuation of the one published in 1883 (*Ep. 'Aρχ.* p. 197-228). It contains a list of 23 cures effected by the Epidaurian Asklepios, 15 having been performed upon men, and 8 upon women. No. 81 was on the base of a statue of Lykortas son of Theoridas set up by the city of the Lakedaimonians. No. 82 was on the base of a statue of *Tiberius Claudius Nero, Consul*, set up by the city of the Epidaurians. No. 83, also on the base of a statue, states that Archo daughter of Astylaïdas consecrated to Apollon and Asklepios a statue of her mother Echekrateia daughter of Damokles.—CHR. D. TSOUNTAS, *Prehistoric Graves in Greece*. The author attempts to prove that the circular tombs (*θολωρὶ τάφοι*), formerly called treasuries, are a survival of the original form of the Greek dwelling. To this end comparisons are drawn with the tombs found in Scandinavia and elsewhere in Northern Europe, and with the tombs of Hektor and Patroklos described in the *Iliad*. The *θόλος* mentioned in the *Odyssey* (x. 442, 459, 466) as connected with the palace of Odysseus is also cited. By means of an examination of the covering of earth under which the graves in the Akropolis of Mykenai were found, it is shown that these graves were originally covered by a tomb. The circular double wall, which Schliemann has called the wall of the *agora*, is maintained to be the *krepidoma* of this tomb. The article closes with a short discussion on the position of the bodies in the graves, and on cre-

mation.—P. KABBADIAS, *Sculptures from the Excavations at Epidaurus* (pls. 1, 2; figures 1–12). I. *Sculptures from the pediments of the temple of Asklepios*. 1. *Torso of a nude warrior* (fig. 1). This appears to be a part of the Amazonomachia from the western pediment of the temple (cf. 'Εφ. 'Αρχ. 1884, p. 50 sqq.). 2. *Head of an amazon* (fig. 2). Found in a wall between the *tholos* of Polykleitos and the temple of Asklepios, at the beginning of the excavations (cf. 'Αθήναιον I. p. 549, No. 2; and 'Εφ. 'Αρχ. 1884, p. 57, No. 12). Referred to the same group as the torso.

II. *Akroteria from the temple of Asklepios*. Three small statues of Nike. One (figs. 3, 3a) is nearly entire. It lacks the right hand, the left arm nearly from the shoulder, and the right foot. The shoulders and neck have holes for the fastening of the wings, which were probably of bronze. The figure is clothed with the *σχιστός χιτών*, leaving the right leg bare. The garment is fastened only on the left shoulder, so that the right arm and breast are exposed. The goddess is represented at the moment when she alights upon the earth. The other two figures are somewhat less well preserved, both heads being gone, as well as the arms. Fig. 4 is of the same size as fig. 3, and differs from it only in having the left leg advanced, instead of the right leg as in fig. 3. The third figure (fig. 5) is somewhat larger than the other two, and is therefore supposed to have occupied the place over the middle of the pediment. A head (fig. 5a) has been found, the dimensions and workmanship of which make it probable that it belonged to this last figure. These statues must have stood upon the temple of Asklepios, as the temple of Artemis, to which they might otherwise be ascribed, appears to have had no sculptural adornment. The figures appear to belong to the fourth century B. C.

III. *Copy of the chryselephantine statue in the temple* (cf. Paus. II. 27, 2). Asklepios seated upon a throne, sculptured in very high relief upon a block of marble (fig. 6). This block was apparently once placed upon a base, and also fastened to a wall behind.

IV. *Three statues of Asklepios standing* (figs. 7–9). These were probably votive offerings. The two smaller ones are of good workmanship, though late, and are ascribed to the age of the Antonines. The third is of inferior workmanship.

V. *Two statues of youths* (figs. 10, 11). One of these lacks both legs below the knee, the right arm below the elbow, and almost the whole of the left arm. The head and face are badly mutilated. The other figure lacks the head, both arms, and both legs from the knee downward. The workmanship is said to be good.

VI. *Hekate Trimorphos* (figs. 12, 12a). Three figures stand around a column which has a deep hole in it to receive a votive offering. The base on which the figures stand bears the inscription, 'Αρτέμιδι Ἐκάτῃ ἐπηκόω Φάβουλλος. Two of the figures are alike, each holding an apple (?) to her breast with one hand, while the other hand

hangs down and touches the himation. The third figure lets both hands hang down, and holds in one a corner of her himation, in the other a *φιάλη* or similar object. The head of each figure is surmounted by a high *kalathos*.—CHR. D. TSOUNTAS, *Athenian Vase-makers* (pl. 3). Publication of a plaque, from the Akropolis, with black figures on a red ground and the inscription []ο Σκύθες ἔγραψεν. Also a *kylix*, found at Korinth but of Athenian manufacture, with red figures on a black ground and the inscription, *Ἐδεργίδες ἐ*. Moreover, two inscriptions from fragments of pottery found on the Akropolis, *Δῶρις ἐ* and *Ἡ. ρον: ἐποιεσ*.—MISCELLANIES. N. NOBOSADSKÉ, *A decree of proxeny from Argos*. The inscription is published.—I. PANTAZIDES, *Περὶ τοῦ Ὑπερτελέατου*. *Hyperteleatas* as epithet of Apollon is derived from the name of a place, probably *Ὑπερτέλεια*. Paus. III. 22, 10; the reading *ὑπερτελέατον* is emended to *ὑπερτελέατου* (sc. *Ἀπόλλωνος*).—D. PHILIOS, *The theatre near Zea in the Peiraiæus*. A correction of certain statements of M. Dragatsés (*Εφ. Ἀρχ.* 1884, p. 196), concerning details of the construction of the theatre.—S. A. ΚΟΥΜΑΝΟΥΔΕΣ, *A record of the Pyloroi of the Akropolis at Athens*. An inscription similar to those published C. I. A. III. 1284-1294. The date assigned is "Roman times after Christ." The archon Chrysisippos appears here for the first time.

No. 2.—P. KABBADIAS, *Inscriptions from Epidaurous*. The first of these (No. 84) is a metrical inscription containing a pæan to Apollon and Asklepios, with an introduction and an epilogue in hexameters: the pæan is in Bacchiac or Ionic metre. The epilogue contains the genealogy of Asklepios, as follows: (1) Zeus, (2) Erato and Malos, (3) Kleopheme and Phlegyas, (3) Aigle (Koronis) and Apollon, (4) Asklepios. The poet, named Isyllos, was hitherto unknown. No. 85 was inscribed upon an altar. It reads, *Ἀσκληπίωι Σωτήρι*. No. 86 was on the base of a votive offering set up by Agrippa in honor of Asklepios. Both these inscriptions are of late date. No. 87 is a fragment of a list of cures like those formerly published (*Εφ. Ἀρχ.* 1883, p. 197, 1885, p. 1).—J. CH. DRAGATSES, *Antiquities of the Peiraiæus*. In making a road near the eastern shore of the harbor of Zea, the workmen found remains of buildings. Near these buildings several inscriptions were found. 1. A stele set up by Euthydemos of Eleusis, with directions for sacrifices. The same stele bears three other short inscriptions of somewhat later date. 2. A fragment of a relief with the legend *Ἐρμαῖος Διὶ Φ. λίφ*. 3. A few fragmentary reliefs and inscriptions indicating that a temple of Asklepios was in this neighborhood. These are described only from memory, as they have disappeared (but cf. *Εφ. Ἀρχ.* 1884, p. 219). 4. In dredging the harbor of the Peiraiæus there were found: *a*, a sepulchral relief representing a woman; *b*, a fragmentary urn with a relief representing a woman and

a bearded man; c, a quadrangular base with the inscription *Δημήτριος Κόχνου Ἀναφύστιος*; d, a fragmentary urn with a relief representing a woman (*Πεισιπράτεια*) and a man (*Θεοχάρης Σουινεύς*); e, fragment of a stele with an epitaph.—B. I. LEONARDOS, *Inscriptions of Amphiareion* (cf. *Ἐφ. Ἀρχ.* 1884, p. 98–100, and 160, *Πρακτικά* 1884). I. This inscription contains directions for the priest of Amphiaraos, and for those who wish to offer sacrifice or to sleep in the temple. II. This is a decree of the Oropians conferring a statue upon Hiero of Aigeira. Mention is made of the Achaian League, the Romans, and the great games of Amphiaraos. The date assigned is “Roman times before Christ.” III. Dedication on the base of a statue set up by king Lysimachos. The artist was Sthennis, son of Herodoros, an Athenian. IV. There are here published, an inscription showing that the people of Oropos set up a statue of C. Cornelius Lentulus, by Herodoros, son of Sthennis, an Athenian; and a vote of proxeny for Philip, son of Alkimachos, a Macedonian. On the same stone were five other decrees of proxeny which are not published. V. A dedicatory inscription of a statue in honor of L. Cornelius Sulla Epaphroditus set up by the Oropians. The artist was Teisikrates son of Thoinias. The same stone bears a number of decrees of proxeny, which are not published. VI. The people of the Oropians dedicate to Amphiaraos and Hygieia a statue of Metella Caecilia wife of L. Sulla Epaphroditus. VII. The people of the Oropians dedicate to Amphiaraos (the statue of) Quintus Caepio Quinti f. Brutus. The artist is Thoinias, son of Teisikrates, a Sikyonian. On the same stone is a decree conferring proxeny upon Hermias, son of Nearchos, an Athenian. VIII. Demokrite daughter of Theodoros dedicated to Amphiaraos (statues of) her father Theodoros son of Archilochos, and her son Theodoros son of Demainetos. The artist is Dionysios son of Ariston. IX. The people of the Oropians dedicate to Amphiaraos (the statue of) Appius Claudius Appii f. Pulcher. The artist is Agatharchos, son of Dionysios, a Boiotian.—TH. SOPHOULES, *Statuette from Sparta* (pl. 4). Publication of a marble statuette representing a youth. Nearly the whole of both legs and more than half of both arms are wanting. The nose is somewhat broken. The hair is long, and bound about the head with a tænia. The work is said to be a late copy of a bronze original. The original is assigned to the Peloponnesian school before Polykleitos, i. e. of the fifth century and before Ol. 85.—CHR. D. TSOUNTAS, *Earthen Utensil and Fragments of Pottery from Athens* (pl. 5). Publication (figs. 1, 1a) of a curious utensil with paintings on a white ground, described by F. Matz (Otto Jahn, *Europa*, p. 47 sq.). Also, publication of fragments of vases found on the Akropolis. Three fragments (fig. 2) are from a kylix which was adorned with a Gigantomachia in red figures on a black ground. Fig. 3 is a fragment.

of a kylix with parts of two figures, perhaps Kassandra and Aias. Fig. 4 is a fragment of a vase ornamented with black figures upon a red ground. Perseus stands upon a base or step, holding in his left hand a bag which contains, according to the inscription, the Gorgon's head. Perseus has wings on his ankles. His head is wanting. Behind him sits an old man. Portions of other figures also are preserved.—N. NOVOSADSKÉ, *Inscription from Megara*. This inscription records the setting up of a statue by the senate and people to Vitellia daughter of Sabinus. A few corrections of the inscription published in the *Revue Archéologique* (1875, pp. 19–22) are added.—PLATE 6 represented a bronze Satyr from the collection of Johannes Demetrios.

No. 3.—CHR. D. TSOUNTAS, *Inscriptions from the Akropolis*. 1. A fragment of the report of the stewards of Athena and the other divinities, for the year of the archonship of Eukleides. This fragment seems to make it certain, that, 403 B. C., the stewards of the treasures of Athena were united in one board with the stewards of the other divinities. Only three names are here given, instead of the usual ten. 2. Two fragments of an inscription containing three decrees in honor of three officials, whose office is not determined. 3. A fragment of a decree in honor of a certain Alexander, whose influence with Ptolemy Euergetes had been of service to the Athenians. The probable date is between 250 and 243.—D. PHILIOS, *Inscriptions from Eleusis* (contin.). 23 (167). Inscription cut upon a pedestal. Papias Onesime dedicates to the goddesses (the statue of) her son Titus Flavius Ateimatos. 24 (168) and 25 (169) are also inscribed on pedestals. These (statues) are in honor of women, and dedicated to the goddesses. These women, as well as the T. Flavius of 23, had been initiated into the mysteries. 26 (178). Metrical inscription consisting of ten distichs inscribed upon the pedestal of a statue of the Hierophantis (Epidote) who initiated the emperors Antoninus and Commodus. The verses give a record of her family for six generations, beginning with Eisaios, teacher of Hadrian. 27 (120). Inscription upon a pedestal. The senate of the Areopagus and the senate of the six hundred set up a statue of C. Caecilius Casius. 28 (165). Inscribed upon the pedestal of a statue of Appia Annia Regilla Atilia Caucidia Tertulla, daughter of Appius, consul and pontifex, wife of Herodes of Marathon consul and exegetes (Herodes Atticus), set up by her husband.—B. I. LEONARDOS *Inscriptions of Amphiareion* (contin.). 10. The name Pythodoros inscribed upon a column. 11. Two letters, only, Π Ο. 12. Upon a marble slab are the names Ἀμφιαράδ[υ] Ἀμφιλόχο[υ] Ἐ[ρμυ]?. 13. Upon a pedestal are two inscriptions: the dedication by the Oropians to Amphiaros of (a statue of) Q. Fufius Calenus, and a decree of proxeny for Philleas son of Agasilas an Athenian.—S. N. DRAGOMES, *Inscriptions from the Megarid*.

Five very fragmentary inscriptions, one from Eleutherai, two from Megara, and two from Aigosthena.—S. A. KOUMANOUDES, *Attic Inscriptions*. The first of these, given in facsimile and in small text, is a sixth small fragment of the record of proceedings against the Hermokopidai (cf. C. I. A. 274–277 and Supplem. vol. iv. fasc. 1, p. 35; also Dittenberger, *Sylloge*, p. 72–77). The second is given only in facsimile, and consists entirely of numerals (cf. C. I. A. 545). The third, given in facsimile and small type, contains the first words of a decree. The next three inscriptions are upon three sides of one stone, the fourth side of which has been roughly broken off. They are given in facsimile and small type. The longest and oldest inscription is ascribed to the last part of the fourth century B. C. It contains an account of naval properties. It may be part of one of the naval inscriptions in C. I. A. vol. II. part II. This inscription is fragmentary, for the stone has been badly broken, and on one side cut and shaped for some other than its original use. The inscriptions on the two other inscribed sides are of late date (first or second century after Christ), and consist of proper names. Finally, an inscription is published in small type consisting only of the heading of a decree. The date is the archonship of Nikodemos (cf. C. I. A. II. 471).—D. PHILIOS, *Discoveries in Eleusis* (pls. 8, 9). The specimens of sculpture found at Eleusis have been few and unimportant. On the other hand, fragments of pottery have been found which give, in a nearly complete series, the various stages of keramic decoration from the Mykenian period to that of the red-figured vases. Plate 9 gives (Nos. 5–9) five small vessels of peculiar shape, furnished with holes for hanging them up. These are probably censers. No. 10 of the same plate is a fragment of a vase formed and painted in imitation of sea shells. About the mouth is the inscription *Φωρίας ἐποίησεν* (cf. Klein, *Meistersignaturen*, p. 78). No. 11 is a fragment of a vase with black ground, adorned with an owl in relief, painted in imitation of nature. Nos. 12 and 12a are fragments of a gigantomachy painted in black (and purple) upon an orange ground. Nos. 1, 2 and 3 are thin plates of gold. The five pieces given as No. 3 are ornamented with bead and wire work in conventional patterns. The two larger plates (Nos. 1 and 2) are of repoussé work, and are very similar to one another. Both are adorned with stripes of conventional patterns, alternating with stripes which display animals in conflict with each other or with men. These plates were intended to be nailed upon wood. Nos. 1–3 of plate 8 reproduce fragments of a vase, upon the reddish ground of which are represented Amazons preparing for battle. The figures are black, only the nude parts being white. Violet-color is also sparingly employed. No. 4 of the same plate reproduces a fragment of a plaque. The style of decoration is archaic, and the work careless.

The figures are preserved from the waist up. Two females with high head-dresses stand opposite one another. The figures are black, though the nude parts are white, and some violet is used. The ground is orange.—**MISCELLANIES.** S. N. DRAGOMES, *Observations upon a certain decree of the people* (*Αρχαιολογία* III (1875), p. 687; C. I. A. II. I. 578).—A. S. KOUMANOUDIS, *An Italic Dekalithron*. An ancient weight is published with the inscription *Δεκάλιτρον Ἰταλικόν*.—**PLATE 7** represents fragments of Korinthian pottery with black figures. The article belonging to this plate is to follow in the next number of the *Ἐφ. Ἀρχ.* H. N. FOWLER.

GAZETTE ARCHÉOLOGIQUE. 1885. Nos. 7-8.—P. MONCEAUX, *Excavations and archæological researches at the Sanctuary of the Isthmian Games* (contin). The writer here notices the monuments outside the precincts of the sanctuary and in the sacred woods: the three sacred ways; the stadium on the S. side, some of whose marble steps still remain in place; the theatre on the W. side, forming a semi-circle with a diameter of 50 metres, of Roman construction; remains of temples in the sacred valley, of buildings of the city, and of aqueducts; the defensive wall. A careful examination of the vestiges of Nero's attempt to cut the Isthmus, shows that it was skilfully planned and energetically carried on for some months.—S. REINACH, *A ram-bearing youth* (pl. 25). This bronze statuette, found at Rimat, near Saïda (Tunisia) and belonging at present to the Bibl. Nationale, is of rude workmanship and must be attributed to the II or III century A. D. The writer is inclined to see in this and similar figures, not a mythological personage, but a mere shepherd.—E. LEFÈVRE-PONTALIS, *Stone crosses of the XI and XII centuries in the north of France* (pl. 26).—A. RAMÉ, *Explanation of the bas-relief of Souillac* (pl. 27). *The Legend of Theophilus*. This Romanesque church, one of the most remarkable of the southern group of churches with cupolas and pointed arches, is singular for its immense bas-relief placed on the inside of the façade. This composition has never been satisfactorily explained. M. Ramé pronounces it to represent four episodes of the Byzantine legend of Theophilus of Adama (Kilikia): when he sells himself to the devil; when the devil claims him; when he implores the assistance of the Virgin; and his deliverance by an angel. On the pilasters the writer finds some Old Testament subjects, and, in the four single figures, Isaiah, Joseph, S. Peter, and S. Benedict (or Martin). He relates this sculpture to that of Moïse and Beaulieu.—E. BABELON, *A Roman sarcophagus found at Antioch* (pls. 28, 29). It was found at Antioch by Capt. Marmier, and, though it appears to belong to the II century of our era, preserves, in both technique and subject, reminiscences of earlier Oriental art.—L. COURAJOD, *Jacques Morel, a Burgundian sculptor of the XV century* (pl. 30 and 2 figs.).

The kings and nobles of France considered the erection of a monument for themselves, during their lifetime, one of their most important acts: the writer sketches the development of these monuments from the XIII to the XVI century, especially in Burgundy. The Burgundian type of Dijon was followed in a great part of France. In 1448, Charles, duc de Bourbon, charged Jacques Morel of Montpellier to erect a monument for him and his wife Agnes de Bourgogne: "it is absolutely a chef-d'œuvre . . . and the most perfected type of Burgundian sculptural art." The figures are broad and noble, and the execution finished, without minuteness (pl. 30). By Jacques Morel was also the mausoleum of René of Anjou, which he left unfinished at his death in 1459.—H. THÉDENAT and A. HÉRON DE VILLEFOSSE, *The treasures of silver-ware found in Gaul* (contin.). (8 figs.). Continuation of the description of the treasure of Montcornet.

Nos. 9-10.—E. POTTIER, *Lekythoi with white and with bistre background at the Cabinet des Médailles* (pls. 31, 32). A supplement to the author's *Étude sur les lécythes blancs attiques à représentations funéraires*, published in 1883: it contains a catalogue of the vases in the *Cabinet des Médailles*. That illustrated on pl. 31, representing the meeting of a man and woman of middle age (quite unusual) at a tomb, is of considerable artistic excellence.—A. ODOBESCO, *Silver cup of the goddess Nana-Anat* (pl. 33). A cup with a female figure seated on a peculiar animal, in the centre, and, around her, eight figures adoring two symbols of Ormuzd. In this paper the writer seeks to identify the animal as a camelopard or giraffe, which would symbolize the active and passive principles combined in the goddess Anaitis, seated on his back.—L. DE LAIGUE, *Funerary Genius: a marble discovered in Rome* (pl. 34). A beautiful fragment belonging to the early Empire, found in the gardens of Sallust.—G. DURAND, *A cross from the Abbey of the Paraclete, preserved at the cathedral of Amiens* (pl. 35). It is a work of the XIII century of remarkable beauty for its filigree work, its nielli, and its medallions.—CH. DE LINAS, *The diptych of St. Nicaise in the treasury of the cathedral of Tournai* (pl. 36 and 19 figs.). On the obverse, is (1) Christ in a *vesica piscis*, (2) the Lamb in a circle supported by two angels, (3) the Crucifixion: on the reverse, St. Nicaise with two acolytes. It is a poor and inartistic production of the beginning of the XI century.—H. THÉDENAT and A. HÉRON DE VILLEFOSSE, *The treasures of silver-ware found in Gaul* (pl. 37). (contin. and end).

Nos. 11-12.—E. LE BLANT, *Introduction to the study of the Christian sarcophagi of Gaul* (pls. 38-41). This essay will form the introduction to the writer's great work on the sarcophagi of Gaul, which is soon to be

issued. Some years ago, M. le Blant published an important volume on the early-Christian sarcophagi of Arles: the present study he devotes to those of the rest of Gaul. The questions discussed in this introduction are: the use of old Christian and even pagan tombs in times of decadence; the historical reminiscences and legends attached to these rich tombs; the singular explanations often given of their bas-reliefs; their variations of type; their age; and the preservation of early types in Merovingian times.—L. COURAJOD, *A sculpture by Antonio di Giusto Betti at the Louvre* (pl. 43). This head of a youthful warrior, evidently by an Italian master of the xv cent., is satisfactorily proved by the writer to be the work of Antonio di Giusto Betti (b. 1479—d. 1519), who worked at the castle of Gaillon where this bust in alto-relievo was executed (cf. head of Apostle on tomb of Louis XII at St. Denis).—L. COURAJOD, *Some bronze sculptures by Filarete* (first article) (pl. 44). This small reproduction in bronze of the well-known statue of Marcus Aurelius, in the Royal collection at Dresden, is of singular interest. In the first place, it has a long inscription showing it to be by Filarete and to date from 1465, and will lead to the identification of a number of similar works as by the same artist; in the second place, it shows that *painted enamels*, the invention of which has always been attributed to the French school of Limoges, were already executed in Italy in 1465.—E. MÜNTZ, *Inedited frescos of the Papal palace at Avignon and the Certosa at Villeneuve* (first article). A review of some of the works of art executed under the pontificate of Clement VI. The frescos of the two chapels (of S. Jean Baptiste and S. Martial) in the tower of Saint John seem to have been commenced in 1343. The painted glass windows were executed in 1345–6.—A. CHABOUILLET, *Study on some cameos of the Cabinet des Médailles* (pl. 42). I. This paper illustrates a cameo attributed to Seleukos I, Nikator, the finest among those donated in 1862 by the duc de Luynes. It is hardly possible to decide whether this is the head of a god, a hero, or a king, but it was executed, in all probability, at Alexandria in the Ptolemaic period.—P. MONCEAUX, *Excavations and archaeological researches at the Sanctuary of the Isthmian games* (end). An account (1) of the ruins of a very ancient city, (2) of the *diolkos*, and (3) of the necropolis of Korinth. The plan of this ancient city, which the writer identifies with Ephyra, can still be ascertained with accuracy: the city was situated on a hill, and was cut entirely out of the rock,—streets, foundations, house-walls, furniture. The supremacy of the Isthmus seems to have passed from Ephyra to Korinth at the time of the Dorian conquest. The necropolis of the latter extends over the entire plain around the city.

A. L. F., JR.

JOURNAL OF HELLENIC STUDIES. Vol. VI. No. 1. April, 1885.—

E. A. GARDNER, *A Statuette representing a Boy with a Goose* (pl. A and fig. 51). An autotype reproduces a silver statuette, in the British Museum, which belongs to a numerous class representing a boy, in various attitudes, holding or struggling with a goose; the original conception of which was referred by Jahn in 1848 to a work of Boethos (whose probable date is the beg. of Hellenistic period) mentioned by Pliny (xxxiv. 84). This publication establishes Jahn's conjecture on firmer ground, by giving a fixed date for the existence of one specimen of the type, inasmuch as it was found near Alexandria together with coins which prove that it was buried in the early years of Ptolemy Euergetes, or about 240 B. C. Mr. G. enumerates 52 examples of this *genre* subject and classifies them under 5 types.—G. B. BROWN, *Sepulchral Relief from Attica at Winton Castle*. Plate B figures a pretty stele, crowned by an anthemion-ornament, and bearing the standing figure of a maiden gazing at a small image in her right hand. The architrave above her head is inscribed, *Aristomache*.—JANE E. HARRISON, *Odysseus and the Sirens—Dionysiac Boat-Races—A Kylix by Nikosthenes* (XLIX, plate of the kylix in colors). The kylix belongs to the black-figured class, and depicts on each side two galleys sailing nearly neck and neck, and near each handle a Siren. This is maintained to be the type from which in the red-figured class the myth of Odysseus and the Sirens is pictorially developed, the artist employing the forms and decorations of a purely *genre* conception, for the purpose of enshrining the myth. The earlier type, as on this kylix of Nikosthenes, portrays a boat-race, and a boat-race, too, as in general where galleys are found on black-figured vases, in honor of Dionysos. Even the eyes so frequent on this class of vases should stand symbolically for Dionysiac boat-races. For the prevalence of boat-races among the Greeks, appeal is made to Prof. Gardner's two articles on the subject in vol. II. of the *Journal of Hellenic Studies*: [where, however, no proof is produced of their existence at as early a period as the black-figured vases. But such proof does exist. The speaker in the twenty-first Oration of Lysias (§5), while enumerating his services to the state, mentions his winning a victory with his trireme at Sunion in a contest on which he spent 15 minae; and it is to this festival, a *pentaeteris*, with its naval contest, that Herodotos is believed to refer (VI. 87), when he speaks of the capture of the *theoris* by the Aiginetans, towards the beginning of the fifth century B. C. A. C. M.].—A. MICHAELIS, *Ancient Marbles in Great Britain. Supplement II.* (pls. c. LVI, LVII: 2 figs.). A small plate figures the Attic bull, once the property of Cockerell, and two large plates are devoted to the best reproduction now possible of the famous Korinthian Puteal which Dodwell describes with so much fervor in his

Classical Tour (II. pp. 200–202). These sculptures were taken first to Zante, and thence to London, where they remained for a long time in the possession of Lord Guilford; but they have since disappeared, and one object of the present publication is the hope of exciting an interest in them which may lead to their discovery.—F. IMHOOF-BLUMER and P. GARDNER, *Numismatic Commentary on Pausanias: Megarica, Corinthiaca* (pls. L–LV). This article, accompanied by six large plates of coins, is the most important and valuable contribution to this volume. It undertakes to identify the objects of art and worship mentioned by Pausanias in Megaris, Korinthia, Sikyon, Phlious, Kleonai, Argolis, etc., so far as possible by the study of coins. [The success which has crowned their efforts in so many cases shows what a fruitful field lies here for the illustration of that author. It was a happy thought that inspired both these numismatists at once and independently to enter upon this study, and it is to be hoped that they will pursue the subject until the whole of Pausanias is treated in this way. We may also express the hope that some one as competent will soon perform the much needed task of placing in the hands of the archæologist an edition of Pausanias which will be a proper representative of the knowledge of to-day. A. C. M.]—L. R. FARNELL, *The Pergamene Frieze* (concluded from vol. iv). A painstaking study of the Frieze as known up to the present time, and one which should be read before the sculptures themselves or complete photographs.—E. A. GARDNER, *Inscriptions copied by Cockerell in Greece*. At one of his lectures Mr. Newton asked his auditors to let him see any MS. collection of inscriptions they knew of in private possession, and soon received two volumes here treated of, which are copies. The originals have been lost, but this copy is a very careful one, and corrects many things in the *Corpus*, besides furnishing about 50 inscriptions still unpublished, the entire collection comprising 240, the first 60 of which are treated in this article. None of those that are unpublished appear of special importance.—L. CAMPBELL, *The Aeschylean treatment of Myth and Legend*. Professor Campbell here, regarding Aischylos as the patriot and the Eleusinian devotee, seeks to establish the intention of the poet in the *Eumenides* and *Prometheus*. Most great poetry, idealizing and delighting in contrast, has found its ideal in the distant past or future, and is visionary, reactionary, or pessimistic. Aischylos, however, like Spenser, found his ideal realized in the present, and delighted to contrast it with a time when the world had not yet been reduced to order, but a primeval chaos prevailed in which the elemental passions clashed and raved, and even the Furies might be convicted of passing the bound, and Zeus had not yet learned justice.—J. B. BURY, *Notes on* (1) *the Trilogy*, (2) *Certain Formal Artifices of Aeschylus*. Tragedy took the form of the Trilogy in

obedience to the law that was enunciated by Aristotle in his *Poetics*, that a work of art must be a whole, with a beginning, a middle, and an end; as the plastic group should have a centre and two symmetric sides, likewise in the Oresteian and Promethean trilogies are inculcated *ἔργα*, *πάθος*, and *μᾶθος*. The formal artifices of the poet are especially his indication of responsions of thought by responsions of phrase.—C. SMITH, *Early Paintings of Asia Minor* (4 figs.). The characteristics of the rare examples of undoubted vase-paintings of the early period from Asia Minor are here described, and the writer seeks to show that an amphora from Rhodos belongs to this school which seems to have existed in the vicinity of Klazomenai.—P. GARDNER, *Amphora-handles from Antiparos*. Of seven amphora-handles brought from that island by Mr. Bent not one can be assigned with certainty to either of the three great centres of this manufacture, Rhodos, Knidos, or Thasos.—J. T. BENT, *On the Gold and Silver Mines of Siphnos*. These mines, mentioned by Herodotos and other ancient writers as extremely rich, were explored by Mr. Bent in two places, at the N. E. and N. W. parts of the island. They form huge caves with labyrinthine windings, and in the vicinity of one on the east side, close to the sea, are hollows, supposed to have been used for smelting, and similar ones may be seen under water at a distance from the shore, showing that there has been a subsidence of the land since they were in use, perhaps referred to by Pausanias (x. 11, 2).—W. WROTH, *A Torso of Hadrian in the British Museum*. This Torso from Kyrene is identified by comparison with another from Krete now in the museum at Constantinople, published with a photograph in the *Gazette Archéologique* for 1880. Mr. Wroth calls attention to the close connection existing between Krete and Kyrene, even as early as the IV century B. C., when the Kretans used Kyrenaic coins as *flans* on which to restrike Kretan types.—W. M. FLINDERS PETRIE, *The Discovery of Naukratis*. This is a short report of the first year's work on this site, which is about half a mile long. At the north end of the town stood the temenos and temple of Apollon, as proved by numerous bowls with dedicatory inscriptions, the first temple having been destroyed probably during the Persian invasion. South of this lay the *agora*, or possibly the *palaistra*, a large area without ruins, bounded by walls on three sides. Next followed the town with narrow streets. East of the *agora* was the potters' quarter, south of these the iron-smelters, and to the west the scarab factory where glazed pottery scarabs were made for export, as shown by the hieroglyphics being all blundered. Only the names of Psamtik I. and II. appear on them. The temple of Aphrodite was in the south-western part of the town. In the area of the town, quantities of pottery of archaic types, from the so-called Phœnician-Greek to the ordinary Greek pottery, have been

found. A large enclosure 600 ft. square, to the S. of the town, appears to have been a large temenos with treasury and storehouses of brick, in which Ptolemy II. erected a large stone building. A. C. MERRIAM.

REVUE ARCHÉOLOGIQUE. 1885, II. **Sept.-Oct.**—M. DELOCHE, *Studies on some seals and rings of the Merovingian period* (cont.). XIII. *Seal-ring of Aurea* (1 fig.). A bronze ring with monogram deciphered as AVREA. Mention is made of an abbess of this name at Paris in the year 666 A. D., and of another at Amiens about 789 A. D. XIV and XV. *Seal-rings of Melle* (Deux-Sèvres) (2 figs.). Two bronze rings found near Melle in 1883. The monogram of one is deciphered as + BENIGNVS, a name common in the Gallo-Frank period, and borne by at least fifteen ecclesiastics of rank between the II and VIII centuries.—P. BATIFFOL, *Canones Nicaeni pseudepigraphi*. The text of a hitherto inedited XIV century MS. from the library of San Marco (Marcianus, 498), containing a modified version of the Nicene Creed with anathemas against the faith of Sabellios, Photinos, those who do not acknowledge the resurrection of the flesh, and against all heresies contrary to the Nicene symbol, and especially against the "atheistic" faith of the Arians. Then follow a series of moral and religious precepts, in general of a negative and ascetic character.—ED. DROUIN, *Coins with inscriptions in Pehlvi and Pehlvi-Arabic* (cont.) (pl. XXIII). A description of Indo-Pehlvi coins, of which there are several varieties from Khorâssân, Multân and Zaboulistân. A large number of coins in imitation of the Sassanid type, with fire-altar and Buddhist emblems and pseudo-Pehlvi inscriptions, are found in the valleys of the Kâboul and the upper Indus.—H. GAIDOZ, *The Gallic Sun-god and the symbolism of the wheel* (cont. and end) (1 fig.). The association of the thunderbolt with the wheel in figured monuments is explained from early and wide-spread beliefs connecting the thunderbolt with the sun. The Gallic Sun-god was recognized by the Romans as Jupiter, not merely from his character of the thunderer, but as ruler of the heavens. Instances are cited of many Gallic surnames of Jupiter, and additional evidence from texts and figured monuments to support the thesis, that the Gallic god of the wheel was the Sun-god identified by the Romans with Jupiter.—DR. RENÉ BRIAU, *Introduction of Medicine into Latium and Rome* (cont. and end). Practice of medicine was introduced into Rome not by Greeks but by the Etruscans. The religious rites of the haruspices led to a knowledge of general anatomy. Many anatomical and pathological terms of early Latin origin still remain in use. Etruscan medical practice is referred to implicitly by Dion. Halik. *Antiq. Rom.* I. c. LXX; Livy, *Hist.* I. c. XLI; Valerius Max. II. c. IV.—ANDRÉ LEVAL, *Supposed letter of Mohammed IV to Leopold I, Emperor of Germany, and*

his reply. Two Greek manuscript letters, found in the archives of the monastery of St. Louis at Constantinople, are here edited in the Greek and translated with annotations.—CHARLES NORMAND, *Ancient metallic architecture, or the role of metal in ancient constructions*. A résumé of the state of our knowledge on this subject, and an appeal for further information.—DIEULAFOY, *Mission to Susiana: Note of the discovery of 7 new inscriptions on the tomb of Darius* (pl. xxiv). The long inscription on the tomb of Darius at Naksh-i-Rustam has been photographed by MM. Babin and Houssaye, and seven new smaller inscriptions were found beneath a covering of stucco, the first instance of engraved cuneiform characters retaining traces of color. A photographic reproduction of an Elamite bas-relief at Mal-Amir is presented.—H. GAIDOZ, *The art of the Gallic Empire* (pl. xxv). Description of a Gallic *situla* found in an Etruscan tomb on the Arnoaldi estate at Bologna. The description is based on the publication of Prof. Brizio, *Sulla nuova situla di bronzo figurata trovata in Bologna*. Modena, 1884.

Nov.-Dec.—E. REVILLOUT, *A farm-lease of the time of Amasis, and the condition of property at this period* (pl. xxvi). The institution of private property in land, which existed during the Ancient Empire, was overthrown by Rameses II. Land now belonged to the king, the priests and the newly established military caste. This distribution of property was modified, not destroyed, by the code of Bocchoris: its influence is seen in the farm-lease of the time of Amasis, and is felt even to the present day.—DR. VERCOUTRE, *Sacerdotal practice of medicine in Greek Antiquity*. An attempt to prove that the priests of Asklepios were not mere charlatans, but were masters of hygiene, and gave many prescriptions of a rational and scientific character.—J. MÉNANT, *Intaglios of Asia Minor* (22 figs.). In the light of the rock-sculptures of Asia Minor, several seals and cylinders are described and classed as Hittite. Care must be taken to distinguish these Hittites of Asia Minor from the Biblical Hittites, the descendants of Heth.—H. GAIDOZ, *The Gallic Sun-god and the symbolism of the wheel: Post-scriptum*.—M. DELOCHE, *Studies on some seals and rings of the Merovingian period* (cont.) (3 figs.). xvi. A silver fibula, which served as a seal, with monogram deciphered as + Sl(gillum) or Sl(gnum) SISTO (for SIXTO).—P. CHARLES ROBERT, *Alternate dispersion and centralization in the coinage of money in Gaul, from the Gallic to the Carolingian period*. During the Gallic period, money was coined at many places in Gaul, first according to Greek and then to Roman models: under Roman rule, we find the centres of coinage reduced to three: in the Merovingian period, many centres and great variety of coins: under Charlemagne, again centralization.—SALOMON REINACH, *Chronique of the East* (9 figs.). A very comprehensive summary of the work of Mr. Ohne-

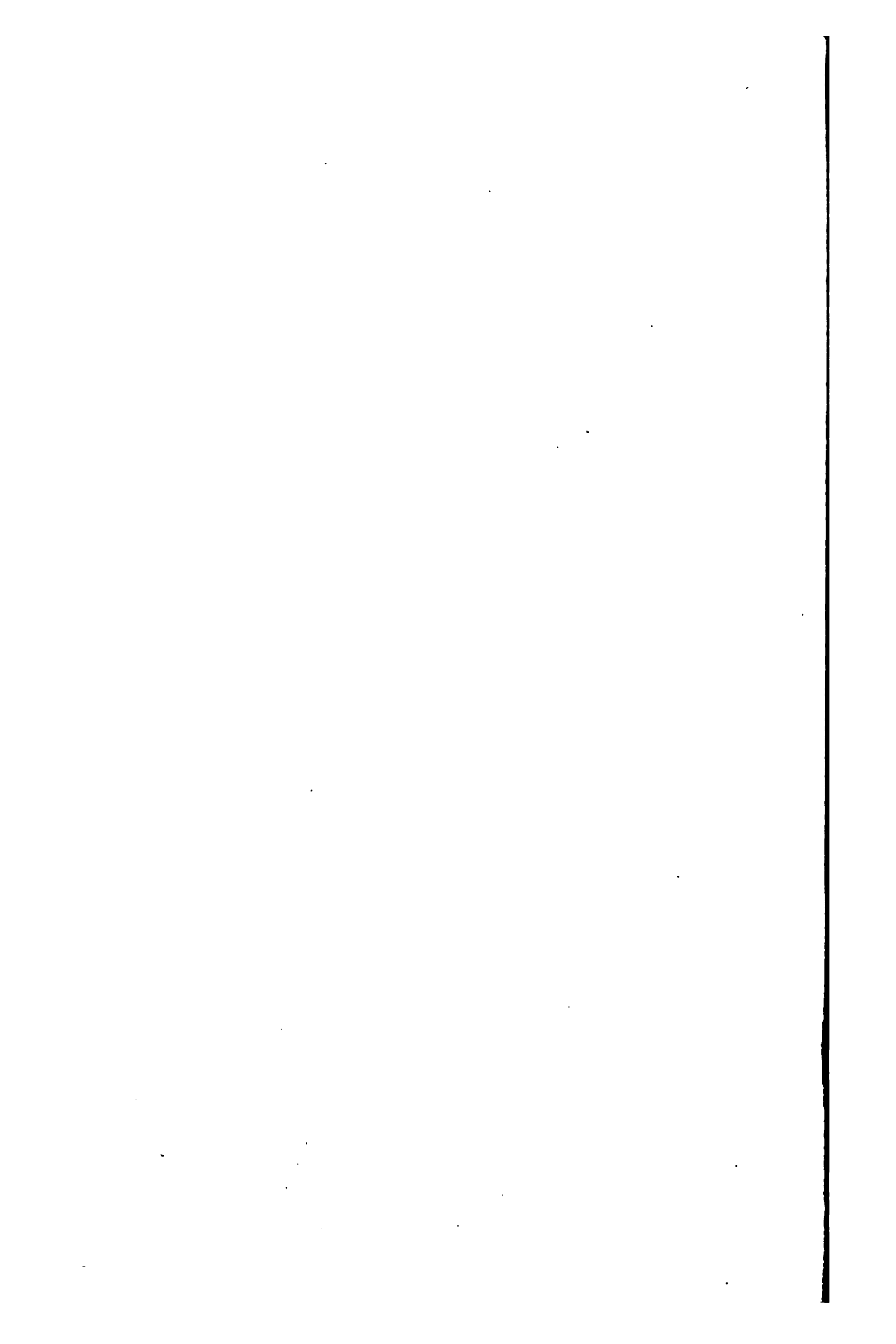
falsch-Richter in Kypros since 1880, at Kition-Larnaka, Salamis, Soli, Kourion-Episkopi, Chytroi-Voni, Achna, Marie, Nikosia, Idalion-Dali, Amathous, Marion and Alambra.—PAUL TANNERY, The ΟΥΓΚΙΑΞ-ΜΟΞ ΥΔΑΤΟΞ. The text, translation, explanation and critical notes on a fragment of Hero of Alexandria, containing information on the Greek method of calculating the volume of water-pipes.

1886, I. Jan.—CLERMONT-GANNEAU, *A Phœnician inscription from Tyre* (pl. I). This Phœnician inscription is of especial interest as being the first found at Tyre. It was discovered by M. Löytved, and was, together with a part of the monument on which it was engraved, bought by the Louvre. Only the left portion remains, and even that is in an unsatisfactory condition. It commemorates an important work in which the *suffetes* (magistrates) of Tyre took part: perhaps the construction of a reservoir. The writer attributes the inscription to the Greek Ptolemaic period after the autonomous constitution given in 274 to the people of Tyre by Ptolemy Philadelphos.—L. COURAJOD, *The bronze Diana of the Castle of Fontainebleau* (pl. II). The bronze Diana of Marly, executed in 1684 by the Keller brothers for Louis XIV, entered the Louvre in 1794, and was mistaken for the Diana of Fontainebleau which had been executed for Henry IV in 1602 by Barthélemy Prieur, and all traces of which had been lost after 1801. M. Courajod re-establishes the identity of the two, both of which are copies of the marble Diana of the *Salle des Antiques*.—M. DELOCHE, *Studies on some seals and rings of the Merovingian period* (cont.). xvii. Bronze ring of Mesnil-Bruntel (Somme) with monogram Sl(gnum) or Sl(gillum) FELICIE, found August 21, 1885. Though we have no example of the name Felicia, that of Felicius is quite frequent.—DR. VERCOUTRE, *Sacerdotal practice of medicine in Greek Antiquity* (cont.). An answer to the objection that a great number of the remedies prescribed by Asklepios are evidently absurd.—PAUL TANNERY, *The astronomical cubit and the ancient divisions of the circle*. He contests the entire dependence of the Greeks on Babylonian astronomy. The writer's hypotheses are: (1) that this unit, 1/180 of the circumference, preceded among the Greeks the division of the circle into 360°; (2) that the division into 360°, applied to the circle in general, is really due to Hipparchos, and coincides with his invention of trigonometry; (3) that the Chaldæans had this division of 360 only for the zodiac, and employed other analogous but different divisions at the same time.

ALLAN MARQUAND.

BOOKS RECEIVED.

- Ch. Clermont-Ganneau.** Recueil d'Archéologie Orientale. Avec planches et gravures. Fascicule I. 8vo, pp. 80. Paris, 1885, *Leroux*.
- W. H. Dall.** Masks, Labrets and certain Aboriginal Customs, with an inquiry into the bearing of their geographical distribution (Extract from the third annual Report of the Bureau of Ethnology). 4to, pp. 202, with 25 plates. Washington, 1885, *Government printing office*.
- Henri Delaborde (Vte.).** Les Artistes Célèbres. Gérard Édelinck. Ouvrage accompagné de 34 gravures. Rl. 8vo, pp. 93. Paris, 1886, *Rouam*.
- E. N. Horsford.** John Cabot's Landfall in 1497, and the site of Norumbega. A letter to Chief-Justice Daly, president of the American Geographical Society. Rl. 4to, pp. 42, with 9 plates. Cambridge, 1886, *John Wilson & Son*.
- R. de Lasteyrie.** Jules Quicherat. Sa vie et ses travaux. 8vo, pp. 42. Paris, 1883, *Imp. Nationale*.
- O. Marucchi.** Description du Forum Romain et Guide pour le visiter. Traduction Française revue et augmentée par l'auteur et mise au courant des dernières découvertes. Avec deux planches. 12mo, pp. 208. Rome, 1885, *Loescher*.
- J. Ménant.** Recherches sur la Glyptique Orientale. Seconde partie: Cylindres de l'Assyrie, Médie, Asie-Mineure, Perse, Égypte et Phénicie. Rl. 8vo, pp. 271, with 5 plates and 266 figures. Paris, 1886, *Maisonneuve*.
- André Michel.** Les Artistes Célèbres. François Boucher. Ouvrage accompagné de 44 gravures. Paris, 1886, *Rouam*.
- J. C. Morgenthau.** Ueber den Zusammenhang der Bilder auf Griechischen Vasen. I Theil: die schwarzfigurigen Vasen. Inaugural-Dissertation z. Erlang. d. Doctorwürde, etc. zu Leipzig. 8vo, pp. 90. Leipzig, 1886, *Bär & Hermann*.
- W. M. Flinders Petrie.** Tanis. Part I., 1883-4. With nineteen plates and plans. Published by order of the Committee. [Second Memoir of the Egypt Exploration Fund.] Folio, pp. viii-54. London, 1885, *Trübner*.
- Jules Quicherat.** Mélanges d'Archéologie et d'histoire. Archéologie du Moyen Age. Mémoires et fragments réunis par Robert de Lasteyrie. 8vo, pp. 514, with 11 plates and 88 figures. Paris, 1886, *Picard*.
- E. Stevenson.** Osservazioni sulla Collectio Canonum di Deusdedit. 8vo, pp. 98. Roma, 1885, *Soc. Romana di Storia Patria*.
- Cyrus Thomas.** Notes on certain Maya and Mexican Manuscripts. (Extract from the third annual Report of the Bureau of Ethnology.) 4to, pp. 65, with four plates and figures. Washington, 1885, *Government printing office*.



AMERICAN JOURNAL OF ARCHÆOLOGY.

VOL. II.

No. 2.

NOTES AND INSCRIPTIONS FROM ASIA MINOR.

IX.—MANUEL'S CAMPAIGN AGAINST THE TURKS, A. D. 1176.

In the *Journal of Hellenic Studies* (1883, p. 402) I have shown that the small town of Sibia or Sublaion, which struck a few rare coins under the Roman Empire, and which was a Bishopric in Byzantine times, was situated where the modern village Homa stands. One of the most tragic events in Byzantine history, the battle which finally laid the Empire prostrate and helpless before the Seljuk Turks, took place beside Sibia, though as yet no one has ever suspected that the pass of Homa was the scene of the fight.

In the twelfth century the plain of Sibia and the pass which leads from it across the mountains into the province of Salutaris and the East, rose into importance from the peculiar conditions of the time. The history is obscure, and has never yet been properly explained. The key to it lies in the clear exposition of a name which occurs for the first time in historians of the period, and which has lasted till the present time: that name is Khoma,—or Homa, as the Turks still call the village which occupies the site of Sibia.

The name Khoma is mentioned several times during the twelfth century. It denotes a district or province guarded by certain troops, who are often called Khomatenoi or *οἱ ἐκ τοῦ Χώματος*. The passages in which it occurs are as follows:

ἄποσοι ἐκ τοῦ Χώματος ἄρμηντο, Anna Komnena i. 131 (Bonn edition).

τῶν ἐκ τοῦ Χώματος, Anna i. 134, 170, 178.

τῶν Χωματινῶν ἑξαρχον, Anna i. 29.

τὸν Βούρτζην τοπάρχην ὄντα Καππαδοκίας καὶ Χώματος, Anna i. 171.

(From Laodikeia on the Lykos) διὰ τοῦ Χώματος διελθὼν τὴν Ἀάμπην κατέλαβε . . . ἐφθαχὼς δὲ εἰς τὸ Πολύβοτον, Anna ii. 96.

From Apameia-Kelainai εἰς τὸ Χῶμα ἐλθὼν τῷ Μυριοκεφάλῳ ἐφίσταται, Niketas Chon., p. 231.

Ducange has correctly described the meaning of the term Khoma in writers of this late period,¹ though he has erred in supposing that Lykia was part of the Theme and that the Lykian Khoma was the central city in it. None of the later writers have taken any notice of the Theme Khoma.

The passages just quoted show that the Theme of Khoma lay east of Laodikeia, and that the road to Polybotos² passed through it. They also prove that the Theme existed when Alexios Komnenos ascended the throne A. D. 1081, but no older evidence exists to show at what time this new Theme was constituted. It is obviously a part of the older Anatolic Theme, as described by Constantine in the tenth century. Between the time of Constantine and that of Alexios Komnenos a vast change had come over the Anatolic Theme: great part of it, including the eastern and southern and much of the central regions, had been occupied by the Seljuk Turks and formed into a hostile monarchy. The Seljuk sovereigns had formed alliances with more than one of the Byzantine emperors or pretenders, and a condition of any such alliance necessarily was the recognition of the Seljuk suzerainty over that part of the Anatolic Theme which they claimed.³ Moreover, a remarkable change is observable in the road-system of this district, when the wars of Alexios and Manuel make it possible, after many centuries of obscurity, to look again into the means of communication. The great highway, the path indicated by nature,

¹ See his note on Anna Komn. ii. p. 486, where he corrects the old false interpretation of the word.

² Polybotos or Polyboton is the modern Bolwadun.

³ Finlay has correctly described the character and conditions of these alliances between the weakest Byzantine Emperors and the warlike Seljuks. The cession of territory is disguised or omitted by the Byzantine historians. It can be proved that Apameia-Kelainai and the country between it and Laodikeia *ad Lycom* was ceded in this way to the Seljuks.

from Laodikeia to the east, has often been described,⁴ but in these late wars it is not employed. In 1092 Dukas marched from Philadelpheia in pursuit of the retreating Turks by way of Laodikeia and thence through the district Khoma by Lampe⁵ to Polybotos. All the operations of Manuel in his fruitless attempt to drive back the tide of Turkish expansion in the years 1176-8 were directed on Sibia (Homa), and on points between Laodikeia and Sibia. The reason why this line of communication became so important about 1100 to 1200 A. D. is that the line of the old and natural highway lay in Turkish territory.⁶ Laodikeia, Apameia, and the line of country between them were Turkish, and the plain of Sibia was an outpost of the Byzantine power, bordered on the south and the east by Seljuk territory. Close to Sibia a pass, called now Duz Bel, crosses the mountains which at that time divided the Byzantine from the Seljuk dominion. The pass over the Duz Bel then became an important *kleisoura* between Turkish and Byzantine territory, the fortress commanding it on the Byzantine side became a central point in the defence of the frontier, the routes leading to it became important military roads, the policy of the emperors who defended the frontier was concentrated on the maintenance of this border fortress, and the organization of the whole district was conducted with a view to this end. Such was the origin of the new Theme of Khoma.

The origin of the name Khoma as applied to this Theme is a point on which I can throw no light. The explanation advanced by Ducange (*l. c.*), that it is derived from the Lykian city Khoma, is inadmissible. It is hardly possible that the Theme Khoma can have included any part of Lykia. The passage quoted from Anna Komnena (I. 171) shows that the Theme of Khoma was conterminous with the Theme which in the twelfth century was dignified with the name of Kappadokia, and that the two Themes were under one general, Burtzes. Other passages (Anna II. 325 and 327) prove that Kappadokia at that period meant the plains north and north-east of Amorion: hence it is clear that the two Themes embraced the whole frontier-defence against the Seljuk kingdom of Ikonion.

⁴ E. g., *Journal of Hellenic Studies*, 1882, p. 345. It goes by Apameia.

⁵ Anna II. 96, quoted above.

⁶ I must assume the results of my study of the local history of southern Phrygia, which is already in MS. ready for print.

Anna Komnena and Niketas, the only two writers who use the term Khoma, denote by it the district which I have described. The term, by an easy transition, was applied to the central fortress on which the defence of the whole district mainly depended, and in this sense the name has lasted till the present day. The village on the site of Sibia is called by the Turks Homa. The term *Thema* in Byzantine writers means (1) the troops who guarded a province, (2) the country or province which they guarded, (3) the main fortress where they were stationed. The *κάστρον Χαρσιανόν*, the central fortress of the Thema Kharsianon, had in all probability a distinct older name.⁷

When Manuel resolved to make one great effort to break the Turkish power, he began by refortifying a point on each of two great roads between Ikonion and the Byzantine territory: One point was Dorylaion, formerly an important military station, a *θέμα* and an *ἀπληκτον*, on the direct road from Constantinople to Ikonion: the other was Soublaion or Sibia, the central fortress for the defence of the Theme of Khoma. He chose the latter route for delivering his great blow, wintered at Khonai (now called Honas), and in the following spring (A. D. 1176) marched directly against Ikonion.

In describing the subsequent operations, Niketas, our sole authority, uses two names, which are known only from this passage: MYRIO-KEPHALON and the TCHYVRIJI KLEISOURA. Close to Homa or Sibia, an important pass crosses the neck connecting the Ak Dagħ with the Djebel Sultan Dagħ: this pass is now called the Duz Bel, "Level Neck."⁸

Leaving the plain of Sibia, the road climbs the grassy hillside by an almost perpendicular ascent of 1500 feet or more. After this first steep climb, the pass lies before us straight and open, whence the name, "Level Neck." About two miles further east the road forks, one branch leading to the Tchul Ovasi (Metropolitanus Campus)

⁷It is probably the almost impregnable rock of Mushalem Kale.

⁸The pass is not marked in any map, and seems not to have been traversed by any modern traveller till we crossed it in 1883. At the present time a traveller from Ala Sheher (Philadelpheia) to Konia would probably, and a traveller from any part of the higher Maeander valley would certainly, be recommended by the muleteers to cross the Duz Bel. By a fortunate accident I was led to choose this route, otherwise Manuel's campaign against the Turks would still be unintelligible to me.

goes to the right down a long narrow defile called Turrije Boghaz; the other turns to the left and descends another more open defile towards Sandykli.⁹

Such was the pass which the emperor Manuel crossed on his ill-fated expedition. He reached a ruined fort named Myriokephalon, and had then before him a long defile, the Tchyvriji Kleisoura, (*αἱ κλήσουραι τοῦ Τζυβριτζή κατονομάζονται δε καὶ ἡμελλόν Ῥωμαῖοι μετὰ τὴν ἀπὸ Μυριοκεφάλου παριέναι ἀπαρσιν*, Niket. Chon. 231). Against the advice of his officers, he marched into this defile with his whole army in long scattered array, without any precaution; and the Turks, who occupied the heights on each side, slaughtered the Byzantine troops without difficulty or danger.

The description suits the Turrije Boghaz excellently, as far as I can judge from its appearance.¹⁰ The very name may be the same which Niketas writes *Τζυβριτζή*, obviously a Greek rendering of a Turkish name.¹¹ Myriokephalon then was a fort on the Duz Bel: and we were informed at Homa that ruins existed on the Bel, though in our rapid march we did not observe them. It is probable that, when the Iconoclast Emperors organized the defence of the empire against the Arabs, they built the fortress of Myriokephalon, which was a ruin in the twelfth century. This pass could have become an important one only during the long wars against the Arab marauders.¹²

After Manuel's army had been almost annihilated by the Turks, the Seljuk sultan, Kilij Arslan, offered him peace on condition of destroying Dorylaion and Soublaion; and he returned again, necessarily by the same road, to Khonai, dismantling the lately restored fortifications of Soublaion as he passed (*τὸ Σούβλαιον ἐπιπαριῶν καθαιρεῖ*, Niket. Chon.). From this time onward, the valley of Sibia has been in Turkish hands, and the population has adopted the Mohammedan religion.

⁹ I have traversed only the second defile: the first is the main road to the East.

¹⁰ I looked down the pass from the Duz Bel, and also looked up the pass from its other end south of Kizil Euren.

¹¹ τζη is the Greek rendering of the common Turkish ending *ji*.

¹² It is important only in defence against an enemy from the East.

X.—FINES SAGALASSENSIUM.

In June, 1884, I found the following inscription in the cemetery of Deuer, a village at the south end of the lake of Buldur. It is engraved very roughly and carelessly on a large block of unsmoothed limestone. The surface of the stone is exceedingly uneven, and the letters are very faint. Seeing its importance, I spent the great part of two days working at it, but the reading of l. 16 is still uncertain. I am indebted to a most ingenious restoration by Prof. Mommsen of lines 13 to 15, the interpretation of which baffled me while I was studying the stone. While working at this inscription, I was just recovering from a sharp attack of fever, and on the first day was hardly able to stand upright: and, as the stone was buried in the ground upside down, I suffered much from the great heat and the constrained position which I was obliged to occupy: an examination under more favorable conditions may yet give the reading of l. 16.

ε _ ΕΠΙCΤΟΛΗ // ΘΕ
 ΟΥ // C Ε Β Α C // ΟΥ
 ΓΕΡΜΑΝΙ // // ΙCΑΡΟC
 ΚΟΙΝΤΟCΠΕΤΡΩΝΙ
 5 ΟCΟΥΜΒ // ΠΡΕCΒΕΥΤΗC
 ΚΑΙΑΝΤΙCΤΡΑΤΗΓΟCΝΕΡΩ
 // ΟCΚΛΑΥΔΙΟΥΚΑΙCΑΡΟC
 CΕΒΑCΤΟΥΓΕΡΜΑΝΙΚΟΥ
 ΛΟ // ΟCΠΟΥΠΙΟCΤΡΑΙ
 10 CΗ // ΤΡΟΠΟCΝ // ΩΝΟC
 ΚΛΑ ΙΟΥ ΑΙC ΟCCE
 ΟΥΓΕ ΜΑΝΙΚΟΥΩ
 ΡΟΟCΤΗC \NTAME Ι
 ΔΕ ΙΑΕΙΝΙ // ΛΑCCEΩΝ
 15 ΤΑΔΕΕΝΑ ΤΕΡΑΚ
 \ \ Ο ΤΥΜΒΡΙΑΝΑC
 ΚΛΑΥ ΑΙCΑ
 ΕΡΜ

Throughout this inscription there is hardly a single letter which is clear and certain: it was deciphered, symbol by symbol, with hesitation and laborious comparison. Hence, in the difficult line 16 there is no letter except N of which I am positively certain, and the horizontal stroke of the T is very much extended on the right, though I

could see no trace to warrant the reading Π. In line 2 the word θεοῦ is engraved over the erased name of Nero. In l. 5 the impossible reading BOB appeared, after frequent examination, to be on the stone.

Ἐξ ἐπιστολῆ[ς] θεοῦ Σεβασ[τ]οῦ Γερμανι[κοῦ Κα]ίσαρος Κοίντος Πετρώνιος Οὐμβ[ερ?] πρεσβευτῆς καὶ ἀντιστρατηγὸς Νέρω[ν]ος Κλαυδίου Καίσαρος Σεβαστοῦ Γερμανικοῦ [καὶ] Λο[ύκι]ος Πούπιος Πραΐσι[ν]ος ἐπι[τροπος Ν[έρ]ωνος Κλα[υδ]ίου [Κ]αίσα[ρος Σε]βασ[τ]οῦ Γε[ρ]μανικοῦ ὠροθέτησαν τὰ μέ[ν] ἐν δε[ξι]ῇ εἰν[αι Σαγα]λασσεῶν, τὰ δὲ ἐν ἀ[ρι]στ[ερ]ῇ [Νέρωνος] Κλαυ[δίου Κ]αίσα[ρος Σε]βαστοῦ Γ[ερμ]ανικοῦ].

“In accordance with a rescript of the Emperor Nero [the name Nero has been erased, and the word God substituted] Germanicus Caesar, Quintus Petronius Umber, lieutenant with power of praetor of the Emperor Nero Claudius Caesar Germanicus, and Lucius Pupius Praesens, procurator of the Emperor Nero Claudius Caesar Germanicus, fixed the boundary, that what lies on the right should belong to the Sagalassians, and what lies on the left should belong to the . . . [estate] of the Emperor Nero Claudius Caesar Germanicus.”

In the village of Deuer I found another inscription, which is a companion to the preceding. It is engraved on a block of limestone which has been hollowed out to form a large mortar. Only a few letters remain at the ends of the lines, along the edge of the stone on the right.

		/	10	█
		OC		II
		C		███
		KAI		CC
5		NOC		Ω
	POC	BAC	15	ΕΡΚ
		OY I KAI		OC
		CTTPAI		YOYE
		PΩ		AAAC

In line 13 the second C is probably part of O or Ω, and in line 18 the Λ is very doubtful. The first ten lines of this inscription were identical with eleven of the preceding: the rest probably contained a similar formula in reverse order. The word [Σαγ]αλασ[σέων] seems to be the end of the whole.

A third inscription was discovered in the same village by Mr. A. H. Smith, who visited Deuer on the day before I passed through it.

I also copied it. It shows that in the reign of Diocletian this district was still part of the territory of Sagalassos.

These inscriptions prove with definite certainty that, throughout the Roman period, the whole valley along the east and south of the lake of Buldur belonged to Sagalassos. It is, of course, obvious that this state of affairs existed before the Roman supremacy began, and was permitted to continue under their government. Therefore we may consider it certain that, in the second and third centuries before Christ, the country lying along the east and south of the lake was included in "finis Sagalassensium."

This discovery throws a new and utterly unexpected light on the passage of Livy which describes the route of the consul Manlius in his expedition against Galatia. Hitherto, it has been exceedingly difficult to see how Manlius passed through the territory of the Sagalassians. The furthest point to the south-east which Livy mentions is Termessos: a glance at the map shows how far Sagalassos lies out of the natural route from Termessos to Galatia. An acquaintance with the natural features of the country makes it still more difficult to understand how Manlius could have gone through Sagalassos. The mountain barrier north of that city would force him, as it had before forced Alexander, to turn westward and march along the north-eastern end of lake Askania (lake of Buldur).

Professor G. Hirschfeld¹³ saw clearly the apparently insuperable difficulties which are occasioned by the supposition that Manlius marched from Termessos by Sagalassos. He recognized, what is indubitable to one who knows the country, that, if Manlius passed through the valley of Sagalassos, he must have been marching not from Termessos, but from Pamphylia proper, the country adjoining Perga, Attaleia, and Aspendos. On the other hand, Livy never mentions the advance of Manlius beyond Termessos; and the words of Polybios¹⁴ are opposed to such a supposition. But we now see that there is no necessity to suppose that Manlius ever went into the valley of Sagalassos; and, if we read Livy without that prejudice in mind, his account is clear, simple and accurate.

Manlius returned from the neighborhood of Termessos, crossed the river Istanos (Tauros), passed by Alifachreddin Keui (Xyline

¹³ *Reisebericht*, published in BERLIN. MONATSBER., 1879; also *Gratulationschrift der Königsberg. Univers. für d. archæol. Institut in Rom*, 1879.

¹⁴ Polyb. XXII, 18, ὁ δὲ Γνάριος συνεγγίνας τῇ Τερμησσῶ.

Kome), marched past Andeda and Pogla through the pass leading to the Gebren valley in several days (*continentibus itineribus*), sacked Kormasa in the Gebren valley, and then proceeded along the southern and eastern side of the Buldur lake (Askania, *παρά τῆν λίμνην*), through the territory of the Sagalassians. At the north-eastern end of the lake the road which he took joins the road from Sagalassos, by which, according to Prof. Hirschfeld's supposition, he would have travelled. Thus, we see that Manlius, after his interference in Pamphylian affairs, marched towards Galatia by the easiest and straightest way, which is marked out by nature as the proper road for a traveller. From the N. E. end of the lake Askania to the Campus Metropolitanus, I have, in a former paper,¹⁶ traced the route of the Roman army. I have only one addition to make to the reasoning in that paper. In it I proved that the *Rhotrini fontes*, mentioned by Livy, are the beautiful springs, called Bash Bunar, in the valley behind Apameia, and that the violent alteration of the text into *Obrimae fontes* could not be accepted. I did not observe that the true reading must be *Rhocrinus fontes*. The Greek name of the fountains is, as I then proved, *πηγή Ἀύλοκρηγή* or *Ἀύροκρηγή* or *Ἀύροκρηγή*: and the last form, with omission of the initial vowel-sound, gives the Latin form.

I may make one more slight alteration in the text of Livy.—From Kormasa, Manlius advanced to Darsa. On the route just described, Buldur would be the next town after Kormasa. Now Buldur is, as I shall hereafter try to prove, the ancient Durzela, Zarzila, or Zorzila. The change from Darsam to Darsilam is not great.

I have mentioned that the lake along which Manlius marched must be the Buldur Göl. Leake stands almost alone among modern geographers in holding this opinion: it is always pleasant to find new proofs of his marvellous sagacity in divining what has required many years to prove.

The inscriptions published above show that, during the first century after Christ, the district was included in the Roman province of Galatia. It was afterwards, when the province Lycia-Pamphylia was constituted, transferred to the latter, and it appears so in Ptolemy.

W. M. RAMSAY.

¹⁶ *Metropolitanus Campus*, in the JOURNAL OF HELLENIC STUDIES, 1883.

A HITTITE CYLINDER IN THE MUSÉE FOL AT GENEVA.

The Musée Fol at Geneva possesses a certain number of Assyro-Babylonian intaglios, and amongst others a cylinder in lapis-lazuli (48 by 15 cm.), which is of the deepest interest for Orientalists. F. Lenormant attempted an interpretation, which was printed in the Catalogue published in 1875.¹ He hinted at a royal cylinder, which of course would have added greatly to its value; but, according to him, the characters were so faint, so indistinct, that he did not venture to propose an identification where fancy would have held a larger place than reality. He thought, nevertheless, that the god *Nergal* himself could be recognized in the winged figure.

M. Ménant, who by his remarkable works stands in the front rank of Assyriologists, during his visit to Geneva in 1882 tried, but vainly, to find the royal sign. Since then, by taking many impressions of the same character and by the most careful attention, he succeeded in reconstituting the whole, except a few of the most indistinct signs. He thus became certain, that it was an Assyrian text containing an invocation to the god *Marduk*; but it was evident that it contained no royal sign. This fact is far from diminishing its value: our cylinder is one of the finest specimens of a series of intaglios still but little known and attributed to the Hittites. We give the subject twice (*fig. 13*) so as to show the inscription: it represents a figure whose head-dress is a sort of pointed tiara; he is clad in a short tunic fastened around the waist by a girdle; in each hand he holds a small animal, head downwards; his feet rest on winged chimeras which bend under the weight of his body. Behind him is a tree with three branches coming out of a sort of basket, and above, in the interval, is an inscription of four unequal lines in cuneiform characters.

¹ *Musée Fol. Etudes d'Art et d'Archéologie*, Vol. II, p. 79, pl. II, fig. 4 (No. 1386).

Though the characters, as just remarked, do not yield a good impression, M. Ménant considers as accurate the transcription which he gives.² We have here an Assyrian text which contains an invocation to the god Marduk, beginning thus: "In presence of the god Marduk, the lord, my master."

Lenormant has given the transcription and its explanation, as follows: (1) *Ina arduṭi Nergal kunuk*—(2) *Zbni*—(3) *abal Na*—(4) (signs of titles of functions) *šar* (here a name of country impossible to read). He translated it thus: *In the service of Nergal (the Babylonian Masongro) seal of Zbni . . . son of Na . . . (here a title of some unknown function of the king) . . . , (then the name of a country which cannot be read).* Lenormant also



FIG. 13.

hinted that the winged god, subduer of monsters, represented on the cylinder might very well be Nergal himself. But, according to M. Ménant, the word *arduti* is not to be found, nor is the ideogram of Nergal, or *kunuk* (fig. 14). He says, "The first line, such as we have reconstructed it, may be considered as correct; as to the third, Lenormant mistook the sign *i* for that of 'filiation.' Finally, the signs of our fourth line are right; the translation is very difficult on account of the last group, the form of which is not doubtful, but its signification is still unknown; and, as concerns the word *šar*, king, it is most decidedly not there, nor is the word *mat*, country."

The figure engraved on the cylinder is then undoubtedly that of

²Cf. *Glyptique Orientale*, Vol. II, p. 116.

the god Marduk, the Merodach of the Bible, and not Nergal. We agree with M. Ménant in attributing the style of the subject to the art of the Hittites: the position, the dress of the figures, the animals which support it, everything shows the influence of this people, traces of whom are to be seen at several points of Asia Minor, at Boghaz-Keui,³ Eujuk, Karabel, Birejik, and Jerablus, from Carchemish to the shores of the Aegean sea.

The cylinder of the Musée Fol takes its place by the side of the intaglios of Asia Minor. These intaglios are very numerous, and the work of M. Sorlin d'Origny on the specimens of his collection, which we hope soon to see published, allows us to look for many a point of comparison. Lenormant enumerated among the plates of Lajard's *Culte de Mithra* seventeen cylinders which he attributed to the Hittites, and M. Ménant accepts this attribution for the greater part of them. Those which the French savant assimilates to

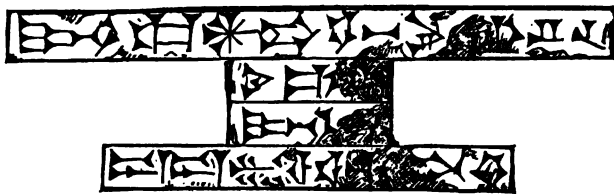


FIG. 14.

that of the Musée Fol, most of which are still inedited, seem to be of real interest from the point of view of epigraphy. The presence of Assyrian and Hittite wedges opens a wide field of investigation, as on one of them⁴ are to be found, in cuneiform characters, names which have no Shemitic form, while the Hittite writing, isolated, and looking almost like an ornament added to the design, sufficiently indicates the origin of the intaglios, even if this were not proved by the workmanship itself. We need not wonder at the widely-spread use of the cylinder among the Hittites. That mercantile nation, in

³The ancient Pteria.—There is no need to mention here all the works written on this subject; it is enough, we believe, to cite the names of William Hayes Ward, Wright, Sayce, who first took up those ungrateful researches of such vivid interest for Oriental science.

⁴J. MÉNANT. *Glyptique Orientale*, Vol. II, p. 117. No. 110.

constant intercourse with its neighbors, had felt the Assyro-Babylonian influence, and accepted this method of signature, imposed by the mighty civilization which ruled the Eastern world. The Hittite terracotta seals belonging to M. G. Schlumberger denote the use of clay to seal or label commercial transactions.⁵

To return to our cylinder, as we have stated in the beginning, it belongs to the style of the finest Hittite monuments, and shows the same distinctive marks that are to be seen on them. The figure supported by chimeras reminds us of the divinities at Boghaz-Keui, the pointed head-dress is also similar to their high tiaras.

ÉMILE DUVAL.

⁵ RYLANDS. *Proceedings of the Society of Biblical Archaeology*, Feb. 1884; and *Transactions of the Society of Bibl. Arch.*, Vol. VIII, part 3, p. 422.

A PROTO-IONIC CAPITAL FROM THE SITE OF NEANDREIA.*

II.

Reference has already been made to the fact, that the monuments of the earliest period of architectural development among the Greeks were, with but few exceptions, lost to science through having been replaced by buildings of the more advanced styles. The preservation of so primitive a memorial as this capital is to be accounted for by the position of Mount Chigri, and, especially, by the history of the ancient city which occupied its summit. The identification of the ruins is of direct value in connection with the archæological consideration, as it supplies a *terminus ante quem* for all discoveries made upon the site thus fortunately spared.

Chigri-Dagh is formed by cliffs of granite, rising steeply to a height determined by the surveyors of the English admiralty³⁷ as 1648 ft., and by Virchow³⁸ as 499.9 met. The barometrical readings of the Assos expedition served only to verify these estimates, the difference between which is but about three metres. Chigri is thus the most prominent landmark of the Troad, north of Saqa-Kioh and west of the Skamandros.

The view from the summit is magnificent. Upon the north is the plain of Ilion, divided by the silver line of the Skamandros; beyond are the Hellespont and the Thracian Chersonesos. Every curve of the western coast of the Troad can be traced. The imposing ruins of Alexandria Troas, to which town the primitive inhabitants of Chigri were removed by Antigonos, are easily discerned, and opposite to the half-submerged mole of this once populous metropolis, lies Tenedos,

* Continued from vol. II. p. 20, of the JOURNAL.

³⁷ Admiralty map No. 1608. *Entrance to the Dardanelles*, surveyed by Spratt, 1840.

³⁸ R. Virchow, *Beitraege zur Landeskunde der Troas. Aus den Abhandl. d. Kgl. Akademie der Wissenschaften zu Berlin* 1879. Berlin, 1879.

which, in still more ancient times, had been colonized by Tennes, son of the king of Kolonai and Neandreia (Chigri),—thereby receiving the name by which it is known even to-day. North of Imbros, Samothrake, the mighty seat of Poseidon, rises precipitously from the blue waters of the Aegean, and far beyond the low and hazy hills of Lemnos, the setting sun outlines with wonderful distinctness the conical peak of Athos,^{39a} more than one hundred and seventy-five kilometres distant: thus, the horizon is bordered by the sacred sites of the Kabeirian mysteries and the holy mountain of Eastern Christianity; while prominent in the foreground is the domed mosque of Kemaly. To the east stretch the fertile plains of the Samonion, once a territory of Chigri; beyond are the majestic heights of Ida. On the south, the violet crest of Mount Lepethymnos, in Lesbos, rises above the volcanic ridge which borders the Adramyttian gulf. The scene of the Iliad is spread out before the beholder like a map.

The uneven summit of Chigri is fortified by extensive walls, of an irregular rhomboidal plan. The greatest length of the enclosure, from east to west, may roughly be estimated as one kilometre, while its greatest width is less than one third as much.³⁹ The ramparts are of hewn stones, polygonal and square, dating to various periods anterior to the fourth century B. C. They are skilfully planned to profit by the natural advantages for defence of this rocky height, and, being in an exceptionally good state of preservation throughout their entire length, they are among the finest monuments of Greek military engineering in Asia Minor. The city is approached from the north-

^{39a} This spectacle, little less than marvellous in view of the great distance from shore to shore, has been observed by the writer on many occasions: from Chigri, from the coast between Alexandria Troas and Lekton, and even from the much more remote summit of Mount Ida. It has been referred to by several authorities. *Clare conspicitur Athos cum coelum est serenum, ex Hellesponto et Asiatico litore, multo autem clarius ex Ida Monte*, says Vossius in the observations (*ad lib. ii. cap. 2*) attached to his edition of Mela, Hagae Comitum, 1658.

We are reminded of the saying of the ancients, repeated by many writers, that the shadow of Athos was cast upon the market-place of Lemnos at noon, or (and this was undoubtedly the original meaning of the fable) by the setting sun at the time of the summer solstice.

³⁹ Newton, whose work will be cited below, judges the summit to be "more than a mile long," from the fact that it took him twenty minutes to walk the distance; but it is evident that this estimate is too great. Calvert's measurement, published by Pullan and repeated, without acknowledgment, by Schliemann, gives 1900 paces as the length, and 520 paces as the breadth of the enclosure.

east by a grand causeway, paved with slabs of stone, and evidently of great antiquity. The chief entrances to the enclosure are at the north-east and at the south, and are particularly important. They are flanked by square towers very similar to those of the main gateway at Assos, their monolithic lintels and jambs showing traces of the bolts and battens. It is not the present purpose, however, to give any adequate account of these fortifications, or of the ruins of the city itself; though it may be remarked that the capital which is the subject of this paper and the fragments of the painted terracottas which undoubtedly belonged to the same building, were found in the north-west corner of the enclosure.

The first explorer who is known to have visited the ruins of Mount Chigri is Pococke,—the earlier travellers in the Troad who penetrated beyond the port of Alexandria Troas, such as Belon (1554) and Du Loir (1654), not having gone farther inland than the hot springs of Lidja. Pococke⁴⁰ calls the site Chigur, and identifies it with Skepsis, from the similarity of the name of that ancient town to that of the neighboring village of Eskiupjee (Eski Skupchu). De Vaugondy's ancient map of Asia Minor,⁴¹ published fifteen years after Pococke's last volume, gives Cocyllum (Kokylion) in the position of Chigri. Kokylion is one of the towns of the Troad mentioned by Pliny⁴² as deserted in his time, and its identification with Chigri rests solely upon the similarity of the names. Whether this was due to the map-maker alone, or to some traveller previous to 1760, other than Pococke, it is not possible to say. Lechevalier⁴³ subsequently adopted the name Kokylion from the village of Qocholobassy, to the north of Chigri, which mountain he calls Kiril-Dagh. This misleading method of identification was also practised by Choiseul,⁴⁴ whose assumption that Chigri was the site of Kenchreai is still the most generally accepted. Choiseul's authority was in this respect greatly strengthened by the endorsement of Leake⁴⁵ and

⁴⁰ R. Pococke, *A description of the East and some other countries*. London, 1743-45. Part two.

⁴¹ *Asia Minor*. Auctore R. de Vaugondy. Paris? 1760?

⁴² Pliny, v. 32. Compare also Xenophon, *Hell.* III. 1. 16.

⁴³ J. B. Lechevalier, *Voyage de la Troade, fait dans les années 1785 et 1786*. (Third edition) Paris, 1802.

⁴⁴ M. G. A. F. de Choiseul-Gouffier, *Voyage pittoresque de la Grèce*. Paris, 1782-1809, Vol. II.

⁴⁵ W. M. Leake, *Journal of a Tour in Asia Minor*. London, 1824.

Webb.⁴⁶ Some account of the interesting geological aspects of Chigri is given by Tchihatcheff;⁴⁷ he makes, however, the error of speaking of the formation as a trachyte. The more modern travellers who have visited the ruins are Newton,⁴⁸ whose excellent description has been referred to; Pullan,⁴⁹ who published Calvert's notes; and, within the last few years, Meyer,⁵⁰ Schliemann,⁵¹ Virchow,⁵² Diller, the geologist of the Assos expedition,⁵³ and Jebb.⁵⁴

Compared with the many visitors to the neighboring towns, this is but a short list. Perhaps the neglect of Chigri may in some measure be attributed to the evil repute of this lonely mountain as the resort of brigands, Commander Spratt having had a narrow escape from one of these bands while visiting the site. Many travellers have passed directly by the foot of the hill on the road from Eziné to the ruins of Alexandria Troas, without making the ascent.

The identification of Chigri as Kenchreai, proposed by Choiseul and favored by Leake, Webb and Virchow, is, as before mentioned,

⁴⁶ P. B. Webb, *Osservazioni intorno allo stato antico e presente dell' agro Trojano*; first published in Acerbi's *Biblioteca Italiana*, Milano, 1821; written by the author for that journal and translated under his supervision.

⁴⁷ P. Chikhachev, *Asie Mineure, description physique, statistique et archéologique de cette contrée. Quatrième partie*. Paris, 1853-60.

⁴⁸ C. T. Newton, *Travels and discoveries in the Levant*. London, 1865.

⁴⁹ R. P. Pullan, in Murray's *Handbook for travellers in Turkey in Asia*. (Fourth edition) London, 1878.

⁵⁰ E. Meyer, *Geschichte von Troas*. Leipzig, 1877.

⁵¹ H. Schliemann, *Ilios: Stadt und Land der Trojaner*. Leipzig, 1881. The slight notes given in the *Reise in der Troas im Mai 1881* (Leipzig, 1881) are reprinted in *Troja*. London, 1884. Schliemann's statement (*Ilios* p. 57), that there is no accumulation of débris on Mount Chigri, is misleading. The native rock does, indeed, crop out in many parts of the fortress, notably at the south-east and north-east corners, where peaks of trachyte rise even above the fortification walls: yet, throughout the greater part of the enclosure, there is a soil of considerable depth, as is evident from the fact that the summit of the mountain serves as the pasture for a great number of horses and cattle at a season when the lower plains have been parched by the summer sun. Schliemann's further assertion, that "only here and there a late Roman potsherd and some fragments of bricks of a late date" were to be seen, is absolutely incorrect. Careful examinations of the site, on several occasions, failed to bring to light any remains more recent than of the fourth century B. C.

⁵² Virchow's barometrical measurement of the height, given in the *Beitraege zur Landeskunde der Troas*, quoted above, is printed also in Schliemann's *Ilios*.

⁵³ J. S. Diller, *The geology of Assos*, in Clarke's *Report on the investigations at Assos*, 1881. Boston, 1882.

⁵⁴ R. C. Jebb, *A tour in the Troad: in the Fortnightly Review*, No. cxcvi. London, 1883.

that generally accepted.⁵⁵ This assumption can be definitely disproved. Kenchreai is of interest as one of the cities which claimed to have been the birthplace of Homer (Soudas, s. v. *Ὅμηρος*), and as the place where the great poet dwelt while familiarizing himself with the scenes of the Trojan war (Steph. Byzant. s. v. *Κεγχρῆαι*). But Kenchreai existed as a citadel at a date long after Chigri must have been deserted. Georgios Pachymeres (*De Mich. Pal.* vi. 24) informs us that the emperor Michael Palaeologos confined the unfortunate Manuel in this fortress. The same writer (*De Andron. Pal.* v. 27) describes in detail the taking of Kenchreai by the Turks,



FIG. 15.—Sketch-map of the ancient Troad.

soon after the beginning of the fourteenth century : he relates that, after having held out for some time, it was compelled to surrender from lack of water, and was burned by the enemy. Nothing is more certain than that this citadel was not situated upon Mount Chigri, where no Byzantine remains whatever are to be met with. The writers who have advocated the identity of Kenchreai and

⁵⁵ Compare: J. A. Cramer, *A geographical and historical description of Asia Minor*. Oxford, 1832; and C. Texier, *Asie Mineure, description géographique, historique, et archéologique des provinces et des villes de la Chersonnèse d'Asie*. Paris, 1862. One of the volumes of *L'Univers*.

Chigri must either have been ignorant of the reference made to that ancient town by Pachymeres, or not well acquainted with the character of the remains upon the site. Kenchreai is undoubtedly to be identified with Kiz-Kalessi,—a citadel upon the north of Chigri, and one of the few sites of the Troad which were fortified in Byzantine times. Not having been occupied by the Turkish conquerors, it still shows traces of the fire by which it was destroyed.

The ancient atlas of Smith, and that of Kiepert, as well as the map in Mueller and Duebner's edition of Strabo, place Kolonai upon the site of Chigri. In like manner Eduard Meyer, one of the best informed of all the travellers in the Troad, speaks of the remains as those of Kolonai. It is not strange that this commanding height should have been identified with the stronghold chosen as a retreat by the Spartan Pausanias while carrying on his treacherous negotiations with the Persians.⁵⁶ Nevertheless it is certain that Kolonai was situated much nearer to the sea than Mount Chigri. Xenophon (*Hell.* III. 1, 13 and 16) twice mentions it as a maritime town, and the testimony of Strabo is even more explicit, for he describes it as lying on the sea (589), and on the coast opposite Tenedos (604). The latter assertion is made also by Diodoros (v. 83. 1) and by Pausanias (x. 14. 2). As will be explained below, the passage of Skylax in which Kolonai is mentioned must be taken in the same sense. Among those ancient writers whose mention conveys any indication of the situation of the town, there remains only Pliny (v. 32), who says distinctly enough *intus Colone intercidit*, but whose testimony concerning the Troad is of but little value, especially in the case of those cities which, like Kolonai, were deserted more than three centuries before his time. Even the name *Kolōnai* is characteristic of such mounds as those of the tertiary formation found on this coast of the Troad, and would be entirely inexplicable in connection with the granite mountain of Chigri.⁵⁷

⁵⁶ Thouk. i. 131; Diod. xiv. 383; Corn. Nep., *Paus.* 3.

⁵⁷ F. Calvert,—*On the site and remains of Colone*, in the *Archæological Journal*, vol. xvii. London, 1860,—believes the narrow summit of Beshik-Tepch, three miles north of Eski-Stambol (Alexandreia), to be the true site of Kolonai. But the distance of this place from Strabo's Ilios is less than the one hundred and forty stadia designated by the geographer. It appears, moreover, from another passage (Strabo, 604) that Alexandreia was founded between the tract known as the Achaiion and Kolonai, and that we must consequently look for the latter town south of the great metropolis of the Diadochi.

All indications favor the identification of Mount Chigri with the ancient Neandreia. This view, first suggested by Calvert,⁵⁶ is based upon the description given by Strabo. Strabo states that the Neandreians were situated above Hamaxitos,—the position of which town is determined, by the notices of it in other passages, as close to Lekton (604), near Larissa (440) and the Sminthion (605),—on this side (i. e. to the north) of Lekton, but further inland and nearer Ilion, from which they were distant one hundred and thirty stadia.⁵⁷ Strabo states, also, that the territory of Assos and its colony Gargara was bounded by the tracts belonging to Antandros, Kebrene, Neandreia and Hamaxitos (606), towns which are thus seen to lie almost in a semi-circle around the region in question; and further, that the plain of Samonion (now known as that of Bairamitch) belonged to Neandreia (472),—a district that would naturally be under the domination of the stronghold of Mount Chigri. Strabo moreover tells us that the inhabitants of Neandreia, together with those of many other cities of this region, were removed by Antigonos to the newly established town of Alexandria Troas. Pliny, a little later, speaks of the site as deserted (v. 32).

A similar conclusion is to be derived from a mention of Neandreia by Xenophon (*Hell.* III. 1, 13–16). Mania, the satrapess of the province, whose chief seat was in the interior of Kebrene and Skepsis, possessed Neandreia, and extended her dominion by reducing the maritime towns of the south-western Troad, Larissa, Hamaxitos and Kolonai, which had remained in the possession of the sea-faring Greeks. On the arrival of the Spartan Derkyllidas, these three towns surrendered at once, as did, within one or two days, Neandreia, Ilion, and Kokylion, after the fall of which places Kebrene was besieged. Xenophon's enumeration of the towns can leave no doubt as to the route followed by Derkyllidas. The Spartan general must have landed at the ancient port of Lekton, and have moved into the valley of the Skamandros by the natural pass upon the north of Mount Chigri, taking the town of Neandreia upon its summit, which, it is to be observed, is the first named after leaving the sea at Kolonai. At the present day, the main road of the

⁵⁶ F. Calvert, *On the site and remains of Kebrene*, in the *Archæological Journal*, vol. XXII. London, 1865.

⁵⁷ Strabo, 606. Korai's emendation, *μεσογυβίτροποι δὲ* for *μεσογυβίτροπέ τε*, is self-evident.

country, by which the wine of Tenedos is carried to Eziné and Bairamitch on the Menderé, follows the same route.

Opposed to this weight of evidence, we have the statement of Skylax (p. 36) that Neandreia was situated on the sea. As at least those portions of Skylax relating to the coasts of Asia Minor are to be referred to a date anterior to that of the foundation of Alexandria Troas and the depopulation of Neandreia, it would be natural to give entire credence to this earlier authority, and to assume that Strabo, although evidently quoting from Demetrios of Skepsis, was mistaken in his identification,—were it not that it is plain, from internal evidence, that the passage in question is, as it stands, a misstatement throughout. Skylax, whose *Periplus* was characterized even by Bentley as “one of the most corrupt books in the world,” gives in his description of the Troad two lists, the one of inland towns: Sigeion, Achilleion, Achaiion, Kolonai, Larissa, Hamaxitos and Chrysa,—the other of towns on the sea: Kebrene, Skepsis, Neandreia and Pityeia. Now all those of the first list are well known to be situated upon the coast, while, of the latter list, both Kebrene and Skepsis were far inland. Pityeia does not belong to the Troad at all. It is thus plain that the classifications of the towns have been interchanged: that those of the first list were originally described as situated on the sea, those of the latter as in the interior.⁶⁰

⁶⁰The words of Skylax are: Καὶ ἐν τῇ ἡπείρῳ Σίγη καὶ Ἀχιλλεῖον καὶ Κρατῆρε Ἀχαιῶν, Κολῶναι, Λάρισσα, Ἀμαξιτὸς καὶ ἱερὸν Ἀπολλωνος, ἵνα Χρύσης ἱερᾶτο. Ἐντεῖθεν δὲ Διολὶς χώρα καλεῖται. Διολίδες δὲ πόλεις ἐν αὐτῇ εἰσὶν ἐπὶ θαλάττῃ αἰδε Κεβρῆν, Σκῆψις, Νεάνδρεια, Πιτῆεια.

The difficulty presented by this passage was evident to Mueller, and in a note to his edition of Skylax (*Geographi Graeci minores*, Parisiis, 1855, vol. i.), he inserts between αἰδε and Κεβρῆν the words: Ἄσσοσ, Γάργαρα, Ἀντανδρός· ἐν δὲ μεσογείᾳ αἰδε. This empiric change of the sense is actually adopted in the text of the last critical edition of Skylax, *Anonymi vulgo Scylacis Caryandensis periplus maris interni recensuit B. Fabricius* (H. T. Dietrich) Lipsiae, 1878. It by no means meets the difficulties of the case, the maritime towns still being described as inland. Were it desirable to restore the text, it would be more reasonable to simply interchange the lists, and not attempt to bring in the names of Assos, Gargara and Antandros. The towns on the Gulf of Adramyttion would not have been named before Kebrene and Neandreia.

It is surprising that so manifest a corruption should have misled writers upon ancient geography, otherwise most trustworthy. Thus, C. Mannert (*Geographie der Griechen und Römer aus ihren Schriften dargestellt*. Leipzig, Nuernberg, Landshut, 1829–31. Third edition) and A. Forbiger (*Handbuch der alten Geographie*. Leipzig, 1842–44) refuse all credence to Strabo, on the strength of this passage of Skylax. The latter author, in his second volume, describes Neandreia as a maritime town,

Hence, the testimony of Skylax may even be claimed in support of that of Strabo.

A passage of the greatest importance in reference to Neandria, and one to which attention has not been called by any writer upon the geography of the Troad, is given in Dictys of Krete.⁶¹ From this we learn that the Greeks before Ilion, being harassed by attacks of the inhabitants of the neighboring country, moved their forces against the towns situated nearest to Ilion, first invading the realm of King Kyknos, the chief place of which was Neandria. The Greeks took this citadel, and were about to destroy it by fire, but were persuaded to spare it by the prayers and tears of the inhabitants, who tendered their submission to the invaders and gave up the two sons and the daughter of King Kyknos, he himself having been slain, some time before, by Achilleus. Advancing, thereafter, beyond Neandria, the Greeks reduced Kylla, but left Kolonai unharmed, as that town belonged to the Neandreians and was protected by the alliance which had been concluded with them.

The manuscripts of Dictys, differing among themselves, show corruptions of the names: Neandria appearing as Meandria, Mentore or Metore, Kolonai as Corone. The first of these errors (*Meandri-*

enst of Gargara." Compare his position in Pauly (*Real-Encyclopædie der classischen Alterthumswissenschaft*, s. v. *Neandria* vol. v. Stuttgart, 1848), where he understands Skylax to place the town on the Hellespont. This is translated, without acknowledgment, in the notice on Neandria which, signed by Leonhard Schmitz, appears in Smith's *Dictionary of Greek and Roman Geography*, London, 1873. Forbiger's erroneous quotation of Skylax in support of the statement that Neandria was on the Hellespont is thus perpetuated. It may be remarked that Smith not infrequently presents to his readers stolen and garbled versions of Pauly's articles.

⁶¹ Dictys Cretensis, II. 12 and 13. The author twice refers to the realm of King Kyknos as adjoining Ilion.

The interest of the passage in question is not restricted to the geographical indications which it affords; it also furnishes an argument in favor of the belief that, in this much discussed work, there have been preserved, together with later and spurious material, some traditions of great age which are credible in the same sense as are those collected in the Homeric poems. Though the events recorded should be considered as romance rather than as history, the geography could not thus be invented. The author of the original work must have had an intimate acquaintance with the Troad, or at all events must have derived his information from sources of this character now lost to classical science. This may be well illustrated by a comparison of the work of Dictys with that of Dares, whose vapid descriptions of the Homeric heroes contain no mention of geographical details, or do not differ in these particulars from the earlier writings from which the book was compiled.

orum for *Neandriorum*, etc.) was pointed out nearly two centuries ago by the learned Perizonius.⁶² He based his conviction solely upon the accounts of Kyknos given by Malala (p. 124, Oxford ed.) and Kedrenos (p. 221), who, evidently deriving their information from Dictys, assert that King Kyknos lived in Neandreia, near Ilion. It is well known that these Byzantine writers frequently quote the *ipsisima verba* of the Greek Dictys. They were in possession of the original work, which has since disappeared, and their rendering of the geographical names is hence far more worthy of confidence than that of the copies of the Latin version of Dictys, now alone accessible to us. The conjecture of Perizonius thus admits of no doubt, and this correction is adopted in the latest critical texts.

The emendation *Colonen* for *Coronen*, naturally following the Latin orthography of the name as given by Pliny (v. 32) was suggested by Fuchs.⁶³ The three ancient writers who differ from Dictys, Malala, and Kedrenos in the name of the capital of Kyknos, namely Diodoros (v. 83. 1), Strabo (589 and 604) and Pausanias (x. 14. 2), agree in speaking of Kolonai as his dwelling-place. It is surprising that, notwithstanding this weight of argument, the emendation has been refused by Dederich,⁶⁴ and is not even referred to by Meister;⁶⁵ their editions of Dictys, the most recent published, still read *Corone*, while no place of that name exists in the Troad.

The testimony of the author of the Greek original must have been founded upon traditions, oral or written, which show an accurate acquaintance with the country around Ilion. Whether these legends do or do not recount the actual events of a predatory warfare, carried on by the Achaians in the Troad, they must at least have been so framed as to appear credible to the Greeks inhabiting this remarkable country during the historic period. As it is now read, by the aid of the Byzantine plagiarists and in the light of a familiarity with the Trojan landscape, the passage describes occurrences which would naturally have taken place in such a campaign.

⁶² J. Perizonius, *Dissertatio de historia belli Trojani*, etc. (Leyden?), (1701?). This essay was incorporated in the edition of Dictys published by L. Smids, Amsterdam, 1702, and in others since then.

⁶³ J. A. Fuchs, *De varietate fabularum Troicarum quaestiones*. Coloniae ad Rhenum, 1830. This excellent work is but very little known; the copy which has been on the shelves of the British Museum for half a century was found to be uncut.

⁶⁴ Dictys Cretensis, *Belli Trojani libri sex*. Ed. A. Dederich, Bonnae, 1833.

⁶⁵ Dictys Cretensis, *Ephemeridos belli Troiani*. Ed. F. Meister, Lipsiae, 1872.

According to the narrative of Dictys, the Greeks disembarked at the mouth of the Menderé, near the modern Koum Kaleh, and encamped in the plain. On their expedition against the country of King Kyknos they passed up the valley of the river, through the defile of Bali-Dagh, to the stronghold of Mount Chigri. After having come to terms with the inhabitants, the Greeks found but two courses open to them: to advance inland, across the plain of Bairamitch, or to turn to the south-east, towards the coast. By a further inroad they would have incurred the danger of being cut off by the enemy. Undoubtedly influenced by this consideration, the Greeks chose the latter alternative, reaching the sea south of Eski Stambol.

It is thus plain, that the legends of the Trojan cycle relating to King Kyknos originally designated both Kolonai and Neandreia as towns of his kingdom; the former as a seaport, the latter as a mountain fastness. All the episodes in the life of the hero relate to the sea, and it is probable that his residence was Kolonai, as the more trustworthy authorities assure us. The opposite island of Tenedos was colonized and named after Tennes, a son of Kyknos,⁶⁶ and the most prominent part taken by the king in the Trojan war was an attempt to prevent the Greeks from landing.⁶⁷ The citadel of Neandreia, on the other hand, must have been a stronghold and retreat; this is sufficiently indicated by the tradition given by Dictys (II. 13), that it was the abode (*nutrix*) of the children of the king. The legend which asserts Kyknos to have been the son of Poseidon and Skamandrodike⁶⁸ must doubtless be taken as significant of the sea and the river which formed the boundaries of his realm.

It is worthy of note, in this connection, that both Xenophon (*Hell.* III. 1. 16) and Strabo (472 and 606) speak of the Neandreians as a people; the latter, as has been seen, describing not the position of the town, but that of the tract which bore its name. This is explained by the fact that Neandreia, like Assos, was, at a very early period, the capital of a small independent kingdom, which continued in the memories of the inhabitants long after the entire Troad had been included in a much wider dominion.

⁶⁶ Steph. Byzant. s. v. Τένεδος; Suidas, s. v. Τενέδιος ἄνθρωπος; Cicero, in *Verrem*, act. II. 1. 19; Konon, *Narrat.* xxviii; Plutarch, *Quæst. Græc.* 297; Servius, *Commentary to Virgil, Aen.* II. 21; and the other authors quoted in this connection.

⁶⁷ Aristotle, *Rhet.* II. 22. 12.

⁶⁸ Scholiast to Homer, *Il.* A. 38; Scholiast to Pindar, *Ol.* II. 147; Tzetzes, *ad Licoph.* 233; and Eudocia, *Viol.* p. 264; for a different account, see Hyginus, *Fab.* 157.

No further information is to be derived from the references to Neandreaia made by Theopompos (Fr. 310) and Charax (Fr. 4), preserved in Stephanos of Byzantion.⁶⁹ The town was naturally included in the province of the Hellespont, and was so described. These writers are, however, to be quoted as completing the list of ancient authors who make any mention of this place.

The indications obtainable from the coins of Neandreaia lend further weight to the conclusions derived from classic literature. The head of Apollon, who was evidently the chief deity of the town,⁷⁰ generally appears upon the obverse, while the symbols of the reverse suggest the advantages derived by the inhabitants of the citadel from the pastures and cultivated fields of the great Samonian Plain. A grazing horse and an ear of wheat formed the most common types,⁷¹ and a ram occurs upon a fine coin of the fifth century, now in the British Museum.⁷² It is a point particularly worthy of remark, that a coin published by Sestini⁷³ was re-struck with an incuse stamp ΑΑΞΑΝ, without doubt to facilitate the circulation of the old mintage in the city to which the inhabitants had removed. It is evident, that the Neandrians formed an influential part of the population of Alexandria Troas, from the fact that the coins of the latter town, during the first three centuries of its existence, display the two types characteristic of the Neandriaian mintage: the head of Apollon⁷⁴ and the grazing horse.

⁶⁹ Steph. Byzant. s. v. *Νεάνδρεια*. Compare also the mention s. v. *Φαυρία*.

⁷⁰ It must have been with reference to this cult, and to that of the neighboring Chrysa, that Strabo (p. 618) declared Apollon to be the chief deity of the south-western Troad. Tenedos also worshipped Apollon, following in this respect its parent city, even as early as the time of the Homeric poems (*Iliad*, i. 38, 451, etc.), in the same manner as did Alexandria Troas in the age of the Diadochi. The especial protection granted by Apollon to the Trojans and their allies, and the prevalence of his worship among them, are striking features of the *Iliad*.

⁷¹ Coins of Neandreaia were found at Assos. The writer can quote, in reference to this subject, no publication more recent than that of Borrell, entitled *Unedited Greek Coins*, in *The Numismatic Chronicle*, vol. v. 1. London, 1843. Compare also T. E. Mionnet, *Description des Médailles Antiques*, vol. v. Paris, 1830.

⁷² A coin of this kind is engraved in the work of Sestini which is quoted in the following note, pl. add. III. The head on the obverse, horned and bearded, is erroneously held by the author to be that of Pan.

⁷³ D. Sestini, *Descrizione delle medaglie Greche. Parte seconda*. Firenze, 1829.

⁷⁴ On the worship of Apollon in Alexandria Troas see, also, the inscription from that place, published as No. 3577 of the *Corpus Inscr. Graec.*; together with Boeckh's remarks thereon.

Concerning the political history of the place, it is not here necessary to enter into detail. Its chief interest⁷⁵ attaches to the appearance of Neandreia among the towns tributary to Athens, in the well-known inscription, dating to the third quarter of the fifth century, which has been published by Rhangabé.⁷⁶ The amount of the contribution, mentioned with each occurrence of the name, permits an interesting comparison with that paid by the neighboring towns of Assos, Sigeion, Kebrene, Gargara and Lamponeia. The efforts of this confederation were not successful, but the second subjugation of the Troad by the Persians was soon followed by the Asiatic conquests of the Greeks, and by the consequent removal of the population of Neandreia to increase that of the thriving port of Alexandria Troas.

Thus this remote fortress, deserted by the generation succeeding Alexander the Great, has remained an undisturbed ruin for twenty-two centuries. Romans, Goths, Armenians and Franks claimed the site as their own, the Byzantine Greeks were finally driven altogether from the land by the Seljukian and Ottoman Turks, and the first heed paid to the overthrown monuments of the ancient town should be credited to the Archæological Institute of a continent not dreamed of by Kalchas or Kassandra.

JOSEPH THACHER CLARKE.

⁷⁵ Brugsch, in his *Troy and Egypt* (appendix ix to Schliemann's *Ilios*, quoted above) suggests that the Trojan Kolonai is to be identified with the Kerena or Kelena mentioned in an inscription engraved upon the walls of a pylon of the temple of Medinet Abou, which gives a list of thirty-nine towns of the Asiatic coast and the neighboring islands whose contingents were defeated by Rameses III in the 13th century B. C. This theory is rendered particularly attractive by the fact, now placed almost beyond question, that both the Dardanians and the Asians fought against Rameses II only a century before, and are named in the famous poem of Pentaur. Nevertheless, a careful consideration of the context,—especially of the names of those places which are recognizable with some degree of probability,—leads the writer to believe that the town in question must have been situated at least as far south as Kypros. The statement made by Brugsch in his *Geschichte Aegyptens unter den Pharaonen* (vol. II. Leipzig, 1878), that the Kerena of the Egyptians was Kerynia, appears much more reasonable.

⁷⁶ A. Rhizos Rhankabes, *Antiquités Helléniques*. Athènes, 1842-55. Vol. I. No. 236, etc.; most recently in the *Corpus Inscr. Attic.* Vol. I. No. 226.

EGYPTIAN ANTIQUITIES.

TWO PTOLEMAIC INSCRIPTIONS.

Among other objects in an Egyptian collection belonging to Mr. Joseph W. Drexel of New York, now on exhibition in the Metropolitan Museum of Art, are two small marble slabs which were obtained by Mr. Drexel from an Arab in Thebes, some time since. Nothing is known of their place of discovery, but of their place of dedication something will be said below.

I.

On a slab measuring about six by eight inches, is an inscription covering some two-thirds of the surface:—

ΥΠΕΡΒΑΣΙΛΕΩΣ ΠΤΟΛΕΜΑΙΟΥ
ΤΟΥ ΠΤΟΛΕΜΑΙΟΥ ΚΑΙ ΒΑΣΙΛΙΣΣΗΣ
ΑΡΣΙΝΟΗΣ ΘΕΩΝ ΦΙΛΟΠΑΤΩΡΩΝ
ΤΕΩΣ ΩΡΟΥ ΦΥΛΑΚΙΤΗΣ
ΤΟΠΟΥ ΑΜΜΩΝΙΕΙΟΥ

*ὑπὲρ βασιλέως Πτολεμαίου
τοῦ Πτολεμαίου, καὶ βασιλίσσης
'Αρσινόης, θεῶν Φιλοπατόρων,
Τέως Ὁρου φυλακίτης
τόπου Ἀμμωνείου.*

“In behalf of king Ptolemy, son of Ptolemy, and queen Arsinoe, the gods Philopatores, Teos son of Horos, warder of the district Ammonieion, (has consecrated this).”

The letters, half an inch high with wide and deep incisions, are irregular in form and considerably crowded, without ornamental apices. A and Λ tend to advance the right limb beyond the left at apex, distinctly so in some cases; ξ not Σ; Ω smaller than the average letter, and with wide opening; Ο and Θ still smaller; Ι and Φ long; right limb of Γ long and even meets the line; in one

case H assumes the curves which characterize it when drawn with the reed.

The inscription falls within the reign of Philopator, 222–204 B. C. Teos, the name of the dedicator, is said by Brugsch (*Lettre à M. de Rougé*, p. 53) to be an Egyptian demotic name; it occurs several times in the papyri, and is even mentioned by Manethon as that of a Sebennytic king of the xxx Dynasty. Horos is likewise Egyptian, and Brugsch, in the work above cited, has traced it in the papyri, as transmitted from 220 B. C. for more than a century in a family of western Thebes, connected with the temple of Ammon as *pastophoroi* or *cholchytai*. No Teos son of Horos appears in his list, but Teos is a name recurring several times among those to be buried in the tombs belonging to this family. One is a goose-feeder (*χρηνοβοσχος*), another a pilot (*κυβερνήτης*). The Teos of our inscription is a member of the standing force required to protect and to act as the police of the country. A letter is preserved (*Lettre*, p. 61) written by Osoroeris, a member of the Horos family, to Dionysios who is designated as the commander of cavalry and *phylakitai* of the Theban district (*ἱππάρχη ἐπ' ἀνδρῶν καὶ ἀρχιφυλακίτη τοῦ περὶ Θήβας*), in which complaint is made to him that some of the tombs belonging to Osoroeris had been entered and plundered, and redress is implored. Mention is made of a similar officer and his *phylakitai* in several other papyri of the Louvre, in one of which they are sent to search the Serapeion at Memphis. Hence the meaning of the term is quite beyond doubt, and the sense of "prisoner" given to it by Liddell and Scott (*Lex. sub voc.*) is wholly inadmissible as applying to the Philae inscription, *C. I. A.* 4896 c 7. Sophocles (*Byz. Lex.*) rightly interprets it "guard." The commanders of the *phylakitai* bear Greek names, but the men themselves may be Egyptians, as shown by our inscription, and by *Papyrus Louvre* 42, where the name Arpaeses occurs.

The *topos* is a subdivision of the larger nome, and in this case the Ammonieion is one of the *topoi* of the nome Perithebas, or district about Thebes, and took its name from the temple of Ammon-Ophi, or the Ammon who presides at the house of the dead at Ophi (Brugsch, *loc. cit.*) in western Thebes (*Ἀμένωφις τῶν περὶ τὰ Μεμνόμενα*), the temple with which the Horos family were connected as *cholchytai*, and the one in which it may reasonably be supposed this slab was dedicated.

II.

On a slab, eleven inches long by seven wide, of harder stone than No. 1. The left side is broken away at surface, as well as at right upper corner :—

. ΑΞΙΛΕΩΞ ΠΤΟΛΕΜΑΙΟΥ ΘΕ . .
 . ΕΓΓΑΛΟΥ ΦΙΛΟΓΑΤΟΡΟΣΞΩΤΗΡΟΣ
 ΚΑΙΝΙΚΗΦΟΡΟΥ ΚΑΙΤΟΥ ΥΙΟΥΓΤΟΛΕΜΑΙΟΥ
 ΙΞΙΔΙ ΞΑΡΑΓΙΔΙ ΑΡΟΛΛΩΝΙ
 ΚΟΜΩΝ ΑΣΚΛΗΓΙΑΔΟΥ
 ΟΙΚΟΝΟΜΟΣΤΩΝΚΑΤΑΝΑΥΚΡΑΤΙΝ

*ὅπερ β]ασιλέως Πτολεμαίου θε[οῦ
 μ]εγάλου Φιλοπάτορος σωτήρος
 καὶ νεκροφόρου, καὶ τοῦ υἱοῦ Πτολεμαίου[υ],
 Ἰσιδι Σαραπίδι Ἀπόλλωνι
 Κόμων Ἀσκληπιάδου
 οἰκονόμος τῶν κατὰ Ναύκρατιν.*

“In behalf of king Ptolemy, the great god, Philopator, saviour and winner of victory, and his son Ptolemy, to Isis, Sarapis, Apollon, Komon son of Asklepiades, steward of monies at Naukratis, (has dedicated this).” The letters, about three-eighths of an inch in height, are very neatly and prettily cut, many with elaborate ornamental apices, especially Γ. Λ is usually λ; Α sometimes with similar apex; Ω is of full size and narrow at base, Ο one-third smaller; Ξ has its horizontal limbs parallel; one Μ curves somewhat within; Ι is of the height of the other letters, Φ longer. The Κ of ΚΟΜΩΝ has been considerably injured. The important words are separated as indicated above.

This dedication must have been made between 209 B. C., when Philopator’s son Epiphanes was born, and the death of his father 204 B. C.; but where it was deposited is not so easily determined. Did Komon visit Thebes and there consecrate his offering for the well-being of the royal family in some temple especially devoted to the deities of health and strength, himself the son of Asklepiades, a name affected by Asklepiad families? Or has this slab passed from hand to hand, in recent days, to Thebes from the mound of Naukratis itself? Of which mound Mr. Petrie says (*Egypt Exploration Fund Report*, 1885, p. 14): “To-day all the heart of it is gone, spread out on the fields of the country to enrich the clover and barley of the

peasantry, and the antiquities which it contained cast forth without a name or history among the collections of the world, if their intrinsic worth prevented their immediate destruction." The remains of a noted temple of Apollon at Naukratis have been among the richest results of Mr. Petrie's excavations there. On the other hand, if it came from the Ammon temple at Thebes, it is barely possible that Isis, Sarapis, and Apollon were there worshipped as associated gods, as we know (Brugsch, *Lettre*) invalids were often taken there, in the hope of a miraculous or other cure.

It has been maintained by Boeckh (*C. I. G.* 3562) that the title of *oikonomos* of a city belongs only to late inscriptions, though, how late, it is not definitely stated (cf. Dittenberger, *S. I. G.* 470). The title in our inscription is somewhat vague, but may be compared with *ὁ ταμίας ὁ κατὰ πόλιν*, of the *prætor urbanus* at Rome (Reinach, *Traité d'Épigraphie*, p. 534). Komon's province, however, may have been restricted to narrower limits than the whole city.

MUMMY TABLETS.

The two tablets described below belong to a rather rare class in collections from Egypt. In the *Revue Archéologique* (xxvii) for July-Dec., 1874, and (xxix) Jan.-June, 1875, M. Edmond le Blant figured and described 95; and that was all of which he could obtain any knowledge in collections abroad. About half of these had been brought from Egypt by M. Batissier, and, from the micaceous sand adhering to certain of them, they were supposed to have come from the vicinity of Thebes, as indeed some of the inscriptions indicate. The remainder of the 95 were in the Louvre, at Florence, Turin, Leyden, Berlin, London, and Boulak. They are small, oblong tablets of wood, from three to eight inches in length, and usually less than half an inch in thickness, with one or both faces smoothed for the reception of an inscription. Towards the upper end a hole is usually pierced for a string, and on each side, near this hole, a notch is cut, giving it the appearance of a dovetail. The wood is of several varieties: plane, sycamore, acacia, and the conifers, pine, fir, and cedar. The use of these tablets was two-fold: they were affixed to the mummy either simply to designate the individual in the tomb, or to identify it and give directions for its transportation from the place of death and embalmment to that of entombment.

Of the former class the two given below are examples; for the latter we may cite the inscription of Le Blant's No. 46, "To Diospolis (Thebes): Pamontis son of Tapmontis: from Pandaroi."

The inscriptions are mostly in Greek. Le Blant mentions only two in hieroglyphs. They are commonly written with ink, in uncial characters, on one side of the tablet; but they are also engraved in the wood, sometimes after the ink has been applied. Some have the inscription continued or repeated upon the back of the tablet, and a few have the divinity Anubis, dog or jackal, outlined there.

The two specimens which form the subject of this article were obtained by Dr. W. C. Prime, of New York, during his visit to Egypt in 1855-6, and are now in his possession. "They were found among a lot of trash in an Arab's possession on the west bank of the Nile near Sakkara; or it may have been farther up the river."

I.

Length $4\frac{1}{2}$ inches, width of body $3\frac{1}{2}$, from notch to notch $2\frac{1}{2}$, width of top $2\frac{1}{2}$, width of hole about $\frac{3}{8}$: lateral edges beveled down on front face, where the inscription is engraved in deep and rather angular letters, in lines running from top to bottom, lengthwise on the tablet. A has the v-bar, ω is angular, C lunar with projecting upper limb. It reads:

CAPAΠOΔ
ΩPOCKTI'
KΑΛHTOC
ET'MH

Turn the tablet over towards you, and you find the same repeated in ink, with freer movement and rounder letters; A with v-bar as before:

CAPAΠOΔΩP
OCKTI'KΑΛ
HTOCET'
MH

Σαραπόδωρος Κτι' Κάλητος ἐτ(ῶν) μῆ.

"Sarapodoros Kti. son of Kales, aged 48."

Kti. is, no doubt, the contraction of Ktistes, a name which occurs in Le Blant's list, No. 6, *Κτίστης Ὀρίωνος ἐτῶν λς*, and elsewhere.

II.

Length $4\frac{3}{4}$ inches, width $2\frac{1}{2}$, from notch to notch $1\frac{3}{4}$, hole about $\frac{3}{8}$. Letters farther from the monumental than No. 1. B narrow, I long, α, ε, C, ω as given, M formed by curves. Written across the tablet is :

B I O C C E
 N Π Ε Μ Δ
 Ο Υ Τ Ο C
 Η Γ Ε Μ Ω Ν
 Ε Τ Ω Ν Λ Η

Bios Σενπεμαούτος ήγεμών, ἐτῶν, λη.

“Bios son of Senpemaous, the guide, aged 38.”

Senpemaous is an Egyptian name, in which the element *Sen* means “child of,” and is a frequent component in proper names, commonly feminine, as is also the termination *-ούς -ούτος*. To designate a person by adding the name of the mother instead of the father, was common in Egypt, and occasionally the significant *πάτωρ* is added. With *ήγεμών* we may compare similar identifications by the occupation, as Le Blant's No. 73, *ἐξηγητής*; No. 81, *ἐξηγητέων ἐναρχος*; No. 13, *ναυπηγός*; etc.

These labels do not furnish any definite evidence to determine their age, but Le Blant has thought that they were later than the beginning of the Christian era, from the occurrence in some of them of the formula *οὐδεις ἀθάνατος*.

AUGUSTUS C. MERRIAM.

NOTES ON ORIENTAL ANTIQUITIES.

TWO SEALS WITH PHŒNICIAN INSCRIPTIONS.

I. Among other small objects obtained by me in Baghdad, while with the Wolfe expedition, are two seals with Phœnician inscriptions which deserve publication. One of these (*fig. 16*) is a light carnelian, 2.3 centimetres long, and 0.9 cent. thick; and is pierced longitudinally with a small hole. It is engraved with more than usual care and skill, with diamond point.

Instead of the usual mythological figures, it represents a scene in life, the submission of captives to a conqueror. Before a man whom we will call the prince, bareheaded and clad in Persian gathered skirts or trousers,—such as we see on the Akhæmenian monuments of Persepolis, Nakhshi Rustum and Behistun,—is a captive, kneeling, with hands bound, and apparently a rope around his neck. Behind



FIG. 16.

the captive stands an officer with a short coat, round shield and spear. Behind the prince is a second captive, standing, with hands bound behind his back and a rope around his neck. The two prisoners are naked, except that they both have on what appears to be a Greek helmet, which is worn also by the officer. This style of helmet, however, occurs occasionally with the round shield in Assyrian art: see Botta's *Monuments*, T. II. pl. 147. In Layard's *Monuments*, 2d series, pl. 44, a foreign tribe is seen with a similar head-dress of feathers. The prince is bareheaded, although it was to be expected that he would have on a square cap or crown. The following inscription, in the Phœnician character, runs lengthwise on the cylinder: 𐤕 𐤓 𐤕 𐤕 or 𐤕𐤓𐤕. Between the last two letters, the 𐤓 and the 𐤕, there is what I take to be an original flaw in the stone, as it has the shape of no letter, and is not cut in outline, but appears to represent a bit flaked out. The inscription ought to carry the name of the owner, which should be prefixed by the possessive preposition 𐤍. It

is not easy to suppose that נ can take the place of ל, but the last three letters would seem to give the Jewish name *Nathan*. The cylinder may be of an age soon after the capture of Babylon by Cyrus, as the Phœnician letters are of an early type.

II. Another carnelian seal (*fig. 17*), with a Phœnician inscription, is conoid in shape, with an oval cross-section like the ordinary Assyrian seal, and pierced near the apex. The larger diameter of the face is 1.8 centimetres, and the shorter is 1.3 cent. The height is 2.5 cent. This is one of the most perfect of its type I have ever seen. It is engraved on the face and on the two sides. On one side is the representation, so common on the Assyrian seals, of a worshipper, in a long tunic, standing before three of the peculiar and differing upright columns, or *asheras*, used for worship. One of these is surmounted by a crescent. On the other side is represented a man in a short military tunic, with a pointed cap or helmet, and with one arm



FIG. 17.

lifted vertically. Behind him is a human figure with the head of a lion, the god Nergal, perhaps, and with an arm similarly lifted. For the god Nergal, see Layard's *Monuments of Nineveh*, first series, pl. 82. The two figures do not apparently represent Merodach and Tiamat. Above them is the crescent. On the face is the representation of the divine triad, in which a smaller human head with one arm rises above each wing, on each side of the larger central head and bust. Beneath the divine emblem is a kneeling figure with both hands lifted, also two columns, or *asheras*, and the inscription (not reversed): 𐤆𐤌𐤍𐤏 or 𐤏𐤍𐤏𐤆, apparently, the last letter being perhaps 𐤍 or 𐤏. The characters are primitive, and the art probably belongs to the late Assyrian or the Akhæmenian Persian period. The divine triad is not a common object in Eastern art; a similar example is found in Layard's *Culte de Mithra*, xxxiii, fig. 3, where again we have a Phœnician inscription.

WILLIAM HAYES WARD.

THE TERRACOTTA HEADS OF TEOTIHUACAN.

[PLATES III, IV.]

I.

Forty-two years have passed since Brantz Mayer, referring to the clay heads that form the subject of this paper, spoke of their purposes being then entirely unknown to Mexican antiquarians:¹ seventeen years later, E. B. Tylor pronounced them to be "rather a puzzle:"² and, at the present day, the "riddle of the many heads," as it has been aptly termed by an eminent archæologist of our day,³ is practically unsolved. In the *Museo Nacional* of the City of Mexico the numerous specimens are labelled, inquiringly, "idols or ex-votos?" There has been no lack of interest, however, in these small works of art; and since Nebel, in his beautifully illustrated *Viaje pintoresco y arqueologico*, represented twelve of them, commenting upon the excellence of their workmanship, many writers have mentioned them and freely indulged in speculation and conjecture as to their origin and use. The diversity of head-gear observed in them has given rise to, and even been quoted in proof of, theories of the migrations of tribes, of the mixtures of widely differing races, or of their succession to each other,⁴ in the occupation of the Valley of

¹"They have evidently never been attached to bodies (of clay, is here meant) and their purposes are entirely unknown to Mexican antiquarians, although they have hitherto been discovered in great quantities at the foot of these teocallis." (B. MAYER, *Mexico; Aztec, Spanish and Republican*. New York, 1844, p. 227).

²"... mere heads which never had bodies (of clay) and will not stand anyhow. They could not have been personal ornaments, for there is nothing to fasten them by. They are rather a puzzle." (E. B. TYLOR, *Anahuac*. London, 1861, p. 229).

³Professor F. W. Putnam, Curator of the Peabody Museum, Cambridge, Mass., to whom the writer is much indebted for the interest taken in the present investigation and for kind encouragement.

⁴"One finds, among these masks that reproduce types of various Indian races with felicity and sometimes with art, strange faces that seem not to belong to America. Among the specimens reproduced in our engraving, one may observe a negro with

Mexico. Owing to the unfamiliar aspect of some of these head-dresses, it has been asserted that they could not be even "Toltec," but must be relics of still more remote, and unknown, races of men.⁵ Diverse uses have been assigned to them, but perhaps the commonest supposition has been that they were in some way connected with ceremonies relating to the dead.⁶

thick lips, flat nose, and woolly hair. One sees, also, a Chinese head, and I possess representative types of the white race, and Japanese masks. One may observe heads with retreating foreheads like the profiles of Palenque, and others with the straight brow of a Grecian profile. They are orthognathous or prognathous, the faces are smooth or bearded; it is an extraordinary mixture that proves how many races must have mingled or succeeded each other on this old continent." (DÉSIRÉ CHARNAY, *Les anciennes villes du Nouveau Monde*. Paris, 1884, p. 118).

⁵ "With a little reflection, it becomes evident that the forms examined belong to known types, whereas others are totally foreign and depart entirely from those recorded in historical times. It matters little, as we have said, that they should resemble Jews, Asiatics, or Egyptians; they are not such, in truth, but it remains amply demonstrated that, beyond the period of the chronicles related by hieroglyphic writings, there existed people of unknown attire, races differing from those of modern times, and civilizations revealed to us by works that are not like those of the Toltecs, Acolhuas, or Aztecs." (OROZCO Y BERRA, *Historia Antigua de Mexico*. Mexico, vol. II. p. 360).—Sr. Alfredo Chavero, the prominent Mexican writer, on page 242 of the magnificently illustrated work in course of publication in the city of Mexico, *Mexico à travers de los Siglos*, after attributing the construction of the pyramids in the Valley of Mexico to the "Vixtoti," a southern civilization, proceeds: "Now we can explain to ourselves the types and head-dresses of the heads from Teotihuacan that surprised Orozco y Berra so much, those faces that were thought to be of negroes, those turbans similar to those of Copán, and the head-dress with bands like those of Nachán."—Mr. Bancroft's comment (*Native Races*, vol. I. p. 541) will be found to differ from the testimony of other writers: "Many of these heads have been brought away and sketched, and they are very similar one to another."

I have been informed that similar heads are found in other localities, but have, as yet, had no opportunity of obtaining reliable specimens of these for study and comparison. It may not be out of place here to state that I have been unable to detect, in the many heads examined, any type but an Indian one; indeed, some of them bear a striking resemblance to individuals of the Aztec race who, for several months last winter, acted for us as domestic servants or guides.

⁶ "One's attention is drawn to the fact that in the cinerary urns only the skull appears; it is accompanied by precious objects to show that it was that of a prominent person. This fact might explain the reason why in those ruins (of Teotihuacan) are found in profusion certain little clay heads, terminating in an appendage, and intended to be inserted into some object; perhaps the body of the dead was consigned to the flames, whilst the head alone, being the principal part of man, was preserved, and the little heads were placed in the grave to commemorate the race of each individual." (OROZCO Y BERRA, vol. II. p. 359).—"I have seen a suggestion somewhere, that, when a man was buried, each surviving member of his family put one of

It cannot be said, however, that any of the above theories were proved or even strongly advocated; the small clay heads, after a few remarks, were generally dismissed in favor of greater subjects, Orozco y Berra being the only author to treat of them at length. When, therefore, the present writer adopted the course of comparative research, deeming it the sole one that might yield definite results, it led to a field unoccupied by other workers.⁷

The clay heads are still found in countless numbers at Teotihuacan, and each year a rich harvest of them is reaped by those who search the freshly ploughed stretches of level land that lie across the broad straight *Micoatl*, or Path of the Dead, and about the bases of the Pyramids. Varying in length of face from one to two inches, with exceptional specimens under and above this average, they have invariably been found with only a neck or appendage attached to them, and may be readily distinguished, by this one noteworthy peculiarity, from those that were applied as ornaments⁸ on terracotta vessels, and from fragments of "idols," etc. Sometimes, this neck is formed of the same mass of clay from which the head was moulded, and is short, round, and smoothly finished at the end: but, in the majority of specimens, a close examination shows that the faces were made,

these heads into his grave. This sounds plausible enough, especially as both male and female heads are found." (E. B. TYLOR, p. 229).—"Don Lucas Alaman believed that the numerous terracotta heads were relics distributed by the priests to the crowds of pilgrims that assembled at the shrines." (H. H. BANCROFT, *ibid.*).

⁷The writer begs to acknowledge the courtesy of Sr. Don Jesus Sanchez, the Director of the *Museo Nacional*, through whom every facility for examining and sketching the fine collection contained there was afforded, and that of Dr. Chas. Rau, the curator of the Smithsonian Museum, and of Dr. Ruschenberger, of the Academy of Natural Sciences of Philadelphia, where the Poinsett collection is deposited. The specimens at the Peabody Museum, Cambridge, and those at New Haven were only hastily inspected on account of pressure of time. Besides the many specimens thus compared, the writer possesses a fair collection, made in person, which has furnished many of the illustrations.

⁸In the collections examined, such fragmentary heads are often placed with those that form the subject of this paper. The characteristic finish of the back and neck of these shows that they belong to a separate class. Among the "fragmentary heads" are those broken off the flat "idols" of well-known shape: the flat, occasionally grotesque, masks (parts of figures also) that are found applied in bas-relief to ancient vases, a few of which exist in the *Museo Nacional*, forming a striking contrast to the gross imitations close by, laden with meaningless decoration. These complete figures, or parts of them, as well as the numerous heads of tigers, eagles, owls, lizards, etc. (evidently ornamental appendages to clay vessels) seem, in many cases, to have been pressed by moulds, of which a few genuine specimens exist in various collections.

like the Aztec stone-masks, with a flat back, and then baked. Subsequently, the neck, about an inch long, was roughly pressed to the smooth back, at an angle from the face, leaving the chin free. A second more or less thorough baking then took place, and the fact that the fresh clay failed to adhere firmly or to acquire the hardness of the masks themselves, explains why, in so many cases, the necks are brittle and have become readily detached and broken (PL. III, 1-4). The unfinished, carelessly-pressed necks and backs of these masks,—offering a striking contrast to the usually delicate and artistic finish of the faces,—lead one to infer that the backs and necks were meant to be concealed, and that the latter were intended to serve solely for attachment or insertion.⁹

At the first glance, the multitude and variety of these heads are confusing; but after prolonged observation they seem to naturally distribute themselves into three large and well-defined Classes, specimens of each of which exist in nearly every collection. It would appear that each Class represents a period in the history of their manufacture, a stage in their evolution.

CLASS I.

In the first Class (PL. III) we find the primary and crude attempts at the representation of a human face, shaped like a mask attached to a short neck or stump.¹⁰ Some of these have markedly projecting mouths and chins, and the neck is placed at an almost acute angle with the line of the face. In others of the same shape, the features are better rendered, and, in the finest specimens of this first Class, we sometimes find faces, with vestiges of a dull-red paint upon them, which are so characteristic that it would seem as though a not unsuccessful attempt at portraiture had been made, though all are of the same conventionalized shape, size and type. All are earless, have high square foreheads, prominent and well-shaped noses, open nostrils, large mouths, and eyes that either seem half-closed, or are, in a smaller number of cases, entirely so. The features are invariably

⁹ In the *Museo Nacional* there are three unique specimens in which the long neck spreads into the roughly and badly shaped semblance of shoulders. One cannot fail to perceive, however, that in these cases the enlargement of the appendage was merely to facilitate attachment. The angle at which the face is placed, the great length of the neck, and the total absence of finish exclude the possibility of inferring an attempt at the representation of shoulders.

¹⁰ In the *Museo Nacional* there are not less than 61 specimens of this Class.

represented in repose,¹¹ a characteristic that extends to the following Classes as well.

CLASS II.

The second Class (PL. III), although the least numerous of the three, is one of great interest. In it are found the first departures from the conventional form above mentioned, and also attempts at the modelling of clay ornaments for the head are visible in the circular earrings (some with beaded edges) that stand out on either side of the face. Unmistakeable traces of impressions made upon the clay while still in its plastic condition, remain to prove that these new forms were made in order to adapt the little heads to the shapes of head-dresses and ornaments that, for some reason, were to be affixed to them. These clay heads seem, in fact, to have served somewhat the purpose of a hairdresser's poll. In some of them, holes, notches and lines were made, which could serve for the attachment or insertion of decorations. Traces of paint, brown, red and white, are noticeable in many, becoming peculiarly vivid when a specimen is immersed in water. This immersion also reveals very great differences in the color and quality of the clay. From this fact, one must infer, either that all the heads were not made in the same locality, or that the clay itself was brought from several sources. The new forms are five in number (categories A, B, C, D, E), and a representative specimen of each is given in plate III.

II. A.—These heads are exceptional in being round and well-proportioned, with necks formed from the same mass of clay. The first discovery of traces of the previous existence of decorations of a perishable nature was made by the writer whilst examining a tiny head, belonging to this category, picked up at Teotihuacan. It is smaller and of a finer clay and workmanship than any specimen met with before or since. A representation of it is given (II-A-1), but it scarcely conveys an adequate impression of the original. The head is round and disproportionately high, in order to serve as a foundation for the close-fitting cap or head-dress that was pressed on it so tightly that

¹¹ In this respect a striking contrast is offered by the animated, mirthful expressions of the terracotta figurines found in the State of Vera-Cruz and admirably represented in Hermann Strebel's recent work: *Alt-Mexiko*, Hamburg, 1885. His specimens, in some respects not as elaborate in detail as the heads from Teotihuacan, show, however, a certain degree of care taken to represent open eyes. The eyeball is formed, and the iris is indicated by a circular depression.

some of the clay, yet soft, was forced down in the attempt, and remains as a thick line at the nape of the neck, below the once-existing edge. An examination under a strong magnifying glass proves that this cap was not of a textile fabric, impressions of which would be easily recognized, but of a perfectly smooth and yet yielding substance that left impressions on certain parts.¹² High on the forehead are two small, irregular, circular hollows, symmetrically placed on either side. On the top of the head, extending backwards and diverging, are several regular rows of impressions of the size of a pin-head. A straight line on the lower forehead, formed by the cessation of the burnished finish of the face, and a slight roughness show the position held by the cap. The magnifying glass also reveals the fact that the features of this specimen had undoubtedly been cut with some sharply-pointed instrument.



FIG 18.—Terracotta head from Mexico à travers de los Siglos, p. 243.

II. B.—The workmanship of heads of this type is generally fine and delicate. The impressions left are usually observable about the forehead and chin. Circular ear-ornaments are represented upon them, and it would seem as though all of them represented women.

II. C.—“There comes next in order a type distinguishable by two protuberances of the forehead and the absence of hair, as though the individuals were in

¹²In connection with this specimen the following passages are suggestive: Fray Toribio de Motolinia (*Coleccion de documentos para la historia de Mexico*, publicada por Joaquin Garcia Icazbalceta. Tomo 1, Mexico, 1858) tratado 1, chap. v, p. 33; “They (the Mexicans) had idols [to the Spanish new-comers every image seemed ‘an idol’] of stone, of wood and of baked clay . . . great, middle-sized, small and tiny ones. Some had the semblance of bishops, with their mitres and croziers, of which some were gilt and others decorated with turquoises in many ways.” The same writer (tratado II, chap. IX, p. 137) describes the method used by the Indians of his day, in making precious inlaid crucifixes for the altars. A cross was shaped in wood and covered with a thick pitch or glue. With great care and nicety this was heated, and turquoises and stones of various colours set into the softened surface until this was completely covered with them.—Fr. Bernardino de Sahagun (*Historia general de las cosas de Nueva España*. Mexico, 1829, vol. II, chap. IV, p. 353) speaks of “thin and flexible plates of gold that were bound to the forehead” and worn by the lords.—In Lord Kingsborough’s work the text of the Codex Mendoza describes the representations on plate XLI as “10 plates of gold, four fingers in width, of the thickness of parchment.”

the habit of shaving." (Orozco y Berra, vol. II, p. 359). This category is very numerous, and exhibits distinctly feminine features as well as more frequent traces of artificial attachments. Often a sunken line extends across the brow, as in II-C-1, and a deep, transverse notch is observable in the depression of the middle of the head. In some specimens a cavity, exhibiting the contour of a small obsidian flake, was made at the back of the mask, under the transverse notch.

II. D.—A protuberance above the eyes is the distinctive feature of this category. The specimen illustrated, a back view of which is given (PL. III), bears traces of having been painted with light-brown color. It exhibits also a unique feature: the little neck, shaped like a flattened pipe-stem, was evidently baked and hardened before it was forced into the soft clay at the back of the mask, and no care was taken to smooth the displaced mass of clay.

II. E.—These heads are conical, and all bear evidence that they once had an attached ornamentation on one side of the head. The smaller head (II-E-1) is remarkable for the band of red paint (evidently applied under the glaze) that divides the elongated forehead into two equal parts: it will be the subject of comment further on.

CLASS III.

We now come to the last and most important Class, the one that has excited the most interest, remark, and theorizing, and which in many instances exhibits a quality of workmanship surprising by its excellence, and a confusing variety of peculiar and not ungraceful head-dresses. Under seemingly endless differences of detail, the five fundamental forms of the second Class remain unchanged. A skill in modelling had been attained which made it possible and preferable to represent, in clay, parts and sometimes the whole of the elaborate head-gears formed of different substances, that had been previously affixed to the small clay heads. The transition was a gradual one. Some specimens (III-I-1; III-J-1) with imitation of fringed hair in clay have, also, either small holes, into which probably feathers were stuck, or bare places left for supplementary decoration. It is fortunate for the investigator that finally even feathers were imitated in clay, for it is with the complete representations of Class III in hand, that one can mentally reconstruct the vanished finery of the identical shapes of Class II. The various impressions existing in the latter correspond exactly in location with the solid clay imitations

of feathers, tufts, locks of hair, etc., of the more skilful artistic productions.

It is not difficult to classify this large group according to the modified reproductions of the essentially identical head-dresses that many specimens have in common. Placing some of these, which seemed from a superficial glance to be alike, side by side and comparing them carefully, they have been found by the writer to invariably present differences either in size, quality of clay, or execution. Moreover, each one invariably exhibits modifications of feature sufficient to give every specimen an individuality of its own. It seems reasonable therefore to suppose that these clay heads are portraits of persons. The faces are invariably in repose, in some the eyes are closed: in the picture-writings, closed eyes invariably convey the idea of death. We find, with identical head-dresses, faces young and smooth, others very elongated, some with sunken cheeks, others with wrinkles: were a deity represented, this variety would scarcely occur, but a conventional semblance would have been adopted and maintained without change.

Extending, now, the comparative study of the heads to the head-dresses¹³,—making use, for comparison, of Fray Bernardino de Sahagun's numerous and detailed descriptions of those worn by the Aztec women, warriors, nobles, and living images of the divinities, and of the delineations of such in the codexes reproduced in Lord Kingsborough's great work,—it will be found that the principal types of the clay head-gears (including those mentioned by Orozco y Berra¹⁴ as quite strange and unknown) agree, in many cases, even to the smallest details, with those described and depicted in the above authentic sources. A single instance of such complete similarity might, of course, be attributable to coincidence: a series of instances, however, arrest and claim attention.

Before examining the literally and most carefully translated passages from Sahagun's invaluable work, in connection with the terracotta types from Teotihuacan, to which are added corresponding

¹³This is in accordance with the writer's premise: that, unless the contrary be proved, the explanations of relics of ancient pottery found on or near the surface of the soil in the Valley of Mexico should be sought for, at first, in the records of the last civilization known to have existed there and to have practised the art of moulding in clay.

¹⁴His descriptions of each type will be appended to the writer's: they will prove that identical groups are under consideration.

delineations from the picture-writings, it will be well for those unacquainted with the strange religious observances of the Ancient Mexicans, to understand what is meant by the above-mentioned "living images of the gods,"¹⁶ and for others to have their attention drawn to the fact (which will be treated at length in Part II of this paper) that the symbolic head-dress and distinctive garb of a deity were worn, not only by the victims sacrificed in its honor, but by priests in certain ceremonies, by children consecrated to a deity, by "noblemen;" and also formed an important feature in the funeral rites.

III. A.¹⁶—"The slave destined to die on the feast of the god Tezcatlipoca . . . they cut his hair in the fashion used by the captains, tying it in a tuft on the crown of his head, with a curious fringe; they fastened to this two tassels with their rings (or circles)¹⁷ very curiously made of feathers, gold, and rabbit's hair. These they called *atzaxelli*."¹⁸ (Sahagun, book II, chap. XXIV).¹⁹ By adopting, as the meaning of the word *boton* in this particular case, that of "a design in the shape of a ring or screw used for ornamentation in balustrades, keys and other articles of iron, tin or other materials," we have, in the head-dress he describes as worn by Tezcatlipoca's living representative, the one permanent and unmistakable feature of the god's head-gear, the hollow circle, from the centre of which issues a shape which, though it varies in each representation, yet conveys the same symbolic meaning. It is fortunate to be able to

¹⁶ "They appointed any slave to be the representation of the idoll, saying it was his picture. They, every yeare, gave one slave to the Priests that they might never want the lively image of their idoll. At his first entry into the office, after he had been well washed, they attyred him with all the ornaments of the idoll giving him the same name." At the feast of the god he was sacrificed in its honor. *The Naturall and Morall Historie of the East and West Indies by Acosta, translated by E. G. London, 1604, lib. v.*

¹⁷ Of this type there are two specimens in the *Museo Nacional* and three in the writer's collection.

¹⁸ As the Spanish word *boton* has several and diverse meanings (see *Diccionario de la Academia Española*, 1865) the writer, before translating it as *ring*, or *circle*, resorted to the picture-writings and compared Sahagun's description with the symbolic head-ornament that recurs, with but slight modification, in all representations of the god Tezcatlipoca.

¹⁹ From *atzatl*=heron-crest and *xelli*=divided, from the verb *xeliui*=to divide (Rémi Siméon).

²⁰ The writer has translated from the text of Sahagun's *Historia General* in the seventh volume of Lord Kingsborough's *Antiquities of Mexico*, in preference to that published by Carlos Maria de Bustamante, Mexico, 1829.

determine what this was by referring to Duran and to the illustrations of his Atlas²⁰ (*fig. 19, a*): "The idol of the god Tezcatlipoca, as adored in the city of Mexico (that of Cholula was differently apparelled) wore . . . about its head a circlet of burnished gold finished with an ear of gold with smokes painted in it that signify the hearing of the supplications and prayers of afflicted sinners. From between this ear and the circlet issued a large bunch of the crests and feathers of the white heron."²¹ The signification of the smokes, as given above, is quite erroneous: in the first case, according to an invariable and well-known rule in the picture-writings, they are represented in Duran's illustration as issuing *from* the disk attached to the circlet. Nor can the disk be "an ear," for this is quite distinctly represented, in

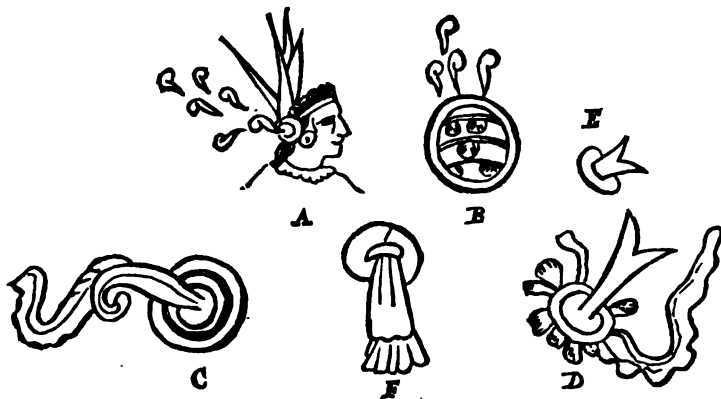


FIG. 19.—A and F, from *Atlas Duran*; B, from *Mapa de Tepechpan*; C, from bas-relief of "Sacrificial stone"; D, from *Vatican Codex*; E, from *Borgian Codex*.

its natural position, by the conventional circular ear-ornament. Unquestionably, the circle with smokes issuing from it forms the "rebus" of the god's name composed of *tezcatl* = mirror, and *poca* = to smoke. In support of this assertion the writer refers to the hieroglyph of the name of Chimalpopoca, "emperor" of Mexico, as represented in the *mapa de Tepechpan* and reproduced in Orozco y Berra's atlas. The puffs of smoke issuing from the shield = *chimalli* are drawn in an identical manner (*fig. 19, b*). After glancing at the

²⁰ Fray Diego Duran, *Historia de las Indias de Nueva España*. Mexico 1867-80, vol. II, p. 98.

²¹ Here we see that the feathers worn by the living representative of Tezcatlipoca were probably heron's feathers; at all events the name indicates this (see note 18).

various forms²² given to the "smoke" in the several codexes (*fig. 19, d, e,*), it is not difficult to see how, in the case of such a form of head-dress being worn by a living, moving being, this smoke would assume the form of a pendent tassel, as in *fig. 19, f.* We find figured in some of the clay heads from Teotihuacan a faithful and natural representation of such insignia as were actually worn.

III. B.²³—In the feast of the eleventh month, Ochpaniztli,²⁴ "the image of Centeotl was a youth who wore as a mask the skin flayed from the thigh of the woman who had been sacrificed. . . His garb was . . . the mask of skin over the head, and a hood of featherwork fastened to a feather garment with sleeves and body. The point of the long hood was twisted back, and on it was a crest like a cock's comb." Further on, in the same chapter, the skin is spoken of "that was worn on the head and over the face like a mask." (*Sahagun, book II, chap. xxx.*) The above description of hood and garment is applicable to a figure, drawn in Duran's Atlas, relating to the feast Tlacaxipehualixtli, on which occasion several human beings were sacrificed and their skins worn. In Duran's text (vol. II, p. 148) the hood is described as being "scarlet and encircled with a scarlet ribbon that, tied above the forehead, formed a gallant bow." Its serrated ends, as shown in the drawing, and its color, probably suggested Sahagun's comparison to a "crest like a cock's comb." From the accord of Sahagun's description with Duran's text and illustrations (*fig. 20*), we may infer that an identical costume was worn on both religious festivals. In examining the terracotta specimens of this group, one observes that the face is represented as covered by a smooth mask with apertures for the eyes and mouth only.²⁵ It is the only terracotta type that has a



FIG. 20.—From *Atlas Duran.*

²² The writer observes that the "emperor Tizoc and warriors" sculptured in bas-relief around the so-called "sacrificial-stone" wear this symbolic form of head-dress (see *fig. 19, c.*).

²³ Of this type there are three in the *Museo Nacional*, two in the writer's, and three in the Poinsett collection.

²⁴ After the female victim called Toçi had been killed in honor of the goddess of the same name (= Centeotl), her body was flayed, and a priest, assuming her appellation, clothed himself in her skin, entire, excepting the piece mentioned above which was brought to the youth Centeotl who, during the festivity, was called "the son of Toçi."

²⁵ "Not a few are distinguishable by a species of turban that encircles the head

roll or band of any description encircling the face. It would seem as though this and the deep sunken lines in the turban (corresponding in position to that of "the ribbon that encircled the hood," etc.) were made in order to afford facilities for the adjustment of a small hood corresponding in material, and possibly in shape, to that mentioned above.²⁶

III. c.—The god of rain, Tlaloc, and the lesser divinities of the same name are invariably represented in Aztec art with circles about their eyes and a curved band above the mouth, and in the picture-writings these emblems are painted light-blue (*fig. 21, b, c*).

These circles and bands are evident in *fig. 21, a*, made from a drawing, by the writer, of one of three similar terracotta specimens in the *Museo Nacional*. These emblematic signs are in relief, and probably were originally painted blue.²⁷ At the feast Etzal-

with bands that come over the cheeks close under the chin, reminding one of the head-dress of the Jews at a certain period, or that of some Asiatic tribe." (OROZCO Y BERRA, vol. II, p. 359). It will be seen that Orozco y Berra, in this description, overlooks the mask. In Nebel's *Viaje* an illustration of a similar head is given in which, however, this noteworthy peculiarity is well defined by the artist. The writer is not aware that it has been noticed before.

²⁶This inference will not seem strange to any one who has lived in Mexico, and knows to what an extent the manufacture of small dressed wax and clay figures is carried by the Indians. The figurines of Puebla, made of wax covered with cotton cloth, are justly celebrated, and are perfect miniature representations, full of life and movement, of the native vendors in their respective costumes, which vary according to their avocation. These little figures (the faces of which are usually about the size of the clay heads that form the subject of the present paper) are carefully and dexterously dressed with garments and ornaments made of the identical materials worn by the people themselves. At Puebla also are made, by Indians of the Aztec race, tiny and truly wonderful groups of fine clay figures, not half an inch in height. There is not a Mexican household that does not possess a collection of small images, more or less well made, and these may be seen to full advantage at Christmas-tide, when, passing through even the poorest quarters of a town, one perceives through open doors, and is often politely invited in to inspect, the *nacimiento*, or birth of Christ, represented in miniature. The skill of the Indian potters of Guadalajara is lauded throughout Mexico, and the writer has often been told of certain individuals there, who, after a few moments' observation only, can reproduce in clay, with extraordinary fidelity, not only the features of a stranger, but the whole figure with the details of the sometimes complex modern costume. These individuals claim, it appears, that their forefathers were all potters. Evidences that clay portraits were made by the ancient Mexicans, also, will be given in the second part of this paper.

²⁷"At times one observes the hair arranged as a shingled roof, with an ornament encircling the top; the decoration about the eyes is most singular and would be compared in modern times to large spectacles: it can be nothing else but a distinctive mark of rank or race" (OROZCO Y BERRA, vol. II, p. 359).

qualiztli, in the sixth month, "many prisoners and slaves adorned with the ornaments of the gods 'Tlaloques' were killed in their honor." (Sahagun, book I, chap. VI; and book II, chap. XXV). A curious travesty was carried out on the same feast by the common people, who "took the cat's-tails or reeds with which the temple was decorated, and made from their leaves circles like rings or the frames of spectacles, and put these over their eyes, tying them behind with cords . . . with these over their eyes and a staff in their hand," etc. (Duran, vol. II, p. 283). These rings undoubtedly had some affinity or connection with the emblems of Tlaloc, and were worn in allusion to them. In the Vienna Codex (*fig. 21, b*) a woman, seated, is delineated with these unmistakably tied on.

III. D.—Although the head-gear in each of these specimens is dif-



FIG. 21.—A, head in Museo Nacional; B, from Vienna Codex; C, from Bodleian MS.

ferent, they have in common the peculiarity of the two circles on the forehead. The six priests chosen to sacrifice victims "wore their hair much adorned and twisted, with strips of leather encircling the head."²⁸ On their foreheads they wore tiny targets (or shields) of paper painted of various colours." (Duran, vol. II, p. 95).²⁹ In the old English translation of Acosta (vol. II, p. 348) the following parallel passage occurs: "The other five had their hair much curled

²⁸ Examine closely III-D-1, on PL. III, where knotted bands are represented above the hollow circles on the forehead. This head also bears distinct traces of black paint. It is a well-known fact that the priests of certain grades besmeared themselves with black.

²⁹ Duran (vol. I, p. 388-390) mentions that the priests and the children destined to be sacrificed wear "large stars on their foreheads fastening their paper wreaths." See, also, Sahagun, book II, chap. XXIV, "the priests wore (at the feast Toxcatl) on their foreheads circular ornaments of paper plaited like the petals of roses."

and tied up with laces of leather bound about the midst of the head; upon their foreheads they carried small roundlets of paper painted with diverse colours." Attention is here drawn to the fact that the heart of the victim thus sacrificed was offered to the Sun, and that, on the brow of the Sun of the Stone Calendar, besides a central sign, two circles are sculptured in relief that will be found, upon comparison, to resemble those on clay head III-D-3. A peculiar arrangement of the hair is exhibited in III-D-2. The quality of the clay of which heads III-D-1 and 2 are made is coarse and unsifted, and they have the appearance of great age.³⁰

III. E.³¹—The dress and ornaments of the living image of the goddess Centeotl (Toçi) were these: "She had her mouth and chin, to the neck, dyed with *ulli*, a black gum; on her face she had what was like a round patch of the same. On her head she had a cap



FIG. 22.—From the *Codice Ramirez*.

made of cloth, twisted and tied; the ends of the knot fell over the shoulders, and tufts of feathers that were like flames were inserted in it. These fell towards the back of the head." (Sahagun, VIII, 7). The image of the goddess from the *Codice Ramirez* is shown in the illustration (fig. 22). The treatment of the turban-like "cap" in the drawing and in the clay heads is the same, and the analogy they bear in common to the description in the text will be manifest on a careful examination. Many

specimens exist with turbans or caps alone; it seems not unlikely that real feather decorations were fastened to these.

III. F.³²—"The priests . . . tied to the back of their heads flowers

³⁰ In connection with these unusual specimens, the following extract from Duran (vol. II, p. 275) is interesting: "These diviners" also deceived and persuaded parents into having faith and hope in the efficacy of the shaving of their children's hair by "saying that it was in this or that fashion that the ancient priests shaved themselves, thus they shaved the children's hair in the form of a crown, a circle or crosses—on some they left pellets (Spanish: *pegujones*) of hair at the back of the head, or in front, or at both sides." For further information proving the variety of manners in which the priests, according to their grade in the hierarchy, wore their hair, see ACOSTA, *Naturall and Morall Historie*, lib. 5; and DURAN, vol. II, pp. 91, 124.

³¹ Of this type there is one specimen in the *Museo Nacional* and three in the writer's collection.

³² It would seem as though this type had not come under Orozco y Berra's notice,

of plaited paper. These projected from each side of the head like semi-circles, as though they were ears of paper." (Sahagun, book II, chap. XXV). Attention is drawn to the series of lines visible in the semi-circular projections of III-F-4 and 5, that might be taken for an attempt at the representation of a plaited surface. Owing to the thinness of these projections, comparatively few complete specimens exist, but vestiges of their previous existence remain to show that they invariably accompanied the peculiar central prominence that characterizes this type.³³ The feast on which were worn the above symbolic ornaments (similar to those depicted on representations of Tlaloc and Chalchiuhtlycuc) was that of Etzalqualiztli ("in honor of the gods of water, the Tlalocs"), and in the course of his description of the ceremonial usages of this same feast Sahagun speaks of the old priests called *quaquacuilitin*, who "were completely shaven with the exception of the crown of the head, where the hair was left long, in reverse of the clerical tonsure." There is no clue as to whether this patch of long hair fell behind, or was tied and brought forward, a fashion that the clay heads seem to display.³⁴ It will be noticed that this central relief is not treated in the same manner in all the specimens: in some it reaches farther over the face, is larger or smoother than others. In one of the nine specimens at the *Museo Nacional* and in III-F-4 a deep line extends along its centre, and the sides are roughly cut: some specimens show a series of scratched lines or depressions faintly marked. The row of heads of this group (PL. IV) will illustrate their great individual difference, and show that they do not represent a personified deity, but are probably portraits of individuals wearing a distinctive head-gear.

III. G.—This fine female head (*fig. 23, a*), found by M. Désiré Charnay at Teotihuacan,³⁵ and reproduced in his *Les anciennes villes*

unless he has them in view when he says, rather enigmatically (II, 360), "Another type shows the hair cut, between the temples, in a fashion well known in historical times, and in use at the present day by some races."

³³ Compare this with the somewhat similar central elevation of the feminine head dress in *fig. 18*.

³⁴ Sahagun (book IX, ch. XVII) describes a somewhat analogous mode: "the third slave . . . was arrayed as a man, with hair cut in the centre of the head like an elevation, called *quachichiquille* (feather-crest), and this elevation was not of hair, but of rich feathers."

³⁵ The writer has not seen this specimen, and only assumes that it has the characteristic finish of the back of the head and neck. The point upon which the stress

du *Nouveau Monde*, and in *Mexico à través de los Siglos*, displays two conventionalized forms of adornment: above is a row of four-petaled flowers of the same design as some sculptured in bas-relief on a fragment of stone also found at Teotihuacan, and those scattered over the upper garment, (*huipilli*) of the goddess Xochiquetzal as depicted in Duran's Atlas (*fig. 23, b*). Closer to the head is a line of finely executed wave pattern.³⁶

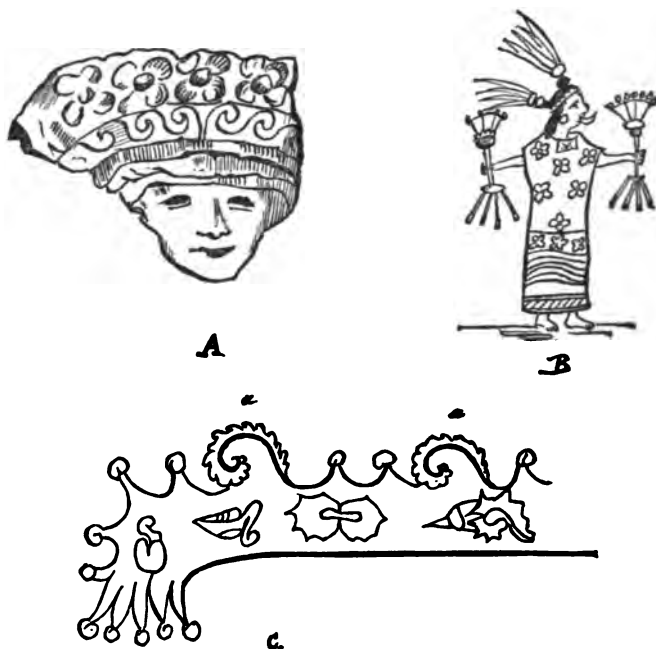


FIG. 23.—A, from *Mexico à través de los Siglos*, p. 243; B, from *Atlas Duran*; C, from *Vienna Codex*, p. 47.

III. H.—Leaving the head-dresses that seem connected with religious ideas or ceremonies, we come to the military insignia more

is laid in this case is, that the conventional designs represented in the head-dress were in use by the Aztecs.

³⁶ "The 'goddess of salt' had waves of water embroidered on her *huipilli*" (Sahagun, book II, ch. XXVI). By referring to (*fig. 23, c*) representations of waves in the Vienna Codex (Kingsborough, vol. II) we recognize in the curved outline of a portion of the water marked *a* the conventional pattern found on so many relics of aboriginal art. It is interesting to find this suggestion of its derivation, and, at all events, the explanation of what pattern was meant in the above passage.

seldom found on the terracotta heads. "They placed their heads in that of a tiger or serpent made of wood, with open jaws showing the fangs, so as to inspire the adversary with fear. All the noblemen and officers adorned their heads with beautiful plumes, adding, by this means, great height to their stature."³⁷ "To protect their heads, some wear what are like heads of serpents, tigers, lions and wolves with their fangs: the head of the man remains in the mouth of the animal as though it were devouring him: they are of wood, covered on top with feathers and ornaments of gold, precious stones, and are wonderful to behold."³⁸

The first specimen of the illustration (PL. IV. H) is, beyond question, the representation of a face in the jaws of a serpent. In the *Museo Nacional* are two with faces in the jaws of a lion. It would be difficult to assert anything so positive about the other (PL. IV. H²). It would seem, however, as if the helmet-shaped head-gear would have answered the purpose of "protecting the head," and might have been made of wood, ornamented with tufts of feathers.³⁹

III. I.—The knights of the sun "were called *quachic*, which means 'shaven men' . . . and this was because to receive this grade of chivalry they shaved the entire head with a blade,⁴⁰ leaving over the right ear only a lock of hair as thick as a thumb—this lock was braided with red ribbon, and half the head was painted blue and the other half red or yellow." (Duran, vol. II, p. 163). It will be remembered that in Class II particular attention was drawn to a small, fine, conical-shaped head, that bears unusually well-preserved traces of red paint covering half the head only, and also marks above the place for the right ear, which was left with a smooth finish. PL. III. 2, from the Smithsonian collection, has a partly broken appendage of clay above the right ear. To the writer it seems probable that these heads are portraits of "*quachic*." The fact that the small

³⁷ Francisco J. Clavijero, *Historia Antigua de Mexico*, traducida por J. J. de Mora, Mexico, 1844, p. 215.

³⁸ Conquistador anonimo, ch. IV. *Coleccion de Documentos para la Historia de Mexico*, ed. Icazbalceta, Mexico, 1858.

³⁹ For numerous representations of military head-gear, see the *Codex Mendoza*, parts I and II (Lord Kingsborough's *Mexican Antiquities*, vol. I), whence fig. 25, g, is taken.

⁴⁰ There were barbers who cut hair and shaved heads . . . using, instead of steel blades, keen-edged obsidian flakes." (CARLOS MARIA DE BUSTAMANTE, *Texcoco en los ultimos tiempos de sus antiguos reyes*. Mexico, 1826, p. 236).

painted head was conically shaped, has suggested that it was thus intentionally formed, in a conventional manner, so as to convey the fact (important as showing military advancement) that the whole head was shaven, and that the lock, worn at the nape of the neck before the attainment of this higher grade, had been removed. Before applying this explanation to another singular and numerous group of heads of pyramidal form, a few interesting facts will be given, to show the importance attached to locks of hair worn on certain parts of the head.

The grades by which (military) dignities were reached were as



FIG. 24.—A, from *Mendoza Codex*, 86; B, from *Duran (Atlas, tr. 1, lam. 23)*; C, from *Vatican Codex*, 182; D, from *Mexico à travers de los Siglos*, p. 648.

follows: when a boy was small his head was cropped; at the age of ten a lock of hair⁴¹ was allowed to grow at the nape of the neck; at fifteen this was long, and the youth was called *cuexpatchicuepul*, because he had not yet distinguished himself in war; when he, alone or with others, took an enemy prisoner this lock was cut off, and this was a sign of honor.⁴² If the terracotta head III-I-2 be examined, it will be seen that cropped or clipped hair (as further on in

⁴¹ "This lock had no less than three names: *piochili*, *quatzrunli*, *cuexpalli*" (MOLINA, *Vocabulario de la Lengua Mexicana*. Mexico, 1571).

⁴² Sahagun, book VIII, ch. XXXVIII. See the whole of this passage.

female heads) is represented in a conventional way. From the apex there hangs, invariably, an appendage down the left side.⁴³ In one of the specimens from the Poinsett collection (III-1-4) this has finely-drawn lines on it; in other specimens it is generally smooth.⁴⁴ Figure 24, *b*, shows a striking resemblance to this head-dress, and in *fig.* 24, *c*, the head placed on the conventional representation of a mountain has the horizontal bands colored as hair, in the original drawing.⁴⁵ The writer suggests that these illustrations (*figs.* 24 and 25),⁴⁶ and the fact, mentioned by several authors, that "some warriors did not comb their hair but wore it matted and erect on their heads (see also *fig.* 25, *e, f*) so as to look terrible," probably explains the heads found by M. Charnay at Teotihuacan, and called by him "heads of negroes with woolly heads." The hair worn thus, standing erect from the forehead, may also account for the heads of Class II. D.

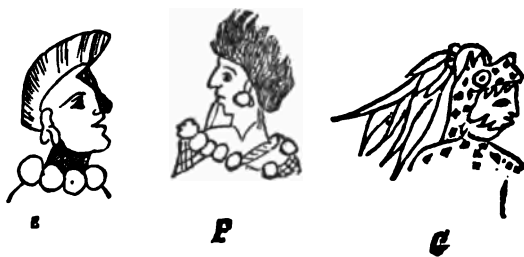


FIG. 25.—E, from *Mendoza Codex*, pt. II; F, from *Atlas Duran*;
G, from *Mendoza Codex*.

⁴³ "Some wear their hair in a species of bands of pyramidal form, fastened up by a ribbon that hangs to the left. Those in which the fashion is more exaggerated come under the same category" (OROZCO Y BERRA, vol. II, p. 359).

⁴⁴ The writer imagines that, as the front only of the clay head was intended to be seen, the devise of elongating the head was resorted to when it was necessary, for an important reason, to represent the back of the head with or without a distinctive badge. This supposition may be erroneous, however, and the reader may prefer to consider this type as having analogy to figures of captains. See SAHAGUN, book II, ch. XXVII; book VIII, ch. XXXVII; and DURAN, vol. II, p. 163. See also *fig.* 34, *Mappe Tlotzin II*: J. M. AUBIN, *Mémoires sur la Peinture didactique*. Imprimerie Nationale, Paris, 1885, p. 68.

⁴⁵ Of this type there are 9 specimens in the *Museo Nacional*.

⁴⁶ Notice a deep hole at the top of the head dress of PL. IV: III-1-1: it was made while the clay was moist, for, at the back, there is a visible displacement of material. In this specimen there is no sign of the usual clay appendage having been broken off, as in others. The inference is that, in this case, the ornament was supplementary and fastened in the cavity.

III. J.—“The noblewomen used to wear their hair hanging to the waist, or to the shoulders only. Others wore it long over the temples and ears only,⁴⁷ whilst the rest of the head was clipped (or cut in an irregular manner; see *tresquilado*, Spanish dictionaries). Others entwined their hair with black cotton-thread, and wore these twists about the head, forming two little horns above the forehead. “Others have longer hair and cut its ends equally, as an embellishment, so that, when it is twisted and tied up, it looked as though it were all of the same length; and other women have their whole heads shorn or clipped.” (Sahagun, book VIII, ch. XXII).

It will be seen that these various fashions are represented in the terracotta heads. A numerous type is the one where clipped hair is represented, in the conventional manner noticed above, on the top of the head, and two smooth-cornered prominences are left at each side over the temples (PL. IV: III-J-1). These were undoubtedly left



FIG. 26.—D, head in Museo Nacional (case v, No. 4); E, from Vienna Codex.

for the attachment of the locks of hair or ornamental appendages that we find well executed in clay in heads of the same shape,⁴⁸ and also encounter in the picture-writings (figs. 26, d, e; 27, f, g, h). The complete heads of this Class are the ones that have invariably been called by writers on the subject “Egyptian in type.”⁴⁹

⁴⁷ In MOLINA, *Vocabulario de la Lengua Mexicana* (Mexico 1571), we find the words *atzotzocolli* and *ahamoxtili*, translated as “the long lock (of hair) left at the side of a girl’s head when this was shorn.” This proves the long and well established observance of the fashion.

⁴⁸ Some seem also shaved but wear three ornaments, one in the middle and one on each side of the forehead (see fig. 18) (OROZCO Y BERRA, vol. II, p. 359).

⁴⁹ “Some seem of an Egyptian type with a band above the forehead and two lateral wings: in these, round ears are well defined, as is the case in many of these images” . . . Several ornaments recall the Egyptian type so much that it is necessary to bear in mind that they are fragments of idols.” (OROZCO Y BERRA, vol. II, p. 539).

III. K.⁶⁰—There is one more well represented and defined feminine type (PL. IV) that merits attention, for in it are found admirably and artistically finished specimens. Its peculiarities are, a peak represented by sunken or raised lines coming over the forehead; and an erect, fan-shaped ornament of feathers radiating from the back of the head. Hair clipped in a similar shape is observable in III-K-2, which has traces of dull-red paint on the face. III-K-5 is one of the finest specimens that has come under the writer's notice. It is covered with well-preserved vestiges of white paint, and is the only one observed with this peculiarity. Other equally well executed heads are represented on plate IV. In some of these the head-dress is broken and incomplete, but the faces are evidently such admirable



FIG. 27.—F and H, from *Vienna Codex*; G, from *Borgian Codex*.

portraits, that to leave these fragments out of the series would be a real omission.

⁶⁰ The following passages show, not only that the priestesses had their hair cut in a distinctive manner, but that there were differences in this, according to their grade. "As soon as they (the maidens) entered (the temple where they were to serve) their heads were shorn." (FR. GERONIMO DE MENDIETA, *Historia Ecclesiastica Indiana*. Mexico, 1870, p. 106).—" . . . the most aged nuns that were named *quaquacuiltin*, which means 'women who have their hair cut in a certain manner.'" (SAHAGUN, book VI, ch. XXXIX). Compare the way the aged priests, also named *quaquacuiltin*, had their heads shaved (SAHAGUN, book II, ch. XXV). Owing to the above indication given by Sahagun, the writer hesitates in accepting M. Rémi Siméon's rendering of the derivation of the name *quaquacuiltin* (see foot-note, p. 59, Sahagun, *Histoire Générale*, trad. Jourdanet et Siméon).

To sum up, in brief: the writer's conclusions, based upon the foregoing comparative study,⁵¹ are:—

1. That the terracotta heads in question, supplied with accessory decoration, were intended to be and were attached to bodies made of perishable materials, now disappeared. This explanation accounts satisfactorily for their present shape, and vindicates the intelligence of the skilful artists who shaped them. 2. That the heads are made of too many varieties of clay for it to be probable that they were all made in the same locality. 3. That they may be arranged in three large classes: whether belonging to different periods or merely exhibiting a greater or less skill in workmanship, is a point that can be ascertained, if at all, only by carefully conducted excavations at Teotihuacan. 4. That they are portraits of individuals (probably intended to be represented as dead) wearing in common a limited variety of head-gear. 5. That the reasons hitherto adduced by recent writers for assigning the clay heads of Teotihuacan to remote, strange and unknown civilizations cease to be tenable, as it has been shown, on the evidence of reliable writers and of the native pictorial representations, that closely similar or identical head-dresses were worn by the Aztecs at about the period of the Conquest.

ZELIA NUTTALL.

[Conclusion in next number.]

⁵¹ The writer has purposely confined these comparisons to the types noticed by Orozco y Berra and others, or represented, in the collections examined, by a number of specimens. Resemblances of single or even of two similar specimens to some of Sahagun's descriptions, have been omitted. Any information as to the number and kind of types represented in the numerous private collections that must exist, would be of value to the writer, who would thus be assisted in forming a comparative table that might be useful in future research. Readers are referred, for further descriptions of religious head-dresses actually worn, to SAHAGUN, *Historia General*, book I, chs. XI, XIII, XV, XVII, XIX; book II, chs. XXIV, XXXVII; book IX, chs. XV, XVII: DURAN, *Historia de las Indias*, vol. II, pp. 180, 187, 193, and 280. Until these and others have been studied, there will be no necessity to assign, with Orozco y Berra, to prehistoric races such relics as the clay heads in question, an account of their "strange and unknown attire."

NOTE.

AN AMERICAN EXPEDITION TO MAGNA GRECIA.

Since the time of the Assos expedition, the success of which is well known, the Archæological Institute of America has been considering the best field for a continuation of its labors in classic lands. In its *Seventh Annual Report*, just issued, we find the following remarks :

“Two regions, as yet imperfectly explored, seem to be the most attractive, the Cyrenaica and Magna Grecia. . . . The second field, Magna Grecia, is even more attractive, as well as accessible. The great cities of Southern Italy—Tarentum, Capua, Sybaris, Croton, and others—require to be investigated with scientific thoroughness. The chance discoveries in the past, on these sites, of works of great archæological and artistic value, attest the existence of an immense mine of antiquities of the best Greek periods. . . . As a site for research, Tarentum would seem to unite many advantages: the climate is healthy, so that excavations might be carried on during the entire year; the modern city, on the site of the ancient acropolis, would furnish an abundance of workmen; and, finally, desultory excavations have here, more than at any other site, yielded satisfactory results. . . . Excavations undertaken here would in all probability yield a large number of Greek bronzes, terra-cottas, coins, painted vases, and perhaps works of greater size and importance,—a good foundation for a museum.”

This recommendation of the *Report* has been rapidly acted upon. At the annual meeting of the Council, held in Boston on May 8, it was resolved to place Mr. Joseph Thacher Clarke, the leader of the Assos expedition, in charge of the exploration of some site in Magna Grecia, provided the sum of not less than \$2,000, besides what the Institute itself voted, should be at once raised for the purpose. Considering the unique importance of the undertaking, and the credit that it will bring to our country, as well as the works of art that it will add to our Museums, we do not hesitate to make a strong appeal for money contributions, which may be sent to the managing editor of the *JOURNAL* before October 1. If the requisite amount be raised, work will be commenced early in the winter.

A. L. FROTHINGHAM, JR.

CORRESPONDENCE.

EXCAVATIONS AT NAUKRATIS.

[The following interesting letter was written by Mr. Gardner, the explorer of Naukratis, to Dr. Charles Waldstein of Cambridge, Eng., for publication in the JOURNAL.]

NEBIREH (NAUKRATIS), TEL EL BARUD; LOWER EGYPT:
March 4, 1886.

It has been extremely fortunate for me to begin work under so able and experienced an excavator as Mr. Petrie. Though I have been alone, here, after the first month, I feel that any success I may have met with is due to a continuance of his methods; and, though he has with characteristic energy gone off to fresh fields as soon as he could leave Naukratis in other hands, the work here must still be regarded as belonging chiefly to him.

Three temples and a cemetery have occupied most of our attention this year. Two of these temples have been discovered only this season, and it is worth noting that both of them were found by a careful following up of chance indications, and not by independent trial-work. This latter, indeed, but rarely yields good results on such a site as this, where there are no natural features to guide the explorer, but all is a flat and indistinguishable labyrinth of mud-brick walls, covered over with heaps of potsherds of all styles and ages.

If one wishes to excavate a temple at Naukratis, one has to begin by unlearning all one's notions of what a Greek temple ought to be like. It is of no use looking for drums of columns or fragments of entablatures. Such, even in cases where they did exist, have invariably been broken up as soon as visible: the few pieces remaining are never enough to give much information as to their site. But, fortunately for us, the Greeks at Naukratis, as elsewhere, showed the versatility of their nature; and, since stone was not to be had without great difficulty in the Delta, they took to building in mud-brick faced with plaster; and this apparently more fragile structure has often remained, simply because it offers less attraction to the spoiler.

The temples both of the Dioscuri and of Aphrodite were of mud-brick, and a plan of both is consequently recoverable. The former even

has pillars in front of it, built of mud-brick faced with plaster. The temple of Aphrodite shows three distinct buildings of different periods, one above another; and to the earliest of these belongs a great altar in front, with steps leading up to it. This altar, like that of Zeus at Olympia, was composed of the ashes of victims, held together by a thin casing of brick.

But the importance of this temple does not lie chiefly in its architectural peculiarities. All around it there was found a thick layer of rubbish, consisting almost entirely of fragments of the finest archaic pottery: and almost all the best specimens of this are of a ware which probably belongs to Naukratis itself. I have roughly estimated the number of good fragments I have recovered from this layer at 150,000: this fact will give some notion of its richness; many pieces are inscribed; and many, I hope, will fit together into more or less complete wholes. Then some 100 archaic statuettes, mostly fragmentary, have also appeared: and these, dating as they do from the infancy of Greek art, will throw most valuable light on its relations with Egypt at that period. Nothing in this layer seems to be later than the middle of the sixth century B. C., and much is certainly earlier.

The temenos of the Samian Hera has also been recovered, but has not yet yielded much of intrinsic value, though fragments of a few dedicated vases have been found.

The main part, at least, of the cemetery lay to the north of the ancient city, not far from the canal that formed its highway to the sea. Unfortunately, a great part of it lies below a modern village; but a portion lying on an outlying mound has been completely turned over. Not many graves of the archaic period have been found, and none of value: later graves, from the fifth to the third century B. C., have been numerous, and have yielded a very fair collection of small vases, bronze mirrors, etc., and a large number of terracotta *gorgoneia* that seem once to have decorated the outside of wooden coffins. In one case, a small rouge-pot was found, with the rouge in it as fit for use as on the day it was buried.

The season is now drawing to an end, and I do not expect that much that is new in the way of discovery will occur; I have still one or two sites to finish clearing; but the year's results will be gathered mostly from what I have already stored here. To work these out will give me employment enough for some time to come.

ERNEST A. GARDNER.

REVIEWS AND NOTICES OF BOOKS.

ESSAYS ON THE ART OF PHEIDIAS, by CHARLES WALDSTEIN, M. A.; Director of the Fitzwilliam Museum and Reader of Classical Archæology in the University of Cambridge; Ph. D. Heidelberg; M. A. Columbia College, N. Y.—Cambridge: University Press. New York: The Century Co. 1885. 8vo, pp. xix—431, 16 plates and 25 figures.

In the history of any science, nothing is more rare than the appearance among its professors of a man with the impulse to connect it with knowledge as a whole,—nothing except, perhaps, a man with the ability so to connect it. The great body of writers in each science know and advance it only within itself, and for the most part mechanically. Of knowledge as a true and valuable guide for human life, they have no conception; and the relation of their own science to human life they never consider, nor mark the mutual aid of sciences which illustrate different aspects of life. To ordinary workers, knowledge is the mechanical sum of sciences, not an intelligible whole, of which every special science is a member. It is, therefore, always noteworthy when a book appears, the author of which shows some appreciation of the fact that his subject stands in close relation with all knowledge; and that not the least portion of his task is to find out what that relation is. Briefly, the author of such a book is a moral teacher, as well as an advancer of learning. The science of archæology has been no richer than other sciences in men of this order. But, when such a man has come, he has influenced the whole subsequent course of the science. No better instance can be given than Otfried Müller. His *Handbuch der Archäologie der Kunst* was not only one of the books which dignify their subject and show the utility of it, but a book which laid down the lines on which to study it: lines which belonged to knowledge in general, rather than to the special science of archæology. In fact, this is true of all Müller's work: classical archaeology, the history of the classical literatures, were to him parts of the knowledge of ancient moral life, and this of moral life as a whole, interpreted by science.

Since Müller's time, archæology has for the most part settled back into itself: it has become a region apart, of interest only to the *Gelehrten vom*

Fach. Archæologists, indeed, are apt to regard as empty enthusiasm anything meant to show the general use and bearing of the facts of their science. Yet, it is the sign of a master to be able to distinguish devotion to great ideas from empty enthusiasm, and to see that, while the latter is the least, the former is the most, profitable thing in the world. There have been some signs, of late, that, among younger archæologists, the need of a truer conception of their science is beginning to be felt. M. Salomon Reinach has devoted some of the acutest pages of his acute *Manuel de Philologie Classique* to a consideration of what classical philology is. There could be no better sign. The first thing the archæologist should do, is to settle what his science is; as Dr. Waldstein says: "the progress of any branch of investigation is most seriously retarded by ignorance of its true province, its aims, and means of inquiry:" and we may add that this is the smallest part of the matter. By this ignorance, not only is progress in investigation retarded, but also the value of the science in the advancement of wisdom is made almost *nil*.

It is to give Dr. Waldstein's book high praise to say that, more than any other that has recently appeared, it expresses the new tendency among archæologists: it is in the line of advance of the true science of archæology, in its relation with knowledge in general. It is a book of principles; to quote our author again: "In these essays the general principles will be illustrated and fixed by the individual and concrete instances; while the special inquiries will be appreciated, because viewed in the light of the general definition of the archæological system." Such a book is to be judged, not in its kind, but by the wisest and highest standard: as a book, not as a piece of mechanical work. Few books deserve so high praise as this,—few archæological books, certainly. But the privilege carries with it the necessity of submitting to the severest criticism.

The first essay in the book is upon *The Province, Aim, and Methods of the Study of Classical Archæology*. That there is such an essay in the book, is one of the sources of our confidence that Dr. Waldstein is to do much to bring back to its relation with humane things the science of Archæology; and this essay contains what it would profit all archæologists and all classical students to read and ponder. One way of looking at facts and ideas, says Dr. Waldstein, is the plastic way, is having them present themselves before the mind as forms, rather than formulas; the Greeks had in a remarkable degree this plastic way of seeing things, and their art was the best reproduction of their manner of thinking. We can, then, best make ourselves acquainted with one of the most characteristic, and at the same time important and profitable, qualities of Greek thought, by the study of Greek art: and this systematic study of Greek art is Archæology, which thus shows itself to be, "together with ancient

literature a co-ordinate department of the science of classical antiquity." Therefore Dr. Waldstein objects to ranking Archæology under classical Philology. He fears a return to the Hermann point of view; i. e., that all investigations of antiquity have but one use, to subserve the criticism and interpretation of the ancient authors. This is admirable; yet it may be that Dr. Waldstein carries his fear too far. We cannot help thinking that Wolf and Boeckh and Otfried Müller have made this point of view no longer possible, and that, as a matter of mere nomenclature, it is useful to say, with M. Reinach, "La philologie classique est la science de la vie intellectuelle des anciens, et particulièrement des Romains et des Grecs." The name "Science of classical antiquity" is ponderous in comparison with "Classical Philology."

Of what we have quoted from this essay on the science of classical archæology, we have nothing to say but praise. To have shown that it is really a science in relation with human faculty and life, is a great achievement. Dr. Waldstein has done this, and interestingly. It may be that he has not said all there is to say; but at any rate he has said more than has yet been said.

Dr. Waldstein's remarks about the methods of research, that preliminary portion of the science of classical archæology, are excellent,—especially his exhortations to archæologists to cease studying their subject in the literary remains of antiquity, instead of training themselves to see differences in the manner and technique of works themselves. The keenness of Dr. Waldstein's eyes has been of great use to him in his own researches, and he rightly thinks that hereafter anything of importance can only be accomplished with the help of trained eyes. Yet his comparative disregard of the literary sources of antiquity has led to a certain inaccuracy in his dealing with those sources, which he will himself recognize as a defect in his work. In a certain way, it matters little that he says that "an oracle addressed to Sulla combines Beauty ($\tau\omicron\delta\ \kappa\acute{\alpha}\lambda\lambda\omicron\varsigma$) with Grandeur ($\tau\omicron\delta\ \mu\acute{\epsilon}\gamma\epsilon\theta\omicron\varsigma$), as the chief characteristic" of the statue of Zeus at Olympia (p. 70), when really this statement is made by implication in the description of the vision that gave the oracle; or that, on the same page, he translates the statement of Plotinos, $\acute{\epsilon}\pi\epsilon\iota\tau\alpha$ (sc. $\acute{\epsilon}\pi\lambda\alpha\sigma\epsilon\nu$) $\acute{\omicron}$ $\Phi\epsilon\iota\delta\iota\alpha\varsigma$ $\tau\omicron\delta\ \Delta\iota\alpha$ $\pi\rho\acute{\omicron}\varsigma$ $\omicron\upsilon\delta\acute{\epsilon}\nu$ $\alpha\iota\sigma\theta\eta\tau\omicron\delta\ \nu\omicron\iota\acute{\eta}\sigma\alpha\varsigma$, $\acute{\alpha}\lambda\lambda\grave{\alpha}$ $\lambda\alpha\beta\acute{\omega}\nu$ ($\nu\tilde{\omega}$) $\omicron\iota\omicron\varsigma$ $\acute{\alpha}\nu$ $\gamma\acute{\epsilon}\nu\omicron\iota\tau\omicron$, $\epsilon\iota$ $\eta\mu\acute{\iota}\nu$ $\acute{\omicron}$ $\text{Ze}\acute{\upsilon}\varsigma$ $\delta\iota'$ $\acute{\omicron}\mu\mu\acute{\alpha}\tau\omega\upsilon$ $\acute{\epsilon}\theta\acute{\epsilon}\lambda\omicron\iota$ $\phi\alpha\nu\eta\gamma\alpha\iota$, by "Pheidias had conceived of Zeus in his imagination as Zeus would have been, if he had appeared to him face to face." Such inaccuracies, in a certain way, matter little; yet there is, in such slips, a suggestion that the author considers that most useful but easily abused book, Overbeck's *Schriftquellen* sufficient to furnish an archæologist's classical reading; and that he so little esteems the light on the science of plastic thinking to be obtained from a deep and accurate study

of Greek literature, that he would have the archæologist content himself with isolated extracts, taken without regard to their context, bearing only on the facts of archæology, and read for the general meaning alone. May we say that the archæologist up to Dr. Waldstein's first high conception of his science, will not fail in the same fineness and accuracy in dealing with his written sources, that he shows in dealing with the monuments? Both will help him greatly in his science of ancient thought.

I have purposely dwelt at considerable length on Dr. Waldstein's first essay, because it is on the whole the most novel and characteristic in the book,—the most typical of the new tendency in classical archæology. The second essay is again general, but within the limits of the science itself: it is on *The Spirit of the Art of Pheidias, in its Relation to his Age, Life and Character*. The chapter is really an essay in applied ethics. Much of it is elementary, both in art criticism and in ethics: but, also, much of it is deep-going and edifying. It is impossible to give any notion of the substance of it, beyond saying that in it much is done to show the value of the plastic way of thinking—which was that of Pheidias.

Having given us a general view, Dr. Waldstein takes us through the Parthenon, pausing, as he goes, to speak of each portion of the sculptural adornment of the building. It is interesting to find him everywhere giving individuality to his work by making what of new he himself has to contribute the centre of his essay. First, it is the metopes, and Dr. Waldstein gives, substantially as he published it in October, 1882, in the *Journal of Hellenic Studies*, his discovery of a marble head in the Louvre that exactly fitted the body of a Lapith in one of the metopes among the Elgin marbles. Then come the pediments, western and eastern. Here Dr. Waldstein describes a fragment discovered at Venice first by Mr. Woolney, the sculptor, and independently by himself; and strives to show that it had a place in the western pediment. Perhaps, what is of most interest in this attempt is the opportunity it affords the author for a complete unfolding of his method of research. No archæologist can fail to profit by seeing so severe an induction applied to his science. Dr. Waldstein's attempt to identify the figures of the eastern pediment is also full of interest. Such keenness of eye joined with such ingenuity of mind and artistic insight can never fail to hold our attention. Yet one cannot help thinking that an attempt like this is at best only a chance for mental gymnastics, not for the obtaining of positive results.

Two of the essays in the book deal with the Parthenon frieze. They mainly consist of an elaborate discussion of some terracottas found in Paris, Rome, and Copenhagen which reproduce portions of the frieze. In a terracotta fragment of the Louvre Dr. Waldstein recognized the Athena of the eastern frieze; and a piece found in the Museo Kircheriano

at Rome proved to be the adjoining fragment. Dr. Waldstein's startling conjecture, that these terracottas were once part of the working-model made by Pheidias for the Parthenon frieze, is practically retracted in a note written afterwards and appended to the Essays. In fact, their very antiquity may well be doubted, especially in view of their relation to the plaster casts which he afterward discovered; but of this it would be incautious to judge without ocular evidence, though even the plates indicate that the plaques were not by the hand of a master.

In the essay on the chryselephantine Athena Parthenos, an attempt is made, with perhaps too much of positiveness of statement, to show that there was not a column to support the right hand of the statue with its Nike: it is asserted that, by a system of counter-weights, the Nike could be supported without a column. Relying solely on the statement in various ancient authors, that the statue was so built that, if any one should attempt to remove the portrait of Pheidias from the shield on the left, the whole would fall to pieces,—relying solely on this, Dr. Waldstein makes the following statement: "No doubt in the shield on the left hand was the weight or power which, passing through the centre, supported the right arm and gave equilibrium to the whole statue." Surely, this "no doubt" is a dangerous phrase for so uncertain a matter.

The next essay to this, *The School of Pheidias and the Attic Sepulchral Reliefs*, so far as we know, is the first in which an adequate and connected account has been attempted of the sepulchral monuments of Athens that show a resemblance in style to the Parthenon sculptures. It has long been our opinion that far too little has been made of these beautiful reliefs. The close relation between them and the more famous sculptures has indeed long since been pointed out; but with this archæologists seem for the most part to have been satisfied; apparently considering them as direct imitations, and so of little essential interest. It is reserved for Dr. Waldstein to show their independence within the limits of their manner, and to suggest that they come from the hands of some of the numerous sculptors trained in the works of Pheidias, but thrown out of public employment by the Peloponnesian war, and compelled to earn a livelihood by a humbler exercise of their skill. But again Dr. Waldstein seems to us not to keep within the bounds of a just moderation when he says that, "There can be no doubt that this class of works of sculpture bridged over the step from the art of the fifth to the art of the fourth century, that they were a stepping-stone from the divine and religious sculpture to the sculpture that partook of a more human character, from the art of Pheidias to the art of Praxiteles."

The above is the last essay on the art proper of Pheidias; but a long appendix contains several essays, previously published, bearing upon the history of Greek art. First comes an account of Pythagoras of Rhegion,

and a discussion of the so-called Choiseul-Gouffier Apollo in the British Museum. This discussion, first published in 1880 in the *Journal of Hellenic Studies*, tended to show that the beautiful statue in question could not be an Apollo, but was a pugilist, and most likely the work of Pythagoras. Dr. Waldstein now adds a page or two of admirable new matter, in which he shows that the Choiseul-Gouffier statue is of a type so famous as to have been followed by the die-sinkers of coins in Sicily in the middle of the fifth century B. C., and that this type was only superseded by that established in the end of the same century by a yet more famous master, Polykleitos. Next comes an essay on *Praxiteles and the Hermes with the Infant Dionysos*, in which, after conclusively reasoning away all doubts as to the Hermes being by the famous Praxiteles, he makes a very able psychologic analysis of the spirit of the art of Praxiteles. In contrast to the art of Pheidias, with its noble naïveté, simplicity, and serene grandeur, he finds in the Praxitelean ideal a sophisticated variety, a passive, moody sensibility, giving to it that sweet melancholy which he sees as the subjective element of Praxitelean art. He presents the Hermes, with its dreamy softness, its sad abstraction and tenderness, combined with latent strength, as a typical work, enlightening us, not only as to the ideal of Praxiteles, but as to the characteristics of the Greek epoch in which he lived; and he traces a likeness between the consciousness that produced this artistic type, and that of the romanticists of our century, De Musset, Shelley, Heine, Chopin.

Dr. Waldstein ends his volume with two essays, one on *The Influence of Athletic Games upon Greek Art*; the other on *The Eastern Pediment of the Temple of Zeus at Olympia, and the Western Pediment of the Parthenon*. In the latter, the author works from Brunn's geographical method of interpretation of pedimental groups,—a method which Dr. Waldstein has thoroughly made his own.

ARTHUR RICHMOND MARSH.

RECHERCHES SUR LA GLYPTIQUE ORIENTALE par M. JOACHIM MÉNANT. Première Partie. CYLINDRES DE LA CHALDÉE. 4to, pp. 263. Paris, 1883, *Maisonneuve*.

— Seconde Partie. CYLINDRES DE L'ASSYRIE, MÉDIE, ASIE-MINEURE, PERSE, ÉGYPTE ET PHÉNICIE. 4to, pp. 271. Paris, 1886, *Maisonneuve et Leclerc*. [In the two volumes there are eleven plates and 433 illustrations in the text.]

In these two volumes the subject of the intaglios of Western Asia has been for the first time treated by a scholar who is an authority in Assyri-

ology, and has prepared himself for the task by many years of patient study and investigation. The result has been to place before us a work of capital importance for archæology in general, and invaluable for the study of Babylonian antiquities.

In order to review intelligently the second of these volumes, published but a few weeks since, it is necessary to combine with it a consideration of the first, published nearly three years ago, as the two are intimately connected: the Persian and late-Babylonian cylinders, especially, must be studied side by side with those of the earlier Babylonian Empire, in order to understand their genealogy. This work is a first step in the science, and as such has about it much that is tentative, while it leaves a host of questions the solution of which is not even attempted. This difficulty was inherent in the subject and our present knowledge of it, and we must thank M. Ménant for his courage in giving us a work that will be the background on which future attempts will for a long time be worked. One of the greatest difficulties encountered was the classification and arrangement of the material: to get any order out of this almost hopeless chaos. Thousands of these engraved Babylonian seals existed in public museums and private collections, but our notions as to their age, the schools they belong to, and the subjects cut upon them, were hazy in the extreme. In fact, but little importance had been attached to these specimens of the art of Western Asia: their small size and the ignorance as to their character had prevented any attempt to make them tell a story that should throw light on the art-history of Babylonia and Assyria. This was all the more prejudicial to our knowledge of Babylonian archæology, because these small seals were almost the only remains that had come to our notice of the plastic art of Babylonia, with its three thousand years of existence. Until M. de Sarzec's discovery of the sculptures of Telloh, in 1881, we knew of not a single specimen of early Babylonian sculpture: all that we possessed were a few reliefs belonging to the period of complete decadence (xii to ix cent. B. C.), when Assyria had already attained to supremacy (steles of Marduk-idin-ahi, etc.). This almost complete absence of sculpture must not be considered due to unpopularity of the art in Babylonia: though the bas-relief was but little used, we know that sculpture in the round was constantly practised. The real reason is that so little scientific excavation has been accomplished on the sites of the old Babylonian cities. In the meantime, the elements of a comparison between the plastic art of Assyria and that of its more ancient neighbor were wanting, and the mistake could be freely indulged in which has led many and even eminent authorities in art-history to confound the arts of the two countries, and to deny to each the individuality that truly belongs to it.

It is here that the importance of the seal-cylinders arises. Being in general use at all times, they date back to the earliest period, and descend in unbroken succession to the time of the Persian and Seleucid dominion; so that eventually, when their various stages have been identified, they will form of themselves an epitome of the development of the glyptic art in the East. It is interesting to find that, from these cylinders alone, the gulf between Babylonian and Assyrian art is perfectly evident, both as to technique and conception. In a Babylonian cylinder the figures have no marked outlines, nor is there any attempt to emphasize the minor lines of muscle, drapery, or ornamentation: action is almost entirely wanting, the scenes are devoid of any striking effects, and the expression is usually quiet. In an Assyrian cylinder, on the contrary, the outlines are sharp, and, as in the larger sculptures, there is an abundance of detail in the emphasis of lines and ornamentation: most striking of all is the vigorous action, the expression, often exaggerated, and the striving after strong effects. A study of the scenes represented shows that the same distinction presided over the conception, as well as the execution, of these miniature compositions: the favorite Babylonian legends are often dropped, and when used are generally modified; while others connected with the worship of Aššur are introduced.

The seals were made of many kinds of material: hematite, black and colored marbles, jasper and porphyry; rock-crystal, onyx, chalcedony, agate, lapis-lazuli, carnelian, sapphirine, ivory and bone. The shapes varied according to the method of using them: but the two most commonly made were the conical and the cylindrical; the former of which appears only at a late period, the earlier seals being invariably cylinders with a hole through the centre for a metal rod by which to roll them on the wet clay or the wax, and by which they were suspended around the person of the wearer. They were a necessary part of the costume of Babylonian and Assyrian gentlemen; not only of those who occupied official positions, but of all adult private persons, who used them to affix their signature to documents of any description. This accounts for the profusion in which they are found. All bear engraved some figured scene, generally of religious import, and very often the name of the owner is added. The subjects are taken from the mythology or legends of Babylonia; a large proportion representing an adoration scene or a sacrifice, in which is represented the owner before his patron divinity, either alone or led forward by a priestly intercessor. In the earlier series the variety of subjects is very great, and many of them, relating to early Babylonian popular legends, are as yet inexplicable to the archæologist. It is clear, however, that a careful comparative study of these engraved stones with the early literature will eventually throw much light on the figured

mythology of Babylonia, which is still a blank to us. At present no certain interpretation of the greater part of the subjects is possible. The inscriptions are usually difficult to read on account of their archaism and brevity, consisting, as they do, mainly of proper names.

Several collections of seals have already been published before Ménéant's present work, by Cullimore and Lajard in particular, but without any intelligent criticism. At the present moment, M. Ménéant himself is editing in heliotype plates the entire collection of M. de Clercq, consisting of four hundred cylinders; the largest in existence except that of the British Museum which contains six hundred and sixty. In Paris, the Bibliothèque Nationale and the Louvre together contain about as many, each of them having over three hundred seals. The only other European collection of importance is that of the Hague (150), but, as the United States are beginning to collect quite a number, I will mention these collections of ours with more detail for the benefit of foreign archæologists. The Metropolitan Museum of New York possesses at present over sixty seals, some belonging to the Kypriote collections, a few coming from previous purchases, and a large number from the collection brought here two years ago by M. Maimon. Mr. R. S. Williams of Utica (N. Y.) has a choice collection of some twenty-five, among which is a fine royal cylinder. M. Ménéant will illustrate these in the next number of the JOURNAL. At Amherst College there is a collection of about the same number, sent over at various times from Syria. The largest collection and one of the finest in existence is, however, that brought home, nearly a year ago, by Dr. William Hayes Ward, who made it during the Wolfe Expedition to Babylonia, conducted under the auspices of the Archæological Institute. This collection, amounting to about two hundred and fifty Babylonian, Assyrian, Persian, Syrian, Hittite and Phœnician cylinders, includes many choice examples, and many which possess the peculiar value that the localities from which they came are known. As I shall have occasion to remark on the impossibility which M. Ménéant has found, with few exceptions, of attributing any group of cylinders with certainty to any particular school and city, the importance of this certified provenance will easily be seen.

In M. Ménéant's first volume, the difficulty of classification was most serious. The method which he adopted was partly geographical, partly according to subject. Of course, the more or less archaic forms of the inscriptions that accompanied many of them were good evidence as to their belonging to the early or the middle empire: however, the difference in style, even among the earliest specimens, was apparent, and the main difficulty was and is to identify each style with some kingdom or period. A royal cylinder of "Segani-sar-luh," a king of Sippara-Agadé,

probably anterior to Sargon I (3800 B. C.), is a good though narrow basis for attributing to the school of Agadé a large group of very archaic seals portraying, principally, scenes from the legend of Izdubar, the Babylonian Herakles. Seals of the great kings of Ur,—Ur-Gur, Dungi (2900–2800), “Gamil-Sin,”—and of their dependents the kings of Nippur and Zirgulla, show that at Ur, the greatest city of South Babylonia, there existed an important and characteristic school of sculpture, whose types stand out clearly from those of all other groups. The school of Erech is not so well established: though it certainly existed as an important unit, the only two examples brought forward do not give it much individuality. But the styles of Agadé and Ur have a number of contrasting characteristics. In the Agadé seals the style is bold and massive; the figures strong; the animals rendered with truthfulness to nature; figures in the nude are frequent; and here more than in any other examples we find a careful study of anatomy. The effects are broad, though there is much careful work in details. The scenes on the seals from Ur are totally different, and on examination seem even to point to a difference of race between the peoples portrayed on the works of North (Agadé) and those of South Babylonia (Ur). The figures of Ur are long and slender, with clinging drapery which is often divided into flounces, especially in the female figures; there is less knowledge of anatomy and no attempt to portray the nude, and in general a much less artistic faculty than at Agadé. The heads are small and of a more delicate, ascetic type. Related to the school of Agadé is a series of seals engraved with fantastic animals pitted against each other or against Izdubar and Heabani. On one point in the arrangement and relation of classes, we may be allowed to differ from M. Ménant. In point of age, he places at the very head those seals where fantastic animals are drawn in the rudest and most barbarous manner. Dr. Ward has already suggested that these works may well be assigned to the decadence, and not to the rise, of the glyptic art in Babylonia. The earliest works whose age we know, show that the appreciation of animal form was strongest at this time. The common error that art must follow a law of evolution from the barbarous state, and gradually advance to perfection, is one that leads to many misconceptions.

A chapter is set apart for the works belonging to the time of the *Patesi*, a term generally translated *viceroi* and applied to the minor rulers of Babylonian cities and states. It may be well to recognize a difference in age among these works, and to place some at a much later date than would here be indicated, for the title of *Patesi* lasted for many centuries, and was in use for a long time after the rise of the empires of which Sargon I and Ur-Gur were the founders. To continue in the order of M.

Ménant's first volume, we find that the chapters which follow those on Agadé, Erech and Ur, are entitled: Sacrifices—Beltis—Invocations—Various Subjects—Zirgurla—Larsam. Many are the cylinders on which religious sacrifices are represented, and these M. Ménant wishes to connect with the school of Ur, which made of this subject a specialty: he has pointed out, quite rightly, the interesting texts in the ritualistic and astrological literature of Babylonia and Assyria that throw light on these religious rites, represented in so varied a manner. In some cases we cannot fail to recognize proofs of those human sacrifices by which the Babylonians cast a blot on their civilization. The subject discussed in the chapter devoted to representations in which there appears a nude female deity is not very easy of solution: it derives its main difficulty—that of the identification of this figure—from the very haziness of our knowledge of the Babylonian pantheon. We have not yet learned to make the requisite mythological distinctions between the various female divinities worshipped throughout Babylonia: Nana, Ishtar, Belit, Anat, Zarpanit. We are still unable to trace the development of their myths; to distinguish the earlier from the later philosophic conception; to separate the special worship, which the different cities devoted to their patron divinities, from the position these occupied in the general pantheon.

Another class of seals bear inscriptions containing invocations in favor of the wearer: these are connected with the general belief of the Babylonians in magic and in the protective power of certain formulas. M. Ménant, in several places, hints at one of the most interesting questions raised by a study of the seals: the identity of the various divinities represented, and the relation to these divinities of certain animals and signs that appear on the seals either in connection with these divinities or as their symbols. He remarks (p. 204): "On a établi de tout temps une corrélation plus ou moins directe entre certaines divinités et certains animaux. Cette corrélation existait évidemment en Chaldée au moment où nous rencontrons ainsi l'animal servant de piédestal à la divinité. Si nous connaissions cette association d'idées, il nous serait possible de déterminer, par le genre de l'animal, la divinité que l'artiste a voulu rendre, mais c'est précisément ce qu'il faut chercher." It would be easy to prove the great importance of the study of this relationship, as a successful attempt would give us the key to the entire figured representation of Babylonian mythology. In the chapter on Larsa, attention is called to the importance of the clay contract-tablets, found there by Loftus, bearing the impressions of the seals. As there are many of them dated, some from the reign of Rim-Agu, others from that of Hammurabi (2168 B. C.), they are of especial interest for comparative study both of subject and of style.

M. Ménant has wisely abstained from formulating any dogmatic opinion

on the age of the seals described in his first volume, except in so far as he considers them all to be anterior to the reign of Hammurabi. Some assistance can be derived from the materials themselves, as we know that certain stones—black marble and hematite, for example—were used at an early period, while others came into common use at a later date. Indications of style and of more or less perfection of workmanship are often deceptive, as inferior work was done at all times: many seals were executed by special order, while the greater number were ready-made, and turned out by the hundreds, the purchasers simply having their names engraved on them. But, setting aside these uncertainties, what are the general conclusions to be drawn from what we learn of the practice of the glyptic art in Babylonia? We already knew that from the dawn of this civilization were practised the arts of metal-founding, of carving colossal statues out of the hardest marble, and of weaving stuffs in wondrous patterns; and now we find that the Babylonians were acquainted with all the complicated instruments necessary for the perfect cutting of *pietra dura*, and that they probably used the lens from the earliest period.

In the second volume the seal-cylinders of Assyria are treated, and at the same time those of Media, Asia Minor, Persia, Egypt and Phœnicia. The connecting link between the arts of Babylonia and Assyria has always remained a mystery, and this is just as true in the glyptic art as it is in large sculpture; and this difficulty M. Ménant has met without being able to solve. To those who hold to the practical dependence of Assyria on the earlier civilization of Babylonia this is certainly a disappointment. In reality, there did exist a close relationship, but I have already remarked on the recklessness with which this relationship is disfigured and enlarged. For Assyria this small branch of the fine arts has by no means the same unique interest as for Babylonian art and mythology: the great bas-reliefs are a far better index of its plastic development. Besides, we do not find in Assyrian seals the same variety of types and subjects: there is far greater repetition, and the work seems less artistic and more perfunctory. Consequently, much of the interest vanishes, though at the same time we better comprehend the scenes portrayed, and are also able to assign the works with somewhat more precision to their particular period and school. We have already remarked on the differences in technique and conception between the seals of the two countries. Among other differences a further, merely mechanical, one may be here noted: the inscriptions are traced on the cylinders as they should be read, and not reversed as in Babylonia. A fundamental difference is shown in the drawing of the human form: in Babylonian seals there is not the least disinclination to draw the naked figure,—often with success, as at Agadé,—but with the Assyrian seal-cutter this was never

attempted. A comparison of the small works with the larger sculpture shows that the seal-cutters were mere artisans, as compared with the sculptors, and that their work was careless and inartistic. Animals, so finely portrayed on Babylonian seals, and rendered with so much life and beauty in the Assyrian bas-reliefs, are given in an unskilful and sketchy manner. In the material execution itself there is also a decided inferiority, except in the case of royal cylinders and others of especial importance.

It would be natural to suppose the existence of separate schools in the several great cities of Assyria: Aššur, Kalah, Nineveh and Arbela; but no proofs of this exist. In suggesting a chronological succession, M. Ménant places at the beginning of Assyrian glyptics the seals that are executed with the point; that is, where the outlines are merely engraved, without any modelling: to a slightly later period he assigns those examples where the *bouterolle* or drilling hammer is used; and to the Sargonid dynasty, finally, the perfection of the technique, when the figures no longer bear any disfiguring traces of the instruments used in their execution. Much obscurity attaches to the whole subject from the almost complete lack of inscriptions, which, on the seals of Babylonia, were so numerous and helped to localize and to date certain styles. A comparative study of the subjects shows that a large proportion of them can be explained from our acquaintance with Assyrian literature and mythology. Among the figures that appear to be purely Assyrian inventions are the sphinx, the man-headed bull, the man-fish, the eagle-headed genius, the winged symbol of the god Aššur, the sacred tree, the men-caryatides, etc.

Connected with the Assyrian glyptic school were, according to M. Ménant, the seals of Armenia and Asia Minor,—the latter being represented by the Hittites. Here we meet a very delicate question, and one on which it is impossible to speak with any certainty. That the Hittites used seals engraved with their own hieroglyphic system is certain, and we cannot deny that they were well acquainted with the art of seal-cutting, as with all the arts. But the examples of Hittite seals that are brought forward are few in number. Some have Hittite characters engraved on them; others bear Assyrian inscriptions, like that of the Musée Fol illustrated in this number of the JOURNAL (p. 132): all have certain characteristics in common.

The chapter on "The Second Empire of Chaldæa" is rather short, and the reason is, apparently, the difficulty of recognizing these works of late Babylonian art: the antiquarian mania, so well personified by Nabuna'id (Nabonidos, 556 B. C.), which led to the rebuilding of old temples and to studies for ascertaining their precise age, made the artist of this period seek to reproduce exactly, not only the archaic inscriptional

writing, but the very subjects and style of the Early Empire. Often, it is true, he betrayed himself by a slip; by the introduction of some incongruous element or a palpable paleographical error; but the attempt involves the question in a certain obscurity. The best *points d'appui* are the terracotta contract-tablets having impressions of cylinders, which, being exactly dated, show what types of seals were then used. The earliest date found by M. Ménant on the British Museum contracts is the 2d year of Nebuchadnezzar; the latest, the 14th year of Darius.

Persia under the Akhæmenidæ was in seal-cutting, as in monumental sculpture, merely an inferior copyist of Assyria. The famous seal of King Darius in the British Museum, which may be taken as showing the high-water mark of Persian glyptichs, shows careful and skilful execution, but an entire lack of artistic talent, of knowledge of form and proportion, and a ponderous stiffness.

The last and one of the most interesting chapters is devoted to the seals of Phœnicia. In a preliminary chapter on Egyptian seals, M. Ménant shows that those which present a combination of Egyptian subjects with Assyrian inscriptions, or vice-versa, are due to the Phœnicians, the great go-betweens of the East, who were in such close relations at the same time with Assyria and with Egypt. Trading as they did with Nineveh, where many of their seals are found impressed on contract-tablets, they were obliged to adopt the Assyrian custom of employing seals, and with the idea borrowed also the form. Sometimes it is evident that they purchased Assyrian seals ready-made, and had their names inscribed upon them, *tant bien que mal*, in Phœnician letters. But, being a volatile nation, they shortly came to consider the Egyptian scarab as a more convenient form than the cylinder for their seals. Still, though they adhered generally to this Egyptian form, the themes of their seals were for the greater part quite Assyrian, and, at a later period, Persian. The numerous seals found in Kypros show the native Phœnician execution: some date back to Babylonian models, others are imitations of Assyrian and Egyptian works, while in some the influence of Hittite models is evident. There appears to have been in Kypros a manufactory which turned out quantities of third-class works at low prices, which found a ready market on the mainland: the execution is always of the rudest and most summary description, without any attempt at artistic or finished workmanship.

A. L. FROTHINGHAM, JR.

ANCIENT ROME IN 1885, by J. HENRY MIDDLETON. Edinburgh; Adam and Charles Black: New York; Scribner & Welford. 8vo, pp. xxvi-512.

This book declares itself a guide-book to the architectural remains of ancient Rome. As such, it is to be examined for accuracy in general statement and in minute detail; for completeness; for convenience of form and structure, implying handiness as a work of reference; and for readableness,—an added grace, which even a guide-book may possess. As to the need of another guide-book to Rome, that question need not come up at all, for recent discoveries have remade Roman archæology. As this book contains a description of the very latest discoveries, it has at once a value which none of its predecessors have. The book which tells us about the *Atrium Vestæ*, and of the numerous private houses decorated with reliefs and paintings which have been discovered only to be destroyed during the past few years, has indeed a special claim upon us. But it is not in any sense true, as has been said in some reviews, that these recent discoveries are the only “excuse for adding another to the many books on the archæology of Rome.” It appears to be true, on the contrary, that no existing book in any language gives so much of what the student of archæology needs in Rome, or to refer to when Rome is far away. The only book that can be compared with Mr. Middleton’s is Gsel-Fels’ *Rom und die Campagna*, of 1883 (unless a later edition of the same contains still farther improvements): there only will be found anything like an adequate account of Roman topography and geology,—of the building materials of old Rome,—of the buildings themselves, with discrimination between what is known and what is guessed at,—of the decorations as they have been found to be, and not as somebody has chosen to misunderstand an ancient writer who himself misunderstood. And, if Gsel-Fels’ book is the only one that can be compared with Middleton’s, it is also inferior to Middleton’s in this respect: that it has to do everything at once, and to serve, not the archæological student only, but the most butterfly travellers, as well. The Germans make their tour to Rome almost as regularly as the English: and Gsel-Fels is to them, as Murray is to the English, the book that one buys who wants a little more than Baedeker gives. But nobody would think of buying Middleton to carry about Rome under his arm or to pore over at the hotel at night, unless strongly inclined toward the study of the ruins; and therefore Middleton is the better book for such a student.

Mr. Burns’ good and interesting quarto with a title identical with Doctor Gsel-Fels’ volume (or with a translation of it) is not to be ignored. But “Rome in 1885” is the more precise, the more technically exact,

the more workmanlike book ; and far more free from the vice of writing "about and about" the subject,—a vice unendurable in guide-books. And yet—to take up our *desiderata* in reverse order—the book under consideration is eminently readable. When a writer has a great subject, all that he needs, to be readable, is that sort of imagination which reveals to him the essential parts of it. And our guide-book becomes less instead of more readable; when the author has been at pains to avoid what he thinks the dry guide-book style, and becomes fluent and discursive. That is the fault of Mr. Burns' otherwise excellent book: that is the fault of many otherwise excellent French books of similar subject: the almost-avowed effort to avoid the catalogue style, and to invest with pleasant discursiveness that which does not admit of it. And so of the plan of the book before us: it is made doubly useful by the care taken to refer, backward and forward, to other passages which bear upon the subject in hand. When actively in use, the book can be easily studied without an index. It is only when it stands on the shelf, and is applied to for suddenly-required answers to questions, that the very inadequate index becomes an annoyance.

Now, as regards completeness, it is to be said that Mr. Middleton has taken almost no notice of architectural style and character. . Rome is indeed a poor place in which to study architectural design. The impressiveness of Roman monuments was never the result of noble or delicate designing: it came of itself, from vastness and massiveness and unintended happiness of proportion,—like the impressiveness of a mediæval castle, or of a sea-side cliff. But the simple fact that all the architecture of Europe for fifteen centuries has sprung from Rome as its common source,—the great stream flowing uniformly for a short time, and then dividing into eastern and western branches, of which the one was soon dried up, but the other has flowed on till now,—that one fact makes the doubtful good taste and the stiff and administrative style of work of the Roman imperial architects of prodigious importance to us. And no book on Roman architectural antiquities can be complete without constant and careful explanation of what each ruin has to show of the Roman feeling for architectural design. But that is all that we miss. Everything else that the volume could hold is here. No doubt, we would like to have very much more information about all the buildings named and described, but for this we need a big quarto of text and a folio of measured drawings, and that was not on the cards.

Now as to accuracy: under that head one has to allude to a certain avoidance of all mention of the doubts as to the commoner attributions. This is peculiarly objectionable in respect to the newer discoveries. Perhaps there is not one of the newly-found buildings and traces of build-

ings concerning which there is not serious dispute. The author has a perfect right to assume the correctness of his own views, especially when they are shared by the majority of competent investigators: but perhaps it is not right to ignore the other side. Mere mention of the contradictory opinion and of where it is to be found is all we ask, perhaps is all that we are entitled to. Then, in somewhat the same direction, there is a certain tendency to be too positive in assertion: and of this the most remarkable instance is that of the reiterated assertions, that brick was used, in old Rome, *only* for facing of walls; that what seemed to be vaults in old Rome were *all* make-believe vaults, solid blocks cast in one piece, having no more arch-construction than bowls or bottles; that what look like discharging-arches and relieving-arches are *all* mere superficial pretence; although, as the author admits, they were not to show in the completed work, as they would all be covered by the facing of marble or hard stucco. A great and remarkable characteristic of the later imperial building is clearly understood by our author, and well and strongly put in these repeated statements: but where is the proof of the universal applicability of these assertions, and where the authorities that can be quoted as supporting such an opinion, in the absence of proof? As to the Pantheon, for instance; has our writer any support in his assumption that here also, in this early building, the constructional brick arches apparent in walls and dome alike are all mere pretence? No one will know, for certain, until the Pantheon is torn down; in the meantime, we long for Mr. Middleton's reasons in full, and his supporting authorities for so surprising a statement. If, indeed, the Pantheon is one mass of concrete, a mere lump of inert weight, its cupola bearing solid upon its drum, as its drum upon the earth, then it is quite time our histories of architecture were corrected in a vital point, and a host of special essays put behind the fire.

The positive assertion in the Introduction, of the recent discovery that "a great city of the Rasena, highly advanced in culture and in technical skill in all the minor arts of life" once stood where Rome was to stand, has been as positively contradicted by Professor Lanciani, in the *Athenæum* of March 13th.

Now, such errors of over-confidence do not harm the book so much as they do the author. No beginner in archæology is much hurt or hindered by believing, for awhile, these two hasty assertions. Older students are slow to believe them, and never take them as positive fact. In spite of them, the book is to be recommended as the best single book there is for the student in Rome or out of Rome, for study or for reference concerning the buildings whose traces remain to us.

RUSSELL STURGIS.

JULES QUICHERAT. MÉLANGES D'ARCHÉOLOGIE ET D'HISTOIRE. ARCHÉOLOGIE DU MOYEN AGE. Mémoires et Fragments réunis par *Robert de Lasteyrie*. 8vo, pp. xiv-514 with eleven plates and figures. Paris, 1886, Picard.

It sometimes happens that men who have had the merit of developing new theories, of founding new critical methods, and of changing the course of opinion, never receive the right amount of public appreciation; and that much of the credit due to them falls to the share of those who have borrowed and restated these theories and methods at second hand, and in a manner, perhaps, more attractive to the public. It was so with Jules Quicherat, one of the most industrious and original workers in the field of mediæval archæology. To him we owe a great part of the impulse that has produced so many devotees of the science in France. A crowd of young enthusiasts left his lecture-room at the École des Chartes (where he gave, during more than thirty years, the only public course on French archæology) to propagate his teachings in their writings. Many of his theories were afterward, so to speak, appropriated by other writers, and it is only after his death that his importance has been fully realized. Several of his former pupils have undertaken to edit his works, and none with more devotion and enthusiasm than M. de Lasteyrie, the present editor of the *Gazette Archéologique*, to whom we owe the editing of that part of Quicherat's writings comprised in the present volume.

The most popular of Quicherat's works, that which had the broadest scope and offered the widest interest, was his masterly *Histoire du Costume en France*. Most of his literary activity was expended in the production of small memoirs, which, hidden in periodical publications, did not bring him much notoriety, though they showed the most admirable erudition and acuteness. His life-work was his association with the École des Chartes, of which he was Director from 1871 to the time of his death (1882), and to which he devoted his entire energy. The first paper in this volume treats of *The Basilica of Fanum built by Vitruvius*, in which he seeks to solve some of the many difficulties left unsettled by Vitruvius' text: among these is the sense of *testudo* applied to the roofing. The writer shows that the meaning of vault, which we attach to the term, did not come into vogue until post-classic times. In his *Restoration of the Basilica of St. Martin of Tours*, Quicherat brings all his ingeniousness to bear on the question of the plan and architectural features of this most important of early Frankish churches, though it is doubtful that his conclusions can be safely accepted. Other papers of an equally restricted character are his essays on the age of the cathedrals of Embrun, Grenoble, and Laon; studies on the crypt of Saint Geosmes, on the

churches of Saint Gilles, Saint Ouen of Rouen, and kindred subjects. In several of these he opposed the theory, much in vogue among a large class of French archæologists, which attributed many of the Romanesque edifices, especially of the South of France, to the Carolingian period: a fallacy even now not entirely eradicated, and which was echoed to a most pernicious degree by Ferguson in his history of architecture.

A large part of the volume is occupied by writings on the characteristics of mediæval architecture, and here M. Quicherat shows the rarest qualities: a strictly scientific mind which grasps the problem in its essential qualities; clear and correct ideas expressed in the most concise and telling language; and, besides, a systematic way of grouping his thoughts and facts. In his papers on the *ogive* and on *Romanesque architecture*, he for the first time presents, among the chaos of previous theories, a clear definition of the development of architectural forms; he proves that the vault is to be considered as the moving cause of the architectural progress of the XI and XII centuries, a fact that has since been recognized and developed by other writers. His evident talent as a teacher, in which keenness of idea and clearness of expression are the most important characteristics, is brought out by the fragments of his famous *Cours d'Archéologie*. This favorite series of lectures he intended to publish: unfortunately, he only prepared a MS. of a section of it, and that, even, was an unfinished sketch. Such as it is, M. de Lasteyrie decided to edit it, with a few changes and additions, and it is by far the most important part of the volume. His knowledge of Romanesque architecture was probably more varied and thorough than that of any living archæologist, and this, combined with his talent for systematization, makes of this an admirable treatise. The most original part of it was undoubtedly his classification of Romanesque churches. Of previous attempts the most successful was the geographical one initiated by M. de Caumont and perfected by Viollet le Duc, who firmly established it in public estimation. More recently still, Antyme Saint-Paul has elaborated it in even greater detail. But Quicherat was not satisfied with a system which seemed to him to lack a real and rational basis and to be founded, not on well-defined architectural characteristics, but on certain family similarities which did not hold good for all the works within each territory, failed to account for many specimens that were outside of the general families of styles, and did not bear in its nomenclature any relation to the nature of the style itself. To quote his words, "It has neither facilitated the study, nor advanced the knowledge of Romanesque; it has not enabled archæologists, in the presence of the monuments, to describe them except according to their instincts, still less to form a just idea of the Romanesque of different localities, in case they

have not seen it themselves." In his own classification, his point of departure is what he considers emphatically, as shown above, the keynote of Romanesque architecture,—the vault; and it is on the differentiations of the vault that he founds his classes, orders, species and families. The details of this classification, as perfected by Quicherat's long experience, are unfortunately among the parts of his *Cours* that he had not written out. What his first notions on the subject were, as they appeared in the *Revue Archéologique* of 1852, is all we can refer to. They are reprinted in this volume as ch. II of his essay on *Romanesque architecture*. The great advantage of his system of classification is that, while it does not exclude the geographical grouping, it provides for outlying examples and for exceptions, and immediately characterizes a group of buildings by their most important features. The value of the *Cours* is enhanced by the drawings and notes added by M. de Lasteyrie: the illustrations are chosen with care and are always most apt, and the notes supply much information in a small compass.

M. Quicherat's methods of thinking and writing may well serve as a model for every teacher of the science and history of architecture. He never takes anything for granted: general acceptance of a fact never prevents him from severely testing it from an independent standpoint, and casting it aside if it does not stand the test: he inculcates, at every line, the habits of observation and analysis, rather than a reliance upon books and authorities.

A. L. FROTHINGHAM, JR.

KULTURHISTORISCHER BILDERATLAS. I. ALTERTUM. Bearbeitet von PROF. DR. THEODOR SCHREIBER. Hundert Tafeln mit erklärendem Text. Leipzig, 1885, *E. A. Seeman*.

This publication runs parallel with the same firm's widely circulated *Kunsthistorische Bilderbogen*. Art is introduced only as an active phase of culture and daily life, but is placed at the head. As we turn the leaves, the mind is carried from theatrical edifices and properties, in a natural sequence, through the belongings, instruments, tools, contrivances and products of the arts of music, dancing, sculpture, painting, architecture, to the apparatus of worship, public games, military and marine equipment, trade and travel, habitation, indoor life, outdoor amusements, marriage, the school and the scholar, funeral rites, etc. The illustrations are carefully picked from standard and original publications, and sometimes they are from inedited photographs (there are ten such). The endeavor has been to illustrate antiquity by antiques only. But few

restorations, and only the most documentary, were admitted. The grouping of objects of one class, whether Greek or Roman, on the same page, facilitates comparison and makes one supplement another when the Atlas is referred to for special illustration. Other countries but Greece and Rome pass unnoticed. The aim of the letterpress is to give the succinct indications that will make the pictures intelligible, and some cross-classification. A feature of the book that raises it above the ordinary level of a scholastic manual is the statement of sources under all the cuts, to which general references to the standard hand-books correspond in the elucidations prefixed. Scholarly teachers who have access to better libraries than most of our colleges provide for their use, will find the Atlas thus serves the purpose of a visualizing index. The woodcuts, as such, betray the heterogeneous sources whence they were taken, but all study of ancient monuments and documents from woodcuts is unsatisfying, if not accompanied, as it should be, by frequent contemplation of photographs and large plates, not to say casts and models. This is the sense of Schreiber's insistence on the familiar titles; even the old tomes of the *Antichità d' Ercolano* (Naples, 1757 sqq.) are not yet superseded.

The work is one of those that enable the archæologist to pass beyond the narrow limits of his specialty and to connect it with all phases of ancient life, and for this reason is of more practical importance than the most erudite but narrow monograph. To professors of the science it will certainly prove a boon. Perhaps it would have been preferable to give a larger selection from Greek and Etruscan, instead of so large a proportion of late Roman works. We would also wish that the text were a little more developed.

ALFRED EMERSON.

CORRECTION.

In my review of the *Papers of the American School at Athens* (*Amer. Journal of Archæology*, vol. I, p. 207), I do injustice to Mr. Jas. R. Wheeler, the author of the paper on the Theatre of Dionysos, in criticising his omission of the volume-number when citing from the *Corpus Inscriptionum Atticarum*. The "Explanation of Abbreviated References," on p. 153 of the "Papers," states that vol. III, part I, is to be understood wherever the number of the volume is not given.

A. EMERSON.

ARCHÆOLOGICAL NEWS.

SUMMARY OF RECENT DISCOVERIES AND INVESTIGATIONS.

Page.	Page.	Page.
AFGHANISTAN, 211	GREAT BRITAIN, 231	PALESTINE, 211
ASIA MINOR, 212	GREECE, 216	ROUMANIA, 230
AUSTRIA-HUNGARY, . 230	HINDUSTAN, . . . 207, 233	SIAM, 207
EGYPT, 203	ITALY, 217	TURKESTAN, 211
FRANCE, 227	MEXICO, 232	UNITED STATES, . . . 232
GERMANY, 229		

A F R I C A.

E G Y P T.

During this winter, the Egyptian Government has not undertaken any new work, and it has but scanty funds for archæological purposes. It is to the enterprising organizers of the Egypt Exploration Fund that we again owe the most interesting results of the season, of which full reports are given below. Naukratis has continued to yield works that are invaluable as the connecting links between Asiatic and Grecian art, and investigations have been started on a number of new sites, the most important being *Am-Nebesheh*.

AM-TELL NEBESHEH.—While the work at Naukratis was being carried on this winter under Mr. Gardner, Mr. Petrie has attempted excavations on an entirely new site, called variously Tell Bedawi, Tell Nebesheh, Tell Farun, the second of which is preferred by him. In several letters to the *Academy*, dated February 5, 13, 26 and March 25, Mr. Petrie, in conjunction with Mr. Griffith, recounts the progress of his excavations, of which we will give a succinct account.

Feb. 5. Fully half the site is occupied by a cemetery, the other half by two small towns and a temple. The cemetery has been formed by an immense number of small chambers, or groups of chambers, placed isolatedly and irregularly all over a sandy plain. These were built of unbaked brick, and roofed with barrel vaulting. Some few were larger, and cased, or lined if subterranean, with limestone; while in later times—in the sixth century B. C. and after—large groups of about a dozen chambers became frequent. So far, nothing has been found anterior to the xx dynasty. The temple goes farther back, as a black granite altar

of Amenemhat II of the XII dynasty has been found. An inscription on its side gives the title of "seal-bearer and high chancellor": probably these persons were the viziers of the Hyksos. There is great probability of finding here monuments of the Hyksos period.

Feb. 13. A sphinx of black granite found at the gateway of the enclosure of the temple is one of the most erased monuments known. It was originally made under the XII dynasty. Four inscriptions found here that mention the city of Am, capital of the XIX nome Am Pehu, seem to prove that it was on this site.

Feb. 26. The huge chamber mentioned last week (Feb. 19) contains at least two inscribed sarcophagi. A fragment of one of the XII dynasty sandstone statues identifies it with Amenemhat II, the dedicator of the table of offerings. He is the only early king known here, with certainty, and was probably the founder of the temple.

March 25. "The temple proves to have been built by Aahmes (Amasis), as beneath the corners I (Petrie) have taken from the sand the foundation deposits of small plaques bearing his name. . . Over each deposit of plaques was a large number of terracotta models of different forms of vases and dishes, apparently representing those used in the ceremonies. One side of the great shrine has been found; and, though carefully erased, the banner of Aahmes can just be seen in the inscription. . . At the pylon a large substructure has been cleared, built by Aahmes from fragments of older temples." Have been found; fragment of second sphinx; colossus of Ramesu II in black granite; outside the pylon, a curious monument composed of "a clustered lotus-column, inscribed with scenes of offering, and surmounted by a kneeling figure of Merenptah under the protection of a hawk, 13 ft. 3 in. high in all. This free-standing pillar . . . seems to resemble the Solomonic pillars at Jerusalem rather than anything yet known in Egyptian architecture. The temple of Aahmes was only the latest, and we have apparently recovered the site of the temple of the XII and XIX dynasties. It is larger, and in the middle of the *temenos*: but it seems to have been entirely cleared out by Aahmes for his new buildings, leaving only the brick wall around the foundation."—*Academy*.

TELL FERÂIN.—Mr. Petrie sought here for the site of the long-lost city, Buto. He speaks of the result in these terms: "Tell Ferâin was a great city, of the rank of Saïs, Bubastis and Tanis. Its ruins lie in two large divisions, 50 to 60 ft. high, with a broad space between them leading to a great temple-enclosure of massive brickwork, like the great walls of Saïs or Tanis. This enclosure is about 900 ft. long and 700 ft. wide. Within it is a rectangular cleared area, where the temple stood," etc.—*Academy*, March 13.

GIZEH.—The great Sphinx by the Pyramids of Gizeh, the uncovering of which was mentioned in the last number of the *JOURNAL* (p. 80), is an immense bed of cut rock, 70 metres long and higher than the highest house. Its use has never been discovered. It was one of Mariette's pet projects to uncover it: he expected to make extraordinary discoveries in a work which belongs to the early prehistoric times of Egypt. It is estimated that 20,000 frs. more are necessary to complete the work of uncovering, and M. Renan appeals to the public for this sum, through the *Journal des Débats* (March 25), which was so successful in organizing the Luxor subscription.

KABASA.—Mr. Petrie identifies this city with the present Senhur, which stands on part of a large Greco-Roman site and preserves many remains of that period. In this identification, as well as in that of Buto = Tell Ferâin, Mr. Petrie takes Ptolemy as his authority.—*Academy*, March 13.

LUXOR.—M. Maspero writes (March 2) to the *Journal des Débats*, "Le déblaiement de Louqsor avance lentement, mais il avance. Aujourd'hui même les négociations nécessaires pour l'expropriation des maisons subsistantes ont été terminées et la démolition commencera vers la fin de la semaine. Je commence même à croire que je réussirai à déplacer la mosquée avant la fin de l'année. Les négociations ont naturellement ralenti la marche des travaux, nous avons cependant abaissé le niveau de huit mètres dans la moitié de la première cour et sur le front nord du pylone. Au cours des excavations, j'ai eu la bonne fortune de déblayer une colonne de granit rose, admirable de travail et de conservation. Elle représente Ramses II, debout; c'est à mon sens, l'œuvre la plus belle que nous ayons de cette époque de l'histoire Égyptienne."—*Cour. de l'Art*, March 26.

NAUKRATIS.—The Council of the Hellenic Society has made a further grant of 100 l. towards the excavations at Naukratis now being conducted by Mr. Ernest Gardner.—*Athenæum*, Feb. 27.

In continuation of the news given in the last number of the *JOURNAL* (II, 81), the following progress in the excavations at Naukratis may be noted, from Mr. Gardner's letters. Under date of March 6 he says: "As the cemetery has been finished, the temple of Aphrodite now takes precedence, . . . and it still holds its place as the richest site of excavation. The two wells discovered to the N. of the temple . . . have been thoroughly cleared, . . . and a considerable amount of good early pottery has been found in them; three or four early painted jugs are all but perfect; and one splendid bowl, some 18 ins. in diam. inscribed and painted with a double frieze of beasts, birds, &c., has been recovered. . . The clearing of the building itself has been almost completed. The *temenos* of the Samian Hera is now definitely fixed. . . I have now several fragments

of pottery, . . . all dedicated to Hera. I have also come on the brick foundations of a large stone building, probably the temple itself."—*Academy*, March 27.

SYÊNÉ—ASSUÂN.—With the permission of Gen. Grenfell, the Egyptian soldiers at Assuân are being employed in disinterring a remarkable line of tombs in the sandstone cliffs which face the old town of Syêné, between the two old Coptic monasteries. "One of them is remarkable on account of both its size and its form. It is really a twin-tomb, with two entrances, the roof of one of the tombs being supported on rows of square columns cut out of the rock, the roof of the other on rows of round columns. Inside, however, there is no division between the two original sepulchres, and we walk through long avenues of columns, which call to mind the columns of the cathedral of Cordova or the mosque of Kairwân. . . . Here and there on the walls and columns are rude sculptures, picked out with red paint. The tomb belonged originally to a high official of the Old Empire, who lived, according to an inscription on the external face of the tomb, in the reign of Nofer-ka-ra. Unfortunately, however, there were several kings of this name in the first seven dynasties. Prof. Maspero believes that this particular one will prove to be the Nofer-ka-ra or Pepi II of the VI dynasty, whose pyramid he opened four years ago; but the rudeness of the sculptures as compared with those on monuments of the VI, or even of the III and IV dynasties which I have seen elsewhere, almost tempts me to think that he may turn out to be the Nofer-ka-ra of the II or III dynasty." To the N. of this tomb is one which is the finest and most beautiful of those found thus far; indeed in many respects it is unique. It may confidently be ascribed to the XII dynasty. "We first enter a large and lofty hall, flanked by two aisles which are separated from it by massive columns. A flight of steps next leads us into a long vaulted corridor, on either side of which are large niches containing figures of the dead in the form of mummies, standing upright, carved out of the rock and painted. On the stuccoed walls are other figures and hieroglyphs, exquisitely painted, the colours being as fresh as if they had been laid on but yesterday. The corridor opens into a second pillared hall, at the end of which is a shrine formed of large blocks of stone fitted into a recess in the rock, and painted with rare finish and brilliancy." All the tombs had been violated during the Roman epoch, and the old-empire tomb turned into a common cemetery. Gen. Grenfell has also opened some Coptic graves, cleared out the roof of a temple and excavated the great court at Philæ, etc.—Prof. Sayce in *Academy*, March 20.

Miss Amelia B. Edwards, in the *Academy* of May 1, announces that Gen. Grenfell is making rapid progress with his interesting discoveries.

The great sixth-dynasty tomb proves to be inviolate: the shaft, at the bottom of which was the rock-cut sepulchral chamber with two mummies, was reached through a solid mass of later mummies and mummy cases, some eight feet thick. The vault contained several inscribed steles, and some specimens of pottery.

Prof. Sayce gives a pleasant account of some of his own investigations in a letter dated Cairo, April 10, with a postscript from Venice, published in the *Academy* of May 1.

ASIA.

SIAM.

CHIENG-MAI.—Some ancient ruins of considerable interest have lately been discovered in Siam, in the neighborhood of Chieng-mai. As yet it has been found impossible to pronounce definitely on their date, but they are unquestionably older than the foundation of the Kingdom of Ayuthia in 1350. An interesting feature in the discovery is, that the material used in the construction of the buildings is laterite (*sic*), whereas the modern Siamese use only brick. Some ancient inscriptions have also been brought to light in the same district: they are written in a character that is no longer decipherable by native scholars generally, though a knowledge of it is still preserved among a chosen few.—*Athenæum*, May 1.

HINDUSTAN.

ARCHÆOLOGICAL SURVEYS OF INDIA.—We learn that Dr. J. Burgess, C. I. E., has been appointed, by the Viceroy, Director General of all the archæological surveys of India, and placed in charge of the conservation of ancient monuments, and of epigraphy. Mr. J. F. Fleet, late Epigraphist, returns to his revenue duties.

General Cunningham resigned the direction of the archæological survey last year, and this has led to a reorganization of the establishment on a different basis. Bengal, the North-West provinces, and the Punjab, together with Rajpootana, Central India and Chota Nagpore, have been formed into three districts, and a surveyor, with two or more assistants and staff, as in Bombay, appointed to each. Dr. Burgess will remain in charge of his present work in Bombay and Madras. "Under this arrangement, every part of the Indian Empire will have its archæological surveyor, who, with his assistants, will be able, before many years are over, to give us a very full and careful account of all the ancient monuments, and will enable the Government to publish much interesting and valuable informa-

tion on the subject."—Mr. James Gibbs, *Society of Arts*, meeting of April 2.

PENUKONDA.—Mr. A. Rea, of the archæological survey of Southern India, says, in a recent report:—"On arrival at Penukonda, on the 23rd December, 1885, I commenced a thorough survey of the many buildings found here. The fortifications encircle a group of rocky hills, and, though extensive, are much ruined. The principal buildings are in the fort. They are much in the same style as such structures at Vijayanagar. The Mahal Palace, now used as a Munsif's court, and a number of tombs, are designed in the Hindu-Saracenic style of the palace buildings at Vijayanagar. Two temples close by are covered with sculptured scenes from the Ramayana and Saivite puranas; these are after the style of those on the Hazara Rama temple at Vijayanagar. There are large numbers of various classes of buildings, tanks and wells—some of the latter cut to a great depth—scattered about the hills enclosed by the walls. The most important of these are being surveyed, and the numerous inscriptions copied. Regarding the extremely incomplete and ruined state of the ancient fort-walls, my impression is, that it is chiefly due to indiscriminate destruction carried on by people about the place. Even just now, coolies are engaged demolishing them at various places, and removing the stones, but by whose orders, or for what purpose, I do not know. There is no one to look after the many ruins, and they seem to be at the disposal of any person in want of ready-cut building material. For want of available funds to repair the boundary walls of the *Ramaswami* and *Esvara* temples, the fine sculptures there are being irretrievably injured by persons mischievously inclined. With the numerous deserted buildings the case is even worse; they seem to be at everybody's disposal. For a place of the historical importance of Penukonda, it is a matter of regret that its ancient features should thus be wantonly destroyed."

GOOTY.—*Ancient Hindu Fortifications.*—In a report by Mr. A. Rea, First Assistant, Archæological Survey of Southern India, he says:—"I examined the ancient remains at Gooty, but, with the exception of the extensive range of fortified buildings, there are no other remains of archæological importance in the place. The fort is of Vijayanagar date, said to have been constructed by Krishnadeva Raya. It is built on a cluster of large hills, and is an interesting example of Hindu fortification. It occupies a position of great natural strength, and must have been in parts—notably the fortifications on the high north-east peak—almost impregnable. The same system of re-entering gateways flanked by bastions, as we find at Vijayanagar, differing in each case by the slightly altered character of the two sites, seems to have been followed here. From what we see and learn of these and other military works, there is

no doubt but that the Hindu military engineers thoroughly understood the theory and practice of a system of fortification perfectly suited to their mode of warfare. When the best specimens of the numerous examples scattered throughout this part of the country have been systematically examined and studied, and the exact theory of their mode of defence reduced to a system, it should prove an interesting addition to our knowledge of the works of a former age."

THE AJUNTA CAVES.—In the year 1872, the Government of India sanctioned their first grant of Rs. 5,000 from Imperial revenues for the purpose of obtaining "copies of the celebrated frescoes at the Ajunta caves, on the understanding that Mr. Griffiths, the artist, will first report whether the work is feasible." These caves lie on the borders of the Nizam's Dominions, 55 miles from Arungabad. The oldest of them are assigned to about 200 B. C.; the most modern to the year 600 A. D.; thus they furnish a continuous narrative of Buddhist art during 800 years. They consist of twenty-four monasteries and five temples, all hewn out of the solid rock, supported by lofty pillars, richly ornamented with sculpture and covered with highly finished paintings. These latter give their real value to the caves. They have, as Mr. Griffiths says, "all the elements of a living, growing art; all the characteristics found in Italian art of the 13th and 14th century, and which, like it, might have attained the highest state of development if it had not been checked by the revival of Brahmanism and the rise of Jainism." The paintings are not frescoes in the true sense of the word. The rough surface of the wall appears to have been covered with a thin coating of cow-dung, mixed with powdered trap and rice-husks. A thin smooth plaster for the ground colour was next laid, upon which the designs were drawn and then painted. The light and shade are very good, and the paintings must have originally been in the most brilliant colours. Seen at the proper distance every touch falls into its right place. As in the Italian pictures of the fourteenth century, a truthful rather than a beautiful rendering of a story is the principal object. Hills, rivers, seas and houses are conventional, but most of the objects are faithfully treated. There are pictures of Buddha, his disciples and his devotees; of long processions and street scenes and battles; of hunting scenes with men on horseback; of elephant fights; domestic scenes of love and marriage and death; festivals, with men and women singing, dancing, and playing on musical instruments; groups of women performing religious austerities; and scenes from the market-place of buying and selling, preparing food and carrying water—in a word, these wonderful frescoes give us a perfect panorama of every phase of Indian life, from the reign of Asoka to shortly before the expulsion of the Buddhist faith from India. "The drawings," says Mr. Griffiths, "have

life in them, and for purposes of art education, no better examples can be placed before an Indian student. The human faces are full of expression—the limbs are drawn with grace and action, the flowers bloom, the birds soar, and the beasts spring or fight, or patiently carry burdens. The sameness of detail, and the way in which, in many cases, a story runs on from a painting, and is continued in the sculpture, seem to point out that the sculptures and the paintings are the work of the same artists." Who these artists were must forever remain a mystery. The pictures have been attributed to Egyptians and Italians, or, from the common occurrence of Greek fretwork as an ornament, to artists trained in the school of Bactrian Greeks. But the intimate knowledge of native life and the absence of foreign allusions make it probable that the men who painted the pictures were natives of India.

Mr. Griffiths first started for Ajunta in the company of four native students on the 7th December, 1872. They stayed till the 20th May following, and as they had to live in the caves they suffered from ill-health. Nevertheless, Mr. Griffiths proved that it would be possible to make copies of the faded and mutilated paintings. The question now arose as to whether it would not be advisable to remove the paintings from the walls of the caves, as had been successfully done with some of the frescoes in Italy. In May, 1874, Mr. Griffiths was deputed on duty to Europe to acquaint himself with the practice in vogue for the removal of frescoes. The Secretary of State, however, interfered and ordered that no proposal should be entertained of removing the paintings from their present position, and that all such examples of Indian art should, whenever practicable, be preserved *in situ*. In 1874-75, the work of copying the pictures was formally resumed, and as it would necessarily occupy some years a bungalow was built for the draftsmen, and the caves were provided with doors and shutters. Henceforth the work was carried on every cold season, with one interruption from famine and one for furlough. In 1881 it was resolved to keep four of the more experienced draftsmen permanently at the caves, Mr. Griffiths paying them a monthly visit of inspection during the year. Each batch of copies as they were completed were forwarded to the Secretary of State for India, after the paintings had been photographed. When the work was brought to a close the other day, the expenditure incurred from first to last was only Rs. 55,152. It may give some idea of the magnitude of the operations if we add that the amount of canvas used was 166,888 square yards. We have full lists of the work done in the appendices attached to Mr. Griffiths' reports. There are in all 165 copies of paintings; 160 copies of panels; and 374 water-colour drawings of the ornamental panels of the walls and ceilings, executed on a reduced scale with a view to their publication. The paint-

ings vary in size from 25 feet by 11 feet downwards, and owing to the large dimensions of the pictures some of the pieces of canvas had to be specially manufactured. The first part of the work having been happily and successfully accomplished, it remains to render these copies available to artists and art students throughout the world. The whole of the copies are to be finally located in London, and the work, as Mr. Griffiths suggests, of reproducing the pictures for book publication had better be prepared there.—*Times of India*. [*Indian items are communicated by Mr. Robert Sewell*,]

TURKESTAN.

TOKMAK.—*Christian cemeteries.*—The *Turkestan Messenger* publishes a letter stating that two ancient Christian sepulchres have just been discovered in the plain of Tchouia, in the district of Tokmak. One near Tokmak itself was discovered by Dr. Poiarkoff, and the other in the environs of Pishpeck was brought to light during the operations of the Topographical Survey. The latter extends over rather more than thirty square yards, and its surface is covered with a quantity of gravestones, bearing angular inscriptions, surmounted by a cross. Dr. Poiarkoff has requested permission to carry out some excavations in the cemetery, at his own expense.—*Athenæum*, Feb. 13.

AFGHANISTAN.

BAMIAN.—Capt. M. G. Talbot has recently visited the rock-cut caves of Bamian, in Northern Afghanistan, about whose sculptured figures so much has been written and conjectured. A letter from him was read at a recent meeting of the Asiatic Society (March 15), in which he describes five of these figures: a male idol, 173 ft. high; a female, 120 ft.; a smaller, much injured, figure, 50 or 60 ft.; a seated figure in a niche, and a standing figure. There were paintings on the roofs of the niches of the first two of these. Both are hewn out of the conglomerate rock, but the finishing touches and drapery were added by the application of stucco. Sir Henry Rawlinson made an interesting exposition of his own theories regarding these idols.—*Athenæum*, March 20.

PALESTINE.

PALESTINE EXPLORATION FUND.—"Mr. Laurence Oliphant has discovered the ruins of two synagogues on the north-east shores of the lake of Galilee. One of these, at a place called Kanef, is a complete ruin; the walls of the other are standing to the height of 9 ft. An account of these ruins, with drawings, will appear in the new number of the Palestine Fund's *Quarterly Statement*." The dimensions of the latter ruin are

60 by 37 ft. ; the height over the door is 6 ft. by 18 ins. ; the width of the door is 4 ft. 6 ins. It is oriented, and the entrance is in the eastern wall. The architecture is plain and simple ; no cornices or carvings were found, but the interior is so thickly strewn with masses of building stone, that some of the more ornamental features may have been concealed.

In view of this discovery, it is interesting to note M. Reinach's interesting comments on a Greek inscription from Phokaia (*Acad. des Insc.* March 19). This inscription shows that a Jewess named Tation had built the hall of the temple and the peristyle of the hypethra (ὑπαίθρα), and gave it to the Jewish community : in gratitude the synagogue honored her with a golden crown and the privilege of *proedria*. The distinction made by the text between the hall of the temple (οἶκος) and the peribolos of the hypethra is interesting for the architectural history of Jewish synagogues: the same characteristics are found in the Christian basilica of Tyre, built by Paulinus in 313. Both types, of synagogue and basilica, are derived from the Greco-Roman private house. This is the first information we possess of any synagogue outside of Judæa.—*Athenæum*, April 3 ; *Chronique des Arts*, April 3.

HEBRON.—The Mosque of Hebron, one of the oldest, has never been accurately described or even visited, as no European has been allowed to pass the external limits. The Ottoman Government has just caused an exact plan of it to be made, which will be of great assistance in making known this wonderful building, said by legend to have been founded by David and to contain the tombs of Abraham, Isaac and Jacob.—*Cour. de l'Art*, March 19.

JERUSALEM.—The famous monument called the *Tomb of the Kings* has become the property of France through the donation of the heirs of M. Isaac Pereire, who, together with his brother Emile, purchased it in 1878.—*Gazette Arch.* 1886, p. 51.

ASIA MINOR.

There seems to be a general impulse, of late years, to a thorough exploration of the important provinces of Asia Minor, and many countries are vying with each other in expeditions sent out for the purpose :—Germany, with her work at Pergamon under Humann and Conze ; Austria, with her Lanckoronski expeditions to Lykia and Pamphylia ; England, with Mr. Ramsay whose work has been so important for the geography of the least-known parts of the country ; and America, with Dr. Sterrett, whose collection of inedited inscriptions will be, when published, the third great event in Anatolian epigraphy. The entire field is thus being thoroughly gone over, in its monuments, epigraphy and geography. From this energetic and continuous work the most important

results may be expected, and Asia Minor, until now the least-known, will become one of the most familiar of Eastern lands. The questions of the Hittites, of the relation of the Greeks of Asia Minor to the Oriental Empires, to the native races, and to Greece, will all receive new light.

Hittite Monuments.—Mr. Haynes, who accompanied the American expeditions of Dr. Sterrett and Dr. Ward, has lately received an appointment at Ain-tab in the midst of the Hittite region. He has received funds from the New York branch of the Archæological Institute for the exploration of this region, and has already made the discovery, not only of a number of important Hittite sculptured monuments, but of several important sites, with ruins dating back to the Assyrian and pre-Assyrian periods. A statement of his first discoveries is given in the *Seventh Annual Report* of the Archæological Institute of America (May, 1886), from which we take the following extract:—

Mr. Haynes will undertake this summer an expedition "to examine, photograph, and report upon, not only the numerous Hittite remains, not yet published, which are to be found in that neighborhood, but also the early Christian churches said to exist upon the track of St. Paul's journeys in Lycaonia and Pisidia. The following extract from a letter of Mr. Haynes, dated Aintab, 22 March, 1886, shows how large an opportunity for discovery is within his reach.

'I made a short excursion of about fifty miles to the westward a few days ago, and photographed a group of eleven fine Hittite figures, seven of which are human and four animal. There are other defaced and broken sculptures scattered about, some of which are gathered into a Moslem graveyard close by. The ancient city once occupying this site was partly built upon an artificial mound, about a half mile in circuit and some thirty feet or more in height. The line of wall surrounding the lower city can be distinctly traced.

'Our spring vacation of two weeks begins in nine days, and I shall occupy it in searching the upper part of the plain in which I photographed the above-mentioned sculptures. From a distance I have seen many artificial mounds. No one has ever examined them. It is a famous centre for Hittite inscriptions and sculptures. The plain is about one hundred miles in length from Antioch to Marash. It is the upper part, for about forty-five miles, that I propose to examine now, and I will write you if anything is found.'

DR. STERRETT made his third trip through Asia Minor, after the close of Dr. Ward's expedition to Babylonia, and largely increased his epigraphic stores. He is at present in Europe, preparing his collection of inscriptions for the press. They number nearly one thousand, and will be published with cursive transcription, translation, and comment in two large volumes of the series of the School of Classical Studies at Athens. Their preparation involves much research, and the first volume may not be ready during the present year.

MR. RAMSAY continues to make known the results of his journey by articles in the *Journal of Hellenic Studies*, the *Archäologische Zeitung*, the *American Journal of Archæology*, and other publications.

AIGAI (NIMRÛD-KALESSI).—M. Reinach says, in the *Revue Arch.* 1886, p. 161, "In Jan. 1881, I explored for the first time, with MM. Ramsay and D. Baltazzi, the magnificent Greek ruins of Nimrûd-Kalessi, about four hours from Myrina. In accord with my fellow-travellers, I expressed the opinion that these ruins were those of the ancient Aegae (wrongly placed by all geographers at Guzel-Hissar, nearer the coast), and that they belonged in great part to the period of the Attali." On application, a firman was accorded by the Turkish Government, and M. Clerc passed several months at Nimrûd-Kalessi in 1882. "He opened a number of tombs, and found some objects, a part of which are now in the Louvre; a detailed memoir on these excavations will appear in the *Bulletin* of 1886." Unfortunately, none of the architects attached to the Villa Medici came to draw up the plans of these immense ruins, and now this task has been undertaken by the German archæologists, MM. Bohn and Fabricius, who will also take photographs. According to them, the walls of the akropolis are of the Hellenic period; and the great building (the use of which is unknown) belongs to the period of the kings of Pergamon: they consider that the akropolis of Pergamon cannot be understood without an acquaintance with that of Nimrûd-Kalessi, and vice-versa. The necropolis is far from having been exhausted by M. Clerc: the tombs are not, as at Myrina, excavated in the tufa: they are built of blocks of trachyte, and covered with a single stone. M. Baltazzi, who accompanied the German archæologists and who was intimately acquainted with the locality from previous visits, commenced, with Hamdi-Bey, excavations in the necropolis, and had already opened forty tombs before the beginning of the winter; finding in them elegant pottery, terracotta heads and fragments (similar to those of Myrina but of different material and color) mirrors, bracelets, etc. All the coins found have the effigy of Aigai. The inscription of the temple of Apollon Chresteros has been published by Fabricius in the *Mittheilungen* (x, p. 272). The remains of a large theatre, with vaults of the Roman period, have been recognized.

Necropolis of Jénidjé-Keui.—At a distance of two hours and a half from Nimrûd-Kalessi, M. Baltazzi has discovered a new necropolis, near the village of Jénidjé-Keui. "Several of the objects found are archaic and show great analogy to those of Assos; a terracotta reminds of the Phœnician bronzes found in Sardinia."—*Revue Arch.* 1886, I, pp. 161-3.

ELAIA.—The excavations commenced here by the Austrians are succeeding well. At the first stroke of the pick, they discovered the Christian necropolis, and, a few days after, the Roman necropolis.—*Revue Arch.* 1886, I, p. 163.

PERGAMON.—The great work on *The Antiquities of Pergamon*, of which one volume appeared in 1885, is to consist of eight folio volumes with the

following contents: I. Report on the excavations, by Humann; and study on the topography of Pergamon, by Conze. II. The Sanctuary of Athena Polias. III. The Agora, the altar of Zeus, and the temple of Dionysos. IV. The sculptures of the altar. V. The Augusteum and the surrounding porticos. VI. Other buildings, especially of the Roman period. VII. Other sculptures. VIII. Inscriptions. The entire work will cost about \$550, a price against which M. Reinach justly protests, as it places a publication that ought to be in the hands of every lover of ancient art, beyond the reach of any but the best-endowed public libraries.

The following are the main conclusions of a report on the recent work at Pergamon, presented by Bohn to the Berlin Academy. The *agora*, situated on the akropolis, is anterior to the greatest development of the kingly power. Enlarged and beautified at the most brilliant period of the city's history, it was preserved almost intact up to the beginning of the Middle Ages, when the Byzantine walls on the S. and E. were built. The plan of the *agora* has been ascertained: its definite form was probably given to it by Eumenes II, who also may have raised the great altar. Among other ruins there has been found a small temple (7.60 by 12.30 met.), a Doric peristyle, on a stereobate of two steps: the columns, 5.15 met. in height, have 20 channellings. The central *akroterion* was probably a female statue. The substructure is of tufa, the rest of bluish marble. As the theatre near this temple is dedicated to Dionysos Kathegemon, it is conjectured that the temple itself was dedicated to the same divinity.

The excavations have been brought nearly to a close: the German Government accorded only with reluctance a subvention of about 50,000 mks., and this is to be the last. The new firman was to extend only to August of this year. Messrs. Humann and Conze arrived at Pergamon in September, and the work was to consist partly in completing the excavation of the new temple, and in uncovering all the section between the temple of Athena and the Hellenistic outer wall.

DISCOVERY OF AN ANCIENT CITY.—At a meeting of the *Archäologische Gesellschaft* of Berlin, on March 2, Dr. Fabricius announced the discovery by him of the ruins of an ancient city to the N. W. of Pergamon, near the village of Aschaga Beiköi; and which he afterwards explored in conjunction with Messrs. Conze and Bohn. It is built on a hill: its walls and towers, well preserved, in some cases to the height of thirty courses, belong to the same style as those of Pergamon erected before Eumenes II. The city has a circumference of 1500 met., and a maximum diameter of 550. In the interior are ruins of many houses, of small sanctuaries, and of a theatre of remarkable plan. Outside the walls, on terraces, are cemeteries with colossal stone sarcophagi. To the S. are the ruins of a

small, four-triglyph Doric temple with peribolos. To the Roman period belong one of the wall-towers and a large aqueduct. The city was still inhabited in Byzantine times, as is shown by the remains of a church within the walls, which is the only building in which marble is used, all the others being built of the local granite. No inscription has yet been found to show the name of this city, and no definite assistance has been gained from literature.—*Berl. phil. Woch.* April 17.

EUROPE.

GREECE.

There has been a lull in archæological investigation in Greece, and no discoveries of any interest have been made since the archaic statues were found in February on the Akropolis of Athens.

ATHENS.—*Akropolis.*—It is said that the recent discoveries on the Akropolis are to be catalogued and published by a commission consisting of MM. Tsountas (inscriptions), Kabbadias and Koumanoudes (figured monuments). Whether this includes the last discoveries of archaic statues, inscriptions, etc., is not known. Since the last number of the JOURNAL was issued further detailed accounts of these discoveries have been published in the *Temps*, March 22, and *Athenæum*, Feb. 27.

English School.—The construction of the building for the English School, after the designs of Mr. Penrose, the eminent English architect, has been brought to a close, and the building will soon be ready for occupancy.

American School.—The Archæological Institute, having accepted the site offered by the Greek Government for the erection of the building for the American School, initiated a public subscription to secure the necessary building-fund. The \$25,000 required for the purpose were collected mainly in Boston, and the detailed plans are now almost ready. They have been prepared with great care by Professor Ware, of Columbia College, after consultation with Professors Goodwin and Allen. Every care has been taken to make the building a model of convenience and healthiness. It is to be considerably larger than the English School, and the arrangements also differ; every advantage being taken of the sunny side of the building. Mr. Trowbridge, son of the Harvard professor, who has had considerable practical experience, will superintend the work and see that the plans are faithfully executed.

BOIOTIA (PERDIKOVRYSI).—*Temple of Apollon Ptoos.*—Each number of the *Bulletin de Correspondance Hellénique* contains an additional paper on the archaic statues discovered by M. Holleaux among the ruins of the

temple of Apollon Ptoos. In the March number two interesting bronze statuettes of the VI century are illustrated. The first bears a striking analogy to the Apollon of Naxos (*Arch. Ztg.* 1879, p. 84), and is related to the type of the Apollon sculptured by Kanachos for the temple of Branchidai: the inscription reads: *Ἐὐ[γ or F]εῖτίας ἀνέθεξε το(ῖ) Ἰποῖου(ι)*. The second statuette, perhaps earlier in date, is of extremely rude workmanship, and bears the inscription: *Κίδος ἀνέθεξε το Ἰόλλουι τοῖ Ἰποῖῆι*. In the April number M. Holleaux illustrates a torso, in marble of Paros, which probably dates from the V century, and belongs to the second series of "Apollon" figures: he points out its resemblances to the Apollon of Piombino (Louvre) and the Strangford Apollon (Brit. Mus.), and its connection with the type of Kanachos.

KORINTH.—Dr. Dörpfeld has undertaken for the German Institute some excavations in the old Doric temple. The results were small, and consisted solely in small fragments of walls and stumps of columns: still it was possible to ascertain the ground-plan of the structure, the direction of the walls, one of the entrances, and the site of a statue. It seems probable that the temple was double, and sacred to two divinities.—*Berl. phil. Woch.* April 24.

KRETE.—**GORTYNA.**—A colossal draped female statue of Pentelic marble has been found, with the head and one arm missing. It is of somewhat late date, and its interest consists in being signed by a sculptor otherwise unknown: *Εἰσιδοτος Ἀθηναῖος ἐποίησεν*, "Eisidotos, the Athenian, made it."—*Δελτίον τῆς Ἐστίας*, No. 479.

MANTINEIA.—A colossal statue of a diskobolos has been found here and sent to the museum at Athens.—*Berl. phil. Woch.* April 24.

ITALY.

PREHISTORIC AND CLASSICAL ANTIQUITIES.

ANZIO.—On the border line between Anzio and Nettuno remains of an elegant Roman edifice have been found, with beautiful marble pavements, fragments of painted stucco, a charming statue of Mercury, etc.—*Not. d. Scavi*, 1886, p. 58.

BOLOGNA.—*Necropolis.*—In the *Notizie degli Scavi* for March, p. 67, Count Gozzadini gives an account of the excavations undertaken by him for the Government, during the winter, in that most interesting part of the Bolognese necropolis, the *podere Arnoaldi Veli* (see *JOURNAL*, I, 234). As usual, an upper stratum of Roman tombs was found, below which, at a depth of between 4 and 6 metres, were the Etruscan tombs: this great depth had not, however, protected any of them from violation and spoliation. For this reason, the objects found in the tombs were not remarkable, with the exception of a few fine painted vases. The discovery in one tomb

of a hoe or pick evidently dropped there by the violators of the tomb is considered by Sig. Gozzadini as important for determining whether it was the Romans or the Gauls who despoiled the necropolis: the form of the instrument being, as far as could be ascertained, entirely unknown to the Romans, it remains to be proved that it was used by the Gauls, who would then be, as Count Gozzadini is inclined to believe, the violators of the necropolis.

CAGLIARI (Sardinia).—*Roman Necropolis.*—On the Viale Principe Umberto, part of a Roman necropolis was discovered, in which a number of inscriptions have been found.—*Not. d. Scavi*, 1886, p. 104.

CANOSA, RUVO and GIOIA DEL COLLE.—*Antiquities.*—In this territory numerous finds of interesting works have been made. Of late, a number were purchased by the Museum of Bari, vases, statuettes, etc., while others remain at Ruvo. In *Ruvo* itself a remarkable series of vases was discovered, in December, in a tomb under the church of S. Sabino: they belong to the best period of the local art, and may be dated from the middle of the III century B. C. One of them has a remarkably interesting representation of Orestes pursued by the Erinyes and protected by Apollon. Among various other collections of vases, is one owned by Cav. Jatta, one of which is of quite a new form (like a footless *holmos*), and decorated with beautiful paintings from common life, in which varied expressions are given in the faces, in an almost unique manner. From some tombs at *Gioia del Colle* comes a collection of vases with careless designs belonging to the decadence of the local manufacture and probably imported from Ruvo.—*Not. d. Scavi*, 1886, pp. 87–100.

CAERE—CERVETERI.—*Ex-votos.*—Several thousand terracotta *ex-votos* were found here at a depth of about 1.15 met.: they are remarkable both for their good preservation and for the beauty of their execution. They represent various parts of the human body, animals (doves, oxen, cows, bullocks), and divinities. There are many examples of Fortuna and of Juno Lucina: especially noteworthy are some archaic statuettes of Minerva *Egidarmata* with helm and shield; some figures playing on musical instruments; two beautiful figures, a satyr playing on the double tibia, and a seated Priapus; a veiled and seated female figure, and another kneeling. Of interest are two life-size archaic heads, some life-size Roman portrait-heads, and a number of beautifully-modelled female heads with the *stephane*, necklace and earrings evidently of Etruscan workmanship (cf. imitation of Etruscan jewelery). A votive terracotta bas-relief representing a sacrificial scene is unique. The vessels found were also votive reproductions in miniature of the large works. These objects were probably consecrated to some healing divinity whose temple existed on this site.—*Not. d. Scavi*, 1886, p. 38.

CHIUSI (near).—*Mosaic pavement*.—At Monte-Venere, near Chiusi, has been found a mosaic pavement, 6 by 4 metres. The central section represents a double hunt: above, three deer are pursued by a single hunter armed with a lance; below, two men, one armed with a two-edged ax, the other with a lance, attack a wild boar.—*Not. d. Scavi*, 1886, p. 79.

FANO (Island of) (Umbria).—In the same spot where the discovery was made, in 1884, of a beautiful archaic bronze statuette of the god Vertumnus, has been found another bronze statuette, in perfect preservation, representing Hercules, which seems to belong to the same class as the former.—*Not. d. Scavi*, 1886, p. 8.

FORLI.—*Prehistoric Station at Villanova*.—A new prehistoric station has been discovered at Villanova, 2 kil. from Forli. Eleven circular or oval holes (*bucca di capanna*), with many objects which are of interest for the prehistoric period of the province, were examined. A careful study of these objects led the discoverer to assign them to the first iron age.—*Not. d. Scavi*, 1886, p. 31.

OSTIA.—The excavations undertaken in December and January led to the uncovering of a broad street flanked to the E. by a public brick building of uncertain use, and to the W. by another of *opera quadrata*, similar to the *Horrea* or warehouses: the group is grandiose and symmetrical. Several interesting fragments of sculpture came to light.—*Not. d. Scavi*, 1886, p. 25.

ROME.—*Latin or Etruscan origin of Rome*.—Mr. J. H. Middleton, in his *Ancient Rome in 1885*, made the extraordinary statement, that an Etruscan necropolis had been found in Rome; proving the existence of a previous Etruscan settlement on the site, and thus contradicting all received notions as to the Latin origin of Rome. This is merely a symptom of the growing Etruscophilia that possesses so many archæologists. Prof. Lanciani, than whom no one has more authority on the subject, remarks (*Athenæum*, March 13), "As I have had the official charge of scientific investigation in the area of the new quarters, in which the alleged discovery would have taken place, and as I have brought to light, as it were with my own hands, the fourteen thousand objects belonging to the earliest Esquiline necropolis, upon the nature of which this new theory of a pre-Roman Etruscan city is based, I may be allowed, I hope, to express my opinion on the subject *en pleine connaissance de cause*. To begin at once from the conclusion, I say that nothing has been found within the last sixteen years, either in the new or the old quarters of Rome, which can give any foundation to the above statement." The simple fact is, that the Latin tombs contained a large proportion of imported Etruscan pottery. Various accounts of the finds in this inter-

esting archaic necropolis have been given in the JOURNAL, vol. I, pp. 292, 445, 468.

THE ARCHÆOLOGICAL COMMISSION.—Shortly after the Italians entered Rome, the Government instituted an Archæological Commission formed of the most competent authorities, without distinction of political opinion, who have general charge of all archæological work in the city. This Commission has shown itself most efficient in insuring the protection and discovery of ancient monuments. *Bullettino della Commissione Archeologica Comunale*.—In this organ of the Commission are edited the most important works found: this important publication has just entered, with the year 1886, on a new series, under a different system, in which the many discoveries, whose importance is on the increase with every year, shall be promptly and fully described and those of greater interest fully illustrated. No better proof of the activity of the Commission can be given than the *Acts* published in the last number for 1885, which show the work of that year, and from which we take the following interesting facts (see also under *New quarter in the Ghetto* p. 221). *Museo Urbano*.—The cession of the Botanical Gardens has been obtained for the erection of a museum, or rather a gigantic store-house in which the results of excavations shall be classified and exhibited. This was accorded by a vote of the Communal Council on May 2, 1885. By decree of the Giunta on May 30, the direction of the building of this museum was confided to Comm. R. Lanciani, and it was expected that the building would be finished during the coming summer. *Photographs of monuments*.—The Commission is forming a large collection of photographs of the monuments that are disappearing through the execution of the *piano regolatore*, whatever may be their importance. *Archæological Registers*.—The following registers are accurately kept: (a) daily report of the inspectors; (b) daily journal of objects discovered, with note of their provenance; (c) general repertory of objects collected; (d) annual catalogue of objects arranged in order and ready to be placed in museums; (e) register of objects delivered to be restored, with the description of their original condition and of the restoration. *City Walls*.—The many fragments of the agger of Servius Tullius, as well as of the wall of Aurelian, that have come to light recently, have received much attention from the Commission: many of these being connected with private dwellings, it was not always easy or possible to obtain their preservation. *Destruction of mediæval monuments*.—It is unfortunate that the influence of archæologists has not been sufficient to prevent the destruction of many monuments worthy of preservation: one reason is, perhaps, that even they do not attach much importance to the relics of mediæval Rome, and make hardly more than a platonic protest in such cases.

New quarter in the Ghetto.—In consequence of the important discoveries which it is expected will be made through the building of the new quarter in the area of the Ghetto, the Archæological Commission has requested the authorities to make the lines of the *piano regolatore* agree with those of the principal monuments already known, especially the porticos of Octavia and Philip, the crypt of Balbus, and the theatre of Marcellus. It has also asked that the monuments which exist above ground but are now almost completely hidden by modern houses, especially the temple of Jupiter in the portico of Octavia, should be uncovered. The Giunta has acceded to these requests and voted 5,000 frs. for the archæological exploration of the Ghetto.—The Commission has commenced a collection of photographic views of the Ghetto, representing not only each street, but all of the most remarkable buildings in every detail.

Preservation of the Walls.—The Communal Council has approved two orders of the day presented by Comm. de Rossi. The first required that the walls of Rome near the Porta Salara, which belong to the time of Belisarius, should be preserved: this will cost the city 275,000 frs. The second, of a more comprehensive character, invited the Giunta to place itself in accord with the Government for the preservation of all the walls of the city.—*Italie of Rome*, Feb. 26.

The preservation of Monuments.—A number of attacks have been made on the vandalism from which old Rome is suffering through the rebuilding of the city. To one of these, published in the London *Morning Post* (No. 35,489), the syndic of Rome, duke Torlonia, wrote a reply refuting the charge, and asserting that nowhere were monuments so respected and preserved as in Rome, and enumerating many instances of the fact. It is undoubtedly true that every effort is made to preserve classical monuments of note, but the fact remains that many important buildings have been torn down, a few of which have been noticed in the *JOURNAL* (I, p. 450; II, p. 94).

Among the monuments whose preservation has been lately assured are (1) the Palazzo De Regis; (2) the Aurelian walls; (3) the *fornice di Claudio* in the Via del Nazareno; (4) the Tiberine Emporium. The Giunta has purchased three of the fine sarcophagi found on the Via Salaria. The discoveries made in Rome during the first four months of the year are elaborately chronicled in the monthly numbers of the *Bullettino della Commissione*.

Publication of Latin Inscriptions.—The *Bulletin Epigraphique* announces that Professor Henzen is preparing a collection of typical Roman inscriptions which will be up to the latest lights in this department of knowledge, and which is intended to supersede both Wilmanns and Orelli.—*Athenæum*, Feb. 13.

Barracks of the Equites Singulares.—On p. 90 we gave a number of inscriptions found here, set up by members of this choice body of Roman soldiery during the II and III centuries. Further excavations have brought to light many more, forming now a total of at least 50.—*Nuova Antologia*, March 16; *Not. d. Scavi*, 1886, pp. 12–22; *Athenæum*.

PROFESSOR LANCIANI has written to the *Athenæum* (March 13) a very interesting letter on the barracks of the *Equites Singulares*. He considers those recently found near the Lateran to be the ancient ones, as they are built in the reticulated style of masonry; a style which went out of fashion and was altogether put aside by Roman architects long before the reign of Septimius Severus, who built the new ones. Prof. Lanciani says, "I cannot speak of these finds without a certain degree of enthusiasm, because I have never seen forty-three marble pedestals or marble slabs inscribed with nearly one hundred pages of minute records discovered in one and the same hall, and in less than a week's time. The portion of the barracks brought to light in the Via Tasso runs parallel with an antique street 13 ft. wide, and contains a hall more than 90 ft. long, and small apartments on each side of it, the whole built in the reticulated work of Hadrian's time. The inscriptions must be divided into two classes: those raised at the expense of an individual; and those raised by subscription among a certain number of men, which number varies from a minimum of six to a maximum of forty. The cause of all this display of devotion and tenderness towards the gods, or towards the emperors, is but one—the joy of these veterans to be *missi honesta missione*, viz., to obtain an honorable *congé* after twenty-five years of faithful service. . . Of the statues which stood on the pedestals above described two only have been brought to light, besides many fragments of others. The first, headless and of rather common workmanship, is considered by some to have represented the genius of the barracks; the second is a noble work of art—indeed, one of the most perfect marble statues discovered in Rome within my recollection. It represents a young Bacchus, whose curly, silky, womanly hair, tied on the forehead with a *vitta* and crowned with ivy, falls in graceful ringlets on the shoulders. A light *chlamys* descends from the left forearm around the lower half of the body." Its exquisite finish and perfect preservation make it one of the finest statues of Bacchus in existence.

Forum.—Excavations are to be undertaken, near the temple of Castor and Pollux and on the side of the Palatine, to uncover the north side of the house of the Vestals: this will settle the question as to the side on which the main entrance was situated. Some consider it to have been on the *Via Sacra*, others on the *Vicus Vestæ*, which separated it from the temple of Castor and Pollux.—*Italie*, March 20.

Archaistic Statue.—On Jan. 28, in the gardens of Sallust, was found a life-size winged female figure, of archaistic character and architectural style: both hands raise the edge of the peplos (cf. archaic statues of kanephoroi). The figure stands equally on both feet.

Group of the Three Graces.—On Via Torre dei Conti has come to light a marble group of the Three Graces; $\frac{2}{3}$ natural size. The position is the usual one: two facing the spectator, the third turning her back. For beauty of design, excellence of execution, and perfect preservation this is one of the best pieces of sculpture discovered in Rome of late years.—*Bull. d. Comm. Arch.* 1886, p. 112.

Mithraeum.—In another newly-explored part of the mansion of the Nummii Albini, near the new Ministry of War, came to light in December an interesting sanctuary of Mithras, which is but another proof of the extensive worship of this Persian divinity in Rome. The chief interest is in a wall-painting of Mithras slaying the bull, probably the first example of the scene in colors that has come to light; the two principal figures are accompanied by the dog, the scorpion, the two lamp-bearers. The figure of Mithras has a purple cap, tunic, kandys and leggings, and the head is surrounded with a kind of nimbus or aureole.—*Bull. d. Comm. Arch.* April, 1886.

Mosaic of Rape of Persephone.—In a tomb near the 3rd milestone of the Via Portuensis, was found a mosaic pavement (11 ft. by 7) representing, in colors, the rape of Persephone by Haides. The picture, evidently copied from some famous original, is quite exquisite in color, in outline, and in workmanship, and its preservation, in most parts, is unique. In the central compartment, Haides is represented in his chariot holding the inanimate body of Persephone with his left arm, while with his right he drives his team of four magnificent black horses, whose names are written near their heads (ΖΟΦΙΟΞ, ΕΡΕΒΕΥΞ, ΧΘΟΝΙΟΞ, and ΛΥΓΑΙΟΞ). Athena is represented running forward with lance reversed: the quadriga is preceded by Hermes ψυχροπόρος, and followed by Persephone's companion nymphs, whose attitudes of surprise and horror are quite impressive. In the border, the corners are occupied by medallions enclosing life-size heads of the four seasons, and the space between them by pictures of green ducks, peacocks, and other domestic birds.—*Not. d. Scavi*, 1885, p. 477; *Bull. d. Comm. Arch.* 1886, pp. 49, 106–8; *Athenæum*, April 17.

Archaic Necropolis.—In the construction of a drain on *Via dello Statuto*, some very ancient tombs, belonging to the group illustrated by Cav. M. S. de Rossi (*Bull.* 1885, p. 39), have come to light. They are of various forms and contents, and some of them have been transported bodily to be exhibited in the new museum.—*Bull. d. Comm. Arch.* 1886, p. 112.

Tombs on Via Nomentana.—In the Villa Patrizi workmen have begun to uncover a building which is probably sepulchral, built with large blocks of reddish tufa. By it were found several inscriptions. The first is on a stele of travertine with semi-circular top, and reads: M·VALERI·M·F|APOLONI|INFR·P·XII|INAGR·P·XIIIX. The second is on a marble slab and gives the name of the builder of the Mausoleum: CN·DOMITIVS·HELIVS|SE VIVO·FECIT·SIBI·DOMI|TIAE·HELPIDI·ET·DOMITIAE|CALPVRNIAE FELICITATI·|FIL·ET·CALPVRNIAE·NICE|CONIVGI·ET·LIBERTIS·LI|BERTAVSQUE·POST MEIS. 16 other funerary inscriptions from the same locality are given in the *Bullettino*.—*Bull. d. Comm. Arch.* April, 1886; *Not. d. Scavi*, 1886, p. 80.

Villa Patrizi.—In building a convent for the French Sisters, just outside Porta Pia, workmen have commenced to uncover a sepulchral group of great importance, enclosed by a common wall 18 met. long and having a single door (1.40 met. wide) adorned with brick pilasters. The sepulchral chambers, which contain inscriptions in place, have not yet been visited.—*Not. d. Scavi*, 1886, p. 53.

Palace of the Annii.—In the Villa Casali on the Cœlian, the palace of the Annii has been rediscovered. The vestibule is ornamented with a double colonnade, and paved in white and black mosaic, the design of which represents colossal figures, tritons and nereids swimming: the mosaic is one of the largest found, measuring 30 by 33 feet. One of the bath-rooms contains a remarkable mosaic floor representing two athletes who have just been fighting in the presence of their two trainers. Many pieces of sculpture were recovered in demolishing a wall, including a number of busts, probably of the family of the Annii, and an interesting unique relief of the flaying of Marsyas.—*Bull. d. Comm. Arch.* 1886, p. 108; *Not. d. Scavi*, 1886, p. 11; *Athenæum*, April 17.

The Palatine.—The excavations at the foot of the N. E. corner of the Palatine, between S. Maria Liberatrice and San Teodoro, for the construction of the new entrance to the Palatine and the Forum, have thrown light on the topography of the *zona Velabrense* between the Clivo della Vittoria and the Vico Tusco (cf. *Bullettino* on p. 236 of JOURNAL). The architectural constructions brought to light, though not important in themselves, are of interest as belonging to all three periods of Roman history, royal, republican, and imperial.—*Not. d. Scavi*, 1886, p. 51.

First-century Imperial Buildings.—In making a drain on the axis of the castle of Saint Angelo, at about 50 met. from the N. bastion, was found a group of buildings of the first century built in "cortina neroniana" of great perfection. Nine rooms have, up to the present, been explored, all situated around a piscina which is full of human bones to the height of 1.80 m. The building, perhaps connected with the gardens of

Nero, was sumptuously decorated: marble staircases; pavements of polichrome mosaic; walls with Pompeian frescos.—*Not. d. Scavi*, 1886, pp. 22–3.

Via Portuense.—The pavement of the Via Portuense at the foot of the hill of Monteverde has been uncovered: it is flanked with *columbaria* of the first century, which, when explored, will probably yield a rich harvest of works of art. The details of the construction of one of these are remarkable for beauty and precision.—*Not. d. Scavi*, 1886, p. 81.

Travertine Quarries.—These quarries exist near the *Aque Albule* on the Via Tiburtina. From them the Romans extracted *five millions and a half cubic ft.* of travertine: from them came the materials for the Colosseum, theatre of Marcellus, Septa, bridges, etc. The road leading to them was important, as is shown by the numerous notable tombs and mausoleums by which it is bordered. The quarries have just been re-opened.—*Not. d. Scavi*, 1886, p. 24.

IMPORTANT OBJECTS FOUND IN ROME DURING THE YEAR 1885.

On p. 240 of vol. I of the JOURNAL we gave a selected list of important objects found in Rome during 1884, taken from the *Bullettino della Commissione Archeologica Comunale*. We now do the same for the year 1885, making use of the catalogue given in the closing issue of the *Bullettino* for 1885. It is but right to add that, for some unknown reason, many of the most important objects, like the bronze statues of athletes and of Bacchus (JOURNAL I, pp. 237, 443) are omitted from this list.

Paintings.—13 fragments of wall-paintings of little value. A mosaic pavement, found outside of Porta Portese, and attributed to the time of the first Antonines. In the centre the rape of Persephone; in the corners the four seasons (see a description of this mosaic on p. 223).

Sculpture.—Statues of Jupiter; Jupiter Serapis; 3 of Juno, two of which are remarkably fine; Minerva; Diana triformis; 2 of Venus; Isis-Fortuna; 3 of Hercules; Muse; Genius of Sleep; Paris; etc. The Hercules from S. Andrea della Valle and the Paris are fine pieces of sculpture. Fourteen busts and heads, several being family portraits; six torsos; six alto-reliefs, of which one contains the head of a colossal female figure, probably Juno, in a broad and grandiose style, found near S. Andrea della Valle; two sarcophagi; etc.

Metal Objects.—Small articles of gold, silver, bronze, lead and iron; coins; works in bone.

Terracottas.—Part of a frieze of elegant Greek style representing a short and monstrous figure (Bes?) between two sphinxes, one male and the other female; another portion of a similar frieze with sphinx, masks, etc; some lamps, several of which are of remarkable beauty and rarity.

Archaic Tombs.—49 of the archaic tombs found in the Via dello Statuto on the Esquiline have been reconstructed, with their original contents, which are of unique interest: a complete catalogue of these objects is given in the *Bullettino* by PROF. ALBERTO PARISOTTI.

SAN GINESIO (Picenum).—*Greek Bronzes.*—In the February number of the *Notizie degli Scavi* (1886, pp. 39–48) Count Silveri-Gentiloni has given a minute description of some extremely interesting and artistic bronzes very similar to those of Capua and Kume which Helbig (*Ann. Inst.* 1880, p. 223) considers to be, not Etruscan works, but products of Greek metal-work imported by commerce from Chalkis either through Kume and Neapolis or Tarentum. These finds prove the existence of an Italic settlement in the Picenum. The two most important pieces were much injured by the ignorant workmen who found them and secretly sold them in Rome. The greater part of each vase was purchased by the Museum of Karlsruhe. The oinochoe has a band of finely-drawn fantastic animals, partly in relief and partly in *graffito*, of which the illustration gives no adequate idea: the figure that forms the handle is archaic; its feet rest on a palmette flanked by crouching rams, while its head rests between the tails of two seated lions. This piece surpasses anything of the kind yet found. The *situla* with its handle formed of Tritons is also of most beautiful workmanship. Many other vases were found in the same tomb, but many were injured or destroyed. A helmet (*galea*) of cast bronze, chiselled and engraved, found with them, is considered the finest in existence, surpassing those at Bologna, Rome, Lodi, and Pesaro. A number of other arms were found in the tomb, and not a single piece of earthenware.

SPOLETO.—In front of the communal palace have been discovered the remains of a large Roman edifice. The peristyle was entirely paved with an elaborate mosaic, and the walls covered with encaustic paintings on plaster.—*Not. d. Scavi*, 1886, pp. 8–9.

TARQUINII-CORNETO.—*Museum.*—The importance and fruitfulness of the excavations carried on during the last few years have led to the establishment of a local Etruscan Museum, where all the objects found are to be placed.—*Cour. de l'Art*, April 9.

TERNI.—About two kilometres from Terni, have been found numerous tombs, whose contents, if the excavations had been properly conducted and supervised, would have thrown much light on the early population of this province, of the early period of which so little remains. Some of the tombs were for inhumation, some for cremation: the former being either simple trenches, or trenches walled and covered with calcareous stone; the latter consisting of urns containing the ashes. Among the

objects are bronze fibulae, bracelets, lances, "rotelle," knife-razors, "pendaglietti," etc.—*Not. d. Scavi*, 1886, pp. 9–11.

CHRISTIAN ANTIQUITIES OF ITALY.

MARSALA (Sicily).—*Christian Antiquities*.—Invited by the prefect of Trapani, Prof. Salinas, director of the Museum of Palermo, visited the so-called *Grotta della Sibilla*, where, instead of the reported classical antiquities, he found a Christian monument of great importance, no other examples of which are known in Sicily. It is entirely decorated with paintings which still retain the classical style: its pavement was in mosaic, of which fragments of the greatest beauty remain. Steps were taken to protect the remnants of this mosaic, and all the wall-paintings were copied by the light of torches, after removing, by water, the calcareous crust that covered them. *Catacombs of Marsala*.—At the same time, copies were made of some hitherto unknown frescos in the Catacombs of Marsala: one of these represents the Good Shepherd.—*Not. d. Scavi*, 1886, pp. 103–4.

MILAN.—The fine collection of works of art and of manuscripts belonging to Count Trotti has recently been sold. The greater part has been bought by the well-known dealer Sig. Baslini. Com. Hoepli bought, for an enormous sum, the rest of the collection: the manuscripts and miniatures. Among these is an *Officium Mariae*, a gem of the Lombard school of the xv cent.; another *Officium* in 4to, in a Venetian binding of the xv cent.; and many other wonderful specimens of Italian miniature painting.—*Cour. de l'Art*, March 19.

FRANCE.

APT.—In digging a well in the house of M. Reboulin, some workmen came upon remains of Roman walls, at a depth of 8 metres. On demolishing them, there was found, at 12 met., a deposit of 26 bronze and copper vessels, hidden in a hole in the rock. They consist of (1) a lamp; (2) 7 vases with raised handles and mouths; (3) 12 oinochoai of various shapes, adorned with palmettes and masks; (4) 6 basins. The lamp is of beautiful workmanship: it is circular, and has three noses under which are finely-chiselled satyr-heads; each nose has a ring decorated with palmettes in which are three chains attached to a cartouche with the inscription GENIO COL GIVLIVS VALIDVS EX VOTO. Two of the vases are richly gilt all over, and well decorated. A coin of Constantine may give the date of the objects.—*Revue Arch.* 1886, I, pp. 178–80; *Cour. de l'Art*, March 12.

LILLE.—The Director of the Museum of Ethnography, M. Van Hende, has secured a superb collection of ancient stuffs of Peru. This collection,

formed at Lima by M. Quesnel, is the most important, perhaps, after that of the Trocadero.—*Revue d'Ethnographie*, 1886, No. 1, p. 93.

LIMOGES.—*Art Exhibition.*—On May 10, was opened the scientific and artistic exhibition, which promises to be of the greatest interest, as Limoges was throughout the Middle Ages one of the great art centres of France. Before the opening, the *Commissaire général*, M. Garrigou-Lagrange, spoke in these terms of the retrospective section of ancient works of art, ending by saying that 500 or 600 of the ancient enamels for which Limoges was so famous will be on exhibition: "Il y a eu chez nous pendant des siècles une telle production d'œuvres artistiques: l'orfèvrerie, l'émaillerie, l'imprimerie y ont accumulé tant de richesses, que, malgré les années écoulées, malgré l'avidité chercheuse des collectionneurs, qui ont emporté une grande partie de nos trésors, il nous en reste encore de magnifiques débris. Aussi notre section d'art rétrospectif réserve-t-elle aux artistes et aux amateurs de véritables surprises, et, sans parler des tapisseries anciennes, des pièces d'orfèvrerie et des livres curieux, je ne veux, pour preuve de l'intérêt qui s'y attachera, que les cinq ou six cents émaux réunis à ce jour par la Commission."—*Cour. de l'Art*, April 16.

METZ.—A Roman triumphal monument, whose fragments were found some years ago in a village of Lorraine called Merten, has just been erected in the Museum of Metz. It is ten metres high: on a base rises a square plinth with four niches containing statues, almost life-size, of Apollo, Juno, Minerva and Hercules. On the summit, on a pedestal, are seven smaller statues which may represent the seven days of the week (?). From this rises a column with a rich capital adorned with four heads (probably the four seasons). The monument is crowned by the statue of a Roman warrior spearing an enemy who lies under his horse. It seems to date from the end of the II or the beginning of the III century A. D., and to commemorate a Roman victory over some native tribe.—*Cour. de l'Art*, April 16.

PARIS.—*Museum of Decorative Art.*—One of the questions of the day in Paris is the proposed erection of a Museum of Decorative Art by the *Union centrale des Arts décoratifs*. The lottery organized for the purpose left in the hands of the Society the sum of about six millions of francs, of which it is proposed to devote one half to the building, and the other to the purchase of works and the organization of instruction. The site has not yet been selected. It was proposed to construct the museum on the Quai d'Orsay, on the ruins of the former *Cour des Comptes*, which would have placed it entirely out of the reach of the workmen, for whom it is especially destined.—*Cour. de l'Art*, March 12.

Municipal Museum.—The prefecture is contemplating the establishment of a Municipal Museum of Fine Arts, which is to be formed of

works not especially related to the history of Paris, in order not to clash with the *Musée Carnevalet*.—*Cour. de l'Art*, March 19 and April 2.

New Library.—Another public library was opened in Paris, on Feb. 28: the *Bibliothèque Municipale professionnelle d'Art et d'Industrie*, established by means of a bequest made to the city by M. A. S. Forney. It includes a reference and a lending department, both free; and contains a considerable number of books on the fine and industrial arts and the applied sciences, besides over 10,000 engravings, drawings, and photographs.—*Athenæum*, March 6.

GERMANY.

Publications of the Imperial Archæological Institute.—For some time the project has been entertained of entirely remodelling the heretofore existing system of publications of the Institute, in order better to concentrate the archæological forces of Germany, and also to inaugurate a system of centralization. This project has finally been realized, and is initiated with the present year (see Circular of the Central-Direction of the Institute, dated Berlin, March, 1886). Until the present, the following have been the Institute's publications. At Rome, the *Annali*, the *Monumenti Inediti*, and the *Bullettino*, mostly in the Italian language: at Berlin, the *Archäologische Zeitung*: at Athens, the *Mittheilungen*. According to this arrangement, the centre of activity was Rome: this centre has now been transferred to Berlin, making Rome and Athens branches of the central organization. Thus, at Berlin will appear, at the end of each year, the *Antike Denkmäler*, a folio publication with 12 plates accompanied by short explanatory texts, which takes the place of the Roman *Monumenti Inediti*: the monuments are to be taken from the whole field of classical archæology, including architecture. It will be edited by Dr. Max Fränkel with the coöperation of the secretaries at Rome and Athens. Further, the Berlin Institute will issue a quarterly *Jahrbuch*, also edited by Dr. Fränkel, which will take the place of the *Archäologische Zeitung*, though it will be enlarged in the branches of bibliography and discoveries. The *Ephemeris Epigraphica* also appears at Berlin. Both the Schools at Rome and Athens have a quarterly organ, the former entitled *Mittheilungen. Römische Abtheilung*; the latter, *Mittheilungen. Athenische Abtheilung*. The Roman publication takes the place of the *Annali*, and will probably not differ much from it, except in language, as not only German and Italian, but Latin and French articles are allowed; it also includes the sittings of the Roman Institute, which have always appeared in monthly numbers of the *Bullettino*. The Athenian publication will doubtless not differ from the present *Mittheilungen*.

The change will doubtless be an assistance to a systematization of archæological work in Germany, and will bring Greek and Asiatic archæology into greater prominence. Still, one very natural result will be the partial disruption of the great Roman branch, whose members were so largely recruited in Italy. Italians will doubtless soon establish, as they well might have done long since, a *National Archæological Institute* for Italy.

AUSTRIA-HUNGARY.

VIENNA.—*The Archduke Renier's Papyri*.—The study of the papyri is facilitated by their removal to suitable quarters in the second floor of the Imperial Museum, where the deciphering is being continued, and in connection with which a room is provided for their scientific study. Among the documents recently discovered is a poetical description of the city Pi-Rameses, founded by Rameses II in the eastern Nile delta; fragments of a codex of Aischines, containing *oration* III, § 178-86, and of one containing Isokrates' *oration* v, § 48-9; pieces of a lexicon to the *Meidias* of Demosthenes, and of an unknown grammarian of the first century; a number of private documents belonging to the time of the Roman Empire, among which are Greek papyri dating from Trajan, Hadrian, Antoninus Pius, Marcus Aurelius, Gratian, Constantine, Licinius, Valerian and Honorius. A MS. of Hesiod, some centuries older than any yet known, contains about 200 verses from the *Works and Days* and the *Shield of Herakles*; also fragments of the *Argonautics* of Apollodoros Rhodios; 200 verses of the *Odyssey* of which no traces had yet been found on papyrus; fragments of several books of the *Iliad*, etc.—*Revue Arch.* 1886, I, pp. 168-9; *Rivista di Filologia*, XIV, p. 368; *Mittheil. d. K. K. Oesterr. Museums*, 1886, pp. 58-9; *Athenæum*, April 18.

CAMPODUNUM—KEMPTEN (Bavaria).—Further investigations, by Fr. Thiersch and others, of the ruins of Roman Campodunum, prove that the remains mark the site of a borough forum.

ROUMANIA.

ADAM-CLISSI (Dobroutcha).—The interesting tower of Adam-Clissi has been the subject of many disputes: some have considered it to be the work of the Persians; others, of some Thrakian tribe under Greek influence (v cent. B. C.); a German commission pronounced it to be a Greek work. Recently the discovery of an inscription (ORDIN(is)) has proved it to be a Roman construction. It is at present 15 met. high, and 16 met. wide, a great part of it having been thrown down. At the summit are remains of colossal statues. The stones forming the revetment are all sculptured, and represent, on the N., military scenes; on the E., war-chariots; on the S., ornamental designs; on the W., women, children and

animals. Many of these stones have been carried off by the peasants, some by the English, and others by the Turks. In order to save it from destruction, the Roumanian Government intends to take it down and rebuild it at Bucharest.—*Revue Arch.* 1886, 1, pp. 150-2.

GREAT BRITAIN AND IRELAND.

ENGLAND.—*Epigraphical discoveries in 1885.*—At a meeting of the Archæological Institute, March 4, Mr. W. T. Watkin communicated a paper on Roman inscriptions discovered in Britain in 1885, showing that the finds in the past year are equal to the average of the discoveries in Roman epigraphy during the last ten years, and that, as usual, the greatest number of the inscriptions have been found upon or near the line of the Roman Wall.—*Athenæum*, March 20.

LONDON.—*British Museum.*—The galleries made vacant by the removal to the Kensington Museum of the collections of natural history have been filled with collections of works of art, and are now opened to the public: among them are Oriental collections; Chinese and Japanese pottery; ethnographical collections; Indian sculptures (Jamal-Garhi).—*Athenæum*, April 17.

MR. MURRAY, the newly-appointed Keeper of Greek and Roman antiquities, is busily occupied in re-arranging the Greek and Etruscan vases. Four large vitrines in the vase-room are now appropriated to the display of the Greek examples which bear the signatures of artists, and thus attest the dates to which they are due. In proximity are grouped the unsigned works, which can thus be approximately dated. The superb collection of painted vases for unguents and perfumes, some of which are most delicately painted in colors, he has had brought down from the tops of the cases, and placed where they can be seen and studied.—*Athenæum*, March 27.

WINCHESTER.—*Cathedral.*—Excavations have laid bare what appear to be the bases of the walls of a large church, probably that destroyed by Bishop Walkelin. An immense mass of earth has been removed from the crypt of the cathedral, that buried more than the half of the shafts and the bases of the columns supporting the vaults.—*Athenæum*, Apr. 17.

SCOTLAND.—**EDINBURGH.**—**MR. J. ROMILLY ALLEN** delivered the course of Rhind lectures in Archæology in connection with the Society of Antiquaries of Scotland. The course consisted of six lectures on "Early Christian Symbolism in Great Britain and Ireland," and was delivered in Edinburgh, commencing on Easter Monday.—*Athenæum*, April 17.

IRELAND.—**DUBLIN.**—*Chapter-House rediscovered.* "It has just become publicly known that a missing chapter-house which was buried at the great fire in Dublin in the XIII century has been discovered by some

workmen who were excavating underneath Christ Church Cathedral. In the chapter-house were beautifully-carved effigies, coins, tiles, and marvellous specimens of architecture. The discovery has created quite a sensation."—*American Architect*, May 15.

AMERICA.

UNITED STATES.

LECTURES BY PROFESSOR LANCIANI OF ROME.—In the autumn, Comm. Rodolfo Lanciani, professor of archæology at the University of Rome, will visit this country for the purpose of delivering a series of lectures on *Roman archæology*, on which subject he is a well-known authority. He has had charge for some years of all excavations in Rome, and knows better than any living scholar, except perhaps Jordan, the topography and monuments of the ancient city. He will first deliver a course at the Lowell Institute, and perhaps at Harvard University: in January he is expected in Baltimore, where he has accepted an invitation to lecture at the Johns Hopkins University. The following are the topics of his lectures for the Lowell Institute.

i. The early renaissance of archæological studies in Rome (Dante, Petrarch, Cola di Rienzo, Pomponio Leto, Platina, Peruzzi, etc.). ii. The foundation and prehistoric life of Rome. iii. The hygienic laws and sanitary condition of ancient Rome (aqueducts, drainage, malaria, cemeteries, etc.). iv. The Tiber and the maritime trade of Rome (quays, wharves, Emporium, Ostia, *Portus Augusti*, treasures of the bed of the river). v. Roman Parks and Public Gardens. vi. The Roman Campaigna. vii. The Police and Garrison of Rome. viii. Ancient Rome and modern London. ix. The Palace of the Caesars. x. The discovery of the House of the Vestals. xi. Same subject continued. xii. Treasures found in the excavations.

MEXICO.

Mr. L. Batres, inspector of antiquities in Mexico, has explored the famous ruins of Tula, the ancient Toltec metropolis, and secured for the *Museo Nacional* thirteen of its interesting monuments. The pieces are, three broken colossal statues (Charnay, *Anciennes Villes*, p. 72); three fragments of immense columns of a temple elaborately sculptured (*ibid.* p. 73); a sculptured disk, a metre in diameter (*ibid.*); two large idols; a cylindrical stone; a square die with hieroglyphs (p. 75); a Toltec *metate*; part of the column of a palace with hieroglyphs and characteristic Toltec decoration.—*Revue d'Ethnographie*, 1886, No. 1, p. 93.

ADDENDUM.

ARCHÆOLOGY IN SOUTHERN INDIA.

Mr. Alexander Rea of the Archæological Survey has lately visited and inspected a remarkable group of rock-cut caves in the North Arcot District of the Madras Presidency. These were noted under the head "Māmandūr" in Sewell's *Lists of Antiquities*, vol. I, p. 166, but they had not been scientifically reported on before the visit of Mr. Rea. The group includes four rock-cuttings, none of great architectural pretensions, their features consisting of a few mouldings, carved ornaments, and some sculpture. They have, however, considerable archæological interest from the fact of their resemblance, on all points, to some of the ancient works at Mahābalipuram which date from the 7th century A. D. In the cave to the extreme north of the group is an inscription in Pallava-Grantha characters, of great antiquity. It proves that the caves were excavated by the Pallavas. In the second cave are two inscriptions in excellent preservation in Chola-Tamil, testifying to grants made to the Temple by the Chola sovereign who reigned from A. D. 1023 to 1064. [*Communicated by Mr. Robert Sewell.*]

A. L. FROTHINGHAM, JR.

SUMMARIES OF PERIODICALS.

ARCHÄOLOGISCHE ZEITUNG. 1885. No. 4.—1. M. MAYER, *Alkmaion's Youth* (pl. 15). A fine *hydria* with red figures, in Berlin (No. 2395), is published. The painting represents Eriphyle giving suck to the little Alkmaion, in the presence of Amphiaraos and a servant. The three chief characters are designated by inscriptions. The tendency of many modern writers to regard too many vase-paintings as genre-scenes from common life, even when well-known names of heroes are given in inscriptions, is discussed.—2. K. WERNICKE, *Contributions to the knowledge of Vases with Artists' Names* (pls. 16–19). A collection of drawings formerly the property of Edward Gerhard is in the Berlin Museum. The paintings and inscriptions from 18 vases, drawings of which are in this collection, are discussed. Many of these have been previously mentioned by W. Klein in his work *Die griechischen Vasen mit Meister-signaturen*. The vases here described are by the following artists: Taleides, Tychios, Nikosthenes, Charitaios, Hermogenes, Charinos, Panphaios, Epiktetos, Chachrylion, Euphronios, Duris, Hieron, and Polygnotos, besides one with the inscription Ἰερ[ο]ν κα[λ]ός, and one with Δέαρος [κα]λός. The vases published are, one each, by Nikosthenes (16, 1), Hermogenes (16, 2), and Epiktetos (16, 3), one presumably by Euphronios (17), two presumably by Hieron (18 and 19, 1), and one with Δέαρος καλός (19, 2).—3. P. WOLTERS, *The Triton of Tanagra*. Two coins of Tanagra are published. One of these is in Berlin, the other in the British Museum (*Catal. Central Greece*, pp. 66, 60; pl. 10, 15). Examination of these and a similar coin (*Wiener Numism. Zechr.* IX, 1877, p. 32; *Arch. Ztg.* 1883, p. 255) shows that the figure of Dionysos there represented cannot be the Dionysos of Kalamis (Paus. IX, 20, 4). The Triton represented on the coins, and described by Pausanias *l. c.* (cf. Aelian *περὶ ζῴων* XIII, 21) is shown to have been, not a work of art, but an embalmed sea-monster.—4. F. MARX, *Dioscuri from Southern Italy*. A small terracotta from the neighborhood of Bari is published as a vignette. The Dioscuri are seated side by side, and two animals (lions or panthers) are fawning upon them. This work is Asiatic, and probably reached Italy by way of Lakonika (cf. Pausanias' description of the shrine at Amyklai, III, 18, 8), whence it was brought by early emigrants.—5. A. FÜRBRÄNGER, *The "Hera of Gir-*

genti." Cuts of four heads are given, all of which are declared, upon internal i. e. stylistic evidence, to be forgeries. The heads are: *A*, the "Hera of Girgenti" in the British Museum (*Mon. d. Inst.* ix, 1; Overbeck, *Kunstmythol. Hera*, pl. ix, 4, 5; cf. Friederichs-Wolters, *Gipsabgüsse*, 501): *B*, a head in the Castellani collection (Fröhner, *Auction catalog*, pl. 22, 23, No. 1085): *C*, a head in the Berlin Museum (*Verzeichn. d. ant. Skulpt.* Berlin 1885, No. 1328): *D*, a head in the possession of Baron von Warsberg in Vienna (Friederichs-Wolters, *Gipsabgüsse*, 1458). These heads are all ascribed to the same unknown modern forger.—

6. MISCELLANIES. A. MICHAELIS, *Theseus or Jason?* Additional support for the views expressed in *Arch. Ztg.* 1885, p. 231, is derived from a newly found MS. (*Rhein. Mus.* xli, 1) part of which from Apollodoros is given in full.—A. MICHAELIS, *The Lost Medicean Statue of Poseidon* (cut in the text from Cavallieri's *Antiquae statuae urbis Romae* pl. 27). The statue is described, and previous notices of it are quoted. The statue of Apollon which Cavallieri published as *in aedibus Victoriarum* (Palazzo Vettori) is said to be identical with the Apollon Egremont.—H. BLÜMNER, *The Greek Eating-tables again* (cf. *Arch. Ztg.* xlii, pp. 179, 285). Two cuts are given of a small bronze table from Clusium, which serves as pedestal for the figure of a dancer. This table, which is in the Berlin Museum, was wrongly said by Friederichs' *Berl. ant. Bildw.* (ii, 167, No. 693) to be modern. It is antique, and confirms what the writer has elsewhere stated.—K. WERNICKE, *The Vases with Artists' Names; Appendix to p. 249 sqq.* To the vases there described are added, one with the inscription *Ἐπίδρομος*, one with *προσαγορεύω*, and one with *Megakles*.—A. MICHAELIS, *Appendix to p. 281.* Additional evidence is addressed to show that the *Mythographus Vaticanus* and the *Scholion* to *Il. A*, 741 agree with Apollodoros about Theseus and Medeia.—F. STUDNICZKA, *Appendix to Arch. Ztg. 1884, p. 281 sqq.* Furtwängler is said to be the first who gave the name of Sterope to the so-called Hippodameia of the eastern pediment at Olympia.—7. REPORTS. *Archaeological Society in Berlin*, meeting of Nov. 3.—*Chronicle of the Winckelmann-celebrations.* HAROLD N. FOWLER.

BULLETTINO DELLA COMMISSIONE ARCHEOLOGICA COMUNALE DI ROMA. 1885. Oct.-Dec.—RODOLFO LANCIANI, *The quarters of the Equites Singulares.* In the neighborhood of the *Scala Santa* (Lateran) the prolongation of the *Via Tasso* from the Esquiline led, some months ago, to the discovery of a long solid wall adorned with riches, against which was placed a row of marble pedestals and votive altars with long inscriptions relating to the *Equites Singulares*, whose quarters were in this place (for description of building and statues, see p. 222 of the *News*). In this paper, Prof. Lanciani does not describe the building or enter into any

historical, critical, or topographical considerations,—of which he has given a charming popular presentation in the London *Athenæum* of March 13,—but simply publishes the text of 24 of the inscriptions.—RODOLFO LANCIANI, *A fragment of the marble plan of Severus representing the Clivo della Vittoria and the Vico Tusco* (pl. XXII). The writer has made various attempts to relate the many scattered and disconnected fragments of this famous marble plan of Rome, often with success. This paper brings forward one instance of this kind, in which three fragments are brought together and shown to be connected and to represent the northern part of the Palatine between the garden of Sta. Maria Liberatrice and the present entrance opposite the fish-market. It includes several buildings whose identity has not yet been established, but which probably will be when the excavations that are at present being conducted on this very site shall have been brought to a close.—R. LANCIANI, *Supplement to vol. VI of the Corpus Inscriptionum Latinarum* (see p. 94).—C. L. VISCONTI, *List of the ancient works of art, discovered by the Communal Archaeological Commission from Jan. 1 to Dec. 31, 1885, and preserved at the Capitol or in the Communal store-houses*. See analysis given in the *News*, pp. 225–6.—*Acts of the Commission and gifts received*. These show the extraordinary activity and the efficiency of the Commission in the presence of the unusual opportunities for archæological work and discovery which are now presented. Some of the facts are brought out in the *News*, pp. 220–1. A. L. F. JR.

BULLETIN DE CORRESPONDANCE HELLÉNIQUE. Athens and Paris, 1886. **January.**—G. COCSIN and F. DURRBACH, *An Inscribed Bas-relief from Lemnos*. One side of a big stone found in the interior of the island, and the space not taken up with the vignette of a warrior on the face, are covered with archaic Greek characters written *ῥουσσροφιδόν*. But the words they form are not Greek. M. Bréal thinks the document Thracian; the writers point out Etruscan alphabetic peculiarities, desinences, etc.; neither pretends to render the sense. These old mercenaries wrote Karian on a statue of Rameses, or Norse Runes on a lion at the Peiraieus, or Lydian (?) on such a stone as this, with little regard for the future epigraphist.—TH. HOMOLLE, *Note on the Chronology of Athenian Archons (B. C. 166 to 102)*. Corrections of the lists from Delian documents, inasmuch as the official chronology of Delos is that of Athens after B. C. 166. Fixed dates are assigned to a number of archons.—G. COCSIN and CH. DIEHL, *Inscriptions of Kadyanda in Lykia*. Publication of 20 inscriptions. Occasion is given for the observation that many Lykian documents reflect the popularity of a national legend, the heroes of which were made famous through Homeric song: Télébéoué is Telephos; Glaukos, Sarpedon, Bellerophonés gave their names to townships.

Also, the Lykian nation survived into the Roman Empire as a religious community—like the Saxon kingdoms in the sees of the Church of England. A versified epitaph at Usumlü throws a ray of light on ancient slavery.¹—M. HOLLEAUX, *Excavations at the Temple of Apollon Ptoos. II* (p's. IV, VII). Second report of discoveries at Akraiphia in Boiotia: an archaic statue and fragments. The statue, a rude male figure broken off at the knees, measures 1.30 met., has one leg slightly advanced, arms straight and adherent, face beardless, and hair bound with a fillet. It belongs to a well-known category, of which we possess good examples from the Kyklades, the Isthmos, Boiotian Orchomenos, and elsewhere. To the last generation, this type represented a god, Apollon. Recently, it is held to image an athletic victor, or a defunct personage. The example from Akraiphia, at least, was found in the precinct of a temple, and, as sepulchres were excluded from sanctuaries, this would exclude the hypothesis that it represents a deceased person. The athletic theory, also, would hardly obtain, as the Ptoian games were not of early celebration. M. Holleaux's analysis places it, in point of art, in the group which Furtwängler has headed with the "Apollon" of Orchomenos (see *News* of last number of JOURNAL, p. 86). A head, of kindred general type, is much mutilated, but not enough to conceal the fact that it belongs to the advanced archaic school. H. assigns it to a high position and a late date (ca. 525 B. C.) among early Boiotian statuary. The third work described is part of a square pillar-image or *ἑτάρον* of singular rudeness, dating back to the VII century. It is quite unique, and belongs, according to M. H., to the period of wood-sculpture.

February.—E. POTTIER, *Excavations in the Necropolis of Myrina. Conclusion* (pls. XII, XV). Two terracotta groups: Dionysos and Ariadne: one is of inferior make and bad proportions, a first state in terracotta, as it were; both personages, in the finished one, wear rings, which strike a nuptial note. Otherwise, the female figure could be Semele, a maenad, or drunkenness personified, as in a similar group from Syme, near Myrina. The god of wine drops an empty drinking-vessel in his left hand, and a heavy head on his companion's shoulder; his right arm is bent over his head in the attitude of sleep or sleepiness. Seilenos giving drink to a little Dionysos he holds in his arms is one of the clever copies of large sculpture common in Asia Minor; the "faun with the baby" is one of the treasures of the Louvre galleries. A box-vase bears a scratched epigraph: *Made by Therinos. A present to Nysa, from Recepta.*

¹ Translation: "Leonteus built this tomb upon the soil
That marks the grave of Zosimos, his friend
By ready service and in honest toil.
Now his young master, thankful, mourns his end."

This Latin name brings the generality of *Myrina figurines* down to the 1 century B. C. A capital feminine bust (pl. XVI, h. 0.25 m., w. 0.22, face 0.055) wears a gilt riband in the hair, and a sky-blue and violet dress, gold-hemmed and fastened with a gold brooch in a V neck: the ears are pierced.—P. FOUCART, *Ephesian Inscription*.—M. HOLLEAUX, *Excavation at the temple of Apollon Ptoos*. III (pl. v): head of an archaic figure, which is described in the *News* of the last number of the JOURNAL, p. 87.—F. DURRBACH, *Decrees of the III and II centuries, from Delos*. Documents of a time when cheap purchase of corn was public distinction, and when Athens required an escort of Rhodian men of war for her miserable fleet of three or four open vessels, menaced by Makedonian cruisers. An analysis of this paper is given in the preceding number of the JOURNAL, p. 87.—C. D. MYLONAS, *Inscription from Troizen*. Decree of a Doric city, probably Troizen, calling on its clans, associations, etc., to contribute for immediate fortification and other protective measures. An account of wholesale patriotic contributions follows. M. assigns the emergency to the moment after the defeat of Aratos and his Achæians by Kleomenes III of Sparta, in 425 B. C.—G. RADET and P. PARIS, *Inscriptions from Attaleia, Perge, Aspendos*. A human interest attaches to one Modestus the Sophist, whose epitaph proclaims that "he belonged with the seven wise men (as eighth!), but died not yet twenty-five years old."—MISCELLANY. *A metrical epitaph in Athens. Rhodian funerary inscriptions.*

ALFRED EMERSON.

BULLETIN TRIMESTRIEL DES ANTIQUITÉS AFRICAINES. 1885.
April-July.—C. PALLU DE LESSERT, *The Governors of the Mauretania*. On the assassination of Ptolemy in 39 A. D., his kingdom was made into two Roman provinces, Mauretania Caesariensis and Mauretania Tingitana: under Diocletian a third, Mauretania Sitifensis, was formed of a part of the Caesariensis. The Governors bore different titles at different times. The writer collects all the available information concerning them, and edits many of their inscriptions. Governors of Mauretania Caesariensis: M. Licinius Crassus Frugi (40 A. D. ?); C. Suet. Paulinus; Cn. Hosidius Geta; Vibius Secundus; Luceius Albinus; Lusius Quietus; Q. Marcus Turbo; M. Vettius Latro (128); C. Petronius Celer; C. Porcius Vetustinus.—J. POINSSOT, *Archæological Journey in Tunisia in 1882-83*. At Agbia (mod. Aïn Hedja), an interesting Byzantine citadel; at Henchir Douameus mta l'oued Rmel, ruins of an important city, with walls, temples, basilica, etc.—A. WINCKLER, *Notes on the ruins of Bulla Regia*. The city is in the shape of a triangle each of whose sides measures about 800 metres; it had four gates and seven posterns. Outside the city was the necropolis, and, on a hill, a large building (temple)

50. by 35 met.: to the S. a vast semi-elliptical amphitheatre, and to the E. a triumphal arch. Within the city, a theatre; a nymphaeum; baths (well-preserved); numerous private dwellings with fine mosaics.—L. DEMAEGHT, *Archæological Museum of Oran*. A description of the Roman antiquities possessed by the newly-opened Museum at Oran.

Aug.-Oct.—H. FERRERO, *Inscription of Vulcacius Rufinus*. Republication of an inscription given already by Lanciani in *Not. d. Scavi*, May 1884, and *Bull. d. Comm. Arch.* XI, p. 233; XII, p. 45. Vulcacius Rufinus, son-in-law of Constantine, is here shown to have been governor of the East, Egypt, and Mesopotamia; governor of Numidia, etc.—C. PALLU DE LESSERT, *The Governors of the Mauretania* (cont.). Continuation of the inscriptions concerning the Roman governors of Mauretania Caesariensis: T. Varius Clemens (A. D. 152); Sextus Baius Pudens (A. D. 167); Cl. Perpetuus; Cn. Nunnus Martialis (A. D. 195); P. Aelius Pereg. Rogatus (A. D. 201-211); Cn. Haius Diadumenianus; Q. Sallustius Macrinianus; C. Oct. Pud. Caesius Honoratus; P. Flavius Clemens; L. Licinius Hierocles (A. D. 227); T. Aelius Decrianus; T. Flavius Serenus; P. Sallustius Sempronius Victor; Capellianus (who defeated the Gordians); Catellius Rufinus; Livianus; M. Aur. Atho Marcellus; M. Aur. Vitalis (254); Fl. Pecuarus (288); T. Aur. Litua (292); Ulpus Appollonius; Aelius Januarius; Val. Faustus (311); Flavius Terentianus (318-19). The Governors of Mauretania Tingitana referred to are: Trebonius Garucianus; Luceius Albinus; P. Baesius Betuinianus. C. Marius M. Sabinus (203); C. Vibius Salutaris; C. Vallius Maximianus; Rufinus; C. H. D. (*above*); Q. S. M. (*above*); Furius Celsus; T. F. S. (*above*); Anastasius Fortunatus (298); A. J. (*above*); Fl. Memorius. Governors of Mauretania Sitifiensis: T. A. L. (*above*); Sept. Flavianus; F. T. (*above*); Fl. Augustianus; Jucundius Peregrinus; Sext. Ages. Aedesius; Fl. M. Constans.—J. POINSSOT, *Archæological Journey in Tunisia in 1882-3* (cont.). The routes from Carthage to Theveste and from Carthage to Sicca Veneria. Ruins at Henchir Qaoussat and a number of inedited inscriptions, especially on mile-stones.—J. POINSSOT, *Inedited inscriptions found by M. Winckler*.—A. HÉRON DE VILLESFOSSE, *Notes on African Epigraphy* (cont.). See the inscriptions, *JOURNAL*, II, p. 82.—TH. MOMMSEN, *The African Provinces*. A chapter from T. v of his Roman History, translated by C. Pallu de Lessert.

Nov.-Dec.—A. HÉRON DE VILLESFOSSE, *Notes on African Epigraphy* (cont.). XIX. Bust of Ptolemy King of Mauretania (pl. XXI). This marble bust, found in 1843 at Caesarea (mod. Cherchell), and now in the Louvre, was proved by Lenormant to be that of Ptolemy the last King of Mauretania (23-40). XX. Roman mosaic from Hadrumetum (Louvre) (pls. XXII, XXIII). A description of five fragments of a mosaic found in

1882. The most important represents a race of four cupids on fishes, a parody of the Roman races: the others represent a panther, a monkey, a horse. XXI. Third report on the excavations of Lieut. M. Boyé at Sbeitla (Sufetula), Tunisia. These excavations were commenced in 1883, and are here referred to in the order of their discovery, with the publication of all the inedited inscriptions, several of which are of considerable historical importance. XXII. Inscription of the reaper (Louvre). Some corrections and additional readings.—A. L. DELATRE, *The Punic tomb of Byrsa and its contents*. This tomb was discovered in 1880, but the interesting objects which it contained had not until now been illustrated. The mausoleum was composed of a rectangular chamber with a pointed roof built of large blocks of tufa in horizontal layers without cement (2.68 by 1.58 by 1.80 met.). It may belong to the earliest period of the colonization by the Tyrians. The two bodies were accompanied by one large and ten smaller vases and ten vials of terracotta, four *paterae*, and nine Punic lamps. In one of the tombs some arms were found, which is an almost unique coincidence, and indicates a primitive period.—A. L. DELATRE, *Christian Inscriptions found in different parts of the ancient city of Carthage*. These form Nos. 964 to 979 of the *Corpus* of Christian inscriptions of this region.—A. L. DELATRE, *Marks on pottery found at Hadrumetum*.—B. ROY, *Inedited inscriptions of the Roman bridge and the region of Kef*. These are, for the greater part, short epitaphs from Sidi Amor, Henshir Meyala, Khanguet-el-Kedime, Kasr-el-Hotiba, Fom-el-Afrit, etc.—J. POINSSOT, *Archæological Journey in Tunisia* (see *Bulletin* t. I, p. 291; t. II, pp. 68, 150, 226; t. III, pp. 16, 89, 174). Notes on the ruins met on the road from Kairwân to Tunis, towards the close of the journey. The route taken was along the foot of the high range of mountains that borders on the west the immense plains of Kairwân and the Enfida of the Ouled Saïd, and on whose edges are vast, fertile and well-watered plateaux, once densely populated. The remains of ancient stations are numerous, and some prove, by the extent and importance of their ruined monuments, the existence of cities of some size. M. Poinssot signalizes a rectangular entrenched camp near Kairwân, and another a few miles beyond; at Henshir-el-Hamman, at the entrance to a narrow defile, the ruins of two cities, and a magnificent aqueduct. On a Roman road from Hadrumetum to Carthage, on a plateau of the Djebel Sidi Ahmeur, are the ruins of an important city, some of whose principal monuments M. Poinssot illustrates. One of its three temples is still standing: numerous mausoleums surround the city. Wilmanns conjectured the city to be Sua, but the apparent analogy with Souar has no value whatever.—TH. MOMMSEN, *The African Provinces* (cont.). Translated by C. Pallu de Lessert.

JOURNAL OF HELLENIC STUDIES. Vol. VI. No. 2. Oct. 1885.—**JAMES FERGUSON**, *The Tomb of Porsenna* (pl. LX). An attempted restoration of this tomb as described by Pliny (xxxvi. c. 13), with its three stories, five pyramids, its petasos, and its 450 feet of altitude.—**THEODORE BENT**, *The Islands of Telos and Karpathos*. Some interesting notes of a visit to these outlying and little-known islands of the Sporadic group, describing an Hellenic temple, now converted into a church, and some graves on Telos, and others on Karpathos. He also notes some of the dialectic peculiarities of the language in which several survivals of classical words and roots are recorded.—**A. S. MURRAY**, *A Terracotta Diadoumenos* (pl. LXI). This statuette, recently acquired by the British Museum, is supposed to have come from the vicinity of Smyrna, and is believed by Mr. Murray to be a copy of the Diadoumenos of Polykleitos, conforming more closely to the original, in its canon of proportion, than the marble copies now known, and therefore probably the work of some artist belonging to the close of the century intervening between Polykleitos and Lysippos, by whose canon the marble copies are affected. A bronze original is obviously followed, as shown by the careful preparation of the surface; the influence of Praxiteles is also perceptible.—**E. A. GARDNER**, *Inscriptions from Cos*, etc. Fifteen inscriptions from Kos, Rhodos, and vicinity, more or less mutilated, and mostly honorary. Two almost exactly similar are to be found in the *Corpus*.—**E. L. HICKS**, *Judith and Holophernes*. Ewald long ago suggested that the Holophernes of the Book of Judith might have been identical with Orophernes, king of Kappadokia and friend of Demetrios Soter, and Mr. Hicks agrees with him. Coins of this king were discovered in the temple, at Priene, in 1870, and a mutilated inscription relating to him is now in the British Museum.—**J. SIX**, *Some Archaic Gorgons in the British Museum* (pls. LIX, D). Both Homer and the Hesiodic Shield of Herakles seem to point to Kypros as the place whence the Greeks obtained their knowledge of the Gorgon; and the monuments do not gainsay this evidence.—**AD. MICHAELIS**, *Sarapis standing; on a Xanthian Marble in the British Museum* (pls. LVIII, E). A valuable study of the various types of Sarapis and Tyche, in order to give a correct explanation of this marble, to which wrong attributions were originally attached.—**WILLIAM RIDGEWAY**, *The Homeric Land System*. An important article seeking to show that the "primitive system known as the 'Open-Field' or 'Common-Field' system of agriculture" prevailed in Greece at an early period, was predominant in the time of the *Iliad*, and is represented as breaking up in the *Odyssey*; while the whole tone of the Hesiodic poems gives us a clear impression that the system of which the poet treats is one of separate and hereditary ownership in land.—**E. A. GARDNER**, *Inscrip-*

tions Copied by Cockerell in Greece (II). A completion of the paper on this subject in the last No. of the *Journal*. The material heretofore unpublished is of importance to the epigraphist only.—A. W. VERRALL, *On the Syrinx (σῦριγξ) in the Ancient Chariot*. The writer contends that this is not "the box or hole in the nave of a wheel," but the series of staves or cross-pieces which lamely served the purpose of spokes in a primitive wheel represented occasionally on coins and vases. This interpretation is based on a note in the Medicean MS. of Aischylos, from which it is inferred that staves went parallel across the circle inclosed by the circumference, and were probably fixed, not into the circumference, but on it. Diminishing thus in length, their similarity to the Pan's-pipe would be striking.—CECIL SMITH, *Vases from Rhodes with Incised Inscriptions*. Some of Biliotti's collection, with names and designations of ownership.—C. T. NEWTON, *Statue of an Emperor in the British Museum*. In the last No. of the *Journal*, Mr. Wroth tried to prove that a torso of a Roman Emperor in the British Museum belonged to a statue of Hadrian, on the ground of its constituting a substantial replica of a statue found at Hierapytna in Krete. This attribution is here contested by Mr. Newton.—F. A. PALEY, *Remarks on Aesch. Agam. 1172, in Emendation of Mr. Bury's Reading* (p. 175). Mr. Bury's comparison (see last No. of *J. H. S.* p. 175) is accepted with an emendation. A. C. MERRIAM.

MITTHEILUNGEN DES DEUTSCHEN ARCHÄOLOGISCHEN INSTITUTES IN ATHEN. Vol. X. No. 8.—F. MARX, *Marble group from Sparta* (pl. 6). Publication of a badly mutilated group representing a nude female at each side of whom stands a small male figure. Head and neck, both arms, and the legs from the knee down are gone from the central figure: the other two are also much mutilated. The female figure is evidently kneeling. This position was characteristic of women in labor. The two male figures are deities who assist in childbirth. The group is probably a votive offering dedicated, by a mother after she was delivered, to the deities who had aided her. The execution of the group is somewhat clumsy, and reminds us of wood-carving, yet it is by no means very primitive. Considerably later than the middle of the sixth century, is the approximate date assigned.—J. H. MORDTMANN, *Epigraphy of Kyzikos*. III (cf. *Mith.* VI, 40 sq. 121 sq.; VII, 251 sq.). No. 28. Stele with relief representing Herakles in combat with Kyzikos (?). No. 29. Slab of marble with relief representing the Tolpian Mother, and nine priests who are preceded by a boy leading a ram to an altar. No. 30. Stele with relief: Kybele with two lions, a slave leading a ram to an altar, and two other figures. The inscription mentions the *ἱππαρχος* (the eponymous magistrate) besides the people who dedicate the stele.

These form a corporation or society consisting of the ἀρχάνης, two managers ἐπὶ τοῦ χρηματισμοῦ, eleven μέτοχοι, and two ἐπαγωγοί. No. 31. Stele with relief representing an offering to Artemis: under it a simple votive inscription. No. 32. The inscription, which the writer was not allowed to copy, mentions the emperor Tiberius. No. 33. Marble fragment, apparently of a cylindrical vessel with relief representing Hermes, who holds in his left hand the κηρυκτεῖον, in his right a purse; beside him, parts of a female figure holding a bowl: the inscription reads Ἐρμῆ]ς σαυ[φορος? No. 34. Relief representing a rider beside whom is a laurel tree about which a snake is twining: the inscription is a dedication to Apollon. No. 35. Inscription, Διόγριος τοῦ Διογνήτου Ἀθηναῖος. No. 36. Two fragments of metrical inscriptions. No. 37. Sepulchral relief representing a banquet. Nine figures besides a tree about which a snake is coiled, and half of a horse: the inscription gives the names of four men, who probably were buried in the tomb. Nos. 38–41. Inscriptions from sepulchral monuments.—G. WEBER, *Akdsché-Kajá, an unknown rock-citadel near Smyrna*. An ancient fortress about nine kilometres S. W. of Smyrna is described. It is assigned to the same period as the citadel of old Smyrna. A map of the vicinity and a plan of the citadel are given.—N. NOVOSADSKY, *On an Inscription lately found at Lebadeia*.—W. DÖRPFELD, *The Choragic Monument of Nikias* (pl. 7). The remains of this building are mostly built into Beulé's gate. Some additional fragments were found in the neighborhood. The building was a Doric hexastyle nearly 11 metres across the front. The back may have been formed by the solid rock. The triglyphs are of poros stone, the other parts of Pentelic marble. This is because the triglyphs only were completely colored.—U. KÖHLER, *The Choragic Inscription of Nikias*. In this inscription the *chorodidaskalos* is not mentioned, but the title of the dithyramb and the name of the poet (Timotheos, a Milesian poet who died before 360 B. C.) are given. The date of the inscription coincides with that of the monument of Thrasyllus, 319 B. C. The great Dionysiaks of that year were probably made unusually brilliant by a gift of Nikanor.—P. J. MEIER, *The Archaic pediment-relief from the Akropolis*. I, II. (supplementary plate) (cf. *Εφ. Ἀρχ.* 1884, p. 147, pl. 7). The relief represents Herakles in combat with the Hydra. Beside the combatants are Iolaos with a chariot, and the crab. The background was never colored, whereas all the figures were. The colors employed were flesh-color, black, light-green, and red. That is, the relief was dark on a light background. Early vases and wall-paintings show the same arrangement of color. The causes of the change from this to the opposite manner are discussed. The development of symmetry in pedimental composition is discussed by comparison of this relief with that of the

treasure-house of the Megarians at Olympia.—F. KOEPP, *The Attic Hygieia* (pls. 8, 9). It is shown that Hygieia was not brought to Athens from Epidauros with Asklepios in the fifth century, but was joined to him at Athens during the fourth century. Before the fourth century, the female figures with whom Asklepios is associated are Iaso, Panakeia, and Aigle. Two cuts are given in the text. An excursus follows in which v. Duhn's hypothesis (*Arch. Ztg.* 1885, p. 90 sqq.) that Asklepios is represented in the eastern frieze of the Parthenon is disproved.—E. FABRICIUS, *The Temple of Apollon Chresterios near Aigai*. The ruins of an Ionic temple at Nimrûd-Kalessi, near the site of Myrina, are described. An inscription shows that the temple was that of Apollon Chresterios, and mentions P. Servelius Isauricus the proconsul.—W. DÖRPFELD, *The Ancient Athena-temple on the Akropolis at Athens*. Just south of the Erechtheion, foundations of a building have been found. This was a great peripteral temple,—the old temple of Athena. Before the Persian wars no temple stood on the site of the Parthenon, for the foundations of the Parthenon are connected with the southern wall of the Akropolis, and this is ascribed to Kimon. Moreover, the architectural members which are built into the wall of the Akropolis, and have been thought to be parts of the old Parthenon, can never have belonged to one and the same building.—MISCELLANIES. A. M. FONTRIER, *An Inscription from Aidin*. An inscription on the base of a statue of a victor in the *παιχράτιον*.—H. G. LOLLING, *Inscriptions from Marathon*. Three fragmentary inscriptions, one with a dedication to Dionysos.—E. FABRICIUS, *The Grotto of Idaean Zeus* (cf. JOURNAL, II, p. 87).—U. KÖHLER, *Bialphabetic inscription in Athens*. A fragmentary inscription in the Attic and Ionic alphabets.—H. G. LOLLING, *Inscriptions from Chalkia*. A votive inscription, and a metrical inscription on a gravestone.—H. G. LOLLING, *Inscriptions from Sykamino and Limogardi*. A dedication to Herakles, and a list of names.—REPORTS on literature and discoveries.

NO. 4.—W. DÖRPFELD, *Contributions to Metrology*. IV. *The Italic System of Measures*. It is proved that the Greek foot of 0.296 m. replaced in Rome an old Italian foot of 0.278 m., probably in the year 268 B. C. At the same time the whole system of weights and measures was changed, and a reform in the coinage introduced, by which the *As* was fixed at two ounces. The changes in the weight of the *As* from a pound to half an ounce are traced.—J. H. MORDTMANN, *Inscriptions from Varna* (Odessos).—P. J. MEIER, *The Archaic pediment-relief from the Akropolis*. III. The first half of the sixth century is shown to be the probable date of the relief, for it cannot have belonged to a wooden temple, nor to one of unburnt brick. The relief is compared with the Chalkidic vase (*Ep. 'Apx.* 1884, pl. 7), and it is considered probable that

the relief is also of Chalkidic origin. *Excursus I* compares the relief above discussed with a second relief which was found at the same time and published in the same place (*Ep. 'Apx.* 1884, pl. 7). This relief is fragmentary, and represents Herakles in combat with a Triton. It cannot belong to the same temple as the first. *Excursus II* advances the theory, that the use of white in vase-paintings to distinguish female from male figures was developed from an earlier habit of outline drawing. A plaque with black figures in Athens is described, and said to be Chalkidic.

—W. M. RAMSAY, *Notes and Inscriptions from Asia Minor* (*Mith.* 1883, p. 71). iv. *Milyasa and Cabalis*. Hierokles' list of the cities of the Tauros valley is corrupt. It reads: *δήμου Μενδενέω, δήμου Σάχλα, Σίνδα, Βέρβη, Σινδαῶνδα*. By the help of inscriptions (five are here published), it is shown that the list should read: *δήμου Περμινोधέων, Πάγλα, Ἀνδηδα, Βέρβη, Ἴσινδα*. Of these the first and last lie on the Istanoz Tchai, while the other three are in the valley of a tributary stream. Ptolemy's list of the towns of Milyas or Milya and Kabalia is shown to be incorrect, while Strabo's is correct. v. *Trebenna of Pamphylia*. Ptolemy places Trebendai among the Lykian cities. All the Byzantine lists and Hierokles place it in Pamphylia. It appears to have been situated where the ruins of Evde Khan now are. vi. *The Province Pamphylia*. The Roman colony Julia Augusta Fida Comana was founded B. C. 6, and was in the province of Galatia. In A. D. 149 it was in Lycia-Pamphylia. This change doubtless took place under Vespasian. Under Diocletian the country along the Buldur lake, the valley of Isbarta, Salagassos, and the Ilan Ova at the head of the Eurymedon were transferred from Pamphylia to Pisidia. The division of Pamphylia into two bishoprics was made before Hierokles, but the division of Phrygia Pacatiana was unknown to him. vii. *Corrections*. (1) Colonia Parlais (*Bull. de Corr. Hell.* 1883, p. 318). (2) Hadrianopolis of Phrygia (*Mith.* 1883, p. 76). (3) Prymnessos and Metropolis (*Mith.* 1882). (4) Carallia, Misthia, Amblada, Pappa, and Vasada (*Mith.* 1883, p. 77).—H. G. LOLLING, *The Delphinion near Oropos and the Deme Psaphia*. 1. *Delphinion*. This ancient harbor is shown to have been 20 stadia from Oropos at the point now called Kamaraki. The "ancient Eretria" of Strabo (403) is identified with the *χώμη Ἀμάρυνθος*. Strabo says the distance from Delphinion to ancient Eretria is 60 stadia. This is shown to be correct. 2. *Psaphis*. The site of Psaphis is near the deserted village Revithiá. The inscriptions in the neighboring monastery Kalo-Livadi belonged, then, to Psaphis. A votive inscription is published.—U. KÖHLER, *The Attic Gravestones of the Fifth Century* (pls. 13, 14). i. The gravestones of the period between the Persian wars and the Peloponnesian war. The developed Attic alphabet was adopted about 440 B. C. Before that time

the alphabet was not regular. Even in public documents Ionic letters occur. To this transition period many gravestones must be referred, even if Ionic characters occur upon them. 37 inscriptions from such stones are published. The plates represent two stones with reliefs. Before the Persian wars, the epitaphs consist merely of the name of the deceased, in the genitive. Later, the father's name and the *demotikon* were added, though the *demotikon* is wanting in the inscriptions before the Peloponnesian war, because the constitution of Kleisthenes was not yet, as later, the fixed frame encompassing the life of the Attic citizen. The addition of the father's name caused the name of the deceased to be put in the nominative case, though this is not invariable in the inscriptions in question. The regular forms for gravestones of this period are: the small stele with a moulding and kyma at the top; the narrow, high pillar; and the small slab or stele with pointed gable. The style of the reliefs is incomplete and disharmonious, but original. Gravestones with inscriptions in the Attic alphabet with perfectly regular letters are unknown. In the transition period the Ionic alphabet predominates.—TH. SCHREIBER, *Alexandrian Sculptures in Athens* (pls. 10, 11, 12). Four statuettes from Alexandria are published. One (11¹) represents, in bronze, a crouching Persian supporting a weight of some kind. Two (11² and 12) represent Nubians: 11² (bronze) is apparently a fruit-vendor; on his back sits a monkey. 12 is somewhat fragmentary: the material is basalt. 10 is a comic and somewhat disgusting bronze figure of a man who has swallowed too large a mouthful. The work of these figures is such as to exclude the notion that they belong to Roman times. Various other works are cited, and the conclusion is drawn that there was in the Hellenistic period an independent Alexandrian school of sculpture.—MISCELLANIES. A. M. FONTRIER, *An Ephesian Inscription*. The inscription records the restoration of the wall of the Augusteum by order of the proconsul M. Ulpius Traianus.—J. H. MORDTMANN, *Supplement to p. 200 sqq.* Some slight corrections of the article "Epigraphy of Kyzikos" (v. *supra*).—U. KÖHLER, *Gravestones and Monuments*. Four inscriptions from gravestones found in Athens.—REPORTS on Literature and Discoveries.

HABOLD N. FOWLER.

AMERICAN JOURNAL OF ARCHÆOLOGY.

VOL. II.

No. 3.

ORIENTAL CYLINDERS OF THE WILLIAMS COLLECTION.

[PLATES V, VI.]

The Oriental cylinders which we publish in plates v and vi belong to the collection of Mr. R. S. Williams of Utica, N. Y. This collection was begun some years ago by his brother, the late Rev. Dr. Williams, who was for many years a missionary in Syria, and who assisted at Layard's excavations: it has been increased from time to time by the present owner, who has maintained relations with Syria. The subjects which we have reproduced, though few, are sufficient to show the general characteristics of the art of gem-cutting in Western Asia, and the differences which characterize it, according to period and locality. In order to fully understand the motives which lead us to attribute these works to a precise time or place, some preliminary remarks are necessary, which may be supplemented by consulting the more detailed examination which has been made in our studies on Oriental glyptics.¹

It is well known that the cylinders are cut in a hard stone,—porphyry, jasper, hematite, rock-crystal or any other *pietra-dura*; as well as in ivory and bone. They are generally pierced through the axis; the engraving occupies the convex surface; it is an intaglio, which it is impossible to study without taking an impression of the subject on

¹ *Les Pierres gravées de la Haute-Asie. Recherches sur la Glyptique orientale*: 2 vols. roy. 8vo., Paris, 1883-86.

a plastic substance: taken with care, this impression gives the subject in a bas-relief which the heliotype faithfully reproduces. A knowledge is thus acquired, not only of the subject, but also of the work of the artist, and even of the different processes which he employed. Oriental cylinders always served a threefold purpose: they were ornaments, amulets and seals. The subjects engraved on them represent, either episodes of the ancient legends of Chaldæa; or religious ceremonies; rarely scenes of mere fancy. They are often accompanied by inscriptions the extent of which varies according to the idea that was uppermost at their making. When they were considered principally as amulets or talismans, the owner inscribed a formula of prayer, or an incantation; sometimes the name of one or two divinities. Most frequently, in accord with the use of the cylinder as a seal,² he inscribed on it his name and his filiation, with a formula of adoration of one of the divinities of the Assyro-Chaldæan Pantheon.³ The inscriptions rarely give any information as to the subject of the scene. Still, they are of great importance; for the paleographic study which they render possible gives exact indications as to their epoch, and consequently of the period to which the execution of the cylinder should be referred. Some inscriptions contain the name of a sovereign the date of whose reign is already known,⁴ and these cylinders therefore constitute precious examples of the glyptic art of those dates. If, for Chaldæa, we were confined merely to these indications, however precise they may be, our means of appreciation would be very limited, but we have others which result from the use of these intaglios as seals. By this means an indication is given which enables us to fix the latest date at which certain artistic types were in use.

Excavations have brought to light contract-tablets dating from the earliest times down to the period of the Seleucidæ, which bear the impression of the seals of the contracting parties, and the date at which they were executed,—the day, the month, and the year. We thus have positive proof as to what types were used at the time when these contracts were made.⁵ For Assyria, a further indication is

² The word *kunuk* = "seal" is found on some cylinders. Cf. our *Empreintes de Cylindres assyro-chaldéens relevés sur des contrats d'intérêt privé au Musée Britannique*: Paris, 1880, p. 26.

³ *Glyptique orientale*: Introduction, p. 20.

⁴ *Collection de Clercq: Catalogue méthodique et raisonné*, Introduction, p. 4.

⁵ *Empreintes de Cylindres assyro-chaldéens, etc.*: Paris, 1880.

given by a comparison of the subjects of the cylinders with those of the bas-reliefs sculptured on the walls of the palaces, the ruins of which have been excavated. We see, then, that the artists, both sculptors and engravers, were inspired by the same ideas; and, while incorporating them by different means, they did not deviate from the traditions accepted at the centre where they lived. The establishment of these points in a great number of cases about which there can be no doubt, makes it possible by analogy to relate works which do not present any distinctive marks, to others whose places in the great periods of history have already been determined. This short preamble would not be complete, if we did not hint at the difficulties presented by the history of the glyptic art in Western Asia. The Assyro-Chaldeans were not alone in making use of cylinders. We find them in use among all their neighbors: hence, it may readily be understood that the elements of a rigorous classification are sometimes wanting. Egypt, Phœnicia, Armenia, and above all Asia Minor, present, in this respect, more than one enigma. The information which we gather regarding the Hittites, whose civilization is scarcely beginning to be revealed to us, tempt one to relate to their monuments a quantity of cylinders the explanation of which is still the cause of great embarrassment to the historian. Finally, if in certain cases the subjects present the characteristics of a work pure in its conception and in its execution, there are also examples which result from numerous influences produced by conquests or by defeats, and which affect the entire life of a people. Hence arise medleys in which the attributes, the symbols, the subjects, and even the nature of the inscriptions, are confounded. These are transitional works in which it is difficult to estimate what share belongs to the victors, and what to the vanquished, and consequently to determine the provenance of the monument.

These few remarks are sufficient to enable one to follow the description of our cylinders, and to understand the considerations which have led us either to assign to them a precise origin or to abstain from all attribution.

CHALDÆAN CYLINDERS.

It is well known that the beginnings of civilization in Babylonia are not accessible to the historian; still, certain works of this remote period have come down to us. At the period when a determined date

can first be assigned to any events of this ancient civilization (about forty centuries before our era), Lower Mesopotamia contained several cities already famous, Ur, Larsam, and Erech, which appear to have by turns disputed the supremacy, until Babylon finally obtained dominion over all these rival cities. We possess monuments of these different localities, cylinders which bear the names of their ancient sovereigns. These give sure points of comparison which allow us to appreciate the characteristic differences in the work of the artists, and to recognize, by an examination of their processes and of their tendency to devote themselves to one subject more than another, distinctive traditions which form what may be considered as *Schools*.⁶ We will now seek to justify these remarks by examining some specimens from the collection which forms the subject of this paper, and we will first study the works which we attribute to the legendary age.

Data which enable us to assign an approximate period to these archaic works are found on contract-tablets dating from the time of Hammurabi,—the first King of Babylon who united under the same sceptre all the ancient capitals of Lower Babylonia,—on which are impressions of cylinders which represent animals whose species it is difficult to determine; they rise on their hind legs and throw themselves upon each other, as if to devour one another; sometimes man appears as a mediator. This type must have disappeared about the time of Hammurabi: even at this remote period it had become worn-out and antiquated: we are thus led to attribute to it an earlier origin, and consequently to refer it back to legendary times. Now, it is precisely this scene that we find represented on *Cylinder No. 1* (porphyritic obsidian: height 2.5, diam. 1.4 centim.). The question arises, what was the origin of this subject? There is a well-known legend, *the legend of Izdubar*,⁷ in which it is said that “in the beginning,” the world was inhabited by strange animals in the midst of which man lived in peace. Can our subject be an allusion to this ancient tradition? It is allowable to suppose this; and for this reason we attribute to the legendary period the subject and the execution of the cylinder in question. Scenes of this kind are very numerous and varied; still, it is always the same thought that inspires the artist, and which he embodies with more or less talent. This cylinder shows a certain

⁶ *Glyptique orientale*, Part I, p. 83.

⁷ G. SMITH, *The Chaldean account of Genesis*, p. 202, Tab. III, col. 4.

amount of skill ; the glyptic art was not in its infancy ; the traces of the instrument often disappear under the influence of a conscious attempt at modelling, and to conform to the requirements of a symmetry which the taste for the fantastic does not exclude.

Cylinder No. 14 (bone : h. 1.5, d. 0.7 cent.) presents a subject of the same nature, but rudely executed. The arrangement of figures is confused, and it is only by a careful comparison with *replicas* more finely worked, that they can be made out. The hero of the legend illustrated by the artist stands with extended arms in the midst of the animals which are standing erect around him. On his right is a carnivorous animal always difficult to name ; he has a hideous head, and a neck covered with a thick mane. On his left is a lion, easier to recognize ; and in the field are small animals or symbols the drawing of which is too imperfect to enable us to identify them.

After these works of the primitive period, we come to scenes of a more precise character, in which personages occupy the principal position, and the scenes are religious. It is possible to distinguish, by the differences of costume, the localities whence the artist took his models for the creation of types which, after gaining acceptance, were transmitted by tradition down to quite a late period. The type of the cylinders of this kind is given by a fine cylinder in the British Museum, which was long mislaid : it was originally published by Rich, Ker-Porter and Dorow, and we have reproduced it in our *Glyptique orientale* (Part I, p. 129). The inscription informs us that this cylinder was the seal of a sovereign whose name we read *Urkhām*,⁸ the earliest king of Ur, who reigned thirty centuries before our era.

Cylinder No. 11 (hematite : h. 2.7, d. 1.6 cent.) represents a scene analogous to that engraved on the cylinder of Urkhām, only it is rudely executed. It is composed of three principal figures : first, a divinity, seated on a throne without a back, and enveloped in a very characteristic long robe ;⁹ a small figure, the lower part of whose

⁸ We might also compare this scene with that which is engraved on a cylinder of the Museum of Berlin, and which bears the name of Gamil-Sin. Prof. Schrader was the first to publish this important cylinder, which we have reproduced in our *Glyptique orientale*, Part I, p. 131.

⁹ Different scholars consider this garment to be *plaited*, or *spiral*, or even *fouced* (?). M. Heuzey thinks that this arrangement is the result of a conventional method of representing the fabric, which he considers to be a rich tissue ornamented on one side only with a long fleece. See, in the *Comptes-rendus de l'Institut*, April 16th 1886, the note of M. HEUZEY, *Sur une étoffe chaldéenne*.

body has disappeared, is prostrated at his feet; then come two figures who approach the god with raised hands, in the attitude of adoration. The field of the cylinder is thickly covered: we see, in strange confusion, different symbols,—the shining disk within the crescent of the moon; a bird; then a sort of staff, the symbol of justice;¹⁰ finally, other small animals the character of which it is impossible to define. The inscription, which consists of two lines of writing, seems to have replaced a primitive inscription; the form of the characters is such as to make it impossible to read them. Under the cartouche may be seen the upper part of the body of a small animal, probably a dog or a lion.

Cylinder No. 12 (hematite: h. 1.9, d. 0.9 cent.) presents an analogous ceremony, completed by the addition of a fourth figure standing on an animal which probably is, as on the preceding cylinder, a dog or a lion. Figures standing on animals are often met with on intaglios and bas-reliefs. This position undoubtedly had a mythical significance; the difficulty is to discover the myth which thus associates the animal with the divinity. We have been able to discover some of these relations. Thus, when we see a goddess standing on a lion, we know at once that it is Ishtar, because we are acquainted with a text which tells us that this animal was dedicated to her.¹¹ In this cylinder there is but a vague indication of the animal; and, on the other hand, though the figure, by its pose and its head-dress, may be considered a god, we do not know by what name to designate him.

Cylinder No. 6 (hematite: h. 1.5, d. 0.8 cent.) gives us a new subject. We see on a sort of platform two divinities of rigid figure, seated one in front of the other; under the platform is a lion facing to the right. Then, three standing figures advance toward the platform, with their hands raised in adoration; the second one carries a small animal in his arms. On the field is the symbol of justice, and behind the two divinities a sort of undulating line, very frequent on the cylinders of this period, which may be taken for the branch of a tree or for a serpent; it appears, however, only to mark the division of the scene.¹² The subject is a phase of *the sacrifice of the kid*. This theme has given rise to a great variety of representations, in which the role, the costumes, and the disposition of the figures

¹⁰ *Glyptique orientale*, Part I, p. 246.

¹¹ *Cuneiform Inscriptions of Western Asia*, IV, 66, rev.; c. 6, l. 25.

¹² This mistake has given rise to the most erroneous suppositions, which we have duly disposed of (*Glyptique orientale*, Part I, p. 189).

may vary, but which leave no doubt as to the ensemble of the ceremony.¹³

Cylinder No. 4 (hematite: h. 1.8, d. 1.1 cent.) represents an act of adoration of another description. The god, or his pontiff, in a long robe, is standing with the right leg advanced; two figures approach him, with the hand raised in adoration. The inscription of two lines contains the names of two divinities, *An-ut* = "Samas," and *An-a-a* = "Malik." The reading of the name "Samas" has been for a long time ascertained: it is not so with that of "Malik." At first the ideogram *An-a-a* was read "Ilaï" or "Ilaya;" then was adopted the reading "Malik," introducing into the Assyrian pantheon, without positive proof, a divinity corresponding to the Moloch of Phœnician mythology. Now, a passage in the lists of divinities, so numerous on the Assyrian tablets, seems to indicate that the ideogram *An-a-a* designates a female divinity; moreover an inscription of Saos-Duchinos (*Samas-sum-ukin*) makes her the *betrothed of the Sun*. The reading "Malik" is therefore essentially provisional.¹⁴

Cylinder No. 2 (hematite: h. 1.5, d. 0.8 cent.) gives only the rude sketch of an act of adoration, which cannot be defined owing to the insufficiency of the design: however, it is possible to distinguish the whimsical indication of two figures marching towards a fantastic animal, whose image is repeated behind him in inverse position; finally, in the field, reappears that undulating line, a branch or serpent, of which we have already spoken. The technic of the engraving, precisely on account of its unskilfulness, merits examination: it shows a naive manner of representing figures. The head is formed by three strokes, which are sufficient to indicate its position and head-dress; the body is confined to a few lines; the legs, though drawn with a single stroke, show the direction in which the figures move. These productions of a primitive art are interesting to study: they show us what can be accomplished by the effort of the artist when he desires to make himself understood, notwithstanding the insufficiency of his execution; an engraver of a more advanced period would never be so naive and at the same time so skilful.

Cylinder No. 7 (hematite: h. 2.4, d. 0.9 cent.) represents again an episode of the sacrifice of the kid; we did not analyze it by the side

¹³ See especially the subjects represented in the plates of the *Catalogue of the Collection de Clercq*, Nos. 149 to 175. Cf. same scene in *Metrop. Mus., N. Y.*

¹⁴ Cf. the note of M. Oppert in the *Catalogue de Clercq*, p. 57.

of cylinder No. 6, though it has an analogous scene, because the execution of this intaglio denotes another origin. It is certain that this cylinder belongs to Chaldæa, but we are not able to attribute it to a precise locality, because means of comparison are wanting. The intaglio exhibits an entirely different execution and figures wearing a different costume. The pontiff or god wears a hat with the brim turned up: he is armed with a sword, and wears a long robe richly ornamented: before him are three figures; the first in a short tunic, with his foot resting on a chimera, is followed by a second figure dressed in a long robe, turning back towards the third, who carries the kid in his arms. In the upper part of the field, in front of the divinity, is the disk within the crescent, and below, the symbol of justice.

The subject of *Cylinder No. 13* (hematite: h. 1.5, d. 0.8 cent.) is of great simplicity. A standing figure, robed in a short tunic, holds with the left hand, brought to the waist, a sword or a club; the right hand hangs naturally by the side of the body. He stands boldly before the pontiff, who appears to bless him. This motive is repeated to satiety on the cylinders of Chaldæa. I have long questioned what the first figure could be. I formerly took it to be a *warrior*,¹⁵ but I have been obliged to discard this view, and to restore to it its true character, which I will here explain. In seeking, among the numerous intaglios which I have studied, the scenes in which this figure is represented, I recognized it on a series of cylinders which reproduce the different phases of a human sacrifice, from the moment when the pontiff blesses the victim, to the time when it falls under the stroke of the sacrificer.¹⁶ We find that the repulsive figure which fills this office always has the same features, the same costume, and it is he who finally remains alone in the presence of the pontiff. It must therefore be admitted that this figure is only the personification of that holocaust which was only too real in all the primitive civilizations of the ancient East. When human sacrifices finally disappeared actually from Chaldæa, they were still represented by the *Sacrificer*, who perpetuated symbolically the tradition of them. The favor which these sacrifices enjoyed, explains why subjects of this nature are so numerous, for, if the human victim was no longer in reality immolated on the altar, it was still believed possible to satisfy this supreme holocaust by the symbol which consecrated the mysterious memory of it,

¹⁵ *Catalogue des cylindres orientaux du Musée de La Haye*, Nos. 90-111, 91-83.

¹⁶ *Glyptique orientale*, Part I, p. 150, Nos. 94-96.

as the highest homage that could be rendered to the divinity. The inscriptions on these cylinders often contain the names of only two divinities, which in this case are those of Samas and Malik. Above all, let us beware of seeing in the latter name a distant allusion to the Phœnician Moloch. However tempting this connection may be for the corroboration of our opinion on the role of the figure which we have described, it must be renounced. We cannot repeat too often, that the reading Malik is not yet proved.¹⁷

ASSYRIAN CYLINDERS.

Assyrian cylinders do not carry us back to so early a period as those of Chaldæa. They present, doubtless for that very reason, phases more determinable by the technical processes employed by the artists. From this point of view two Schools may be distinguished, whose seat, however, remains undetermined. On one side, the School which employed the process of execution with the *point*; on the other, that which gave the preference to the use of the *bouterolle*, or drill;¹⁸ until the artist, by the union of these two processes, removed all traces of the instrument, and produced those beautiful works of the art of the Sargonidæ.

Cylinder No. 5 (ivory: h. 2.5, d. 1.0 cent.) is a specimen of work with the point, very easily recognized by the deep and sharp lines which have left on the stone a drawing without modelling, dry and entirely linear. The subject represents the often repeated scene of adoration: it differs entirely from the Chaldæan type, but the elements of it may be found on the Assyrian bas-reliefs.

Cylinder No. 9 (obsidian: h. 2.6, d. 1.1 cent.) shows a kneeling archer aiming his arrows at a wild animal; the field is covered by various symbols. The technic of the engraving, which is especially interesting, is so closely related to that of the preceding cylinder that it evidently belongs to the same School.

Cylinder No. 16 (yellow agate: h. 3.6, d. 1.4 cent.) represents a standing archer shooting an arrow at the winged bull; behind the scene is a tree; and in the field, above, the symbol of the supreme god, and below, that of the sacred tree. An analogous scene is given on the cylinder reproduced in plate VII, No. 6, of our *Glyptique orientale*,

¹⁷ See remarks on cylinder No. 4, p. 253.

¹⁸ *Glyptique orientale*, Part II, p. 22.

Part II. The technic of the intaglio is still the same; but the forms are more rounded, an attempt at modelling being apparent; and here and there the drill has left evident traces of its use.

Cylinder No. 3 (chalcedony: h. 1.9, d. 1.0 cent.) shows us the rough beginning of work with the drill. The drill (*bouterolle*) is an instrument which the artist uses by giving it a rapid rotary movement, producing round concave holes by the means of which he first rudely sketches his figures, perfecting them afterward by giving more delicacy to the work and by making it follow more closely the forms of the body. A beautiful cylinder of the Museum of Florence shows that this method of execution was employed for the seal of a Prefect of Kalah.¹⁹ Taking this indication, in the absence of any other, as a basis, we have attributed this kind of work, perhaps rather arbitrarily, to the artists of Kalah. By studying a group of cylinders of the same kind, it is possible to clearly distinguish the scene on this cylinder. On the left is a divinity wearing the tiara, with long curling hair, and dressed in a short tunic over which falls a long robe descending to the heels, leaving the left leg uncovered: the figure is surrounded by an aureole whose rays are tipped with pearls; in front of this divinity stands, in adoration, a figure whose costume could also be restored: in the field, above, is the symbol of the supreme god, and below, a rude indication of the sacred tree. All this is represented on our cylinder, only it is in the condition of a rough sketch: in order to understand it, it is necessary to consult the cylinders of the same kind which present the different stages of the work, until there is no longer any doubt as to the expression of the thought of the artist.

To the preceding subject should be compared that of the fine *Cylinder No. 8* (sapphirine chalcedony: h. 3.4, d. 1.5 cent.). It bears traces of the same processes, but shows how well a gem-cutter could make use of them. The subject is of the greatest interest, and the inscription itself gives to this work a capital importance. We here find two distinct scenes: that on the left is but the correctly executed form of the rough design in the preceding one, but here all the details are clear. A beardless divinity stands on a pedestal; a star that shines over its head shows it to be Ishtar;²⁰ on her head is the high

¹⁹ *Glyptique orientale*, Part II, p. 36.

²⁰ The attributes of Ishtar were numerous, and it is not unusual to see her designated by either a lion or a star, or even by other symbols which it is needless to specify here.

tiara, with a double row of horns, and she is richly robed in a short tunic over which hangs a long garment which opens so as to leave the advanced right leg uncovered. She is armed with bow and quiver, drawn inside the aureole that partly encircles her. The robes are richly adorned with fringes, embroideries, and plaits. Before her stands, in adoration, a male figure with long beard and curling hair falling on his shoulders, and dressed in a long robe. This scene occurs frequently on other cylinders by the side of different subjects which need not here be mentioned. It will be interesting, however, to study the same scene on a cylinder of the British Museum whose size and perfect execution show the real character of the figure which is being adored.²¹ The artist, while giving to the worshipper a life-like appearance, has given to the goddess the stiffness of a statue. It is an *eikon* executed by the engravers of this period with a very clear intention, and always successfully rendered.

The second scene is more complicated but is easily explained: it represents the god Marduk pursuing with his arrow Tihamat, the Sea-Dragon. This theme is borrowed from an ancient Chaldean legend very popular in Assyria.²² The god, wearing the tiara, bearded, dressed in a long robe open in front which leaves the right leg exposed, and standing on a winged lion that rushes along at full gallop, pursues the monster, at which he is shooting an arrow: from his belt hang a sword and a sickle. The Dragon is a winged quadruped which, while fleeing from the god, turns back towards him his head with a hideous grimace. This scene is given in the sculptures of the palace of Nimrûd,²³ and the details of the costume of the god and the characteristics of the dragon can be clearly distinguished. But, at Nimrûd, Marduk is armed with the thunderbolt, and is enveloped in a double pair of wings. The monster is, with slight variations, of the characteristic type always attributed to him,—a winged lion, raised on his hind legs, whose body is covered with feathers, and whose legs terminate in vulture's claws.²⁴ This subject has been often reproduced by the gem-cutters. A rough design of it is given on a


²¹ *Glyptique orientale*, Part II, fig. 37.

²² G. SMITH, *The Chaldean account of Genesis*, pp. 90, 91.

²³ LAYARD, *Monuments of Nineveh*, Second series, pl. 5.

²⁴ There has just been communicated to me a cylinder on which the dragon is represented in the shape of a serpent, and Marduk is armed with the thunderbolt, and is enveloped in a double pair of wings, as in the Nimrûd bas-reliefs.

cylinder of the *Collection de Clercq* (*Catalogue*, pl. xxxi, No. 331), and replicas of it can be examined in my work, *Recherches sur la Glyptique orientale* (Part II, p. 44 *sqq.*).

An examination of the inscription shows, at once, that this has all the importance of a royal cylinder. We can read, in the field, an inscription traced parallel with the axis, and whose confused characters, occupying the space left free by the figures, show, at the beginning, the sign , which denotes a *royal rank*.²⁵ The scribe who made use of it,—and was secretary to the chancellor of a sovereign whose name is not here expressed,—is called “Marduk-zir-idin, son of” Here I must stop, as the impression does not allow me to read the end of the inscription.

To what nation or period can we assign the two remaining cylinders, Nos. 10 and 15? Serious difficulties stand in the way of any attribution. They have no very definite character, and are evidently specimens of an art in a state either of transition or of decadence, in which various elements were combined. The Phœnicians are, of all nations, those who most contributed to this confusion: having no national art, they unconsciously combined, in the same intaglio, figures from the art of Assyria, of Egypt or some other nation: they sometimes confined themselves to tracing a name in their own alphabet on the field of a cylinder of foreign origin, thus destroying its originality. It seems to have been otherwise with the nations of Asia Minor. The Hittites have left, at different points in Asia Minor, monuments of a distinct style accompanied by characteristic inscriptions, which have furnished types that are recognizable on a large number of cylinders. Unfortunately, many of these works have come under Phœnician influence, and hence show much-altered elements. Can these two cylinders be attributed to the Hittites? Just so much as we were affirmative, in cases where in the field of the cylinders were inscribed Hittite hieroglyphs by the side of figures that could be compared to those of Eujuk or Boghaz-Keui,²⁶ just so reserved should we be when these distinguishing elements are wanting. It is true that some cylinders are so far removed from the art of both Chaldæa and Assyria that, on examining them, one may be tempted to attribute them to the nearest neighbors of these two nations; and, in fact, the great empire

²⁵ This sign is distinct from that which belongs to the ordinary seal.

²⁶ *Glyptique orientale*, Part II, p. 119.

of the Hittites was for many centuries on the borders of the Assyrian domain. The Hittite art was certainly not despicable, for the Kings of Assyria did not hesitate to borrow from it. From this mingling of cultures there may have resulted hybrid works in which we should expect to find, neither beauty of execution nor breadth of conception, but, at most, a vague reminiscence of the most characteristic traits of the two nations.

Cylinder No. 10 (composition: h. 2.3, d. 1.0 cent.) is a very rudely executed work, and recalls certain of the cylinders found at Kourion.²⁷ Can it be the product of Kypriote art? It is difficult to say. There is nothing Assyrian or Chaldæan in the arrangement of the figures or of the animals, and, if we were tempted to attribute it to the Hittites, we should be obliged to allow that the conjecture rested on negative grounds, necessarily weak.

It is the same with *Cylinder No. 15* (hematite: h. 1.6, d. 0.8 cent.): though it has a more distinctive character, no more affirmative judgment can be given on it. Works of this nature must undergo serious study before it will be possible to definitely assign to them their proper place.

It remains to speak of the flat seals, of which two examples are given on our second plate (PL. VI, Nos. 17, 18). The use, in Assyria, of flat seals in the form of cones, pyramids, and spheroids is shown by a royal decree of the 26th day of the month Tebet of the year of Masallim-Assur (790 B. C.) which bears the impress of the royal seal. Their use was continued until the time of the Seleucidæ and even later. The two seals in question may be assigned to the Great Empire of Assyria, to which belong many analogous works. The subjects engraved on them, on being compared with those of the Assyrian bas-reliefs, show that they should be attributed to the school of Kalah. On the first, No. 17 (carnelian: h. 1.7, w. 1.4 cent.), is a seated figure behind which is engraved an inscription, apparently in Phœnician letters. On the second, No. 18 (agate: h. 1.6, w. 1.2 cent.), is a priest adoring the sacred tree, above which is the symbol of the supreme Assyrian divinity.

The intaglios that have been described all belong either to the time of the Early Empire of Chaldæa, or to that of the Great Empire of Assyria, and stop at one of the great periods in the history of

²⁷ L. DI CERNOLO, *Cyprus*, pl. XXXII, No. 21.

Western Asia. There are no specimens of the dynasty of the Sargonidæ, or of later periods. Still, the collection, specimens of which have here been examined, is a remarkable one. The magnificent cylinder of Marduk-zir-idin is of great rarity: we have examined it with the greatest interest, and have sought to place it in the light it deserves: and in bringing this study to a close we most sincerely congratulate its fortunate owner, who has afforded us the opportunity of examining it.

J. MÉNANT.

ROUEN, *July 27*, 1886.

NOTES ON ORIENTAL ANTIQUITIES.

III. A GOD OF AGRICULTURE.

A god of agriculture has not, as yet, been fully recognized in the Babylonian pantheon. That there must have been a deity especially in charge of the productions of the field, is hardly to be questioned; though his rank may have been much lower than that of a god of war or of learning. The operations of plowing, sowing, irrigating and harvesting must have been carried on under the protection of some divinity, although the lists of the gods and the enumeration of



FIG. 28.—*Bibliothèque Nationale, Paris.*

their attributes found on the inscribed monuments do not give very definite information on this subject.

The two gods whose attributes and functions most relate them to agriculture are Raman (Bin) and the older Bel of Nippur. Raman is the god not only of the air and of storms, but also of the fertilizing canals. He bears, among other names, those of distributor of abundance, chief benefactor, god of fruitfulness. The ancient Bel of Babylonian mythology, not Bel Merodach (Marduk) of Babylon, was lord of the surface of the earth, and of the affairs of men; and agriculture, as well as other occupations of man, may well have been under the care of this active divinity.

Agricultural occupations are represented on a very few of the Babylonian seal-cylinders. The care of sheep and goats seems to be

represented, among other things, on two seals published by me in this Journal (vol. II, pp. 46-48). But, comparatively, very few scenes of common life are represented on these interesting objects: for the most part they have mythological subjects, gods, heroes, and worshippers. I do not know of any representation of a god of agriculture on any seal hitherto published.

One seal in the Bibliothèque Nationale at Paris (*fig. 28*) gives the operation of plowing. I reproduce it from Lajard's *Culte de Mithra* (pl. xxxiv, No. 15), and it is also given in Ménant's *Pierres gravées de la Haute-Asie* (vol. I, p. 205). I give it for the purpose of comparing the plow, held by the plowman and drawn by two oxen, with the plow as found on three other seals in my possession (*figs. 29, 30, 31*), which are, fortunately, mythological in their character.



FIG. 29.—From the Wolfe expedition.

Figure 29 represents a large cylinder of serpentine (3.4 by 2.4 cent.) with the concave outline found only in the oldest of these seals. It is in a fine state of preservation, uncommon in seals of this soft material. It represents a seated deity, with stalks of wheat rising from his shoulders, holding wheat in his right hand. In front of him is a worshipper with both hands extended in supplication toward the deity. Then follows a second worshipper bearing a plow, which is very clearly drawn, showing the construction of the share and of the jointed beam. A third personage follows, with stalks of wheat in his hand and radiating from his body. All four figures have long beards and wear caps, apparently horned. The robe of the deity is arranged in the parallel horizontal plaits so often seen, leaving the right arm exposed; while the robes of the worshippers (which apparently consist of only a skirt) fall in vertical folds, and are held at the waist by a sash whose ends fall behind.

With this seal should be compared another in my collection (*fig. 30*), of green jasper, somewhat smaller (2.9 by 1.7 centim.) and with concave surface, but unfortunately so broken away as to destroy the larger part of its three lines of archaic inscription. Here, again, is a seated divinity, with wheat coming from his shoulders, and a wheat in his right hand. If there were any doubt about the wheat in *figure 29*, the beard at the end of the ears in *figure 30* would remove it. Before the deity is a stand, or altar, and on it a dish and perhaps a bird: then comes a figure holding a plow by the handles. He seems to have left his gifts (a bird (?), cakes (?), and a drink-offering) on the altar, and to have returned to his plowing, while the deity looks on benevolently, holding out the emblem of prosperity. Then follow the three lines of inscription, of a very old style, too nearly lost by the fracture to be legible. I am not sure that the



FIG. 30.—From the Wolfe expedition.

seated deity is not a goddess: the female counterpart of the god on *figure 29*.

It is not easy to say what deity is represented by this god of the wheat-field. It is too much to identify him with either Raman or Bel, though it is difficult to say what other god would be suggested. It is a matter for question, whether another not uncommon representation of a god with waving rays proceeding from the shoulders, which also suggest wings, is this same god with the wheat about him. He often appears in connection with an attendant opening a door, and is sometimes figured with a low mound (mountain?) on each side of him. Cf. Ménant, *Pierres gravées*, vol. I, figs. 67, 68, 69, 71, 72. George Smith, in his *Chaldean Genesis*, makes the untenable suggestion, that these seals represent the building of the tower of Babel.

One is reminded, by this god of wheat, of the Hittite representation of the god Samdan (?) at Ibriz (W. M. Ramsay, *Archäol. Zeitung*,

1885, No. 3, pl. 13). He is represented as bedecked with clusters of grapes, and holding in his hand a bunch of wheat.

Another seal in my possession, if it does not belong to this series, yet cannot be overlooked in the study of a deity or deities of agriculture. It is represented in *figure 31*. The seal is of a rich dark-blue lapis lazuli, and is perfect, except for the ordinary spots of iron pyrites and a slight flaking of the stone in front of the god. Its size is 2.7 by 1.5 centimetres. The deity is not the seated god we have figured above, but a god whom the cylinders represent a hundred times, robed in a loose open garment extending below the knee, and with his right leg bare and lifted up, the foot resting on a stool, or prominence. He is bearded, has the head covered with the horned cap, and holds in his left hand a sceptre, or baton, adorned at the end with a figure not easy to recognize. In his right hand he carries a plow, holding it



FIG. 31.—From the Wolfe expedition.

by the beam. I know of no other instance in which this very familiar deity, or any other, in fact, is represented as holding a plow. I assume this to be the same deity as usually appears in this attitude, as it is natural to believe that each deity would have a conventional representation, which would be varied only in minor details.¹ His dress is always the same, his foot is always raised and often rests on an animal,—a bull, a lion, or an ibex, or even a sphinx: he sometimes leads a bull by a rope, and sometimes holds in his hand a small long-tailed animal. More frequently he holds in his hand what appears to be a sharply notched knife, but which may be a club set with flints, like a certain ancient Mexican weapon, or possibly a palm-branch.

¹ He is seen in Cullimore, *Oriental Cylinders*, figs. 29, 44, 45, 49, 52-55, etc.; Lajard, *Culte de Mithra*, xxxviii, 1, 2, 3, 5, 6, etc.; De Clercq, *Catalogue raisonné*, figs. 152-157, 159, 160, 163-175; Ménant, *Glyptique orientale*, pl. iv, 3-6 and pp. 163-5, where the female form of this deity seems to be figured.

Often he holds an object which has been called a thunderbolt, forked into two zigzag branches. Sometimes he holds the scimitar-like weapon which Bel uses against Tihamat. In front of him is generally seen the worshipper bearing a victim, although the worshipper with a victim often appears before a seated divinity. On account of the "thunderbolt" he has been identified by Lenormant and Sayce with Raman (Bin); and the plow which he holds, in the seal here figured, would be appropriate to Raman. I doubt very much that he can be identical with the seated god in the other seals here figured. In front of the deity, on the seal we are now considering, are seen three upright objects, which appear to be altars, with the crescent above them. A worshipper is pouring an oblation upon them, and behind him is a



FIG. 32.—Collection de Clercq.

second worshipper, or an attendant. The inscription, which is in two lines, Mr. Pinches kindly reads for me, as follows :

“A-mur(or A-hi)-Shamash,
sis(ahu)-da-gi.”

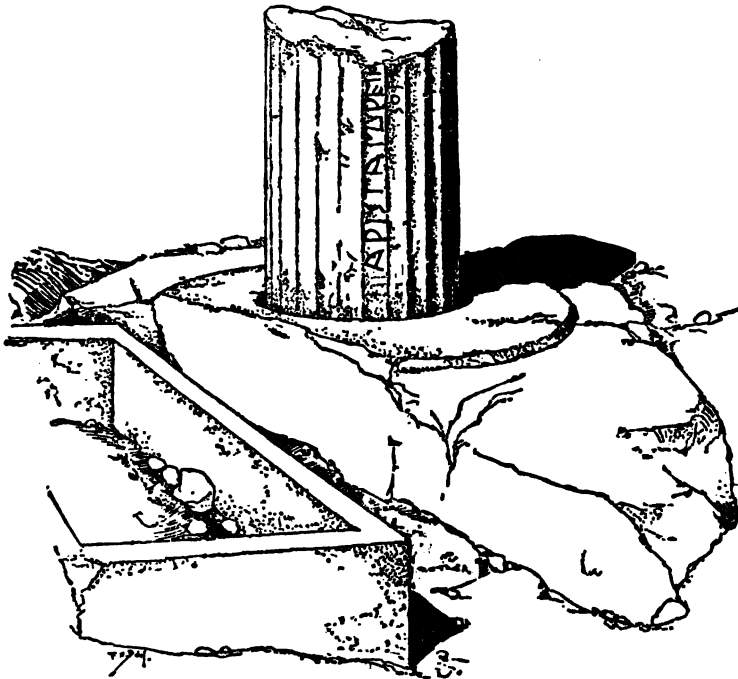
The first line gives the owner's name, Amur-Shamash (*i. e.* “I have seen the sun-god”), while the second perhaps gives his occupation, in Akkadian. Mr. Pinches would date it about 1800 B. c.

Since the above was written, I have received the second *livraison* of the Catalogue of De Clercq's magnificent collection of more than four hundred Babylonian and other cylinders. Among them is one (*Collection de Clercq*, No. 140) which belongs to the same type as *figs.* 29, 30, representing a god of agriculture, although the plow is not given. We reproduce it in *figure* 32. The deity holds in his right hand a stalk of some kind of grain, apparently the seven-rowed (Egyptian) wheat,—the same as in the hand of the Hittite god at

Ibrtz,—and a stalk of the same grain rises from each shoulder. The worshipper before him has two stalks of wheat rising from his head-dress, a stalk of wheat from each shoulder, and a branch of some other plant (dates?) from his waist. At his feet, on one side is a bunch of three stalks of wheat, and on the other a branch, perhaps of dates. The significance of the other two large figures is not apparent; but the small figure behind them is probably that of the owner of the seal. The name of the owner, as read by Oppert, is *Dada, the measurer*; which may imply that the owner of the seal was engaged in the business of measuring the grain and fruit collected as taxes, or sold.

WILLIAM HAYES WARD.

A DORIC SHAFT AND BASE FOUND AT ASSOS.



Archaic Ionian Column. [of Clench]
—Street of Tombs, Assos.

FIG. 33.

One of the most interesting monuments unearthed in the Nekropolis of Assos is the stump of an archaic Doric shaft: the only known example of a column of that order provided with an Egyptian base.¹

¹It is to be observed that the Attic bases of late form, which appear in the engraving of the two extremely ancient Doric columns found on the Akropolis of Athens (published by Ludwig Ross in vol. XIII of the *Annali dell' Instituto*, Roma, 1841, tav. c) do not belong to these shafts, but were added through an error, explained in the letter-press. As these columns were free-standing, they were,

Its relation to the earliest development of Greek architecture makes it a striking parallel to the proto-Ionic capital from Neandrea.² Both are important illustrations of the methods by which the Greeks simplified and improved architectural details derived from older civilizations. Each is a link in a long chain, and hence the presentation of each requires that more attention be devoted to the adjoining links, to the antique remains of similar character, than is possible in the narrow limits of a Report on the excavation of one site. The writer trusts that this consideration may be held to justify the separate publication of these results of the exploration of Assos and the southern Troad, undertaken by the Archæological Institute of America.

The column shown in *figure 33* was found during the digging of the second year (1882). It stood by the side of the main road which led through the burial-ground from the principal western gate of the

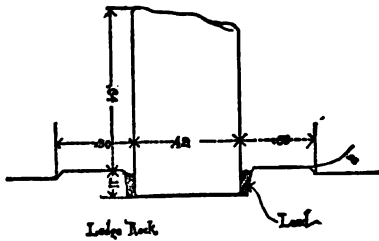


FIG. 34.—Section of the Doric shaft and base.*

city, and was distant about 130 metres from the fortifications. At this point, the native rock rises almost vertically, having been fully 1.2 m. above the pavement of the ancient street which passed close to it. When found, the column was but little below the surface of the accumulated earth. The rock was here levelled and cut

to a broad base, in the centre of which was sunk a deep socket of the same plan as the lower diameter of the shaft (*fig. 34*). Into this the column was inserted, and set by a lead casting. A considerable part of this lead had been picked away by despoilers before being covered by the accumulating débris, and it is fortunate that the stone itself had not been entirely shattered in order to get at the six or eight pounds of metal which remained around and beneath it. Among the ruins of

without doubt, originally provided with bases; but at all events these members have not been found.

The only Greek Doric base known to the writer has little or no bearing upon the development of the style: it is that of the Column of the Naxians at Delphi, discovered and published by M. P. Foucart in his *Mémoire sur les ruines et l'histoire de Delphes*; *Archives des Missions scientifiques et littéraires*: Deux. Série, vol. II: Paris, 1865.

² J. T. Clarke, *A proto-Ionic Capital from the site of Neandrea*, in the *Amer. Journal of Archaeology*, vol. II, pp. 20, 186.

* More exact measurements are given on the following page, in the text.

Assos those stones still exposed above-ground which were united by iron cramps have, almost without exception, been broken by the sledge-hammer, the employment of which for the purpose of obtaining such lead castings is familiar to the wandering gypsy-smiths in Asia Minor. So securely was the column attached to the bed rock that, although it is beyond question the oldest of all the monuments discovered in the Nekropolis, it is the only one which has not been overthrown. The shaft was irregularly broken off at a height of about 0.65 m. from its base. No remains of the upper part were brought to light by the further excavations in the vicinity.

During the Roman dominion, a segment of the base was cut away to make room for a monolithic sarcophagus,³ the approximate date of which is evident from its having contained, together with crumbling bones, the sherds of a vessel of red pottery ornamented with figures in relief,—the well-known Samian ware. This sarcophagus was buried beneath the surface of the earth, no respect being paid to the integrity of the column, which must, at that time, have been at least five hundred years old. The remaining part of the base, although much worn and fractured, shows the stone-cutting to have been careful and accurate: the bevelled edge is perfectly regular, and the distance from its upper circumference to the arrises of the shaft is on all sides exactly 0.298 m. The lower diameter of the base is 1.06 m.; its height 0.034 m.

The shaft is 0.425 m. in diameter. The stone of which it is cut is the same andesite as the bed rock. The resistance of this material to weathering depends greatly upon the stratum from which it is quarried, and the degree of exposure to the elements. Thus, some of the stones of the lower wall of the great eastern gate, which probably dates from the fourth century, having been subjected to the percolation of water since the time of the Turkish occupation, may be easily crumbled with the finger nail. The archaic column, on the other hand, has hardly been weathered at all: its arrises are perfectly sharp, and the letters engraved upon it as legible as when first cut. The channels, of an approximately segmental plan, are twenty-five in number. Their extreme shallowness, like the slight elevation of the base cut upon the bed rock, is sufficiently accounted for by the difficulty of

³No. 76 of the list and general plan which will be given in the second Report on the Excavations at Assos.

working this exceedingly hard and gritty stone. Recent experiments made upon the andesite of Assos by a lapidary, under the supervision of the writer, have shown it to be one of the most intractable materials ever chosen for architectural details.

The number of the channels, unique among the remains of antiquity, is to be explained by the entirely isolated position of the column. As it stood in no relation to the axes of a building, it was not absolutely necessary to make the number of channels divisible by four,⁴ or even the opposite sides of the column symmetrical,⁵ and the channels consequently of even number. Within these limitations, the subsequent usage of the Greeks in channelling their columns seems to have been determined solely by considerations based upon the absolute size of the shafts, and the distance from which they were generally to be seen. The simile of Aristotle, in his *Ethics*,⁶ from which is derived our knowledge of the technical term employed for this detail, clearly shows that the *rhabdosis* was regarded by the architect, not as an independent feature of the design,⁷ but

⁴ All the multiples of four, from sixteen to thirty-two, appear in the buildings of Greece. Twenty-eight and thirty-two channels are, however, exceedingly rare: the former number being known to the writer only by the fragment of a Doric column found by him among the foundation stones of the theatre of Ephesos; the latter only by two Doric drums on the island of Samos, which have been described by L. Ross, in his *Reisen auf den griechischen Inseln des aegaeischen Meeres*: Stuttgart, 1840-43. These last were seen and measured by the present writer in 1879. They had then been removed from their former position and built into the wall of a vineyard. An approximate diameter is 1.04 m., showing that the building to which they belonged was of considerable size: at least half as large again as, for instance, the chief temple of Assos.

⁵ Eighteen channels (the only number not a multiple of four known to have been employed by the Greeks) are to be observed in the pronaos of the temple of Assos. The peculiar considerations which led to the adoption of this number have been set forth in the *Report on the investigations at Assos, 1881*: Boston, 1882, p. 89.

⁶ *Ethika Nikom.* x. 4. 2. The commentary upon this passage, attributed to Eustratios, betrays a want of understanding of the word *ῥαβδόσις*, which is explained: *τὴν κατὰ μῆκος πῆξιν, ἥτις γίνεται, ὅταν πρὸς ὀρθὰς γωνίας ἰσθηται*. Still, it is not surprising that a Byzantine ecclesiastic of the twelfth century should have been wholly unacquainted with the details of antique architecture, and have supposed that the *rhabdosis* signified the erection of the column to a position exactly vertical.

⁷ Certain writers on Greek architecture fancifully assume this striation of the shaft to have been derived from, or at least to be analogous to, the ribbed stems of umbelliferous plants, notably the *Heracleum silphium narthex* (K. Bötticher, *Die Tektonik der Hellenen*: Ed. 2: Berlin, 1874, vol. 1); or the cracked bark of the trunks of trees (P. F. Krell, *Geschichte des dorischen Style*; Stuttgart, 1870: and many

simply in its relation to the general effect of the building.⁸ The number of channels is thus no indication of age, as has been so often assumed. For instance, the columns of the archaic temple of Korinth, of large dimensions and situated in the plain, have twenty channels; while the small shafts of the interior of the temple of Aigina have only sixteen, as have also those of the much more recent temple of Sunion, which stand upon the narrow summit of an eminence, forming a landmark for mariners doubling the cape. All the instances of sixteen-channelled shafts, which are exceptions to the general usage, are to be explained by these considerations. The best parallel to the memberment of the Assos column is presented by the forty-four channels of that of the Naxians at Delphi (cf. Note 1), both intended to be seen from immediate proximity. It is evident, however, that, at the time when the Assos monument was erected, the practice of channelling had not been reduced to the system which rendered the Doric columns of later ages so regular in detail, but, frequently, so mechanical and uninteresting. The artistic effect of channelling a cylindrical shaft, thus emphasizing the line of support, had undoubt-

others). But that the Greeks attached no symbolical significance, no peculiarly architectural character even, to the channelling, is evident from the employment of the adjective *ραβδωτός* for any striation,—such as the furrows of sea-shells (Aristotle, *Hist. Animal.* iv. 4. 3), the ribbed ornamentation of drinking-vessels (Polemon in Athenaios, xi. 67), and even the stripes of garments (Xenophon, *Kyr.* viii. 3. 16).

⁸ In the fourth chapter of the tenth book of the *Nikomachean Ethics*, Aristotle reviews his analysis of pleasure, and by the synthetical method determines its definitions. He explains that it is something complete in itself; not something gradually attained, but a consciousness of perfection which is independent of the condition of time. Hence, pleasure is not motion, inasmuch as this requires time, and presupposes some higher end, being thus, in itself, incomplete. This he illustrates by a comparison with architecture, which is perfect when it has produced that at which it ultimately aims, while its separate processes are imperfect, and differ entirely from each other. In specifying the details of the building of a temple, and in explaining the differences observable between them, he says: *ἡ γὰρ τῶν λίθων σύνθεσις ἐτέρα τῆς τοῦ κίονος ραβδώσεως, καὶ αὐταὶ τῆς τοῦ ναοῦ ποιήσεως.* Did the great philosopher intend, in thus contrasting the fitting together of the stones with the channelling of the column, to illustrate also the distinction which is to be made between the mechanical juncture of the drums, on the one hand, and their incorporation into an æsthetic unity by this architectural expedient, on the other? He probably did not. The marked distinction which is to be made between these two processes may have led to the instinctive choice of them as similes; but it is plain from the details of the construction subsequently adduced,—namely the entirely unrelated krepis and triglyph,—that this idea was not definitely present in his mind. Such æsthetic subtleties would be less natural to the ancient Greeks than, let us say, to the modern Germans.



FIG. 35.—*Inscription on the Doric shaft.*

edly been observed by the primitive stone-cutter upon other columns, and imitated by him in a perfectly natural manner. He divided the circumference with a unit of measurement determined in entire independence of the axes. This proved to adjust itself most readily to twenty-five divisions of equal width; and the separating lines were cut as arrises,—no attention being paid to the odd number, or to the want of that symmetry which results from a correspondence of the channels to one or two parallel faces. From this peculiarity of the channelling, it is to be inferred that the abacus of the capital was not of a square but of a round plan, as is the case with the archaic columns found on the Akropolis of Athens (cf. Note 1).

There does not remain enough of the shaft to prove with certainty the apparent lack of an entasis. This refinement could hardly be expected, as the columns of the chief temple of Assos itself, though certainly of much later date, are straight-lined. Moreover, the small monument was

not exposed to be seen from a standpoint much below its base ; there was thus little or no optical illusion, and consequent need of a correction of this kind.

The great age of the shaft (evident also from architectural considerations) is certified by an archaic inscription engraved in two of the channels (*fig. 35*). This inscription has been published by Dr. Sterrett,⁹ who assigns it to the sixth century, and reads: ΑΡΙΞΤΑΝΔΡΕΙ[Α?]. The last letter of the first line is, however, undoubtedly K. Professor Ramsay¹⁰ hence suggested 'Αριστάνδρη κ[. . . ; but, owing to the improbability of this Ionic form occurring at Aiolic Assos, has since, with the writer, preferred 'Αρίστανδρε Ικ[. . . ; *exempli gratia*, 'Ικτινίου. This last reading has great weight of probability. Epitaph inscriptions not unfrequently began with the vocative ; and, while neither of the feminine forms have been known to occur, no less than six men by the name of Aristandros are known from antiquity, the chief among these being Asiatics and Islanders. Furthermore, although of course not impossible, it would have been entirely exceptional, among the remains of Assos, for so prominent a monument to have been dedicated alone, or, in the first word, to a woman. The lines are *boustrophedon*. Of the second only the termination ΚΙΟΞ remains. The low position of these letters upon the stone (beginning 0.11 m. from the base) warrants the assumption that the inscription extended at least above the middle of the column. It would have been quite as easy to read letters engraved even at a height of two metres, as those near the bottom of the shaft ; and the most natural method of inscribing the epitaph would be to extend the words along the greater length of the channel. That this was the usual relation is apparent from the noted inscription upon the *Colonna Nania*,¹¹ and from that upon the round

⁹ J. R. S. Sterrett, *Inscriptions of Assos. Papers of the Archaeological Institute of America*. Boston, 1885.

¹⁰ W. M. Ramsay, *Notes and Inscriptions from Asia Minor*. VI. *The Inscriptions of Assos*, in the *American Journal of Archaeology*, vol. I. 2. Baltimore, 1885.

¹¹ Chief among the free-standing votive columns known is the archaic *Colonna Nania*, from the Island of Melos: first described and engraved by G. F. Zanetti, *Due antichissime greche iscrizioni*, Venezia, 1755; and since often republished, appearing in the *Corpus Inscr. Graec.* vol. I, no. 3. Neither the capital nor the base of this column have been found, but apophyges at either end of the shaft prove the original existence of both. The celebrated inscription, occupying three-quarters of the total length, is engraved in two of the channels.

stele found by Finlay on the island of Aigina.¹² It is hence to be assumed that we have recovered less than one-eighth of the inscription,—even supposing it to have been restricted to two channels. No importance is however to be attached to this, beyond the consideration that an inscription of such length must have contained more than the name and patronymic of a single individual, which are all that appear upon the other tombstones of the Nekropolis.

The indications to be derived from the length of the inscription; from its commencing with the vocative; and, above all, from the situation of the column directly upon the native rock (so that no bodies could have been buried beneath it, as beneath every other sepulchral monument found at Assos); give some weight to the supposition that the column may have been erected, and the epitaph inscribed, as a memorial to a number of persons whose bodies had not been recovered for sepulture: persons, for instance, who may have been lost at sea, or have fallen in battle, and were thus honored by their relatives or by the Demos. Such were many of the sepulchral steles of the ancients. 'Ο τύμβος οὗτος ἔνδον οὐκ ἔχει νεκρῶν. (*Anthol. Palat.* VII. 311). Epitaphs of this kind have been preserved in great number in the *Anthology*.¹³ Still, it must be admitted that enough does not remain of the Assos column to seriously argue that we have here to deal with a cenotaph. The side of the stone bearing the inscription has been broken away fully ten centimetres lower than the rest, as if wantonly mutilated. With a few more letters its significance would have been clear.

The original height of the shaft in proportion to its diameter was without doubt considerably greater than was customary in the functional supports of the style. A comparison with the archaic free-standing columns hitherto known (among which, besides the *Colonna Nania* and the above-mentioned two archaic columns found upon the Akropolis of Athens, is a Doric shaft standing in the Athenian ceme-

¹² This archaic shaft, unchannelled and with a dedicatory inscription, engraved in four lines along almost its entire length, was first published by W. M. Leake, *On an inscription found in Aigina*, in the *Transactions of the Royal Society of Literature*, vol. II, xx: London, 1834. It was subsequently redrawn for the *Expedition scientifique de Morée*: Paris, 1831 etc., vol. III, pl. 46. The inscription is given in the *C. I. G.*, vol. II, appendix 2138, d.

¹³ *Anthol. Palat.* VII. 74, 272, 273, 274, 397, and others. The first of these was written upon the monument erected by the Magnesians above the empty tomb of Themistokles. Cf. Plutarch, *Themist.* XXXII. 4.

tery before the *Dipylon*¹⁴) leads to the assumption of a height of about six and a half diameters,¹⁵ or two metres and three-quarters. This estimate can hardly involve an error greater than 0.2m. A column of this height would have just sufficed to elevate an *agalma* above the reach of passers-by. It is clear that this was the purpose of the support. Upon vases, reliefs and coins, too numerous to be specified, free-standing shafts are represented, upholding an image, a vase, or other votive offering; these being generally of a symbolic character, as, for instance, the two cocks significant of the palaistra, the Nikes, or the owls of Athena, seen on almost all the Panathenaic vases. The two well-known columns with triangular capitals, standing on the side of the Akropolis of Athens, above the theatre of Dionysos, supported tripods.¹⁶

During the earliest ages, diminutive columns, generally of the Doric style, were employed to uphold the *ἱεραὶ Παρθένου*.¹⁷ But the most

¹⁴ The only free-standing shaft erected as a sepulchral monument that has hitherto been known, is a Doric column elevated upon a round pedestal, and still standing in the cemetery before the *Dipylon* of Athens,—inadequately published, without illustration, by A. S. Rhousopoulos in the *Ἐφημερίς τῶν φιλομαθῶν, Ἀθήνησι*, 1870, No. 739; and by R. Schöll in the *Bullettino dell' Istituto*, Roma, 1870, No. XIII. These accounts disagree in important particulars: the former, for instance, stating that the upper and lower circumference of the shaft are respectively 0.88 m. and 1.0 m.; while the latter affirms the shaft to be *sensu la solita reductione*. The writer, who has himself examined the monument, is indebted to Dr. Sterrett for a drawing of the lower part of the shaft and of its peculiar support.

This column is of interest in the present consideration, from the fact that it stands, not upon a true base, but upon a round pedestal with terminal and socle mouldings. Nevertheless, as the monument is some two or three hundred years more recent than that of Assos, and consequently belongs to a period when the art of Greece was in its decline, and when the archaic and primitive features of the leading styles had been forgotten, it naturally cannot be compared, in historical significance, with the column of the sixth century from provincial Assos.

¹⁵ This is a weighted average of all the examples known, and closely agrees with the proportions of the column in the Athenian cemetery. This last monument, the best parallel in this respect, is stated by Rhousopoulos to have been 2.03 m. high, with a lower circumference of 1.0, and a base 0.33 m. high. Schöll assigns to it a total height of 2.34 m.

¹⁶ E. D. Clarke, *Travels in various countries of Europe, Asia and Africa*: Cambridge, 1810-23, vol. II, part 2. Also *C. I. G.* No. 227 b. Many representations of tripods supported upon columns appear upon vases and reliefs; a number of these have been collected by F. Wieseler, *Das Satyrspiel*, in the *Göttinger Studien, zweite Abtheilung*: Göttingen, 1847.

¹⁷ This is proved by Ross, *Bericht von den Ausgrabungen auf der Akropolis von Athen*, in his *Archäologische Aufsätze*: Leipzig, 1855-61. The inscriptions of the *Colonna*

striking parallel to the sepulchral column of Assos is supplied by the descriptions of the famous tomb of the orator Isokrates, erected near the Kynosarges. This was a round column (*κίων*)¹⁸ surmounted by the figure of a siren.¹⁹ The dimensions of the shaft and of the statue (respectively thirty and seven cubits), though much greater than those of the Assos column, and, indeed, exceptional during all Greek antiquity, agree with the representations of such monuments; and may serve to give an idea of the customary proportion between the support and the *agalma*. The loss of the capital of the column at Assos is to be regretted, not only on account of its independent archi-

Naxia, the two archaic shafts from the Akropolis of Athens, and the round stele from the island of Aigina, before mentioned, all refer to the dedication of the votive offerings which were placed upon these supports. The same is true of the inscription in three of the flutes of the drum of an Ionic column from the Peloponnesos, given by P. M. Paciandi, *Monumenta Peloponnesia*, Romae, 1761, vol. I; and reprinted in the *C. I. G.* No. 24.

¹⁸ Before the employment of stone columns in the temple architecture of Greece, the word *κίων* designated the great posts of wood which served as the supports of the timbered ceilings. In later times it was restricted, by common usage, to shafts of round plan, while the word *στήλη* signified a square, free-standing pillar. The exceptions prove this rule. Careful writers, when using either of these terms in a sense different from that usually attached to it, qualify it by an adjective. Thus, Plutarch (*Aem. Paul.* xxviii) speaks of a *κίων τετράγωνος*, while the obelisk in the Hippodrome of Constantinople, being too large to be termed a stele, is called *κίων τετράπλευρος* (*Anthol. Palat.* ix. 682). A small round cippus, probably without a capital, is called *στήλη περιφέρης* by Pausanias (ii. 12. 5). The exact determination of the use of these words is a point of great importance in the study of ancient architecture.

The learned authors of Liddell and Scott's Greek Lexicon (seventh edition, 1883) remark, in their definition of *κίων*, that the word is "expressly distinguished from *στήλη*" by Andokides (vi. 15). The passage in question throws, however, no light whatever upon the distinguishing differences between these two kinds of shafts. The orator merely relates that Diokleides, while witnessing the mutilation of the hermae, stood between a certain column and a certain stele.

¹⁹ Plutarch, *Vita decem rhet.* iv. 25. The same statements concerning the column are made by the ancient author of the anonymous life of Isokrates (ii. 96., ed. Westermann). Philostratos (*Vitae sophist.* i. 17. 1) in describing this monument uses only the general term *σῆμα*.

A siren was placed also above the tomb of Sokrates (Anonymous *Vita Sopk.* i. 74, ed. Westermann), above that of the poetess Baukis (Erinna, frag. 5: Bergk, *Poet. lyr.* ed. 1876, p. 927,—from *Anthol. Palat.* vii. 710), and above that of Kleo (Mnasalkas, frag. 17, from *Anthol. Palat.* vii. 491). Alexander, as is well known, erected statues of sirens upon the funeral pyre of Hephaistion (Diodoros, xvii. 115. 4). Images of sirens, placed upon the summit of free-standing columns and steles, are frequently shown by vase-paintings and other representations.

tectural significance, but because the dowel-holes upon its abacus would undoubtedly have given some indications of the nature of the image which it supported.

Architectural history has long led to the conclusion that the characteristic features of the Doric shaft were derived by the Greeks from the banks of the Nile. Since its demonstration, through the first adequate surveys of the monuments of ancient Egyptian architecture, no valid objection has been raised against this derivation, of which the present discovery may be considered a direct proof.

So striking is the resemblance of the channelled shafts of Egypt to those of Greece, that Jomard,²⁰ who first called attention to the proto-Doric character of the columns of Beni Hassan, felt it necessary to explain that they could not have been the work of Hellenic architects. In the supports of the rock-cut tombs of Beni Hassan, and in those found among the ruins of Calabsheh, Amada and other places, there is to be recognized a fixed architectural system, evidently determined by long practice, and, with but slight variations, adopted throughout Egypt as an established order. The columns of the first-named monuments may be considered as typical of this formation, not inaptly termed by Lepsius *l'ordre des colonnes-piliers*.²¹

The manner in which the number of channels was determined is made evident by the existence, almost side by side, of supports illustrating the various stages of development. The multiplication of the facets was brought about by chamfering the corners of a square pier, which was thus transformed into an eight-sided, and, when the process was repeated, into a sixteen-sided shaft. It was found, however, that the column of sixteen-sided polygonal plan had angles much too obtuse to give the desirable play of light and shade, and the natural expedient of grooving the narrow facets was hence adopted, the edges being sharpened into arrises, and the surfaces becoming channels.²² A portion of the original square pier was left

²⁰ *Description de l'Égypte*: Paris, 1821, vol. iv.

²¹ K. R. Lepsius, *Sur l'ordre des colonnes-piliers en Égypte*, in the *Annali dell' Instituto*, vol. ix, Rome, 1838.

²² The argument of Semper (*Der Stil in den technischen und tektonischen Künsten*, 2d. ed., München 1878), that the channels of the Doric column resulted from an imitation of long strips of metal soldered together around a core of wood, appears inadmissible; and his remark: "the number of the channels increases in exact proportion with the absolute dimensions of the shaft, inasmuch as the grooving of the strips is dependent solely upon the character and thickness of the metal" (vol. II,

at the top, as an abacus; while the shaft was provided with a broad and flat base, projecting far beyond the lower diameter of the column. This sixteen-sided, channelled support was in general use during the twelfth dynasty, which is held by Mariette to have ruled during the twenty-ninth century B. C., and, even according to the calculations of Lepsius which place it at the latest possible date, was still some thousand years before the Trojan war.

It is not here necessary to bring forward proofs of the intimate connection of the Greeks with the inhabitants of Egypt, especially after the seventh century B. C., the period when the most important advances were being made in Hellenic architecture. The researches of modern Egyptologists have shown that, after the age of Psammetichos, no great work of the Egyptians could have remained unknown to the Greeks. The Egyptians had been, for centuries, the greatest masters in the art of stone-cutting which the world has known, while in this branch the Greeks had then everything to learn. The tradition that squared stones were first employed in Greece by the Phœnician Kadmos while building the walls of Boiotian Thebes,²³ is a reminiscence of this influence. The Egyptian origin of many of the methods of quarrying, cutting and lifting large blocks of stone, in use among the Greeks, becomes more and more certain as our acquaintance with the architectural remains of these countries increases. To take one instance among many: the peculiar method of employing the lewis, observable in early Hellenic buildings (witness the temple of Assos), is the same as that which appears upon Egyptian reliefs, and is recognizable among the débris of Egyptian quarries.

Thus, in the design and execution of stone supports, the architects of Greece, after the seventh century, had no need to make independent experiments. It was not necessary for them to pass through a development corresponding to that displayed by the square pier, the eight-sided, the sixteen-sided, and the channelled shafts of Beni Hassan. It is not probable that the octagonal shafts found at Troizen²⁴

p. 380): is sufficiently disproved by the many channels of the small columns of Delphi and Assos. Indeed Semper, while so clearly setting forth the development of the Ionic capital, is most unsatisfactory and contradictory in his account of the derivation of the forms of the Doric column: even going so far as to assume the supports of Beni Hassan to be either archaistic or debased (vol. I, p. 392), and to doubt the truth of there having been any historical connection between the primitive architectural styles of Egypt and Greece (vol. II, p. 332).

²³ Pliny, *Hist. Nat.* VII. 57. 5.

²⁴ W. Gell, *Itinerary of the Morea*: London, 1817.

and the drums of the same plan from Bolyrnos²⁵ antedate the introduction of the Egyptian proto-Doric column, in the same way as do the well-known supports of the Tholos of Atreus and that shown on the relief of the Gate of the Lions at Mykenai. Pausanias (II. 31. 6) speaks of a temple at Troizen as one of the most ancient which he saw in Greece. But this passage, written during the second century A. D., though it certainly attests the great relative age of the building in question, can by no means be taken as an evidence that these columns, the very identity of which is not assured, are older than the seventh century B. C., and consequently could not owe the peculiarity for which they are remarkable to an imitation of the architectural details of Egypt. The shape of the columns of Troizen and Bolyrnos, sufficiently common in Egypt, is rather to be taken as an indication that the designers of the earliest stone temples of Greece were uncertain which to choose among the three varieties of supports presented by the tombs of Beni Hassan. Were it nevertheless to be assumed that these archaic Greek monuments display no foreign influences whatever, the appearance of octagonal pillars in connection with them would, of itself, by no means suffice to prove that an independent Hellenic development determined all the features of the Doric column, which was of such marvellous perfection even in the most ancient and most primitive temples of the style. Moreover, the twenty-five channels of the shaft found at Assos make it extremely improbable that the sixteen-fold striation had been independently developed by the Greeks. As has already been mentioned, the irregular number shows that the stone-cutter imitated, from some model, the general effect of channelling, without understanding the significant artistic traditions which were so clearly pronounced and so invariably maintained in Egypt, where this model originated in that treatment of the facets first devised to sharpen the angles of the sixteen-sided prism which had resulted from chamfering the corners of a square pier. Had the Assos column been the direct outcome of the evolution which determined the order of the pier-columns, it would, in all probability, like them have presented a number of channels divisible by four.

How closely the Egyptian base was imitated, will be made plain

²⁵ L. Ross, *Reisen und Reiserouten durch Griechenland*. Vol. I. *Reisen im Peloponnes*. Berlin, 1841. Neither the remains from Troizen (Damala) nor those from Bolyrnos have ever been drawn. Excavations at these ancient sites are greatly to be desired.

by a comparison of the stump found in the Nekropolis of Assos (*fig. 36, A*) with one of the interior shafts of the north-western tomb of Beni Hassan²⁶ (*fig. 36, B*), drawn with the old-fashioned *modulus* on the same scale. For such free-standing columns the channelled shaft and the broad base of Egypt were admirably fitted. These features were probably adopted, without essential change, throughout Greece. But, with the employment of the base in the functional supports of a

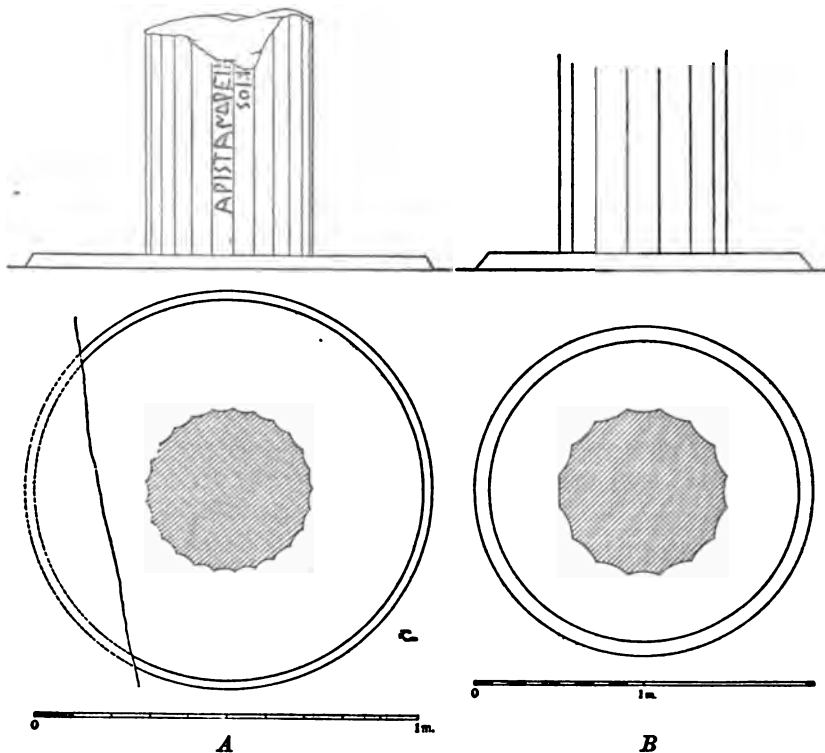


FIG. 36.—A, plan and elevation of the Doric shaft and base at Assos.

B, plan and elevation of a shaft and base from a tomb at Beni Hassan, Egypt.

²⁶The measurements adopted for this illustration have been taken from the monograph of Lepsius, quoted above. That publication was based, in regard to the details in question, not only upon the previous surveys of Beni Hassan made by the French expedition, by Rosellini (*I Monumenti dell' Egitto e della Nubia*: Pisa, 1832-44), and by Wilkinson (*The Architecture of ancient Egypt*: London, 1850, pl. 2), but also upon the inedited drawings of a Russian architect, M. Jefimoff. Lepsius makes, however, the curious error of placing the arris, not the channel, in the axis of the abacus; cf. pl. xxxv. That this is not correct is evident from the drawings given by other authors (instance Rosellini, *Atlas*, vol. II, pl. 3) and especially from photographs.

building (notably in connection with the plan of the primitive temple *in antis*), a practical disadvantage made itself felt; one so serious that, in avoiding it, the appearance of the column was entirely changed. This was the interference of the projecting plinths with the passage through the intercolumniation. The slight elevation of the bases of Beni Hassan, like that of the one found at Assos, is to be explained by the extreme difficulty of cutting this member from the native rock. It is evident that, when such a base was formed of a separate stone slab, this must have been made of much greater thickness in order to bear, without cracking, the weight placed upon it. The proportional thickness thus determined may, in the buildings of small dimensions customary during the earliest ages, be estimated to have fully equalled the height of the upper step of later Doric temples. This assumption is borne out by the oldest and most carefully drawn representation of archaic Doric structures, that upon the well-known François vase.²⁷ The buildings here shown (for instance the house of the goddess Thetis, which is characterized in every way as a temple) have Doric columns with bases of considerable projection: straight-edged like those of Egypt, but higher and unbevelled. That this base was held by the designer to be an indispensable and characteristic feature, is evident from its being repeated in all the scenes where Doric columns were introduced. Nor is such a member shown upon the François vase alone.²⁸ In the archaic art of Greece channelled columns are frequently, nay generally, represented as standing upon bases of rectilinear outline.²⁹

In the *Denkmäler aus Aegypten und Aethiopen* (Berlin, 1849-59, vol. 1), Lepsius ascribes somewhat different dimensions to this column; the projection of the base, from the shaft to the upper edge of the bevel, being scaled as 0.37 m.

²⁷ *Monumenti inediti*, vol. iv, Roma, 1844-48, pls. LIV, LV.

²⁸ Compare the important representation upon the vase referred to in Note 37: furthermore, the bases of the channelled Doric shafts shown in E. Gerhard, *Auserlesene griechische Vasenbilder*; Berlin, 1839-58, vol. ii, pl. 143; vol. iv, pl. 293; and, especially, pl. 281, Nos. 1, 2. The majority of the Panathenaic vases in the British Museum show Doric columns with bases.

²⁹ The wide distribution of such architectural forms throughout the ancient world is attested by the appearance, among the remains of Persian constructions referable to the age of Cyrus, of a base of precisely the same character as those of Beni Hassan, and as that now discovered at Assos. Compare the illustration published by M. Dieulafoy, *L'Art antique de la Perse; Achéménides, Parthes, Sassanides*: Paris, 1884, pl. XII and fig. 28. The materials as yet available for comparison do not suffice for us to decide with certainty whether this feature was derived by the well-trained architects of the Achaemenidae from the banks of the Nile, or from the coasts of

As illustrated in *figure 37*, the projecting stones, *AA*, would have greatly interfered with the passage. Such an obstruction had been no disadvantage before the closed tombs of Beni Hassan, but upon the threshold of the Hellenic temple it would have been intolerable. Nothing could be more natural than to fill out the narrow space between the sides of the bases, *B*, so connecting the separate blocks as to form a continuous plinth: *the common base of all the columns*. Thus originated the Doric stylobate. This would remain a mere hypothesis, but for the explicit testimony of those ancient authors who have defined this architectural term: the stylobate was the upper step alone.³⁰ And, what is still more to the point, it was in the Doric style, and in no other, that this character of a base was attached to the upper step.³¹

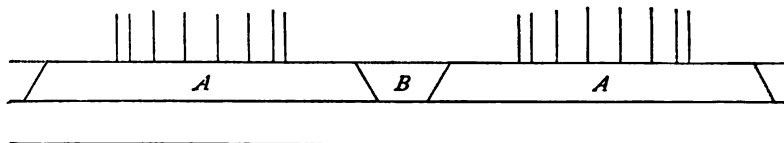


FIG. 37.

In the Ionic style the base, which, together with the capital, had been derived from Mesopotamia, consisted of mouldings. These roundels and scotias permitted great emphasis to be given to the member, its diameter being at the same time comparatively restricted. Hence, the projection of the Ionic base could never seriously interfere with the passage between the columns. In the Doric style, on the other hand, the principles of design were essentially different, and did not permit the introduction of curved lines of a contrary flexure in a member of such eminent importance to the constructive framework as the base. Moreover, the well-known tendency of the Doric, in

the Aegean. The gabled roof and archaic-Greek proportions of the tomb of Cyrus certainly favor the latter assumption.

³⁰ This is plain from the fact that the stylobate was considered requisite, even when the steps were transformed into a socle: Vitruvius, III. 4. 5. The Roman architect here evidently follows Hellenic traditions. Compare Hesychios, s. v. κρηπίς. The distinct character of the stylobate is especially apparent when, as in certain archaic temples of Sicily, it is of considerably greater height than the lower steps.

³¹ This all-important passage of Pollux (VII. 121) reads *στυλοβάτης, ἡ τοῦ Δωρικῶ κίονος βάσις· σπέτρα δὲ, ἡ τοῦ Ἰωνικοῦ*. Hesychios, s. v. *στυλοβάτης*, also attributes to the stylobate the character of a base.

contrast to the Ionic,³³ was to merge all the constituent parts in an inseverable whole, depriving them, as far as possible, of their individual independence. The only way, in accordance with these principles, by which the straight-lined base could be retained in the temple *in antis* and in the peripteros, was so to unite the separate slabs as to form a continuous plinth. Thus was the channelled shaft of Egypt, together with its base, introduced into the architecture of Greece, and embodied with the native Doric entablature in a fabric of perfect unity.

In æsthetic respects, the ultimate criterion of all artistic development, the creation of the stylobate was decidedly advantageous. The peripteral temple was to the Greeks an *anathema*, a votive offering to the deity. This was hereby elevated upon a single base, upon a consecrated floor, which isolated the fane even from the surrounding steps and the pavement of the temenos. Notwithstanding the fact that the stylobate, at least in later times, seems to have been conceived as extending over the entire foundation,³³ the columns of the Doric pronaos were provided with a separate plinth,³⁴ and the same member appears within the naos of those temples which were provided with galleries and inner ranges of columns.³⁵ The fact that

³³ Ionic columns, from their independent and more decorative character, were more frequently employed as free-standing shafts than were those of the Doric style. The general use of the former as sepulchral monuments has led to the erroneous assumption that the ancients attached to the Ionic column a distinctly mortuary significance. This view, first suggested by O. M. von Stackelberg (*Der Apollo Tempel zu Bassae in Arcadien, und die daselbst ausgegrabenen Bildwerke*: Frankfurt am Main, 1826), has been elaborated by F. Carellius (*Dissertazione esegetica intorno all' origine ed al sistema della sacra architettura presso i Greci*: Napoli, 1831), and especially by Raoul-Rochette (*Monuments inédits d'antiquité*, Paris, 1833; and in the *Journal des Savants*, Paris, 1833). This hypothesis scarcely needs serious disproof. The frequent adoption of Ionic forms for the isolated monuments of a nekropolis is fully explained by the architectural considerations before indicated.

Instances of the employment of Doric columns as sepulchral monuments are, however, by no means uncommon. Such shafts are represented upon many painted vases: to name one collection, instance Inghirami, *Pitture di vasi etruschi*: Ed. 2: Firenze, 1852-56, vol. II, 137, 142, 154, etc. The majority of the existing remains of such columns are of the Doric style. At least one other Doric shaft stood in the Nekropolis of Assos.

³⁴ That the stylobate comprised the entire floor, above the foundations and steps, is evident from Vitruvius, III. 4. 2.

³⁵ This is the rule, the only exceptions being the temples of Selinous and Assos.

³⁶ Instance the Parthenon, the great temple of Zeus at Olympia, that of Aigina, that of Poseidonia,—in short all the edifices with this arrangement.

the dipteral plan, so common in the Ionic style, is never known to have occurred in the Doric, may in some measure be explained by the consideration that the inner columns would, from many points of view, have appeared altogether destitute of a base. Taken together with the greater relative height of the Ionic column, its possession of an independent base may have also contributed to the not unfrequent adoption of Ionic columns in the interior of Doric structures: instance the Propylaia of Athens.

The supports employed by the Greeks before the introduction of the proto-Doric shaft from Egypt seem to have been round wooden posts, encased in sheets of beaten metal, without vertical striation, but provided with bases as well as capitals of round mouldings. The engaged columns of the Tholos of Atreus, and that represented upon the relief above the Gate of the Lions at Mykenai, certainly imitate empastic forms. While the use of these columns was entirely discontinued in Greece, reminiscences of them were preserved in the corresponding details of Etruscan architecture. The so-called Tuscan order had derived many of its leading features from Greece at a period when the columns of Beni Hassan were still unknown to Hellenic designers. In Italy the development of the column, not being influenced by the straight-lined and projecting base, followed an entirely different course, much less successful than that of Greece. The base of the former, with its circular plinth and tore of equal height, described by Vitruvius (iv. 7. 3), retained the primitive Hellenic forms almost unaltered. Such bases as these could never have been combined in a continuous plinth. Without the influence of Egypt the column of the Doric style must have remained similar to that of the Etruscan temple.

Among the Greeks the adjacent bases of the functional supports were so connected as to form the stylobate; but the case was not the same with the free-standing shafts of the Doric style. In isolated monuments, æsthetic and practical considerations, as well as ancient traditions, led to the retention of the independent plinth. The Greeks seem never to have been guilty of that modern solecism:³⁶ the erection of a free-standing column without a base. The inorganic juncture of a channelled shaft with a pavement was held to be inadmissible, even by the designers of the Hellenistic period; as is exemplified by the before-

³⁶ Instance the light-house on the jetty at Margate, and similar Doric columns without bases in London, Paris, etc.

mentioned column of the Athenian cemetery. Vase-paintings, too numerous to require specification, show that, after the characteristic forms of the original Doric base had been entirely forgotten, the three steps of the peripteros were placed beneath the channelled column, to form a transition between the horizontal pavement and the upright shaft.

That the Egyptian forms of the base, however, long continued unaltered, is proved by the accurate representation of this member in the careful drawing of a vase in the museum of Florence.³⁷ A Doric column is there shown, standing upon a low projecting slab, with bevelled edge, in all respects like the bases of Beni Hassan. The indications of primitive usage to be derived from such representations,—indeed, the entire history of Greek architecture,—might well have led to the assumption that the Egyptian base would be found in Hellas, were it possible to bring to light some column of the archaic period,³⁸ erected in entire independence of any other support. These conditions are fulfilled in the discovery now published, which provides a striking proof of this theory of development.

Unfortunately, so little remains of the column that it is not possible to perceive from it what progress the Asiatic Greeks of the sixth century had made in that incomparable artistic development which led from the mechanical baldness of the rock-cut supports of Beni Hassan to the organic perfection of the inclined and curved shafts and of the vigorous and graceful capitals of the Parthenon. No epoch of architectural history is of greater interest, the knowledge of none could be of greater practical value, than that immediately preceding the first appearance of the Doric style in its completeness: for complete it is, even in the oldest known temples. The column from Assos is a memorial of this period; and, though but a fragment, forms one of the most important results of the investigations carried on at that site, by furnishing a direct and decisive proof of the Egyptian origin of the Doric shaft, and by explaining the character of a common base which, throughout antiquity, was attached to the stylobate.

JOSEPH THACHER CLARKE.

³⁷ Engraved in Inghirami, *op. cit.*, vol. III, pl. CCCXIV.

³⁸ It may be observed in this connection that the peculiarly provincial character of the art of Assos greatly increased the probability of primitive features being there retained. The sculptures of the temple upon the akropolis, for instance, are so archaic that they have hitherto been universally regarded as nearly a century more ancient than the date to which the building is now assigned.

INTAILLES ANTIQUES DE LA COLLECTION
DE LUYNES.

[PLATE VII.]

Dans la célèbre collection d'antiquités et de médailles que le duc de Luynes donna, en 1862, au Cabinet des Médailles et Antiques de la Bibliothèque nationale, à Paris, se trouve une des plus intéressantes séries de pierres gravées que jamais collectionneur ait formée. La plupart de ces précieux monuments sont demeurés inédits bien qu'ils méritent, aussi bien au point de vue artistique qu'au point de vue de l'intérêt des sujets représentés, d'attirer particulièrement l'attention des archéologues. On en jugera par les quelques intailles que nous avons réunies sur la planche annexée à ce travail, et dont nous allons fournir un bref commentaire. La plupart appartiennent à l'art étrusque, d'autres à l'art grec ; quelques-unes enfin à l'art romain.

I.—CAPANÉE FOUROYÉ.

Fils d'Hipponous et d'Astynome, Capanée avait épousé Evadne, fille d'Iphis, roi d'Argos. Il fut un des sept héros argiens qui marchèrent contre Thèbes, lors de la guerre entre Étéocle et Polynice. Il s'était vanté que le feu de Zeus lui-même, ne l'empêcherait pas de monter à l'assaut de la capitale de la Béotie et n'arrêterait pas son audace. Mais au moment où le téméraire s'élançait sur l'échelle pour escalader le rempart, Zeus le foudroya.¹ Une pierre gravée étrusque représente Capanée renversé sur les débris de son échelle ; son nom KATNO est gravé à côté de lui.² D'autres intailles portent aussi le même sujet.³ A Delphes, il y avait une statue de Capanée consacrée à Apollon par les Argiens.⁴

Sur la pierre gravée de la collection de Luynes, le héros argien, renversé et ayant abandonné son épée recourbée, essaye encore de se

¹ Apollod. III, 6 et suiv.

² Millin, *Galerie mythologique*, pl. CXXXIX, n. 510.

³ J. de Witte, *Catalogue Durand*, n. 2189 ; cf. *Bullettino dell' Istituto*, 1834, p. 118.

⁴ Pausanias, x, 10, 2.

couvrir de son bouclier et il regarde le ciel d'où le coup fatal lui a été porté; l'échelle n'est pas figurée. Le mouvement du corps est bien compris, hardi et d'une bonne exécution.

Cornaline. Haut. 13 mill.; larg. 9 mill. Scarabée étrusque monté en bague.

II.—DIOMÈDE PORTANT LA TÊTE DE DOLON.

Le héros grec est nu, armé d'un bouclier, d'une épée et de deux javelots; il tient sur sa main droite la tête casquée de Dolon. Cette pierre gravée a fait autrefois partie de la collection Durand.⁵ Un autre scarabée de la collection Durand représente à peu près le même sujet.⁶ Il existe aussi d'autres monuments sur lesquels on voit Diomède et Ulysse coupant la tête à Dolon, que les Troyens avaient chargé d'observer et d'espionner l'armée des Grecs durant un armistice intervenu au cours du siège de Troie.⁷

Cornaline. Haut. 13 mill.; larg. 10 mill. Scarabée étrusque.

III.—PANDARÉE EMMENANT LE CHIEN DE CRÈTE.

Le grammairien Antoninus Liberalis raconte dans ses *Μεταμορφώσεων συναγωγή*, la fable suivante: "Quand Rhéa, qui craignait Cronos, eût caché Jupiter dans l'autre de Crète, la nymphe Aex vint le nourrir de son lait; un chien d'or gardait Aex, d'après l'ordre de Rhéa. Après que Jupiter eût ôté l'empire à Cronos par la victoire qu'il remporta sur les Titans, il donna l'immortalité à sa nourrice; son image fut mise au rang des astres. Quant au chien d'or, il l'établit gardien de son temple dans l'île de Crète. Pandarée, fils de Mérope, ayant volé ce chien, le conduisit au mont Sipyle et le donna en garde à Tantale, fils de Jupiter et de Pluto. Quelque temps après, Pandarée étant venu au Sipyle, réclama le chien; mais Tantale jura ne pas l'avoir reçu. Jupiter donc, pour punir Pandarée du vol qu'il avait commis, le changea en pierre dans l'endroit même où il se trouvait, et précipita Tantale en bas du mont Sipyle, pour se venger de son parjure."⁸

Il n'est pas difficile de reconnaître sur le scarabée de style étrusque, de la collection de Luynes, le voleur Pandarée, armé du casque, de la

⁵ J. de Witte, *Catalogue Durand*, n. 2199; *Bullettino dell' Istituto*, 1834, p. 118.

⁶ J. de Witte, *Catalogue Durand*, n. 2200.

⁷ Millin, *Galerie mythologique*, pl. CLVII, n. 573.

⁸ Voyez J. de Witte, dans la *Revue numismatique*, 1840, p. 190.

lance et du bouclier, tenant un scyphos de la main droite et emmenant le chien de Crète qui, bien qu'en or, n'en était pas moins vivant, à ce que prétend la fable. Dans le champ, on aperçoit une tête barbue de Silène qui sert d'orifice à une fontaine.

Le mythe de Pandarée et du chien crétois est très rare dans les représentations figurées de l'antiquité. Pourtant, sur un vase peint de l'ancienne collection Durand, cette légende se trouve figurée, plus complète que sur le scarabée de Luynes et avec quelques modifications de détail.⁹ On y voit l'audacieux voleur placé entre Héra et Poseidon qui favorisent son entreprise; il porte les mêmes armes que sur notre pierre gravée; de la main gauche il tient une couronne et la chaîne attachée au cou du chien de Jupiter.

Calcedoine brouillée. Haut. 17 mill.; larg. 11 mill. Scarabée étrusque monté en bague; style semi-archaïque.

IV.—CÉPHALE ET LE CHIEN LÆLAPS.

Hermès, *le crépuscule*, épousa Hersé, *la rosée*, fille de Cécrops, et de ce mariage naquit Céphale, *la brillante étoile du matin*, qui disparaît au lever de l'aurore. Céphale, dans le développement de la même allégorie, devient un jeune chasseur, d'une incomparable beauté, qui épouse Procris, *le scintillement de la rosée*, aussi belle et aussi passionnée que lui pour le plaisir de la chasse. Un matin, Eos ou *l'aurore* surprit Céphale qui s'était attardé dans les bois jusqu'au lever du soleil; elle en devint éperdument amoureuse et l'entraîna de force avec elle jusque dans les régions dorées de l'Orient qu'elle habitait.¹⁰ Cependant, Céphale demeurait fidèle à sa foi conjugale, sourd aux sollicitations de l'audacieuse qui l'avait enlevé. Celle-ci usa d'un stratagème pour vaincre la vertu du beau chasseur: elle lui conseilla d'éprouver la fidélité de la malheureuse Procris. Céphale se rendit méconnaissable sous les vêtements d'un riche étranger et s'en vint faire la cour à sa femme qui tomba dans le piège et se laissa séduire. Couverte de confusion lorsque son mari se fit connaître et craignant sa vengeance, Procris s'enfuit en Crète auprès d'Artémis, et elle se consola en suivant la déesse à la chasse. Artémis lui fit cadeau du chien Lælaps qui n'avait pas son pareil en flair et en vitesse, et d'un javelot dont les

⁹ J. de Witte, *Catalogue de la collection Durand*, n. 262.

¹⁰ Divers monuments représentent Eos qui emporte Céphale. Voyez *Archæologische Zeitung*, neue Folge, t. VIII, 1875, pl. 15; J. de Witte, *Catalogue de la collection Durand*, Nos. 233, 234 et 263.

traits étaient inévitables et auxquels nulle proie ne pouvait échapper. Procris résolut à son tour d'éprouver son mari. Elle part sous un déguisement, aborde au port de Thorikos, à la pointe de l'Attique, et invite Céphale à une partie de chasse. Céphale est émerveillé de la rapidité du chien *Laelaps* et de la vertu du javelot enchanté qui jamais ne manque son but ; pour posséder l'un et l'autre, il déclare sa flamme à la belle étrangère qui ne manque pas de se faire reconnaître au moment propice.

Les deux époux, coupables de la même faute, se réconcilièrent, et rien ne vint désormais troubler leur union, jusqu'au jour où Procris, demeurée néanmoins inquiète et jalouse, voulut savoir si Céphale n'aimait point réellement Eos qu'elle l'entendait souvent appeler aux premiers feux du jour. Procris se cacha, pour épier son mari, derrière un fourré de verdure, à quelque distance de l'endroit où Céphale, assis sur un rocher, se reposait de ses courses nocturnes. Le jeune chasseur entendant tout à coup remuer le feuillage, croit à la présence du gibier ; il arme son arc et lance dans la direction du bruit le javelot inévitable. Procris tombe mortellement frappée, victime à la fois de sa jalousie et du présent fatal qu'elle avait fait à son mari.

Céphale, désespéré et maudissant son sort, erra dans toutes les contrées de la Grèce. Il se trouvait à Thorikos, prêt à s'embarquer pour des régions inconnues, lorsque Amphitrion, roi de Thèbes, vint solliciter son secours contre les Téléboens. Le javelot qui avait tué Procris donna la victoire à Amphitrion, et celui-ci récompensa les services de Céphale, en lui donnant en toute souveraineté l'île qui s'appela dès lors Céphallénie. Une autre version raconte que Céphale, inconsolable d'avoir tué celle qu'il aimait, s'enfuit bien loin, marchant sans cesse, toujours à l'Ouest ; il atteignit le cap Leucade, en face de Céphallénie et ses forces l'abandonnant, il tomba dans la mer.

Des médailles de la cité des *Pallenses* de Céphallénie représentent le jeune chasseur avec son nom, ΚΕΦΑΛΟΣ, au moment où, assis sur un rocher, il va lancer le trait fatal qui devait atteindre Procris. On a voulu aussi reconnaître Céphale dans une statuette de bronze qui le figure dans la même attitude que les médailles.¹¹ L'intaille de la collection de Luynes que nous publions ici nous montre un chasseur et son chien dans lesquels nous n'hésitons pas à reconnaître Céphale et le chien *Laelaps*. Le chasseur est barbu, entièrement nu comme il convient

¹¹ S. Trivier, dans la *Gazette archéologique*, 1876, p. 144.

aux héros, debout, tenant le pedum de la main gauche baissée, tandis qu'élevant la droite à la hauteur du visage, il présente un objet très petit au chien qui s'élançe, debout sur ses pattes de derrière, pour atteindre l'appât.

Cornaline. Haut. 14 mill.; larg. 12 mill. Scarabée étrusque monté en bague; le style de cette pierre est particulièrement remarquable.

V.—LE DEVIN POLYIDIOS RETIRANT LE CORPS DE GLAUCOS DU VASE DE MIEL, EN PRÉSENCE DE MINOS ET DE PASIPHAÉ.

Le jeune fils de Minos, roi de Crète, et de Pasiphaé, tombe dans un tonneau (*πιθος*) de miel, en poursuivant une souris. Il y meurt étouffé, avant qu'on ait pu songer à l'en retirer. Minos s'adresse alors à Polyidios, devin d'Argos, descendant du fameux Mélémos, qui avait guéri les filles de Proetos. Mais Polyidios se fait prier: ce n'est que contraint par la force et les menaces qu'il se décide à retirer l'enfant. Minos exige en outre qu'il le ressuscite et pour forcer le devin à avoir recours à toute sa science, il l'enferme avec le cadavre jusqu'à ce que l'enfant soit ramené à la vie. Le miracle s'accomplit et Glaucos revoit le jour.

Sur le scarabée de Luynes, nous voyons Polyidios, debout, à demi-nu, enveloppé dans son péplos et tenant une baguette magique qu'il enfonce dans le vase de miel; la tête de Glaucos émerge du vase. A droite et à gauche, Minos debout, la barbe pointue, enveloppé dans son péplos, et Pasiphaé, assise, posant les mains sur le bord de la cuve, assistent à l'opération théurgique. On connaît d'autres gemmes où le même sujet se trouve représenté; l'une d'elles a fait autrefois partie de la collection Louis Fould.¹²

Cornaline. Haut. 21 mill.; larg. 16 mill. Scarabée étrusque de style semi-archaïque monté en bague.

VI.—PERSÉE VAINQUEUR DE LA GORGONE.

Persée est représenté entièrement nu, debout, s'appuyant légèrement sur un cippe. D'une main il élève triomphalement la tête de la Gorgone qu'il a saisie par les cheveux; de l'autre, il porte une petite Victoire qui tient une palme et une couronne. A ses pieds, sa cuirasse et son bouclier.

¹² Chabouillet, *Catalogue de la coll. Louis Fould*, n. 1047; voyez aussi Gori, *Museum Florentinum*, t. II pl. XLIII, n. 11.

Ce sujet est fréquemment reproduit sur les monuments antiques, particulièrement les vases peints et les médailles ; aussi nous n'insisterons pas sur son explication. Remarquons toutefois que notre scarabée s'écarte un peu de la donnée généralement acceptée. Presque partout Persée tient la harpe au lieu d'une Victoire et le cadavre acéphale de la Gorgone est étendu à ses pieds, comme sur les monnaies d'Amisus du Pont, par exemple.

Cornaline. Haut. 18 mill. ; larg. 14 mill. Scarabée étrusque monté en bague. Excellent style.

VII.—CASTOR PUISANT DE L'EAU À LA FONTAINE, CHEZ LES BÉBRYCES.

Le héros est représenté nu, avec de longs cheveux, son péplos enroulé autour du bras gauche. Posant le pied sur une roche, il se penche en avant, du côté d'un muse de lion qui forme l'orifice de la fontaine et d'où s'échappent des eaux. A ses pieds, on voit l'outre qui s'emplit de l'eau qui jaillit de la source. Dans le champ, le nom QVTZA , *Castur*, en caractères étrusques.

Dans sa *xxii^e* idylle, Théocrite chante la gloire des Dioscures et raconte notamment les aventures de Castor et de Pollux quand ils prirent part à l'expédition des Argonautes. Le navire Argo s'étant arrêté sur la côte du pays des Bébryces, en Bithynie, les deux jumeaux en profitèrent pour débarquer et faire une excursion dans ce pays inconnu. Après avoir marché quelque temps, à l'aventure, dans des contrées solitaires, au milieu des montagnes et des bois, ils découvrirent sous une roche escarpée une source abondante. Ils allaient s'y désaltérer, et déjà Castor y puisait, comme on le voit sur le scarabée que nous publions ici, lorsque parait l'hôte de ce site sauvage, le géant Amycus. Un colloque s'engage : " Eh quoi, mon ami, dit Pollux, ne pourrions-nous même pas nous désaltérer à cette source ? " . Le barbare prétend s'y opposer, et finalement Pollux engage avec Amycus un combat corps à corps, combat terrible dans lequel il prouve sa force extraordinaire : le géant est terrassé et vaincu.

Cornaline. Haut. 16 mill. ; larg. 10 mill. Scarabée étrusque monté en bague.

VIII.—LE TIREUR D'ÉPINE.

Faune agenouillé, cherchant à extraire une épine du pied d'un autre faune assis devant lui. Le patient, le corps à demi-couvert d'une

nébride, et muni d'une queue qui caractérise sa nature, lève la jambe droite et l'appuie sur le genou de son compagnon ; les contorsions de son corps, sa tête rejetée en arrière, les traits contractés du visage, tout cela est l'expression d'une violente douleur. L'opérateur, aussi à demi-couvert d'une nébride, est tout entier absorbé par l'extraction de l'épine ; il regarde attentivement son ouvrage sans se préoccuper de la souffrance qu'endure son camarade.

On connaît le tireur d'épine classique : le berger qui cherche à extraire lui-même l'épine qui a pénétré dans ses chairs, et dont les principales reproductions sont les statuettes de bronze du Vatican, de la collection de Rothschild,¹³ et le marbre qui, de la collection Castellani, est passé au Musée britannique.¹⁴ Mais un autre type de tireur d'épine, créé sans doute par un autre artiste, est celui qui se compose de deux personnages, et dont la pierre gravée de la collection de Luynes est une reproduction plus ou moins libre. Il existe plusieurs groupes de marbre qui doivent être rapprochés du sujet de cette intaille. Nous n'en citerons que deux. L'un, au Vatican, représente un Satyre, cornu, à pattes de bouc, accroupi devant un Faune, assis sur un rocher, et cherchant à extraire une épine du pied de ce dernier.¹⁵ L'autre, au musée du Louvre, est un groupe analogue, avec une pose un peu différente.

Les variantes que nous signalons n'empêchent pas que ces monuments n'aient un fond commun, et qu'ils ne soient évidemment de libres interprétations d'un chef-d'œuvre unique qui, malheureusement, n'est pas parvenu jusqu'à nous, mais qui eût pu, peut-être, soutenir la comparaison avec le tireur d'épine à un seul personnage dont nous avons de si admirables reproductions.¹⁶

Nous n'insisterons pas sur le caractère artistique de la pierre gravée que nous venons de décrire. Cependant, nous ferons remarquer la pose particulièrement heureuse des deux satyres, la hardiesse et le naturel de leurs mouvements, la parfaite harmonie qui règne dans les proportions de leurs membres. La souffrance aiguë et difficilement contenue, est bien rendue par les contorsions du patient, les traits mou-

¹³ Voy. *Gazette archéologique*, t. VII (1881-82), pl. 9, 10 et 11 et p. 127.

¹⁴ *Archäologische Zeitung*, 1879, p. 21 et pl. II et III.

¹⁵ *Mus. Pio Clement.* t. I, pl. 48 : Cf. Clarac, *Mus. de Sculpt.* n. 1742, pl. 726.

¹⁶ Sur les tireurs d'épine, voyez A. Furtwängler, *Der Dornauszieher und der Knabe mit der Gans*, in-8°, Berlin, 1876 : *Annali dell' Istituto*, 1874, t. XLVI, pl. M ; 1876, t. XLVIII, pl. O.

vementés de son visage et jusque dans la musculature de ses pieds, qui se crispent sous la douleur. Rien n'égale, d'autre part, la finesse de l'expression du jeune berger qui se livre avec une délicatesse, une attention et un sang froid de circonstance, à une minutieuse opération chirurgicale.

Calcédoine blanche. Haut. 22 mill.; larg. 17 mill. Intaille de style grec montée en bague.

IX.—MARSYAS APPRENANT À OLYMPUS À JOUER DE LA SYRINX.

Le satyre Phrygien qui osa disputer à Apollon le prix de la musique et fût cruellement puni de sa témérité, est debout à côté de son élève; on le reconnaît à ses cornes et à ses pattes de bouc; il tient un pedum à la main. Le jeune Olympus, son compatriote et son disciple, est assis sur un rocher et il tient des deux mains la syrinx dont il va jouer. Plus loin, au second plan, on aperçoit la grotte du satyre placée au-dessus d'un rocher escarpé.

Peu de légendes furent plus fréquemment que celle de Marsyas interprétées par les artistes grecs. On peut citer de grandes statues de marbre qui représentent, comme notre intaille, Marsyas ou Pan apprenant à Olympus à jouer de la syrinx;¹⁷ d'autres monuments figurent Marsyas enseignant à son élève à jouer de la flûte.¹⁸ Pausanias raconte qu'une peinture de Polygnote à Delphes représentait Marsyas, assis sur un rocher, ayant à côté de lui Olympus jeune, à qui il donne une leçon de flûte. Pline nous informe d'autre part, qu'on voyait au Champ de Mars, à Rome, un groupe représentant Olympus et Pan et qui passait pour un chef-d'œuvre: l'auteur en était inconnu.¹⁹ L'attitude d'Olympus, sur la pierre gravée de Luynes, a la plus grande analogie avec le type de revers de beaux tétradrachmes d'Arcadie sur lesquels figure le jeune héros phrygien assis sur un rocher.

Cornaline. Haut. 15 mill.; larg. 14 mill. Intaille de style grec.

X.—SATURNE DANS UN CHAR TRÂINÉ PAR DEUX SERPENTS.

Le dieu est assis, les jambes enveloppées dans sa chlamyde; de la main droite, il tient la harpe debout, en guise de sceptre; de la gauche

¹⁷ Clarac, *Mus. de Sculpt.* pl. 726 B, 1736 D, 1736 E.

¹⁸ Millin, *Galerie Mythologique*, t. 1, pl. XIX, 77: Cf. Chabouillet, *Catalogue des Camées et pierres gravées du Cabinet des Médailles*, n. 1674.

¹⁹ Plin. *Hist. nat.* XXXVI, 5.

il saisit les rênes nouées autour du cou des dragons. Dans le champ, on voit les figures du Capricorne et du Verseau. Les représentations de Cronos ou Saturne sont rares ;²⁰ celle-ci est particulièrement intéressante. Il faut la rapprocher des monnaies d'Antonin le Pieux frappées la VIII^e année de son règne à Alexandrie d'Égypte. Sur ces pièces, le buste de Saturne est accompagné, tantôt de la constellation du Capricorne et tantôt de celle du Verseau: on sait que ces constellations étaient le domicile de la planète Saturne, ce qui explique leur association avec le dieu lui-même sur les monuments figurés. Rappelons enfin qu' à l'époque d'Antonin, l'astrologie était particulièrement en honneur à Alexandrie.²¹

Jaspe rouge. Haut. 11 mill. ; larg. 15 mill. Intaille romaine de bon style, de l'époque des Antonins.

ERNEST BABELON.

²⁰ Voyez A. de Longpérier, *Notice des bronzes antiques du Louvre*, p. 2.

²¹ Charles Lenormant, *Nouvelle galerie mythologique*, p. 5.

THE LOST MOSAICS OF ROME IV TO IX CENTURY.

[PLATE VIII.]

THE VATICAN BASILICA.—When Constantine built the basilica of St. Peter, the main decoration of the interior consisted of mosaics, with which the greater part of the walls were covered. The apse mosaic was restored under Severinus (c. 640) and Innocent III (1198–1216), and existed until the basilica was destroyed to make way for the new edifice; that on the triumphal arch and remnants of those on the walls of the transept were still seen and described at the beginning of the XVI century. As to the nave, the tradition which asserts them to have had a mosaic decoration which was replaced by the frescos of Pope Formosus (891–96), rests on very uncertain foundations. A Constantinian mosaic certainly existed on the façade, as Comm. de Rossi has recently proved, and it was replaced by that of Gregory IX (1227–41).

The earliest of the mosaics of the Vatican basilica about which we have much information is, without doubt, that which was placed on the triumphal arch, and which Prof. Frothingham was so fortunately able to reconstruct from a text of the XVI century. As this remarkable example of the mosaic painting of the fourth century has been described in detail by my learned American fellow-worker, I shall limit myself to a reference to his essay published in the *Revue Archéologique* of Jan.–Feb. 1883.¹

I myself have given in the same Review (Nov. 1878, Aug. 1879 and Sept. 1882) a detailed study of the mosaic of the apse, to which it will be necessary only to refer.²

VATICAN BAPTISTERY.—Another mosaic of the fourth century is known only from a description in the poems of Prudentius; it was

¹ *Une mosaïque Constantinienne inconnue à Saint-Pierre de Rome.*

² *Notes sur les Mosaïques Chrétiennes de l'Italie. VI. Des éléments antiques dans les mosaïques romaines du Moyen Âge.*

placed in the baptistery built by St. Damasus (366-84), if we are to believe the palatine manuscript cited by Gruter :

Ad Fontes.

NON HAEC HVMANIS OPIBVS NON ARTE MAGISTRA
 SED PRAESTANTE PETRO CVI TRADITA JANVA COELI
 EST ANTISTES XPI COMPOSVIT DAMASVS
 VNA PETRI SEDES VNVM VERVMQVE LAYACRVM
 VINCVLA NVLLA TENEAT. AGATHIVS VOTVM SOLVIT.³

Some well-known verses, composed by the pontiff, allude to the works which he had undertaken in order to conduct to the Baptistery the water that was damaging the tombs of the martyrs. They are among the most elegant of his poetical productions :

“Cingebant latices montem teneroque meatu
 Corpora multorum, cineres, atque ossa rigabant.
 Non tulit hoc Damasus, communi lege sepultos
 Post requiem, tristes iterum persolvere poenas,” etc.⁴

Finally, the verses of Prudentius often cited since the XVI century describe the subject of the mosaics executed in this sanctuary :

“Interior tumuli pars est, ubi lapsibus sonoris
 Stagnum nivali volvitur profundo.
 Omnicolor vitreas pictura superne tingit undas
 Musci relucent, et virescit aurum
 Cyaneusque latex umbram trahit imminentis ostri.
 Credas, moveri fluctibus lacunar.
 Pastor oves alit ipse illic gelidi rigore fontis
 Videt sitire quas fluentia Christi.”⁵

The Good Shepherd feeding his flock, is a subject quite often represented in the primitive mosaics. It occurs, among other instances, in the mosaics that filled one of the small apses of the portico of San Venanzio (*pastores armenta pascentes*), which we may suppose resembled the fifth-century mosaic remaining in one of the apses of San Lorenzo at Milan, and in that of the mausoleum of Galla Placidia, at Ravenna. Commendatore de Rossi is inclined to think that the mosaics represented also marine subjects: “scene di mare,” *e. g.*,⁶

³ *Corpus Inscr. Rom.* 1163, No. 10.

⁴ This inscription is preserved in the Vatican crypts, and bears the number 47.

⁵ *Prudentii Carmina*: Rome, 1789, p. 1194: LIB. ΠΕΡΙΣΤΕΦΑΝΩΝ. Hym. XII, 33, etc.

tempest-tossed vessel; this he gathers from this inscription formerly placed on the very spot where Damasus anointed the faithful on emerging from the water:

TV CRUCE SVSCEPTA MVNDI VITARE PROCELLAS
DISCE MAGIS MONITVS HAC RATIONE LOCI.⁶

VATICAN.—ORATORY OF SANTA CROCE.—We learn from the *Liber Pontificalis* that Pope Symmachus (498–514) ordered the construction, in the Vatican basilica, of the oratory of the Holy Cross: “Item (fecit) ad fontem in basilica S. Petri apostoli oratorium sanctae Crucis ex argento, confessionem, et crucem ex auro cum gemmis, ubi in claudit lignum Dominicum, ipsa crux pens. libras x.”⁷

The papal chronicle does not add any information as to the mosaics that adorned the oratory having been executed under the auspices of this pope: this is first asserted by a medieval writer, Petrus Mallius, who was a canon of the basilica in the XII century and wrote a well-known description of it: “Ecclesia sanctae Crucis, quam construi fecit beatae recordationis Symachus Papa, cujus absidam columnis porfireticis, et optimo musivo decoravit et decem libras ligni sanctae crucis in ea recondidit.”⁸ May not Mallius have taken for the work of Symmachus what was in reality that of Leo III? I am rather inclined to think so, and this on account of a document but slightly posterior to Leo III, and consequently a far greater authority than Mallius, I mean the *Liber Pontificalis*, which attributes positively to the contemporary of Charlemagne the execution of the mosaics of the apse of this oratory: “Oratorium sanctae crucis quod jam prae nimia vetustate erat ruiturum simul cum absida novo aedificio erexit et ad perfectum usque perduxit, atque ipsam absidam ex musivo diverso decoratam picturis atque marmoribus miro splendore ornavit” (*in vita Leonis III*, § LXVI).

VATICAN.—ORATORY OF SAN MICHELE.—Mallius, Vegius, Panvinio and Ciampini mention the mosaics which adorned the altar of the Archangel Michael, situated in the portico before the church of Santa Petronilla (plan of Alfarano, No. 154): “Templum Sanctae Petronillae ante quod est Basilica Sancti Angeli, quae vocatur Vaticanum, mirifico mosibo laqueatum auro et vitro.”⁹ “*De oratorio*

⁶ *Bullettino di Archeologia Cristiana*; 1867, p. 88, fig. p. 34.

⁷ *Liber Pontificalis*, ed. Duchesne, p. 261. Cf. Note 21 on p. 266.

⁸ *Descriptio basilicae Vaticanae*, ed. de Angelis, p. 124.

⁹ P. Mallius, *op. cit.* ed. de Angelis, p. 58.

sanctae Michaëlis archangeli. Ante templum sanctae Petronillae versus murum ecclesiae fuit sacellum, sive aedicula sancti Michaëlis archangeli, dicta in Vaticano, auratis laquearibus ornata, musivo vitreoque opere decorata, quae diu ante exolevit: remansit vero tantum altare dictum sancti Michaëlis, quod etiam hodie amplius non extat. Sic P. Mallius et M. Vegius.¹⁰ "C. Litera haec ecclesiam Sancti Andreae a Symmacho papa constructam designat, de qua etiam egimus supra sub numero $\frac{1}{3}$. . . Tria in eadem erant altaria . . . secundum ad dexteram D. Michaeli arcangelo dedicatum, ac S. Angeli Vaticani nomine insignitum, mosivoque opere erat ornatum."¹¹

VATICAN.—ORATORY OF SANTA LUCIA.—The author of the description of the Vatican basilica as it existed in the latter half of the XII century, Petrus Mallius (*op. cit.* p. 125), attributes to Gregory the Great (590–604) the mosaics of the oratory of Santa Lucia, situated on the right before reaching the confession of St. Peter and near *San Giovanni ad fontes*: "Ante ecclesiam sancti Joannis ad Fontes ad oratorium sanctae Luciae, quod, ut a nostris accipimus, consecravit beatus Gregorius Papa, et ejus venerabile brachium in eo recondidit, et parietes illius, ut apparet, musivo depinxit."

De Angelis, the editor of Mallius, relates (*loc. cit.*) that he himself had seen, "in vestigio antiquo hujus Basilicae," the following inscription: ALTARE S. LVCIAE VIRGINIS A GEGORIO (*sic*) PRIMO. The existence of such a document, if it were well established, would tend to confirm the assertion of Mallius.

Panvinio, who also speaks of the antiquity of the chapel dedicated to Santa Lucia, places it in a different part of the basilica.¹²

VATICAN . BASILICA.—FAÇADE OF THE ATRIUM.—Pope Sergius (687–701) restored the partially ruined mosaics of the façade of the atrium: "Hic musivum, quod ex parte in fronte atrii ejusdem basilicae fuerat dirutum innovavit."¹³ These mosaics probably belonged to the time of Constantine himself.

VATICAN.—ORATORY OF JOHN THE SEVENTH (705-8).—The mosaics of this oratory have been studied in a special article pub-

¹⁰ Panvinio, *apud Mai, Spicilegium Romanum*, t. IX, p. 260.

¹¹ Ciampini, *De Sacris Aedificiis*, p. 93. Cf. Mignanti, *Istoria della sacrosanta patriarcale Basilica Vaticana*, t. I, p. 129.

¹² *De septem urbis ecclesiis*, p. 46.

¹³ *Lit. Pont.*, in *vita Sergii XI*, ed. Duchesne, t. I, p. 375. Cf. Panvinio *apud Mai, Spicilegium Romanum*, t. IX, p. 233.

lished in the *Revue Archéologique*, September, 1877: we refer our readers to it for details.

VATICAN.—ORATORY OF THE VIRGIN.—According to the *Liber Pontificalis*, Gregory III (731–41) caused to be constructed in the Basilica of Saint Peter, near the triumphal arch, in the space reserved for the men, an oratory dedicated to the Virgin.¹⁴ Mallius adds (*op. cit.*, p. 15) that, by the side of the altar to the Mother of Christ, another altar was raised in honor of Saint Gabinius. Neither of them mentions the mosaics which the oratory owed to Gregory III. Panvinio is the first who speaks of them (*op. cit.*, p. 42): “Octavum oratorium cum duobus altaribus S. Mariae et S. Gabinii a parte transversae crucis sub arcu majore, prope chorum canonicorum, in media cruce existentem, fuit beatae Mariae a Gregorio III fabricatum [et] dedicatum, pulcherrimis musiveis figuris condecoratum . . . in quo ipse, Eugeniusque III, qui illud restituit, sepulti fuere.”

The last phrase shows that the oratory served as a burial-place for both Gregory III and Eugenius III. This circumstance raises some doubt in my mind regarding the assertion of Panvinio. In fact Mallius and, later, Mapheus Vegius tell us that the tomb of the first of these pontiffs was adorned with mosaics. It is questionable whether these mosaics were distinct from those which the learned Veronese monk mentions: he may have taken the mosaics of the tomb of Gregory III, executed probably a short while after his death, to be the work of this pope. This kind of mosaic, instead of relating to the life of the defunct, represented ordinarily the same general subjects, so that such a confusion would not be improbable.

Leaving this question unsettled, I will cite the passages of Mallius and Vegius just alluded to. Mallius says (*ubi supra*): “Hic itaque summus Papa Gregorius tertius requiescit in loco illo, ubi nuno felicis memoriae beatus Eugenius Papa tertius requiescit. Ubi etiam ad honorem ejusdem Gregorii Papae fuit erectus arcus optime mosibo depictus et permansit usque ad tempora Domini Eugenii tertii Papae.” Vegius says: “Extat adhuc titulus Eugenii III marmoris impressus. Deperiit enim Gregorii III, et titulus qui erat hujusmodi, TERTIVS HIC PAPA GREGORIVS EST TVMVLATVS, et arcus simul qui illi erat erectus, ex nobili mosivo depictum.”¹⁵

¹⁴ *In vita Gregorii III*, § VI.

¹⁵ *De rebus antiquis memorabilibus Basilicae S. Petri Romae*, in the *Acta Sanctorum* for June, t. VII, p. 83.

To the restorations undertaken in this oratory by Eugenius III must be added those of Cardinal Lorenzo, nephew of Innocent VIII, who renewed it in 1495.¹⁶

VATICAN.—ORATORY OF SANTA MARIA IN TURRI.—Three mosaics were executed under the pontificate of Paul I (757–67). One of them decorated the oratory of the Virgin, popularly termed “de’ Cancelli,” in the Vatican basilica. It has long since disappeared, without leaving any traces but the more or less meaningless epithets bestowed on it by the authors of the Middle Ages or of the Renaissance:¹⁷ the very subject which it represented is unknown. The second, which was in the church built near the monastery of SS. Stephen and Silvester, met with a similar fate.¹⁸ As for the third, in the Oratory of Santa Maria in Turri, it seems to have almost entirely escaped the notice of archæologists,¹⁹ though a detailed ms. description and even a drawing of it are preserved: it is to this work that the following lines refer.

It is known that, on the erection of the new edifice, many of the ancient monuments belonging to the old basilica were designed and painted on the walls of certain parts of the crypt, in order to preserve some memory of them. Such a reproduction of this mosaic existed in the time of Torrigio (c. 1625), in the chapel of Santa Maria del Portico: this probably had been executed but a few years before the time when he wrote. He says: “Appresso scorgesi dipinta la facciata antica di mosaico, e l’immagine del Salvatore, che stava già nell’ Oratorio di S. Maria in Laborario, ò Inter Turres, ò In turribus, ò In turri, ò in Atrio: detta così perche stava nel cortile, e tra il campanile, e una certa Torre chiamata *Turris S. Justini*. . . . Vi si legge: *Opus musivum Salvatoris Oratorii S. Mariae in Turri à S. Paolo I.*”²⁰

The *Liber Pontificalis*, even, mentions this work, without however

¹⁶ Severano, *Memorie sacre delle sette chiese*, p. 107.

¹⁷ *Liber Pontificalis*, ed. Duchesne, t. I, pp. 465, 467; P. Mallius, *op. cit.*, p. 50; M. Vegius, *op. cit.*, p. 82; Panvinus, *op. cit.*, p. 41.

¹⁸ *Lib. Pont.*, ed. Duchesne, t. I, p. 464.

¹⁹ Besides the reference to it by Torrigio, it has been mentioned incidentally and with many errors in some little-known works. Bonnani, *Templi Vaticani historia*, p. 145; Marangoni, *Storia della cappella . . . di San Lorenzo*, 1747, p. 179; R. de Bussière, *Les sept Basiliques de Rome*. More recently it is mentioned and inadequately published in Garrucci’s great work, *Storia dell’ Arte Cristiana*, vol. I, in his chronology, under Paul I.

²⁰ Torrigio, *Le Sacre Grotte Vaticane*: Roma, 1639, p. 112.

expressly using the word mosaic. This passage is not given in all the MSS., but in one of the most important of them preserved at the Bibliothèque Nationale and dating from the IX century: "Fecit autem et in atrium ante turrem sanctae Mariae ad grada quod vocatur Paradiso oraculum ante Salvatorem in honore sanctae Dei genetricis Mariae miro opere et decoravit magnifice."²¹ The expressions "mirum opus" and "decoravit magnifice" clearly show the nature of the decoration of the building; they are almost always synonymous with mosaic-work. The presence of such a work on the façade of the *oraculum* as late as the first years of the XVII century (it was destroyed in 1610) does but confirm this hypothesis. This mosaic adorned the upper part of the façade, which was supported by Ionic columns and was between buildings of a style rather difficult to determine (perhaps added at a later date). It is thus given in the drawings that accompany the MSS. of the antiquarian Giacomo Grimaldi, apostolic notary and archivist of the basilica of St. Peter. This writer gives the following description of the mosaic: "Opus igitur ipsum musivum Pauli primi Salvatorem habebat sedentem, et sinistra librum tenentem, in quo erant litterae EGO SVM RESVRRECTIO ET VITA, in rota stellis ornata: hinc inde angeli rotam tenentes; subtus rotam Salvatoris seniores quatuor, bini per latera, offerentes coronas Salvatori, quatuor angeli sustinent rotam, et alii quatuor stant in actu volatus, supplicibus manibus versus Salvatorem, hinc inde; omnes vestiti. Musivum totum sinistrae partis seu magna pars desiderabatur; cecidit tempore Joannis XXIII Cossae, ut notat Antonius Petri in suo diario; deficit in fabricando mœniano marmoreo ad benedictiones. In Zophoro, multae litterae corruerunt, sed cum Pompeo Ugonio, insigni oratore²² meique amantissimo, considerando spatia litterarum quae desiderabantur, multo antequam fabri ipsam faciem demolirentur; ita Ugonius inscriptionem eandem ad integrum est interpretatus. Litterae autem erant e musivo majusculae Romanae, licet ineptae. Nigrae remanserant, rubrae vero additae sunt, videlicet: † X. PE | TI *bi SIT honor* | *Paulus* QVOD DECO | rat opus *♣*."²³

²¹ *Liber Pontificalis*, ed. Duchesne, p. 465.

²² He is the author of that valuable work, *Historia delle Stazioni di Roma*: Rome, 1588.

²³ *Catalogus sacrarum Reliquiarum almae Vaticanae Basilicae*, fol. 68, in the Ambrosian Library at Milan. The red letters of Grimaldi's MS., being those that were supplied, are printed in italics.

The drawing which accompanies Grimaldi's description (PL. VIII) represents Christ seated in the centre of a starry circle. His right hand is raised in the act of blessing or teaching, and his left holds the book. On each side three angels dart towards him with a motion of considerable boldness, to pay him homage. Somewhat lower are two angels of smaller dimensions, one on each side. The lower part is occupied by four figures which have the nimbus, as do all the other figures in the composition: they raise towards Christ a crown in homage. Grimaldi considers them to be the Elders of the Apocalypse (*quatuor Seniores*), but then why should we have four only instead of the 12 or 24 represented at San Paolo fuori-le-mura, at SS. Cosmo e Damiano, at Santa Prassede, on the façade of the basilica of San Pietro itself, etc.? Perhaps it may be admitted that the other figures disappeared at the time when the mosaic was made over. We know, for example, from the *Diarium* of Antonio di Pietro, that the entire left side fell, at the beginning of the xv century, under the pontificate of John XXIII.

Torrighio informs us (*op. cit.*, p. 114) that the chapel was restored by Innocent II (1130-43), and quotes the inscription of that Pope, found in 1610: "Questa Cappella fù ristaurata da Innocentio II, e nel 1610 fù trovata un' Iscrizione in marmo, che stava nell' altare de gli Auditori di Rota nella sala sotto il portico, che diceva:

EST IN HONORE PIAE DOMVS ISTA SACRATA MARIAE
HOC INNOCENTI TE PRAESVLE PERFICIENTE."

It is a well-known fact that, in the ceremony of imperial investiture, the Emperor was received by the canons in this chapel²⁴ and there took his solemn oath. This leads me to recognize an allusion to the mosaic in a hitherto obscure passage of Ugonio (*op. cit.*, p. 93, *vo.*) when he describes the entrance to the Basilica: "Passate le scale si entra in un spatio coperto: dove à man manca si vede nel muro un imagine del Signore con certe corone intorno & una croce sotto di porfido. Qui quando l'Imperatore si coronava in S. Pietro, si soleva drizzare un' altare; & si eleggeva Canonico di S. Pietro con certe solenni cerimonie."

VATICAN.—TOMB OF SAINT SIXTUS I.—The *Liber Pontificalis* tells us: "Paschalis in basilica (S. Petri) ante aditum qui ducit ad corpus in loco Ferrata, altare constituit, in quo et venerandum beati

²⁴ See Torrighio, p. 586.

Sixti martyris atque pontificis corpus honestissime collocavit, ubi et desuper arcum musivo exornatum decenter instruxit" (*in vita Paschalis I*, § v).

Petrus Mallius speaks more than once of this mosaic executed under Pope Pascal: "Xystus Papa fuit sepultus juxta ferratam prope corpus beati Petri ubi adhuc est arcus de musibo, quem fecit fieri Paschalis Papa primus (p. 62). Altare beati Xysti I quod est in introitu Basilicæ beati Petri juxta ferratam, super quod altare est arcus ex mirifico musivo, sicut legitur in vita Paschalis I Papæ" (p. 107). In the time of Mapheus Vegius the tomb of Sixtus I still existed; for he tells us (p. 81) that it was newly brought to light, together with those of St. Leo and of Hadrian, on the occasion of the works undertaken by Nicholas V: "Dum fundamenta ubi immensa novi operis imperfecti moles requiesceret, a Nicolao V aperirentur, reperiuntur ibi subterraneæ cellæ ornatissimæ quæ, superjecta ingenti rudium congerie, intra viscera terræ absconditæ, penitus ignotæ erant. Sane primum ipsum oratorium S. Sixti est, quod respicit suggestum, ubi Evangelium cantatur; de quo dicit Paschalis Papa, post deprædationem cœmeterii Calisti positum fuisse, ubi corpus B. Sixti martyris ante corpus B. Petri juxta septa ferrea, super quod et factum altare, lapidibus ornatum, et super altare arcus ex miro musivo; quæ sicut ille dicit adhuc hodie apparent."

Writers of the XVI and XVII centuries also mention this arch as covered with mosaics, but without describing it. No vestige of it remains.

VATICAN.—ORATORY OF SS. PROCESSUS AND MARTINIANUS.

—"Simili modo in eadem sacratissima beati Petri apostoli ecclesia, juxta ingressum qui ducit ad beatam Petronillam, oratorium summæ magnitudinis atque pulchritudinis decoranter construxit: et super columnas in quadrificio cameranter musivo pulchrisque metallis decoravit. In eo et corpora beatissimorum martyrum Processi et Martiniani recondidit."²⁶ It is in these terms that the *Liber Pontificalis* speaks of this work.

Mallius (p. 54) devotes a few lines to the oratory of the two saints: "juxta portam aeneam qua itur ad sanctam Petronillam et ad sanctum Andream, est oratorium sanctorum Processi et Martiniani martyrum, musibo et diversis lapidibus decoratum."

²⁶ *Lib. Pont., in vita Paschalis I*, § v.

Mapheus Vegius (*ubi supra*), also, was still able to study this interesting work of the IX century, of which, unfortunately, he did not think it necessary to give a description: "ultra portam aeneam quae ducit ad altare sanctae Petronillae, est eximium oratorium, quod ex mosivo egregie fabricatum erexit Paschalis Papa in honorem Processi et Martiniani."

Finally, a French Cardinal who died in 1470, Richard de Normandie, willed a considerable sum for the decoration of this oratory, where he wished to be buried.²⁶ Grimaldi relates that the unconsecrating of the altar took place in 1605: "Sub eodem pontifice (Paulo V) inter multa ac praeclara tantae basilicae monumenta quae perierunt etiam insigne SS. Processi et Martiniani martyrum oratorium opere vermiculato lapidibus ac metallis decoratum solo aequatum fuit."²⁷

On this last point the assertion of Chattard,²⁸ who places the destruction of the oratory under the pontificate of Julius II, must be corrected.

VATICAN.—ORATORY OF ST. GREGORY.—The *Liber Pontificalis* attributes to Gregory IV (827–44) the decoration of this monument (*in vita*, § VI): "(Gregorius IV) corpus beati Gregorii ex loco, sepultum quo prius fuerat, tulit, et non longe ab eo in alium noviter constructum infra ecclesiam beati Petri apostoli summo honore perduxit. Ejusque sacrum altare argenteis tabulis undique ornavit, et oratorium in suo sancto nomine titulavit absidamque ejus desuper aurato musivo depinxit." Mallius (p. 78) mentions the oratory of St. Gregory, but without speaking of the mosaics which adorned it.

The historians of the basilica are not in accord as to the site occupied by this oratory. While some, like Severano,²⁹ place it on the right of the portico of the church, others seek to identify it with the chapel of Santa Maria delle Febbri, built and adorned with mosaics by the same pope, Gregory IV.

VATICAN.—ORATORY OF ST. LEO.—This oratory is known by a passage of the *Liber Pontificalis*, *in vita Leonis IV*, § XXXI: "Ipse quidem a Deo protectus et venerabilis praesul intra basilicam beati Petri apostoli oraculum mirae pulchritudinis, summique decoris construxit, quod pulchris marmoribus circumdans splendide compsit absidamque ejus ex musivo aureo superinducto colore glorificè deco-

²⁶ Grimaldi, MS. of Barberini Library, xxxiv, No. 49, ff. 11–12.—²⁷ *Ibid.* fol. 10.

²⁸ *Nuova descrizione del Vaticano*: Rome, 1762, t. I, p. 67.

²⁹ *Memorie sacre delle sette chiese*, p. 67.

ravit, in quo etiam corpus beati Leonis confessoris, atque pontificis recondens," etc.

THE LATERAN BASILICA.—The Lateran, like the Vatican, was from the time of its foundation a great centre for mosaic painting. Its mosaic series may be divided into three parts, into those which decorated (1) the Basilica itself, (2) the Baptistery and its dependencies, (3) the various buildings of the pontifical palace, especially the triclinia and oratories.

No records of Constantinian mosaics exist, as at the Vatican, and the earliest known is doubtless that still to be seen in the Chapel of SS. Rufina and Secondina, attributed by De Rossi to about 400 A. D. From that time, however, until the decline of mosaic painting the Lateran basilica possessed a complete and uninterrupted series of works. Here was placed the last work executed by the Roman school of the early Middle Ages,—the mosaics of the nave executed by Sergius III about the year 907; a work of which no notice has ever been taken by art historians; that of Santa Maria in Trastevere, executed under Benedict III (855–58), having been considered the last mosaic of this school.

Here, again, I must commence by referring the reader to previous works. A notice of the apsidal mosaic of the basilica appeared in the *Revue Archéologique* (Nov. 1878, Aug. 1879, Sept. 1882); another, of the triclinium of the apostolic palace, in the same Review (Jan. 1884).

LATERAN.—ORATORY OF THE HOLY CROSS.—Saint Hilary (461–68) raised three oratories by the side of the baptistery of the Lateran. Two of these, joined to and communicating with this edifice, still remain: the oratory of John the Baptist and that of St. John the Evangelist. The third, that of the Holy Cross, which was placed at a certain distance from the baptistery, on the right hand coming from the square of the Lateran, has disappeared. "Fecit oratoria tria in baptisterio basilicæ Constantinianæ, S. Johannis Baptistæ, S. Johannis Evangelistæ et S. Crucis. . . Nymphæum et triporticum [fecit] ante oratorium S. Crucis . . . undique ornatum ex musibo et columnis aquitanicis et tripolitæ et purphyreticis."²⁰

Several inscriptions complete the evidence as to the part which St. Hilary had in all these works. Over the door of the oratory of St.

²⁰ *Lib. Pont.*; ed. Duchesne, pp. 242, 243; cf. Note 3, p. 245.

John the Evangelist we still read : LIBERATORI SVO BEATO JOHANNI EVANGELISTAE HILARVS EPISCOPVS FAMVLVS XPI. Over that of the oratory of John the Baptist : HILARVS EPISCOPVS DEI FAMVLVS OFFERT.

Of the mosaics executed in these different edifices, the *Liber Pontificalis*, as we have seen, mentions only those of the nymphæum placed in front of the oratory of the Holy Cross. But we know that for the first five or six centuries of the Christian era the papal chronicle does not pride itself on a strict exactitude. It is therefore allowable to supplement its silence by means of data furnished by the style of the works themselves. At least in that one of these works which has survived, the style is that of the mosaics of the time of St. Hilary, as I will soon show.

The oratory of the Holy Cross was destroyed at the time of the last restoration of the Lateran, under Sixtus V : "Questo luogo et Capelle, essendo del tutto rovinate e desolate, . . è parso il meglio in quest' ultima restauratione del Laterano si leuassero."³¹ At the epoch in which Panvinio wrote it had already lost the greater part of its riches (*op. cit.*, p. 165) : "Nunc magna ex parte omnibus ornamentis suis, et marmoreis etiam spoliatum est; et eorum loco repositae sunt inepti artificis picturae."

Nevertheless, we know what the mosaics of this oratory represented, thanks to Severano and Cardinal Rasponi. As their descriptions complete each other, I will reproduce both of them : "La volta era ornata di mosaico, con quattro Angeli nei cantoni, li quali sostenevano una croce. Trà le quattro finestre, che vi erano, si vedevano le imagini (parimente di mosaico) di SS. Pietro e Paolo, Gio: Battista, Gio: Evangelista, Giacomo, Filippo, Lorenzo, e Stephano; e nelli muri delle Tribune medesime, coperti di marmi, i segni della santissima Croce."³² Rasponi says : "Tectum concameratum opere musivo aureo elegantissimo expictum erat, visebanturque ad angulos quatuor Angeli qui ingentem crucem sustinebant. Super absidas, paulo infra testudinem, fenestrae quatuor peramplae aperiebantur, ac in earum interstitiis ex musivo opere SS. apostolorum Petri ac Pauli, S. Joannis Evangelistae, S. Joannis Baptistae, SS. martyrum Laurentii et Stephani, nec non Jacobi et Philippi imagines extabant."³³

³¹ P. Ugonio, *Historia delle stazioni di Roma*: Rome, 1588, p. 46, ro.

³² Severano, *op. cit.*, t. I, p. 499.

³³ Rasponi, *De Basilica et Patriarchio Lateranensi*, p. 232. Cf. Grimaldi, *Cod. Ambros.* A 178, fol. 36 vo.

LATERAN.—ORATORY OF JOHN THE BAPTIST.—The oratory of John the Baptist, situated on the right hand of the baptistery as you enter from the square of the Lateran, has not fallen under the pick of the hireling demolishers of Sixtus V, but it has, nevertheless, lost its primitive decoration. Clement VIII, and later Francesco Mattei, patriarch of Alexandria (1727), restored and adorned it with new paintings.⁵⁴ It was doubtless on the occasion of the “embellishments” of the latter that the oratory was despoiled of its mosaics. Both Panvinio and Cardinal Rasponi praise the elegance of this ornamentation: “Testudo tota è musivo pulcherrimo” (Panvinio, *op. cit.*, p. 159): “Concameratio elegantissime intersecta cernitur opere musivo” (Rasponi, *op. cit.*, p. 226). Ciampini has done better by giving us an engraving of it.⁵⁵

In the centre of the composition, that is to say, at the summit of the vault, was seen the nimbed Lamb standing in the midst of a garland of laurel leaves; while all around was a rich ornamentation which recalls the paintings of the catacombs,—flowers, arabesques, various birds, peacocks, doves bearing in their beak an olive-branch; lower down, on the right and left of each of the two windows of the oratory, stood an evangelist, holding open the sacred book, accompanied by the animal which is consecrated to him.

LATERAN.—ORATORY OF ST. PETER.—“Gregorius II (715–31) oratorium Osannae in patriarchio in nomine beati Petri apostoli diversis ornatum metallis, a novo fecit.” It is in these terms that the *Liber Pontificalis* (*vita S. Greg. II*, § IX) mentions the construction of this oratory. I would not have thought of translating the word *metalla* by “mosaics,” as it is often used with the meaning “marbles,”⁵⁶ if Onofrio Panvinio, in his manuscript history of the Lateran, had not solved the difficulty.⁵⁷ In the chapter entitled *De oratorio sancti Petri in patriarchio Lateranensi*, he expresses himself on this subject in the following manner: “Gregorius II, ut Anastasius tradit, oratorium diversis ornavit metallis, id est opere musivo.”

⁵⁴ Valentini and Gerardi, *La Patriarcale Basilica Lateranense*: Rome, 1832, t. II, p. 71: “Queste due capelle vennero ristorate ed abbellite con pittura ed altri ornamenti dalla S. M. di Clemente VIII, ed in seguito nel 1727 da Francesco dei Duchi Mattei Patriarcha di Alessandria, come risulta da lapidi che in esse legonsi.”

⁵⁵ *Vetere Monumenta*, t. I, pl. LXXV.

⁵⁶ Examples will be found in Vignoli's edition of the *Liber Pontificalis*, t. I, p. 366; t. II, p. 382.

⁵⁷ Barberini Library, MS. No. XLIX, 14, p. 263 vo.

The opinion of a scholar so well versed as was Panvinio in the history of the ancient papal palace is worthy of serious consideration. In his time there remained no more traces of the oratory of Gregory II: "Hujus oratorii vestigium nullum quod sciam extat."

LATERAN.—ORATORY OF THE ARCHANGEL.—The *Liber Pontificalis*, so well informed as to everything that relates to the IX century, attributes to Leo III the foundation of the oratory of the Archangel in the Lateran palace: "(Leo III) fecit in patriarchio Lateranensi oratorium a fundamentis in honorem beati Archangeli, insigni opere firmissime construens, quod etiam ex musivo seu diversis picturis atque pulcherrimis marmorum metallis diversis coloribus ornavit undique."³⁸

This oratory was destroyed in 1613, according to Grimaldi.³⁹ Rasponi⁴⁰ reports that he saw a fragment of the inscription placed on the façade, which was thus worded: HOC ORATORIVM A FVNDAMENTIS CVRANTE V. LEVITA PETRI AD HONOREM FIERI JVSSIT LEO. I have not been able to discover the subject of the mosaic mentioned by the papal chronicle.

LATERAN.—TRICLINIUM OF GREGORY IV.—This Pope, who reigned from 827 to 844, added to the palace of the Lateran a triclinium whose magnificence is thus praised by the *Liber Pontificalis* (*in vita Greg. IV*, § XV): "Fecit in patriarchio Lateranensi triclinium mirae magnitudinis decoratum cum absida de musivo, seu et alias absidas duas dextra laevaue positas infra paracellarium variis historiis depictas."

SANT' AGATA IN SUBURRA.—In the apse of the church of Saint Agatha in Suburra, or "super suburram," there was still to be read, towards the close of the XVI century, the following inscription, which has been preserved by Ciacconio in his collection of drawings,⁴¹ and by Baronius in the Martyrology:⁴² FL. RICIMER V. I. MAGISTER VTRIVSQVE MILITIAE ET EX CONSVL. ORD. PRO VOTO SVO ADORNAVIT. The word *adornavit* authorizes us to believe that Ricimer did

³⁸ *In vita Leonis III*, § XCII-II, 303. ³⁹ Ambrosian Library, MS. A. 178, fol. 8^{vo}.

⁴⁰ *De Basilica et Patriarchio Lateranensi*. He has supplied the lacunae by means of Ugonio's *Historia delle Stazioni di Roma*.

⁴¹ Vatican Library, *Latin MSS.* No. 5,407 *et seq.* It is known that this precious collection was brought to light by Commend. De Rossi. Copies of Ciacconio's drawings are to be found at the Ambrosian Library, Milan.

⁴² Edition of Venice, 1621, p. 93, Feb. 5.

not build the church, but only had the mosaics executed, which, after having existed until the time of Clement VIII,⁴³ have been rescued from oblivion, thanks to the learned Ciacconio. The Arian general gained in 456 his great victory over the Alani, and it is possible that it was in consequence of a vow made on this occasion that these mosaics were executed. In any case, their origin cannot be posterior to 472, the year of Ricimer's death.

A series of thirteen drawings of the XVI century, slightly colored, each representing an isolated figure,—this is all that remains from this interesting work. The figures are those of Christ and the twelve apostles. At the beginning of the series, there is a note which I here transcribe: "In aede S. Agathae ad Suburra in abside istius ecclesiae sunt Christus et XII apostoli, sex a dextris et sex a sinistris; quod opus fieri fecit Flavius Ricimerus . . . quae pictura in mosaico antiquior multo est, ut existimo, ipso S. Gregorio P. P. Paulus IV Pont. max. non levibus rationibus permotus, solebat dicere picturas has esse veras apostolorum effigies, id quod certe comprobant sanctorum apostolorum Petri et Pauli, quae omnino sunt similes iis quae pro certis et indubitatis in Vaticana basilica asservantur. Opus vermiculatum seu mosaicum vulgo dictum in aede S. Agathae in Suburra, quod nuper cecidit et picturis suppletum est anno D. MDICV." ⁴⁴

According to the drawings which reproduce them, the following is the order of the figures.—S. IACOBVS ALPHEI, beardless, with hair cut straight across the forehead, near the eyebrows. His costume, as well as that of all the other apostles, was composed of a bluish tunic ("stolae coerulei coloris," Ciamp. *Vet. Mon.* t. I, p. 272) across which run lengthwise two bands of a darker blue; then, a mantle shaded with brown, adorned with those enigmatical letters which have been the despair of so many archæologists (on these figures an L is generally used); finally, sandals. His left hand is hidden under his mantle, his right is extended naturally, as if he were conversing with his neighbor. Neither he nor the other apostles have the nimbus.—S. SIMON

⁴³ Writers are not in accord as to the period when the apse of Sant' Agata in Suburra fell to ruin, and with it the mosaics. Baronius, *Annales*, 472, No. 11; and Nibby, *Roma nell' anno 1838*, p. 331; relate that it was in 1589. Ciampini, *Vetera Monumenta*, t. II, p. 271; and Gregorovius, *Storia della città di Roma*, t. I, p. 262; contend, on the contrary, that it was in 1592.

⁴⁴ Martinelli was acquainted with the passage relating to Paul IV, and reproduces it in his *Diaconia S. Agatae in Suburra*, p. LVIII.

ZELOTES holds the roll (volumen) with both hands, the right uncovered, the left being covered by his robe; chestnut beard.—S. IACOBVS, chestnut beard and hair. His left hand is draped in the folds of his garment, the right hand raised.—S. IVDAS IACOBI: while the preceding apostles are turned towards the right, this one is turned to the left. He is having an animated discussion with St. James. His attitude is excellently drawn.—S. PHILIPPVS: hair brown, beard rather long and of the same color. It would appear that he was tonsured.—S. PAVLVS holds with his left hand the volumen: he extends the right hand towards Christ, as if to question him. His beard is brown and very long; hair also brown.—SALVS TOTIVS GENERIS HVMANI: the Christ is seated on the azure globe: on his left hand rests the open book, which he shows to the faithful; with the right hand, slightly raised and the palm turned outward, he appears to expound the sacred text: his gesture is full of gentleness and persuasion. His vesture consists of a blue tunic with a wide yellow *clavus*, a violet mantle, and sandals. He has long curling brown hair, silky beard divided in the middle, and a yellow nimbus.—S. PETRVS advances towards Christ with a hasty step, bearing on his mantle the key, symbol of his office. His figure is broad and robust; he has curly white beard and hair.⁴⁵—S. ANDREAS faces frontward, with beard cut rather short, hair dishevelled and a brusque manner; he holds the roll (volumen) in his right hand, supporting it with his left hand which is veiled.—S. IOHANNES faces frontward, with a sentimental expression. He has long curling hair and a blond beard. With his uncovered right hand he holds the volumen unrolled. His physiognomy is that of a youth, and not of the old man that we see in the engraving of Ciampini.—S. THOMAS raises his hand with the last two fingers bent. His hair is cut close, and he has a brown beard.—S. MATTHÆVS: in his veiled left hand we see the volumen, while with his raised right hand he makes a gesture

⁴⁵ Misled by Ciampini's engraving, Abbé Martigny (*Dict. des Antiq. Chrét.* p. 423) thought that St. Peter wore a tiara: this is not so. The same remark applies to the supposed tiaras of the Apostles in the Baptistery of the Orthodox at Ravenna: in reality they are nothing else than folds of hangings suspended behind their heads. Here, also, one of Ciampini's engravings has led into error not only the above-named scholar (*Dict.* p. 45), but also Von Quast (*Ravenna*, p. 5), Schnaase (*Gesch. d. bild. Künste*, 1st ed., t. III, p. 181), Unger (*Encycl. Ersch & Gruber*, vol. LXXXIV, p. 391, col. 1), and Canina (*Ric. sull' architettura più propria dei tempi cristiani*: Roma, 1846, pl. CIV).

as if to demonstrate something.—S. BARTOLOMÆVS is slightly bent, of youthful appearance, beardless and with hair cut close.

These figures are separated in the copies at the Vatican : Ciampini had the happy idea of grouping them on the same sheet (*Vet. Mon.* t. I, pl. LXXVII) so as to reconstitute the ensemble of the mosaic. Their attitude and their gestures indicate the order in which they were originally arranged, and this project of reconstitution has every possible guarantee of trustworthiness. It shows with what talent and consummate knowledge the mosaicists of Ricimer gave animation to the scene without violating the laws of style and of monumental decoration. The idea which the artists wished to make the ruling one, is that of the procession of the apostles in two groups towards the Saviour of mankind. But at every instant comes an episode, so to speak, to interrupt the uniformity of the action and charm the fancy, without obscuring the main motive. Thus, for example, St. Jude turns back toward his neighbor, carried away by the heat of discussion ; and St. Andrew stops in front of the spectator, as if suddenly impressed by an idea. Such motives, while they accentuate the character of each one of the disciples of the Divine Master, at the same time contribute to the general composition a peculiar force and zest.

Remarkable, also, is the thoroughly antique elegance of the draperies, and the felicitous role given by the artist to the left hand, which usually holds the mantle so as to let it fall down in picturesque folds. It may be said that the entire style forms a most remarkable intermediary between the too violent action of the primitive mosaics (*e. g.* that of the Baptistery of the Orthodox at Ravenna) and the heaviness of the following period, already so near to the stiffness and immobility of the Middle Ages proper. As for the types, they show a feeling both for beauty and for character. But I think it would be dangerous to confide too blindly in these copies of the XVI century. Their author seems to have been influenced by the great creations of the Renaissance. It is to be feared that he may have seen the apostles of Saint Agatha in Suburra through the medium of Leonardo da Vinci's Last Supper ; the air of some of the heads recalls directly the immortal fresco of *Santa Maria delle Grazie*. However this may be, if these copies were but a feeble echo of the original, it would be none the less interesting to reproduce in more satisfactory

engravings than those of Ciampini these very rare vestiges of the Arian painting of the fifth century.

Gregory the Great (590–604), having again consecrated this church and restored it to orthodox worship, wished also to embellish it. In doing so, he employed both enamelled cubes and fresco-painting. Pope Hadrian, in his well-known letter to Charlemagne, recalls these creations of his illustrious predecessor: "Ecclesia Arianorum, cujus ipse sanctus Gregorius in dialogis suis meminit, placuit eidem sancto Gregorio ut in fide catholica, introductis illic beatis Sebastiani et sanctae Agathae martyrum reliquiis, dedicari debuisset, quod et factum est: diversis historiis ipse beatus Gregorius pingi fecit eam, tam in musivo quam in coloribus, et venerandas imagines ibidem erexit: et a tunc usque hactenus venerantur."⁴⁶ The two "images" which the anonymous author of the *Itinerary of Einsiedeln* saw in the VIII century in the church of Sant' Agata doubtless formed a part of the works executed by St. Gregory: "Sca. Agatha ibi imagines Pauli et sanctae Mariae sub. (suburra?) Thermae Constantini."⁴⁷ The mosaics or paintings in question remained until about the beginning of the XVII century, as is proved by a passage in Martinelli (*op. cit.*, p. LXVI): "Gregorianum venerabile opus picturis, sacrisque imaginibus expressum permansit ad aevum nostrum, quo edaci tempori cedens, ac fere ad confusa lineamenta redactum, M. Antonius Gozadinus albario opere perpolivit."

It is doubly to be regretted that these works have perished, for Gregory the Great, as is well known, did not execute any great number; preferring the works of faith to monuments in marble or brass.

SANTI APOSTOLI.—Pelagius I (555–61) began the erection of the church of the Holy Apostles (St. Philip and St. James), but he died before having finished it.⁴⁸ John III (561–74) continued and completed the work of his predecessor.⁴⁹ That this church was ornamented with mosaics is proved by a passage in the letter addressed by Pope Hadrian to Charlemagne on the subject of the second council of Nicaea: "Multo amplius vero dominus Pelagius atque

⁴⁶ Labbe, *Sac. Concilia*, loc. cit.

⁴⁷ Urlichs, *Codex urbis Romae topographicus*: Wurtzburg, 1871, p. 70.

⁴⁸ *Lib. Pont.*, in *vita Pelagii*, ed. Duchesne, p. 303.

⁴⁹ *Ibid.*, in *vita Johan. III*, p. 305. Vignoli is in error, when he says, in his edition of the *Liber Pontificalis*, t. I, p. 359, that John III finished the church begun by his predecessor Sergius.

dominus Joannes mirae magnitudinis ecclesiam Apostolorum a solo aedificantes historias diversas, tam in musivo, quam in variis coloribus cum sacris pingentes imaginibus, et a tunc usque hactenus a nobis venerantur."⁵⁰ Nibby,⁵¹ who passes over in silence the execution of these mosaics, publishes from Marini (*Papiri diplomatici*, p. 103) two inscriptions formerly placed, the one on the arch of triumph, the other in the apse. The first is thus worded :

PELAGIVS CEPIT COMPLEVIT PAPA IOANNES
VNVM OPVS AMBORVM PAR MICAT ET MERITVM.

The apse of this church was restored by Hadrian I (*Lib. Pont. in vita Had.*, § L): "Absidam cernens jam ruinae vicinam existentem cancellis ferreis eandem absidam confirmare fecit, et ita eam renovavit." In 886, under Stephen V, took place a new restoration, and again another under Martin V (1417-31). Finally, about 1475, Sixtus IV almost entirely rebuilt this venerable edifice. There is little probability that after this there remained anything of the mosaics of Pelagius I and John III.

EUGÈNE MÜNTZ.

[To be continued.]

⁵⁰ Labbe, *Sacrosancta Concellia*: ed. of Venice, 1729, t. VIII, p. 1553 et seq.

⁵¹ *Roma nell' anno 1838*; parte mod. t. I, p. 108. These inscriptions are preserved in a MS. of the XV cent. in the Vatican Library. Cf. Martinelli, *Roma ex ethnica sacra*: Rome, 1653, p. 64 et seq.

MARBLE HEADS IN THE TCHINLY-KIOSK MUSEUM.

[PLATE IX.]

The two marble sculptures, a medallion and a bust, which have been admirably reproduced by M. Dujardin on PL. IX, belong to the Museum of Tchiny-Kiosk, at Constantinople.

I. The medallion (1.02 m. in diameter) is said to come from the Byzantine Forum or *Augusteon*:¹ it is a head of Medusa in relief, sculptured in that peculiarly dry and frigid style which characterizes Greco-Roman art in its later stage of development, or its decay. One striking feature in the art of that period is a tendency to ornamental regularity in the representation of the human figure. After having gradually conquered its independence from the realm of architecture and decoration, in the days of pre-Pheidian sculpture, it seems as if the declining art had felt a temptation to resume the yoke which the genius of ancient masters had shaken off. Indeed, the history of the type of Medusa, which has more than once been retraced,² may serve as an illustration of that curious evolution. In the most ancient works, particularly the black-figured vases and works in metal, the head of Medusa is an emblem of horror and dismay, something like a hideous bugbear or *ἀποτρόπαιον*; often used, besides, as a simple ornament, undoubtedly connected with a superstitious idea of prophylaxy, but without any relation to the objects on which it is represented.³ Gradually, however, the type is seen to evolve, under the increasing influence of idealism: the coarseness of expression and grotesque ugly-

¹ Reinach, *Catalogue du Musée Impérial*, 1882, No. 128.

² Levezow, *Ueber die Entwicklung des Gorgonenideals* (*Abhandlungen der Berliner Akademie*, 1832, and separately, Berlin, 1833); Six, *Specimen literarium inaugurale de Gorgone*, Amsterdam, 1885 (cf. *Journal of Hellenic Studies*, vol. VI, pp. 275-286); Dumont, *Monuments grecs*, 1878, p. 22 sqq.; Wolters, *Gypsabgüsse antiker Bildwerke*, No. 1597.

³ Cf. the most ancient known marble figure of Medusa, a medallion found in Sparta (*Archäol. Zeitung*, 1881, pl. 17, 1 and p. 291; *Mittheil. des deutschen Instituts*, vol. II, p. 317). This Medusa is an architectural ornament, as is also an archaic head of Medusa found on the Akropolis of Athens (Ross, *Archäol. Aufsätze*, vol. I, pl. 8, p. 109), and a similar one from Olympia (Wolters, *Gypsabgüsse*, No. 385).

ness disappear,⁴ giving way to a two-fold conception of the Gorgon's head,—either as a symbol of intense but noble suffering, or as the image of fascinating but fatal and cruel beauty. The former is chiefly represented by the Ludovisi Medusa in Rome,⁵ the latter by the Rondanini Medusa in Munich,⁶ two masterpieces belonging, in all probability, to the end of the Alexandrine period. As a symbol of pain, the Ludovisi type was very well adapted to the adornment of sarcophagi,⁷ while on the other hand the type of the Rondanini sculpture afforded an easy motive for architectural decoration. Both these types, especially the latter, were adopted and repeatedly used by Roman art. The head of Medusa occurs on countless monuments, and finally tends to become a mere ornament, without any mythological or moral meaning attached to it. The two winglets on the top of the head, which first appear in the Alexandrine period,⁸ are always preserved in the Roman type; but the tongue is no longer thrust out, the menacing rows of teeth do not appear, and the entangled serpents forming the head-gear are generally omitted.⁹ The head is encircled, as in the Medusa of Constantinople, with thick twists of hair,¹⁰ still recalling

⁴ A legend alluded to by Pindar, which may have found greater credit in later times, praises the beauty of Medusa (*εἰπάραος*, *Pyth.* XII, v. 28).

⁵ *Monumenti dell' Istituto*, vol. VIII, pl. 35; Dilthey, *Annali*, 1871, pp. 212-238; Lucy Mitchell, *A History of Ancient Sculpture*, pl. 6, p. 618; Schreiber, *Die antiken Bildwerke der Villa Ludovisi*, p. 131. Wolters (*Gypsabgüsse*, No. 1419), while objecting to the traditional name of Medusa given to that splendid piece of sculpture, notices that Prof. Brunn decidedly maintains it.

⁶ Lützw, *Münchener Antiken*, pl. 25.

⁷ Cf. Stephani, *Compte-Rendu de la commission de Saint Pétersbourg*, 1863, p. 89. Jahn contends that the head of Medusa on sarcophagi is not meant as a symbol of death and pain, but as an ἀποτρόπαιον (*Berichte der sächsischen Gesellschaft der Wissenschaften*, 1854, p. 47).

⁸ Cf. Levezow, *op. laud.*, p. 87. The winglets are a euphemistic transformation of the horns which appear in archaic monuments such as *Archäol. Zeitung*, 1881, pl. 17. Cf. *Arch. Zeit.*, 1845, p. 185.

⁹ Hesiod mentions two serpents around the Gorgon's waist (*Scutum*, v. 233 sqq.). Pindar calls Medusa ὀφιδῶς (*Olymp.* XIII) and the Gorgons παρθέναι ἀπλάται ὀφίων κεφαλαίς *Pyth.* XII). In the XIIth Pythic ode, the head of Gorgon is expressively styled ποικίλον κέρα δρακόντων φέβασιν. Aischylos speaks of the δρακοντόμαλλοι Γόργονες (*Prometheus*, v. 804). Cf. Apollodoros, II, 2. The entangled serpents in the Gorgon's hair are not, however, an ordinary occurrence in the works of archaic art (cf. Levezow, pp. 29, 82). One of the most ancient instances is a terracotta mask, now in Berlin, engraved at the end of Levezow's paper, pl. I, fig. 11.

¹⁰ Ovid (*Metamorph.* IV, v. 795) goes so far as to praise the beauty of Medusa's hair: *Nec in tota conspectior ulla capillis*

Pars fuit. . . .

the aspect of serpents, but only to those who are acquainted with the original type. Under the winglets and beneath the chin, uniting the extremities of the two terminal locks, there are circular bands which may be taken for serpents,¹¹ but are indeed, in many instances, more like taenias or neck-ties. The workmanship of the serpentine hair is perfectly regular and symmetrical, resembling an elaborate frame in wood or metal, rather than the natural waving of locks. It seems as if Medusa, no longer able to petrify her opponents, had finally petrified herself into the dull stiffness of an ornament. Such is the case with the Medusa of Constantinople. The expression of the face is neither coldly disdainful, nor painfully languid: it is harsh and almost ugly. The ugliness was probably not aimed at by the sculptor, but the harshness is certainly intentional, as may be seen from the wrinkled forehead, the frowning brow, and other details such as the ungraceful corners of the mouth. The eyes and the winglets still preserve distinct traces of blue painting; the nose is flat and vulgar, the mouth and chin are coarse, sensual, and realistic. On the whole, this elaborate piece of Roman workmanship, which has come to us in a state of perfect preservation, is, like the mythic figure it represents, a rather distant echo of Greek and Alexandrine tradition, and the only redeeming qualities which it can claim are characteristic of every art on the verge of decay: ornamental instinct and technical skill.¹²

II. The bust, which has been figured on the same plate, was found at Kyrene,¹³ and is perhaps an idealized portrait of the Empress Sabina, wife of Hadrian, who was sometimes represented under the aspect of various goddesses,¹⁴ and may have assumed in this instance the majestic appearance of Hera. It affords another illustration of the transformation and corruption of Greek models by the *fa presto* artists of imperial Rome. Although the surface of the marble has suffered a good deal from rain or dampness, the workmanship might

¹¹ The serpents forming a kind of neck-tie are often to be seen under the heads of Medusa; cf. Ross, *Archæol. Aufs.* I, pl. 8; Levezow, pl. IV, No. 44; pl. V, Nos. 47-51. The heads of the serpents projecting from beneath the winglets are very distinct in the Rondanini Medusa (Levezow, pl. V, fig. 50).

¹² A similar medallion, but of smaller proportions, was found at Pompeii, and is engraved in the *Museo Borbonico*, vol. XIII, pl. 23.

¹³ Reinach, *Catalogue du Musée Impérial*, No. 304.

¹⁴ Cf. Sabina as Ceres, in the Louvre, No. 593 (Duruy, *Histoire des Romains*, vol. V, p. 2); Sabina as Venus Genitrix, found in the Augusteum of Otricoli (*Museo Pio-Clementino*, III, pl. 8).

be praised as tolerably free and spirited, if it were not for the two locks of hair falling on either side of the neck. These locks resemble human hair but little more than do the serpentine curls of Medusa: they are metallic spirals awkwardly copied in marble. Here, again, we may observe a resemblance between late Roman clumsiness and early Greek inexperience: the graceful and lively treatment of hair was one of the last attainments of Hellenic art, and one of the first that Roman sculpture forfeited. In spite of this very great defect, the head in question is interesting as a not altogether unworthy reminiscence of the type of Hera such as it had been, according to Brunn's conjecture, created by Polykleitos. There is a striking resemblance between the head in Constantinople and the celebrated bust from the Farnese collection now in the Museum at Naples, where Brunn has recognized the influence of a Polykleitan model, whilst others prefer attributing its origin to Alkamenēs.¹⁵ The fact that female heads belonging to the same series are of comparatively rare occurrence adds some value to the bust of Constantinople, which, so far as I know, has been hitherto neither described nor engraved.

SALOMON REINACH.

¹⁵ *Museo Borbonico*, vol. v, pl. 9, 2; Overbeck, *Kunstmythologie*, pl. 9, 1, 2; *Monumenti*, vol. VIII, pl. 1, with Brunn's article in the *Annali*, 1864, p. 297. A good wood-cut is given by Lübke, *Geschichte der Plastik*, vol. I, p. 184.

THE TERRACOTTA HEADS OF TEOTIHUACAN.

II.

In the first part of this paper, clay portrait-heads, showing evidences of having once been attached to bodies made of a perishable substance, were discussed. In this second part the evidence of the Spanish chroniclers will be presented, showing that, at the time of the Conquest, there existed the custom of making small effigies of the dead, some of which consisted of a wooden body on which a portrait-head was mounted. As these effigies were invariably connected with mortuary customs a brief consideration of them is, first of all, necessary.

Among the Ancient Mexicans the circumstances attending the death of each individual determined the funeral ceremonies, and the form as well as the site of interment. The early writers¹ relate that they also believed the soul's future destination to be regulated by the circumstances of decease: thus "those who died a natural death, be they lord, noble, commoner or laborer, man, woman or child, were cremated, and went, after a long and difficult journey, to Mictlan, the land of the dead." The bodies of those who died of incurable and contagious diseases, or were killed by lightning or by drowning, were buried in special graves, and "went to Tlalocan, a terrestrial paradise." Finally, the warriors slain in battle or in the hands of the enemy, as well as the women who died in childbirth, went to the Sun, and extraordinary honors were paid to their remains. The courtyard of a special temple was dedicated to the interment of the women who, in the words of the old chronicler, "were canonized as saints and adored as goddesses." The skulls of the illustrious warriors were preserved, mounted on palisades, in a portion of the temple named Tzompautli.²

¹ Sahagun, *Historia*, Appendix to book III, chs. 1, 2, 3; Torquemada, *Monarquia*, vol. II, p. 530; Mendieta, *Historia*, p. 164; Clavijero, *Historia*, p. 147; Kingsborough, vol. VI, p. 227; Duran, *Historia*, vol. II, p. 114.

² Sahagun, book VI, ch. XXIX, book IX, ch. VI, Appen. to book II, in description of the great temple of Mexico; Bernal Diaz, *Histoire véridique de la Conquête*, trad.

Details will here be given only of the ceremonies connected with the first two kinds of funeral rites. In the case of those who died from natural causes³ and were cremated, an address was delivered over the body by the elders or priests whose special office it was, and who then proceeded to cut, prepare, and tie the papers with which the body was dressed. Its limbs were drawn up and it was tightly bound in its wrappings (*fig. 38*). Above this they put the raiment of the "god"^{3a} to whom the dead person had been especially devoted, or in whose temple the ceremonies were to take place.⁴ According to another writer,⁵ the body was dressed in the garb of the "god whom he had represented in life, for all noblemen did represent idolles and carried the name of one." In the accounts of the magnificent obsequies of several of the "emperors" of Mexico, it is stated that their bodies (and subsequently their effigies) were successively arrayed in

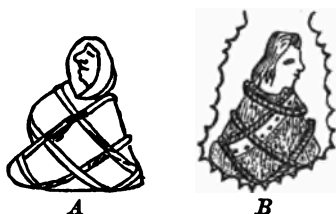


FIG. 38.—A, Orozco y Berra, *Atlas*, pl. 18; B, *Mappe Quinatsin I*, Aubin, *op. cit.*

the rich garments of the "four principal gods," this portion of the ritual devolving upon the highest in rank present. Describing the obsequies of the "emperor" Axayacatl, "who had represented in life our god Huitzilopochtli" (*fig. 39, B*, from Duran's *Atlas*, where this chief is depicted as dead), Padre Duran⁶ relates: "They made a large

Jourdanet, Paris, 1877, p. 252; Kingsborough; vol. vi, Codex Mendoza, pt. II, text to pl. LXXX; *Relacion de Andrés de T&osilva*, *Documentos*, ed. Icazbalceta, vol. II, p. 583.

³ Sahagun, Appendix to book III.

^{3a} It has been necessary in the first part of the paper and in this to retain the misleading terms used by the early Spanish writers, such as "gods," emperors, monarchs, etc.

⁴ Torquemada, vol. II, p. 521.

⁵ Acosta, *op. cit.* lib. 5, p. 349, where it is also related that "the priest who did the office of the dead was decked with the marks of the same idoll." In connection with the wearing of the distinctive garb of a deity by priests, see also Sahagun, book II, ch. XXI; Motolinia, trat. I, ch. v; Duran, vol. I, p. 283, vol. II, pp. 91, 92, 106.

⁶ Vol. I, ch. XXXIX, pp. 304, 306.

arbour called *tlacochoalli*, meaning 'house of rest or repose,'⁷ and in it they placed a statue, the portrait of the dead monarch, made of splinters of pine tied together," on which was mounted a head, "as of a person," decorated with feathers. They covered the image with a fine robe representing Huitzilopochtli: over this was hung the dress of the god Tlaloc, with the accessory symbolic decorations to be worn on the head or carried in the hand. "The next garment was that of the god Youalahua, and the fourth that of Quetzalcoatl."⁸

To return to the usual ceremony: the body itself, wrapped as before described, was conveyed some days later to the court of the temple, where, before the image of the god, stood a large caldron made of lime and stone into which it was thrown and consumed by the flames of the

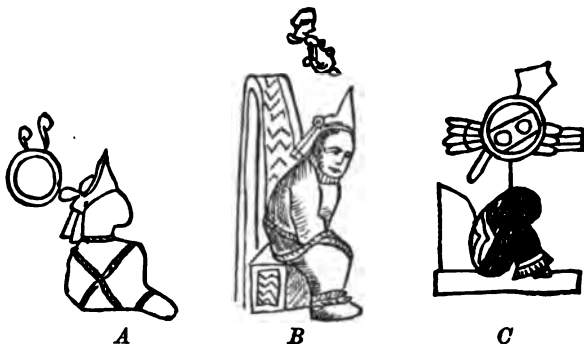


FIG. 39.—A, *Mapa de Tepochpan*; B, *Atlas Duran*; C, *Vatican Codex*.

"sacred wood," the priests stirring it with long poles. When the fire burnt out, the ashes were collected, water was poured over them, and they were buried in the ground; then, according to Sahagun, "the

⁷From the verb *cochi* = to sleep, and *calli* = house.

⁸See, also, the account of the funeral of the same "emperor" in Tezozomoc, *Cronica Mexicana*, p. 427. The body of Ahuizotl was clothed and anointed, and "thus he became consecrated as a god, and was placed among the gods." His remains were also consumed before Vitzilopochtli (Duran, I, p. 408). The "emperor" Tizoc was "dressed in the garb of four gods" and interred in the same place (Duran, I, p. 322). Of the same "monarch," Tezozomoc (*op. cit.* pp. 451, 455) states that "on the day after the cremation, whilst his portrait was being carved in wood, the kings of Texcoco and Tacuba . . . proposed to adorn his body in effigy and inter it solemnly." The following account of the funeral ceremonies, by Tezozomoc, is of interest. It is here related that "His body was placed, in squatting posture, on a fine mat, and was covered from the shoulders with 17 finely worked, thin robes,

remaining bones were placed in a jar,⁹ . . . which was then buried in a room of their dwelling," and daily offerings were made before it. At the end of a year the contents of the vessel were again burnt, the ashes buried, and the remaining fragments preserved. This was repeated until, at the end of three or four years, all was consumed, and thus the duties towards the dead came to an end. Torquemada mentions the keeping of the ashes and bones in earthen vessels (vol. II, pp. 523, 527), and among other details states: "They cut from the top of the head of the dead person a lock of hair; . . . and these, with the precious green stone, the bones and ashes, were placed in a small coffer of stone or wood, finely carved and painted both inside and outside. On top of this box they put an image of the defunct, made of wood dressed and adorned, and before it they placed offerings, calling this ceremony *Quitonallia* (from *tonalli* = portion, lit. "giving them their portion"): . . . each year in his memory, they sacrificed before the coffer, quails, rabbits, birds and butterflies: they also placed before the coffer and the portrait of the dead resting on it, much incense and offerings of food and wine, flowers and roses, also the incense sticks called *acayeltl*. These offerings were made once a year for four years."

Motolinia (*op. cit.*, p. 31) relates that the mourning and offerings were repeated, twenty days after the burial, and then at regular intervals of eighty days, during one year, and afterwards for four years only once a year, on the anniversary. He adds the important fact that, after death, to the name of each individual the surname *teotl* was added, meaning, as he says, "god or saint."¹⁰

From the collective evidence of the best authorities, it is therefore

over which a richer one was thrown bearing on it, beautifully embroidered, the image of Tezcatlipoca. His face was covered with a mask of gold, hollow and perfectly moulded so as to represent his physiognomy." When the remains of the "emperor" were reduced to ashes, these with the other relics were collected and placed "in a small coffer painted inside and outside with images of gods." This was tightly closed, and on it was placed a "statue carved in wood that was a perfect portrait of the 'emperor'; . . . both were afterwards removed to the temple by the priests, and placed in a sort of niche" (C. M. de Bustamante, *Texcoco en los últimos tiempos*: Mexico, 1826). See, also, Francisco Lopez de Gomara, *Cronica de Nueva España*, book II, p. 166, for description of an effigy of the deceased "king of Michoacan"; and Clavijero, ed. Mora, p. 192, where reasons are given for the dressing of the dead in the raiment of different gods.

⁹ Cf. Torquemada, vol. II, p. 528.

¹⁰ In corroboration of this, see Mendieta, *op. cit.*, p. 84; Sahagun, book X, ch. XXIX, § 12.

fully proved that the cremated remains of individuals who had died from natural causes were preserved, for a stated length of time, in a room of the dwelling set apart for the purpose: that, by inference, small portraits or images of the defunct, who was surnamed (such a one) *teotl*, or god, were kept with the remains, and prescribed periodical offerings placed before them. It is easy to understand how it came about that even these early writers themselves fell into the still prevalent error of supposing the Ancient Mexicans to have had in their dwellings "oratories in which they kept a number of idols, household gods that they adored and propitiated by daily offerings and sacrifices."¹¹

The true nature of these "oratories and idols" can be best understood by a careful sifting of the rather confused but very minute details, preserved by early writers, of ceremonies held during the year, on certain feasts in memory of those who had died from lightning, drowning, or certain contagious and incurable diseases, and after death went to Tlalocan.¹² "The body of such a one was not cremated, but was buried in a special grave. Twigs of the wild amaranth were laid upon his cheeks and face, and his forehead was anointed with *teaxtelle*, a blue dye."¹³

¹¹ "Within the doors of their houses they had oratories and special rooms where they kept their idols, just as nowadays they use them for sacred images" (Duran, vol. II, p. 295). Motolinia (tratado I, p. 33) says: "And in many places they had what were like oratories, where they kept great quantities of idols of different forms and shapes, . . . some like men, some like women, . . . others had diverse insignia by which they knew what "devil" they represented." The same writer says: "If, a hundred years hence, one were to excavate in the courtyards of the ancient temples of idols, one would ever find idols, for they made so many. When a child was born they made an idol, at the end of a year a larger one, after four years another, and as it grew up they went on making idols; and of these the foundations and walls are full and in the courtyards there are many of them." Query: were these idols not portraits?

Orozco y Berra, *op. cit.* vol. III, p. 409, gives an interesting incident preserved in the annals of the kingdom of Texcoco, in which it is distinctly related of certain murdered individuals, that a sculptured portrait was made of each one, and this, richly dressed and adorned, was placed on the wall in a room of the palace. Commenting on these, Orozco y Berra alludes to the "custom of the Mexicans of having Penates in their habitations."

Sahagun says (appendix to book II, § 5), "In honor of the gods which they had in their houses" they performed the daily duty of sweeping the dwelling and burning incense and making offerings to "the images."

¹² Tlalocan means literally "a place in the earth or ground."

¹³ See, e. g., Sahagun, book III, ch. I, § II; Torquemada, book VI, ch. XXXVIII.

In the 13th month, *Tepelhuill* (mountain festival), "a feast was held in honor of the mountains,¹⁴ and images were made in honor of them," and also "in memory of those who had been drowned, killed by lightning, or who had died in such a manner that they could not be burnt, but were, instead, buried." These images were called *ecatotontin*,¹⁵ and are described thus: "They made, of pieces of wood or stick of the thickness of the wrist, the foundations of tiny figures, resembling the dolls used by the little girls of our Spanish nation." So says Torquemada; while Sahagun compares the figures to "infant boys and girls." These pieces of wood were smeared with the dough *tzoalli*, and on the top of each piece of wood¹⁶ they put "a

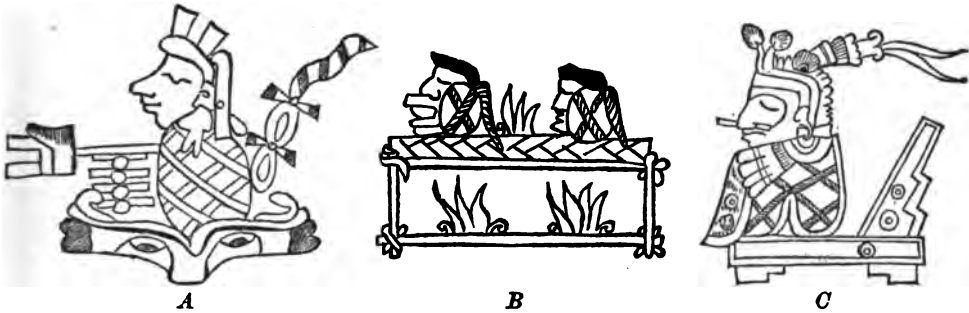


FIG. 40.—A, *Fejervary Codex*; B, *Bodleian Codex*; C, *Borgian Codex*.

¹⁴ Facts and quotations are taken from Sahagun, book II, chs. XIII, XXXII; and from Torquemada, vol. II, pp. 64, 279.

¹⁵ "According to M. Remi Siméon (Sahagun, trad. Jourdanet et Siméon, p. 71), this word is "the plural of *ecatontli*, the diminutive of *ecatl* = wind." The name "little wind" seems, however, in connection with these images, absolutely meaningless.

Drawing attention to the facts, (1) that Fray Sahagun wrote down this word under the dictation of an Indian; and (2) that "the Mexicans do not pronounce the letter *m*, . . . and thus say *exico* instead of Mexico" (Fray Andres de Olmos, *Arte de la Lengua Mexicana*: Mexico, 1547, parte III, cap. VI), it seems possible that the actual word may have been formed from *mecall* = cord. This is the common root of *mecayotia* = "to bind something with cords"; and *mecayoll* = "blood-relationship" (Molina, *Vocabulario*). A diminutive formed of either of these would, in accordance with the comprehensive character of the Nahuatl language, embrace the double meaning of the two words; and thus *mecayotontli* would mean "kindred, something small, bound with cords."

The reader who is acquainted with the vicissitudes of Fray Sahagun's original text will admit the possibilities of even greater errors in the orthography of names.

¹⁶ The Spanish word *trozo*, here used, is translated "piece of a thing cut off," or "a log of wood." The dough *tzoalli* is repeatedly mentioned by Sahagun and Duran, as "the material used by the natives for the manufacture of idols." The latter

head like that of a person." These images were then placed on "certain snakes made of wood or of the roots of trees, with a snake-head neatly carved on them." "Long rolls of the same dough were laid before them; these were called *yomio* (his bones)."

The most trustworthy of sources, the native pictorial representations, give us the actual appearance and the true character of the images described above; and in *figures* 40, 42, 45, 46, are numerous examples, taken from various sources, of mummied dead, drawn in a conventional manner, which even at the present day can scarcely find more apt comparison than to a *bambino* wrapped in its swaddling clothes. In *fig.* 40, *A*, is a woman's body thus tied, recognizable as such from the head-dress and her instrument of labor, the *mellatl*, on which the maize is even now ground, lying overturned before her. It is resting upon a "carved head of a snake," in which experts in Mexican picture-writings will recognize a well-known and often-used



FIG. 41.—*A*, Vienna Codex; *B* and *C*, Mapa de tributo (Lorenzana).

symbol, meaning "in the earth or cave." This alone points to the probable reason why this carved symbol accompanied the images of those who were buried in the ground, and gives us the important knowledge that the *ecatontin* were, undoubtedly, miniature effigies of the dead, and that,—when these "were placed with much ceremony on altars in the oratory, and they offered them *tamales* and other food, burned incense before them, and adorned them with flowers, also sang songs in their praise, and drank wine in their honor,"—it was but an observance of prescribed funeral ceremonies in memory of those

explains, more than once, that it was made of amaranth seeds and maize kneaded with black honey (vol. II, p. 197). Besides being edible, this material evidently possessed the valuable properties of plasticity, of retaining, while hardening, the shape into which it was moulded, and of fixing permanently objects set into it. Apparently the latter qualities alone caused it to be smeared on the "foundations of wood" so as to attach the papers afterwards wrapped about them, and to hold firmly in place the surmounting head which was set into the adhesive mass.

whose mortal remains were missing from the family resting place, but whose images were kept there and held in veneration.

The true character of the "oratories" is thus established; and, reviewing Fray Motolinia's testimony (see Note 11 and the whole of the passage quoted from), we see not only that such funeral chambers were found in the dwelling itself, but that "public ones" existed; and we can account for the very great number of so-called "idols," found in these and in the court-yards, by the natural inference, that the images of the dead were never destroyed, but were allowed to accumulate in stated localities.

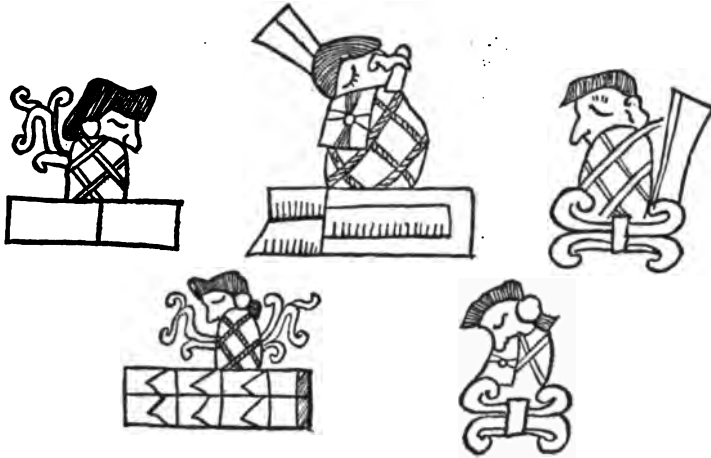


FIG. 42.—*Vienna Codex.*

It was believed that diseases such as gout, inflammation, lameness, paralysis, dropsy, were caused by the cold proceeding from the lofty snow-capped peaks that surround the Valley of Mexico. In the 16th month of the year *Atemoztli* (the falling of the waters), when the season of storms and rain set in, a feast was held in which a kind of propitiatory offering was made by those suffering from and exposed to these ills. The offering consisted of small edible images made of the dough *tzoalli*, used for similar purposes in other religious ceremonies. It was unlawful for any one but a priest to make these. He shaped them "like a mountain, but with the semblance of a person," giving them teeth of pumpkin-seeds and eyes of round black beans. These were decked with the consecrated papers on which the sacred

gum *ulli* had been dropped, that were hung "about the neck of the little images like a deacon's stole."

After certain ceremonies, these images were broken and the fragments exposed to the sun to dry, upon the roof of the house, whence they were taken each day and eaten little by little, "probably in the belief that cure or prevention was thus obtained." These images were, it is expressly stated, named *tepeme* or *tepicli*.¹⁷ In the Vienna Codex¹⁸ (Kingsborough, vol. II) the writer has found representations of these, one of which is given in *fig. 41, A*. It will be observed that it exactly answers the above description, and moreover that its contour is the well-known conventional broken line used in the drawing of mountains themselves in other Mexican picture-writings, two illustrations of which are given (*fig. 41, B, C*).



FIG. 43.—Seated figure. Author's collection.



FIG. 44.—Author's Collection.

Returning to the details, collected by Fray Sahagun, of the observances held in the "mountain festival," internal evidence shows that

¹⁷ *Tepeme* is the plural of mountain. The word *Tepicli* occurs in Bustamante's edition of Sahagun, vol. I, p. 72. In *Tepitoton*, translated "little ones," the meaning is misconceived, as is evident by comparison with the two preceding words. "This was the name given to the Penates and to the idols that represented them" (Clavijero, ed. Mora, p. 156). Cf. the mention of "Lares" in Torquemada, vol. II, p. 64.

¹⁸ The Vienna Codex, as well as the two MSS. preserved in the Library at Oxford, and known as *Arch. Bodl. H. 75* and *Arch. Seld. A. 2*, have been considered by Orozco y Berra (*Historia*, vol. I, p. 53), and by more recent Mexican authorities, to be "of *mixteco tsapoteco*" provenance. The writer, who has made a special study of these documents and taken particular care to compare the phonetic symbols contained in them with those in recognized Mexican codexes, does not hesitate to affirm that the three documents in question are purely Mexican, and are to be interpreted by means of the Nahuatl language.

the true nature of the *ecatontin* was, purposely perhaps, withheld from him, and that, at all events he has confounded them with the above-described edible, cure-working *tepeme* (fig. 41, A). He understood that both kinds of images were made at the above feast, and it was but natural that confusion should have arisen, and certain rites assumed to have been held in honor of the *tepeme*; whereas, the identity of these rites with the funeral ceremonies already described, and the totally different character of the *tepeme* lead to the conviction that they were in reality performed in memory of the dead before their portrait-effigies, the *ecatontin*. This enables us to comprehend many valuable details connected with such effigies, which complete the knowledge we have of them. Thus it is erroneously said, of the edible images, "their dress was according to the image of the god they represented" (book I, ch. XXI): "On both sides they covered the images with the papers called *tetcuill*, and put crowns of feathers on their heads" (book II, ch. XXXII). These papers are to be seen on both forms of images; see figures 41 and 42.

Finally, the size of the images is definitely ascertained by the following passages: "food was offered to each one (of these images), and the *tamales* they gave them were very small, in keeping with the images themselves, which were small. The food was placed in diminutive plates . . . two little cup-shaped gourd vessels were filled with *pulque* and put before them" (book II, ch. XXXV).¹⁹

A few words may now be said about the clay heads fractured at the neck, found at Teotihuacan, briefly alluded to in Part I of this paper, p. 159. Many of these exhibit the same character of workmanship, of head-gear, and of facial individuality, as the heads that form the subject of this article, but differ from them in offering unmistakable evidence of having been attached to bodies of clay. In some specimens the head is found in bas-relief on a portion of a flat thin background, and this probably formed part, at one time, of a complete representation of a corpse, such as shown in the specimen

¹⁹ "This accursed beverage (*pulque*, the fermented juice of the Agave) was a special offering to the gods, and in several sacrifices and offerings I came across (besides eatables) feathers, copal and other childish things, such as toys of bone, and little dishes of terracotta, and also beads; I found very small jars of *pulque* as well" (Duran, vol. II, p. 291). Light is hereby thrown upon the probable reason for the multitude of diminutive earthen vessels found in the ancient graves of Mexico. They have generally been thought to be children's toys, and to mark the burial-place of children.

from the writer's collection (*fig. 43*). Its seated position coincides with the testimony of the *Conquistador Anónimo* as to the mode of burial (ch. XXIV, ed. Icazbalceta).

Some of the fractured heads are broken across the base of the flat broad neck, on which traces of ornamentation exist. These may have belonged to the entire figures of clay, the existence of which is attested by innumerable fragments of limbs, hands, and feet, and of bodies over which draperies of clay were placed. These fragments would seem to indicate another form of effigy, in which the whole human figure was executed. Not having seen one of these entire, the writer has been unable to form a definite opinion of them, and is much more inclined to think that such heads were broken from the peculiar mummy-shaped objects so plentiful in collections. These are of a

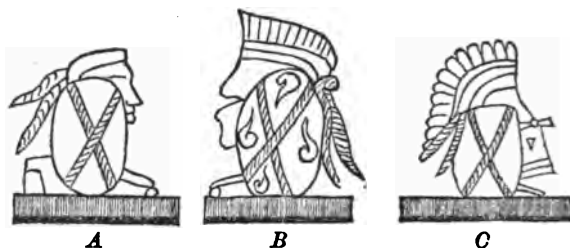


FIG. 45.—*Arch. Bodl. H. 75.*

single conventional form, invariably display a broad neck-ornament, and are pierced transversely in two places.

In *figure 44* is shown a possible manner of passing a cord through these perforations, by which its ends remain free for suspension, and the body assumes the familiar swaddled form invariably connected with representations of the dead. That such were actually suspended is proved by Torquemada, who says "in honor of the Lares (*Tepic-totons*), dolls made of wool, in the shape of infant boys and girls, were hung in the crossways; . . . these were similar in appearance to the dolls made in honor of the mountain gods."²⁰ Thus, after following a distinct line of research, we find ourselves again confronted

²⁰The following passage from Duran (vol. II, p. 274) evidently refers to the same custom: "On this the first day of the third month, Tozozontli, there was practised an abuse and superstition which I have actually seen in many places, indeed in almost all, at the present day. It is that, above their cultivated patches, they stretched cords from tree to tree, and from these, at certain intervals, suspended

by the *ecatontin*, the effigies of the dead; and we become convinced that with them alone rests the solution of the problem.

Numberless relics of various kinds, found in the same locality, are evidently connected with funeral ritual. Thus, fragments of large and small earthen vessels, the grotesque masks and heads of animals that ornamented them, spindle-whorls, beads of bone and stone, flakes of obsidian, arrow and spear heads, all seem to prove that burial customs were here observed. Finally, numerous little vessels, most of which are of coarse pinched clay containing two narrow deep cavities, show by their peculiar form their adaptability to hold the incense sticks, the burning of which constituted the most frequent of

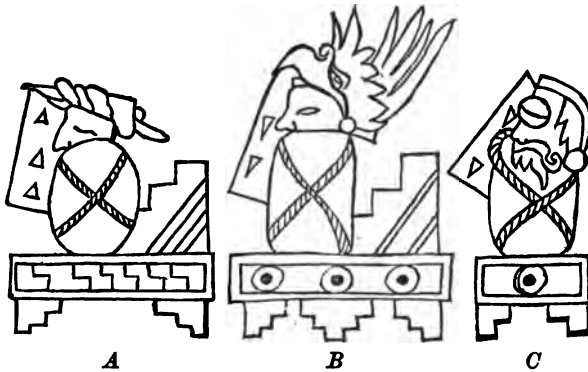


FIG. 46.—Arch. Selden, A. 2.

all offerings. That Teotihuacan was a place of burial, is a fact frequently mentioned by the early writers, but their testimony seems to have been lost sight of; and the opinion that it was used for this purpose at the time of the Conquest has never, to the writer's knowledge, been expressed. Considering the antiquity of the Pyramids, the conclusion to which the foregoing investigation naturally leads is of no ordinary interest.²¹

little idols, adding rags, or something or other, so that those who do not know or understand should think that these are scarecrows or children's toys: in reality it is but superstition and abuse."

²¹ The light thrown upon the existence of a form of ancestor-worship among the Ancient Mexicans, by this investigation, is one worthy of further consideration, and it is the writer's intention to present the materials collected upon this subject in connection with Teotihuacan as a place of burial.

From the statements here presented the following conclusions are drawn: (1) that, at the time of the Conquest, it was the prescribed and common custom to make effigies of the dead which reproduced in miniature the form of the bound body and the insignia of a deity with which it was invariably decked:²² (2) that, judging from the native pictures, such distinctive insignia were confined to the head alone, whilst the body was of a plain, conventional shape; one method of making it being of a piece of wood covered with papers on which, by means of an adhesive substance, a head, at times decorated with feathers, was set (*figs.* 45, 46): (3) that these effigies were of diminutive size, and existed in countless numbers in many localities: (4) that the peculiarities of the terracotta heads found at Teotihuacan, and the conclusions to which the study of them leads, fully justify the inference that they were at one time mounted on bodies similar in appearance to those described: (5) that this inference affords a satisfactory explanation of the existence of these heads, of their head-gears like those of Mexican "deities," and of the impressions which they show of a decoration that has been lost, and also accounts for their shape, size, and number:—and this explanation is offered as the solution of the "enigma of the many heads."

ZELIA NUTTALL.

²² Thus, the head-dress of one of the mummied bodies given in *fig.* 46, *A*, shows that a woman is represented, as will be seen by comparison with *figs.* 26, 27 in Part I of this article. *C*, of *fig.* 46, exhibits the Tlaloc symbols found in the clay head illustrated in *fig.* 21, Part I. This circumstance is rendered of special interest by Clavijero's statement: "He who met his death by drowning was dressed like the idol of Tlaloc" (ed. Mora, p. 192).

PROCÈS VERBAL DE L'OUVERTURE DES MOMIES DE SETI I ET SEQENENRA TAÀAQEN.¹

L'an 1886 et le 9 Juin, correspondant au sept de Ramadhan 1303 de l'Hégire.

En présence de MM. le Général Stephenson, commandant l'armée anglaise d'occupation, Garnier de Heldewier, agent et consul-général de Belgique en Egypte, le Général Comte della Sala Pacha et Madame della Sala, Eugène Grebaut directeur général des fouilles et antiquités de l'Egypte, Dr. Fouquet de la Faculté de Médecine de Paris, Insinger, Hervé Basile.

Par les soins de MM. Gaston Maspéro, ancien directeur des fouilles et antiquités de l'Egypte, Émile Brugsch Bey, conservateur, et Urbain Bouriant, conservateur-adjoint du Musée de Boulaq, il a été procédé dans la Salle dite Salle-Copte au dépouillement des deux momies qui portent au catalogue imprimé les numéros 5227 et 5232 et proviennent de la cachette de Deir-el-Bahari.

La momie No. 5227, extraite la première de sa cage en verre est celle du roi Seqenenra Taàaqen, xvii^e Dynastie Thébaine, ainsi qu'il résulte de l'inscription tracée sur le couvercle du cercueil à l'encre rouge, puis retouchée à la pointe. Deux grands linceuls en toile grossière mal attachés, la revêtaient des pieds à la tête, puis on rencontra quelques pièces de linge négligemment roulées et des tampons de chiffons maintenus par des bandelettes, le tout gras au toucher et pénétré d'une odeur fétide. Ces premières enveloppes une fois levées, il nous resta entre les mains une sorte de fuseau d'étoffe d'environ 1.82m. et tellement mince qu'il semblait impossible qu'un corps humain pût y trouver place. Les deux dernières épaisseurs de toile étaient collées l'une à l'autre par les parfums et adhéraient

¹Through the kindness of M. Ménant we have received from M. Maspéro, former director of antiquities in Egypt, a copy of the official report of the opening, in the Museum of Boulaq, of two royal mummies. We publish it in full, and tender our cordial thanks to the eminent Egyptologist. The two mummies were found, with several others, at Deir-el-Bahari, in July 1881, but had not yet been opened from lack of a suitable repository. This find was described by M. Maspéro in an important monograph (*La trouvaille de Deir-el-Bahari*. 20 photographies par E. Brugsch. Texte par G. Maspéro. Cairo, 1881), to which readers are referred for details of the entire discovery. A similar *procès-verbal* of the opening of the mummies of Rhamses II and III has just appeared in the *Revue Archéologique* of July-August.

étroitement à la peau : on les fendit au couteau et le corps entier parût au jour. La tête était renversée en arrière et inclinée fortement sur la gauche ; de longues mèches de cheveux éparses sur le front cachaient à demi une large plaie qui traversait la tempe droite un peu au dessus de l'arcade sourcillière. Les lèvres grand ouvertes étaient retractées de manière à former un anneau presque rond à travers lequel sortent les dents de devant et les gencives ; la langue était prise et mordue entre les dents. Les traits contractés violemment portaient encore une expression d'angoisse très reconnaissable. Un examen minutieux révéla l'existence de deux autres blessures. L'une faite par une massue ou par une hache d'armes avait entamé la joue gauche et brisé la mâchoire inférieure : les dents de côté étaient à découvert. L'autre dissimulée par les cheveux s'ouvre au sommet de la tête un peu au dessus de la blessure du front : un coup de hache dirigé de haut en bas avait détaché un énorme copeau d'os et produit dans la boîte du crâne une longue fente par laquelle une partie du cerveau avait dû s'écouler. La position et l'aspect des blessures permettent de rétablir d'une manière presque certaine la scène finale de la vie du roi ; Taâaqen atteint une première fois à la mâchoire tombe étourdi ; les ennemis se précipitent sur lui et deux coups portés tandis qu'il est à terre, l'un de hache au sommet du crâne, l'autre de lance ou de dague au dessus de l'œil, l'achèvent presque aussitôt. Nous savions qu'il avait fait la guerre aux Pasteurs : nous ne savions pas qu'il fût mort sur le champ de bataille. Les Egyptiens sortirent vainqueurs du combat qui s'engagea autour de leur chef puisqu'ils réussirent à le relever et à l'emporter. Le corps momifié rapidement sur place fût expédié à Thèbes où il reçut la sépulture. Ces détails nous expliquent et l'aspect saisissant qu'il présente et les irrégularités qu'on remarque dans l'embaumement. La poitrine et les côtes serrées à outrance par des gens pressés se sont brisées et ne forment plus qu'un paquet de débris noirâtres au milieu duquel les vertèbres sont éparses. Le bassin est en pièce, les bras et les jambes sont désarticulés. La décomposition avait dû commencer déjà au moment où les embaumeurs se mirent à l'œuvre : une large plaque blanchâtre entoure la plaie du front et semble n'être qu'une masse de chair mortifiée. La momie préparée à la hâte n'a pas bien résisté aux influences destructrices du dehors, les vers en ont percé l'enveloppe et des larves de nécrophore ont laissé leur coque dans les tresses de cheveux. Taâaqen avait environ quarante ans quand il succomba. Il était grand, élancé, d'une vigueur remarquable à en juger par ce qui reste des muscles de l'épaule et du thorax. Il avait la tête petite et allongée en tonneau, bien garnie de cheveux noirs, minces, ronds, frisés en longues mèches, l'œil était large et enfoncé, le nez droit et large à la racine, les pommettes proéminentes, la mâchoire forte, la bouche moyenne un peu avancée garnie de dents saines et d'un bel émail. L'oreille a dis-

paru et l'on ne voit aucune trace de barbe ni de moustache. Tiouaqen devait ressembler singulièrement aux Barabras d'aujourd'hui, et tout en lui semble indiquer une race moins mélangée d'éléments étrangers que celle des Ramsès.

Le cercueil No. 5232 renfermait la momie de Seti 1^{er}, troisième roi de la XIX^e dynastie et père de Ramsès II comme en font foi les procès verbaux de l'an VI et de l'an XVI de Hrihor, de l'an X de Pinotmou 1^{er} enregistrés sur le couvercle. L'appareil de bandelettes et de linceuls qui l'enveloppait était disposé de la même façon que sur la momie de Ramsès II; à moitié environ de l'épaisseur totale, une inscription hiératique en deux lignes tracée à l'encre noire nous apprend que l'an IX, le deuxième mois de "Pirit le 16 fut le jour où on rhabilla le roi Menmari (Seti 1^{er}) v. s. f." Une autre inscription tracée sur une des bandelettes ajoute que le linge employé à l'embaumement avait été fabriqué par le premier Prophète d'Ammon Menkhopirri en l'an VI, ce qui nous donne la dernière restauration subie par la momie du conquérant. Le corps présente à peu près le même aspect que celui de Ramsès II. Long, décharné, jaune-noir, les bras croisés sur la poitrine, les parties génitales ont été détachées à l'aide d'un instrument tranchant. La tête était couverte d'un masque épais de toile fine noircie par le goudron et qu'on dut enlever au ciseau. M. Alexandre Barsanti chargé de cette délicate opération fit sortir de cette masse informe la plus jolie tête de momie qu'on ait jamais vue au Musée. Les sculpteurs de Thèbes et d'Abydos ne flattaient pas Pharaon quand ils lui donnaient ce profil délicat, doux et souriant que les voyageurs admirent: la momie a conservé après trente-deux siècles la même expression qu'avait le vivant. Ce qui frappe tout d'abord quand on la compare à celle de Ramsès II c'est la ressemblance étonnante du père et du fils, nez, bouche, menton, les traits sont les mêmes, mais plus fins, plus intelligents, plus humains chez le père. Sêti 1^{er} est comme le type idéalisé de Ramsès II. Il dut mourir vieux, la tête est rase, les sourcils sont blancs et l'état du corps accuse la soixantaine et bien passée, ce qui confirme l'opinion des savants qui lui attribuent un très long règne. Le corps est sain, vigoureux, pourtant les doigts noueux portent des traces évidentes d'arthritisme; les deux dents qu'on aperçoit sous la pâte qui emplit la bouche sont blanches et bien entretenues.

G. MASPÉRO.

Fait à Boulaq, Juin 1886.

CORRESPONDENCE.

RECENT EXCAVATIONS IN ROME.

I.

During the winter, excavations were undertaken, with satisfactory results, on the Palatine hill, the cradle of Rome and afterwards the favorite residence of the Caesars. They were commenced and are being continued on the slope of the hill opposite the Velabrum, between the churches of S. Maria Liberatrice and San Teodoro.

On this hill, more than eight centuries before Christ, some Latin shepherds from the Alban mounts founded a rude village, a record of which has been preserved in the legend of Evander entertaining Aeneas and showing him the other villages on the neighboring heights. The village of these Latin settlers was afterwards transformed into a fortified city by a bold shepherd afterwards named Romulus, and, on the submission of the neighboring inhabited centres, formed the city of Rome: on this hill the primitive enceinte of the city, called from its form *Roma quadrata*, was long preserved.

Students of the topography of the city know that the enceinte of *Roma quadrata* on the Palatine can be established, from a well-known passage of Tacitus describing the pomerium, from the configuration of the hill, and from the few remains of the primitive walls. The four sides were approximately oriented according to the Etruscan rite: the north faced the *Velabrum*, the east the *Forum Romanum*, the south the *Coelian*, and the west the *Vallis Murcia*. Each of these sides had a gate corresponding to the four points noted by Tacitus (*Ara Consi*, *Curiae veteres*, *Sacellum Larum*, *Forum Romanum*), and the sites may be recognized in the natural accesses to the mount and in certain openings preserved afterwards as entrances to the Imperial palace. The names of only two out of the four gates are known, the *Mugonia*, and the *Romana*: we will name the others conventionally from the neighboring monuments. In the 1st (N.) side was the *Porta Romana*; in the 2nd, the *Mugonia*; in the 3rd, that of the *Septizonium*; and in the 4th, that of the *Lupercale*.

I shall speak particularly of the *porta Romana* and the neighboring localities where the above-mentioned discoveries have taken place. The

position of this gate is established by archæologists as on the N., just above the church of S. Maria Liberatrice. Varro says (*De L. L.* vi, 24), "Hoc sacrificium fit in Velabro, qua in novam viam exitur, . . . non longe a porta romana." From it led the *nova via*, according to the same writer (*De L. L.* v, 164), "porta romana ab Roma dicta quae habet gradus in nova via." As the *nova via* started in the Velabrum, and, hugging the east side towards the Forum, led to the *porta Mugonia*, the *porta Romana* should be placed on the N., and, as on this side, just above S. Maria Liberatrice, there exists an ancient entrance to the Imperial palace, this is probably its identical site.

The discoveries of three years ago, when the House of the Vestals came to light, confirmed this theory. A portion was then found of the *nova via* which divided the *locus Vestae* from the part of the Imperial palace added by Caligula, and to it led the rapid incline mentioned in Varro as descending from the *porta Romana*. A new proof of this position is found in Prof. Lanciani's studies on the temple of Victory, which gave its name to the *Clivo della Vittoria*: he found in Bianchini's work that this temple arose over S. Maria Liberatrice. The late excavations have laid bare other remains of the primitive enceinte of Romulus along the northern side opposite the Velabrum, and they follow exactly a line that joins on to the opening of the imperial period above S. Maria Liberatrice. These remains are always of the same construction as those already known, *i. e.*, large square masses of tufa *uniti a contrasto*. Here then arose that gate whose origin is anterior to Romulus himself, and which, according to Guidi's learned researches, belonged to the primitive Alban village and took its name from the river *Rumon* towards which it led, and which also gave a name to the city itself.

This being settled, it follows that the ancient road, at the bottom of which the gate opens, is the *Clivus Victoriae*, one of the oldest streets of the Palatine, represented in the Severian plan of the city: for Festus says that the *Porta Romana* rose "in infimo clivo Victoriae." The excavations, near this slope, uncovered the polygonal pavement of an ancient road which led down from the gate towards the Velabrum, passing behind the round church of San Teodoro. This cannot be the continuation of the *Clivus Victoriae* itself, as it would be in contradiction with the ancient texts and the topography: consequently, the *Clivo della Vittoria* was a street in the interior of *Roma quadrata* which led up to and ended at the *Porta Romana*. The road just now discovered is that which led from the Velabrum to the *Porta Romana*. Some archæologists have considered it to be part of the *nova via*, but this is impossible for various reasons: (1) it was only connected by *steps* with the *Porta Romana* (*see* Varro), and entered the city by the *Mugonian* gate; (2) the *nova via* was joined to the

via sacra by a descending flight of steps,¹ which was first recognized by myself in the new fragment of the Capitoline plan discovered in 1882. Consequently, under the N. point of the Palatine, three levels must be distinguished, indicated by three roads: in the lower, the *via sacra*, passing by the temple of Vesta; in the 2nd, the *nova via*, found three years ago; in the 3rd, the *Clivo della Vittoria*, ending at the Porta Romana, before which, on the left (facing the gate), the staircase descended to the *nova via*, and on the right, by a gentle incline, the road now found led towards the Velabrum. The recognition of this topographical arrangement is made necessary also by the very position of the *Locus Vestæ*.

These points being determined, I will return to the newly-discovered road, leading to the Porta Romana, which might well be called "Clivus portæ Romanæ." Its antiquity is proved by the discovery under it of a *cloaca* which follows its entire length. It is excavated in the tufa, its section is 1. by 1.70 met., and it has a vault composed of five square blocks, also of tufa, arranged in layers: this method of construction points to a very remote period, and is met with, for example, in the Mamertine prisons. In the sides of the gallery, which has already been cleared out to a length of 60 metres, there open up, at regular intervals, side-openings serving as outlets to minor passages, and all the waters were then drained off into the *cloaca maxima*, which passes, at a short distance, in the Velabrum. It appears to me that this gallery under the road of the Porta Romana should be referred to an extremely early date, and that it is, consequently, of especial importance for the study of the ancient hydraulic constructions, and the system of drainage, of primitive Rome.

Along the road there appeared many ruins, and others, already partly visible but filled with earth, were more uncovered. Among the latter were some piers formed of masses of tufa covered afterwards with brick walls, in which the authors of the *Guida del Palatino* proposed to recognize the *porticus Catuli*, an important monument of the VII cent. of Rome, commemorating the wars with the Cimbri. Now that these ruins can be better examined, it does not seem to me that these piers could have belonged to a portico, (1) because it is now seen that they back on to the natural rock and could not serve as a passage to any building; and (2) because they are so close to the newly-discovered road, that no space is left for a house to which the portico could belong. Bearing in mind that the N. wall of *Roma quadrata* passed just by the line of piers, and that the latter are or a construction identical with that of the walls of Romulus,

¹Ovid, in describing the matron descending toward the temple of Vesta, says, "qua nova romano nunc via juncta foro est, huc pede matronam vidi descendere nudo: obstupui, tacitus sustinuique gradum (*Fast.*)"

and join on to them, I put forward the conjecture that these piers may be the remains of the towers or buttresses which defended this part of the *enceinte*, all the more that this position is close to the gate. This I propose more as a suggestion, as it could not be satisfactorily proved except on the spot and with exact drawings at command. The ruins themselves were entirely transformed in Imperial times by being surrounded with brick-work, and by the use of the spaces between the piers for taverns, etc. If my conjecture should prove correct, then we would expect a similar set of buttresses near the other gates, and we should become acquainted with a hitherto unknown detail of the most ancient fortification of primitive Rome.

As for the portico of Catulus, adorned with the spoils of the Cimbri conquered by him and Marius at the battle of Vercelli, it is highly probable, as Visconti and Lanciani have pointed out, that it was in this neighborhood, where is also to be placed the house of Cicero, which, the great orator himself tells us, was near this triumphal portico, "vix pars aedium nearum decima ad Catuli porticum accessit" (*Pro Domo*, 44): this accords with these other words of his, "in conspectu totius urbis domus est mea" (*ibid.* 47). In fact, the N. declivity of the Palatine overlooks the Velabrum and the Forum, and is opposite the Capitol. This being the opinion of archæologists, it gave rise, at the commencement of the recent excavations, to the rumor that the house of the prince of Roman orators had actually been found, and strangers were shown as such a large dwelling-house recently discovered along the road on the left, going towards the Porta Romana. But this denomination is quite without foundation, as the construction of the house in question shows it to belong to the II or III century of our era. It consists of a number of chambers of brick-work with pavements in *opera spicata* and black and white mosaic; and in one of the rooms were found two bronze statuettes representing the two Mithraic genii that symbolize the two equinoxes. This house, quite independent of the Imperial palace, should be regarded as one of the *insulae* of the X Region of Augustus.

Some other discoveries were also made during the excavations on the *clivo*: on the right, under the substructures of the *Orti Farnesiani*, traces of an ancient house built on the natural tufa which is chiselled all around it; on the left, many brick walls connecting with the large house above-mentioned, and also a large and thick wall of *opus incertum*, a method of construction of the Republican period, preceding the *opus reticulatum*, and extremely rare in Rome.

In conclusion, the excavations have confirmed the topography of the northern part of the Palatine relating to the Porta Romana and the primitive walls, and have brought to light a most ancient road communicating

between this gate and the Velabrum, drained by an early subterranean passage, and adorned later with noble edifices.

II.

Important excavations have taken place during last winter in the ancient catacomb of San Sebastiano on the Via Appia. The history of this catacomb is of special interest, as the veneration for it has continued uninterruptedly, even during the Middle Ages when all other cemeteries were abandoned and forgotten. Its origin goes back almost to apostolic times before the existence of the greater part of the Christian catacombs: and according to an early tradition the bodies of the apostles Paul and Peter were hidden here shortly after their martyrdom. This is asserted by a hymn of Damasus (IV cent.) which was to be seen in the crypts, by a letter of Gregory the Great, by the itineraries, martyrologies, etc. Around the crypt in which these bodies are said to have had a temporary resting-place were grouped many tombs of the faithful; and, when St. Sebastian was martyred under Diocletian, his remains were buried here "apud vestigia apostolorum." His tomb was transformed into a sumptuous basilica, and around it were grouped many sepulchral cells and mausolea, of which some picturesque ruins still remain. To it was given the name *apud accubitoria*, or *sepulchra christianorum*, and by a hybrid formation *catatumbas*, *in catacumbis* and *catacumbæ*: this was the origin of a term that came to be applied to all ancient Christian cemeteries. Though these small catacombs of San Sebastiano always remained distinct from the great neighboring ones of Callixtus and Praetextatus, when the latter were abandoned in the early Middle Ages, all the veneration of the faithful was concentrated on the grottos of St. Sebastian which, through proximity to the basilica, remained accessible, and by a singular misnomer became known through the Middle Ages as the cemetery of Callixtus. Only thirty years ago was this delusion dispelled by the discovery of the real catacombs of Callixtus.

Last winter Comm. de Rossi in the name of the Commission of sacred archæology counselled the Ministry of public instruction, guardian of the basilica and crypt of S. Sebastiano, to undertake there some regular excavations. These were commenced on the first floor of the hypogeum at a point where the opening of a *lucernario* was already visible among the ruins. Under this, three large chapels were brought to light excavated in the tufa with the usual loculi and arcosolia in the walls, on which there also remained the inscriptions placed there by the early Christians. On one of the arcosolia is a marble slab on which is engraved a dove holding the olive branch between two monograms of Christ, a symbol of the soul

at peace in heaven. The largest of the crypts probably contained the tomb of a martyr, as near the end-wall was found a colonnette of the form of those which are known to be used for the placing of lamps kept burning in honor of a saint's tomb. Under the pavement of this chapel there came to light several tombs made there when the walls were already full of bodies. In one of these was found a real archæological curiosity: it is a tile used in the construction of the tomb, on which a Latin inscription was traced when the clay was still fresh. It records the ordering from Julius, by one Benevento, of four hundred tiles to be taken to a certain place: BENEVENTO TEGVLAS INDIXIT IVLIO NO. CCCV VT DEFERANTVR AD POR NEAPO (the latter abbreviation being doubtless meant for *ad portum Neapolitanum*): that is, to a depository of terracottas of this name, which must have been, like so many others already known, along the banks of the Tiber.

After the uncovering of these crypts and a few neighboring ambulacra, the work was concentrated on a point, but slightly distant from this story, where had been already seen traces of a staircase descending towards a story below. This staircase is broad and grandiose, its steps cut in the tufa being covered with stone: it was one of those state-staircases, built in the centuries of peace for the use of pilgrims, leading to the tomb of some illustrious martyr. This conjecture was strengthened by the fact that at the head of the stairs were the ruins of a building, doubtless an ancient oratory; and it is known that a basilica or an oratory was always placed at the opening of these main entrances. Up to the present time the bottom of the long staircase has not been reached, so that the results of the excavations will not appear until their renewal during next winter. In the mean time, it may be noted that, besides St. Sebastian whose tomb was turned into the basilica, a number of martyrs whose names are recorded in the early itineraries were entombed here. Among these the first rank was taken by bishop St. Quirinus and St. Eutochius, celebrated by Pope Damasus in a beautiful hymn preserved *in situ*.

Half-way down the above-mentioned stairway there was found, on the right, a side gallery: on the removal of the earth which filled it up to the vault, the excavators had the pleasant and rare surprise of finding an ambulacrum almost intact, with its tombs still closed by tiles and marble slabs. The destroyers of the Middle Ages and of more recent days, who violated almost all the tombs in the Christian cemeteries, had not reached this angle of the hypogeum, and we find it as it was left by the ancient *fossores*. The discovery of this rare model of a well-preserved gallery was immediately announced in the public press, and, as some of these tombs were still adorned with the glass vase which is sometimes a sign of martyrdom, it was rumored that at San Sebastiano there had been found a sub-

terranean gallery full of tombs of martyrs, and that the ecclesiastical authorities would provide for their veneration. All this, however, is entirely fanciful, as there is not the slightest proof that the tombs discovered belonged to confessors of the faith, and consequently ecclesiastical authority has not intervened. On the contrary, there is every indication that this gallery is a work of the period of the Peace of the Church, as the monogram of Christ, which came into especial use after the peace, is here of frequent occurrence. As for the glass vases fastened with plaster in the openings of the loculi, it is now demonstrated that, though under special circumstances and whenever there are evident traces of blood they should be considered signs of martyrdom, they are generally not so: it is believed, with great probability, that they are specimens of the glass cups from which the body was sprinkled with aromas and perfumes in the act of burial. Finally, the inscriptions which close the loculi in the walls possess the paleographic and stylistic characteristics of the IV cent. The following are the principal: (1) IVSTINVS SE BIBV | FECIT ✠—(2) BINCENTIA ✠ | IN PACE (dove)—(3) ✠ QVE BIXIT ANV | QVIRIACE IN PACE.

The staircase from which this gallery leads was found to be encumbered with marble slabs thrown down from above, perhaps from the oratory at the head of the staircase. Among these is deserving of special notice a bust of the Saviour sculptured in relief in a sort of rectangular frame. This sculpture, though badly damaged, belongs to the well-known iconographic type with pointed beard and hair falling on the shoulders, and has the characteristics of a work of the IV century. The fact that it is an isolated bust makes it, for the century to which it belongs, a unique example. The conclusion to be drawn would apparently be that this work is a sculptured image made for public veneration: as is evident to all, this fact would be of capital importance for the history of Christian art and ecclesiastical discipline during the first centuries.

Finally, I will mention that two inscriptions have come to light which belong to the tombs of the cemetery built in open air, and perhaps to those mausolea to whose ruins I have referred and which gave to the place the name of catacombs. Both have a consular date, one of Limenius and Catullinus, 340 A. D., the other that of the sixth consulate of Valentinian, 445 A. D.

The discovery of an historical crypt in the cemetery of Maximus, in which were buried S. Felicita and Silanus, one of her seven sons, has already been noticed on more than one page of this Journal (II, pp. 93, 354), and its fresco of the VII century representing her with her seven sons has been described. Their martyrdom took place under the emperor Marcus Aurelius in 162 A. D., as has been clearly proved, some time since,

by Comm. de Rossi.² A graphic account of it is given in a very early document, apparently translated from a contemporary Greek text, and is published in Ruinart's *Acta*.³ According to this account, the martyrs suffered in several places and by different judges, and would consequently have received burial in various localities. The earliest of the martyrologies or calendaries, the *Philocalian Calendar*, a document of the IV century, indicates the burial places of the martyrs, and these correspond with the groups of those who are said to have suffered. Thus Januarius was buried in the crypt of Praetextatus on the Via Appia; Felix and Philip in the cemetery of Priscilla; Alexander Vitalis and Martial in *cæmeterium Jordanorum*; Silanus in the subterranean chambers of Maximus on the Via Salaria, in which the recent discoveries have been made. The itineraries of pilgrims to the sacred places in Rome show that the tombs of these martyrs were held in special veneration and visited by crowds from the time of the Peace of the Church up to the VIII century.

The oratory is rudely built of tufa and bricks, and must have been roofed, as no traces of vaults have been found. A staircase of equal width led down to the hall, which was divided into three aisles by two rows of marble columns. At the end was the fresco of Felicita and her seven sons being crowned by the Saviour, in front of which rose the altar erected over the martyrs' tomb. The tomb is empty, as the relics were transported by Leo III (795-816) to the church of Santa Susanna, a fact which he commemorated by a mosaic which was unfortunately destroyed by Card. Rusticucci in restoring the church in 1595.

Among the inscriptions found in the crypt is one, bearing the consular date of the year 390, to the memory of a young woman named Constantia and Bonifatia, whom de Rossi⁴ sagaciously conjectures to be sister of that Boniface who, thirty years later, became Pope and erected over the oratory a basilica in honor of Santa Felicita. To the left of the oratory was discovered a narrow staircase leading down to a small irregular room excavated in the tufa: on the right of it opens an archway on which are remains of paintings and nails for the hanging of lamps. Under the arch is a cavity which certainly served to contain water: to it there leads a long water conduit, and an aperture for letting out the water is also visible. The only possible explanation is that this was a baptistery.

Orazio Marucchi.

Roma, July 1886.

² *Bull. di Arch. Crist.*, 1863, p. 29, sqq.

³ Ruinart, *Acta sincera*, Amsterdam edition, pp. 26-27.

⁴ *Bull. di Arch. Crist.*, 1884-85, No. IV, pp. 178-9.

REVIEWS AND NOTICES OF BOOKS.

LES ARTISTES CÉLÈBRES. PHIDIAS, par MAXIME COLLIGNON, Professeur suppléant à la Faculté des Lettres de Paris. Ouvrage accompagné de 45 gravures. 4to, pp. 128. Paris, 1886, Librairie de l'Art. J. Rouam, éditeur, 29 Cité d'Antin.

Every new book about Pheidias brings out anew two facts: how small our actual knowledge of him is, and how general the temptation to refer to him all that there is to say of the art of his generation. A marked quality of M. Collignon's book is its moderation in this respect. The author is very careful of dogmatism and over-statement, and watchful of the boundary between knowledge and conjecture. There are few subjects in which this care is more necessary. Pheidias is such a magnificent figure in the history of art, the things we know of him are so definite, our impression of them so precise and clear, the things that may have been true of him so obvious and enticing, the contrast between the positiveness of what we see and the dimness of what we do not see so disconcerting, that there is great temptation to fill up the whole picture with positive color and form. Here M. Collignon's reserve is excellent. He has given a good account of what is known about Pheidias, taking advantage of all the recognized authorities, and having due regard to others who have written on his subject before him. His interest in Pheidias has not led him to forget where conjecture begins, and the reader, whether disposed or not to go with him in all his inferences, does not lose confidence in the writer's accuracy and judgment.

In selection and arrangement the book is excellent, the salient points well marked, and the parts proportioned with that judgment which is a Frenchman's birthright. Without needless display of erudition it is brought up to the scholarship of its date, and is provided with an adequate bibliography and justificatory notes; so that while it is intended for general readers, like the rest of M. Rouam's series of *Artistes Célèbres*, to which it belongs, it is a book which the scholar reads with pleasure, and which shows the student the way to further research in its subject.

But what we know of Pheidias is not enough to make a book, and hence the salutary necessity, to which every writer on him yields, of including

with it the whole range of sculpture of the time and place in which he lived. This may be done in the biographer's spirit, on the assumption that all we have is Pheidias's, or we may discuss the whole sculpture of the Parthenon as the achievement of the age of Perikles, in which Pheidias is the foremost artistic figure. M. Collignon takes the more moderate view, and, while he sees in Pheidias the leading figure and probably the dominant force in Perikleian art, he does not make him absorb all the greatness of the great epoch of Athenian sculpture. All writers from Plutarch and Pausanias down have been so pre-occupied with the brilliance of Pheidias's fame, that one feels a strong desire to plead for the unknown great sculptors who must clearly have been his co-workers, and to complain that Perikleian Athens is belittled when it is assumed that she could furnish but one who was a master in the art. Perhaps even M. Collignon goes further in his attribution than the evidence requires, though not beyond the limit of reasonable conjecture. In discussing the sculptures of the pediments he says discreetly (pp. 63-4): "Deux caractères nous frappent surtout: la parfaite unité des deux compositions, et des différences assez notables dans l'exécution des statues. Considérez les deux frontons: vous y reconnaîtrez le même esprit, dans le groupement des figures, dans le mouvement des draperies, qui accuse un sentiment tout nouveau et une réaction marquée contre la timidité des anciennes écoles. Et cependant le style des figures est loin d'être uniforme: ici une facture plus large et plus sommaire, comme dans l'Héraclès; ailleurs, des délicatesses charmantes, comme dans le Céphise; quelquefois, comme dans l'Iris, un modelé moins souple et moins gras. Que des mains différentes aient travaillé à ces statues, on n'en saurait douter; mais quoi de plus naturel, si l'on attribue à Phidias seul la conception des deux frontons? C'est là en effet la solution à laquelle nous nous arrêterons. Nous imaginons volontiers Phidias déterminant le plan des frontons (M. Collignon means the composition of their sculpture) exécutant de sa main les modèles en terre, et distribuant entre les sculpteurs de son atelier la tâche beaucoup plus longue de les rendre en marbre. Nous irons même plus loin, et nous reconnaitrons la main et le coup de ciseau du maître dans les morceaux de maîtrise, tels que le groupe de Déméter et Coré, celui des Kharites, et le Céphise." This is very reasonable, and only suggests the caveat, on the one hand, that the same artist, if only he be skilful enough, may very well in a large and varied composition handle some figures with boldness and others with delicacy, according to their intended character and expression; and, on the other, that the "coup de ciseau" of Pheidias is perhaps that one of his technical qualities of which we have the least information.

In point of fact, the discussion of Pheidian art is much more complex than if it covered only the work or the influence of one man. The trans-

itional phase through which sculpture was passing was very like that which overtook ecclesiastical art, especially architecture, in Western Europe at the end of the twelfth century. We have not only to account with archaicism, conventionalism, a growing realism, an awakening artistic freedom; but to recognise the mingling of the bolder and simpler but more rigid Doric sculpture with the freer and more graceful Ionic, itself a complex of Greek and Oriental influences. To these are to be added the personal impulse and the actual performance of an exceptionally great master who, as we have evidence, overtopped all about him, and apparently both by his genius and his position exercised a masterful sway over those who worked with him, or at least carried off all the public applause which has come down to our time. Students and writers may naturally differ as to the part they ascribe to this exceptional master, the minuteness with which they trace his influence, and the limits they assign to his work. But where all is inference or conjecture a convincing deduction is not possible. The equations are too few for the unknown quantities. On these questions M. Collignon seems to take the most reasonable ground, ascribing to Pheidias the planning of the iconography of the Parthenon throughout, and to other hands the execution of all but the most important parts.

The chief characteristics of what one may call the Pheidian sculpture have come to be well recognized, and M. Collignon brings them out with clearness and insight. But I doubt if they are marked by a quality which is often ascribed to them, and which he mentions with some emphasis. Speaking of Pheidias's work, M. Collignon says: "Tout y est si simple et si grand, que cette perfection semble n'avoir coûté aucun effort." And again: "Seul il a possédé le secret de cette majestueuse simplicité, de cette grâce puissante et fière, de cette noblesse divine, qui donnent aux statues du Parthénon leur beauté radieuse, et leur éternelle jeunesse." Grand, noble, serene,—by turns majestic and graceful, and sometimes both,—such the sculpture of the Parthenon certainly is, and full of an unstrained masterly freedom apparently unattained till their time: but unity, breadth, singleness of effect, rather than simplicity, are their qualities—qualities which in the hands of a master give the impression of simplicity to work which is composed of multifarious elements. Only in the works of nature and of the greatest masters do we see the power to control a multitude of factors without constraint into an organized whole, and to turn complexity into transparent unity. When this rare mastery exists, to fail to recognize it is perhaps to omit the master's highest praise; and we are the more in danger of overlooking it in an age which is so enamored of slightness and sketchiness in works of art that it is losing its perception of the highest powers of composition. The composition of the pediments of the Parthe-

non is surely far from simple, and in the frieze one of the most conspicuous qualities is a marvellous facility in the handling of intricate combinations. To display the difference between real simplicity and the singleness of a masterful but complex composition we need only compare the Parthenon frieze with Flaxman's or Thorwaldsen's classical inventions. Nothing better shows the inferiority in power of the modern artists than to look at them in this light. Even in matters of detail the same thing holds. The draping of the single figures in the Parthenon pediments is more complicated than in earlier work. It is the wonderfully skilful combination of its lines that gives the figures and groups their effect of unity in spite of a multitudinous detail. Indeed, if I dared suggest a shadow of criticism of the sculpture of the Parthenon, it would be that the draperies in the pediments, in spite of their magnificent composition, and probably in the interest of the awakened naturalism of the time, were a little over-complicated; and that in parts of the frieze the gathering of horses' legs suggests the aptness of the popular sarcasm on Correggio's cupola at Parma. If we read Pliny's and Pausanias's accounts of the Parthenon and the Olympian Zeus, we must realize that elaborateness of composition could hardly be carried farther than in them; and, however we may feel assured that the genius of Pheidias could turn all this varied splendor to singleness of result, the descriptions show that the most luxurious inventions of Cellini would have been simple beside these.

Indeed there is encouragement to think that the greatest technical contribution to Greek sculpture of the age of Pheidias, very likely his own contribution, was just this splendid mastery of composition. In the Olympian and Aiginetan friezes we miss it. The figures stand well enough together, but as if they had been made apart—bought in different shops, and set together with sense and judgment. The pliancy, the freedom and yet sensitiveness to each other's neighborhood and to the prevailing unity which mark every figure and every detail of the Parthenon sculpture are wanting. The mastery of composition is not there. In Pheidias's time it is present. What a careful comparative study of the sculpture of the almost contemporaneous Theseion would suggest as to the order of its development, I do not know; but once acquired it is a permanent possession, and we see it in varying degrees through all the later phases of Greek and even Roman art. The Phigaleian frieze, the sculptures of Pergamon and Halikarnassos, the marriage-frieze at Munich, exemplify it; and it was perhaps that quality which the Romans best maintained in their sculpture, as we see in their sarcophagi and in its late decline in the reliefs of Trajan's column and the Triumphal arches. Pheidias had, and may have been the first to acquire, that power of combination, that exuberant fertility which distinguish Tintoretto and Paolo Veronese and Rubens among painters.

How he was possessed by the decorative instinct that belonged to the Ionic Greeks we may infer from the fact that his greatest works—at least the most conspicuous and most popular—were the chryselephantine colossi, in which the sumptuousness of his imagination found its extreme expression.

These qualities indeed are pictorial, qualities which belong primarily to painters, and were developed at the time when painted decoration came to its full bloom. We need not doubt that Pheidias owed them, at least in great part, to his unusual familiarity with all the fine arts. Of the tradition that Pheidias worked under Polygnotos, and the conjecture that he even had had a share with him in the wall-paintings which were his chief works, M. Collignon says nothing; perhaps because he thinks them not worth notice. But it is difficult not to see a painter's facility in the design of the Parthenon frieze, as indeed he remarks. But it was the distinction of the art of Pheidias's day, of Pheidias himself we may believe, that to its power of invention and combination, to its technical mastery at all points, it added the highest ethical qualities of art, if I may call them so,—majesty, purity, and with them exquisite gracefulness, and to all these, in spite of the unsurpassed affluence of its motives, a noble reserve, shown in the exclusion of detail that is not so controlled and ordered as to seem indispensable. It is this just balance of all the high qualities of art, elsewhere unreconciled, that gives the sculpture of the Parthenon its superiority to all the other sculpture that we know. If there was excess in any direction—and it is difficult to conceive of any vigorous human product without excess of some kind—it was probably in the direction of that sumptuous magnificence which has disappeared from our eyes, and in its disappearance has left the work of the Periklean age to our sight as unblemished as it belongs to human work to be.

With the vexed controversies concerning the identification of the subjects in the Parthenon sculptures M. Collignon's book does not much concern itself. Such discussions are too long to be brought into an essay of a hundred and twenty-five pages. If this leads the author to give the theories which he accepts with an air of assurance that is a little out of keeping with the judicial tone of the book, it is not with any disagreeable positiveness, but is obviously the result of conciseness. The arguments of Professor Brunn and Dr. Waldstein do not convince M. Collignon. The best-known figure of the eastern pediment, interpreted by them as Olympos, but popularly called Theseus, he prefers to consider Herakles. For the group of female figures on the right of the same pediment,—which have been the subject of endless conjecture, but most commonly spoken of as the Fates, two of them lately christened with plausibility by Dr. Waldstein as Thalassa and Gaia,—he offers a new conjecture, calling them

the three Attic Charites; and they are, as will be seen by the extract above quoted, among the few figures which he inclines to ascribe to the chisel of Pheidias himself. As the subject of the Cella-frieze, he accepts without question the Panathenaic procession, and the prevailing personations of the chief figures. Eschewing all controversy, M. Collignon confines himself mostly to what may be considered as known or generally accepted in the way of archæological comment. His artistic criticism is judicious, appreciative, and interesting, without assuming to penetrate the inner regions of the artist's mind, as much of the German criticism of the day attempts, and is on that account the more satisfactory.

Naturally, the sculptures of the Parthenon, and the stories of the Parthenos and of the Zeus at Olympia, occupy the most of Collignon's attention. The residuary account of Pheidias's latest career, and various traditions about him, are condensed into a part of the final chapter. The story of his prosecution and death given by Plutarch and Diodorus Siculus is rejected as antecedently improbable; the contradictory one quoted by the scholiast on Aristophanes from Philochoros is corrected by an emendation of Müller-Strübing, at cost of more ingenuity perhaps than the narrator deserves, and the conclusion reached, really by à priori reasoning, that Pheidias went acquitted to Elis, and died there in honor; a conclusion which on the whole answers as well as any to the conditions of a question on which we can hardly feel any assurance unless new testimony shall be discovered. A good estimate of the qualities of the Pheidian sculpture, and a fair statement of what may be inferred as to Pheidias's following and influence, close this essay, which may be summed up as clear, well arranged, interesting and eminently reasonable.

W. P. P. LONGFELLOW.

DICIONNAIRE DES FONDEURS, CISELEURS, MODELEURS EN BRONZE ET DOREURS, depuis le moyen-âge jusqu'à l'époque actuelle, par A. DE CHAMPEAUX, Inspecteur des Beaux-Arts à la Préfecture de la Seine. A-C. 12mo, pp. 357. Paris, J. Rouam; London, G. Wood & Co., 1886. [GUIDES DU COLLECTIONNEUR].

This work is the third of the series of the *Guides du Collectionneur*. It is to contain the names and works of all artists in metal from the earliest Middle Ages, a work greatly needed. The present thick volume is but a first instalment, covering only the first three letters of the alphabet. A detailed and critical review would therefore be out of place and must be deferred until the entire series is published: but we wish at present to call the attention of archæologists and of students of art to the great merit and usefulness of the work, which are already evident, and to the ency-

clopedic knowledge and patient research shown by the author. These qualities are conspicuous in this first volume, and leave no doubt as to the success of the undertaking.

The sources of information on which the author draws are not merely those which would naturally be consulted by a writer—even a first-rate archæologist—commissioned to perform a task for which he is reasonably well prepared: but the most unexpected and apparently unrelated publications are brought into requisition; monographs, which unfortunately are usually disregarded; memoirs; histories; etc. Of course, the inventories and accounts, catalogues, collections of inedited documents, guides, are carefully consulted. The impression is immediately conveyed that this is a labor of love, by one who has devoted many years to the collection of the facts now laid before us; and, though we may know it to be impossible for a single man to weave together the sum of knowledge and data in such a broad field of work, we feel confident that probably no one could have done the work better, if as well.

More than twelve hundred artists appear in this volume, and the references to authorities, where more details concerning them may be found, are generally made with profusion and accuracy. Often the writer seems disposed to give to an artist known only from documentary evidence more space than would seem necessary, and to devote but a short notice to men whose genius influenced the art of their time. In a work of this kind it is sometimes difficult to give to the different artists the right proportion of space. Artists of the highest talent, such as Carradosa (Foppa) ($\frac{1}{2}$ p.), Bandinelli ($\frac{1}{2}$ p.), Riccio ($1\frac{1}{2}$ p.), have but a short notice in comparison with those given to such relatively obscure artists as Cucci (2 pp.), Caffieri ($3\frac{1}{2}$ pp.), and Anguier (2 pp.). Even if the biography of these artists is too well known to need repetition, an enumeration of their works, such as is given in other less important cases, would not be out of place. The nine pages devoted to Barbedienne seem quite too long, even if the seven given to Christofle are more excusable. There are several points on which the work ought to be more complete in order to be of general use. A few American artists are mentioned (three or four) and these even are dismissed with a single phrase: this is a point on which M. de Champeaux could easily obtain information. Then a few names of Chinese, Japanese, and Mahommedan metal-workers are given: here also far greater completeness could be secured on application to specialists. Still, whatever may be the short-comings in matters of detail, this Dictionary must become the standard work, to which the necessary additions and corrections can be added.

Here are a few typographical errors: on p. 111, l. 17, for *periode* read *period*; p. 139, l. 2 *a. f.*, for *Laureti* read *Laurati*; p. 146, l. 4 *a. f.*, for

Morraena read Morrona, and l. 9 for Palerma read Palermo; p. 284, l. 20, for Schligo read Sligo.

One of the merits to be noticed is the almost consistent use by the writer of the real national names of the artists. The annoying custom of transforming foreign names into the forms of one's own language is happily becoming antiquated; but in France it still has a strong hold and appears entirely even in such works as Siret's *Dictionnaire des Peintres*. Le Corrége and Jean de Pise and Ste Marie des Fleurs, for Correggio, Giovanni da Pisa and Sta Maria dei Fiori, still flourish. M. de Champeaux, fortunately, does not belong to this school, and it is to be hoped that his example will be generally followed and that the time will come when not only each person will be given his own name, but each place will be called by its national appellation, so that we may no longer read of Plaisance, Venice, Florence, and Munich: but Piacenza, Venezia, Firenze, and München. In this connection, I may ask why does M. de Champeaux write *Bartolomeo de Modène*, *Bonano de Pise*, and *Agostino de Plaisance*, instead of *da Modena*, *da Pisa*, and *da Piacenza*.

A. L. FROTHINGHAM, Jr.

ARCHÉOLOGIE CHRÉTIENNE DE CARTHAGE.—FOUILLES DE LA BASILIQUE DE DAMOUS-EL-KARITA (1884) par le R. P. DELATTRE, de la société des Missionnaires d'Alger [Bibliothèque illustrée des Missions Catholiques]. Lyon, 1886, *Bureaux des Missions Catholiques*. 8vo, pp. 67, with illustrations.

During the last twenty years Africa has begun to rival Italy itself in the interest and importance of its remains of Early Christian art. In Algeria; and still more in Tunisia, a large number of basilicas of the iv and v centuries have been brought to light, more by chance than as the result of any systematic research; and there is no telling what might be found if money and men were forthcoming for the work. An example of what could be accomplished even with small means is shown by the pamphlet before us, written by that indefatigable lover of Christian antiquities the abbé Delattre, who from his convent on Mt. Byrsa near Carthage has acted as presiding genius over most of the archæological work in the neighborhood, and has formed a museum well worth visiting, as M. Reinach has well said in the *Nation* (No. 2000). The early Church at Carthage was, we all know, one of the great centres of primitive Christianity, and it would seem as if we were to have a glimpse of it as it was in those early days; not as in Rome where no desecrating hands have turned catacombs and basilicas to ruins, but in the fragmentary condition to which the monuments of Chris-

tian Carthage were reduced by barbarous invaders. One of these glimpses we get from the description of the results of the excavations made in 1884, which led to the uncovering of an Early Christian open-air cemetery and of an adjoining basilica on a site called Damous-el-Karita. The first attempts at excavating were made here in 1880, and have been noticed elsewhere. The present pamphlet is devoted to the main discoveries of 1884. The most interesting as well as unusual part of the work was the clearing out of the cemetery. We are all familiar with the underground catacombs which, naturally enough, have in general been tolerably well preserved; but the cemeteries above-ground, of which there were so many, exposed to weather and destruction, have almost all perished, throughout the Christian world, leaving no trace behind. Not more than two or three of any moment are known: one at *Julia Concordia*, and another but recently discovered at Mitrovitz, the ancient Sirmium. The open-air cemetery or *area* of Carthage is formed of a large semi-circular court more than forty-five metres in diameter surrounded by a high wall within which there was a lofty portico, 3.25 met. wide, whose architrave was supported on columns with semi-Ionic capitals standing at a distance of three metres from each other. In the open space were found hundreds of epitaphs from the tombs of early Christians. In the centre was an octagonal structure, which may have been a pulpit or ambo from which the *lector* read to the faithful assembled in the surrounding portico. Finally, at the head of the semi-circle the wall opened for an oratory or *memoria* in the form of a trifolium composed of three small semi-circular apses, each containing the tomb of an illustrious martyr. This oratory was entirely vaulted and its ornamentation must have been of the richest character, as a considerable portion of the fallen vaulting of the central apse still preserved its mosaic of white and red cubes, with which the whole was adorned. The date of this *area* is considered by the abbé Delattre to be the end of the III or the beginning of the IV century.

Across the end of the cemetery opposite the semi-circle was placed a monumental basilica of the IV century, corresponding in plan to the basilica of the Nativity erected at Bethlehem by the Empress Helena. The length of the central nave is 50 met., its width 12.80 met., and it ends in a semi-circular apse. It was supported on a double row of granite and marble columns, twelve on each side.

To summarize in a few words the other results of these excavations, they brought to light 1924 fragments of inscriptions (1 Punic, 8 Greek, 1915 Latin), 53 bas-reliefs, 36 fragments of sarcophagi, 28 of chancels or *ikonostases*, 200 plaques of marble from the revetment of the interior walls, 6 tomb-mosaics, 70 Christian lamps, 2 pagan lamps, several Roman and Byzantine coins, etc. An interesting peculiarity of the Christian epigraphy

of Carthage is the frequent use of the formula *fidelis in pace*, almost unknown in the thousands of inscriptions from the Roman catacombs. *Fidelis* distinguished a baptized Christian from one who was not, the latter being a catechumen. *In pace*, according to De Rossi, has quite a different meaning in African from what it had in Roman inscriptions: in the latter it meant a spiritual heavenly union, in the former a terrestrial communion with the Church. Africa was so overrun with heresies that even in death the faithful wished to affirm their fidelity to orthodoxy. *In pace vixit*, and *fidelis in pace*, are then formulas attesting this communion with the true Church, and this is shown by the fact of their coming into great use just at the time when the African church was most racked by heresy.

The most interesting piece of Early Christian sculpture found was a relief of the IV century representing the Virgin seated and holding the infant Christ, behind whom is a figure, probably a prophet; while to the left stands a guardian angel. This poetic scene is unfortunately mutilated in almost every figure, but it can easily be imagined that the prophet, as in the even earlier fresco of the cemetery of Priscilla, was pointing to the star above. It is disputed whether, behind the angel, the three Magi may not have been represented as advancing with their offerings, as on the almost contemporary ambone of Thessalonika.

The excavations have not been brought to a close, though they can be continued but slowly through a lack of funds. Much remains to be looked into. Neither the area of the cemetery nor that of the basilica have been entirely uncovered, and no steps have yet been taken toward excavations in a large cemetery back of the early area. In the plateau near the basilica there are indications of most important discoveries. The author says, "We are already certain of finding there a cemetery and large buildings, like a presbytery, monastery, triclinium or baths, dependencies of the vast basilica which we have undertaken to completely uncover." Will not some lover of the early Church hasten the work by contributing at a time when such help is most needed?

A. L. FROTHINGHAM, JR.

DIZIONARIO EPIGRAFICO DI ANTICITÀ ROMANE di ETTORE DE RUGGIERO. Fasc. I. ABACUS-ACHAIA. R. 8vo. Roma, 1886, Tipog. della R. Accad. dei Lincei.

This work promises to be of real value not only to Italian students of Antiquities but to all interested in the subject, as it will be constructed on a somewhat different plan from previous works of a similar character. The program is "to effect a closer union between the study of Latin epi-

graphy and that of Roman antiquities by diminishing as far as possible the technical and practical difficulties which most students encounter in making use of inscriptions for historical, archæological, and even juridical researches." The writer's main difficulty was one of selection: what words should be considered to have the right of entry. In this respect he resolved to confine himself to those well-proven words that had a strict relation to the different phases of ancient life. The greater part of the vocabulary selected refers, (1) to the mythology with its priesthood, institutions, and rites; (2) the political organization of Rome, Italy, of the provinces and municipalities; (3) the financial, judiciary and military administrations, and their special branches relating to mines, the mint, posts, roads, wheat supply, food, public works, etc.; the offices of the court, patrimony, chancery, council of state, libraries, etc., of the emperor; (4) the sources of private jurisprudence, as laws, *senatusconsulta*, edicts and constitutions, etc.; (5) social orders and corporations; (6) professions, arts and trades; (7) public games, popular celebrations, and many customs and objects of daily life.

The few pages of the dictionary contained in the first fasciculus of 32 pp. hardly enable one to judge even in general how well the program announced above is being carried out. The reputation of the author, however, is a good guarantee that the work will be done in a scholarly manner. Of special interest are the articles *Accensus* and *Achaia*.

A. L. F. JR.

SUMMARIES OF PERIODICALS.

BULLETTINO DI ARCHEOLOGIA CRISTIANA. Rome, 1884-5. No. 4.—O. MARUCCHI, *Report of the meetings of the Society of Christian archaeology, held in Rome during 1885.* The reports of these meetings form one of the most valuable features of Comm. de Rossi's periodical, and contain accounts of all the more recent excavations in the Roman Catacombs. Comm. le Blant called attention, at one of them, to a terracotta lamp with the subject of Tobit extracting the fish's gall, a subject not hitherto found on lamps. Prof. Marucchi showed the drawing of an interesting small marble ciborium probably of the VI cent. found in Venice, a unique prototype of the later large tabernacles. It was intended to be placed on the altar and to hold, suspended, the eucharistic dove. Prof. Marucchi also brought forward an inscription showing that under Pascal II, in the XII cent., a Roman artist named Jovianus worked at the basilica of S. Agapitus at Palestrina. Abbate Cozza identified, by means of a Vatican palimpsest of Strabo's geography (VII cent.), the island of Caudon with Gozo, thus determining the identity of Kauda where S. Paul stopped, according to Acts XXVII, 16. The Carlovingian origin of the well-known tessellated mosaic ornamentation so popular with the Roman artists of the XII and XIII centuries, was suggested by Comm. de Rossi; this being founded on the monument of Gero, Archbishop of Cologne (†976). He also made several reports on recent excavations in the Roman catacombs, especially in those of Priscilla, Callixtus and Domitilla. To the latter a new entrance has been discovered, leading to a section of the necropolis that may more properly be termed *cæmeterium Basilei*. Dr. Müller gave a detailed account of an interesting Jewish cemetery recently discovered near the Via Appia-Pignattelli. In the suburbs of Mitrovitz, the ancient Sirmium, the discovery has recently been made of a large open-air Christian necropolis, of which a description is given by the Abbé Hytrek.—G. B. DE ROSSI, *The cemetery of St. Syneros at Sirmium.* Publication and commentary of two of the inscriptions found in this important Christian open-air cemetery, which prove the principal martyr revered there to be S. Syneros who was martyred under Diocletian: (1) *ego aurelia . AMINIA .*
PO|sui TITVLVM VIRO MEO|fL SANCTO EX N. IOV. PRTEC|BENEMERITVS
QVI VIXIT|ANN . PL . M . L . QVI EST DEFVNC|TVS CIVIT . AQVILEIA TITV-

LVM|POSVIT AD BEATV SYNEROTI MA|RTVRE ET INFANE (sic) FILIAM|
 SVAM NOMINE VRASICINA|QVI VIXIT ANNIS · N · III. (2) EGO ARTEMIDORA
 FE|CI VIVA ME MEMORI|AM AD DOMNVN|SYNEROTEM INTE|RANTEM AD
 DEXTE|RAM INTER FORTVNA|TANEM ET DESIDERIVM.—G. B. DE ROESI,
*Discovery of an historical Crypt in the cemetery of Maximus ad Sanctam
 Felicitatem on the Via Salaria Nuova.* Report on the discovery of the
 crypt of S. Felicita with its frescos of this saint and her seven sons. This
 has been already noticed in the *News* on p. 93 of vol. II (cf. *Nuova Anto-
 logia*, Feb. I, 1886). The present paper contains: (1) an account of dis-
 coveries in the crypt, of which nothing but the bare walls and a fresco
 remain: (2) a notice of a painting representing S. Felicita and her seven
 sons, in an oratory near the baths of Titus (disc. in 1812): both these
 frescos are illustrated in pls. IX-X and XI-XII, the latter being considered
 without any doubt to be earlier and to belong to the v, the latter to the
 VII-VIII century: (3) a comparison of the two paintings, showing quite a
 different order in the arrangement of the figures: (4) the description of
 the crypt, a portion of which was transformed, at the close of the IV cent.,
 into a small basilica divided by columns into three aisles, and in which
 the writer conclusively shows that the body of Silanus, one of the sons of
 Felicita, was buried, and the church consecrated to him. Above ground
 was the oratory of Felicita herself, erected by Pope Boniface I (418-22).
 Finally it is shown that the new discoveries throw no special light on the
 questions raised by the acts of S. Felicita and her sons, acts the genuine-
 ness of which has been a matter of doubt.

A. L. F. JR.

BULLETIN DE CORRESPONDANCE HELLÉNIQUE. 1886. Mars.—
 G. COUSIN, *Inscriptions of Akarnania and Aitolia.* *Akarnania*: 1. Treaty of alliance between Rome and the city of Tyrrheion, evidently a translation, made in Rome, of a Latin text. The document is dated 94 B. C. by names of consuls and two praetors. The first known example of the custom of dating by consuls and praetors is but slightly anterior: i. e. the senatus-consultum of Astypalaia, 105 B. C. In the latter document the consuls have no cognomen, while in the former they have. In the senatus-consultum of Asklepias (78 B. C.) both consuls and praetors have the cognomen, thus showing a regular progression. The cause leading to this treaty, which gave to Tyrrheion so exceptionally advantageous a position in Akarnania, are not known. The inscription shows that M. Heuzey was correct in placing the site of Tyrrheion at Hagios Vasilios. 2. List of members of a society; fragmentary. 3. Twenty-six short and unimportant inscriptions from Akarnania. *Aitolia*: 1. Inscription from Kalydon, already published several times, but here fully illustrated: earliest example of the *proemia militaria*, as it dates from Sulla.—M. HOLLEAUX, *Excavo-*

tions at the Temple of Apollon Ptoos (contin.). I. Archaic bronze statuette (pl. IX), quite perfect except loss of feet: inscription on left leg: *Ἐὐγεντίας* (or *Ἐὐγεντίας*) ἀπέθεκε το(ῖ) Ἰπποῖσο(ι). Date, VI century. Both in type and proportions it bears great resemblance to the statuette of Apollon of Naxos at Berlin. In both, the head is crowned and the arrangement of the plaited hair the same: both show in the artist a scrupulously careful study of nature in details, and good workmanship. II. The second statuette (pl. VIII), somewhat oxidized and broken above the ankles, is of rude workmanship and earlier date: VI-VII century. The dedication, inscribed on the front of the body, is thus worded: *Κίδος ἀπέθεκε το πόλλωνι τοῖ Ἰπποῖσι*. The forms are heavy and angular, and there is no attempt to indicate, except by engraved lines, the muscles and secondary forms of the body.—P. FOUCART, *Inscription of Rhodos*. The writer has already published a monograph on religious associations among the Greeks. This inscription enables him to study in great detail one of these associations at Rhodos in the II cent. B. C. It gives the names of many members, with very precise information as to their origin, condition, family relations, etc., and throws light on many details of the organization. The majority of members were foreigners, from Alexandria, Antioch, Selge and Soloi, Knidos, Ephesos, Chios, Kyzikos, Symbra, Amphipolis, Lysimachia, Tenos, Hermione. This gives to this society a character different from those of the Peiraieus and Delos, in many of which the members have a common origin and have for main object the worship of a national divinity. This Rhodian society was founded by Nikasion and divided into three tribes, as in the Dorian cities. The inscription contains a list of victors at games celebrated by this society.—E. POTIER, *Excavations in the necropolis of Myrina*. Remarks on a collection of knuckle-bones with marks and inscriptions, found at Myrina, in connection with their use in games of chance.—M. HOLLEAUX and P. PARIS, *Inscriptions of Oenoanda*. The Turkish village of Urludja was first identified by Spratt and Forbes (*Travels in Lycia*, p. 172) as the site of Oenoanda, in Lykia. The inscriptions here published not only confirm this, but show that on the same site was the city of Termessos *πρὸς Οἰνοάνδοις*. 2. Shows that Licinius Mutianus, the friend of Vespasian, was governor of Lykia under Nero (c. 57). 12 other inscriptions are published.—R. DARESTE, *Inscription of Kalymna*. This inscription from the temple of Apollon at Kalymna was first published by Mr. Newton in 1883 (*Greek Insc. of Br. Mus.* vol. II): it is here commented and a translation offered. Its chief interest is in its legal aspect. Two citizens of Kos, Pausimachos and Hippokrates, probably bankers, made a loan to the city of Kalymna, the reimbursement of which was extremely slow, not being completed until the time of Kleophantos, grandson of Hippokrates. Persons representing the family of Pausimachos, the other and larger creditor,

brought a suit, judged before the strategoi of Knidos, against the city of Kalyrna, for paying the entire debt to the other party. Their suit was rejected by 126 against 78. The oaths taken by the judges, and by the contending parties are of special interest. To be noticed are the regulations concerning documents to be brought forward, written depositions, the time allowed each for discussion, the pleaders, the witnesses *in praesentia aut absentia*, safe-conducts, and cross-examinations.

APRIL.—F. DURRBACH and G. RADET, *Inscriptions of Peraea Rhodiorum*. Long before the Rhodians received Lykia and Karia from the Romans in 189 B. C. they had sovereignty over a strip of territory between these provinces, called the Rhodian Peraea (ἡ περαιὰ τῶν Ῥοδίων). It included such cities as Daidala, Kalynda, Pisilie, Kaunos, Physkos and Phoinix. The inscriptions here published come from the small peninsula opposite Rhodos now called *Darakia*, which forms the S. W. extremity of the Peraea. The sites of Phoinix (mod. *Phenikeh*) and Elaiousa (mod. *Alessa*) are identified, and the former proved to be a large city with an akropolis. No. 1 is a dedication, during the III cent. B. C., to "all the gods" by a prytanis and priests and hierophants of various sanctuaries. Athana and Zeus Polieus, Aphrodite, Asklapios, Sarapis are the divinities worshipped, and these were also worshipped at Rhodos. 2. This inscription, also referred to the same period in the III cent., is a list of contributions, suggested by a popular decree, for the construction of a temple to Dionysos: a complete list of the names of donators with the respective sum opposite each one: one Mnasagoras gave the land for the temple and temenos. This proves that, besides the above-mentioned divinities, Dionysos was worshipped in the Peraea, while another inscription (4) adds Apollon to the list. No. 6 is in honor of a benefactor of a society for the worship of Adonis. In No. 7 the community of a *κροῖα* decrees honors and a crown to a magistrate, Philoumenos. It shows that the Rhodian *κροῖαι*,—which were subdivisions of a city, grouped by a common worship, and distributed according to territorial divisions,—existed up to a late date.—M. HOLLEAUX, *Excavations at the temple of Apollon Ptoos* (contin.). Archaic torso, of Parian marble, reproduced on pl. VI: the head and greater part of arms are broken away, as well as front of legs. On each thigh was an inscription, of which only the beginning remains. The first is thus restored: *Ἰουθίας ἀρχαίφ[εδος] | καὶ Ἀσχιρίων ἀν[ε]θ[έταν]*. In the second, the epithet *[ἀργυ]ροτόχοι* must be a qualificative of Apollon. The two inscriptions formed but one dedication, which cannot be earlier than the middle of the V cent. B. C. There is every reason to assign this statue to the second and transitional series of "Apollon" figures: the facts of its discovery in the temenos of Apollon and its dedication, certify to its being a representation of the god. It is to be

compared to the bronze Apollon of Piombino (Louvre) and the marble Strangford Apollon (Brit. Mus.). The writer conjectures that all may be derived from the Apollon of Kanachos (Paus. IX, 10. 2).—M. CLERC, *The ruins of Aigai in Aiolis*. In the light of the more recent discoveries at Nimród-Kalessi made by the German archæologists Bohn and Fabricius (cf. Reinach in *Rev. Arch.* 1886, p. 161; JOURNAL, II, p. 214) and by Hamdi-Bey and M. Baltazzi, it is interesting to read this somewhat delayed account of the excavations undertaken here in 1882 by M. Clerc, a member of the French School at Athens, excavations of which full advantage could not be taken owing to the absence of architect and draughtsman. This paper does not touch upon the finds in the necropolis, which will form the subject of a subsequent paper, but only on those within the city limits. The acropolis is the most important of the ruins explored by M. Clerc. It was apparently rebuilt at several periods, and only small traces remain of the original Greek construction. There are two distinct concentric lines of walls: the first, often rebuilt, but with traces of Hellenic construction; the second, inner line, is evidently posterior to even the latest parts of the first. Within these walls was a large building of uncertain use with a complicated series of vaulted passages which, though formed of regular round-headed arches with voussoirs, show great inexperience. They may have served to join the walls to the akropolis. At the summit of the akropolis-hill are numerous ruins, the most important being a fortress-like monument, whose main front, well-preserved throughout its entire length of 82 met., rises to a height of 14 metres in the central section. The entire building is in the form of a rectangle, whose small sides are 28 met. long. The construction is regular and in the original state (dating according to Bohn and Fabricius from the time of the kings of Pergamon). The interior is divided into two parts by a wall 0.88m. high, each part being subdivided into sixteen nearly equal sections. On the front are twelve doors each opening into a chamber. These doors are trapezoidal in shape, and each has a window of similar shape close to the left, with a common lintel. The building was in several stories, but these have fallen in, and the chambers are filled in with débris to a height of six metres. Doric and Ionic columns and capitals have been found: also an unchannelled column, and one with wide and flat channels. The exterior of this building has a military aspect, but the small interior chambers, and the absence of convenient communication between them, contradict this theory. M. Clerc is disposed to consider it "a construction or reconstruction of the Roman imperial period." At about an hour's distance from Nimród-Kalessi on the rt. bank of the Kodja-Tchaï is an isolated ruin called by the natives Tchaï-Capou and identified by M. Clerc as the temple of Apollon Chresterios from an inscription which mentions

P. Servilius Isauricus proconsul of Asia 46-44 B. C. The identification of Aigai with Nimrūd-Kaleesi is made from topographical as well as numismatic reasons.—S. REINACH, *Engraved handle of a strigil found at Myrina*. Garrucci published in 1866 the only three strigils bearing figures on their handles that were then known. Some others with sculptured handles were found, especially at Palestrina, but only one with engraved handle has been found in Greece (Varvakeion Museum: Collignon, *Manuel*, p. 352, fig. 138). The strigil here published is the first one with engraved handle found in Asia Minor. It is in the Louvre. The figure represented is a youthful Hermes, with the petasos and holding a staff, standing on an Ionic column. The exquisite drawing recalls that of the best Greek mirrors.—CH. DIEHL and G. COUSIN, *Inscriptions of Alabanda in Karia*. The inscriptions hitherto known, coming from this source, have been few and unimportant. Those here published come from the villages of the Tchinar-tchai plain. 1. Honorary decree, probably of city of Alabanda. The person honored devoted his fortune largely to public benefactions, and was twice ambassador to Rome and once to a king not mentioned. This document indicates the period of the war with Antiochos when Alabanda wished to strengthen its alliance with Rome. 2. Inscription to M. Antonius Meleagros. 4. List of honors conferred on Aristolaos of Alabanda. 5. Similar inscription: name unknown.—E. POTTIER, *Excavations in the necropolis of Myrina* (contin.) (pl. xiv). Illustration of three terracotta groups representing the funerary banquet and a nuptial scene. After a short summary recapitulating the varied and contradictory opinions of archæologists as to the significance of this scene, M. Pottier proceeds to describe the groups here illustrated, considering them to represent the deceased heroized. In the two minor groups is a man extended on a couch, embracing his wife seated by him, and holding in his left hand a kantharos: the central group contains two reclining male figures, crowned, and holding a phialê, while a seated and crowned female figure plays on a triangular lyre. This treatment is rare in the terracottas. The monument on the lower part of pl. xiv is the largest, most perfect and important work found at Myrina. Broken into many pieces it has been carefully reconstituted. This charming group evidently represents a marriage scene, probably the episode of the *ἀνακάλυψις* or "unveiling," treated with great delicacy. The figures are both youthful, the male being only partially, the female entirely, draped; still, it is but another form of the funerary banquet to which a conjugal character is given.—MISCELLANIES. MICHEL ΠΑΛΗΝΑ ΚΟΝΣΤΑΝΤΙΝΟΥ, *Inscription from Tralleis*. It gives the name of the sculptor Philotechnos of Samos of the II cent. B. C., known from two other inscriptions of Samos and Delos.—S. REINACH, *A Jewish Synagogue at Phokaia*. An inscription from Pho-

kaia is important for a knowledge of the form and construction of the Jewish synagogues. It reads: *Τάτιον Στράτωνος τοῦ Ἐν-πέδωνος τὸν οἶκον καὶ τὸν πε-ρίβολον τοῦ ὑπαίθρου κατασκευ-άσασα ἐκ τῶ[ν ἰδ]ίων ἐχαρίσατο τοῖς Ἰουδαίοις. Ἡ συναγωγὴ ἐ[τείμη]σεν τῶν Ἰουδαίων Τάτιον Σ[τράτ]ωνος τοῦ Ἐνπέ-δωνος χρυσῶ στεφάνῳ καὶ προεδρίᾳ.* "Tation, daughter of Straton son of Empedon, having built, at her cost, the hall of the temple and the peribolos of the hypaithron, donates it to the Jews. The synagogue of the Jews has honored Tation, daughter of Straton son of Empedon, with a gold crown and the privilege of proëdria." The existence of a Jewish colony at old Phokaia, the metropolis of Marseilles, was not known. The organization of Jewish society seems to have been modelled on that of the Greek cities. This inscription is a new proof of the fact: it is the first Jewish text mentioning the privilege of proëdria = *πρωτοκαθεδρία* which gave her a seat on the bench of honor. Here we have the only known precise information on the construction of the Judeo-Greek synagogue. First comes the temple, *οἶκος*; then, in front of it the colonnade (*περίβολος*) surrounding the open court (*ὑπαίθρον*). Compare this with the arrangement of the early Christian basilica, as represented by that built at Tyre by Paulinus (313–22) and described by Eusebios. The arrangement is identical. Compare with this the arrangement of the private basilicas and that of the Greco-Roman house. This comparison throws light on the origin of the Christian basilica.—*Epigraphic Miscellanies.*

May-Nov.—GEORGES PERROT, *Note on some poniards from Mykenai.* Reproduction in three finely colored plates of five of the best preserved of these poniards, previously only imperfectly illustrated (cf. *Ἀθηναιον*, t. IX, p. 162; x, p. 309: *Mittheil. d. k. d. Inst.* t. VII, p. 241). These works of primitive art, though discovered by Schliemann in the tombs of Mykenai, were not cleaned and their ornamentation brought to light until lately by M. Koumanoudes (cf. *News of JOURNAL*, I, p. 231; *Revue Arch.*, 1884, II, p. 109). Some of the poniard-blades are simply of bronze ornamented with animals in relief: the majority are composed of three pieces of metal,—the body of the blade and two gold or bronze plaques, inserted on either side, on which all the decoration is placed. The figures are in one instance (pl. III, fig. 6) in relief, usually flat, and formed of sheets of gold or electron of varied tints. The forms and other details are indicated by outline with the point. Nearly 150 fragments of swords and poinards were found in the tombs of Mykenai, mostly ruined by oxidation. Cf., for similar technic, a vase from Mykenai (*Mittheil.* VIII, p. 1) and a sword-blade from Thera (*Mém. des Antiq. du Nord*, 1880, pl. VIII, p. 346). The slenderness of the figures, the selection and execution of the animals, the subjects chosen, all seem to M. Perrot to point back to Egypt as the source of the art which produced these works: this art was perhaps that of the

Phoinikians, at a time (XII–XI cent. B. C.) previous to any Assyrian influence over that maritime people. The execution itself is probably Phoinikian, possibly Mykenaian.—P. PARIS, *Inscriptions of Elateia*. Excavations on this site have not brought to light any of the monuments mentioned by Pausanias, but a number of inscriptions. 1. An archaic epitaph (?). 2–5. Four decrees dating probably between 223 and 197 B. C.; two being from the Phokian confederacy, two from the people of Elateia. 6–8. Other decrees of proxeny of later date, one in honor of the physician Asklepiodoros. 9. A *στοιχηδόν* inscription on base of a group of statues. It is a dedication to Poseidon of statues of national protecting demi-gods, whose names are not mentioned. M. Paris suggests that the occasion for the erection of these statues may have been the famous victory of the Phokians over the Thessalian invaders, before the Median invasion (Paus. II, 4.3, 29.3; X, 1.1, 4.10, 32.10). The archaic pointed Ω may be a reminiscence of the original inscription of which this may be a copy. 10. Dedication of a statue in honor of Lucius Cornelius Sulla Faustus, son of the Dictator, whose title of pro-praetor is here given for the first time. 11. On the base of a statue of Hadrian. Among the following inscriptions are four acts of enfranchisement, already published by Curtius (*Anecdota Delphica*) and of which a more correct text is given.—S. REINACH, *Six statuettes from Myrina*. On plates XI and XIV six figures are illustrated, of which two are replicas of famous statues, and the others are interesting examples of genre sculpture. (1) A child, naked, with a chlamys over his r. shoulder, holds a comic mask in his r. hand. The hair is interwoven with the vine and ends in a flat plait that falls on the shoulder—a variety of the *krobylos* head-dress. (2) A small Herakles standing by a *hermidion* with female head; it is evidently moulded from a bronze. (3) Eros with the attributes of Herakles: the wings are broken off. (4) A child playing with a bird to which it offers a bunch of grapes. (5) A female dancer entirely draped, with left arm concealed under the drapery which is held with the right hand: a peculiarity is that the head is that of an old woman (cf. Heydemann, *Die verhüllte Tänzerin*, 1879): the type appears to be borrowed from painting. (6) Reproduction of the type of an athlete by Myron, of which a number of copies in marble and bronze are known (cf. Brunn, *Annali*, 1879, p. 201; *Beschr. d. Glypt.* 4 ed. p. 213; Kekulé, *Ueber d. Kopf d. Praxitel. Hermes*, 1882), the best being at Munich. The imitation from Myron if direct would be unique in Asia Minor terracottas: it probably came through a Praxitelean adaptation.—MICHEL CLÉBER, *Inscriptions of Thyatira and neighborhood*. Publication of 31 inscriptions. 2. Inscription in honor of L. Licinius Lucullus quaestor and proquaestor in Asia from 88 to 80. 3. Letter of the proconsul P. Cornelius Scipio to the city of Thyatira: confirming Waddington's opinion that he was placed

over Asia. He was consul in 16 B. C. 8. Inscription of Menelaos who is here related to have given hospitality to the emperor Marcus Aurelius Antoninus, who might be either Marcus Aurelius, Commodus or Caracalla. It would seem to be the latter whose visit to Asia Minor took place in 214 and 215. 26. Inscription of importance for the date of the proconsul Marius Maximus, who commanded troops besieging Byzantium from 193 to 196, took part in 197 at battle of Lyon, was consul *suffectus* in 197 or 198, legate *propraetor* of Germania Inf., Belgium and *Cœlo Syria* between 198 and 209, urban prefect in 217, and consul for the second time in 223. The inscription was erected either under Heliogabalus (218–22) or Alexander Severus (222–35); and it proves that M. Waddington was right in placing the two years of his proconsulate in Asia between 214 and 216, as his first year corresponded to the sojourn of Caracalla at Thyatira.—CH. DIEHL and G. COUSIN, *Unknown cities of the Ceramic gulf, Kedreai and Idyma*. On the E. side of a small island, now called *Seïr-oglou*, were found antique ruins of considerable extent, on a hill joined to a low plain covering the W. side of the island. The city was surrounded by a wall, and on the N. side is a perfectly-preserved theatre of considerable size. Other ruins were found of the agora (?), a Doric temple, etc. One of the three inscriptions found shows the name of the city to be *Κεδρεαί*, an ancient city mentioned among the cities of Karia by Hekataios of Miletos, as early as the VI, and a tributary of Athens in the V, century. The second inscription commemorates the dedication of a statue in the temple of Athena by the son of Kleipidas: the third is set up by the association of the Dioskouriasts, or worshippers of the Dioskouroi, and the statue was by the Rhodian artist Simias, son of Pythokritos, hitherto unknown, but whose father is probably identical with the Rhodian sculptor of the middle of the II cent., Pythokritos son of Timocharis. Bargasa, which with Keramos is the only city mentioned by Strabo on the Ceramic Gulf between Knidos and Halikarnassos, has been placed at Djowa near the coast, where there are still many ruins. This is now proved to be a mistake by the discovery of an inscription there which shows that the ancient city occupying this site was Idyma, mentioned by Stephanos of Byzantium among the cities of Karia: it was also a tributary of Athens.—F. DURRBACH, *Inscriptions of Larissa*. These 13 inscriptions come from the Turkish cemeteries of the city. 1. A very defaced and much mutilated text engraved on a marble stele. The preamble is interesting because it is the first known document emanating from the Thessalian league, though several exist headed by the name of the strategos: these magistrates were instituted in 196 B. C., and this one is posterior to 179. The second magistrate mentioned, the *hipparchos*, had not before been known. The question involved seems to be a dispute between two cities of the confederacy between which the city of Mylassa is requested to

intervene as arbitrator. The inscription also proves that the archives of the confederacy (*κοινόν*) were deposited at Larissa; in this case in the temple of Zeus Eleutherios. 2. An inscription already published (*Mittheil.* VIII, p. 112, No. 1; Collitz, *Dialekt Inschrift.* No. 1286), but of which a better copy is given. 3. This is on a marble stele with an agonistic inscription similar to that published in *Mém. de l'Acad. des Ins.* t. XXVI, pt. II, p. 43 sqq. (cf. another in *Arch. des Missions*, 1876, p. 309 sqq.). The date is end of I or beg. of II cent. of our era. The list of games is long and of great interest, including many rare or new terms: bull-fights, literary contests, *προσδρομή*, torch-light race or procession, etc., are among the entertainments.—MISOELLANIES. P. F., Publication of two fragments: the first is of a decree of end of IV cent. voted by Salamis to a benefactor: the second enumerates payments made for work executed in various public buildings, including the Odeon and the Parthenon, which would have been of great interest if less fragmentary.—*Epigraphica.* A. L. BROTHINGHAM, JR.

BULLETIN MONUMENTAL 1885. Sept.-Oct.—A. DE BARTHÉLEMY, *The reliquary of Saint Tudual at Laval* (plate). The reliquary of silver gilt, probably given to the church by Anne de Laval (mid. XV), was destroyed in 1790; but the small ivory box containing the relics, and given probably at the same time, was preserved and is here illustrated. It is of Persian origin, and is ornamented with hunting scenes.—P. DE FONTENILLES, *The Tomb of St. Peter Martyr of Verona, at the church of S. Eustorgio in Milan* (end).—L. BRUGUIER-ROURE, *The Mutilations of the church of the St. Esprit at Pont-Saint-Esprit.*—DELORT, *A new Sepulchral cippus with an inscription and a half-figure, found at Auzerre* (plate). The inscription is simply, APINVLA · SOLINI · FILIA. The D. M. show it to be pagan = Gallo-Roman.—ABBÉ PORÉE, *The Hercules of Thil* (Eure) (plate). This statuette was found used as material in the XVII-cent. castle of Thil. The writer is in doubt whether it belongs to Gallo-Roman art or to the Renaissance.—H. JADART, *The house of Dom Mabillon and his monument in the church of Saint-Pierremont* (Ardennes).—B. DE RIVIÈRES, *Horat inscriptions and devices* (end).

Nov.-Dec.—Canon DEHAISNES, *The processes of the primitive Flemish School and oil painting.* This is an extract from a work soon to appear in three 4to volumes, entitled *Histoire de l'Art dans la Flandre, l'Artois et le Hainaut, avant le XV^e siècle.* The remaining works of the primitive Flemish school have preserved their tone better than most paintings but a half-century old, and this paper seeks for the causes of this perfection in the materials used by these early painters. The writer proves, from documentary evidence, oil painting to have been in general use for a full century before the Van Eycks [citation from *Liber diversarum arcium* of

xiv cent.]. The documents brought forward to prove this are numerous and convincing. Though refusing the invention to John Van Eyck, in opposition to Vasari and many modern writers, the author considers him to have introduced certain improvements.—F. DE MÉLY, *The reliquary of Saint Tugual at Chartres*. Critical notes on this reliquary and the notices that remain of it. Completion to information given in the previous number by M. de Barthélemy.—B. BERNARD, *Saint-Lizier: paintings, coffer and sarcophagus*. Drawings, accompanied by a descriptive text, of these works of art still remaining in the old cathedral of Saint-Lizier.—E. LEFÈVRE-PONTALIS, *The baptismal fonts of Urcel and Laffaux (Aisne)*. Publication of two fine Romanesque fonts the like of which are very rare in the North of France. That of Urcel is composed of a column flanked with four engaged colonnettes, standing on a high square base. That of Laffaux is very similar, except that it is more ornate and the four colonnettes instead of being engaged are separate, though the bases join: the latter especially is of remarkable elegance and executed probably c. 1160.—Comte DE MARSY, *Archæological courses in the Great Seminaries, and the preservation of works of art in religious buildings*. This address upholds the foundation, in all the diocesan seminaries where such do not already exist, of courses of instruction in Christian archæology; brings out the close relation existing between religion and the works of art which it inspired; and shows the necessity for the clergy to know something of architectural styles, in view of restorations, and of the value of early church furniture, in consequence of the bold attempts of antiquity-hunters. M. de Marsy's views were fully adopted by the *Congrès des Catholiques du Nord* in an interesting and detailed series of resolutions.

1886. Jan.-Feb.—Comte DE MARSY, *Notice on the Société Française d'Archéologie*. An account of its foundation by M. de Caumont in 1834, of its organization, scope and objects, and of the work it has performed during the fifty years of its existence.—A. DE DION, *The date of the church of Saint-Germer de Flay (Oise)*. This important example of transitional Romanesque has been often studied, but no accord has been reached, among archæologists, as to its date; some of lesser authority have fixed it between 1030 and 1060 for textual reasons, but Boeswilwald, Viollet-le-Duc, de Laurière and others place it in the XII century. In this paper M. de Dion asserts, (1) that the church was built between 1035 and 1058, (2) that the purely Romanesque parts of the church date from this time or a little later, but in no case from the middle of the XII cent., (3) that the Gothic portions added to replace the roof by vaults, and involving the reconstruction of the arcades and the vaults of the aisles, took place in the middle of the XII century.—E. LEFÈVRE-PONTALIS, *New study on the date of the church of Saint-Germer: Answer to M. de Dion*. In the *Biblio-*

thèque de l'Ecole des Chartes (t. XLVI, 1885, p. 475) the writer published a full monograph on this church, to oppose which was the main object of the preceding article by M. de Dion. M. Lefèvre-Pontalis, while not repeating his former thesis, shows in this paper that the arguments advanced against him by M. de Dion arise from a lack of acquaintance with the monuments of the province, which show that the architects of this region long used simultaneously the round and pointed arch before they decided to systematically adopt the Gothic style. The writer's exposition of the architectural peculiarities of the important group of churches in the Beauvaisis and the Soissonnais are luminous and complete.—LÉON GERMAIN, *The tomb of Isabelle de Musset, wife of Gilles de Busleyden at Marville (Meuse)* (pl.). In the remarkable cemetery of Marville, is the chapel of St. Hilary, whose foundation dates back to the beginnings of Christianity in this region. Among the important monuments which it contains, there is one belonging to the late Gothic period with traces of the early Renaissance, which has hitherto remained anonymous. The writer has succeeded in identifying it by means of its two coats of arms. Gilles de Busleyden married Isabelle de Musset in 1455, and she died in 1506. The defunct is represented reclining with her feet resting on a lion, and holding a rosary in her joined hands. In four late-Gothic niches, two on each side, are small figures of St. Christopher, St. Gilles, St. Jerome and the archangel Michael. The writer considers the tomb to belong to the "Barrois" school of sculpture (Bar-le-Duc).—J. DE LAURIÈRE, *Archæological tour in the Val d'Aran*. This province, though on the French slope of the Pyrenees has always belonged to Spain. The principal castle of this district was that of Castellón, unfortunately destroyed: two of its monuments remain and are described.

March-April.—J. DE LAURIÈRE, *Archæological tour in the Val d'Aran* (contin.). At Salardu, the church preserves a Romanesque south-wall with portal: here and in other churches in the Pyrenees we often find the monogram of Christ χ with the A and ω : the summits of the X are also curved so as to form a P. The construction of the church belongs to the end of the XII or beg. of the XIII century. The most interesting work of art it contains, is the *Santo-Christo*, a crucifix of wood (c. 1200) of good art, which is one of the most interesting known examples. A jubilee in its honor was established in 1316. Uгна has a castle of the XVI and a church of the XII century, and Trédos a fine church of the same date. This latter church possesses a remarkably beautiful processional cross in silver gilt of the beg. of the XVI cent.—HENRI THÉDENAT, *Two children's masks of the Roman period found at Lyon and Paris*. I. In the tomb of a ten-year old girl, Claudia Victoria, discovered at Lyon in 1874, was found a mask of her taken after death (pl.). This goes to prove that the ancients

were in reality acquainted with the use of plaster-casting. It was probably taken by the child's mother as a memento, and afterwards placed in the tomb. As a side issue, the subject of wax portraits is discussed. II. At Paris, in 1878, in the necropolis found on the site of the Marché du Port-Royal there came to light a sarcophagus containing the body of a little child: by a singular chance, when, in the Roman period, the burial took place, some of the fresh plaster which was to cement the cover fell on to the child's face and produced a natural cast, giving quite a good portrait (pl.).—LOUIS COURAJOD, *The Révoil Collection in the Louvre*. Pierre Révoil, a French painter of little merit at the beginning of this century, made for his own use a collection of monuments of considerable value, already famous in 1811. It was purchased for the State in 1828, and an interesting letter of Comte de Clarac regarding its purchase, and giving a detailed description, is published. It is followed by several letters interchanged on the subject between the collector and Comte de Forbin, director of the Royal Museums, and between the latter and M. de la Rochefoucauld and M. Artaud, the royal commissioner.—J. DE BAYE, *The torques was worn among the Gauls by men*. The collar or torques has been attributed exclusively to distinguished warriors among the Gauls: lately some archæologists considered its use to belong to women only. The writer undertakes to show that its use was common to both sexes, and finds many texts as well as monuments that support his theory: it is especially clear that the *torques* was worn by warriors.

May-June.—E. MÜNTZ, *Portable Byzantine mosaics*. These small mosaic-tablets are a specialty of Eastern art, and were highly prized as devotional pictures. Very few have been preserved, and these date, in the writer's opinion, from the XII and XIII centuries. Two only of them were known to Unger, three to Labarte, but the present notice describes fifteen: which are preserved in the Louvre (2); in the Vatican Museum and the Palazzo Borghese at Rome; at S. Marco and S. Maria della Salute in Venice; at the *Opera del Duomo* in Florence (2); at Donauwerth and Burtscheid in Germany; in the South Kensington Museum; at Chimay, Belgium; in the Basilewsky Collection at St. Petersburg (2); and at Mt. Athos (Vatopedi). The material workmanship of these tablets is of the most exquisite and minute description, and in the two in the *Opera del Duomo* at Florence, the separate cubes, of glass, composition, marble and metal, can hardly be discerned by the naked eye. A heliotype plate reproduces the circular tablet of the Louvre which represents St. George killing the dragon, one of the latest of the series, and probably attributable to the XIV century. Though but few have been preserved, there existed a large number in the private and public collections of Italy at the time of the Renaissance. M. Müntz publishes extracts from inventories of the

collections of Card. Barbo, afterward Paul II (23 examples), of Card. Bessarion (seven), of Lorenzo de' Medici (seven); showing that these works were highly prized.—H. JADART, *The Abbey of Hautvillers (Marne) and its monuments*. Of this early foundation there remain but a few vestiges of the monastic buildings, but the church, though much ruined by restorations, retains a considerable portion of its early structure: *e. g.* the main portal, the two side-walls with their round-headed windows, and the lower part of the tower on the S. of the apse belong to the XII cent. There are no tombs existing that date further back than the XVI cent.—L. COURAJOD, *The Révoil Collection at the Louvre*. This second article gives in full the catalogue of this collection under the headings of, (1) offensive and defensive arms; (2) furniture; (3) coffers; (4) vases; (5) faïence dishes; (6) utensils for private use; (7) ladies' toilet articles; (8) jewels and *pietre dure*; (9) clock-work; (10) ancient enamels; (11) later enamels; (12) portraits and paintings; (13) miniatures and drawings; (14) glass-painting; (15) statuettes; (16) bronze busts; (17) bronze medallions; (18) silver medallions; (19) works in ivory; (20) musical instruments; (21) bronze seals; (22) locks, knockers, etc.; (23) crosiers; (24) ancient stuffs; (25) wood-sculptures, etc.—P. CHARDIN, *Collection of heraldic paintings and sculptures* (contin.). Monograph on the arms of the cathedral of Tréguier, including information on the church itself. A. L. F. JR.

ΕΦΗΜΕΡΙΞ ΑΡΧΑΙΟΛΟΓΙΚΗ. JOURNAL OF THE ARCHÆOLOGICAL SOCIETY IN ATHENS. 1885. No. 4.—P. KABBADIAS, *Inscriptions from Epidaurus*. The first four inscriptions (Nos. 88–91) were originally placed in an *exedra* built by one Sodamos and his wife Laphante in commemoration of themselves and their family. These inscriptions, together with Nos. 14 (*Ep.* 1883, p. 31) and 75 (*Ep.* 1884, p. 29), give the genealogy of the family for five generations. Nos. 92 and 93 are cut upon a rectangular pedestal. The original dedication was replaced in late Roman times by one to Thiasos, son of Aristodamos, but the original artist's inscription *Ἀθηνογένης Ἀριστομένου, Λαβρέας Δαμοκείθους Ἀργεῖοι ἐποίησαν* was left (cf. *Ep.* 1883, p. 153, No. 52; Löwy, *Inschriften griech. Bildhauer*, No. 269). No. 94, cut upon a rectangular pedestal, tells in three hexameters that Drymos, son of Theodoros, an Argive, brought the news of an Olympic contest to Epidaurus, running thither on the very day of the contest. The date given is "Alexandrian times." No. 95 gives the names of two Athenian artists, Nikomenes and Timostratos, who flourished apparently in the IV cent. B. C. (cf. Löwy, *Ins. gr. Bild.* No. 131, a). Of the original dedication only τὸ κοί[νον] remains. The name *Ἀρία Ἀριστίππου* was added later. No. 96 tells us that Olympias and Olympiodoros and Nikis dedicated to Apollon and Asklepios a statue of their

father Nikatas, son of Nikatas, of Hermione. No. 97 tells of a votive offering to Athena Polias dedicated in consequence of a vision by Dadouchos priest of Asklepios Soter. No. 98 reads: *To Artemis Orthia, Dionysios* (dedicated this) *in consequence of a vision*. The same person, apparently, dedicated to Apollon Orthios the offering mentioned in No. 28 (*Ep.* 1883, p. 89). No. 99 records a dedication to Helios and the Dioskouroi made in consequence of a vision by Secundus Pomponius Hilarianus. No. 100, cut upon an Ionic epistyle, records a dedication to Asklepios by Aristarchos, son of Erginos. The date suggested is "Alexandrian times." No. 101 records upon a plate of bronze a dedication to Asklepios by Kallistratos the cook. The letters are archaic. The Δ of Ἀσκληπιῶ is wanting. No. 102 (figure in the text) is a marble tablet upon which are represented two human ears. Below is the inscription: *Cutius has auris gallus tibi uouerat olim | Phoebigena, et posuit sanus ab auriculis.*—E. LOEWY, *Artists' Inscription from Atalanta*. An inscription is published giving the names of two Theban artists, Stroton and Polynikos. The form of the letters is that of the IV cent. B. C. The inscription is cut upon two stones which together formed an arc-shaped pedestal. Upon this once stood two figures.—S. A. KOUMANOUDES, *Inscriptions from the Excavations in the Market-place at Athens* (inserted plate, and 3 figs.). Eleven inscriptions are published, which were found on the site of the bazaar lately destroyed by fire. No. 1 is in honor of T. C. C. A. Germanicus Imp., Savior of the world: the date is the 4th generalship of Tiberius Claudius Novius. No. 2, and apparently No. 3, is an honorary inscription to the Emperor Hadrian. Nos. 4 and 5 appear to be fragments of honorary decrees. No. 6 consists of five wretched distichs engraved upon a fluted drum of a Doric column. The Kekropidai and Dysikles had set up a statue of P. Erennios Dexippos, a man of note in the III cent. A. D. No. 7 is a fragment of a dedication by a priestess Pomponia Clara. No. 8 consists of three small fragments of a decree of the V cent. B. C. relating to a temple of the Dioskouroi. A fourth fragment is published *C. I. A.* I, No. 34. No. 9 is a new publication of *C. I. G.* I, 226, *b* (Add. p. 909). The stone, which had disappeared, has come to light again. The name of the archon is without doubt Charias, not Chabrias. In the list of archons the name Chabrias appears for the year 415 B. C. Perhaps this inscription gives the true reading. No. 10 (2 figs.) consists of two fragments of inscriptions, which the editor believes were part of the original laws of Solon, or a copy of them in stone. No words can be read upon the stone, but their peculiar shape leads the editor to reconstruct the $\alpha\lambda\lambda\omicron\upsilon\epsilon\varsigma$ of Solon (cf. Harpokrat. *s. v.* δ $\kappa\alpha\tau\omega\theta\epsilon\upsilon$ $\nu\omicron\mu\omicron\varsigma$). No. 11 (facsimile) is similar to an inscription published in *Ep.* 1885, p. 168. A similar inscription is given in small text.—CHR. D. TSOUNTAS, *Krater from the Akropolis* (pls. 11 and

12). On the front of this vase is represented Theseus killing the Minotaur in the presence of Ariadne and Minos. Theseus has seized the Minotaur by the horn, and is about to dispatch him with his sword: Ariadne stands ready with a garland to crown the victor. An Ionic column at each side of the picture shows that the combat takes place within the labyrinth. On the other side of the vase are Orneus, Pallas, Nisos and Lykos as spectators of the combat. Each figure has its inscription. The krater dates before the eastern front of the Parthenon. The figures are red upon a black ground. The place where it was found, the style of the painting, and the forms of the letters fix the date of the work at about 450 B. C. or very little later.—K. D. MYLONAS, *Bronze Satyr in the collection of Johannes Demetrios* (cf. pl. 6). The satyr published in pl. 6 is described and discussed. The right arm below the elbow and the fingers of the left hand are wanting. These parts are restored to correspond to the Naples satyr (*Mus. Borb.* ix, pl. 42 = Clarac, pl. 717, No. 1715 A). The supplementary plate gives drawings of the Naples satyr and the new satyr with restorations. The common prototype of these two works is referred to the age of Lysippos, and it is suggested that Lysippos himself may have been the artist (Plin. *H. N.* 35, 64).—P. KABBADIAS, *A Korinthian Capital from the Tholos of Polykleitos* (pl. 10). The capital in question is published and discussed. It differs in some particulars from the conjectural reconstruction made by Dörpfeld (*Πρακτικά*, 1883, pl. 4, No. 2) with the aid of such fragments as had then been found. The Tholos and Theatre of Epidauros are referred to the younger Polykleitos.—K. PURGOLD, *An Archaic Pediment from the Akropolis* (continued from *Ep.* 1884, p. 117). The pediment-relief representing Herakles in combat with the Hydra (*Ep.* 1884, pl. 7) is compared with other representations of the same scene, especially with two vases (Heydemann, *Gr. Vasenb.* vi, 1; *Ep.* 1884, pl. 7, 4). Directly or indirectly, the painters of the vases in question seem to have taken this relief as a model. An illustration in text represents an additional fragment of the Hydra. A discussion of a small fragment of another relief (*Ep.* 1884, pl. 7, No. 2) follows. The opinion is expressed, that this fragment comes from the other pediment of the building to which the first-mentioned relief belonged, and, further, that the scene represented was the combat of Herakles and Triton. The same scene is represented on part of the frieze of Assos, a cut of which is given in the text. Finally, the style and execution of these reliefs are discussed. Of the fragment supposed to represent the combat with Triton so little is preserved that the discussion is confined mainly to the other relief. The ground of this relief was of a yellow color somewhat deeper than the natural color of the stone. The figures were brightly colored, the shades used being darker than the background. The stiffness and heaviness of the forms together

with the ignorance of the laws of rhythm in pedimental composition displayed in this relief show it to be the oldest extant specimen of Attic sculpture. Perhaps the end of the VII cent. B. C. would not be too early a date.—TH. SOPHOULES, *A Korinthian Kylix* (pl. 7). The publication of fragments of a kylix from Korinth leads to some remarks upon Korinthian vase-painting, and especially upon the fixed types or schemata employed by the vase-painters. Upon the base here published is represented a combat of men on foot and in chariots. The lower stripe is occupied by a number of figures dancing, with drinking horns in their hands, about a huge bowl. In the inside of the kylix are two female heads with inscriptions, *Νεβρίς* and *Κλύ(τ)α*.—Z. D. GABALAS, *An Inedited Inscription of Pholegandros*. The inscription reads: *Τειμῆς Σωσιπέλου | τὴν ἰδίαν μητέρα | Πραξιόπων Τειμεως | θυγατέρα, ἦν καὶ | ὁ Δῆμος ἐτετιμῆσεν | Θεοῖς*. The form *Τειμῆς* and the name *Πραξιόπων* are new.

1886. No. 1.—B. N. STAES, *Musical contest of Apollon with Marsyas* (pl. 1). The painting of one side of a bell-shaped krater from Krete is published. To the left of the centre, beside the trunk of a tree, sits the satyr playing on the double pipe: beside him is a wine-jar. The extreme left of the picture is occupied by Artemis. In front of Marsyas is Athena richly clad, wearing a helmet and the aegis, and carrying a spear. A Nike with a taenia is flying from Marsyas toward Athena. On the extreme right stands Apollon. For comparison, a similar but somewhat simpler representation is published as a supplementary plate (after Lenormant and De Witt, *Élite céramogr.* II. pl. 69). In spite of the central position of Athena, it is maintained that these paintings represent the first scene of the contest between Apollon and Marsyas. On the reverse of the Kretan krater is a satyr between two maenads.—S. A. KOUMANOUDIS, *Inscriptions from the Excavations in the Market-place at Athens* (contin.). Nine inscriptions are published, mostly fragmentary, of late date and small value.—P. KABBADIAS, *Heads from the Figures in the Pediments of the Temple of Athena Alea* (pl. 2). Of the pediment-sculptures of the temple at Tegea only two human heads and the head of the boar are extant. One of the human heads is here published, and the opinion is expressed that it is the head of Atalanta. It consists of two fragments, the face being split from the chin up through the right eye. A helmet or cap like that here represented is not elsewhere given to Atalanta.—D. PHILIOS, *Eleusinian Reliefs* (pl. 3). Two reliefs are published, which were found in the ruins of a small *templum in antis* at Eleusis. No. 1 is well preserved but of poor workmanship. At each end of the relief is a column or anta; above is a cornice representing a roof. At the extreme right a bearded male figure lies on a couch, resting upon his left elbow. He holds a small box in his left hand, while his raised

right hand holds a drinking horn. At his feet sits upon the couch a female figure holding something in her hands. Before these figures is a table upon which are various objects. Above the head of the male is the inscription ΘΕΩΙ; above the female ΘΕΑΙ. To the left of these figures are seated two females: one holds her hand above the head of the other, against whose shoulder a sceptre is leaning. Before these figures is a table with objects upon it similar to those upon the other table. The extreme left is occupied by a large krater beside which stands a naked boy holding a small pitcher. Underneath is the inscription, Δυσίμαχιδος ἀνέθηκε. No. 2 is a fragment of a large relief: a female head and a bearded male head are preserved. The figures to which these heads belonged held each a sceptre. Beside the heads are the inscriptions Πλούτων and θεά. Near the head of Plouton is a torch which was evidently held by another person. The inscription tells that Lakratides, a priest, dedicated the relief. It is conjectured that the temple, in the ruins of which these reliefs were found, was the temple of Plouton.—CHR. D. TSOUNTAS, *Excavations of Tombs at Eretria* (pl. 4). Since last November some 200 tombs have been excavated at Eretria. They are of various epochs from the VI century B. C. down. The various forms of these tombs are described. In them were found many vases, among them thirty white lekythoi (including fragments). Two lekythoi are published. The first is a red-figured lekythos upon which is represented a diskobolos, naked, holding up the diskos in his left hand. His cloak lies beside him on a stool. On the cloak is the artist's name ΔΟΠΙΞ in Attic letters, the sigma being formed of only three lines. The drawing is less careful than that of other vases by Δοῦρις. The second vase is a white lekythos. In the centre of the painting is a low stele adorned with bands or fillets in bright red and black. Upon the stele sits in a chair a woman with yellow hair. She is dressed in a bright red cloak trimmed with black. In her hand she holds a cluster of grapes. Before her sits upon the ground (that is upon the top of the stele) a nude yellow-haired youth reaching out for the grapes. These two figures are very small. To the right of the stele stands a woman in a long cloak of bright red. She holds in each hand a dark brown wreath. To the left of the stele stands a youth leaning on a staff. His hair is yellowish brown: he wears a brown cloak. The outlines are drawn in yellow and brown with occasional lines of black.—S. BASES, *Epigraphica*. Remarks on the reading and interpretation of an inscription (*Bull. de Corr. Hellén.* VIII, p. 437) containing a letter of Sulla to the Statonikeans. Also further remarks on the consular letter to the Oropians (*Ep. Αρχ.* 1884, No. 3).—J. CH. DRAGATSES, *Antiquities of the Peiræus*. 1. A relief representing the sacrifice of a pig to Zeus Meilichios. The party of worshippers consists of a man, two

women, three boys, and a girl. The relief shows traces of red and yellow colors. The inscription reads, *Κρι]τυβόλη Διὶ Μιλιχίω*. Under No. 7 a monument is described which was found near the mouth of the *λιμὴν τῶν Ἀλλῶν* at the Peiræus. The relief represents a half-draped male figure seated in an armchair. The inscription reads *Τυννίας Τύννωνος Τρικυρόσιος*.

No. 2.—B. I. LEONARDOS, *Inscriptions from the Amphiareion* (contin.). 14. On a square pedestal are the words *Σῶσις ἐποιήσε*. This Sosis seems to be identical with the artist named in another inscription (*Bull. de Corr. Hellén.* 1879, p. 444, No. 2; Löwy, *Ins. gr. Bild.* No. 150). 15. On a simple pedestal: a dedication by the Oropians of a statue of Pisis son of Charias to Amphiaræos. 16. On a simple pedestal: Charias son of Neoptolemos, an Athenian, dedicates to Amphiaræos a statue of his father. Praxias son of Lysimachos, an Athenian, was the artist. Both Charias and Praxias were already known; hence the inscription can be assigned to the second half of the IV cent. B. C. 17. Upon a monument of three stones: the Oropians dedicate to Amphiaræos a statue of their patron C. Scribonius Gai f. Curio. The artist was Xenokrates (cf. No. 19). This Scribonius was tribune B. C. 50. Numerous decrees of proxeny are inscribed upon the same monument. 18. On a monument: the people (of the Oropians) set up a statue of M. Agrippa L. f., thrice consul, their benefactor. The artist was Metiochos (cf. Löwy, *Inschr.* No. 342). The date of the monument is between 27 and 12 B. C. A number of decrees of proxeny are on the same monument. 19. The people of the Oropians dedicate to Amphiaræos a statue of Timarchos son of Theodoros. Upon the same stone is a decree of proxeny for Euboulides, son of Kalliades, an Athenian. This decree is of earlier date than the dedication, which seems to have displaced an older inscription. A second fragment of the same monument bears part of an elegiac inscription and the name of an artist,—Xenokrates, an Athenian. 20. The people of the Oropians dedicate to Amphiaræos a statue of Paulla Popillia daughter of Marcus, wife of Gnaeus Piso. Upon the same stone are decrees of proxeny. 21. The people of the Oropians dedicate to Amphiaræos a statue of their patron Gnaeus Calpurnius Gnaei f. Piso. Calpurnius Piso was consul B. C. 61. Upon the same monument are decrees of proxeny. 22. Upon a monument of four stones with cornice and ornamental base is a dedication to Amphiaræos, by the people of the Oropians, of a statue of P. Servilius Gai f. Isauricus consul imperator. P. Servilius acquired the cognomen Isauricus B. C. 74. Upon the same monument are decrees of proxeny of an earlier date than that of the dedicatory inscription. 23. Upon a small monolithic monument with cornice and ornamental base: Aristomedes dedicates a statue of his brother Megakleides son of Aristomenes. Upon the same stone are three decrees of proxeny, which are published.—

P. KABBADIAS, *Excavations on the Akropolis* (pls. 5, 6, and supplement). The excavations in the N. W. part of the Akropolis are described. Many objects of bronze and earthenware were found, which are referred to the earliest periods of Greek art. One head of Poros stone is referred to the pre-Hellenic time. The head is that of a bearded man, and resembles the masks found at Mykenai. The most important discoveries were made, toward the end of January, near the N. W. corner of the Erechtheion: there 14 archaic statues were found. These were mostly female figures. One is published (pl. 5). The figure consisted of several stones which were originally morticed and cemented together. The drapery falls in stiff straight folds; the hair is arranged in elaborate curls; the head is surmounted by a polos. Color was freely used upon these figures, though it does not appear that the whole surface was colored. The positions in which these figures were found, and their relation to the objects about them, show that they must have been used to help fill up and level the top of the Akropolis when the present wall was built after the Persian invasion. This is made clear by the supplementary plate. Archaic inscriptions also were found, five of which are published in facsimile (pl. 6). No. 1 is on a fragment of a column with Doric flutings to which a curious Ionic capital belongs. No. 2, also engraved upon a fragment of a column with Doric flutings, mentions an artist, Euenor: this cannot be the father of Parrhasios. No. 4 bears the name of the artist Antenor, son of Eumaros, the same who made the group of Harmodios and Aristogeiton which Xerxes carried off. No. 5, inscribed upon the pedestal of a statue, bears the name of the artist Theodoros. Perhaps this is Theodoros the Samian. A fragment of the cornice of a pedestal is also published and described. The colors employed upon the cornice are red, blue, gray, chestnut, orange and green.—B. N. STÆES, *Scenes of the Gigantomachia* (pl. 7). Six fragments of pottery from the Akropolis are published. Three of these belong together, having originally formed part of a large vase. The figures are black upon a red ground. The giants are represented as hoplites. The figures of Zeus, Herakles, Hermes, Dionysos, and perhaps Gaia and Poseidon, can be recognized. The figures have inscriptions. Upon two fragments of a large vase with red figures are two heads, one of which is the head of Dionysos. The sixth fragment published belongs to a kylix, part of which was published *Εφ. Αρχ.* 1885, pl. 52. This fragment represents the body of a fallen giant, and the foot and part of the robe of his conqueror. Remarks upon representations of the gigantomachia follow. Three classes are established: the oldest, in which the giants are represented as hoplites, the second in which they appear as savages, the third in which they have serpents for legs.—S. A. KOUMANOUDES, *Two dozen Attic Decrees*. Twenty-four fragments of de-

crees are published, all from Athens. Also a fragment of a decree of proxeny found on the site of the bazaar lately destroyed by fire. Nos. 1 and 2 are pre-Eukleidean. No. 4 is part of a treaty between the Athenians and the Thracian rulers Kersobleptes, Beresades and Amadokos. Several of these inscriptions contain the names of archons, which fixes their date. All are very fragmentary.

HAROLD N. FOWLER.

GAZETTE ARCHÉOLOGIQUE. 1886. Nos. 1-2.—A. SORLIN-DORIGNY, *The Death of Aigisthos: a marble bas-relief in the Museum of Constantinople* (pl. 1). This fragment of a sarcophagus is one of the best reliefs in the museum: it represents a nude figure kneeling on a couch and defending himself with a footstool, which he is hurling against a warrior who advances with shield and helmet. The subject has been in dispute: Mr. Goold suggested the death of Alkibiades; Dr. Dethier and M. Dumont, the death of Neoptolemos; M. Reinach, the murder of Aigisthos or Neoptolemos. The writer shows that the only plausible subject is the murder of Aigisthos by Orestes and Pylades. In the relief the shield of the second hero is visible, and on the right a wing indicating the presence of an avenging Erinys.—A. ODOBESCO, *Silver cup of the goddess Nana-Anat* (contin.). Under the Achæmenidæ the worship of Aphrodite-Anaitis took considerable extension, and the writer refers to its spread in Further-Asia, especially on the borders of India, as of importance for the identification of the cup in question. He then passes from an examination of the central portion to that of the eight figures which surround it, and are arranged in affronted couples, dancing, six of them bearing sacred vases or offerings. Their robe, after covering arms and chest, is drawn in at the waist and then descends in the form of a skirt to the ankles: four of the figures are evidently females, but the sex of the others is doubtful.—A. CHABOUILLET, *Study on some cameos of the Cabinet des Médailles* (contin.). I. The attribution of the cameo here studied (see JOURNAL, II, 114) to Seleukos I is not supported by any resemblance to his authentic portrait on gold staters; other identifications with Alexander and Achilleus are equally unsatisfactory. II. The repose of Venus: this subject represents the reclining goddess attended by three amorini; in white on a sardonyx ground: its antiquity is doubtful. III. Episode of the myth of the education of Dionysos. Rhea raises herself partly out of the ground and takes in her arms the infant Dionysos, who caresses her and holds in the other hand a bunch of grapes: a bacchante and a hermes complete the scene. Fine antique (cf. article *Bacchus* by Fr. Lenormant in Daremberg and Saglio's *Dict. des Ant. grecques et rom.*). —CH. DE LINAS, *The ivory book of the public library of Rouen* (pl. 4). Study on a MS. on vellum whose wooden covers are decorated with ivory

plaques. The volume contains documents relating to the history of the Church of Rouen and to its possessions. The copper borders of the binding are in the sober style of end XI or beg. XII cent. Each of the ivory plaques contains an aedicula with triangular gable whose entablature is supported by two channelled pilasters with Corinthian capitals: under one stands St. Peter holding a key and draped in a pallium; under the other is a figure in profile, similarly draped, holding an unrolled volumen, whom M. de Linas considers to be St. John. The style of both these figures and of the ornamentation is classical in every detail: the writer compares this work to the famous angel in the British Museum, and attributes it to a Greek artist of the time of Theodosios. The plaques were originally ecclesiastical diptychs.—MAURICE PROU, *Bronze basin of the XI or XII century representing the youth of Achilles*. This is another example, similar to that of the history of Odysseus (*Gazette Arch.* 1885, pls. 4, 5), of the subjects borrowed by medieval art from antiquity. On this *aquamanile*, now in the Louvre, the principal episodes of the youth of Achilles are engraved on the interior: Cheiron teaching him to play on the lyre; Thetis conducting him to Lykomedes; presenting him to the king; Achilleus choosing the arms; the hero departing; confessing his love for Deidameia; embarked in a vessel. The details of armor and costume place the execution of this work c. 1100.—EMILE MOLINIER, *The architects of the Château de Fontainebleau*. Though more has been written on this château than on any other of the Renaissance, but little is known with certainty of its architects and history. In this first paper of a series on the subject, the writer disputes M. Palustre's attribution, to the French architect Pierre Chambiges, of the constructions in brick and stone of the "Cour du Cheval Blanc."

Nos. 3-4.—A. HÉRON DE VILLEFOSSE, *The repose of Herakles; bronze disk in the British Museum*. The hero reclines on a lion-skin, lazily resting on his right arm, while around him gambol Erotes, some of whom have taken possession of his arms, while others charm him with music. Compare with this subject a similar one in which a nude female figure reclines voluptuously.—PAUL MONCEAU, *Statues at Cherchell from the Greek Museum of the Mauretanian kings at Caesarea* (pl. 7). I. A statue of a faun from the train of Dionysos, accompanied by a panther; a graceful group, though late. II. A female statue of natural size, probably of Artemis, having the beauty and delicacy of a Greek original. It is archaic in the arrangement of the hair and the narrow folds of the long chiton, moulded to the limbs, while the harmonious arrangement of the diplois and the suppleness of execution point to the best period of Hellenic art. These traces of Greek art in Numidia, supplemented by the coins of Juba and Ptolemy and by the columns, friezes and mouldings, in

fact by all the ruins, of the site, show that at Cherchell there was a centre of Greek influence. History explains this. Juba II, the founder of Caesarea, who fought at Actium, lived in the East, and received the citizenship of Athens. He brought from Greece some original statues and procured many copies, thus founding the museum of Greek art of which these two statues are remnants, and of which 21 more specimens are scattered in the museums of Paris, Algiers and Cherchell.—HENRI BUCHOT, *The portrait of Louis II of Anjou, king of Sicily, in the Bibliothèque Nationale* (pl. 8). Only one portrait of Louis I of Anjou († 1384) is known, and this is but a copy by Gaignières from a ms. since destroyed. His son Louis II, king of Sicily, was no better represented: Gaignières had also made a copy, he says, from an "original pastel" of this king: besides this, only a supposed portrait in a painted glass window at Le Mans existed. Fortunately, the original of Gaignières' copy has just come to light, and has been given to the Bibliothèque Nationale. It is a contemporary aquarelle portrait of great merit.—E. BABELON, *Seilenos and a Bacchante, a bronze of the De Jansé collection* (pl. 9). A group attributed to the Roman art of the first century, perhaps from Herculaneum [of rather doubtful authenticity?].—A. ODOBESCO, *Silver cup of the goddess Nana-Anat* (cont.) (pls. 10, 11, 12). Comparison of the cup with other ancient pieces of metal-sculpture of Central Asia: (1) the patera of Idalion, and (2) the patera in the Varvakeion museum (Athens), both representing priestess-musicians of the great goddess; (3) a Strogonoff silver oinochoe; (4) a De Brosses vase. This comparison strengthens the theory that the silver cup is a work, if not of Persian art of the Sassanid period, at least related to this art. The art of Central Asia has never been adequately studied, though its monuments would throw considerable light on the religious customs and civilizations of its peoples since the fall of Assyria and before the rise of Islam.—L. DELISLE, *Royal and princely copies of the Miroir historial* (pls. 13, 14, 15, 16). The study of miniature-painting is greatly facilitated by a comparison with works whose dates are known. The three which form the subject of this study and are full of paintings are exactly dated and are copies of the French translation of Vincent de Beauvais' *Speculum historiale*, made by Jean du Vignay, and usually containing a series of paintings illustrating universal history. (1) No. 317 Fonds Français, Bibl. Nat., probably one of the autograph copies of Jean du Vignay, dated 1333: this volume, the only one of the four that remains, contains 320 paintings. (2) ms. of the Univ. of Leyden (*Cod. Vossianus, 3a*)—also a single volume, and a remarkably precious one, as it was the copy of kings Jean and Charles V; it is contemporary with the preceding and dates from Philippe de Valois: it contains 280 paintings, of which the writer gives a

full catalogue. (3) In 1395 and 1396 Thevenin Angevin had the *Miroir historial* copied by order of Louis, duc d'Orléans, in four volumes: three of these are still preserved in the Bibl. Nat. (Nos. 312, 313, 314) and contain 550 paintings in *grisaille*.

A. L. F. JR.

JAHRBUCH DES K. DEUTSCHEN ARCHÄOLOGISCHEN INSTITUTS. Vol. I, 1886. No. 1.—A. CONZE, *Introductory Remarks*.—A. CONZE, *The Praying Boy in the Royal Museum of Berlin* (3 figs.). The history of this well-known statue is given from the time when it was the property of Nicolas Fouquet down to the present day. The hypothesis is advanced, that the replica of this statue in Venice is a modern copy. The Venice figure has no arms, but the arms of the Berlin figure are modern. Perhaps the present position of the hands with the palms turned upward is incorrect. It is suggested that the real date of the statue is in Hellenistic times.—AD. MICHAELIS, *The so-called Ephesian Amazon statues* (pla. 1-4; 5 figs.). The material for the discussion is described, and classified under three types: the Lansdowne, the Capitoline, and the Mattei. A discussion of the heads of the three types follows. The three are then reconstructed as follows: the Capitoline type rests her weight mainly upon the left foot. With her right hand, which is raised higher than her head, she supports herself upon a spear. Her left hand touches a wound on her right side. The right breast and side are bare, while the left side is covered by a tunic fastened over the shoulder. The Lansdowne type leans her left elbow on a pillar. Her right hand is raised and rests upon her head. The tunic is fastened over the right shoulder, but falls so that both breasts are uncovered. The face in both these types expresses lassitude and sadness. The Mattei type rests her weight mainly on the right foot. She holds a spear or staff nearly upright along her left side. The left hand hangs down somewhat and touches the spear below the hips of the figure, while the right arm is raised and the hand grasps the spear above her head so that her face looks out under her forearm. This type wears a tunic fastened over the right shoulder; under the left arm hang a bow and quiver. She seems about to take a leap with the aid of her spear. The Lansdowne type is referred to Polykleitos, the Capitoline type to some master hardly later than Polykleitos (possibly Pheidias), the Mattei type to an artist of a somewhat later period, but it is denied that the three types are all to be referred to one original conception. Plates 1 and 2 give two views of an amazon in Petworth (Mattei type), plate 3 gives the Berlin amazon and a head in the British Museum (Lansdowne type), plate 4 gives three views of an amazon torso in Wörlitz (Capitoline type).—M. FRÄNKEL, *A consecrated Frog* (vignette). A bronze frog is published with the inscription *Ἀμυν Σωβόου Βοάσωνι*. The frog is of Korin-

thian origin. The deity referred to by the epithet *Bodswv* is Apollon. The frog, being able to predict bad weather, is brought into connection with the god of prophecy.—P. WOLTERS, *Communications from the British Museum* (pl. 5). I. *Praxitelean Heads*. Two heads in the British Museum are published. Both are declared to be Praxitelean. The first (*Guide to the Graeco-Roman Sculptures*, II (1876), pp. 44, 97) is explained as the head of a victor in some game. The second (*op. cit.*, I (1879), pp. 199, 105) is the youthful Herakles. II. *The Gigantomachia of Priene*. Technical considerations, such as the form and finish of the slabs of which the frieze of Priene is composed, show that this was not the frieze of the temple, but probably formed a balustrade. Then, the date of the temple is not necessarily the date of the frieze. The style and execution of the relief speak for a later date. It is therefore probable, that the frieze of Priene is not so old as the frieze of Pergamon, though it cannot be of much later date. There is no reason for the belief that any part of the frieze of Priene represents Amazons or Centaurs.—BIBLIOGRAPHY.

HAROLD N. FOWLER.

MITTHEILUNGEN DES K. DEUTSCHEN ARCHÄOLOGISCHEN INSTITUTES. ATHENSISCHE ABTHEILUNG. Vol. XI. No. 1.—E. FABRICIUS, *A Pergamian Country Town*. The region called Kosak, which lies between Pergamon and the gulf of Adramyttion, is described. Then follows a description, by R. Bohn, of the ruins of a small town situated near Aschaga-Beiköi. The course of the fortifications can, for the most part, be followed. Remains of various buildings are described, among which the theatre is most remarkable. The wings of the cavea are cut off so that the upper seats form only a comparatively small arc. The orchestra appears to be of the usual shape. A Fig. of the theatre is given in the text, and Plate I is a plan of the ruins of the town. Remains of a neighboring settlement appear to date from the early Middle Ages. The ruins above described appear to belong mainly to the period of the Pergamene monarchy. The name of the town cannot be determined. Perperene, Trarion, and Attaleia are suggested.—F. DUEMLER, *Communications from the Greek Islands*. I. *Remains of pre-Hellenic population on the Kyklades*. Prehistoric graves on Amorgos and Melos are described. Some of the objects found in them are given on supplementary plates, 1 and 2. These consist mainly of pottery, weapons, etc., of bronze and obsidian. Similar articles have been found in Rheneia, Paros, Naxos, the Eremonisia, Ios, Thera, Therasia, Oliaros, Syra and Delphi. The art displayed in these objects stands between that of Hissarlik and that of Mykenai. It is evident that we have to do with the relics of a people which were firmly settled in the Kyklades before the advent of

the Hellenæ. Perhaps these people were the Leleges, in which case the inhabitants of Mykenai may have been Karians.—H. G. LOLLING, *Communications from Thessaly. II. Sepulchral Inscriptions*. Fifty sepulchral inscriptions are given, most of them for the first time. Of these, fifteen are from Pagasai, one from Pherai, four from Demetrias, one from Meliboia (?), two from Gonnos, one from Skotoussa, and twenty-six from Larissa and its neighborhood.—F. STUDNICZKA, *Attic Pediments of Poros stone*. The very fragmentary relief (pl. II, 1) representing the combat of Herakles with Triton (cf. 'Ep. 'Apx. 1885, No. 4) is said to have belonged to the same building as the relief representing the combat with the Hydra (Ep. 'Apx. 1884, p. 147, pl. 7; 1885, No. 4: *Mittheilungen*, x, 3 and 4). Besides Herakles and the fish-bodied Triton, there must have been Nereids as spectators to fill the space of the pediment. Other representations of this scene are cited for comparison. It is shown that the reliefs in question belong to the first half of the VI cent. B. C. Perhaps the building to which these reliefs belonged was a Herakleion. A fragment of a relief is published (pl. II, 2) representing two satyrs and a maenad. This was found ten years ago near the Dionysiac Theatre, and perhaps belonged to the pediment of the oldest temple of Dionysos.—F. HALBHERR, *An Inscription of Amorgos*. A fragmentary decree of proxyeny of the city of Minoa on Amorgos (*Ann. dell' Inst.* XIV, p. 153; *Arch. Zeitg.* 1843, p. 107; Ross, *Inscr. Gr. ined.* III, p. 58; Rhangabé, *Ant. hell.* II, p. 342) is published anew with corrections.—F. HALBHERR, *New Coins of Axos*. Two coins published by P. Lambros in Sallet's *Zeitschrift für Numismatik* (XIII, p. 125 et seq.) and referred by him to Naxos, are shown to belong to Axos or Oaxos, the initial letter being a local form for the digamma, not a N.—F. STUDNICZKA, *Terracotta Relief from Tenos* (vignette). A relief is published, which represents a fallen warrior being devoured by a bird of prey. The style is similar to that of the "Dipylon vases." Various archaic representations of similar scenes are cited, nearly all of which have been wrongly interpreted as Prometheus. One Kyrenaic vase-painting (*Arch. Zeitg.* 1881, pl. 12, 3, p. 218, No. 11, p. 23) which was formerly believed to represent Prometheus, has since been interpreted as Zeus with the eagle. The same type appears on coins of Arkadia. Remarks follow on the relation of Kyrene to Arkadia.—MISCELLANEA *Literature and Discoveries.—Reports of Meetings.* HAROLD N. FOWLER.

MITTHEILUNGEN DES K. DEUTSCHEN ARCHÄOLOGISCHEN INSTITUTES. RÖMISCHE ABTHEILUNG (*Bullettino dell' Istituto archeologico germanico, sezione romana*). Vol. I. No. 1.—G. TOMASETTI, *The marble mosaic of the Palazzo Colonna* (pl. I). A marble mosaic, or rather *opus sectile* is published and described. In the centre stands a tree (prob-

ably the *figus Ruminalis*) upon which sit two birds. At the foot of the tree stands a shepherd with cloak of skin, a crook and a cap. To the right at the bottom is a she-wolf under which two infants sit reaching after her dugs. Above is a square altar over which a bird flies toward the centre. At the left of the scene sits the goddess Roma upon a rock the lower part of which is cut in architectural curves. The goddess has shield, spear, and helmet. At the base of the rock are two animals. The colored stones which once filled in the mosaic are gone except from the body of the wolf, nearly the whole of one of the children, and the end of the shepherd's crook; but the outlines of the bed prepared for the mosaic show plainly what was represented. Other representations of the mythical foundation of Rome are discussed. The mosaic in question is referred to the end of the second century. It was found in a place called *Tor messer Paolo*, to the left of the Via Appia, near the *Castello di Marino*. Perhaps this was the site of a villa of the Valerii Messallae, who bore the cognomina Paulus and Paulinus.—W. HELBIG, *Excavations of Capodimonte*. About 2½ miles from Capodimonte, on the site of the ancient Visentium, excavations have been conducted by the owners of the land, Signori Brenciaglia. Forty tombs have been discovered, belonging to two epochs, the latest being as old as the early part of the v cent. B. C. In these were found many black-figured Attic vases, as well as vases of Etruscan manufacture. One of the Attic vases bears the artist's name, Hermogenes. Numerous articles of bronze and of other metals were also found. A number of vases and other objects are described. In one tomb a skeleton was found adorned with ornaments of gold, bronze, glass and iron. Three teeth of the skeleton were united by a band of gold. In the older tombs were a number of vases and metal ornaments. Several scarabs with Egyptian figures were found, two of which are represented by illustrations in the text.—W. HELBIG, *A Portrait of Gnaeus Pompeius Magnus* (pl. II). A bust of Pompey is published and discussed. The prototypes are made from a cast sent from Paris to the publisher. For comparison a coin of S. Pompeius with a head of Pompeius Magnus is published. The face does not indicate great intellect or force of character.—W. HENZEN, *An Inscription relating to the Horrea Galbiana*. The inscription, apparently of the time of Trajan, is a dedication to Hercules from the contributions of the *horrearii* of the second cohort. The consuls mentioned (M. Junio Mettuo Rufo Q. Pomponio Materno cos.) are unknown.—A. MAU, *On certain apparatus in the Pistrini of Pompeii* (pl. III). Certain cylindrical utensils found near the kneading-tables and ovens of Pompeii are described. Plan and section of four such cylinders are given. Inside the cylinders were remains of iron frames for wooden beaters or kneaders, which, revolving in the cylinders, must have served to mix the dough.—N. MUELLER, *The Catacombs of the Hebrews near*

the Via Appia Pignatelli. These catacombs, which were excavated in 1885, are described. They were plundered in earlier times, consequently the objects found were of little original value. Vases and lamps, mostly of poor quality, were found, as well as seven brick stamps of the II cent. A. D. Six inscriptions from these catacombs are published, and one each from those of Venosa and the *Vigna Randanini*.—A. MAU, *Storia degli Scavi di Ercolano ricomposta su' documenti superstiti* da MICHELE RUGGIERO, *Architetto direttore degli scavi e monumenti del regno*: Napoli, 1885. This valuable book, which collects in permanent form what is known of the excavations at Herculaneum, is reviewed. Brief mention is made of another work by the same author: *Degli scavi di Stabia dal 1749 al 1782; Notizie raccolte e pubblicate* da MICHELE RUGGIERO: Napoli, 1881.—

REPORTS OF MEETINGS. HAROLD N. FOWLER.

NECROLOGY.

CHARLES C. PERKINS.

Short as the life of this Journal has been—hardly more than a year—it already has to mourn the loss of one of its editorial staff, in the recent death of Mr. Charles C. Perkins of Boston. Mr. Perkins was doubtless the best known of American writers upon the fine arts. All his life had been given to study of the practice, the history, and the archæology of art in its various forms. His early years, after his graduation from Harvard, he gave to European study, at first in music. In this he not only acquired skill enough to play the piano in public on special occasion, but devoted himself to the theory of music, and practised its composition. Not limiting himself, as do most amateurs, to its lighter forms, he tried the highest walks of composition, writing chamber music—piano trios, string quartettes, and even that most exacting of all, from which most American composers have shrunk, the string quintette. While in Paris he studied painting under Ary Schaeffer, and afterwards practised etching with Bracquemond and Lalanne. The study of the arts of design ended in diverting his energies from the practice of music, although to the end of his days he was a warm amateur and promoter of it, retaining the presidency of the Handel and Haydn society of Boston, and being always among the leaders of musical patronage. These varied studies and his extending artistic interest led him to a wide connoisseurship in all the arts; it is in this aspect that he was best known at home. There was hardly a branch of art which he did not study, and in which he did not aspire to more than an amateur's knowledge; and there was no artistic movement of importance in his own community in which he did not share.

It was in the history and archæology of the fine arts that Mr. Perkins's best work was done. During a long residence in Italy his attention was specially turned to the study of early Italian sculpture. The product of this study was his *magnum opus*, his work on Tuscan sculptors, published by Longmans in 1864 in two richly illustrated quarto volumes, and completed four years later by a like volume on Italian sculptors. In this he brought to notice the neglected works of the great forerunners and early leaders of the Italian Renaissance. The work gave him at once a prominent place among writers upon art. It covered ground which before his

time had hardly been touched, and being the fruit of independent labor, from first-hand sources consulted on the spot, it carried the authority both of a pioneer and of an expert. The ability, unusual in a writer, to illustrate his work by etchings and drawings from his own hand, added to its éclat. These volumes have not been so well known or so highly honored at home, where special students in their field are rare; but their value was quickly acknowledged by European scholars, and won for Mr. Perkins the rare distinction of a corresponding membership of the Institute of France. So completely did he take possession of his subject that his work, though now twenty years old, has not ceased to be quoted as the leading authority for it.

The qualifications and the reputation so acquired made him, on his return home, helpful and influential in a community which was beginning to be stirred by a new enthusiasm for the arts and their literature. The systems of instruction in music, drawing, and design which were established in the schools of Boston and the rest of Massachusetts were mainly due to his initiative. He was active in the building of the Music Hall at Boston, and furnished at his own cost the fine bronze statue of Beethoven by Crawford, which is its chief ornament, for the model of which, it is due to Crawford to say, the sculptor refused to be paid. The Museum of Fine Arts in that city owes its being and its form more to his energy and enterprise than to those of any other man, and in recognition of this he was made and has remained its Honorary Director. He wrote the descriptive catalogue of the sculpture gallery in this museum, and his interest in its collections and zeal for their enlargement were unflagging.

In the midst of these public cares, Mr. Perkins's literary activity and productiveness were remarkable. His reputation as an authority in the history of art, and as a critic, made him sought after. He delivered many lectures and addresses, was a contributor to many American and foreign periodicals, was one of the leading writers for the *American Art Review*, and has furnished a number of articles to this *Journal*, of which he was one of the editorial contributors. He edited and annotated the American edition of Eastlake's "Hints on Household Taste," as well as the translation of Dr. Falke's "Art in the House," a work of like subject but larger scope. Eight years ago he published a comparative study entitled "Raphael and Michelangelo," a critical and biographical essay. Somewhat later he condensed into a single large octavo the substance of his *Tuscan Sculptors and Italian Sculptors*, with the additional material needed to justify a larger range and its title of "An Historical Handbook of Italian Sculpture." He was the critical editor of the monumental "Cyclopaedia of Painters and Paintings" which Messrs. Charles Scribner's Sons are now publishing, the ms. of which, it is understood, is complete. His last finished work, issued

this year, aptly closed the cycle of his literary labor, and brought him back to the field of his first successes. It is a monograph on Ghiberti, a handsome illustrated quarto published by Rouam of Paris, written in French as one of the series of his *Bibliothèque internationale de l'Art*, at the request of its editor and his friend M. Eugène Müntz. At the time of his death he was busy, we are told, with the material for a treatise on *The Science of Beauty*, which he had begun to write.

A career like Mr. Perkins's is full of example for a stirring, money-loving community, where the busy are tempted to grasping self-absorption, and the rich to idle indulgence. Born to wealth, and with every opportunity for a life of luxurious ease, he led a life of untiring industry, of equal devotion to his private studies and his public duties. His social grace won him favor everywhere; his public spirit, enterprise, and single-mindedness gave effect to his advocacy of public undertakings for the furtherance of the arts; his interest, his activity, and when there was occasion his purse, were ready for whatever seemed to him to encourage them. He has left his mark on the literature of art and archæology, and on the institutions of his own city.

BOOKS RECEIVED.

- A. A. Caruana.** Recent further excavations of the Megalithic Antiquities of Hagiar-Kim, Malta, executed in the year 1885. Fol. oblong, pp. 11 with seven full-size lithographs. Malta, 1886, *Government press*.
- A. de Champeaux.** Dictionnaire des fondeurs, ciseleurs, modeleurs en bronze et doreurs, depuis le moyen-âge jusqu'à l'époque actuelle. A-C. 12mo, pp. 357. Paris, 1886, *Librairie de l'Art*.
- De Clercq.** Collection de Clercq: Catalogue méthodique et raisonné. I. Antiquités Assyriennes. Folio, pp. 114 with 24 heliotype plates by Dujardin. Paris, 1886, *Leroux*.
- Maxime Collignon.** Phidias (Les Artistes Célèbres). Ouvrage accompagné de 45 gravures. 8vo, pp. 127. Paris, 1886, *Librairie de l'Art*.
- Maxime Collignon.** Tablettes votives de terre cuite peinte trouvées à Corinthe (Musée du Louvre) (Extrait des *Monuments Grecs*, Nos. 11-13, années 1882-84). 4to, pp. 12, 8 figs. Paris, 1886, *Georges Chamerot*.
- Charles Cournault.** Jean Lamour, serrurier du roi Stanislas, à Nancy (Les Artistes Célèbres). Ouvrage accompagné de 26 gravures. 8vo, pp. 29. Paris, 1886, *Librairie de l'Art*.
- B. P. Delattre.** Archéologie Chrétienne de Carthage. Fouilles de la basilique de Damous-el-Karita (1884) (Bibliothèque illustrée des Missions catholiques). 8vo, pp. 65. Lyon, 1886, *Bureaux des Missions catholiques*.
- J. B. Giraud.** L'organisation des Musées et le fonctionnement de l'Enseignement du Dessin en Angleterre. 8vo, pp. 111. Lyon, 1885.
- Eugène Müntz.** Les mosaïques byzantines portatives (Extrait du *Bulletin Monumental*, 52^e vol. 1886). 8vo, pp. 20. Caen, 1886, *Le Blanc-Hardel*.
- J. B. de Rossi.** De origine, historia, indicibus scrinii et bibliothecae sedis apostolicae (ex t. I, *Rescensionis Cod. Palat. Lat. Bib. Vat.*) 4to, pp. 134. Romae, 1886, *ex typographeo Vaticano*.
- G. B. de Rossi.** Le Horrea sotto l'Aventino e la statio annonae urbis Romae (Estratto dagli *Annali dell' Istituto*, 1885). 8vo, pp. 12, plate. Roma, 1885.
- Ettore de Ruggiero.** Dizionario Epigrafico di Antichità Romane. Fasc. I. Abacus-Achaia. R. 8vo, pp. 32. Roma, 1886, *Typog. della R. Accad. dei Lincei*.

AMERICAN JOURNAL OF ARCHÆOLOGY.

VOL. II.

No. 4.

UNPUBLISHED WHITE LEKYTHOI FROM ATTIKA.

[PLATES X, XI, XII-XIII.]

I.

In the study of Attic belief and custom relating to death, burial, and the future life, the abundant data furnished in literature are supplemented and illustrated in a singularly interesting manner by certain monuments of art. These works of art—and very humble art it is at times—are the artistic contents and accessories of the ancient Attic graves. Of hardly less importance than the tombstone reliefs and inscriptions—the final word upon which can be uttered only after Conze shall have completed his great work upon them—are the so-called White Lekythoi from Attika; a species of vase, decorated with paintings usually of mortuary subjects, which have been found of late in considerable numbers, mostly in Attic graves of the fourth century B. C. For an earlier period, of especial interest are certain painted tablets (*πίνακες*), as well as amphorae and other vases with sepulchral scenes.¹

¹The Berlin Museum possesses a number of these pinakes, and four prothesis-amphorae: they belong to the period of Black-figured ware, earlier and later subdivision, respectively. The pinakes were found in 1872 near the orphan asylum in Athens, in a condition that led G. Hirschfeld to believe they had been broken into fragments before burial. The scenes on their surface represent the prothesis, lament for the dead, and the funeral procession of men and women on foot, in cars, and on horseback, with mules and horses. Inscriptions accompany some of the figures. Cf. Furtwängler, *Vasensammlung im Antiquarium* (Berlin) Nos. 1811–1826. The amphorae

The white lekythoi of Attika, of which nearly seven hundred are now known, are a comparatively new series of monuments as regards their recognition, and most of the specimens are still in Athenian collections. The great wealth of vases discovered in Italy in the first third of the present century long eclipsed these elegant and simple products of Attic art. In 1854, Otto Jahn mentions only a few as known to him; in 1866, De Witte says there are only two or three specimens in each of the principal European museums; in 1869, however, the number is so much increased that O. Benndorf devotes to them a fasciculus of his beautiful *Griechische und sicilische Vasenbilder*, 1869-1883; in 1874, Dumont knows of six hundred, of which two-thirds are in Athens. In 1883 (not to mention works appearing in the interval, such as Collignon's catalogue of the vases belonging to the Archæological Society of Athens, essays like Robert's *Thanatos*, and articles in the periodicals, like Furtwängler's important notice in the *Archäologische Zeitung*, 1880) was published E. Pottier's *Étude sur les lécythes blancs attiques à représentations funéraires*, the most extensive treatment of the subject that has yet appeared. Since 1883 the leading journals devoted to classical archæology have contained not infrequent references to the subject.²

In the present article it is proposed briefly to describe eleven hitherto unedited lekythoi, six of which belong to this class, with such introductory and supplementary remarks as may make clear their place in the development of this branch of ceramics, together with a few observations upon one or two points of belief and custom suggested by the inquiry.³

The lekythos is strictly a vase for ointments or for perfumes. It resembles a long bottle, with a round flaring mouth: it has a distinct

have been figured in part in *Mon. d. Inst.* III. tav. LX, and the whole class has been commented upon, with bibliography, by Benndorf, *Griechische und sicilische Vasenbilder*, p. 6. Furtwängler's minute descriptions, with indications of restorations, should be consulted (*Vasensamml.*, Nos. 1887-1889, 3999). The finest specimen of these prothesis-amphoræ is in Athens. It exhibits three scenes, prothesis, burial, and tumulus with *eidwla*, and has a fragmentary inscription, which Keil would read (*Mon. d. Inst.* VIII. tav. IV, v; cf. *Ann.* 1864, pp. 183-99) ἀνδρὸς ἀπο[θιμ]ένοιο [δάκος κακόν] ἐνταύθε κείμει. Cf. Collignon, *Catal.*, No. 200 bis.

²Cf. especially *Gaz. Arch.*, 1885, pp. 277-85 (Pottier); and *Ἐφημ. Ἀρχ.*, 1886, σσ. 31-42 (Tsountas). In the latter article are described a number of white lekythoi found in Eretria in 1885.

³For the original drawing from the vase illustrated in PL. X, I am indebted to Mr. C. Howard Walker, of Boston.

foot and is provided with a handle. It was usually of small size, and is found, with variations as to shape, in all periods of Greek art. At first, lekythoi seem to have been short and stout, and were ointment vases, used by athletes, like the alabastron: subsequently they are elongated in shape, are designed to contain perfumes, and are not expected to be moved about. The White Lekythos from Attika is a large perfume vase, of a distinct class, as regards manufacture, decoration and use. They are usually about one foot in height; one example, three feet and three inches in height, is mentioned by Pottier as the largest known. The classical form of the lekythos is sufficiently represented by the largest vase on PL. X. It should be noticed that the graceful outlines of the vase are secured by a skilful combination and alternation of convex and concave lines. The lines of the body, at first nearly vertical, sharply curve inward toward the foot or disk upon which it rests: the shoulder is distinctly marked off from the body by its inward concave curves: above the shoulder rises the slender neck with a slightly concave outline: upon the neck rests the mouth of the vase, which though wide and flaring is enclosed within convex lines that repeat those of the body. Around the edge the mouth has at times a slight Dorian kyma which gives it the appearance of a trumpet. In most vases the upper inner edge of the mouth projects inward, somewhat covering the opening, making it thus possible to collect near the aperture a small portion of the liquid perfume before pouring it out. The handle, itself made of convex and concave curves, is attached at the shoulder near the body and along the neck: it does not rise above the upper surface of the mouth, as in the case of the prochoös. In the typical vase of the fourth century B. C., the mouth, neck, handle, and lower portion of the body are covered with a brilliant black pigment; the shoulder and the body (except its lower portion), however, are covered with a fine white chalky coating, which gives its name to the vase. The rim of the disk-like foot is often left in the native red of baked clay. The white coating upon the shoulder is decorated, along its upper edge, with the painted ovolo or conventionalized egg-and-tongue ("sogen. Eierstab") or egg-ornament pattern, between horizontal lines; and, on its surface, with the palmette vine, usually made up of three palmettes,—the central one, on the face opposite the handle, facing outward, and the two others facing inward, or toward the base of the handle; all of them enclosed by a graceful connecting vine. The upper edge of the body, the vertical lines of which

are nearly straight, is usually bordered by some form of the meander fret, between two or more horizontal lines encircling the vase. Beneath this meander band is the picture, the centre of which is placed on the side opposite the handle. The fret commonly extends only above the picture, and not entirely around the vase. The lower edge of the white coating is frequently marked off near the black by horizontal lines. The colors used in the lines and in the paintings, the use of the dry point and a few other kindred matters, will be treated later on. The delicate forms of these vases and the friable nature of their chalky coating made them ill-suited to rough usage. They were well adapted, however, to be placed in the grave. In the scenes painted upon them will often be found diminutive representations of similar vases. Inscriptions rarely occur, at least on vases with mortuary scenes: those that are found, however, are of the highest value in assisting to fix dates, as we shall duly see.

These white lekythoi belong to a distinct and well-defined period: viz., from the latter half of the fifth century B. C. to the first half of the third century B. C.: but by far the larger number of specimens have been taken from the graves of the latter half of the fourth century B. C., *i. e.*, they belong to the age of Lysippos in sculpture and Apelles in painting. The two earliest references to mortuary lekythoi in literature are in Aristophanes and in Plato. Aristophanes (*Eccles.* 996) speaks of them and slightly refers to the artists that decorated them in the words *δς τοῖς νεκροῖς ζωγραφεῖ τὰς ληκύθους*, '[a fellow] who paints pictures on the lekythoi for the dead.'⁴ The date of this remark is about 392 B. C.; at this time, then, the preparation of mortuary lekythoi was a well-established industry. In Plato's *Charmides* (161 E), and in the *Hippias Minor* (368 c) sometimes ascribed to Plato, the lekythos is mentioned along with the strigil, as an oil-flask. The scholiast on the latter passage defines it as an Attic vase (*ἀγγεῖον*) in which were placed perfumes and ointments (*μύρον*) for the dead. In *Eccles.* 1032, Aristophanes speaks of lekythoi as placed near the dead (*παράθου τὰς ληκύθους*), evidently at the time of lying-in-state (*πρόθεσις*), either by or under the couch, or upon it near the head and feet.

⁴It is not impossible, however, that the reference here may be to large painted vases of this form placed upon the funeral mound, and not to the small lekythoi buried with the dead. Cf. Aristoph. *Eccles.* 1108, which seems to convey the former, rather than the latter meaning. On burial monuments of this form, see p. 400.

These vases, of which many were placed with the corpse, were either burned or buried with the dead body. Benndorf, at the opening of an Attic grave, saw over a dozen neatly arranged in rows upon the dust of the skeleton. They are so numerous that a grave of the fourth century B. C. is seldom uncovered without disclosing to view one or more of these vases. In the quality of their workmanship and in the artistic skill exhibited, they range from exquisite works of perfect art to very rude specimens of pottery, crude in execution and infantile in sentiment. The humble paintings upon them illustrate vividly the extent to which the artistic instinct permeated and ever characterized the Attic Greeks. They are interesting in preserving to us many peculiarities; for instance, the Athenian type of countenance with its long straight nose, sometimes even tip-tilted, and the clearly marked chin; which appearing in archaic art had been idealized away into more graceful forms by artists in the higher walks of art, the sculptors and the painters of the best period.

The scene pictured upon the great majority of white lekythoi is usually suggested by and suggestive of death, a scene, in the largest number of specimens, at the grave-mound or stele. Of the 600 lekythoi known to Pottier—who, however, has not included in his survey, at least exhaustively, the important collections in London and Berlin—on only about 50 are represented scenes other than those connected with death. Vases with these miscellaneous scenes, as we shall show later on, are as a class earlier than the lekythoi with mortuary representations. On the older lekythoi, as on other varieties of vases, are mythological scenes, heroic scenes (one representing Aineias carrying his father upon his back, with inscriptions identifying the persons), scenes of everyday life, of the home, the toilette, etc.

The vases published in PLS. XI–XIII belong, as a rule, to the class of lekythoi with mortuary scenes. A few words, therefore, upon this class of scenes, based principally upon Pottier's treatise, are in place.

The three principal events after death, in the case of an Athenian citizen, were the lying-in-state (*πρόθεσις*), the carrying forth in procession to the place of burial (*ἐκφορά*), and the burial proper, which might be preceded or replaced by cremation. Sokrates refers to these three acts (Plato, *Phaid.* 115 E), in the words *μηδὲ [Κρίτων] λέγει ἐν τῇ ταφῇ ὡς ἢ προτιθεται Σωκράτη ἢ ἐκφέρει ἢ κατορύττει*. Upon the lekythoi we meet with pictures of the first event, but not of the second, which, however, as we have seen, is vividly figured on certain terra-

cotta πίνακες; pictures of the burial; of the descent into the lower world; and of what may be called, with Pottier, the cult of the tomb, representing scenes at the grave after burial. It will be observed that there are several customs connected with death that do not figure on the lekythoi thus far discovered, such as cremation and the funeral banquet, the latter of which so often appears on reliefs.

In the Prothesis-lekythoi, which are not numerous—full descriptions of which may be found in Pottier's *Étude*—the idea of death is treated with a humane and gentle feeling. In the poets, however, we often read of women tearing the hair, beating or lacerating the breast, and rending the garments:⁵ on very ancient vases of the archaic type, known as the Dipylon vases, we see the delineation of violent grief in forms of rudest art. The same scene treated with equal realism, but with greater artistic skill, meets us also upon the prothesis-pinakes—the most notable specimen of which, from Cape Kolia, is now in the Louvre.⁶ These prothesis-pinakes, it may be remarked by way of parenthesis, may have satisfied, for the earlier and ruder period, that instinct which especially in the fourth century B. C. led to the representation, upon white lekythoi, of mortuary scenes, usually, however, with a gentler and more consoling idealism.

The final act in the actual funeral ceremonies was Burial. This is pictured on hardly more than five white lekythoi. This scene usually represents two winged genii supporting the body of the dead as they are about to lower him into the grave, which is sometimes indicated by the stele in the centre. On one lekythos, stand, symmetrically placed to the right and left, two tall male figures in a grave attitude. In another scene, a young ephebos with petasos and chlamys, raising his hand to his head, contemplates with sorrow the burial of a beautiful young girl. The winged genii are sometimes bearded and sometimes beardless. In these scenes, burial is not treated realistically, as it is upon a notable black-figured amphora:⁷ here two men are represented as leaning over an open grave, holding a coffin from which one removes a robe; two other men standing in the grave are about to receive the

⁵ Aisch. *Cho.* 22; Eur. *Hek.* 655. On one of the lekythoi figured by Benndorf, *op. cit.*, Taf. xxiv. 3, a woman kneels before a stele, tearing her hair. But this is very unusual.

⁶ Benndorf, *op. cit.*, Taf. I, copied in Baumeister, *Denkmäler d. klass. Altertums*, p. 238. On the Dipylon ware, cf. *Jahrb. d. k. deut. archäol. Inst.*, I (1886), pp. 95–125 (Kroker).

⁷ *Mon. d. Inst.* VIII. tav. IV, 1^b; reproduced in Baumeister, *Denkmäler*, p. 305.

coffin ; at each end of the scene is a woman violently weeping, with hands raised to her head ; in the background is an indication of a tree. In the white lekythoi, however, we no longer see an actual ceremony. The scene is rather an interpretation of the idea of death robbed of its terrors and treated with delicate feeling. Robert, in his beautiful essay *Thanatos*, has shown that these two winged figures are the genii of Sleep and Death ; and he endeavors to show that this peculiar type is one of the very few in vase-painting distinctly traceable to poetry. The episode of Sarpedon in the *Iliad*, or of Memnon in the Cyclic poets, gave rise to it, and it discloses itself on early black-figured ware, as well as on the later red-figured vases of a period when, however, such idealizations were spontaneous products of the unfolding genius of the Greeks.

When the dead was laid in the tomb, where in subsequent time he was ever to receive homage, his soul, by that strange inconsistency of belief which is ever found in deepest things, was supposed to begin a long journey, a journey unto a distant realm, whither it should be guided by the divine guide of souls, Hermes *ψυχοποιμπός*, and conducted by the ferryman of the dead. Among the white lekythoi there are over twenty upon which this scene of the Descent into Hades is painted.⁸ The idea is treated allegorically : the dead is represented in the company of Hermes and of Charon, though usually he is alone with Charon. Sometimes there is no indication of the near tomb ; and again Charon is represented with his bark at the very steps of the stele, on which stands or sits, as if awaiting him, the figure of the dead.

Hermes is usually of the earlier, bearded type, which the conservative vase-painters preferred to retain at a time when sculpture had discarded it for the type of the youthful god of athletic contests, like the Hermes of Praxiteles. Charon is of two distinct types : the one, a rough uncouth figure of an old man with an angry expression of countenance ; the other, the gentle type, which is more common, is that of the ordinary Attic boatman. The ruder type is probably the older.

The figure of Charon in Greek mythology, is, as is well known, a comparatively late one. Perhaps the first mention of Charon was in the early epic poem *Minyas* (quoted by Paus. x. 28. 1, 2 ; cf. Kinkel, *E. G. F.* p. 215), where he is spoken of as *γεραιὸς | πορθμεὸς Ἀδριων*. He was thus represented in the paintings in the Lesche at Delphi, by

⁸To the list given by Pottier, *Étude*, pp. 34-38, should be added our No. 11, on p. 399.

Polygnotos (fifth century B. C.). Euripides (*Alk.* 252; B. C. 438) seems to describe the Charon of the lekythoi, who is figured as standing in his bark, with his oar in his hand, looking toward the shore, in the words νεκύων δὲ πορθμεύς | ἔχων χέρ' ἐπὶ κοντῶν Χάρων μὴ ἤδη καλεῖ "τί μέλλεις;" but he does not necessarily refer to the fiercer type. The technique of the vases, and especially inscriptions, suggest a more convincing argument. On the lekythos No. 209 in Jahn's Munich catalogue,⁹ where Charon is of the ruder, fiercer type, is an inscription κα\OΣ. Aside from the fact that this use of καλός is characteristic of vases of the fifth century B. C., the forms of the λ and σ on this Attic vase indicate at least the pre-Eukleidean alphabet, *i. e.*, a date not later than the closing years of the fifth century B. C. It is, however, very possible that the rude type was used by some painters at a time when others used the gentler type. It is also certain that the latter type was used before the close of the fifth century B. C. It would therefore be hazardous to attempt to fix the chronological place of any vase simply by the type of Charon figured upon it. The technique of the vases should be taken carefully into account, as well as contemporaneous representations of Charon upon other works of art. The fierce and angry Charon of Vergil's *Aeneid*—a demon of the lower world, rather than the mere ferryman of Greek legend—was undoubtedly suggested by Etruscan conceptions, and is one of the points wherein the poet abandoned his Greek models and ideals.

On the Attic lekythoi, Charon at times wears the bonnet with up-turned rim. His boat, which is in the form of a skiff with elevated prow, is sometimes ornamented, the simplest form being a huge eye on one side of the prow: rosettes also appear, either a single one in place of the eye, or a series of them under the gunwale of the boat. Heydemann suggests that they represent the asphodel. Occasionally the taenia will be drooped along the boat; water is rudely suggested by waving lines. The figures that stand before Charon, ready to begin the mysterious voyage, are of men, women, and youths. They usually are fully draped in the himation; sometimes their heads droop. Some of the women hold the funeral fillet (taenia) in their hands: one carries a sort of box: an ephebos still holds his lance. In the field a

⁹ Lau, *Griech. Vasen*, Taf. XXIII. 2; Stackelberg, *Gräber d. Hellenen*, Taf. XLVII; Baummeister, *Denkm.* p. 378. The inscriptions of which Jahn saw traces are not reproduced in any of the drawings; they were the [κα]VOΣ mentioned above; H[ο παρ καλός]; a Μ, and either an Δ or a Ν.

taenia is sometimes displayed to indicate that this is not an ordinary voyage, but a journey into the realm of divinities. Over the heads of the two women, on one vase, flit the diminutive black *eidola*, of figures of the souls.¹⁰ In one interesting scene Charon in his boat, holding his oar with both hands, faces the stele. On the steps of the stele sits the naked form of a young man, across whose knees is thrown his chlamys. Between the thumb and first finger of his right hand he holds a small coin, which he is about to offer to Charon. At the left stands a draped woman, with long hair hanging over her shoulders (an unusual treatment); she carries toward the stele the flat basket or canistrum (*καροῦν*) common in all these scenes, from which hangs down a taenia.¹¹ The references in Aristophanes (*Ran.*, 138, etc.) and this painting seem to be the earliest-known evidence of any sort as to the custom of feeing the ferryman of the dead. This lekythos is thus as interesting as the corroded or charred jaw-bone, sometimes found in Attic graves, or in huge burial vases, with the coin still attached.¹²

II.

More than five-sixths of the white lekythoi known to archæologists are painted with scenes representing the Cult of the Tomb.¹³ In this scene there is always present, in the centre, the stele, mound, or other monument of the dead: before it, or on either side, are grouped figures of living persons, usually in profile view. One of these figures is sometimes seated, either on the steps of the stele, or in a chair. The

¹⁰ These *eidola* are met with in all the types of mortuary scenes on the lekythoi, usually as small black winged figures with extended arms, flying in the field; but sometimes as winged youths, bearing a striking resemblance to the conventional representation of Eros in contemporaneous art. They are also found on other vases than lekythoi: an interesting and well-known instance is a vase where the soul of Patroklos is present with Achilleus as he insults the body of Hektor; in another scene where Sarpedon is laid in the tomb by Sleep and Death; also in a painting, where the souls of Achilleus and Hektor, represented as two tiny warriors, are weighed in the balance by Zeus. That these figures represent the soul of the dead is clear from one of the scenes above mentioned, where the name Patroklos is written at the side of the figure. On these *eidola*, cf. O. Jahn, *Arch. Beiträge*, pp. 128-142; also Bendorff, *op. cit.*, p. 33; Murray, *History of Greek Sculpture*, I, p. 28; and, especially for the lekythoi, Pottier, *Étude*, pp. 75-79.

¹¹ Published by Mylonas, *Bull. de Corr. Hellén.*, IV, p. 371, 1; Pottier, *Étude*, p. 36, No. 13°.

¹² Cf. Pottier, *Étude*, p. 50, note 2.

¹³ For bibliography up to close of 1881, see Pottier, *Étude*, pp. 51, 52.

persons present are usually young women. Many typical scenes found on sepulchral reliefs are figured here: scenes of farewell, of mourning, of offerings at the tomb, of funeral toilette. Occasionally, musical instruments are played either by or to the dead. Where there is a seated figure it is commonly, if not always, that of the dead.

The eleven unpublished lekythoi which we now proceed to describe,¹⁴ belong in the main to this class, and in most of their details may be matched by other specimens.¹⁵

No. 1. Private property of Mr. Edward Robinson, of the Boston Museum of Fine Arts. From Athens, 1882. Intact when purchased of Dracopoulos Brothers; now in fragments put together. Is hollow within, but the neck is solid, so that the lekythos was not intended for use. Form as in Lau, *Griech. Vasen*, Taf. xxiii. 2, Furtwängler, *Vasensammlung*, Taf. VI 176. Height, 310 mm.; circumference, 330 mm. Neck, mouth (trumpet-shaped), handle and lower or under curved portion of body covered with black pigment; shoulder and upper or vertical portion of body coated with dingy white: rim of foot, in native red. On upper rim of shoulder a simplified egg-and-tongue ("sogen. Eierstab") ornament (*cf.* Lau, *ibid.*, Taf. xxv. 3, below) which I shall designate as egg-ornament, in the following description; on shoulder, triple palmette vine (PL. XI), alternate leaves red and black. All these ornaments (except as above) traced with brush in black without incised outlines. Body: around upper edge, yellowish lines inclosing meander with a cross in a rectangle in two places for the usual L-shaped outline; meander only above the picture. Colors used are dingy white, black, bluish-black, pale yellow, a dark red; principal lines traced with dry point, and afterward painted. Drawing delicate and graceful.

Scene (PL. XI): centre, a low, broad, square-topped stele, with two steps, bound with dark red fillets (taeniae). Right, a bearded bareheaded warrior in profile to left; round shield (lines of *ἀντις* incised with compasses) covering his person except head and legs, ends of deep red chlamys hanging below rim of shield; episema on shield, a vigorously though rudely drawn lion in bluish-black. In front of the warrior, partly covering stele, is held

¹⁴ It is probable that there are in the United States unpublished white lekythoi from Attika not included in this list. I should be happy to learn of such vases, and to catalogue and describe them, with their owners' consent, in future numbers of the JOURNAL.

¹⁵ Several of the lekythoi here catalogued give evidence of having been retouched in recent times. In the description I have endeavored to mention nothing as characteristic that was not clearly ancient. The modern retouching is frequently nothing more than the accentuation of a few lines that had become faint in the original design.

his Korinthian helmet, with flowing crest. Left, maiden in profile to right; long sleeveless chiton indicated by a few red strokes, and tightly clinging dark-red himation about legs; in raised right hand a sort of wand; in lowered left, hardly visible, a small prochoös. Her hair, like that of the man, was first drawn in yellow, then touched with black: it is caught up into a peculiarly shaped coiffure.

Numbers 2, and 3, are Attic lekythoi lent to the Boston Museum of Fine Arts, and now (1886, Dec.) in the Museum. No. 4 is the property of the Museum. Of their history nothing is known beyond the fact that they were purchased by Mr. L. D. Allen in Athens, in 1875.

No. 2. Form more slender than No. 1, or Furtwängler, *op. cit.*, Taf. vi. 177. Height, 269 mm.; circum., 226 mm. Neck, mouth, handle and lower third of body painted as in No. 1. Shoulder and upper two-thirds of body covered with dingy white. Shoulder rather flat; no egg-ornament above; palmette vine as in No. 1, except colors which are only dirty black. Body: four brownish-yellow lines around upper portion, one on shoulder near edge, one on edge; then the simple meander in black, only above picture: on lower edge of white on body, two brownish-yellow lines around vase. Rim of foot in native red. Colors used in the drawing only dark reddish-brown, and deep red; in ornament, brownish-yellow and black. Drawing fair.

Scene (PL. XII-XIII, *fig. 8*): centre, a slender stele bound with fillets; anthemion and egg-ornament; two steps. Right, maiden in profile to left, in chiton, over which a himation of deep red: bare right arm extended toward stele; left obliterated. Left, a maiden, with head bent forward, in chiton, approaches stele bearing in both hands flat basket, in which perhaps fruit (pomegranates). Traces of *eidolon* in field at left of stele and flying toward it. Part of stele, lower part of both figures, except feet of left figure, effaced.

No. 3. Form in general as No. 2, but a little more slender. Fractures at neck and handle. Height, 265 mm.; circum., 226 mm. Neck, mouth, handle and base of body painted as in Nos. 1, 2. Shoulder and upper part of body covered with dirty yellow, which is darker where the figures are clearest—possibly due to fire(?). On shoulder no egg-ornament, and the palmette vine as in Nos. 1, 2, much effaced; probably only in brown, or brownish-black. Body: four yellowish-brown lines, between which meander, only above picture. Colors used in the scene, only dull red. Drawing fair.

Scene (PL. XII-XIII, *fig. 9*): centre, slender stele, with anthemion (below no egg-ornament) and two steps; traces of fillets. Right, a woman kneeling to left; left hand raised above head, right extended covering stele:

appears to be nude but probably her garments have been effaced. Over her left hand, in field, *eidolon* flying to left. Left, youth standing in profile to right, his nose tip-tilted; right hand extended toward stele. Apparently nude. Design very much effaced. In field to right of anthemion a hand-mirror.

No. 4. Form as in No. 1. Height, 310 mm.; circum., 267 mm. Neck, mouth, handle, and lower third of body as in No. 1. Mouth distinctly trumpet-shaped. Shoulder: no egg-ornament, but a palmette vine as in No. 1, with more elaborate encircling lines; leaves of palmette alternately red and black; red used also in vine: the whole perfectly preserved. Body: meander, and inclosing lines as in No. 3; meander only above picture. Colors as in No. 3. Drawing fair.

Scene (PL. XII-XIII, *fig. 7*): centre, rather broad stele, with obscure anthemion top, and egg-ornament; two steps; traces of fillets. Right, youth standing *en face*, head in profile turned to left; traces of chlamys: right arm extended diagonally downwards; left foot, *en face*, poorly drawn. Left, woman kneeling, right hand extended toward stele; left, resting upon top of head; figure apparently nude, but probably her himation has been effaced. In field to left of anthemion small black *eidolon* flying to right.

No. 5.¹⁶ Private property of Rev. H. Fairbanks, St. Johnsbury, Vt. From Athens, 1857. Form as in No. 1, except that there is no distinction between the neck and shoulder, the two merging into each other: the neck is very thick: the handle is slender, and the body, instead of having the usual cylindrical shape, has almost that of an inverted truncated cone. Height, 153 mm.; circum., 157 mm. Only the mouth, the back of the handle and the base of the body are covered with the black pigment: the neck, shoulder, handle (except back), and edge of foot are left in the native red, while only the upper two-thirds of the body is covered with the usual white coating. Upon the native red of the shoulder is a rudely-drawn ring of dots with lines radiating outward from the base of the neck, apparently conventionalized lotus buds and stems (*cf.* numbers 6-9). The upper part of the body is encircled by four brownish-black lines, between which we should expect the meander: but the meander is not preserved (if it ever existed), nor any part of the pictured scene, traces of which, however, sketched in red, are clearly evident. This vase belongs to an earlier type than numbers 1-4.

Nos. 6-11 are now in the Metropolitan Museum, New York. They were purchased in Athens, in 1874, of M. Rhoussopoulos, professor in

¹⁶This vase I have not seen. My account is based upon a drawing and description kindly furnished me by Mr. Arthur Fairbanks, tutor in Dartmouth College.

On the peculiar coating of Nos. 5-9, see p. 405, note 22.

the university, by Mr. Samuel G. Ward, and by him presented to the Museum. They were found in "recent [before 1874] excavations near Athens:" they are illustrated in PL. X.

No. 6. Form as in Lau, *op. cit.*, Taf. xxiii. 3 (with no plastic distinction between neck and shoulder). Height, 158 mm.; circum., 182 mm. Intact. Black and native red as in Lau, *ibid.*: *i. e.*, black pigment on mouth, back of handle, lower part of body: the neck, shoulder, handle (except back), and rim of foot, in native red. Mouth, not trumpet-shaped, flat and broad. Shoulder decorated with a ring of black dots from which radiate outward, toward the edge, black lines. Body: pale salmon-colored rather than distinctly white coating; simple meander, between one line above and two below, only above picture. Colors, besides the native red and whitish coating, only black, which where thinly applied appears brown. Drawing indifferent, rapid and careless: anatomy of figure indicated distinctly according to a mechanical scheme.

Scene (PL. XII-XIII, *fig.* 3): centre, naked youth *en face*, running to left, head in profile to right: right arm raised. Both feet rest on the ground. Right, a serpent with raised head pursuing the youth.

No. 7. Form more slender than No. 6. Height, 173 mm.; circum., 178 mm. Almost intact. Colors applied and distributed as on No. 6: coating somewhat whiter. Shoulder ornament as in No. 6, except that ring of dots more nearly resembles lotus buds (*cf.* remark on No. 5). Body: around upper rim horizontal lines as in No. 6, two above and two below, between which—only above picture—a series of vertical parallel lines (*cf.* Lau, *op. cit.*, Taf. XXI, design at upper left-hand corner) instead of meander. Colors used, besides native red and white coating, only black, which often appears brownish. Drawing fair, but careless.

Scene (PL. XII-XIII, *fig.* 4): centre, woman seated (seat effaced), in profile to right, wearing talaric chiton appearing only above her feet and indicated by finely drawn parallel lines, over which is a dark gray himation closely wrapped about the figure: a sort of hood on the head (drawing obscure); right hand, raised to face, shows only tips of fingers above the himation: between thumb and forefinger small circular object, perhaps fruit:¹⁷ in the left hand held above the knees a small round mirror. In field, behind the figure, end of a fillet hanging below the border ornament of body. In field, to the right, KA ∨ E.

¹⁷ It is possible this figure is sitting before a rounded tumulus. In Benndorf, *op. cit.*, Taf. xxiv. 2, is shown a figure in front of a rounded tumulus. It strikingly resembles ours, except that the woman is standing and holds no mirror. Behind her in the field—as in No. 7—is the end of a fillet which hangs upon the tumulus.

No. 8. Form as No. 6. Height, 167 mm.; circum., 187 mm. Colors applied and distributed as in Nos. 6, 7. On rim of foot a narrow ring painted in black. Shoulder ornament as in No. 6. Body: yellowish-white coating; four yellowish lines around upper edge between which (two above and two below) simple unbroken meander, only above picture (*cf. Lau, op. cit., Taf. XXI, third design from top in second column from the right*). Colors (besides white and native red) black, yellowish- and brownish-black; in scene, outlines in reddish-brown, with deeper red in hair and himation of the figure. Drawing fair, but careless; much effaced.

Scene (PL. XII-XIII, *fig. 1*): centre, seated female figure, in profile to right, bareheaded, in himation; in extended right hand, arm bare to the elbow, a lekythos traced only in outline (larger than the average; form as in Furtwängler, *Vasensamml., Taf. vi. 176*). Behind the figure, a long slender stele with pointed top; two steps; traces of dark red fillets on steps. Beyond the stele there may once have been another figure, no trace of which, however, remains.

No. 9. Form as No. 6. Height, 204 mm.; circum., 236 mm. Intact, except that foot has been attached. Application and distribution of colors and ornament as in No. 8; meander as in No. 8, only above picture. Colors in scene, dark brown where brush is first applied, afterward lighter, almost yellowish: traces of a sort of dark pink on a part of the himation. Drawing fair, elaborate and usually careful (feet admirable, but hands indifferent). Colors bright and distinct, nothing effaced.

Scene (PL. XII-XIII, *fig. 6*): centre, figure of woman *en face*, bareheaded, running to right, but with face in profile to left; both feet on ground: talaric chiton, marked in fine parallel lines, appearing over right forearm, shoulder and breast, and below himation; himation wrapped about body and left shoulder and arm: on extended left arm wide and deep canistrum, from which depend three fillets and in which are a garland (semicircle with dots) and a lekythos; in the right hand extended to left, held by a handle is an apparently double basket from which hang down three fillets. On the right, near the advanced left foot of the figure, is a low step upon which the painter may have intended to draw the stele.

No. 10. Form more slender than the foregoing: like Furtwängler, *Vasensamml., Taf. vi. 177*, but with no plastic ridge marking shoulder from neck. Height, 248 mm.; circum., 242 mm. Fractured, but skilfully put together. Mouth narrow, deep, and trumpet-shaped. Black applied as in the classical type of the IV century B. C.; *i. e.*, on mouth, handle, neck and lower part of body. Bright and clear white coating on shoulder and main portion of body. Shoulder: in black and very sketchy, the so-called egg-ornament and the triple palmette vine, only in black. Lines inclosing the meander, and around the lower edge of the white, bright yellow; meander, only

above picture, the usual fret with occasional cross in rectangle, in black. Colors in the scene: lines are traced in light brown and black; fillets, edges of anthemion, and himation of figure on left, once dark pink or red; chlamys and kothornoi of figure on right touched in black. Drawing delicate and accurate in the main (the hands especially graceful); on the faces a beautiful expression of pensive sorrow; somewhat effaced; colors indistinct.

Scene (PL. XII-XIII, *fig. 5*): centre, slender stele with elaborate anthemion, behind which emerge the ends of acanthus leaves; below anthemion, plain Lesbian kyma, and below that a band with so-called egg-ornament. Stele rests on three steps, the upper one being very low. Behind the stele a high rounded tumulus, which like the stele is hung about with dark red fillets. Right, a bareheaded epebos *en face*, head in profile to left, drooping, petasos hanging behind his neck; weight rests on right leg; chlamys, held with a pin (not distinct) on right shoulder, is caught over his left forearm; right arm is extended obliquely forward, fingers and thumb apart; against his left arm held loosely in his fingers two spears; on his feet hunter's boots (kothornos). Left, a bareheaded youth, in profile to right: in himation, over left shoulder and under right arm held upon left arm; his right arm is extended, palm upward, toward the stele; in the left hand held obliquely downward he holds a lyre of the most frequent type (*cf. Pottier, Étude, plate IV*).

No. 11. Form as No. 10. Height, 251 mm.; circum., 248 mm. Colors applied and distributed as in No. 10; meander more involved than in No. 10. Colors used on body: brownish-maroon,—in main lines of figure, and in shading the maiden's himation; yellow,—in the lines inclosing the meander, and on Charon's exomis; black,—on one of the fillets on stele, on hair of boy, on Charon's hair and beard, and on the fillets hanging from the canistrum and in the haud of the maiden, also in Charon's exomis; brilliant dark scarlet,—on Charon's cap, on one of the fillets on the stele, and on rim (across the breast) of the boy's himation. The figures were drawn before the stele was put in. Drawing rapid, but very graceful and skilful.

Scene (PL. XII-XIII, *fig. 2*): centre, stele and ornament as in No. 10; anthemion more sketchy; stele with three steps; in front of stele, and partly hiding it, stands a boy, *en face* with head in profile to left; hair rather long; in himation, enfolding him except right shoulder and right arm, which extends obliquely downward to left, with fingers as in epebos of No. 10: impossible to decide whether or not he may have had a coin between the thumb and forefinger of right hand, probably he did not. Left, Charon in his boat, above the level of the steps of the stele; boat of the simplest form with long pointed prow; on the side near the prow an oblong figure as ornament. Charon standing in boat in profile to right, his right knee

bent, leans forward and extends his right arm, palms upward, to the boy; in his raised left hand he holds his pole, the lower end of which passes behind the stele. Charon, whose face is that of the nobler, gentler type, wears the common conical sailor's cap, painted dark scarlet, a band about its rim, and (apparently) a sort of button at the top, and a bright yellow exomis. Right, a maiden standing *en face*, with head in profile to left; her face is obliterated: she wore a himation, leaving only the right shoulder and arm uncovered, and probably a sleeveless chiton. Her right arm is extended with bent elbow toward the stele, and in the hand she holds a black fillet; on her left arm, and raised to the height of her shoulder, is a shallow canistrum from which hang down two fillets.

Among the important modifications and variations in these scenes should be mentioned the different forms and sizes of the stele. It is well known that in Attika, in the sixth century B. C., the long and slender stele was frequent; in the fifth, the tumulus without stele seems to have supplanted it; but in the fourth century the stele, now become shorter and wider, is again in favor. The lekythoi frequently exhibit stele and rounded tumulus together. At first the stele is a long and slender slab, sometimes an actual column with an architectural capital; it is capped by an ornament of the nature of an anthemion (conventionalized palmette) or of a pediment, or by a mere horizontal band or moulding: sometimes it is surmounted by the figure of an animal, such as a lion. Later the height varies. On the tumulus, or burial-mound, which is occasionally found alone, is frequently represented a vase. The lekythos itself, which in the form of a huge marble monument is found in Attic cemeteries of the fourth century B. C.,¹⁸ does not, however, figure as such in any lekythoi-paintings, so far as known.

In many of the scenes the stele seems to stand for the tomb and its contents, and it is often treated as if it were the dead himself. It is oiled and perfumed, decorated with the funeral taeniae, or fillets, and approached with attitudes and gestures of reverence and worship. On the upper part of the stele and in the field are now and then to be

¹⁸ For a picture of such burial monuments, see Mitchell, *History of Ancient Sculpture*, p. 505. Cf. also *Arch. Zeit.* 1864, p. 145; and *Gaz. Archéol.* I. plate VII, pp. 21, 41, with other literature cited by Wolters in *Friederichs Bausteine* (1885), pp. 358-360.

Milchhöfer (cited by Mrs. Mitchell, *op. cit.* p. 383), *Mith. d. Athen. Inst.* v, p. 173, suggests, as an explanation of the absence of grave monuments with the tumulus in the fifth century, that these consisted of painted terracotta vases (lekythoi, amphorae, etc.) of a tall, slender shape, which by reason of their fragile character have disappeared.

seen conventionalized or realistic representations of foliage, in which—almost entirely in the later lekythoi—the acanthus is especially frequent.

The persons present at the stele are usually women and maidens. When men are figured, it is commonly the ephēbos with petasos and chlamys, often having the appearance of a passer-by who has paused for a moment at the grave. Very seldom a mounted horseman figures in the scene. One of the persons is sometimes seated, either in a chair or on the steps of the stele, and is commonly receiving the offerings of those who approach. Once in a while a woman kneels on the steps of the stele, and seems to be listening: another woman, in the same attitude, is fastening fillets to the monument, or laying a garland upon it. The dress of the figures is very seldom the black or sober violet prescribed by law for the thirty days of mourning (Plutarch, *Per.* 28). The himation is sometimes blue, or red, or pink. This may indicate that these visits to the tomb were supposed to take place at times later than the legal period of mourning. Where an expression of grief is given the figure, it is usually that of calm or of impassive resignation: but commonly there is no expression of any sort upon the faces. The hand with upturned palm, or with thumb and forefinger drawn together, is extended toward the stele. At times, the head rests upon the hand in the attitude which to the Greeks signified grief, rather than mere meditation as in modern art. Occasionally, the visitors seem to be conversing with the dead. It is almost needless to add that there is no attempt at individual portraiture on any of these vases.

The objects in the hands of the persons approaching the grave are of the most varied character: some objects are such as were associated with the funeral banquet; others, favorite articles; others, merely ornaments for the stele, or sacred offerings (wine, etc.) for libations, or oil for anointing the tomb. In the canistrum (*κανοῖον*), the wide, flat basket borne by the women, we see fillets, garlands, vases (lekythoi and alabastra) with perfumes, boxes with incense; honey-cakes, pomegranates, perhaps eggs: there are also representations, in the pictures, of mirrors, strigils, swords, etc. A bird, a fan, a rouge-pot, or a mirror hints that the dead was a woman or girl; a dog or sword, that he was a man or youth. The vases figured in these scenes are very numerous and varied: the hydria, or large water jar, with three handles; the oinochoë and prochoës, different forms of wine-pitchers; the phiale or flat saucer used in making libations; the lekane, the pyxis, the plem-

choë with its flat top and solid base; the alabastron and the aryballos, a sort of cruet with peculiar handles, for holding the oil used in anointing the slab; but, above all, the lekythos itself, containing perfumes. These lekythoi—which are usually of the less slender form—when not in the hands or in the baskets of the persons making offerings are either fastened by fillets to the stele, or stand upon the steps of it, or of the tumulus when the latter is figured in place of the stele. Sometimes is represented a large amphora upon the top of the tumulus, placed there to receive the liquid offerings.

Not alone were the bodily wants of the dead to be satisfied: in his loneliness, his spirit must be cheered by sweet music. There are several instances where the lyre figures prominently in lekythoi-paintings, sometimes in the hand of a standing or of a seated person, sometimes leaning against the stele: in one instance the tympanum, a sort of tambourine, is in the hands of a woman.

Most of the articles represented in these simple pictures, so numerous and varied, and in some cases so costly, were left at the tomb. In recent excavations of graves upon which the earth has gathered, in the lapse of time, it is not unusual to recover them. That they should have tempted the cupidity of the lawless and sacrilegious is not surprising: it is for this reason that many mortuary inscriptions contain denunciations and curses, intended for all who should disturb the tomb. Lucian (*Nigr.* 30), writing many centuries later, speaks of servants stationed at tombs to guard the offerings placed there by friends of the dead.

The information upon the manners, customs, and beliefs of the ancient Athenians to be won from these interesting lekythoi-pictures has been by no means exhausted. Here is a field as yet not thoroughly explored by any one. The information obtained in such inquiries is autographic: it does not come to us through the muddy and perplexing medium of centuries of dictionary-makers, nor through the distorting lens of philosophy or of poetical speculation, but immediately from the hands and hearts of simple artizans, who themselves reflect unconsciously the age in which they lived.

III.

The discussion of our lekythoi will lack an important element of completeness, if we do not ascertain their place in the development of this variety of vase-painting. The task of ascertaining this place must at present necessarily be tentative and provisional: this question has

not yet received the systematic and thorough examination in all its details that is required for its final settlement. Some excellent and most suggestive hints, however, have been thrown out by Furtwängler.¹⁹ Taking advantage of these, and following the lines laid down by the Berlin archæologist, supplementing and more closely classifying here and there, we now proceed to sketch the history of Attic white lekythoi. We shall thus expect to establish chronological divisions, into some one of which each of the lekythoi published in this article, so far as it is original, must evidently fall.²⁰

In outlining the history of white lekythoi, hardly more than a certain order of development, or the chronological sequence of certain favorite types, can be determined, with perhaps approximate dates for a few vases in the several groups or series thus ascertained. This grouping must be based upon the independent application of several criteria in the study of the material, the results of each such application supplementing and correcting the results gained from the application of the other criteria. Now the criteria chosen are (1) form of vase, (2) technique, (3) types of subordinate decoration, (4) certain characteristics of the scenes painted upon the vases, and (5) inscriptions.

The earliest prevailing form of the white lekythoi is a short stout vase with large body, with no distinction of shoulder, and with wide handle attached to rim of mouth and body (Furtwängler, *Vasensamml.*, Taf. VI, No. 102). This form is succeeded by one in which the body remains stout, but is marked off at the upper end with a high shoulder; it has a cylindrical neck, a low narrow mouth, handle attached below the mouth's rim (Furtwängler, *ibid.*, No. 175). Very few vases of this form have the white ground, and then only on a small part of the vase. The white ground becomes frequent in the following form.²¹ The body

¹⁹ *Arch. Zeitung*, 1880, pp. 135-137; and in the classifications and descriptions of the Berlin lekythoi, in his *Vasensammlung im Antiquarium*, 1885.

²⁰ Inasmuch as certain types of fabrication, decoration and artistic technique were slow in receiving recognition, and were perpetuated long after they had ceased to be the prevalent types, it becomes impossible to assign its exact date to any special vase under consideration: the utmost that may be done in most cases is, to assert that the type to which the vase belongs prevailed at such and such a period, but that the specimen in hand may be earlier or later than this period. It is with this understanding that the vases above catalogued are assigned places in the following chronological sketch.

²¹ Our No. 5 has a form which is earlier, as prevalent form, than the form just now mentioned. But it by no means follows that this particular vase is therefore necessarily an earlier vase.

of the vase now becomes slimmer, swelling upward from the foot by a curve at first sudden and then gradual. The shoulder is almost flat: the neck is long and narrow: the mouth of the vase is high and broad, cup-shaped, and frequently also narrower, deeper and trumpet-shaped. The handle is attached as in the preceding form. Most lekythoi figured on the lekythoi-pictures are of this form, which must have been prevalent through a long period. Before it falls into disuse it is succeeded by a still slimmer form, with high (instead of flat) shoulder, shorter neck, and (usually) trumpet-shaped mouth—the form described as typical on p. 387.

The four other criteria we shall simultaneously make use of: viz., technique, decoration, pictured scenes, and inscriptions.

The earlier forms of lekythoi with white ground have a technique which in many of its features requires us to place them in the period of Black-figured ware, both *early*, and *later*. It is, however, in the *late* or second division of this period that white begins to be used as a ground color on the body of the vase. The application of a thin chalky coating on the picture part of the native red of vases was practised at this time, not only for lekythoi, but also for oinochoai, kylikes, etc. This white coating is almost never now put on the shoulder of the lekythos. The mouth, back of handle and lower part of the body receive a black coating. The shoulder is decorated, at first, on the native red, with figures of animals (lion, hen, hare, etc.), and then these with the palmette; lotus buds with radiating lines are also used alone on the native red shoulder; the so-called egg-ornament appears on the upper edge of the shoulder, and then the meander on the upper part of the body. All this is done before the white coating has extended upon the shoulder. These motives reappear later. The pictured scenes upon these lekythoi are mostly but not entirely mythical. Very few lekythoi of this period are found in a perfect condition: they have usually been badly burned and defaced by fire. The vases of later years, which are preserved in great numbers and very perfectly, owe their preservation to their having been merely buried, rather than first burned and then buried with the dead. The typical or classical form of the white lekythos is already reached in the latter part of the period of the Black-figured ware, which might roughly be placed from 550–450 B. C., the last years of it being contemporaneous with the earlier years of the period known as that of Red-figured ware.

It is in this period of Red-figured ware, with its subdivisions known

as the *severe*, the *early-free* (before 400 B. C.), and the *late-free*, especially in the last of the three, that white lekythoi most abound. At the outset, the newly acquired red-figured technique is transferred to the white lekythoi; instead of figures in dead black, fully filled in, outline drawings—at first in the severe style—are made on the white ground. In the earlier stage of the severe style, these outlines are drawn in thin fine lines; eyes are represented *en face* in profile faces; the white ground is of a dirty yellow. In the later stage of the severe style, the outlines are bluntly drawn with the brush and with the black pigment of the coating, or with a thin yellowish paint, while the ground is usually a clear, bright white. Eyes are represented in profile. In the earlier stage, the scenes depicted are mostly from ordinary or home life, or of such familiar divinities as Eros, Nike, etc. In the later stage,²² perhaps about 480–450 B. C., begin to appear in increasing numbers representations of the cult of the tomb. On these lekythoi the grave is usually a tumulus, before which sometimes stands a very slender stele.

Long before this time, the custom had prevailed of placing these lekythoi, among the other offerings, with the dead. The feeling gradually gained recognition that the appropriate scenes for vases designed for these uses were such as would suggest the loving devotion of survivors, and, as an expression of this feeling, scenes of the cult of the grave became the rule. In these two stages of the *severe* subdivision of Red-figured ware, the body of the white lekythos alone (with few exceptions) is coated with white. On the native red of the shoulder are painted the palmette vine and other motives mentioned above, though the animal decoration disappears: the neck and lower part of the body are left uncovered. But soon the natural step is taken of covering these parts with the black pigment, such as was used on contemporaneous Red-figured ware proper. The white coating is likewise extended over the shoulder. The classical form of the white lekythos had become fixed several decades before: now, by this innovation, which becomes the rule, the classical type of decoration becomes fixed: *i. e.*, the shoulder and body are white, while the other parts of the vase are coated a

²² It is perhaps here that we should place Nos. 5–9. Note on No. 7 the inscription in the old-Attic alphabet. The term White Lekythoi is sometimes restricted to vases of the decoration of Nos. 1–4, and 10, 11. Nos. 5–9 may belong to the class designated by Dumont as *vases dits du type de Loeres*. Cf. Collignon, *Catal.*, pp. 88–99; Pottier, *Étude*, pp. 4, 5. The White Lekythoi *κατ' ἐξοχήν* are coated with a chalky coating which is distinctly white, and easily flakes off: in the *vases de Loeres* the coating is usually a yellowish-white, as firm as the other colors on the vase.

deep black. Just about this time the meander ornament is sometimes used both above and below the picture; later, the lower band was discarded. The Olympichos vase²³ shows this transition stage admirably, and also, by means of its inscription, in the old-Attic alphabet, written mostly from right to left,²⁴ enables us to fix upon a date, at least not much later than 450 B. C., near which time it was probably made.

It is, however, in the next subdivision of the Red-figured ware, *i. e.* in the *early-free*, which may be regarded as extending to about 400 B. C., that sepulchral scenes begin very distinctly to predominate. There are many lekythoi of this period without any white ground whatever. The types of form and of subordinate decoration previously fixed are followed: in the meander a cross or an X begins to be inserted as in our No. 1. Besides the black pigment of the coating, dark red is used in touching up here and there, as in the alternate leaves of the palmette vine on the shoulder. The main outlines are now traced with a dry point, over which is drawn the brush charged with color. Colors become more various. Outlines are traced not only in the usual black, but also in dark red, and in greyish tints; details are filled in with these colors and also with violet, blue, and green. The stele becomes less slender, and the tumulus less frequent. On all these vases the shoulder is decorated with the triple palmette vine; and the meander, instead of encircling the vase, extends only above the picture.²⁵

In the second, or so-called *late-free*, subdivision of Red-figured ware, subsequent to 400 B. C., the lekythoi are in many cases wonderful works of art. We now have perfected polychromy on a white ground. The outlines previously drawn with a dry point are traced over with a brownish-red paint, and a rich variety of colors is used in filling in, for garments, etc. Violet is common. The palmette vine on the shoulder is omitted in many cases: the shoulder then remains white or is partly covered by the acanthus leaves which rise upward from the top of the broad stele. The meander likewise

²³ Furtwängler, *Vasensamml.*, No. 2252; *Arch. Zeitung*, 1880, p. 134.

²⁴ ΣΟΝΑΧΣΟ+ΙΠΙΝΥΝΟ Ὀλύμπιχος καλός
ΣΟΝΑΧΣΙΑΠΟΗ ὁ παῖς καλός, and ΚΑΝΟΣ καλός.

²⁵ Here belongs our No. 1, and at about the same time Nos. 2, 3, and 4. The Munich vase (Jahn's *Catalogue*, No. 209; *cf.* p. 392) belongs to about the same time as No. 1, though in coloring it is richer. The Dromippos vase in Berlin (Furtwängler, *Vasensamml.*, No. 2443), with its inscription in the new-Attic alphabet, and with its *καλός* sentiment, suggests 400 B. C. as not very far from the date at which this type of white lekythoi prevailed. Our Nos. 10, 11 are probably later.

begins to be omitted: at first the horizontal lines inclosing it are retained, and then they are omitted. Finally, the white coating is extended over the whole vase. The colors in the paintings are often treated with great art: according to Pottier, flesh parts are tinted, and rendered with an eye to light and shade. The stele on these products is usually low and broad. The acanthus ornament, which, on datable Attic reliefs, is said first to appear early in the fourth century, is likewise found here.

Toward the latter part of this period, the preparation of these vases has become so much of an industry that the signs of careless work become more and more apparent; the clay used is of a poor quality; the white coating coarse and inferior; and the art of these humble artizans loses something of the ideal loveliness that marked the work of their craft in the first and second thirds of the fourth century B. C.

JOHN HENRY WRIGHT.

*Johns Hopkins University,
Baltimore, Md.*

THE PORTRAITURE OF ALEXANDER THE GREAT: A TERRACOTTA HEAD IN MUNICH.

I.

The portraiture of Alexander III of Macedon has long been one of the vexed questions of ancient iconography; a circumstance the stranger from the historical certainty that the royal lineaments were often portrayed. Nor was this done mechanically or perfunctorily, as may have been the case with such worthies as Demetrios of Phaleron or Hadrian (Pausanias, I, 18. 6): but in such fashion, and by artists so famous, that a history of Greek art would be incomplete without a consideration of the types thus created.

Pliny (*Hist. Nat.* VII, 37. 125) reports the tradition about a decree of Alexander, granting to Apelles, Pyrgoteles, and Lysippos, a monopoly of the reproduction of his features, within the limits of the art that was the peculiar domain of each: painting, gem-cutting, and bronze statuary. This is sufficiently distinct. The corroborative passages that have been collected¹ are less exact. In particular, the Greek writers express themselves in a way that does not tend to sustain the hypothesis, that Alexander actually promulgated a decree on so trivial a matter. It has been severally conjectured, that these artists were appointed his official portraitists, court-painters, as it were; that he refused to sit to any others; and that only these three were honored with his own orders. We learn of too many portraits by other eminent painters and sculptors to admit for a moment that the privilege was actually an exclusive one. The most noteworthy circumstance is the striking omission of any reference to sculpture or sculptors proper, the "stone-scrapers" (*λιθοξόοι*) of archaic art; more especially when a branch of art so subordinate as gem-cutting is made so prominent. In another passage (XXXVII, 8), Pliny restricts the privilege accorded to the gem-cutter to the use, in the portraiture of Alexander, of the

¹ Brunn's *Geschichte der griech. Künstler*, I, p. 363; II, pp. 209, 489: Overbeck's *Schriftquellen*, Nos. 1446 sqq.

emerald, or the stone the ancients knew by that name. Very probably, but one was ever engraved with his patron's profile by Pyrgoteles, who owes to this anecdote a celebrity his title to which is very dubious, since nothing further is known of him, or of works by his hand. Yet his name has been used as the personification of ancient glyptics by a modern authority on this subject;² and an elementary handbook by a distinguished French archæologist, of which an English version has lately been issued, places this relatively obscure artist at the very head of all Greek gem-cutters.³ A fine sardonyx cameo, signed ΠΥΡΓΟΤΕΛΗΣ, and representing Alexander wearing on his head a lion's mask, was published by Stosch (*Gemm. ant. cael.* t. LV) in the last century, but need not further engage our attention, inasmuch as it was declared a forgery by Bracci (*Mem. degli antichi incisori*, II, p. 184) and by Winckelmann (*Mon. ant. ined.*, I, p. LXXVII). Suetonius tells of an intaglio-head of Alexander used as a signet by Augustus. No mention of an illustrious engraver is made in his casual notice, but it is a safe presumption that none but a stone cut by some exceedingly skilful lapidary would have enjoyed this marked preference of the imperial virtuoso: indeed, it is much more likely that a fine antique gem took his princely fancy, than that he deliberately chose to publish his admiration for a character and a career that were quite the antithesis of his own.

Of Apelles, Pliny (xxxv, 93) says, broadly, that it is superfluous to enumerate how often he painted both Alexander and Philip. His career, begun in the reign of Philip, did not reach its close until long after Alexander's, with which its culmination was coincident. He flourished, says Pliny (xxxv, 79), in the cxii Olympiad (332-328 B. C.). Chief among this artist's portraits of Alexander was one at Ephesos, treasured in the temple of Artemis; the one for which he was paid twenty talents in gold, the money being measured to him, not counted. Cicero refers to it (*in Verr.* IV, 60. 135) as a treasure the Ephesians could not be induced to part with; and its preëminence gave rise to this rather weak epigram: "There are two Alexanders, the invincible, by Philip, and the inimitable, by Apelles."⁴ As a portrait, nevertheless, it was a failure. The hero was figured after the type of the god

² Krause, *Pyrgoteles, oder die Steine der Alten*, 1856.

³ "Gem-cutting attained perfection in Pyrgoteles, who engraved the seal of Alexander." Collignon, *A Manual of Greek Archæology*, translated by J. H. Wright: New York and London, 1886, p. 338.

⁴ Plutarch, *De Alexandri M. seu virtute seu fortuna*, 2.

Zeus, holding a thunderbolt. Lysippos, the sculptor, blamed Apelles, the painter, severely and justly (though perhaps with a rival's pique at the twenty talents) for giving to a mortal this divine attribute: saying that he himself had given to his statue only a spear, the true and appropriate glory of which no time would take away (Plut., *de Isid. et Osirid.*, 24). The attribute chosen by Apelles entailed more direct neglect of individual feature on account of the brown and dusky color he had to give his hero in order to furnish a suitable contrast to the painted lightning: Plutarch (*Vita Alexandri*, 4) notes how contrary this was to actuality, since Alexander's skin was of a rare whiteness, with a ruddy glow about the breast and face. Apparently, the artistic reason escaped him. This celebrated picture by the prince of technic, who added ivory-black to the painter's palette,⁵ and first discovered the application of vitreous varnish (Plin. *H. N.* xxxv, 97), must have possessed some of the qualities we moderns most readily associate with the name of Rembrandt: *enargeia* and *krasis*, which words, in this context, I shall render by the terms *relief* and *warmth*, so familiar in our artists' vernacular, are the qualities Plutarch ascribes to it.⁶ Accordingly, where a single commendation of a particular excellence has been handed down, it is not any characteristic feature or expression that is mentioned, but it is that the thunderbolt or lightning, and the fingers that held it, seemed to stand out from the picture-plane (Plin. *H. N.* xxxv, 92). Brunn,⁷ endeavoring to place the Kolophonian master, aptly alludes to a certain analogy between the type of a reigning conqueror he embodied, and David d'Angers' renowned painting of "Bonaparte crossing the Alps."

The analogy of two other compositions by Apelles, with Alexander as the principal figure, bears out Brunn's comparison: these paintings Augustus hung in a chief place in his forum. Purely allegorical, they represented Alexander on a triumphal car driven by Victory and escorted, like a second Sun-god, by Kastor and Polydeukes, stars of the morning and evening, or accompanied by a personification of Triumph and driving War before him with hands tied on his back. Claudius cut out Alexander's face from both paintings, and had the features of Augustus substituted.⁸ If this was madness, there was method in it. Personality, in these compositions, was immaterial, was an accident.

⁵ Plin. *H. N.* xxxv, 42: *Apelles commentus est ex ebore combusto facere atramentum, quod elephantinum vocatur.*

⁶ *De Alexandri M. s. virtute s. fortuna*, 2.

Geschichte der griech. Künstler, II, p. 219. ⁷ Plin. *H. N.* xxxv, 93, 94.

Quite opposite, as his criticism of Apelles indicated, was the method of portraiture adopted by the third of the preferred artists, Lysippos of Sikyon. His many portraits of Alexander, in a series that opened with the conqueror's boyhood,⁹ and what Pliny (*H. N.* xxxiv, 37) styles the "inexplicable multitude" of the bronzes with which he flooded the cities of Hellas, identified his time with the historical period known as the age of Alexander.¹⁰ Famous above all was the figure with the spear, the same contrasted by himself with the fulminant ideal conceived by Apelles.¹¹ Epigrammatists¹² celebrated the master-stroke that made a very deformity singularly expressive of the subject's actual character of haughty ambition, no less than the equally characteristic leonine fierceness of the eyes. Every schoolboy knows that Alexander's head inclined slightly towards the left shoulder: he was afflicted with that flaw of muscular anatomy known to physicians as *torti collis*, which consists in a shortness of one of the great sternocleido-mastoid muscles of the neck. These muscles, when they normally contract simultaneously, bend the neck forward; but, when they pull singly on the mastoid process of the temporal bone, each turns the head to the opposite side,¹³ as a rudder is turned by its yoke-lines. Other sculptors had rendered this defect, together with the sparkle and lustre of Alexander's eyes,¹⁴ without attaining to that expressiveness of form and feature which revealed his true individuality, or *ethos*. Their statues were like certain of his companions and successors, who affected a moist eye and a mimetic droop of the head, without, somehow, becoming more impressive for this. One Stasikrates, whom Tzetzes contrasts with Lysippos,¹⁵ gained no credit with his patron by suppressing physical defects which his rival had honestly rendered.

No other single statue of Alexander by Lysippos is specifically mentioned. Two elaborate compositions,—the Squadron of Alexander at the battle on the Granikos, and Alexander's Hunt wrought by Lysippos in conjunction with Leochares,—recall the hunts and battle-pieces

⁹ *Ibid.*, xxxiv, 63.

¹⁰ Plin. *H. N.* xxxiv, 51; cxiii. (Olympiade) *Lysippos fuit, cum et Alexander Magnus.*

¹¹ Citations collected by Overbeck, *Antike Schriftquellen*, 1479-1484, s. n. *Lysippos.*

¹² Poseidippos, *Anthologia Graeca*, II, 50. 14, et al.; Archelaos, *Anth. Gr.* II, 57. 1, et al.

¹³ See Duval's *Artistic Anatomy*, ch. xxiii; Baumeister's *Denkmäler des klassischen Altertums*, s. n. *Alexander der Grosse.*

¹⁴ τῶν ὀμμάτων τὴν διάχυσιν καὶ ὑπότητα, Plut. *de Al. M. seu virt. seu fortuna*, II, 2; Solinus (c. 15) describes him as *latis oculis et illustribus.*

¹⁵ Overbeck, No. 1484.

of Assyrian kings on the bas-reliefs of Nimrūd and Khorsabad. And one may conjecture they were inspired by those carved histories. Like them, they chronicled actual events. How very Assyrian are the bronze hounds, the lion at close quarters with the king, and Krateros, one of his noble attendants¹⁶ coming to his aid, figures of which Plutarch tells! Krateros had dedicated the group at Delphoi.¹⁷ Another group representing Alexander's Hunt, the work of the artist's son Euthykrates, existed at Thespiæ.¹⁸ The Squadron, transported by Metellus Macedonicus from Dion to Rome, contained twenty-five equestrian figures, besides that of Alexander himself [and nine foot soldiers?]. This battle-piece also was reproduced by Euthykrates for the city of Thespiæ, with how much or little fidelity cannot be known.¹⁹ Such compositions are not of necessity iconic, yet Plutarch informs us that, in the Hunt, the noble near to the King (Krateros), the lion and the hounds, were portraits; and that the twenty-five horsemen in the Squadron were individual portraits of those of Alexander's companions that fell in the cavalry charge on the Granikos.²⁰

We have seen that Leochares of Athens was associated with Lysippos of Sikyon in the production of the quasi-Assyrian Royal Lion Hunt. Leochares was the elder of the two sculptors, an adept in various plastic technics and, like the other, a born portraitist. Alexander had sat to both of them in his boyhood. Long before any privilege in regard to the royal portrait could have been granted, the Athenian master executed Philip's commission for the gold and ivory portraits seen by Pausanias (v, 20. 9) in the Philippeion at Olympia. The young crown-prince figured here in a family series, with his father, mother, and grandparents. To the earliest period of Alexander's fame, or the seven years between the battle of Chaironeia and his accession, must be ascribed, in general, such paintings and statues as formed pendants to portraits of Philip, or grouped the son with the father. A picture of Alexander "still a boy," by Antiphilos, hung in the portico of Philip at Rome. The date is thus fixed of a painting of the goddess Athena with Philip and Alexander, by the same

¹⁶ Overbeck, 1485-1491.

¹⁷ Plut. *Alex. M.* 40.

¹⁸ To quote but one example from antiquity, the recovered Hermes with the infant Dionysos, of Praxiteles, was similarly identical in subject with a work of his father, and probably a free copy.

¹⁹ Plin. *H. N.* xxxiv, 66.

²⁰ Plin. *H. N.* xxxiv, 64; Arrian. *Anab.* i, 16. 7; Plut. *Al. M.* 16; Vell. Pat. i, 11. 3; Justinus xi, 6. 13 (corrupt: for *centum XX equites* read *circum*).

artist, which was shown to strangers in the portico of Octavia.²¹ To the same category belong a couple of portrait-statues, Philip and Alexander again, by Chaireas, and Euphranor's bronze chariots, in which each was figured standing, and drawn by four horses.²²

The list of contemporary portraits of Alexander that I have given, is certainly long enough (especially if it be borne in mind that only noted canvasses and statues were recorded by our authorities) to dispel any lingering illusions concerning the effectiveness of the prohibitory decree: yet, even two additional numbers, and these denoting the work of no mean hands, will probably fail to make it quite complete. Nikias, best remembered, in spite of his success in ambitious pictorial composition, as the limner of Praxiteles, was the author of "an excellent Alexander" seen by Pliny (*H. N.* xxxv, 131) in the portico of Pompey. Protogenes, whom Apelles advised to paint the deeds of the great Emathian conqueror, as subjects destined to live forever, probably did not consider the proposition flattering to his talent; he preferred, as a rule, to show the power of his brush in the broader field of genre subjects, but threw off a fanciful group of Alexander and Pan.²³ The sensible charm of such a subject, the underlying thought of which would not be more than a play on words to us, must, I cannot help thinking, have lain mainly in the possibilities it afforded for idyllic treatment, and but subordinately in the opportunity for the display of the artist's consummate skill in technical elaboration.²⁴

ALFRED EMERSON.

[*To be continued.*]

²¹ Plin. *H. N.* xxxv, 114.

²² *Ibid.* xxxiv, 75, 78.

²³ Plin. *H. N.* xxxv, 106.

²⁴ For a different opinion, see Brunn, *Geschichte der griech. Künstler*, II, pp. 239, 240.

NOTES ON CHRISTIAN MOSAICS.

II.

THE PORTICO OF THE LATERAN BASILICA.

[PLATE XIV.]

Of late years, the Roman school of architects, sculptors and painters of the XII, XIII and XIV centuries has been receiving some of the attention it deserves as an important factor in the early revival of the fine arts in Italy; a revival which we, misled by Vasari, have been too prone to attribute entirely to the Tuscan schools. Unfortunately, not many of the works of this Roman school remain in Rome itself: the greater part were swept away by the iconoclastic mania of the Renaissance. But whoever may undertake the rehabilitation of this interesting School will find their works scattered through all the small towns of the Roman States: from the Neapolitan provinces on the South to the borders of Tuscany on the North, including a great part of Umbria. I hope to make known, some day, several of the Umbrian churches built by Roman architects from the XI to the XIII century, as they are among the most noble specimens of Italian Romanesque.

These Roman artists formed themselves into schools, sometimes confined to members of one family, which handed down their artistic traditions through several generations. These artists united, to a remarkable degree, varied talents, and often practised the three arts in their several branches. The best-known of these families is that which is popularly called the "Cosmati," to whom we attribute that beautiful style of mosaic ornamentation which was lavished on pulpits, thrones, tombs, confessions, screens, and other forms of church furniture and architecture. The "Cosmati" worked principally in Rome, but extended their sphere far on either side: to Orvieto on the north, and down to Anagni and the Abruzzi. The school of Paulus, which originated at the close of the XI century, seems to have worked mainly in the provinces; while that of the Vassalletti (XII-XIII) is found both in

and out of Rome.¹ There are many artists whom we have not yet been able to relate to any of these known families.

The artist, one of whose hitherto unknown works will be described in this paper, had the same remarkable versatility that belonged to so many of this School. The work itself has been noticed, though very imperfectly, but its authorship has never been discovered. NICOLÒ DI ANGELO, or NICOLAUS ANGELI, was a noted Roman artist of the latter half of the XII century about whom we know somewhat more than of most of his contemporaries. As an architect, he is known to have built, with Giacomo di Lorenzo of the "Cosmati" school, the confession of San Bartolommeo all' Isola, at Rome, under Alexander III (c. 1180);² an inscription with the date 1170, given by Promis, attributes to him and his son the altar of the cathedral of Sutri;³ and he was employed on the Basilica of San Lorenzo at Rome. As a sculptor, he is known to have executed, with Pietro Vassalletto,⁴ the Paschal candlestick of the Basilica of San Paolo, one of the most remarkable examples of early Italian sculpture. He has been regarded, then, as only architect and sculptor: the present paper will show that he was also a good mosaicist.

In the Middle Ages, the front of the Lateran Basilica had attached to it an open portico, the architrave of which was divided horizontally into three narrow sections: above, a decoration of sculptured heads supported the roof; in the centre, a broader band was adorned with mosaics, in compartments separated by roundels; below, was the famous inscription, DOGMATE PAPALI DATVR AC SIMVL IMPERIALI, QVOD SIM CVNCTARVM MATER, etc., still preserved in the modern façade: on the pier at the southern end of the portico and immediately under the above-mentioned inscription were the words, NICOLAVS ANGELI FECIT HOC OPVS, showing him to be the architect of the portico, and the author of its mosaic decoration. This latter inscription passed unnoticed, and was destroyed with the portico when the façade was rebuilt under Clement XII. The only remaining trace of it is in the engraving of the façade in Ciampini's *De Sacris Aedificiis à Constan-*

¹ Cf. Stevenson's remarks on this family, reported in De Rossi's *Bull. di Arch. Cristiana*, 1880, p. 59.

² A. Ricci, *Storia dell' Architettura in Italia*: Roma, 1848-53, vol. I, pp. 358, 378.

³ *Ibid.* p. 549.

⁴ *Bull. di Arch. Cristiana*, 1880, p. 90. The discovery was made by Sig. Enrico Stevenson.

tino Magno constructis (Romae, 1693, tab. 1). The inscription is given quite plainly, but apparently escaped the observation of all Roman archæologists. The only writer who has noticed it is Mgr. Rohault de Fleury in his monumental work, *Le Latran au Moyen-Age*. But he wrongly considers "Nicolo Angeli" to be a Tuscan of the same family as the biographer of Giacomo Turrilli (!), and to have lived c. 1290 under Nicholas IV. He was evidently ignorant of the existence of a XII century Roman artist. Ciampini, who also asserts the mosaics to have been executed under Nicholas IV, follows Pompeo Ugonio,⁵ who is also Rohault de Fleury's authority. But the attribution of the mosaics to the earlier date is not merely on the faith of the inscription of Nicolaus. Johannes Diaconus, who seems to have lived after the middle of the XII century and who dedicated his work to Alexander III, gives the long inscription of the portico in his monograph on the Lateran. The dispute as to whether this writer may not have flourished toward the middle of the XIII century does not affect this question, as a description of the Lateran, identical with his, is found in manuscripts that evidently belong to the XII century. It is known that under Pope Alexander III (1159-81) the basilica underwent considerable repairs; and it is reasonable to attribute to this period the portico with its mosaic, as this date would accord perfectly with those of Nicolò's other works and with the age of the above-mentioned description of the Lateran.

The miniature mosaics of the Portico seem to have suffered severely from neglect; and when Ciampini wrote, at the close of the XVII century, more than half the compartments had entirely disappeared, and the remainder were in a ruinous condition. Apparently, there were originally more than a dozen subjects, but Ciampini engraved only eight. So far as may be conjectured from these, the series was taken from Roman history, and was especially full in incidents connected with the early history of Christianity in Rome. Ciampini himself

⁵ "Papa Nicola IIII dell' ordine di S. Francesco fece rifare da fondamenti tutta questa facciata, ornandola di musaico, e fabricandovi il portico, che vediamo fondato sopra sei colonne, e vi scrisse quei versi in lode di questa chiesa che vi si veggono. *Dogmate Papali*, etc. Di questa fabrica di Nicola parlano quelle parole, che sono scritte nella Tribuna della Chiesa: *Partem anteriorem, et posteriorem huius sancti templi à fundamentis aedificari, et ornari fecit opere mosaico Nicolaus Papa IIII filius B. Francisci*" (*Hist. delle Stazioni di Roma*, 1588, p. 39). The *partem anteriorem* refers, strictly speaking, to the façade itself, but might be extended to the portico, did we not have the inscription of Nicolaus.

remarks, that these mosaics had not been noticed by any of those who had preceded him in the description of the Basilica. This is not quite correct, as Panvinio, more than a century before him, had referred to them.⁶ After Ciampini, Furietti, in his historical sketch of mosaic painting (1752), also mentions them.⁷

Ciampini says (*De Sacris Aedificiis*, pp. 10-14): "Porticus contignatio sex magnis columnis innititur, tribus puris, totidem striatis, cum capitulis Doricis . . . Peristylum, et corona à Pario marmore sunt. Zophorus verò sat eleganter tessellis compactus, in quasdam areolas, sive lacunas distinguitur, inter quas jacent versicolorum, nec ignobilium marmorum orbiculi crustis conspicui. In iis autem areis, spatiiisque lapillis minutissimis expressae sunt aded parvae, et exiles figurae, ut incognitae penè sint intuentibus . . . At injuriâ temporum factum est, ut quaedam ex illis, vel in totum corrosae deciderint, vel maximâ sui parte mutilae sint, et in dies cadant. Quod ego non leviter dolens, quae satis conspicuae sunt, et aliarum casui superstites, delineare, et hic spectandas, ut in Tab. II. explicandasque apponere, mecum eò satius duxi, quòd à nullo, qui de hac augustissima Basilica scripserit, ne leviter quidem fuerint indicatae."

Ciampini's engravings are rough, small, and evidently inaccurate in detail; they give no clue to even the general style of the mosaics. Comm. de Rossi, however, was so fortunate as to discover, about four years ago, in a volume at the Barberini Library in Rome a series of six colored drawings or rather tracings of the mosaics, made, about fifty years before Ciampini, by order of that patron of art and learning, Cardinal Francesco Barberini, when the mosaics were not quite so dilapidated.⁸ These are not all that were made, and three at least

⁶ "Ante palatium Lateranense (cuius frons aliquando totus opere arcuato aptatus erat, hodie vero arcus omnes muro clausi sunt, praeter arcum portae palatii veteris, quae habet valvas aereas, a Caelestino III factas) est porticus antiqua versus septentrionem locata, ad quam per gradus scalae sanctae aditus est: olim fuit tota, et marmoreis tabulis incrustata, et variis e musivo emblematis ornata, nunc ea diruta, omnia fere vetustate consumpta sunt . . . Porticus ineptis quibusdam picturis exornata est. Supersunt etiam nunc tenuia quaedam vestigia veteris incrustaturae e lapillis tessellatis" (Onuphrii Panvini, *De septem urbis ecclesiis*, etc: Rome, 1570, p. 181).

⁷ "Basilicae Lateranensis frontem a solo aedificatam, adjecta porticu, ac musivariis imaginibus honestavit, ut ex Ugonio in suis Stationibus Urbis hausit Ciampinus; atque haec eadem musiva, prius quam novus ecclesiae prospectus, veteri disjecto, a Clemente XII construeretur, in porticu adhuc extabant," etc. (Furietti, *De Musivis*: Rome, 1752, p. 94).

⁸The discovery of these drawings Comm. de Rossi kindly communicated to me, when

have been lost or mislaid, the first, second, and seventh. They are apparently of the exact size of the mosaics themselves, and measure 58 by 24 centimetres. The small designs of Ciampini differ from them so materially that hardly a single figure is the same: it is evident that these differences in attitude and drapery should in every case be decided in favor of the drawings, as they approach far nearer what must have been the style of the original, and also give all the details that are wanting in Ciampini's summary sketches.

Such a mosaic decoration as this was quite consistent with the general spirit of the Roman art of that period; which, while it showed in its architectural productions a simple massiveness that is truly admirable, had a tendency to decoration in all minor details,—a style which it carried to singular perfection, not only in cloisters and porticos, but in minor works. The mosaic ornamentation commonly employed was however generally decorative, and but few examples can be cited of figured mosaics of this minute description: one is to be found in the mosaics of the old portico of San Lorenzo outside the walls of Rome, which were executed under Honorius III, about 1216. In Ciampini's time two fragments of them still remained, of which he has given some very inferior illustrations: if the least reliance is to be placed on them, they show a complete degradation, and are far inferior to those of the Lateran. Another example, which I believe has never before been noticed, is in the well-known cloisters of the Lateran Basilica, which date from the beginning of the XIII century, and were the work of the Vassalletti, as Comm. de Rossi has proved: that it should have hitherto escaped notice is but another instance of how little apt we are to see familiar objects in detail. On a projection in the centre of one of the sides of the cloister, over one of the exits into the area, the ornamental mosaic frieze on the architrave contains two square compartments in which there still remain vestiges of the figured mosaics placed there by the artist of the XIII century. So dilapidated are they that in one of them no figures can be made out, and in the other, only by the most minute examination can a group of three figures be discerned, the central figure being seated: they may be conjectured to be Christ enthroned, with the Virgin standing on one side and John the Baptist on the other.

I told him of my discovery of the artist, and this enabled me to make a more accurate study of the subject.

To commence a detailed description of our Lateran mosaic: according to the order of Ciampini's engravings, the first subject represented the Roman fleet (of which four vessels are depicted) under Vespasian, on its way to Palestine: under it was inscribed, on a marble frieze, NAVES ROMANI DVICIS HÆ SVNT VESPASIANI. The second scene takes us before Jerusalem besieged by Titus. In the two figures we ought probably to recognize Titus himself, seated, and before him a Roman soldier: the inscription is, REGIA NOBILITAS HIC OBSIDET ISRAELITAS. The colored drawings of both of these subjects are among those that are missing, so that there is no way of correcting Ciampini's rendering of the scenes. Next in order is the presentation by the Emperor Constantine to Pope Silvester of the privileges of the Roman Church, with the legend, REX IN SCRIPTVRA SYLVESTRO DAT SVA JVRA. This is, perhaps, the most interesting composition in the series (PL. XIV, 1). Pope Silvester is represented, in simple red and green robes, and with red nimbus and single tiara, seated on a throne in front of the Lateran Basilica: in front of him, in imperial robes of the Lower Empire, is the Emperor Constantine offering him an unrolled parchment, and accompanied by an attendant. Beyond the fact that Ciampini gives three figures and a building, there is no similarity between his engraving and the drawing. In Ciampini, the building is formless and the tower is omitted: while the colored drawing is evidently a careful reproduction of the original, and therefore an extremely valuable document, as showing the state of the church at the close of the XII century. It reproduces the south side of the Basilica on the square, showing part of the nave adorned with a clerestory of round-headed windows. The portico projects from the body of the church, and we see the end of it surmounted by a gable and serving as a side entrance.* The portico evidently had an architrave instead of an arcade, and was doubtless an example of the classic influence that still so strongly affected the mediæval artists of Rome. What the portico of the Lateran was may be easily conceived by a glance at the still-existing portico of the Cathedral of Civita Castellana, built not many years after (1210) by the Cosmati, Lorenzo and Jacopo. Its architrave and rough Ionic capitals connect it clearly with the basilicas of early Rome, especially that of Santa Maria Maggiore, and might lead one

* This arrangement had been already changed in the earliest designs of the Basilica that exist, anterior to Pope Sixtus V.

to attribute to the Roman school of 1200 an early Renaissance which failed by premature birth; though perhaps it had its origin, not in any classic influence, but in that of early Christian architecture. Over the portico rises a fine campanile of which two stories of large round-headed windows appear above the church. If the design can be relied on, this tower, evidently Romanesque, was far more elegant in form and of larger lights than the usual Roman campanile. Its place is now occupied by a XIV century tower.

The subject of this composition, the presentation to Silvester, by Constantine the Great, of the privileges of the Roman Church, is taken from the well-known legend of the conversion of the first Christian Emperor, a legend that entirely superseded, during the Middle Ages, the historical fact as told by Eusebios and other early writers. As two more of these mosaics are taken from this legend, it may be well to give an outline of it here.¹⁰ It runs thus: toward the beginning of his reign, Constantine persecuted the Christians, and obliged Pope Silvester to seek refuge in the caverns of Mt. Soracte. For this persecution he was afflicted with leprosy, to cure which he sent to Persia and India for magicians. The Emperor was counselled to sacrifice a multitude of children, and to bathe in their blood. In the usually accepted version (*Acts of St. Silvester*), the Emperor, on his way to execute this barbarous project, is moved to pity by the appeals of the mothers of these unfortunates. To reward him SS. Peter and Paul appear to him in a vision, induce him to send for Pope Silvester, to be converted and receive baptism, by which he is completely cured. Constantine then issues his decree in favor of the Christians, and orders a church to be erected in his Lateran palace. This is the point of connection between the legend and the Lateran basilica. This legend began to spread in the East and West early in the fifth century, and ancient documents in Greek, Latin, Syriac and Armenian attest its prevalence. The popularity of the apocryphal *Acts of St. Silvester* established it during the Middle Ages as the authoritative version; and it was only at the Reformation that the historic truth began to be again noticed, and it was finally recognized that Constantine was not baptized until at the point of death, and then by Eusebios of Nikomedeia.

¹⁰ For details, see *L'Omelia di Giacomo di Sarag sul battesimo di Costantino imperatore, pubblicata, tradotta ed annotata da A. L. Frothingham, Jun.*: Roma, 1882 (*R. Accademia dei Lincei*).

The fourth mosaic compartment represented the legendary baptism of Constantine by Silvester, and had under it the verse, REX BAPTIZATVR ET LEPRÆ SORDE LAVATVR. This incident was also, like the presentation of privileges, especially connected with the Lateran, as the baptism was said to have taken place in the famous font of basalt in the Lateran baptistery. In the centre of the mosaic is the Emperor partially immersed in the font; on the right, stand St. Silvester performing the rite, and a deacon bearing a processional cross; on the left, are two clerics wearing that form of the mitre which first came into use in the XII century. Ciampini, deceived by a lacuna in the mosaic, which he turned into rocks, thought he distinguished here St. Silvester on Mt. Soracte (PL. XIV, 2).

The subject of the fifth compartment is the martyrdom of one of the patron saints of the Basilica, John the Baptist. In the centre is the prison with its bars and gable: on the right is the kneeling figure of John the Baptist, the lower part of whose body alone is covered with yellow drapery; the nimbed head lies on the ground. The executioner, who stands with sword raised, is a coarse man of the people in the dress of that period, consisting of a red cap, a green jacket striped with white, a yellow jerkin striped with green, and red tights. He appears a second time, carrying in a vase the head of the Baptist.

In the sixth compartment is another incident in the legend of the conversion of Constantine, which connects it with the third and fourth subjects and suggests a possible error of arrangement by the copyist, though in the incorrect drawings of Ciampini the same order is given. The incident is the victory of Silvester over the great dragon of the Tarpeian rock. According to the legend, this dragon lived in a cave, was adored by magicians, and fed on human victims. Silvester wishing to put an end to its devastations, and inspired by St. Peter, shut the dragon in the cave, closing the entrance with heavy chains. Silvester is represented in the mosaic (in red and white robes) as placing a muzzle on the dragon, a polychromic animal of green, yellow, and red. Behind Silvester is the only person of the whole series that is robed entirely in white: he is holding a long double processional cross, and not a stick as appeared to Ciampini.

The drawing of the seventh subject is missing; and this is especially unfortunate, because Ciampini's drawing of it is extremely defective, and he was not himself able to explain its subject. There is a seated figure before which another stands: it may represent Silvester on Mt.

Soracte receiving the messenger of Constantine inviting him to return to Rome.

The last design in Ciampini, and the eighth of the colored series, represents the tortures inflicted on St. John the Evangelist. The apostle is represented, curiously enough, as quite young, naked and with his hands bound in front. An executioner on either side is tormenting him: the one on the left is raising his hand to strike him, but does not hold a scourge, as in Ciampini. Both these figures are brawny and fairly well drawn, wearing caps and dressed in close-fitting, short garments of red and green: one of them has red leggings trimmed with white. Further to the right St. John is seated, and one of the executioners is cutting off his hair with shears. Here we are able to complete the subject from the colored drawing, as it has preserved part of a figure which probably is that of the proconsul seated in the curule chair.

The last of the drawings gives a mosaic that had entirely perished in Ciampini's time, and which completes the series relating to St. John. The apostle is in the midst of the boiling oil, and extends both hands in prayer towards the figure of Christ appearing on the left. The Saviour is bearded, blesses with his right hand, and has a cruciform nimbus: his type is that of the native Italian school before the prevalence of Byzantine models in the XIII century. The figure is rather thick-set, and the drapery is well arranged in classic folds. The following inscription explains these last three scenes:

MARTYRIS CALICEM BIBIT HIC ATHLETA JOANES
 PRINCIPII VERBUM CERNERE QVI MERVIT
 VERBERAT HVC FVSTE PROCŒSVL FORFICE TŒDET
 QVEM FERVENS OLEVVM LAEDERE NŒ VALVIT
 CONDITVR HIC OLEVVM DOLIVM CRVOR ATQVE CAPILLI
 QVAE CONSECRANTVR LIBERA ROMA TIBI.

This series of small mosaic compositions, placed between roundels of porphyry in the epistyle of the architrave of the porch, was evidently intended to form a complete and connected whole consisting of incidents intimately connected with the origin and associations of the earliest of great Christian basilicas: the Lateran palace; the legends of its patron saints; the story of its founders, the first Christian Emperor and Pope Silvester. It would be useless to conjecture what were the subjects of the compartments that were missing when the drawings were executed under Cardinal Francesco Barberini.

The native school of Roman mosaicists that did not follow Byzantine models, but held to Latin traditions, was evidently not accustomed at this time (end of XII cent.) to execute mosaics of any considerable size. The artists of the apse-mosaic of Santa Maria in Trastevere were probably not Romans; and when, at the beginning of the XIII century, Pope Honorius III wished to adorn the apse of San Paolo, he was obliged to send to Venice for mosaicists. At the same time, the Roman artists were skilled in small mosaic work, both ornamental and figured, and were successful whenever they confined themselves to it. Here they did not follow Byzantine models, and these small mosaics of the portico of the Lateran Basilica are a proof of it. They show a special type which was a national inheritance from the native school, and are of all the greater interest from being the earliest signed works of the school. The figures, as far as can be judged from the tracings, are thick-set; the drapery is ample and flowing in some cases, and in others the exact reproduction of cotemporary costume; there is no hesitation in drawing the nude figure, and in attempting the muscular development;—all characteristics quite in contrast with the ideal of the Italo-Byzantine school.

A. L. FROTHINGHAM, Jr.

*College of New Jersey,
Princeton, N. J.*

NOTES.

LAW CODE OF THE KRETAN GORTYNA.

The stone bearing a fragment of this inscription, first discovered by Thenon in 1857 (see this Journal, vol. I, p. 325), and now preserved in the Louvre, is incorrectly represented in its lateral dimensions by the facsimiles of both Fabricius and Comparetti, who make it of nearly the same width as the complete column below: whereas, it is actually shorter by about three letters on the right. I may add that some remnants of letters at the ends of the lines are obliterated by mortar, which was probably used upon it when it was built into the wall of the mill at Hagioi Dekka. While copying the inscription from this block, during the past summer, I observed at the beginning of the last line at the bottom of the stone, right-hand corner, a portion of a letter still remaining,—a clear, deep, regular cut, sloping up from left to right, nearly an inch long (the letters of this line are larger and more widely spaced than elsewhere on the stone), and forming apparently the left limb of an A whose bar and right limb have been broken away by a fracture that passed along what I take to have been the channel of the bar adjacent to the left limb. No indication of this cut is to be seen on the facsimile of Thenon (*Rev. Arch.*, 1863), or on those that have been published since; but its existence on the stone is unmistakable, as also recognized by M. Reinach who has kindly examined it at my request since I left Paris. The chances of other letters than A are so narrowed by the form, the space, and the necessities of the word to be supplied, that my former conjecture in this Journal (vol. II, p. 34, XI. 15, and p. 43) of ΔEKA (retrograde) seems to me confirmed. This number was then supplied on the general ground that if five staters were given a wife on divorcing her (Column II. 52), double that amount would be reasonable as a "gift of hospitality" to the adopted son if repudiated.

A. C. MERRIAM.

Columbia College, New York.

AN INSCRIPTION FROM KEDREAI.

MM. Diehl and Cousin publish in the May–November No. of the *Bulletin de Correspondance Hellénique*, 1886, p. 424, an inscription of four lines, found in the vicinity of a temple at Kedreai in the Ceramic Gulf. They give the first distich transcribed correctly in cursive text from the majuscule, but leave the other without transcription, remarking: “La lecture du second (distique) est certaine, mais le sens nous échappe.” Transcribe the whole as follows, and the difficulty vanishes:

Ἡ μάλα καὶ ταύταν ὁ Κλειππίδα εἶσατο Νίκων
 εἰκόνα τεῖθε κλυτὸν μνάμα καὶ ὀψηγόνοισ,
 δαρὸν ὄπως θυόεντι θεοῦ γέρας ἄγ' ἐνὶ ναῶ
 ἡμένα ἀγγέλλοι δῶρα θναπολίας.¹

A. C. MERRIAM.

A MS. OF THE MINNESINGER AND A CHRISTIAN CEMETERY.

I. *Codex Manesse*.—The great anniversary of the University of Heidelberg, in April 1886, was the occasion of a photographic reproduction of the famous manuscript of the *Minnesinger* now in the Bibliothèque Nationale at Paris. It is well known that this principal monument of the German poetry of the 14th century belonged to the library of Heidelberg until 1622, when it was carried off among the mss. which to-day form the Palatine collection at the Vatican. The text was published for the first time by Bodmer and Breitinger at Zurich, 1758–59. This edition being very incomplete, F. H. von der Nagen gave a better one in the first two parts of the “*Minnesinger-Sammlung*” (1838). Twelve years after, the same author published, with an historical introduction, a lithographic facsimile of some pages of the text, accompanied by the reproduction of ten illustrations executed by Ch. Mathieu, after having given 33 others in various publications of the years 1842–48.

The efforts of the German Government in 1814 to obtain the return of the famous MS. to its former home having been unsuccessful, the Ministry of Worship and Public Instruction of Baden decided to offer a complete copy of it to the library of Heidelberg. This great work (the MS. contains 856 pages) was executed by a skilled photographer of the Grand-duchy of Baden, sent at the expense of the Government to Paris and placed under

¹ “Know ye that Nikon, Kleidippidas’ son, hath seated this statue
 Here, a memorial famed e’en among men to be born;
 Yea, to the end that, a prize of the god in the odorous temple
 Sitting, it long may proclaim gifts from our sacrifice due.”

the supervision of the Conservateur of Ecclesiastical Monuments in Baden, Prof. F. X. Kraus of Freiburg. At the time of the Jubilee at Heidelberg, Herr Nokk, minister of Public Instruction, was able to offer the only photographic copy taken to the University, whose library now preserves it among its treasures. Though the great expense of this work did not allow of the publication of the entire ms., the Ministry of Baden wishes to place it as much as possible at the disposal of the learned world, by preparing an edition of the 137 illustrated sheets of the Codex. This edition, which is very limited, will be made under the direction of Prof. Kraus, and will be published in a few months at Strassburg by Trübner. The extreme importance of these paintings of the Codex Manesse, for the history of both art and costume in the 14th century, cannot fail to draw attention to this publication, due to the liberality of the Government of Baden.

II. *Early Christian Cemetery of the IV and V century at Trèves.*—The ancient *Augusta Treverorum* is known to Christian epigraphists as the most fruitful soil for inscriptions this side of the Alps. For several centuries, but especially during the last forty years, the immediate neighborhood of the city has yielded a considerable number of Christian epitaphs, belonging, for the greater part, to the period of Valentinian I and Gratian, when Trèves was the residence of the Emperors of the West. These inscriptions are collected in the excellent *corpus* of our distinguished friend M. Edmond le Blant (*Inscriptions Chrétiennes de la Gaule*, Paris, 1865), though many fragments necessarily escaped his attention. Besides, the *tituli* found since 1865 are, naturally, not to be found in the *Thesaurus* of the French archæologist. I hear with pleasure that M. le Blant thinks of giving us a supplement to his great work. I hope also to give the complete series of the inscriptions of Trèves in the first volume of my *Inscriptions Chrétiennes des provinces rhénanes antérieures à l'an 1250*. In the meantime, the public may be pleased to know of the last discoveries which we have made there.

There were in Trèves, in the 4th century, three *Cimeteria* that served as burial-places for the Christians of this capital. They are designated by the names of the basilicas that arose on these sacred sites during the Carolingian and Romanesque periods, and which were, doubtless, the successors of primitive oratories of the Imperial time. These were the churches of St. Maximinus, St. Paulinus and St. Eucharius. The latter basilica, called, since the 11th century, by the name of St. Matthias, is one of the most beautiful creations of the Romanesque style that still remain in the Rhenish provinces. To the north and east of this church there were unearthed, in 1845, tombs of the 4th century, and especially some *hypogea*, a discovery of the greatest interest, which the learned Canon von Wilmowsky has described and illustrated in a memoir published, after his death, by the author of this note, in the publications of the *Société pour les recherches*

utiles a Trèves (1882). The continuation of these excavations was prevented in 1845 by the population, through aversion to what was termed the desecration of tombs, and they were taken up again only forty years after. In 1885 and especially during the summer of this year (1886), the administration of the parish of St. Matthias has uncovered a great part of the ancient cemetery of St. Eucharius. Along the north side of the basilica were found a series of tombs composed of large stone sarcophagi with lids, containing bones more or less recognizable. Some of the sarcophagi had inscriptions either inside or attached to the cover; the greater part somewhat mutilated. I shall, for the present, omit the fragments, and give here only the complete epitaphs newly discovered and still unpublished.

1.

No. 9828 of the 'Provincial-Museum'; white marble:

HIC QVIESCIT INPA
 CE · QVIVIXIT ANVII
 EMEV VIVI NARDVS
 PATER TE LVPERCAMater
 TETOLVMPOSVERunt
 (dove) ✱ (dove)

2.

On white marble: found Feb. 27, 1886; preserved in the presbytery of St. Matthias; the marble was found incrustated in a block of native stone, 1-2' above a sarcophagus:

HIC BENE PAVSANT SCOTTO
 QVI VIXIT ANNOS LXVCOIVX D
 VLCIS · SIMA POSVIT TITVL (sic)
 VM PRO CARITATEM
 SCOTTE PAX TI (sic)
 CVM SIT
 (dove) (dove)

3.

No. 9799 of the 'Provincial-Museum'; white marble:

DAMASIVS NVM ·
 HIC BENE QVI
 ESCET IN P ·

4.

White marble; 0.39 m. high; 0.38 m. long; preserved in the presbytery of St. Matthias:

HIC BENE QVIESCET
 IOVINA QVAE VIXIT
 ANNOS I ET · M · D · V
 VIAT CONIVGI
 (dove) ✕ (dove)
 DVLCISS
 titu LVM

Several other inscriptions of the same cemetery of St. Eucharius have been already published by Herr Hettner, Director of the Provincial Museum of Trèves, in his *Korrespondenzblatt der Westdeutschen Zeitschrift für Geschichte und Kunst*, 1882, I, No. 10.

5.

I add a most interesting inscription that has just been discovered in the crypt of the well-known church of St. Paulinus, recently made famous by the discovery of the sarcophagus of Bishop Paulinus, adorned with most curious works of the 4th century, of which I will speak at another time. During the summer there was found a large marble slab, perhaps the *mensa* of an altar with the inscription :

0.08 m. VR SIO VIVAS IN Deo
 0.26 m.

F. X. KRAUS.

Freiburg im Breisgau.

NOTES ON BIBLICAL ARCHÆOLOGY.

Under this head it is proposed to call attention to some of the most important recent discoveries and discussions, without attempting to give an exhaustive list, and without defining too rigidly the limits of the department.

JERUSALEM.—CONRAD SCHICK has published in the *Zeitschrift des Deutschen Palästina Vereins—ZDPV.*—(VIII, 4, 1885) a theory of the course of the "second wall" of Jerusalem which leaves the Church of the Holy Sepulchre outside. He concludes, from a series of careful observations, partly on the surface and partly subterranean, that a continuous depression extends from beyond the Hospice of St. John on the N. E. to a point well past the Church of the Sepulchre on the S. W. This depression, the line of which so bends as to pass to the east and south of the Church of the Holy Sepulchre, from the abrupt fall and sharp definition of the

sides, he thinks to be artificial. In a few places he finds remains of ancient stone-work to the east and south of this depression, and close to it. He believes the depression to be the old ditch or moat of the city, and sees in the ancient stone-work bordering it the remnant of the second wall. The walls, pillars and gateways found in the "Russian Place" in 1883, he thinks belong to a great fortress adjoining the wall.

Another fragment of the second wall he finds in the layers of large stones discovered near the Jaffa gate, in 1885. The grading (in June, 1885) of the street passing northward by Frutiger's bank (well known to travelers) laid bare a line of stones apparently forming the inside of a city-wall; and excavations preparatory to building on the open ground which bordered this street on the west brought to light a parallel line so fashioned and placed as to indicate that it belonged to the outside of the same wall. Schick considers this wall to have made a sharp turn at a point (the "gate of the corner") N. W. of the "Pool of Hezekiah," so as to pass between this (including it in the city) and the Church of the Sepulchre. The discovered layers of stone, if prolonged southward, would fall just to the west of the Tower of David; whence Schick concludes that the "Gate of Genath" mentioned by Josephus as the south-western starting point of the second wall was not to the east of that Tower, but west of it. His views are illustrated by colored drawings executed with great care and precision. They demand the most respectful consideration, and should give a great impetus to archæological research. The great interest attaching to them concerns the site of the Holy Sepulchre, which may (not must) be genuine, if it can be shown that it lies outside the second wall.—Dr. GUTHE, editor of the *Zeitschrift*, accepts the identification of the second wall without inferring (as Schick now does, against his former opinion) the genuineness of the Holy Sepulchre, although his view differs from Schick's in some minor details.

Dr. SELAH MERRILL (*Pal. Expl. Fund, Quart. Statement*, Jan., 1886), agrees with Schick in identifying the remains opposite Frutiger's bank as part of the second wall, but considers it impossible that it should, in that case, have passed south and east of the Church of the Sepulchre. He does not discuss Schick's argument, however, which, perhaps, he did not have before him. His own view as to the site of Calvary is elaborated in the *Andover Review*, Nov., 1885.

In connection with this subject may be noted the descriptions of newly discovered rock-hewn sepulchres in and about Jerusalem. SCHICK (*ZDPV*. VIII, 3, 1885) described (with plan) some recently found beneath the Coptic monastery, just north-east of the Church of the Sepulchre. He considers them to be unquestionably of Jewish origin, and thus another proof is to his mind afforded of the genuineness of the traditional Holy Sepulchre.

More extensive, but less interesting, are the tombs near the Grotto of Jeremiah, outside the Damascus gate (where Dr. Merrill places Calvary), described by SCHICK (*ZDPV. IX, 1, 1886*), and by MERRILL (*Pal. Expl. Fund, Quart. Statement, Oct., 1885*). Both agree that they are of Christian origin. Plans accompany the descriptions.

The discovery of a second aqueduct at the Pool of Siloam is described by Schick in the April No. of the *Palestine Exploration Fund*; it shows how the lower pool, called the *Birket-el-hamrâ*, received water directly from the "Fountain of the Virgin" at some period which Schick places prior to the completion of the well-known Siloam tunnel. This second aqueduct was found on the road from the Pool of Siloam to the mill in the rock-wall on the left: a hole at this point proved to open into a rock-hewn tunnel crossed by another.

TAHPANHES (Egypt).—Mr. W. FLINDERS PETRIE had secured additional evidence that the "Tahpanhes" of Jeremiah and Ezekiel is Tel-ed-Defenneh, where he excavated last spring (probably also the *Δάφνησι τῆσι Πηλουσίῃσι* of Herodotus II, 30, 107). The great extent of the ruins, and the abundance and variety of objects found, offer a general confirmation of the identity. Tahpanhes was an important city (see particularly *Jer. ii, 16*). Besides this are the following particulars:—1. The daughters of king Zedekiah were among the fugitives from Jerusalem who found refuge in Tahpanhes (*Jer. xliii, 6*), and the chief of the three mounds at Tel-ed-Defenneh was called by Mr. Petrie's Arabs *El Kasr el Bint el Yahudî*—"the Castle of the Daughter of the Judæan." 2. Jeremiah was bidden (*xliii, 9 sq.*) to hide stones (כְּבִישׁ בְּרִיב) "in the mortar, in the brick-work which is at the entrance of Pharaoh's house in Tahpanhes;" and Mr. Petrie found an open-air brick pavement, some 60 by 100 feet in area, "facing the entrance to the later buildings at the east corner" (cited by *London Times* from Petrie's journal, Apr., 1886). This would make Jeremiah's account intelligible. The relation of "the later buildings" mentioned by Petrie to the main "house" does not appear; but neither does it appear that the brick pavement before the entrance to them is necessarily connected with them. So far as is yet shown, nothing was discovered which throws light on the Egyptian form of the name of this city, or its meaning (*London Times, June 18, 1886; Academy, June 26 and Sept. 4, 1886*,—the last article describes objects found).

The Rev. HENRY GEORGE TOMKINS (*Academy, Sept. 11, 1886*) discusses the matter of the name, which he thinks is the same with the name of the queen, *Βασις*, *I Kings xi, 19* (*LXX, Θεκεμίνας*). He proposes for the Egyptian form *Ta-khâ-p-ânkh-s*, and for the meaning "The brightness [or light] of the Pharaoh." The current interpretation has been that of Jablonski (*Opusc., 1804, I, 343*), on the basis of the Coptic:—"Taphe-eneh; id est

caput vel principium seculi. Nos dicemus," he adds, "*initium mundi, vel terrae.*"

DANIEL, V, 25.—CLERMONT-GANNEAU offers (in the *Journal Asiatique*, July-Aug., 1886) new suggestions for the translation of סנא סנא חקל ופרסין (Dan. v, 25), suggested by Aramaic letters on an Assyrian weight in the British Museum. The letters had been read שרפ; Clermont-Ganneau found them to be שרפ [i. e. שרפ for שרפ] = "½," i. e. ½ of the (lesser) mina: the actual weight of the inscribed object corresponded to this. This suggested the reading מנא, *mānā* (mina) for the first of the words above given. חקל might then be חקל = Heb. חקל and פרסין the plural (or dual) of פרס. This would give, with the present division of words, "A mina, a mina, a shekel and (two) half-minas." Since, however, a shekel is only the 60th (or the 100th) part of a mina, he thinks it unlikely that these three weights would be arranged in this order. He seeks a verb in חקל, and prefers to connect the ו before פרסין with חקל, giving חקלו (חקלו or חקלו, "they have weighed," or "weigh ye"). The repetition of סנא at the beginning, he suggests may denote distribution, or difference, and proposes to see in the whole a proverbial expression (e. g., "A mina, a mina, they weighed [weigh ye] two half-minas;"—the author compares "Six of one and half a dozen of the other"), which Daniel interprets by paranomasia, i. e. by giving to the words, for his didactic purpose, a meaning suggested by their form, but not actually possessed by them in their proverbial use. Yet the proverb might have been appropriate to Belshazzar's case. Cl.-Ganneau compares the rabbinical סנא בן סנא,—"*phas*, son of a *mina*," applied to a son inferior to his father, (see *Dan.* v, 22). He does not commit himself to a precise translation of the phrase.

MESHA-STONE.—At last, eighteen years after the discovery of the Mesha-Stone, we have a thoroughly good publication of its (unfortunately mutilated) inscription. Professors SMEND (of Basel) and SOCIN (of Tübingen) have issued it in facsimile, with accompanying transcription, translation and notes (Freiburg i. B., J. C. B. Mohr, 1886). The work is based on a careful study of the extant parts of the stone (in the Louvre), and of two squeezes (one in the Louvre, and the other in Basel). The result has been to determine between eighty and ninety new letters, and to furnish a number of interesting readings.

OLD TESTAMENT CHRONOLOGY.—It does not appear that the Hebrews had much astronomy, but Dr. EDUARD MAHLER, of Vienna, bases a system of chronology on allusions which he finds in the Old Testament to eclipses of the sun. His results are reached through the actual calculation of eclipses which seem to him to correspond with the Biblical statements, and are astonishingly precise. Thus, from *Exod.* x, 21, he reckons that the Israelites started from Egypt on Thursday, March 27, B. C. 1335; from *Josh.* x, 12

sq., that Joshua defeated the Amorites on Friday, January 31, B. C. 1296, at about sixteen minutes past eleven, A. M.; *Isaiah* xxxviii, 8, and *II Kings* xx, 9 *sq.*, he connects with the eclipse of June 17, B. C. 679; while the fall of Nineveh is fixed in B. C. 581, by the aid of *Nah.* i, 8, *Zeph.* i, 15, Herodotus i, 74, and the eclipses of May 28, B. C. 585, and March 16, B. C. 581. Some of these results are in themselves rather surprising, and involve other conclusions equally so: *e. g.*, Samaria falls B. C. 688, and Jerusalem B. C. 557! The author's lines of argument are ingenious, and some of his remarks acute; he is skilful in combining his proofs, and in giving his system such an appearance of concatenation that the unwary may miss the loose joinings. His exegesis, however, is under the influence of his theories, and his treatment of Ptolemy's Canon and the Assyrian chronology is decidedly cool. That part of his book (*Biblische Chronologie*, Wien, 1887) which treats of the Jewish Calendar is of more value, though much less entertaining.

GAULANITIS (Gaulân, Djölân, Dschölân, Jaulan), in the East-Jordan country, is in a fair way to be thoroughly understood. Herr G. SCHUMACHER (whose book, *Across the Jordan*, London, 1886, deals with his journey of exploration in that region) fills a double number of the *ZDPV.* (ix, 1886, Heft 3 and 4) with a description of it, accompanied by maps and profiles; and Dr. FRITZ NOETLING is about to publish in the same journal a treatise on the geology of the district. A preliminary report of his journey there in 1885 has already appeared (*ZDPV.* ix, 2, 1886).

MUMMY OF RAMESES II.—It is sufficient to allude to the unrolling of this mummy, which took place at Cairo, June 1, 1886 (*Academy*, July 3, 1886, —*cf. S. S. Times*, Aug. 14,—and *Revue Arch.*, July–Aug., 1886, with photographs).

SYRIAN STONE LORE.—Captain C. R. CONDER has just published, under the above title, a book which is of interest to students of Biblical Archæology. It was received too late for extended notice in this number of the *JOURNAL.*

FRANCIS BROWN.

Union Theological Seminary, New York.

CORRESPONDENCE.

ARCHÆOLOGICAL CONGRESSES IN FRANCE IN 1886.

During the entire summer, archæological Congresses in France have followed each other in almost continuous succession, and problems of history and of archæology of great interest have been often discussed. The Congress of the *Sociétés Savantes*, held every year at the Sorbonne, during Easter week, under the presidency of the Minister of Public Instruction, opens the series. It is there that the delegates of the provincial societies and the members of the University are gathered together. But, a too extensive multiplication of the sections takes away a part of its interest: archæology has a special section, and still one-half of what might be comprised in it is allowed to escape, being incorporated, partly in the section of Anthropology, partly in the section of the Beaux-Arts, and even in that of Geography, a section newly created to the detriment of the others. The *Journal Officiel*, the *Temps*, the *Bulletin Monumental*, etc., have given detailed reports of the papers presented at the Congress of the Sorbonne, and we will refer the reader to them, confining ourselves to noticing the Gallic discoveries of Lasgrais and of Oye, the communications of M. de Marsy on the crypts of Saint-Martin at Tours, and the very important discussion on the division of the Romanesque schools of architecture, in which took part MM. Anthyme Saint-Paul, abbé Müller, de Lasteyrie and Lefèvre-Pontalis.

From the 8th to the 11th of June, the *Société des Antiquaires de Picardie* convoked at Amiens the historians and the archæologists of the neighboring provinces, to celebrate, by historical sittings, the fiftieth anniversary of its foundation. Three days were devoted to discussions and to an inspection of the city. The last day was employed in making an excursion to Nesles and Ham. We must recall, among the works presented at this congress, a very interesting account of the prehistoric discoveries made at Abbeville by Boucher de Perthes and his successors, presented by M. d'Ault-Dumesnil, the account of the last discoveries made in Picardie, from M. Danicourt, the researches on the engravers of Picardie by MM. Macqueron and Delignières, the discussion on the preservation of objects of art raised by M. le comte de Marsy, etc. In order to heighten the éclat of this reunion, the *Société des Antiquaires de Picardie* organized, in several

halls of the Museum, the construction of which we owe to its efforts, a local retrospective exposition, important on more than one account.

At the end of the same month, the *Société Gay-Lussac* called at Limoges a congress which embraced all the branches of human knowledge: consequently, the discussions could not help being very incomplete, to say the least. But, at the same time, an Exposition was opened in this city, devoted exclusively to works of enamel, unique, from the retrospective point of view, on account of the number and the importance of the pieces of early Limoges work which figured in it.

From the 1st to the 8th of August, Nantes received the *Société française d'Archéologie*, which came to hold its 53rd congress. Last year, on the occasion of the Congress of Montbrison, we spoke (*Am. Journal of Archæology*, vol. 1, pp. 401-4) of the origin and aim of this association, founded by Arcisse de Caumont and directed by M. le comte de Marsy; we will, therefore, refer to it very briefly. The works presented had reference more especially to the history and the archæology of Bretagne. The visit to the Departmental Museum, the excursions to the Roman sites of Mauves, of Petit-Mars and of Cléons, the studies on the crypts of the cathedral of Nantes and the church of Guérande, on the castles of Champto-Ceaux and Clisson, of Nantes and Haute-Goulaine, of Ranrouët and Bretesche, furnished subjects for numerous and interesting discussions in which many French and foreign archæologists took part. MM. de Villefosse, member of the Institute, Maître, F. Chaillou and Dr. Plicque discoursed principally on questions of Roman archæology in connection with the recent discoveries of the theatres of Mauves, of Petit-Mars, and of the *Villa des Cléons*. MM. le comte de l'Estourbeillon, Palustre, de Kersauson, Montfort, and Bougouin gave curious details on the military architecture and on the decoration of the castles of Bretagne. Finally, religious architecture found numerous expounders in MM. de Laurière, L. de Farcy, abbé Gaborit, G. d'Espinay, de Marsy, E. Travers, etc. M. Emile Caron made known to the congress the important discovery of Byzantine paintings and mosaics of the XIII century which was made during the year 1885 in the Mosque Kahrié Djâmi at Constantinople. M. de Laurière gave the first notice of the discovery of an altar in the church of Valcabrière and of that of a Roman tomb in the Roman campagna. An excursion to the ancient city of Château-Oriant ended the congress of the *Société française d'Archéologie*, and the next reunion will take place at Soissons and at Laon in 1887.

The *Association pour l'avancement des Sciences* next held a meeting at Nancy, August 12-16, its 14th congress. This association, which numbers several thousand members, embraces within its scope the entire field of scientific studies, from political economy and geography to the exact sciences, natural history, and medicine. It occupies itself merely incident-

ally with archæology, from a prehistoric point of view and in connection with anthropology. Finally, a society of Belgian artists, the *Gilde de Saint-Thomas et de Saint-Luc de Gand*,—which has for object the study of Christian monuments, and the formation of artists (architects, painters, and sculptors) who should devote themselves exclusively to the reproduction and restoration of works of the Middle Ages,—traversed, from August 21–27, a part of Champagne and of the Ile-de-France. Reims, Laon, Châlons, Soissons, Pierrefonds, and Noyon, were the points visited by the *Gilde de Saint-Thomas*, which, under the direction of its president M. le baron Béthune d'Ydewalle, held each day, after its excursions, a sitting for the discussion of questions of art relating to the study of the monuments visited. A certain number of French archæologists joined themselves to the Belgium members and took part in the labors of the *Gilde*.

In closing, we will mention the *Congrès d'histoire et d'archéologie de Belgique*, founded last year at Anvers by the federation of the learned societies of Belgium (see JOURNAL, I, pp. 487–8) and which held its meeting at Namur, August 17–19. During two days the Congress, divided into three sections, listened to numerous communications, of which the most important was that of MM. de Puydt and Sohest on the existence of the quaternian man in the grotto of the *Biche aux Roches* at Spy, in the province of Liège. A long and interesting discussion arose on the origin and progress of the Frankish populations that peopled Belgium. Namur possesses a very considerable Frankish museum, which is most admirably classified by M. Béquet, and the objects which it contains served as a basis for discussions, notably on the question, not yet elucidated, whether the objects in gold taken from the cemeteries in the provinces of Liège, Namur, and Hainault, are works imported from the East, or were manufactured in the country itself. The question of archæological maps, already raised in France and Portugal, and the proposition for a system of international conventional signs for prehistoric epochs, analogous to that adopted at the Congress of Buda-Pesth, were brought forward. During the coming year, the archæological society of Namur is to come to an understanding with the French archæological society on the presentation of a project which may serve as a basis for international work. Namur is especially rich in gold-work of the Middle Ages. The Sisters of Nôtre-Dame preserve in their convent a considerable number of remarkable works of art, coming principally from the ancient abbey of Oignies, many of which are the work of a monk, Ugo, who in the XIII century excelled in the work of engraving on gold and silver. The Chapter of the cathedral, also, possesses some interesting pieces: a large cross, a portable altar, and a small *retable* ornamented with translucent enamels. The members of the Congress had every facility afforded them to examine these works of art, which form the

most numerous and important collection to be found in Belgium. The Congress terminated by making an excursion to the ruins of the feudal castle of Montaigle and an exploration of the Frankish cemetery near Yvoir, and by a visit to the Benedictine Abbey of Maredsous, a gigantic work undertaken about ten years ago, under the direction of M. le baron Béthune d'Ydewalle, for the purpose of reconstituting an abbey of the XIII century. The work is well advanced and was much admired by all who took part in the Belgian Congress, whose next meeting will take place at Bruges, in 1887.

X.

REVIEWS AND NOTICES OF BOOKS.

KÖNIGLICHE MUSEEN ZU BERLIN. DIE GIPSABGÜSSE ANTIKER BILDWERKE in historischer Folge erklärt. BAUSTEINE zur Geschichte der griechisch-römischen Plastik von CARL FRIEDERICH. Neu bearbeitet von PAUL WOLTERS. 8vo, pp. 850 : Berlin, 1885, Speemann.

The Journal of Archæology offers no apology for reviewing at length such books as are peculiarly adapted to the use of beginners in the study of ancient art. It is one of the cherished aims of the Journal to help increase the sum of accurate knowledge and sound judgment of such matters among those persons who are unable to devote their lives to the study. A great deal of pleasure of a noble kind is to be had from the study of great art, even by those to whom such study can be only an avocation : but for this it is necessary that what they know shall be sound and complete as far as it goes ; and that, in the chaos of diverse opinions and clashing criticisms, they have help to choose the sounder opinions—to follow the more judicious leaders.

Now it is to be observed that this book is adapted for the very *vade mecum* and indispensable companion of those who prefer to approach the study of Greek and Greco-Roman sculpture by the way of the surviving monuments. To those who prefer the *Schriftquellen*, or who seem, with Overbeck, to prefer them, other works may be better suited. But it must be pointed out, here in the outset of our inquiry, what defects there are inseparable from this study of the ancient authorities, and that particularly for beginners. Let it be observed, by anyone who has read books and remembered what he has read, how rare it is that a writer on literature, a literary critic, an essayist, a traveller, an observer of men and things, has any sense of the veritable nature of fine-art. Recall the sayings of your favorite poet or social philosopher : turn to the pages where he has brought in some mention of fine-art, or of one of the fine-arts, or of any single work of fine-art to illustrate his meaning, and see if he has not utterly mistaken the significance of the instance he has cited. It is not necessary to give names and offend either the owners or the worshippers thereof ; every reader of this who has at all the esoteric sense in matters of fine-art will have observed how rare is any appearance of such an intimate acquaintance with

it in the works of the great literary masters. The fact is that a strong feeling for art, an intimate knowledge of it, and a warm and somewhat exclusive and partisan love of it are, all and several, the possession of a certain body of men who are not much heard from publicly, except in their works of art, and who have rarely any power of verbal expression. The scholar, the poet, the historian, the literary critic and annalist, the traveller observant of men and manners and national characteristics are, by their very nature and by the nature of their pursuits, debarred from an intimate sense of the true value of fine-art, as it is felt by those who live for it. The student of mental phenomena must needs include the art-sense in his analysis, but its true nature evades him. The traveller in cities which are rich in old art must needs pass upon the canvasses and the half-ruined walls he has heard of as precious, and he misses all that is most important in them and dwells upon accidents: the poet fills out his verse with the names of Rafael and Titian, and lugs in his raptures over an antique statue restored out of all recognition, or a seventeenth century painting of the well-established *decadenza*, all "to point a moral or adorn a tale:" but his words show plainly how far he has been from a real feeling of such pleasure as can be got from fine-art when looked at with eyes which have the art-sense behind them. Philosophical thinkers mistake the habit of analyzing and describing that art-sense for the possession of it, and the *Wissenschaft des Schönen*, or Science of the Beautiful, for the knowledge of beauty. But neither poet nor philosopher knows anything of the delight that a great work of art can give. That is given only to the humble and patient student of art, single and alone. There are exceptions? Yes! So rare that one keeps a little list of them! There are books of travel and there are histories in which it is seen that the writer felt something in works of art, and enjoyed them for what they have that is best: there are even essays (though here the pen stops and hesitates to write it: but—yes, there *are* essays) upon literary and social and intellectual topics in which there is combined with a sense of literary value a partly corresponding sense of what is true and permanent in works of art.

Such exceptions there may have been among the ancients: but what evidence is there that it is their writings which have come down to us? Is it Pliny in his Natural History? Pliny the busy inquirer indeed and indefatigable, but assuredly not a critical spirit. Is it Pausanias? But, if there is anything that is vexatious, it is Pausanias' way of leaving important things half-described, of telling us what gods were on the Olympian base "in gold-work," but in such vague terms that no two modern writers can agree as to the elementary facts of the case. Well, perhaps there is one thing more vexatious still, it is his way of leaving important things not described at all and even unmentioned; as when he tells us of the Parthenon and does

not even allude to the frieze of the Cella. Is it Quintilian?—but indeed it is useless to pursue the inquiry name by name. Nothing is clearer than that those Greek and Roman writers in whose works we find mention of the fine-arts of their own or of previous epochs were themselves as far from being especially interested in fine-art, and as far from being conversant with fine-art in any peculiar and intimate way, as our moderns. In fact, they were in so far worse off that there is no evidence of any archæological or technical curiosity behind them to induce them to accuracy. Nowadays a writer is surrounded by books of reference out of which a certain outside, chapter-and-verse knowledge is to be gotten, and he must write in fear of blundering in the presence of those who are well-informed and watchful. We have no reason to suppose that any such *milieu*, as Mr. Taine has it, existed either in the first or the second century of our era, when lived and wrote the only ancient authors whose works afford us any sustained account of ancient art. It is quite certain that in the days when the greatest works of art were produced, in pre-Roman Greece, no such conditions could have prevailed. Nothing is plainer than that the noble contempt for the pursuit of fine-art as of a rather degrading mechanical employment which was common enough in Clive Newcome's time and (*teste* Mr. Hamerton) is vigorous still, was the normal state of things under the Julian and under the Flavian emperors. The ardent inquiry into the history and nature of the fine-arts, which is so marked a feature of our own time, is of very recent origin. It is not probable that any one suggested to Pausanias that he ought to be closer in his descriptions. Probably all we have lost of the writings of antiquity upon the fine-arts, is a certain number of technical treatises written by practitioners for practitioners, and giving maxims and rules for effective ways of work and safe vehicles and labor-saving processes.

The works of ancient writers, therefore, can be of but little use to beginners in the study of ancient art. No opinion is expressed here as to the use made of those ancient writers by the modern professed investigators: we are concerned only with the best way for those who are not as yet familiar with classical sculpture and its correlated arts to undertake their study. And yet not the mere beginners only; our assertion here goes so far as this: that, until one sets himself seriously to put into shape a continued and connected history of the development of ancient art, he need not question the ancient writers at all,—except now and then as a fancied association strikes him, or when he is curious to know whether this or that piece found at Olympia be actually what Pausanias mentions as being there in his time.

The business of an inquirer into Greek and Greco-Roman art is to see all the specimens of it he can, in their original state; to see all the repro-

ductions he can of all those which are out of his reach, and also the reproductions of the originals he has seen (good reasons for which, anon); to read what is said about them, by way of exposition of their obvious or probable meaning and origin, by modern writers,—searching well the periodicals, the *Gazettes* and *Zeitungs* and *Journals* in many tongues; and to make or have made or appropriate in some way a gradually perfected general schedule of all he knows and of all he is curious about. And here, as if made to fit this final requirement, comes the book of Herr Friederichs revised by Herr Wolters, nominally a catalogue of the Berlin collection of casts from classic sculpture, but really a nearly complete list and analytic catalogue, with critical and historical notes, of the important pieces of that sculpture which exist above ground. The Berlin collection is much the largest in Europe: that at Dresden coming next; those at Vienna, Cambridge, Munich, London, and (probably) Bonn coming next; and all the rest being of no account: but indeed the Berlin collection is the only one that approaches completeness. A somewhat careful computation made four years ago resulted in the conviction that a knowledge of two thousand chosen specimens of ancient sculpture would be a knowledge of the whole subject, as accessible to us at that time. The Berlin collection reaches 2,271 numbers in this catalogue, but some of these numbers refer to inscriptions, and some cover each a number of separate slabs of a frieze, or the like: it can only be said that very few of the important pieces of ancient sculpture are missing. The worst of this wonderful museum of ancient sculpture is its crowded state. Many is the statue and relief of prime importance from which one cannot get far enough to see it *all together*, as it was meant to be seen; many the one that cannot be seen except from a single point of view; many the one that has become a telescopic object, high on the wall of a huge gallery. But there they all are; and with patience, a couple of opera-glasses of different powers, a lot of photographs, an occasional run to Dresden to see some cast in a better light, and frequent visits to the original Pergamon antiquities in another building, one may feel that he is getting on in his study of classical sculpture.

It has been said above, that the student should see reproductions of the originals he knows, as well as of those he has not seen: that is because he will not be able, otherwise, to rightly estimate a piece of sculpture by means of its reproduction. If he has often compared a statue with its cast, and both with the photograph, he will know how much cast and photograph alike give him of the statue he has not seen. Moreover, one is not always in the Museum! And, unfortunately, the American at home is never in the museum where original masterpieces are, never, even, in the room where casts of them are: for how many casts of classic sculpture are there in all the land? The American student then needs photographs; and he

needs this book as the catalogue to his so-made museum in portfolios. He will number each print with the Friederichs-Wolters number; he will add thereto memoranda of his own observations, and notes culled from different writers; he will devise a system of cross-references in the pages under consideration, and will re-index the book (which badly needs better indexing): thus his history of Greek sculpture will gradually take shape: the only true history of the modern school,—the history built up of analysis and comparison of things that exist, with little help from half-understood sayings of men who themselves only half-understood.

Professor D. Cady Eaton adapted into English the former edition of Friederich's *Bausteine*, the groundwork of the present larger book: if somebody will translate this latter into English, adding to the text what it lacks, and providing a thorough index, he will have done the best single thing that can be done for the study of classical art. And so, to consider what this book lacks:—

First and chiefest, it lacks a full and complete account of all restorations, all added parts. It is the strangest, the most unaccountable thing, that this great Berlin collection should be chiefly made up of restored, that is, disguised and altered, works of art. Why are the modern legs of this and the modern head of that brought to Berlin, in plaster, and set up as if authentic? Why?—well, perhaps there is a reason: perhaps it is wrong to say "unaccountable," perhaps the uncritical directors of museums elsewhere would not be best pleased to see the "ornaments of their galleries" stripped of the limbs that long use and wont have made to seem their own. But assuredly it is time that these borrowed members were cut off again. The true doctrine is that no addition whatever shall be made to a piece of sculpture: set it up as it is: set beside it as many restorations and completions in plaster or in costlier material as there are theories of restoration. The Aphrodite of Melos shall be given with a shield; with an apple in her left hand and holding her drapery with her right; adjusting or removing the baldric of Ares; and in any other position, action, and grouping that may seem reasonably probable: but to the marble nothing shall be added. And in the east-collection the unfortunate statue which in the marble has been restored out of recognition by the sculptor who modelled it shall be treated as the more fortunate Aphrodite above mentioned: its modern accretions shall be taken away, and it shall be left as time and chance, and destroyers less cruel than restorers, have left it to us. Now, in some museum-catalogues full justice in this respect is done the sculptures, and every scrap and fragment that has been added is separately pointed out: Brunn's catalogue of the Munich Glyptothek is the model in this respect. In other museums every such addition to the original is enumerated in a placard or label attached to the work

of art or to its pedestal. But the plaster-cast collection—more free, more abstract, unconcerned except with the interests of study and the needs of students—can have these unauthorized parts removed. It is of no consequence at all if the traveller fails to recognize his favorite statue when he sees it without arms or with only one leg, as the ancient statue really is: but it is of supreme importance that the student should not be impressed with a suppositious composition. And so it is an omission in this excellent book that the parts added in modern times are not always enumerated. Usually, the principal ones are mentioned; but that is not enough.

Secondly, we miss the dimensions: these are never hinted at; and these, important to a visitor to the gallery, are indispensable to the student at home.

Thirdly, we miss a separate treatment of the important parts of a series. The separate slabs of the Parthenon frieze, numbered by Michaelis, and so figured in his work that they can be distinguished and designated in writing, might have been so distinguished here, without prejudice to the general treatise (pages 267–279) upon the frieze as a single work of art. The importance of this is plain, when we consider the immense extent of the work, three hundred and fifty feet of crowded bas-relief. If there is an accepted and easy method of referring to this and that detail of it—to the youths bearing wine-jars, or the careering horsemen, or the stately seated gods of the East-front—certainly a book like this ought to use it, for the help of all who study it.

Fourthly, a good and legible page-title changing with the contents, or, better still, a system of marginal indexing. The total lack of these is a constant cause of loss of time and of failure to get the whole sense, when people are pressed.

Fifthly, some mention (as in an appendix, or in prefatory notices of the different schools) of important works which, for certain reasons, are not in the collection. Thus, the bronze "Praying Boy" of the Berlin Museum, and the Pergamene frieze are excluded, because the originals are in Berlin: but also the "Idolino" of Florence seems not to be there, nor are the two Satyrs of the Naples Museum. We wish (though clearly we have no right to call its non-existence a fault) that the relation of these statues to other sculptures might be pointed out.

And finally, the index must be exhaustive, giving places where things have been found, places where they are kept, and names of all the different sorts. Time was that all nude male statues were Apollos; Hermes was the favorite at a later period; and the name Antinoüs has been given freely to many a statue which had been finished a few centuries before the day of that puzzling subject of enquiry: it is necessary to refer to each work of art by all these names, however absurd. Full reference to places would, however, make the finding of what one seeks possible, if slow. To

make such an index will take three weeks of somebody's time, but it will double the value of the book.

And now our complaints and demands are recorded, and it remains only to say how good a book it is: how sound and sensible the criticisms, how useful the historical *résumés*, how full the references to books treating of the different sculptures, and to photographs and prints representing them. There is no book in all the library more needed by the student of classic sculpture: and what classic sculpture is, what part it plays, in the world of classic life and thought, it is fortunately no longer necessary to say.

RUSSELL STURGIS.

New York City.

THE ANCIENT COPTIC CHURCHES OF EGYPT by ALFRED J. BUTLER, M. A., F. S. A., Fellow of Brasenose College, Oxford. In two volumes, 8vo: I, pp. xx-377; II, pp. 409. Oxford, 1884, Clarendon Press.

Though issued in 1884, the importance of the book before us is so capital that an introduction of it to American readers is quite warranted, even at this late day. It is a pioneer book; the first yet written on "a great subject—the Christian antiquities of Egypt." Many were the difficulties to be overcome: a strange language; ignorance and indifference in the natives; an entire absence of monumental or documentary evidence,—these are but a part of the obstacles encountered by Mr. Butler in his voyage of discovery. Early Western Christianity is our natural inheritance, and we know it well. The Greek Church—its art and ecclesiastical antiquities—has been comparatively accessible and a subject of study for many generations. The Christian development in Syria and in Asia Minor has been a later stage in our scientific pilgrimage: only in late years have we become acquainted with the grand but ruined cities of Syria, deserted since the Mohammedan invasion in the seventh century; and with the relics of the earliest Christian settlement in the land where St. Paul first spread the light of the Gospel. The circle was then complete, with one notable exception: Christian Egypt was still a *terra incognita*. To any one familiar with Church history it seems very strange that what was once the most fanatically Christian of all converted lands, the centre of early Christian learning, the originator of monasticism, the home of Clement and Origen, of Cyrill and Athanasius and Arius, should not have been long ago diligently investigated by the historian and the archæologist.

Asia Minor, Syria and a great part of the ancient domain of the Greek Church have been almost entirely converted to Mohammedanism, but the

Copts of Egypt still retain the faith, customs and ritual of their ancestors, and still worship in the churches and dwell in the monasteries founded under Constantine the Great and his successors. This is what Mr. Butler has undertaken to set before us in these two volumes, as "the result of seven months' research in Egypt." We must thank him for undertaking so laborious a task though he shrank from it, feeling "the lack of special training"—a lack which, though sometimes apparent, is counterbalanced by faithful and thorough work.

The first volume is entirely devoted to monumental antiquities: to a minute description of the early churches in Old and New Cairo and in the monasteries of the Natrun Valley and of Upper Egypt. Chapter I is "On the structure of Coptic Churches in general," preceded by some remarks on the origin of the Christian basilica, which will be noticed later. Though most of the churches of Egypt, the author says, "may be roughly termed basilican, it remains to notice a subordinate though powerful influence of another kind, which, for want of a better name, must be called Byzantine." The main effect of this influence is the dome, which is found in all Coptic churches; but "there is not a single specimen of purely Byzantine architecture," and no example of a cruciform ground-plan. "It would be less difficult, though not easy, to find an instance of a purely basilican church." The influence of the Latin (or basilican) style is found especially in the wooden architraves which are used to separate the nave from the aisles. The necessity for strengthening this weak architrave, to resist the pressure of the main wall above, led to the development of an architectural feature peculiar to Egypt—the relieving arch, placed above the architrave between every column. These arches were originally a part of the solid wall, and in this stage we find them used in the Latin basilicas of the West, where they were probably a Roman inheritance. But later, to secure superior lightness of structure, these arches were made free, the architrave was made of wood, and in this stage they were adopted by the Mohammedan invaders. There are also some interesting peculiarities in the construction and grouping of the domes: many churches had but one large dome over the sanctuary, with smaller ones, perhaps, over the side-apses; a second large class had many domes, sometimes twelve. In one case (Dair-as-Sûriâni) the central dome is supported on the two sides by a semi-dome, reminding one of Santa Sophia at Constantinople, while in another (Bûsh) there are four semi-domes. But it would be impossible in these few lines to detail the characteristics of these unique Coptic churches built between the sixth and the tenth centuries. Mr. Butler takes us through the narrow lanes of Cairo, past the mazes of picturesque groups of buildings in whose midst the old churches lie enshrouded and unnoticed. Nothing attracts the antiquarian or the spoiler in their shapeless exterior, which, when not entirely hidden,

shows but a plain uninterrupted wall, unbroken by windows, unmarked by towers, where even the summits of the domes are embedded in the square mass. Entering at the west end, through the narthex, the contrast of the deep gloom with the bright sunlight without is startling. The dim light shows a most picturesque interior. There are no broad sweeps of architectural lines as in our western cathedrals, no beautiful sculptured details, no grace and symmetry of lines: the screens separating the rear, where the females of the congregation are placed, from the front reserved for the males; the second screen dividing the latter from the choir, and the third the choir from the chancel: all this divides the interior into many sections. It is only on looking up at the gallery placed above the colonnade of the nave that the eye can follow a continuous line of vision. But the charm of the Coptic church lies in the beauty and exquisite finish of its interior details,—the carving and inlaid work of its high screens, in ivory, cedar and ebony; the mosaics, in marbles and mother-of-pearl, of the sanctuary and the ambon; the frescos on the walls, and the rows of small panel paintings in which the Coptic artist excelled. I cannot do better than quote the description of one of these unique screens: "The choir-screen is worth a journey to Egypt to see. It is a massive partition of ebony, divided into three large panels [six ft. by eight]—doorway and two side panels—which are framed in masonry. . . In the centre [of each] a double door, opening choirwards, is covered with elaborate mouldings, enclosing ivory crosses carved in high relief. All round the framing of the doors tablets of solid ivory chased with arabesques are inset, and the topmost part of each panel is marked off for an even richer display of chased tablets and crosses. Each of the side-panels of the screen is one mass of superbly cut crosses of ivory, inlaid in even lines, so as to form a kind of broken trellis-work in the ebony background. The spaces between the crosses are filled with little squares, pentagons, hexagons, and other figures of ivory, variously designed, and chiselled with exquisite skill. . . It is difficult to give any idea of the extraordinary richness and delicacy of the details or the splendor of the whole effect. The priest told me that this screen was 953 years old, *i. e.* dates from 927 A. D., which seems to be the year of the church's foundation" (church of *Dair-s-Sifain*, I, 86-87).

Most picturesque of all is the group of churches inclosed within the ancient Roman fortress of Babylon, to which the author devoted a great amount of study, in tracing the walls and examining their fine circular towers. On the summit of one old tower stands the church of St. George. Perched between two of the old Roman bastions, high up in the air, on a platform planted with palm-trees and aloes, is the suspended church called *El Mo'allagah*, the earliest and most interesting of the Christian buildings of Cairo, and the nearest approach to the type of the basilica. Would not

an examination of the ground-plan lead to the conjecture that the three pointed arches, separating what he terms the "nave" and the north aisle, were a later addition?

In the latter part of the first volume Mr. Butler takes us to the monasteries of the Libyan desert, in the Natrun Valley, which go back to early Christian times, when the whole of Egypt was peopled with monastic institutions. Here only four remain: the rest, either have been swallowed up in the sands, or still show, by shattered ruins, the sites they once occupied. From those that are still standing came the precious series of Syriac manuscripts which compose the collections of the Vatican and the British Museum. Mr. Butler says of one, Dair Macarius (and all are built on the same model), "The monastery is a veritable fortress, standing about one hundred and fifty yards square with blind lofty walls rising sheer out of the sand:" there is "a large keep or tower, standing four-square, and approached only by a drawbridge. The tower contains the library, store-rooms," etc. The walls "enclose one principal and one or two smaller court-yards, around which stand the cells of the monks, domestic buildings . . . and the churches." Among the many ways in which these monastic churches differ from those of Cairo are the use of pointed arches and piers, instead of the flat architrave and columns, to separate the nave from the aisles, and the use of the pointed-arched tunnel-vaulting for the nave and aisles. The domes are larger, and the churches better lighted and of greater size.

The last chapters are devoted to "The churches of Upper Egypt," a group "still almost absolutely unexplored," and which Mr. Butler, not being able to visit in person, describes briefly from the scanty notes of other travellers. This is the more unfortunate, that the churches of the White and Red Monasteries, and many others, date evidently from the period before and during the reign of Constantine, and are magnificent examples of the architecture of the fourth century. Others, like those of Nagâdah, are probably the best specimens of Byzantine architecture in Egypt.

The second volume deals exclusively with ecclesiastical archæology and liturgy; with all details of church furniture and ornaments, of ecclesiastical vestments, of language and literature, of the sacraments and other rites and ceremonies. At the end, a collection of lives of the Saints is translated, thus helping the reader to understand many of the subjects of the paintings that fill the churches. Of the frescos we read that not one "has a date clearly fixed by an inscription or other evidence: yet several of them cannot be later than the eighth century, and some original frescos remain from the day of Constantine" (II, p. 85). That these are often remarkable works, we gather from the writer's remarks on those in the

church of one of the Natrun monasteries (Anba Bishôï): "they are clear and strong in design, true in drawing, rich and mellow in tone, and, in a word, worthy of the church which they adorn, and of comparison with any like work in Europe" (I, p. 323). Mr. Butler found the paintings, even those of a late period, quite free from the hieratic stiffness and the uniformity of composition and design which invaded Byzantine art. The chapters on church furniture include the description of many works which show that the Copts preserved artistic taste and skill in all branches of art up to a very late date—perhaps to the fifteenth century. The study of Coptic liturgy leads to interesting comparisons with other Oriental liturgies, and especially with that of the Church of England, by contrast with which Mr. Butler wishes to emphasize the great deviations from primitive liturgical forms that have crept into the Episcopal Church. The forms of ecclesiastical vestments and the changes in them are investigated, and the truth disengaged with considerable felicity from a mass of conflicting testimony. But on this part we need not dwell in detail, as it is rather outside our province.

From the preceding summary the value of the work accomplished by Mr. Butler is evident: but only one who has read his book can realize how opportune it is, in view of the invasion of the mania for restoration and novelty which always accompanies, in the East, a European occupation. Very soon the old frescos will be whitewashed, the sculptured screens of ebony and ivory thrown into a corner, while brand-new glass lamps will take the place of the mediæval Venetian glass or chased metal burners. Mr. Butler's minute description of even the smallest panel painting will then become a valuable document. It is deeply to be regretted that no views of any of the interiors of churches are given, for word-painting at the best is very insufficient in matters of art, and a ground-plan, though useful, has no style. It is to be hoped that photographs may soon be obtained wherever the light makes it possible—as in the churches of the Natrun monasteries.

A few criticisms may not be out of place, especially as a new edition is to be hoped for, in which some of the interesting monuments of Upper Egypt may receive a more adequate description. There is a feeling that, throughout the book, the antiquity of everything—churches, paintings, carvings, embroideries, inlaid-work—is over-estimated, without any reasons being given for such opinions. This leads the writer, for example, to make the untenable suggestion of the Egyptian origin of the Byzantine dome, though he does not bring forward any example in Egypt anterior to the domes of Central Syria (512-14), much less to those in the early Christian buildings of Asia Minor: the connection between the early Christian dome and anterior processes, if it exists, would seem to be with the Sassanid domes

of Persian palaces. The earliest domes of Coptic churches appear to be considerably later than Santa Sophia in Constantinople, while the many-domed churches of Egypt must belong to an even more advanced period.

Very hazardous are the writer's remarks on the origin of the Christian basilica: it cannot but be evident that his acquaintance with the latest literature on the subject is insufficient. He even seems to partly misunderstand Mr. Gilbert Scott, his main authority, confusing the latter's two types of early churches, the oratory and the basilica. He fails to notice the view, now most generally accepted, that the connection is not between the Christian basilica and the public Roman basilica, but between it and the private basilica of the Greco-Roman house; also the important elements from the Judeo-Greek Synagogue and the primitive Chapels of the Catacombs. A longer study of Early Christian architecture in its various phases would have made Mr. Butler's work more useful to the art-historian. To give an instance: the questions of the construction and supports of the dome, and of the use of the pointed arch are not even referred to; yet the former would probably settle the age and relative position of the Coptic dome, and the latter might decide one of the most burning architectural questions of the day, the origin of the pointed arch. We have long heard rumors of its use in early Egyptian churches, and it seemed probable that the great pointed arches of the Mosque of Ibn Tulûn (ix cent.), hitherto regarded as one of the earliest examples, were merely the work of Coptic artists who followed, in this instance, a long-established tradition. With this in mind, it is somewhat unsatisfactory to find that, in his description of Cairene architecture, the writer often refers to an arch without mentioning its form, and, in speaking of pointed relieving arches over architraves, adds no word to indicate whether or not they seem part of the original construction. In discussing the question of the relative age of single and triple apses in early churches, Mr. Butler fails to recognize the relation of the two early closed chambers of the III and IV centuries, one on either side of the church, with the late open side-apses into which they passed by a process of transition which, though not uniform, can be followed in buildings of both the East and the West. The account (I, p. 21) of the different position of men and women in churches, is not as clear as if the distinct difference between the Eastern and Western churches had been recognized: that the Western basilica as a rule has no gallery, but that the men were placed in the right aisle and the women in the left, curtains being drawn so as to separate the sexes completely; and that the use of the gallery for the women was an Eastern custom, and had considerable influence on the architectural form of the church.

The mosaics of small marble cubes which adorn the lower part of the niche in the sanctuaries of many Coptic churches are rightly admired by

Mr. Butler, but, in wishing to explain why the Coptic artists used only geometric designs, he falls into a singular error: he thinks the reason to be that they knew that the heavy marble cubes were not adapted to the reproduction of the human figure, whereas in the figured Byzantine mosaics the artificial cubes were so adapted. In the history of mosaic-painting it is clear, on the contrary, that at first marble cubes were used, even in elaborate wall-mosaics filled with figures, sometimes quite minute, as at Santa Pudentiana and Santa Costanza in Rome, and at S. Aquilino in Milan (iv and v centuries). Only when the supply of these imported colored marbles was well-nigh exhausted, through the growing popularity of mosaic-painting, were the cubes of glass and composition brought into exclusive use. As an instance of what would seem to be far too early an attribution, I may cite the wood-carvings of Abu Sardjah (I, p. 191) which he dates from the VIII century, while the illustration given of them would point to a period four or five hundred years later. In comparing the subjects figured in Coptic art (II, pp. 91-2) with those of the West and the Byzantine Empire, two errors should be noted. First, he remarks that the subject of the Good Shepherd and the Christian symbols of the fish, the anchor, etc., are not to be found. Of course not: they were used mainly in the Catacombs, and had ceased to be represented in any part of the Christian world before the first known works of Coptic art were produced. Mr. Butler is also unjust to Byzantine art. In remarking on the variety to be found in Coptic paintings, he says: "Coptic art seems never to have been tied and bound by rigid laws of tradition in the same manner as the art of the Greek Church. There is no analogy in Cairo to the experience of Didron, who fifty years ago saw the monks of Mount Athos reproducing by rule of thumb the designs and colours of the fourth or fifth century." If the writer had remembered that the *Guide de la Peinture* used by these monks belonged to the *fifteenth* century, he would not have committed an anachronism of some thousand years. But, seriously, any one familiar with Byzantine art knows what a precious Christian-classic inheritance it preserved for many centuries, and what works of beauty it produced in the time of Justinian and even under Basil the Macedonian (ix cent.), when the classic revival in Eastern art took place.

It is to be hoped that, in preparing a second edition, the writer will avail himself of the services of some Orientalist, in order that his book may profit by the additions which this would render possible. There is one class of documents in particular which ought to be consulted: I mean the Syriac manuscripts. The great proportion, as is well known, come from the monasteries of the Natrun Valley, and contain precious indications for both history and liturgy. In the Syrian historians, John of Asia, Zacharias Rhetor, and Dionysios of Tellmahré, there is a great store of informa-

tion regarding the ecclesiastical history of Egypt. The relations between Syria and Egypt would be a most interesting theme: we know that Pantænus, the master of Clement at Alexandria, was a Syrian, probably from Edessa, and this is but an instance of the intimate connection between the two, of which a later one is the persistence of these colonies of Syrian monks in the Natrun desert for many centuries after the conquest, and almost to modern times. It is very probable that the late find of Fayûm Papyri, now in Vienna, in which is included a series of documents extending over the entire Roman, Byzantine, and early Arabian periods, up to the tenth century, when the library was buried, will throw a flood of light on that most obscure period of the history of Egypt. It is useless to add that an examination of Arabian writers is indispensable, especially the numerous historians of Egyptian affairs. It would be very useful if, in the chapter on legends, notes were added, referring to the Ethiopic, Syriac and Arabic versions of the same, and especially to the Greek or Latin originals of the "Acts of martyrs" which appear in so debased a form in Coptic documents. Finally, does it not seem as if undue prominence were given to the liturgy of the Anglican Church? In a work which does not profess to be polemical, these digressions seem out of keeping.

There are some errors in Arabic words, of which examples taken at random are given in a note:¹ the missprints are very few, but there are other errors the character of which is doubtful; these and others will also be relegated to the notes.²

¹ Mr. Butler's transliteration of Arabic words is sometimes incorrect: e. g. his Abu Sargah (I, 181, *passim*) with a hard *g* should be Abu Sardjah; the soft letter *dal* or *dhal*, as in *El-Adhra* (I, 272, *passim*), he transliterates by a hard *d* which properly represents the letter *dad*. An error of another kind occurs in the frequently mentioned name of the Roman fortress of Babylon, which he transliterates "Kasr-ash-Shamm'ah" with an impossible doubling of the *m*. The derivation of a number of technical terms is sometimes omitted, sometimes incorrect. In II, p. 117, the Arabic word for amice *tailasdn* should have been compared with the Persian original, to which the Syriac word *fishang* (*cf. talashma*) approaches even more nearly. An amusing blunder occurs in I, 146, in quoting three lines of an Arabic inscription in which occurs the word "*naiah*" (imperative of *nâha*) with the meaning "give rest" (to their souls). Though the idea of rest was connected with that of decease through all the Christian world and in every language, Mr. Butler thinks it a proof that the church was built by a patriarch! II, 190, *estla* = *στολή*, "*stola*": *shoshippa* and Denzinger's *sciusecfo*, are the same word, a fact which Butler does not seem to recognize; it is a good Syriac word used several times in the Syriac Bible. II, 127: the derivation of *batrashil* from the Greek *ἐπιτραχήλιον* is questionable, though that from *πετροσέλινον* (Dozy, *Suppl. aux dict. Arabes*), however enticing philologically speaking, is unlikely.

² Vol. II, p. 124 for *zinndr* read *zunndr*; p. 323 for *az-zabdjah* read *az-zaudjah* (matrimony); p. 378 for *Mortomariam* read *Maratmiriam* (as name of the Virgin); for

For a work which covers so much unexplored ground, the blemishes are of small consequence, and the good qualities far more noticeable. If we have given a different impression it has not been our intention. *Ancient Coptic Churches of Egypt* cannot fail to remain the standard, even if, as we hope, it be followed by many other works in the same field. Mr. Butler has shown the way, and all can now see what should be done as the next step. To use his own words: "Enough has been said . . . to show what work must yet be done in order to give the world anything like a complete account of the Christian antiquities of Egypt. Remains so vast in extent, so venerable in years, so unique in character, so rich in known and unknown possibilities of interest, are surely as well worthy of research and exploration as the colossal monuments of pagan Egypt."

A. L. FROTHINGHAM, JR.

RECENT FURTHER EXCAVATIONS OF THE MEGALITHIC ANTIQUITIES OF "HAGIAR-KĪM," MALTA, by DR. A. A. CARUANA. Imp. fol. pp. 11, with 7 full-size lithographic plates: Malta, 1886, Government Printing Office.

Dr. Caruana's memoir treats mainly of that imposing work of Cyclopean art known as the *Hagiar-Kīm* (*i. e.*, the Stones of Worship or Veneration), and includes seven large tinted plates and a descriptive text. *Hagiar-Kīm* is 7½ miles south of Valletta, within the district of Krendi, rich in megalithic remains, mostly underground. This was, undoubtedly, one of the largest centres of habitation in Malta in prehistoric times, and, probably, the site of the original Phœnician capital of Melita, which, perishing, left its record in the name *Hal-Kbir*—"Great town." The valuable results of Dr. Caruana's latest survey, carried on under the direction of the Governor of these islands, are embodied in this monograph, which presents the most exhaustive account of *Hagiar-Kīm* yet given. We now know the configuration, primitive boundaries and extent of these remains, and possess full particulars for critical and historical inquiry. A scheme of systematic and gradual exploration of all the antiquities of Malta is countenanced by the local Government, and may be partially carried out, though the movement seems to lack the energy that the work demands. Dr. Caruana says that, though despoiled and neglected, some of these works of Maltese Cyclopean art might be made, with a little skilful restoration, to look almost as complete as when first erected.

Perusia read Perugia; for Vienna read Vienne, for *sotteranea* read *sotterranea* (throughout the book, as title of De Rossi's work), *etc.*

The origin of the megalithic antiquities in general, their era, the race to which they are to be ascribed, the object for which they were designed, are still subjects of dispute among archæologists. Dr. Caruana's memoir, with its scholarly research, is the latest successful attempt to throw new light on the subject. Scanty as is the evidence afforded by these monuments on their own history, that little is valuable. By a careful study of *Hagiar-Kim*, one of the best extant examples of megalithic structures, Dr. Caruana easily disproves Fergusson's theory, that these megalithic antiquities were generally sepulchres and not temples. The reasons why Fergusson dismisses the Maltese "Great Stones" from even his tomb-theory are weak: he says, "they [the Great Stones] are too much unlike anything else in Europe or Africa or the East" for comparison: and he has evidently been misled by erroneous information as to their sites; for, the truth is, the Maltese monuments are generally near the sea, not far distant from it, as he asserts. The point of Fergusson's objective argument is locality and situation, rather than structure. A far more scientific account is given in Perrot and Chipiez's history of ancient art, in the volume on Phœnicia, in which the analogies to buildings by the Phœnicians in Syria and in Phœnicia itself are made clear.

Caruana's excavations and explorations of the Maltese megaliths, and his many years of contact with them, make his conclusions as to the object of *Hagiar-Kim* worthy of respectful consideration by students; and the grounds on which he argues the religious character of this structure, as well as its erection by the Phœnicians, seem to be well sustained.

Measuring north and south, *Hagiar-Kim* is 210 feet, its width is 115 feet. The whole area, included within a somewhat wavering circuit, is 19,132 square feet: the entire perimeter is nearly 687 feet. The numerous chambers into which the temple is divided (only the most sacred ones were rudely roofed) are of oval shapes.¹ The stone of which *Hagiar-Kim* is built was quarried from the spot. Age and exposure have changed the color from its original pale buff to a pale grey, and given it a honey-combed appearance. The builders chose loose rock, and hewed the enormous slabs with tools, often squaring them. Some of them are upwards of 19 ft. in height by 10 ft. broad. The original height of the external walls of the building was 21 ft. The fact that certain portions of the walls of the inner chambers are still *in situ* helps to suggest their complete restoration.

Besides the bones of quadrupeds (mostly oxen and sheep) and fragments

¹ "It appears to have been one of the principal features of these large temples in Malta to be surrounded with sanctuaries to shelter, as in a Pantheon, the national deities. We glean this from the Phœnician inscription *Meliensis V*, found in the large temple . . . in the village of Xghara, Gozo. It is there recorded, that the people of Gozo renewed the four sanctuaries of *Sadam-Baal*, of *Ashtoreth*, and of two other divinities whose names are lost" (p. 2).

of primitive earthenware vessels, nine headless statuettes of ridiculous form and character were found among the ruins: "Seven of these statuettes are of soft Maltese stone, and two of hard-baked clay, glazed, and of a fleshy color. Two of the stone ones are seated, and wrapped in a large gown, proving their female sex, and one has a long tress of hair falling down to the heels. Four are in squatting position and naked" (pp. 5, 6), like Hindu idols, with limbs and bodies preposterously bloated. Some of the sacred slabs found here, pitted all over to represent the starry heavens, show in high relief two spiral lines encompassing the upper half of an egg (cf. Perrot and Chipiez, vol. III, figs. 226-31 and pp. 313-18).

A peculiar and very numerous class of tomb-caves exist in Malta, showing the presence of an ancient Oriental race—the Phœnicians; who formed the principal stock of the native population until long after the fall of the Roman Empire. Upon comparing the internal arrangement of *Hagiar-Kim* and the other Maltese megalithic antiquities with that of the Phœnician tombs, the Maltese archæologist finds nothing to indicate that they were intended for interment. Archæologists have claimed for *Hagiar-Kim* a sepulchral character, because one of the early races that settled here was used to cremation, and from the fact that cinerary urns, generally of the shape of the *stamnos*, full of ashes and half-burnt bones, are frequently found in small caves, together with clay and glass vessels which contained the perfumed liquids and ointments poured over the ashes: but such cinerary urns are Roman. The Romans took the Maltese islands from the Carthaginians, according to Livy, after the second Punic war, B. C. 216, and held them for about 640 years: early Greek colonies, according to Thoukydides, took and possessed the islands before the Romans, c. 700 B. C. (they also used cremation, and undoubtedly many of the Maltese cinerary urns are Greek): but it is not presumed that there is any Greek or Roman art in *Hagiar-Kim*, which must have been centuries old when the Greeks came. Dr. Caruana easily distinguishes Greco-Maltese from Roman tombs by the coins found in them. The Greco-Maltese, during their independence under an aristo-democratic government, coined their own money, of which eleven different types are in the Public Library of Malta. The Roman Republic introduced the Colonial or Romano-Maltese coins, and the Empire substituted its own currency. In *Hagiar-Kim* nothing like Greek or Roman tombs or coins has been found. "Hagiar-Kim, according to the view of those who believe in its sepulchral character, may have been a princely tumulus for a resting-place of the old Greek worthies of Malta, not inferior to that of Atreus erected by the Greeks at Mycenæ, or of Atalyattes by the Lydians at Tantalais. The number of these worthies must have been very considerable, as, besides *Hagiar-Kim*, *Mnaidra*, *Et-torri-tal-Borg*, *Et-torri-tal-Giaunar*, many other Great Stones,

of the same form, are hidden underground at Kortín, El-Marnisi, Hal-Assuiéni, the Salines, the Uardia, etc. I object to this, that when the former excavations were executed in 1827, 1839, and 1840, no traces whatsoever appeared of these Antiquities having been rifled, or even opened, before those dates. They looked, rather, in good preservation. A variety of furniture and little arrangements were found intact. Stone and clay figures, and several stones ornamented and sculptured, were recovered" (p. 8), but no cinerary urns. In brief, there is no local evidence that *Hagiar-Kim* was built for or ever used as a sepulchre. Moreover, the mausoleum-theory involves the placing of stone roofs on foundation-walls totally inadequate to sustain them.

There are, however, local evidences that it was a temple: "The distribution of details in the central portions of the principal areas, and the little arrangements within some of the minor apartments, especially at the *Mnaidra* and at the *Gigantia*, quite befit a place of worship, and are adapted for halls where religious pagan rites could be performed. Niches and apses, in which stone statuettes were placed at *Hagiar-Kim*, are symmetrically placed on either side of both areas" (p. 8). Altar-tables and *arae*, symbolical carvings and bas-reliefs have been found: a quantity of ashes and bones of quadrupeds, mostly oxen and sheep; clear traces of the action of fire upon the floor, besides a quantity of burnt earth, chiefly in the inner court, furnish further proofs of its use as a temple. The Phœnician origin is supported by the evidence of inscriptions, and by classical and traditional testimony. *Inscriptiones Melitenses I* and *V* give direct evidence for the temple-theory, and indirectly inform us of the race and era of their constructors. The typical shape of all the megalithic monuments in Malta is oval—uncouth in design and unpolished in execution, but distinctly oval; the egg being, among the Phœnicians, the symbol of the universe.

Dr. Caruana says (p. 9), "These monuments evidently testify to a mystery-worship of high antiquity, of non-Hellenic origin. . . The native religion of those primitive inhabitants of these islands appears not to have been affected by the subsequent Greek colonization . . . or Roman conquest. Those primitive settlers were thus allowed to keep their antique gods and rites, just as all Canaanite races in Syria and Phœnicia. They worshipped principally only two deities of nature: *Baal*, a male generative god, and *Astoreth*, a female conceptive goddess, of the Universe, symbolized by an egg. . . Now, we know for a certainty that the cultus of these deities was widely spread in the islands of Malta. We have seen, that the Great Stones at *Marsa-Scirocco* were positively consecrated to *Melkart* [a form of *Baal*]; and that two of the Sanctuaries in the Great Stones at Gozo were dedicated to *Baal* and *Astoreth*." A Phœnician stele, upon a jamb just within the entrance of the now-called Catacomb of St. Paul at Citta Vecchia, contains

an invocation to Baal. Further indications are found on coins of these islands, bearing the head of *Ashtoreth*, with veil in the coins of Melita, and with a helmet in Gozo coins, with the crescent in the exergue. The subsequent Greek settlers fraternized with the sea-faring Phœnicians, and with their dominion introduced the Hellenic divinities, but connected them with those of the Phœnicians. "We possess positive indications, that they had even adopted some of the Maltese Great Stones for their worship" (p. 10). They introduced brass hinges and hooks and columns and lozenge-shaped pavement-tiles in the temple of Melkart, which things were discordant with the primitive style of the structure. They Hellenized the megalithic temple at *Marsa-Scirocco*, as the fane of Melkart-Herakles. In this temple was probably found the Greek marble statue of Herakles, now in the Public Library. The temple of Ashtoreth, near *Castel Sant' Angelo* in the Grand Harbor, appears likewise to have been Grecized, and afterward Romanized as a temple of Juno. *Hagiar-Kim*, however, has suffered no Greek or Roman or Christian changes. Such as it is, it is purely and severely a Phœnician ruin, and as such it is unique of its class. As to the age of the Maltese megalithic remains: Fergusson says it is safe to assume that they belong to a period near the Trojan war,—but the Phœnician colonization of the islands probably goes back to a much earlier date, though it would be rash to assign to that time any of the existing remains.

Dr. Caruana's memoir closes with these words: "The use of our Great Stones as places of worship may have continued, at most, up to the 3rd century A. C. . . The courses superposed up to the height of 21 or 22 feet were, in process of time, pulled down. . . The fallen materials formed a mound on the rest, and drifting soil was accumulated up to the height of seven or eight feet, . . leaving only the tops of the taller stones visible. So they were entombed at the time of Comm. Abela [the Maltese historian] in 1642, and up to the time of their discovery in 1827 and 1839. Several of the stones have since been carted away, even recently, for walling up the terraces of newly cultivated lands. And, if proper means be not at once adopted for their preservation, these most interesting monuments will shortly disappear, to the everlasting ignominy of those who should take care of them."

JOHN WORTHINGTON.

Island of Malta.

COLLECTION DE CLERCQ. CATALOGUE MÉTHODIQUE ET RAISONNÉ. ANTIQUITÉS ASSYRIENNES. Cylindres Orientaux, cachets, briques, bronzes, bas-reliefs, etc. publiés par M. DE CLERCQ avec la collaboration de M. J. MENANT. Première et deuxième livraisons. Folio: text and heliotype plates. Paris, 1885, Ernest Leroux, éditeur.

Among the most useful work that could be undertaken at present by archæologists is the collection and publication, each in a separate *corpus*, of the various classes of smaller antiquities, which have been in many cases neglected. If writers, instead of being obliged to collect their material from a thousand different sources,—museums, private collections, books, and magazine articles, could find it all at hand in one series, how many more works of general importance would see the light. Those men who help to place before the scientific world in orderly shape all this scattered material must be considered real benefactors.

The work of which we are noticing the first parts is by no means a complete *corpus* of the cut gems of Western Asia, for it illustrates only one of the four largest collections in the world; but it is a first and great step: and, if the British Museum, the Louvre (to whose collection some 250 cylinders from Elam have just been added) and the Metropolitan Museum in New York (which possesses over 400) decide to publish their specimens, the *corpus* would be well toward completion. M. de Clercq's collection numbers 414 pieces, of which about 250 are published in the plates already issued: they are fine examples of the unrivalled skill in *héliogravure* of the house of Dujardin. The accompanying text contains, first, an introduction by M. Ménant to the study of Oriental glyptics, consisting especially of a systematic classification of the cylinders into periods and schools, which varies but little from that proposed in his *Glyptique orientale*, but is illustrated mainly by examples in this collection. Then follows a detailed catalogue of the cylinders, drawn up with wonderful care and exactness, in which the minutest points are noted, and, on the other hand, great sobriety is shown in speculations concerning the subjects and meaning of the figures represented. The great majority (300) of these cylinders belong to the Early Babylonian period, before the rise of Assyria; though, even within these limits, the period over which they extend cannot be less than 2,000 years, beginning with the archaic period, passing through that of the *Pattai*, to the Early Empire of Sargon of Agadé, which was followed by the schools of Erech, Sirpurla and Ur; the latter being by far the most prolific. Then, by the side of early and late Assyrian cut stones, we find those products of a mixed art which may be styled either Egypto-Assyrian or Phœnicio-Assyrian, according to the qualifying style. Further subdivisions might be made, as the artists of Syria, Phœnicia, and Kypros produced at various times works of a most complex character. Then follow the seals of Hitite, Late Babylonian, and Persian art.

For general remarks on the history and importance of the intaglios of Western Asia, I may refer to my review of Ménant's *Recherches sur la Glyptique orientale*, published in this Journal (1886, pp. 187–195). The special importance of the present costly and magnificent publication lies in its plates. The works of Cullimore and Lajard, published about a cen-

ture ago, contained the only large collections of illustrations yet given, so that here the scientific world is for the first time possessed of artistic and mechanically accurate reproductions of these minute works. How interesting this is, can be judged simply by citing a single topic on which they throw light: the Mythology of Western Asia. This subject is still wrapped in great obscurity, and the cylinders, containing for the greater part religious scenes, are almost the only graphic assistance in its study that can be obtained. To select merely a subdivision of this topic: the representation of the divinities in art, and consequently the further determination of their character and attributes. Of the many religious and mythological symbols and figures represented on these cylinders, which, excepting a few Assyrian sculptures, are the only remaining artistic rendering of the pantheon, how many have yet been identified by writers? Only three, with certainty: Sin, symbolized by the moon; Šamaš, by the sun; Ishtar by the star and the lion. To one acquainted with the great extent of the Babylonian Pantheon and the numerous changes that have taken place during its mythological history, this seems incredibly meagre. Why has so little attention been given to Eastern mythology in art, which is only second in importance to mythology in literature? From actual lack of material! We have in these cylinders ample and varied material from which, with careful study, an almost complete mythology, with its historical stages, might be made out, and a further step taken in our reconstruction of primitive Oriental thought. I hope to give, in future numbers of this Journal, some brief contributions of this character, founded on a comparative study of Oriental cylinders, and shall find a large part of the material in this great collection of M. de Clercq.

A. L. FROTHINGHAM, JR.

LES MUSÉES D'ATHÈNES en reproduction phototypique de Rhomaïdès frères. Publication de C. RHOMAÏDÈS. — FOUILLES DE L'ACROPOLE. Texte descriptif de P. CAVVADIAS, Directeur général des Antiquités. 4to, 1^o livr. pl. I-VIII. Athens, 1886, Karl Wilberg. Prix fr. 7.50.

The sensation made by the discovery, in February last, of the archaic antiquities on the Akropolis of Athens has been fed by the numerous accounts of them published in popular form in the periodical literature, or with more scientific treatment in archæological reviews, as by M. Reinach in the *Revue Archéologique* (July-Aug.) and by Mr. Miller in the *JOURNAL* (vol. II, March pp. 61-65). But only some unsatisfactory reproductions of a few of the unique archaic statues had been as yet given (*Gazette des Beaux-Arts*, 1886, I, pp. 417-21; *Pall Mall Gazette*, Feb., etc.), and

but one in the *Ἐφημ. Ἀρχ.* 1886, No. 2; so that no adequate idea could be obtained of them until the publication of the present work, whose first number contains phototypic reproductions of seven of the statues. Referring to Mr. Miller's account, we find that the antiquities included (1) fourteen archaic statues or fragments of statues; (2) numerous primitive bronzes; (3) some vases and many fragments of pottery; (4) quite a number of archaic inscriptions including several with artists' names. By far the most interesting of these antiquities are the series of statues, which far surpass all previously discovered specimens of archaic sculpture, and represent the complete development of that style in the most artistic province of Greece—Attika. The study of these works is all the more indispensable that they are, in the VI century, the precursors of that beautiful Pheidian period, and may serve to explain some of the transitional steps to it.

These statues were used as levelling-material, being piled up side by side, probably soon after the Persian war, when the work of reconstruction was begun on the Akropolis. The old, and probably even then fragmentary, sculpture was of no use, and was put to this ignoble purpose. All these statues are richly ornamented with many colors, reproducing the elaborate details of the rich chiton and himation, and it is much to be hoped that some at least will be reproduced in colored plates before the colors fade, as they certainly will before another year. They are mostly female figures, and their identification with either Athena or priestesses of this goddess meets with the same difficulties, *e. g.*, that prevent any satisfactory identification of the numerous male statues found at Perdikovrysi in the sanctuary of Apollon Ptoos; or of the female statues of Artemis (?) at Delos. In these statues of the Akropolis, the long hair is arranged in symmetrical curls confined by a diadem and falling over the shoulders and down the back. On the head was an upright bar of bronze, which probably supported some umbrella-shaped covering that served to protect them from the weather. There is unusual variety in these statues, not only in type, but in proportion and in arrangement of hair and drapery. There is, in some cases, such a tendency to portraiture, that one is inclined to adopt the priestess-theory, for, if not, how can it be conceived that in the VI century, when types were so strictly followed, these greatly varying figures could have represented a single divinity—Athena. These variations cannot be attributable to difference in age, as it is evident that all date from about the same period.

This first number of the *FOUILLES DE L'ACROPOLE* contains eight large and fine phototypes, seven of which reproduce the most important of the female statues. This work will be necessary to all archæologists and students of art, as it will in time reproduce all the antiquities preserved in the various museums of Athens.

A. L. F., JR.

THE PERMANENT FUND FOR THE AMERICAN
SCHOOL AT ATHENS.

Professor A. L. FROTHINGHAM,
The American Journal of Archæology,

Sir: Your attention is respectfully invited to the enclosed advance proof of an article on the American School of Classical Studies at Athens, Greece, which is to appear under "Topics of the Time" in the Century Magazine for February. It is desired to collect a permanent fund of not less than \$100,000, or even of \$200,000, in order to ensure the usefulness of the School at Athens for the future, and to eliminate what element of uncertainty may be inherent in the system of support by annual subscriptions, which has now been applied successfully for five years.

It is important that the permanent fund be raised without delay, in order that advantage may be taken of an opportunity to secure the services, as permanent Director of the School, of Dr. Charles Waldstein of New York, the young archæologist who has won recognized fame in the service of Cambridge University, England.

Any notice which you may feel called upon to make, in your columns, of the Century article and of the effort of the Committee in charge of the School, will be received with cordial appreciation.

Subscriptions toward the permanent fund of the School at Athens, of which public acknowledgment will be made, may be sent to the Treasurer of the Managing Committee of the School, Frederic J. de Peyster, Esq., No. 7 East Forty-Second street, or to Messrs. William Alexander Smith & Co., Bankers, No. 58 Wall street, New York.

I have the honor to be, Sir,

Your obedient servant,

THOMAS W. LUDLOW,
Secretary of the Managing Committee.

[We most heartily endorse the statements made in the above letter, and earnestly commend them to the attention of those who have it in their power to advance American learning by aiding in the establishment of so useful and important an institution as the School cannot fail to become. The building at Athens is ready; young men are willing to go from our colleges; and the great step to be now taken is to supply this fund, in order to complete the work.—ED.]

ARCHÆOLOGICAL NEWS.

SUMMARY OF RECENT DISCOVERIES AND INVESTIGATIONS.

	Page.		Page.		Page.
ALGERIA,	484	ENGLAND,	501	MEXICO,	508
ARABIA,	478	FRANCE,	498	PALESTINE,	478
ARMENIA,	477	GERMANY,	499	PHENICIA,	477
ASIA MINOR,	477	GREECE,	478	ROUMANIA,	500
AUSTRIA-HUNGARY,	500	HINDUSTAN,	472	RUSSIA,	501
BELGIUM,	499	ITALY,	481	SPAIN,	498
CEYLON,	488	JAVA,	485	TUNISIA,	484
EGYPT,	460	KYPROS,	478	UNITED STATES,	504

A F R I C A.

EGYPT.

Excavations in 1886.—In his report made to the *Académie des Inscriptions* on July 16, M. Maspéro gave an account of the excavations executed during the year in Egypt. The new authorization to excavate given to private persons has been productive of the best results. Thus, at *Gournet-Mourraï* was found a Theban tomb of the xx dynasty, that of a guardian of the necropolis of the reign of Rameses IV, containing, not only his body and those of his family, but a complete collection of sepulchral objects.

EGYPT EXPLORATION FUND.—The fourth annual general meeting of the Egypt Exploration Fund was held, on Dec. 8, in London. The following was adopted as the program of the organization: “(1) To organize excavations in Egypt, with a view to further elucidation of the History and Arts of Ancient Egypt, and to the illustration of the Old Testament narrative in so far as it has to do with Egypt and the Egyptians; also to explore sites connected with early Greek history, or with the antiquities of the Coptic Church, in their connection with Egypt. (2) To publish, periodically, descriptions of the sites explored and excavated, and of the antiquities brought to light. (3) To ensure the preservation of such antiquities by presenting them to Museums and similar public institutions.” The financial outlook of the society was favorable, there being a balance on hand, at the close of the financial year, of £1,933. 8s. 2d. Miss Catharine L. Wolfe of New York recently sent a donation of \$1,000 for the general purposes of the Fund. Mr. ERNEST A. GARDNER gave a brief

account of the results of his second season's work at Naukratis (JOURNAL, II, p. 181). A report was read from Mr. F. D. GRIFFITH on his excavations at Gemayemi and Kantara (see below); and another by Mr. FLINDERS PETRIE, being a general review of last year's work at Naukratis, Nebesheh (Am), Tell Ferain (Buto) and Tell Defenneh (Tahpanhes).

Future Work.—The work of the coming season was outlined by Miss EDWARDS. It will be under the direction of M. Naville, who will be assisted by Mr. Griffith and Mr. Cowan. The field to be explored will be "the course of the sweet-water canal from Cairo to the Wady Tumilât, the fertile pastures between Zagazig and Tell-el-Kebir, and the caravan route from Kantara to Farama." The object, as in 1883 and 1885, will be the determination of the route of the Exodus.

It was announced that the MSS. and drawings for Mr. Petrie's Memoir on Nebesheh and Defenneh (with chapters by Mr. Griffith), as also the MS. and drawings for M. Naville's Memoir on Goshen, were in the hands of the committee, and would be published as soon as time and means should permit. The donation of antiquities to the Museum at Boston was stated to be little if at all inferior to that voted to the British Museum. The "Fowler Fund" has been completed by the nineteenth donation of £50, making a total of £1,000.—*Academy*, Dec. 25.

AKMIM.—Here has been found the hunting-meet where ever since the sixth dynasty all succeeding races have left traces of their passage by inscriptions in various languages.

CAIRO.—*Baldq Museum: Royal Mummies.*—The unrolling of some royal mummies in June was an event of considerable importance, and created quite a sensation. On June 1st those of Rameses II and III were uncovered: the former was found in perfect condition, giving the portrait of the more than nonagenarian monarch at the time of his death. It is reproduced in three fine heliotype plates accompanying M. Maspéro's report in the *Revue Arch.* (July-Aug., pls. XII-XIV), and these have been copied in the *Illustr. Ztg.*, July 3, *Harper's Weekly*, etc. On June 9th the mummies unrolled were those of Seqenenra Taâaqen, and Seti I, the father of Rameses II. The latter is remarkably well preserved and will, it is hoped, be reproduced. Prof. Maspéro's report is given in full in the preceding number of the JOURNAL (II, pp. 331-33). Another mummy was that of an unknown youth, evidently of royal family, whose death was probably caused by asphyxia or strangulation, thus disclosing a royal tragedy of the XIX dynasty.

GEMAYEMI.—At this site, some three miles from Nebesheh, "Mr. Griffith excavated a small enclosure which had originally contained a sanctuary, but which had subsequently been converted into a centre of art industry, containing the workshops of glass-makers, bronze-workers, sculptors, and

the like. The place seemed to have been abandoned in time of panic, all the tools and more portable objects having been carried off, and only the heavier or more breakable ones left behind. Among these last were a large basalt bowl, a huge pottery-bin, and a number of plaster-casts such as were used for models by the sculptors of ancient Egypt. The casts had been buried, in order to preserve them uninjured, and with them were found a quantity of little figures of gods, panels inlaid with glass mosaic, hooks, nails, rods, hinges and capitals of bronze—all the fittings, in short, for the adornment of a portable shrine of most exquisite workmanship [Shrine of Ptah, see p. 503]. The remains found in the glass-workers' factory were of extreme interest. In the foundations of one room were discovered, not only the very moulds in which had been formed the bars and hieroglyphs of coloured glass with which the before-mentioned panels were decorated, but numbers of pieces of waste blue glass, and some remarkable bars of mosaic for sectional slicing, some of the sections being already nicked with a diamond point . . . There can be no doubt that this was the site of a native factory; and similar moulds were found by Mr. Griffith at Nebesheh and Kantara."—*Academy*, Dec. 25.

KANTARA.—"At this latter place Mr. Griffith excavated the remains of a small temple, or chapel, dedicated to the deity of the frontier district, Horus of Mesen, where two beautiful sandstone monuments, erected by Seti I and Rameses II, are all that now remain of a frontier-fort there erected by the first Pharaohs of the XIX dynasty. Mr. Griffith describes these monuments as two inscribed pedestals, each surmounted by a hawk, the emblem of the god. Deserted and destroyed after the Ramesside period, and superseded by Defenneh under the kings of the XXVI dynasty, Kantara seems to have been for several centuries blotted from the map of Egypt. At length, late in Ptolemaic times, the place again became, not only a fort, but a settlement; and, under the Roman domination, a great camp was here dedicated by Diocletian and Maximian to their patron gods, Jupiter, Herakles, and Victory. A Latin inscription of ten lines, found here, identifies Kantara with the *Castra* of the first wing of the Thracian Legion under Marcus Aurelius: it is now in the British Museum."—*Academy*, Sept. 4; Dec. 25.

LUXOR.—The obstacles to the complete clearing out of this temple are caused by the necessity to demolish the mosque and expropriate several foreign consular agencies. Negotiations to secure this result are almost concluded.

MEMPHIS.—In the necropolis of the pyramids has been found on a stele an image of the great Sphinx placed on a base the existence of which had been unknown until now. The great Sphinx was cut in a geological formation which was hollowed out all around it in the form of a basin. Prof. Maspéro considers that the Sphinx was already ancient in the time of the

iv dynasty, and may perhaps be considered a prehistoric monument.—*Académie des Inscriptions et Belles-Lettres*, Sitting of June 18.

NAUKRATIS.—In Mr. Gardner's official report on his last winter's work at Naukratis he says: "I have undertaken to publish a full account of my work, of the sites and objects discovered, and of the archæological results gained therefrom, as one of the memoirs of the *Egypt Exploration Fund*. This volume will probably appear in the course of next year." The results of his work partly appear in the eighty cases of antiquities dispatched by him to England.—*Academy*, Nov. 13.

TAHPANHES=DAPHNÆ=TELL DEFENNEH; and the **EGYPT EXPLORATION FUND.**—In order to guard the frontiers of Egypt on the side of Syria and against Assyrian invasion, Psamtik I built here, about 665 or 666 B. C., for his foreign mercenaries, a gigantic fortress and in connection with it an important city, at a distance of about sixteen miles from Tanis. To it the Jews fled after killing Gedaliah, under Hophra (Apries) of the xxvi dynasty. On this site, Mr. Petrie found three mounds $\frac{1}{2}$ or one mile apart: two of these contained only ordinary débris, but the third was composed of millions of bricks forming a gigantic pile and bearing evidence of an immense conflagration: it is known to the natives by the name of *El Kasr el Bint el Yahudi*, "Castle of the Jew's daughter." The passage in *Jeremiah* (XLIII, 8-11) referring to the brickwork in "the entry of Pharaoh's house in Tahpanhes," is connected by Mr. Petrie with a court paved with bricks, which he discovered. The excavations disclosed an immense square keep, with sixteen chambers on each floor, of which only the basement remains intact; the remainder having gone to form the débris of the mound. This stands in the midst of a courtyard, which again was inclosed within an immense walled area, 2000 by 1000 ft. The boundary-wall was 50 ft. thick: in the soil that it inclosed were found remnants of muniments of war, horse-bits, arrow-heads, weapons, and implements in iron, together with all the traces of an iron-foundery. Under each corner of the foundations was a complete set of foundation-deposits illustrating the whole ceremony of the dedication: they consist of models of the objects used in the sacrifice (libation-vases, corn-rubbers) and of the bricks employed, the actual bones of the sacrificial ox, specimens of ore, and a series of little tablets in gold, silver, lapis-lazuli, jasper, carnelian, and porcelain: the latter are all engraved with the name and titles of the founder, Psamtik I. In the Pharaoh's pantry were found numerous jar-lids and plaster amphora-stoppers; in the kitchen, the dressers, jars and dishes. In two disused chambers of the palace were found a quantity of Greek painted pottery, the interest of which cannot be overrated, as every example can be dated to within a period of thirty years (580-550 B. C.). The only trace of Naukratis-ware in all this mass consists of two insignificant frag-

ments; the remainder is painted in styles examples of most of which we already possess—Fikellura, Rhodian, geometric, *etc.*; but, in almost every case, some slight difference in detail or treatment marks the fabric as specially local. The style of many of the works found belongs to the Renaissance of Egyptian art which took place under this xxvi dynasty.

Out in the plain were the traces of a town, with the line of streets and basements of the houses still clearly marked; here were discovered pieces of jewellery and numerous small weights such as goldsmiths would employ; while pottery was scattered broadcast everywhere. As yet, no remains of a temple have come to light, though there are walled inclosures within which these may have stood. The entire character of the remains is, in fact, precisely what we should expect from history: a fortress of great strength, and yet on a scale befitting the abode of Kings; a barrack where a great force of soldiery could find quarters; and just so much of a town as would naturally gather around such a nucleus, with industries suitable to its Greek population. In one of the lakes near the town may even be seen traces of the docks, where, the father of history tells us, the Greek ships were laid up.—FLINDERS PETRIE in *Academy*, June 26; CECIL SMITH in *Illustrated London News*, Sept. 11; *Cour. de l'Art*, pp. 411, 428, 435. Cf. JOURNAL, p. 503.

ALGERIA.

CHERCHELL.—*Statues*.—MM. Waïlle and René Basset have been very successful in their expedition. The former has unearthed at Cherchell two marble statues—a large Bacchus, and a headless Venus of good art: also mosaics, inscriptions and medals. These were found in a ruined building, some eight metres below the surface.—*Le Muséon*, August.

TUNISIA.

Preservation of Monuments.—At a sitting of the *Acad. des Inscr. et Belles-Lettres*, held Sept. 17, M. de la Blanchère gave an account of the organization of the service for archæological missions and for the preservation of antiquities in Tunisia. Last year, the Minister of Public Instruction decided to send a permanent delegate of the Ministry to direct the work of those who have charge of scientific expeditions in Tunisia. M. de la Blanchère was appointed to this position. On the other hand, the Tunisian government, at the request of the French minister M. Cambon, decided to take steps for the protection of ancient monuments, and for the creation of a department of antiquities and arts, the direction of which was also confided to M. de la Blanchère. One of the first steps was to ensure legislative protection for monuments. This was done by a government decree of March 7, which, while it recognizes the ownership of antiquities by the

persons who discover, authorizes the department of antiquities to proceed to a "classification" of historical monuments worthy of preservation; and whatever monument is thus classified cannot be touched. Violation of this is punished by fine, in order to abolish the custom of using ancient materials from motives of economy. Excavations cannot be made without government authorization and supervision. Chance discoveries must be immediately reported. Inscriptions are included in the same category as monuments. As soon as promulgated, these laws were rigorously applied.

M. de la Blanchère has visited this year the South and West of the Regency (Tunisia), to gather the elements of a *classification of historical monuments*. He expects to visit the North and the West during next year for the same purpose, and to finish the classification in 1888.

The "Service Beylical des antiquités et des arts" has begun two important undertakings: (1) *an inventory of the historical monuments of the regency*, in the form of a dictionary accompanied by an archæological map; (2) *the creation of a museum at Tunis*. It is hoped that the dictionary and map may be finished within three to five years. There will be great difficulty in the organization of the museum, especially with regard to the transport of large objects through a country without roads or suitable cartage. The monuments already collected at Tunis have been placed in a handsome palace—the former harem of the Bardo—given by the Bey. At various points throughout the territory, provisory deposits are being formed, from which the monuments may, at some future date, be transported by sea to the Bardo, with the help of the fleet. There are at present eight of these,—at Zarzis, Gabès, Younga, Sfax, Monastir, Soussa, and Nebel: at Zarzis are the statues discovered at Ziân by MM. Reinach and Babelon; at Gabès are the military mile-stones found south of the *Shotts*, the first to disclose the existence of a net-work of Roman roads in this region; at Sfax, are the Christian antiquities of the cemetery of Lamta, explored by MM. Cagnat and Saladin, *etc.*—*Revue Critique*, 1886, Sept. 27.

ASIA.

JAVA.

BRAMBANAN.—*Siva Temples*.—It is announced that M. Yzerman, in excavating here, has discovered the remains of several Siva temples, and also a number of inscriptions of the Saka period, analogous to those copied in Cambodia by Captain Aymonier (*JOURNAL*, I, pp. 423–24).—*Le Muséon*, August.

CEYLON.

We extract the following items from the Report, made to the Colonial Secretary by Mr. S. M. Burrows, C. C. S., of archæological work done at Anurádhapura and Pollonnaruwa under his direction from August 1884 to Feb. 1886. The work consisted of discovery and excavation, of reërecting architectural members, of removing the *débris* which in some cases completely filled buildings already known, and thus uncovering sculptures, paintings, and inscriptions, as well as coins and other small objects. Plans and translations of nine inscriptions are given in the Report.

ANURADHAPURA (Aug. 1884 to Feb. 1886).—In the vicinity, in the forest, were uncovered the prostrate members of a stone-roofed canopy, which was reërected on its platform with 8 pillars: the roof was formed by three immense stones weighing over 20 tons. Traces of ancient inscriptions were visible on all of the six monolithic steps which formed its staircase. The age of the monument is supposed to be c. 2000 years.

Dágoba and Monastery.—Two and a half miles north of the Jétawanáráma Dágoba were discovered (1) the ruins of a small dágoba of brickwork rising from a square stone base; (2) a large oblong building (monastery?) with boundary-wall of huge slabs, on each of which is carved a single, male figure in relief under a large canopy in very high relief.

Eastern Chapel of the Abhayagrî Dágoba.—This chapel, covered by a vast mound of *débris*, was excavated by cutting through masses of fallen brick. "The chapel is by far the most perfect of the four [the chapels on the north, south, and west had been previously uncovered], and gives a very good idea of the structure of these and similar shrines. The chapel was flanked at either extremity by three carved monolithic slabs: the external slab, about three feet in height, presents a seven-headed cobra in the act of springing; the front face of the central slab is divided into two compartments, containing a male and a female figure respectively, in high relief, the head of the former being shrouded under the hood of a five-headed cobra, while a single-headed cobra appears over the woman's head; the side face is also divided into a small and large compartment, the former representing an incident from the story of Buddha, the latter being devoted to an elaborate flower-scroll, into which animals, such as the 'hansa,' the Brahmany bull, and the peacock are introduced. This slab is about seven feet high. The inner slab, about six feet high, is entirely covered with flower-patterns. Between these flanking slabs (which are all in wonderful preservation) is the main part of the shrine, consisting of a series of stone panels rising from an ogee moulding, and surmounted by a frieze of projecting elephant-heads alternating with displayed lotuses, an upper frieze of 'Buddhist window,' and a terminal line of diamond-shaped moulding.

The whole of this was, no doubt, elaborately painted: traces of the colour are extant on the cobra and on the male and female figures; and in two of the basement panels both the colour and the intricate patterns are wonderfully distinct."

A Vihára with chapels at the four corners was discovered and excavated, about 100 yards west of the Lankaráma Dágoba. "The stone ogee moulding and slabs which form its boundary-wall and external platform are of very bold and massive workmanship."

During the excavations at this point was found a copper coin of Theodosius I, struck c. 385 A. D., showing intercourse with the Roman Empire.

A Vihára of the first class, situated on the opposite side of the road to the "Stone Canoe," was excavated. It measures 80 by 60 ft. and has a very fine flight of stone steps. "The 'moonstone,' though very large, presents the lotus only, without the usual concentric circles of animal figures; but one at least of the door-guardian stones, standing over 5 ft. high, is unrivalled in excellence of preservation and delicacy of finish. There is a smaller chapel at each corner of the vihára, approached in like manner by a stone stairway and moonstone."

Thoroughfare with its structures and sculptures.—Near the above vihára was laid bare a low boundary-wall of granite blocks which formed one side of a main street, on which was found a seated statue of Buddha, 7 ft. 9 ins. high: and opposite the statue, a smaller thoroughfare running at a right angle to the main street was excavated: it passes through a large oblong ambalam and several preaching-halls, then opens upon a very large vihára with the usual four chapels; evidently one of the most important in Anurádhapura; the road then passes another ambalam, and beyond that another vihára "surrounded by an embattled frieze cut in white limestone; at a right angle to this, there is another vihára of the largest size and of a peculiar design, as the tall and admirably carved pillars are arranged in three close rows on either side, leaving a wide space down the centre."

A large Palace, to the north of the 3½ mile-post on the "outer circular road," was discovered and as far as possible restored. "The whole set of buildings was in a state of advanced ruin: but it is now one of the most complete, and certainly the most imposing, of all the secular buildings."

Three Pavilions were discovered to the north of the 1½ mile-post on the "outer circular road": an even more extensive group of secular buildings than the previous one. The largest of the three is of the first class, and capable of satisfactory restoration.

Ecclesiastical Buildings.—To the north of the Jétawanaráma Dágoba was discovered a very interesting group of ecclesiastical buildings, neither "monastery" nor "college," but somewhat resembling a minor English cathedral with its precincts. "On entering the inclosure, there are build-

ings on either side. That to the right is remarkable for having three contiguous entrances in a row—an arrangement which I do not remember elsewhere, unless it be in a somewhat similar building at Vigitapura. It was evidently of very large dimensions, and the pillars are capable of sustaining a ponderous roof." Within the inclosure, to the left of the entrance, is a large monastery (of 80 pillars) and a small one: but the principal buildings of the inclosure are a vihāra with its four attached chapels. The jungle near by "is thick with ruins, which I have not had time to touch."

Stone Canoe.—In the jungle north-east of the Thupārāma and not far from the old track of the Sacred Road was found "a large 'stone canoe' (properly speaking, a food-vessel for priests), making the fourth of these curious receptacles at present discovered."

Museum.—"A local museum has been started, in which are placed articles of every sort which are turned up in the course of excavation. The object kept in view is, of course, a double one—the preservation of sculptures, paintings, &c., from injury, and the collection of curios. A great many interesting relics have already been got together, including specimens of glazed and common tiles, moulded bricks, stonemason's tools, fragments of statues (crystal and limestone), coins, treasure-stones, personal ornaments, &c."

POLLONNARUWA (March 1885 to March 1886).—"The extreme drought of last year made it possible to burn a good deal of the surrounding jungles: consequently, it is now easy to walk over a considerable portion of the environs of the old city." The immediate result was the laying bare, along its whole length, the wide moat of the fortified part of the city and remains of the city-wall: also two large drains from the moat. "These drains are admirably constructed of granite,—one has six outlet channels, and the other two, and they are as perfect as when they were first laid."

The Thupārāma.—The entrance to, and interior of, this curious building were almost entirely blocked up with *débris*, which has been removed. "The inner and principal shrine is one of the very few buildings remaining to us, in either capital, with a perfect roof;—certainly the only building of such a size, and it presents a very remarkable example of the dimensions to which the false arch was capable of attaining. The fragments of no less than twelve statues of Buddha (none quite, though some very nearly, perfect) were found in this shrine, while at the foot of the large brick statue of Buddha which stands against the western wall, a large granite slab, or stone-seat (*gal-āsana*) was uncovered, with an excellently preserved inscription running round its four sides."

The Heta Dāgé.—"In March 1885, this building was so utterly choked with *débris* that it was impossible to make out its original shape and object. It has now been successfully cleared," with fruitful results. "No

less than three long inscriptions, two legible and one partially illegible, were found in this building: one in the porch and two in the outer shrine. The first two enable us to identify the builder and date of the Heta Dágé [the 2nd year of King Nissanka Malla, who reigned 1187-96 A. D.]. The floor of the inner shrine is remarkably perfect . . . The centre portion is raised, and round it runs a gangway at a lower level. On both sides of this gangway there was a broad band of red colour. The painting has been carefully uncovered, and on one side at least is very well preserved, affording the only instance of a coloured floor yet found. At the northern end of the inner shrine, facing the entrance, are the remains of three large erect statues of Buddha, and near them were found the upper portions of two other statues, remarkable for their terracotta colouring and the incisive and distinctive rendering of the features. Several minor articles of interest were also found here, and have been placed in the local museum.

“*The Sat Mahal Prasáda* has been thoroughly cleared, and the *débris* removed from the lower story; but it remains as mysterious and puzzling a building as ever. The passage which appears to run round the base of the building is abruptly closed in two places by transverse brick walls; nor is there any access to the summit from the interior. An exterior staircase is now revealed, but it leads only to the top of the first story. Mr. Fergusson conjectures that this building is a lineal descendant of ‘Birs Nimroud,’ which also had seven stories, each story bearing the distinctive colour of the planet to which it was sacred. I had ladders erected to the top of the *Sat Mahal Prasáda*, but could find no traces of colour, except a broad streak of pink on the northern face of the second story.”

Unidentified Building.—“Excavations have been commenced at a building, not yet identified, which lies close to the Heta Dágé on the west. It is remarkable for a series of fine pillars, decorated throughout their length with a bold and peculiar scroll-pattern. There is a great deal more work still to be done here; at present we have succeeded in laying bare a southern and an eastern entrance. The latter is of the ordinary granite; the former, together with its large moonstone, is carved in white limestone,—the only example yet discovered. At the northern end of the building we unearthed a large erect, and a smaller sedent, statue of Buddha. The former has lost its head, but the latter is quite perfect, and very well executed, the clean-cut features having a peculiarly meditative expression quite different from the ordinary types.”

The Nissanka Latá Mandapaya.—“A little to the south-west a great deal of work has been done at the building which we now know to be ‘Nissanka’s hall of the flower-scroll.’ This is perhaps the most interesting building in Pollonnáruwa, for it presents a structural example in granite of the ‘Buddhist railing,’ and, according to Fergusson, there is only one

structural example to be found in the whole of India, viz., at the Sanchi Tope, although, as an architectural ornament, it is extremely common on Buddhist buildings of all kinds. Unfortunately, it has been wilfully and extensively broken, but most of the stone posts are still standing; while on the western side two posts are left with their three rails still in position, which enables us to form an excellent idea of the whole arrangement." A great many fragments of an extremely ornate inscription have been found in the building, from which it is possible to decipher "both the name of the building and of the king who built it."

Temple of Vishnu.—"At an angle of the city-moat a small temple of Vishnu, built entirely of granite, was discovered, and has been excavated. Its inner shrine contains a good statue of Vishnu, which has been replaced in position. Several excellently carved stone figures were found here, two of which have been photographed, and also the greater part of a large bold frieze of lions:" also two small fragments of inscriptions.

"In the immediate neighborhood of this temple were found another fragment of an inscription, which proves to be a copy of Nissanka Mala's slab near the Daladá Máligáwa; a broken statue of the familiar Pulleyar, or Ganesa; a broken statue of the Katragama Deviyo, with his peacock; a statue of Iswara; a broken statue, which cannot be identified; and a flag staff-holder;—all of granite."

Inscribed slab of Nissanka Malla.—"Further to the east a large inscribed slab was discovered, which proves to be another copy, word for word, of Nissanka Mala's slab near the Daladá Máligáwa . . . Both inscriptions terminate with emblematic sculptures—a row of figures representing the kingly caste, viz., a lion, a horse, an elephant, a goose, a cobra, and the sun; with its low-caste equivalent immediately under each, viz., a jackal, a donkey, a snipe, a crow, a worm, and a firefly."

Four Hindu Temples.—To the west of the road leading from the Thúpárama to the Rankot Dágoba were found the remains of "four small Hindu temples, all close together. One of these contains a perfect statue of Vishnu, and another has near it a large statue of a goddess with eight hands, standing on the head of a buffalo, which is probably a representation of Káli. These temples are mostly of brickwork, with stone doorways and pillars. Work has been begun upon them, but a great deal still remains to be done."

Nissanka Dána Winóda Mandapaya.—Close to the above four temples "are the ruins of a much larger building, which apparently consisted of an outer and an inner enclosure; the former surrounded by a high brick wall, part of which remains, the latter containing several large pillars, of which only the stumps are left. There are also two large granite stairways, of the usual type, and signs of a lion frieze running all round the

inner enclosure . . . An inscription on two sides informs us that this building was erected by Nissanka Malla, and was called the Nissanka Dána Winóda Mandapaya, or the 'Nissanka hall of alms-distribution.' There is an interesting reference to this building, and its object, in the 'Galpota' inscription (see Müller's *Ancient Inscriptions*, pp. 98, 131)."

The Naipena Vihára has been thoroughly cleared and partly excavated. To the west and north of the main temple are two circular buildings surrounded with walls, which at first sight look like wells, but certainly are not so; one bears signs of a large figure of a five-headed cobra, and "it is hard to resist the conclusion that these circular buildings were snake-pits to hold the sacred cobras, for whose worship the temple was erected, and whose name it still retains. The eastern approach, or *pro-naos*, of one of these temples is formed by an arrangement of pillars which is also suggestive. At the extreme east are four rows of ten pillars, and from these, and at right-angles to them, ten rows of four pillars lead up to the door of the temple. The analogy, both in number and arrangement to the 'Choutries' of Southern India and the 'Chaories' of Upper India is too close to be merely accidental."

"A *Vishnu Temple* has been found, about a hundred yards from these pillars, extremely similar to that described [at an angle of the city-moat] except that in the outer shrine there is a beautiful window formed from a single slab of granite, and pierced with diamond-shaped holes, somewhat after the fashion of the Jallee work of Agra and Delhi."

The Demala Maha Saya.—"I succeeded in tunnelling along the inner wall on either side of the small northern doorway for a short distance, and uncovered two large panels, or recesses between pillars, about 12 feet high by 5 wide, profusely covered with paintings in very fair preservation. The pillars are ornamented with a scroll-pattern very similar to that uncovered at the Abhayagiri Dágoba, in Anurádhapura. The panels between them present a series of historical subjects which I am at present unable to identify. The local pandit conjectures that they are illustrations of the Rámáyana. They are entirely different from the ordinary paintings in most Buddhist temples, as they are purely historical, and not religious; by which I mean that the figures are exclusively human, and not supernatural. Both figures and faces are excellently painted, and full of life; and there is one female face, constantly recurring, which may justly be called beautiful. We may reasonably conclude that all the inner walls of the temple are adorned with similar paintings, which alone would repay the labor of excavation . . .

"A large collection of coins was found just inside the eastern doorway, and has been forwarded to the Hon. Secretary, Royal Asiatic Society, for identification."

Four Buddhist Viháras.—Beyond the Sita Máligáwa was discovered "a

collection of four Buddhist Vihāras, one of which contains four broken but elaborately carved pillars of a unique type. They are interesting because their capitals are decorated with 'Persepolitan leaves,' an ornament which, so far as I know, does not occur elsewhere in either city. There is a large erect statue of Buddha lying between these pillars, and the place would repay excavation."

HINDUSTAN.

Work during the summer.—Mr. A. Rea, First Assistant, Archæological Survey Department, in a report on the work accomplished by his staff from May 19th to July 19th, says:—"During the period under note no field operations have been conducted, the draftsman being solely occupied in finishing up the pencil drawings on hand. A large number of previous seasons' field work is in office. This is being carefully finished in ink, with all speed consistent with artistic workmanship. Forty drawings have been completed and despatched to the Director-General. I have finished my report on the Pallava antiquities of Conjeeveram, and sent it to Dr. Burgess. It includes a sketch of Pallava history; critical dissertation on the characteristics of Pallava architecture and art, with deductions drawn from comparisons of the style, with that of the Seven Pagodas, and various ancient works of the dynasty in other districts, and with Dravidian architecture generally; also a detailed description of the temples and their sculptures. While in Madras, Dr. Burgess received a communication from Colonel Taylor, of Vellore, in reference to an inscribed stone in some fields near Pallavaram. On the 25th May last I despatched a draftsman to make a sketch and, if possible, to copy the inscription. Colonel Oakes, Cantonment Magistrate of Pallavaram, kindly placed a man at our disposal to point out the stone. The draftsman reported that the letters of the stone were so rough that it was impossible to make a copy and that they seemed quite modern. I have communicated with Colonel Taylor to see if there is no mistake in regard to the stone to which he referred. If the inscription was ancient, the stone might be removed to the Museum."

Recent publications.—The last two volumes of *The Archæological Survey of India* contain (vol. XXI.) reports of General Cunningham's tours in 1883-84, and 1884-85, in Central India, when he visited Mahoba, the capital of the old Chandel dynasty in Bundelkhand; and (vol. XXII.) the reports of Mr. Carleylle's tours from 1877 to 1880 in the neighborhood of Gorakpur, where he identified several of the sites traditionally associated with the life of Buddha, notably Ramnagar, or Ramagrama, which was visited by both the Chinese pilgrims Fah Hien and Hwen Tsiang.—*Academy.*

TEMPLE OF SRĪ SAILAM (the "Pigeon Monastery").—A recent visit to the temple of Srī Sailam, made by Dr. Burgess, Director-General of the

Archæological Survey of India, led him to make the important discovery that it was the "Pigeon Monastery" of the Chinese Buddhist pilgrims. We quote, by permission, from his Report to the Government.

"When Fah-hian, the Chinese pilgrim, was at Banáres about the year 400 A. D., he heard of a great monastery, far to the south, built in five storeys, each in the form of a particular animal, an elephant, a tiger, &c., and the uppermost a pigeon. He calls it Po-lo-yu, which he explains as meaning 'Pigeon monastery.' . . . In the seventh century when Hwen-Thsang travelled in India, he tells us that this monastery was built by a former king called So-to-pho-ho (or So-to-pho-han-na), doubtless Sátaváhana, the family title of the Andhra kings who ruled from the second century B. C. to about 200 A. D. It was established as a Bauddha monastery for the sake of Nágárjuna, a great sage and patriarch, whose date I fix approximately in the second-half of the second century A. D. Hwen-Thsang says it was some 300 *li*, or about 60 miles, to the south-west of the country, on the Po-lo-mo-lo-ki-li mountain, which he informs us means 'Black peak.' It may be transliterated into Paramalagiri or Bhramaragiri, but this gives us little help in identifying the place. Not having visited it personally,—for the Brahmans had long before expelled the Buddhists and taken possession of it,—the Chinaman's account of the storeys, galleries, halls, tunnels, and precipices is too exaggerated to be at all probable. But Tibetan books say Nágárjuna died at the great monastery of Dpal-gyi-ri, and this name is only a translation of Srí Parvata or Srí Saila mountain, and thus seems to afford a clue for the identification; for Srí Parvata is the name of the temple dedicated to Mallikárjuna at Srí Sailam on the rocky hill called Rúdragiri over-hanging the Kistna river, about 82 miles E. N. E. from Kurnool. The gigantic causeways and stairs leading from the top of the hill in various directions down to the Kistna, and to various shrines in the gorges among the surrounding hills are undoubtedly of very early date; and the steps are carved with the names of the pilgrims in all characters, ancient and modern. For the Hindu shrine popular tradition claims a great antiquity, and is supported by mention of the place in the *Mahábhárata* (III, 8160); *Susruta* (II, 169, 2); the *Brihat Sanhita* (xvi, 3); *Márkandéya Purána* (v, 19, 16; x, 29, 13); *Kathásaritságara* (65, 66, 73 and 105); and in the *Agni Máteya* and *Síva Puránas*. It is one of the twelve great shrines or *Jyótirlingas* of modern and mediæval Hinduism, but one of the least known and most inaccessible. Perhaps not more than five or six Europeans have ever visited this secluded shrine. The ascent was by great old stairs about 30 feet wide, formed of rough blocks of stone, which lead over all the steep slopes from Nágálutti to Srí Sailam, a distance of 27 miles or thereabouts. At last the temple is reached.

“The temple is in a rectangular enclosure about 630 feet from north to south by 510 feet from east to west, and a slight extension in the west, with gopuras on the other three sides—all of the style of those at Vijayanagar, even to the material—the lower storey being of stone and the upper portions all of brick. This is the more remarkable, as stone is so much more readily procurable on the hill than brick. These gopuras may be at once referred to the early part of the 16th century. The sculptures on the court walls—principally restricted to five courses, the lower of about 32 inches high is carved with figures of elephants in every variety of position; the second course, 26 inches high is carved with horses frequently with female riders; the third, about the same height, with gods and scenes from the modern pantheon, and the remaining two with a variety of mythological figures—have their counterpart in the walls of the Hazára Râma temple at Vijayanagar, executed much in the same style. A comparison of the two at once shows that they belong to the same period, if not to the same workmen. Both on the inside of the walls are similar sculptures and also on blocks irregularly arranged in the four upper courses of the outside. They are all boldly and well cut, and the elephants and horses especially display much action. The temples inside are all mean and insignificant, and, though perhaps a little older than the walls and gopuras, are not greatly so. They are not older than the 15th century, and probably represent the shrines restored after some sudden raid of iconoclastic Muhammadans. They are modest, unpretending buildings dedicated to Mallikârijuna, a form of Siva, and to two females, Pârvatî and Brahmarambhâ or Mâdhavî, to whom a sheep is sacrificed every Tuesday and Friday—a survival of the old bloody sacrifices offered to Durgâ in all her forms. The temple of Mallikârijuna is covered with gilt copper plates, but it and the companion temples are insignificantly small. From the front of the temple enclosure, a double row of corridors, for the accommodation of pilgrims, runs out to the east and is also returned in front of the temple to the southwards, forming another coincidence with the arrangements of the Vijayanagar temples. Inside the court are other corridors, small detached shrines and wells with canopies over them to keep the sunlight from the water. But much of the interior buildings is in a state of ruin and decay. Its day of glory is past. When the great stairs were constructed in every direction from the shrine of Srf Sailam, many a rich gift must have come to its treasury, whether Buddhist or Brahmanical. If the Bauddha shrine were of wood, like the Burmese pagodas, it must have perished early; if of stone, it was perhaps demolished and rebuilt by their successors; but even their great temple was wrecked so completely that no trace of it is now to be seen, and the shrines that occupy its site are scarcely five centuries old. Outside the enclosure of the principal temple are several deserted shrines, but

none bearing distinctive evidence of an age much earlier than that of the central one. A causeway and steep stair to the east descend to the Kistna river and has a gateway and several rest-houses in the course of the descent. At the bottom is a small temple—like all the others—fast going to ruin, which has been carved in a very elaborate and beautiful style, closely resembling the best Tamil work of the 15th and 16th centuries.”

AMRĀVATĪ and JAGGAYAPET.—The Amrāvati Stūpa from which came the famous sculptures now in the British Museum, and which has formed the subject of important studies by the well-known archæologists Burgess and Sewell, is again brought before the public by some important discoveries lately made there by Dr. Burgess. In the first place, its date is fixed as at least as early as the second century A. D., and its identity established by an inscription of the Andhra king Pulumāvi (II cent.), commemorating the gift of “a Dharmachakra to the great Chaitya belonging to the school of the Chaitikāyas.” The Chaityikas and Pūrvasailas were one and the same; and this and other inscriptions prove “that Amrāvati was the site of the great Pūrvasaila Stūpa.”

In the first volume of the *Reports of the Archæological Survey of Southern India*, soon to be published, Dr. Burgess tells of his discovery of some ninety additional sculptures, as well as several Pali inscriptions, one of which was that of Pulumāvi mentioned above. Dr. Burgess also found another similar stūpa at Jaggayapet, not far distant from Amrāvati, the sculptures of which are much more archaic.—*Academy*, Oct. 9.

TEMPLES OF KAMBADUR AND NILGUNDA.—The following extracts are made from the *Report* of Mr. A. Rea, Assistant, Archæological Survey of India, for January and February last: “At Kambadur—about midway between Madakasira and Kalyandrug—there are three temples, all of which are built in the Jaina style. Two are deserted and are being ruined by shrubs; the third is the most ornate, and is in use as a Siva temple. This building is called the ‘Chola’ temple by the villagers. It is, however, not Chola in style, but Chalukyan with a combination of Jaina features not usually found in the other black stone temples I have seen in these districts. It is built partly in granite, and partly in black stone; all the sculptures being in the latter material. A series of sculptured panels on the parapet surrounding the *mahamandapam* are very striking. At first sight they call to mind the Amaravati marbles. They are, however, Jaina, interspersed with *Siva* figures. One figure is shown mounted on a camel, rather an unusual animal in such groups, as far as I have seen. The courtyard is literally strewn with fallen sculptures. This temple is rather an interesting discovery, as, from its architecture, evidence leading to the defining of the districts where we may look for examples of one of the most beautiful periods of art in this portion of the Peninsula. It would lead to

the supposition that the Chalukyan style, so peculiar to Dharwar and Maisur, with its head-quarters at Hallabid in the latter State, had not only extended its influence to the buildings in the taluks bordering the former province on the Tungabhadra river, but had also spread into the Madras districts on the outskirts of Maisur. Should this be so, and there seems reason to believe it will prove correct, we may find the existing examples of this architecture more numerous than hitherto supposed. . . . The temple at Nilgunda is a fine specimen of black stone work, with some beautifully carved panels. It is in a bad state of repair, and covered with growing shrubs. Many of the sculptures are lying on the ground, and others are sure to follow unless the plants can be removed. There are other two temples (in the fort) of the same style but less ornate. The village *patil* is in possession of a set of copperplates. To one who has not seen any of these Chalukyan temples, it is difficult to give an exact idea of what they are like. They are sometimes literally covered with the most delicate ornament; each stone being a work of art by itself. They are as different as possible from the coarse work found in most of the principal temples further south: but, being generally small shrines, the several authorities in charge have not the requisite funds to keep them in repair: the consequence is that the most of those I have seen are fast going to ruin. Most of them are free from whitewash." [*Indian items*, R. Sewell.]

ARABIA.

KARAMANE (Island of).—In this island of the Red Sea, M. Faurot has discovered an inscription of about twenty lines, probably Himyaritic. It is incised in clear but shallow letters, 1 cent. high, on a piece of volcanic stone, which covers a tomb in the mosque of Israki Baba or Salah to the N. of the city.—*Revue Critique*, Sept. 13.

PALESTINE.

JERUSALEM.—*Basilica and tomb.*—Some time since, the Dominican monks undertook excavations, on their property outside the Damascus gate, that resulted in two interesting discoveries. The workmen first came across some fragments of columns, and further investigations disclosed a fine large quadrangular mosaic pavement, evidently that of the nave of some great basilica, on either side of which were found, in place, the bases of a long row of columns. From the position of these ruins it seems evident that they belong to the basilica, famous for its size and beauty, erected to St. Stephen, in the fifth century, by the Empress Eudoxia. At no great distance there was found a large and beautiful rock-cut tomb, in the shape of a hall, with mosaic pavement. On each side of this hall a corridor

leads into a vaulted tomb containing several sarcophagi; and at the further end a larger vaulted chamber is reached, in which is the largest sarcophagus. There are no inscriptions to identify the persons buried here, or to give any indications of the period of the tomb. It has been conjectured that it contained the bodies of Helena, queen of Adiabene, and her sons.—*The Antiquary*, October.

Second wall of the city, tombs and aqueduct.—The fragments of this wall, lately discovered, are described and discussed on pp. 428–29 of this issue, as are also a number of rock-cut tombs and a second aqueduct at the Pool of Siloam.

PHENICIA.

SIDON.—Some natives, excavating for stone, after penetrating through the alluvial soil, had dug through a deposit of blown sand, six metres in depth, below which they found a stratum of earth containing flint implements, fragments of coarse red pottery, and other objects. This shows that the Phœnikian city of Sidon was preceded by an older settlement, whose inhabitants were still in the Stone age.—*Academy*, Aug. 1.

ARMENIA.

VAN.—At the sitting of June 17th of the *Soc. Nat. des Antiquaires de France*, M. Germain Bapst announced that excavations had been made at Van, resulting in the discovery of some monuments of Chaldeo-Assyrian art, the workmanship of which recalls that of the bronze seat obtained from the same place by the Marquis de Vogüé.

ASIA MINOR.

Archæological Mission.—M. Guillaume, of the Institute of France, has been placed in charge of an archæological mission to Greece and Asia Minor.—*Athenæum*, Sept. 25.

Prohibition of excavations.—The report by the Rev. Joseph Hirst on the present condition and future prospects of archæological work in Asia Minor, is very discouraging. At a recent meeting of the Royal Archæological Institute in London was read a letter from him, dated Smyrna, October 25, in which he states that the Turkish Government has withdrawn all permission given to Englishmen and other foreigners to excavate ancient sites within the Sultan's dominions, and also that large quantities of finely sculptured pillars, walls, and stones are being sold and utilized for modern building purposes; and a motion was carried that the Institute should take action, along with other learned societies, in protesting against this act of vandalism.—*N. York Evening Post*, Nov. 18; *The Antiquarian*, Jan. 1887.

BRUSSA.—Mosque.—The Sultan has given orders for the repair, at the expense of \$20,000 from his privy purse, of the ancient mosque and tomb of Sultan Ilderim Bajazet.—*The Antiquarian*, Nov. p. 228.

ASIATIC TERRACOTTAS.—In a late number of the JOURNAL we gave (I, pp. 429-32) long extracts from M. Reinach's interesting letters on terracottas from Asia Minor written especially in view of establishing their falsity. In the last number of the *Revue Archéologique* (1886, II, pp. 93-95), M. Reinach publishes the translation of a note inserted by Kabbadias in the *Archæological Bulletin* of Jan.-Feb. '86, under the title *Antiquities confiscated*. "On the packet-boat of the Fraissinet Company, leaving [Athens] for Marseilles, the custom-house officials of the Peiræus, George Kossaras and Demetrios Kopides, confiscated two boxes containing antiquities that were being sent to Paris . . . The second box contained *two terracotta groups broken into many fragments* but quite complete, with many traces of coloring and gilding [one was of Aphrodite reclining, with three Erotes; the other, a winged Nike leading a bull, preceded by an Eros]. After examination of the clay of which they were made, of their finish and the style of workmanship, it was found that they were falsifications. Neither the manufacturer's nor the possessor's name has been ascertained, though an inquiry has been initiated." In M. Reinach's opinion these terracottas are manufactured in Italy, sent in pieces to Greece, and then shipped from Athens to Paris.

KYPROS.

POLITIKON (near).—Karl Watkins, the Turkish consul at Tarneba, has undertaken near Frankissa (near Politikon), in a hollow (?) three miles in diameter, excavations which have proved the existence here of a Sanctuary of Aphrodite. Have been found, a head of Aphrodite, of Greek workmanship, many earthenware vessels, some beautifully painted, others belonging to the prehistoric period. In the southern section the pavement was uncovered, and the foundations of the altar, as well as some Korinthian capitals, and some bases of statues, were found.—*Δελτίον*, No. 497.

EUROPE.

GREECE.

ATHENS.—New Railway.—The railway from Athens to Patras is in working order as far as Sikyon, and will soon be open to Aigion. By this road the traveller from Athens may reach Eleusis in an hour; an hour more brings him to Megara, and another hour and a half to Korinth. From this point he may reach Sikyon in an hour and three-quarters. By another

branch the tourist may go from Korinth to Nauplia in three hours. This branch brings Nemea, Mykenai, Argos and Tiryns within a manageable distance from Athens. On the other side of Athens, the railway to Laurion renders much more accessible Mt. Pentelikon and the plain of Marathon, as well as the ancient Thorikos and the Temple of Athena at Sunion.—*Athenæum*, June 26.

British School.—The house for the School being completed, it has been opened with Mr. F. C. Penrose as Director for the first year. A meeting of the General Committee and subscribers was held in London Oct. 19. It was reported that the expenses for the building were c. £3,240, "and that £350 would be required for furnishing; leaving some £650, from the original fund, for the foundation of a library and other initial expenses. An annual income of £400 is secured for three years, from various sources. This being considered not only temporary but insufficient, a Managing Committee was appointed to raise a fund for permanent investment. At Professor Norton's suggestion, the Committee resolved to come to an arrangement with the management of the American School, by which the duplication of expensive books for the two libraries may be avoided and coöperation secured in this and other respects.—*Academy*, Oct. 30.

Discoveries on the Akropolis.—Near the Propylæia has been found the bearded bronze head of a man, in the archaic style and more than life-size, reminding of the Aiginetan statues. It is the only bronze head of such size yet found in Greece, being even larger than the later head found at Olympia.

Besides this important piece are to be mentioned a quantity of archaic terracottas with the names of artists; and finally, between the Erechtheion and the Parthenon, foundation-walls which are, according to Dörpfeld, those of the temple of Athena Polias burnt during the Persian war.—*Δελτίον τῆς Ἐστίας*, No. 499 (Aug. 2).

Akropolis.—Excavations on the west side have been carried down to the foundation-walls of the temple: they consist of 24 rows of stones, forming a total height of fourteen feet.—*Δελτίον*, No. 508.

The Delos Statues.—All the statues discovered at Delos by the French School, some of them of great importance, have been transported to Athens and placed in the Central Museum.—*Revue Arch.*, 1886, II, pp. 82–84.

ΒΟΙΩΤΙΑ.—ΑΚΡΑΙΦΙΑ=ΠΕΡΙΔΙΚΟΥΡΥΣΙ.—*Temple of Apollon Ptoos.*—The important archaic statues and heads in bronze and marble, together with statuettes, inscriptions and fragments of vases and figurines in terracotta, found here by the French School, and already described in previous numbers of our Journal, have been transported to Athens and placed in the Central Museum. Other objects have been placed in the convent of Pelagia, near the place of discovery.—S. REINACH in *Revue Arch.* 1886, II, p. 80.

The excavations carried on here by the French School have been brought to a close. Lately, an important aqueduct was found near the sanctuary, a symmetrical construction in tufa, 25 met. high, 2½ wide, and 5½ in thickness, divided into seven reservoirs. Near it were found the heads of three statues, one of marble and two of tufa.—*Δελτίον*, No. 496.

DELOS.—The results of the late excavations have been the discovery of (1), in the "Halle der Stiere," 13 square bases without inscriptions; (2) in the Artemision, 8 votive inscriptions, 23 decrees of proxeny, 14 fragmentary inscriptions of between 20 and 40 lines, a long inscription of 164 lines, a male bust and a colossal hand; (3) near the sanctuary, three archaic statues of Apollon, well preserved; (4) in the hall of Philippos, six bases without inscriptions. Near the "Kalybakia" the Palaistra has been uncovered, and this has led to the discovery of a number of inscriptions, of slabs and benches; also two female and three male heads.—*Δελτίον*, No. 511.

EPIDAUROS.—The excavations here have been recommenced under the direction of D. Philios on the site of the temple of Asklepios. At the very beginning, fourteen statues and many inscriptions were brought to light. Among the former may be mentioned three fine statues of Asklepios, three athletes, eight heads, one of Athena of excellent execution. Later, were found others of importance, especially a life-size statue of Aphrodite Geneiteira, similar in many points to that in the Louvre, and a careful copy of a Hellenistic work; also a headless life-size Hygieia of the best period; and a second, also headless, statue of Athena, of medium size.—*Δελτίον*, Nos. 496, 501.

ERETRIA.—*The pillar-statue* of a young man, half life-size has been found. It dates from the Roman period, but its workmanship is excellent and its preservation perfect. The physiognomy resembles that of Hermes.—*Δελτίον*, No. 504 (Sept. 6).

KRETE.—*Cave of Zeus*.—Excavations have been made by M. F. Halbherr and Dr. J. Chatzidakis in a Kretan cavern, which passes for the Diktaean cave where Zeus was born. Before the cavern is a terrace on which is a smoothed piece of rock which perhaps served as an altar. The cavern is divided into an outer cave, 25 m. long by 15 m. broad by 5 m. high, and an inner cave, 85 m. long by 20 m. broad by 12 m. high. The few objects found are evidently remains of sacrifices.

The excavations which Schliemann wished to undertake here have been prevented. He wished to excavate a mound on the site of the ancient Knossos, but the owners refused to allow him, unless he purchased the whole property—*i. e.*, about the entire site of Knossos—for several thousand pounds.—*Athenæum*, Oct. 2, 16.

LARISSA.—In throwing down the foundations of a house near the new

market, there was found an ancient wall of large tufa blocks between one and two metres high and four wide: it is thought to belong to the akropolis.—*Δελτίον*, Nos. 508, 511.

OLYMPIA.—*The Leonidaion and the "Festthor."*—The so-called "South-west building" at Olympia has been discovered to be built by Leonidas son of Leotos, and hence must be identified, as conjectured in 1882 by Bötticher, with the Leonidaion. It is by far the largest construction yet found, and can have been surpassed only by the great Gymnasion, of which only a portion has yet been excavated. Its dimensions are 81.20 by 74.51 met.; and it covers three times the space of the temple of Zeus. The "Festthor," or rather *πομπική είσοδος*, was placed, together with the Leonidaion, in the S. W. of the Altis: it is relatively small, having three openings, each 1.30 met. wide, which admit six men abreast. These identifications are important for the route of the procession and for the understanding of Pausanias' text.—*Berl. phil. Woch.* Dec. 4.

The Recent Earthquake caused considerable damage here: four columns of the Byzantine church fell down, shattering many antiquities: in the Palaistra, also, two columns were overthrown. Fortunately, the collections did not suffer.—*Δελτίον*, No. 504.

ΟΡΟΠΟΣ.—*Sanctuary of Amphiaraios.*—The excavations directed here by the Archæological Society of Athens have been recommenced under B. Leonardos. First, the theatre was uncovered, showing it to be a hall supported by ten Doric columns. The seats have also been partly laid bare, and one was found to bear the name of Nikon, priest of Amphiaraios: a stele, bearing a figure of good art, had the name of a hitherto unknown sculptor, Strombychos of Athens.—*Δελτίον*, No. 504.

PEIRAIÆUS.—The discovery has been made at the Peiræus of a vaulted subterranean building, which apparently served the purpose of a reservoir. Its area is stated to be 14.30 sq. met.; and the depth, so far as excavated, 16 met. It is approached by eight steps hewn out of the rock. The vault is supported by four columns, three hewn out and one built up.—*Δελτίον*, No. 493. Cf. *Berl. phil. Woch.* July 10. •

SAMOS.—Mr. J. Theodore Bent, in his recent excavations at the site of the old town of Samos, took new and more accurate measurements of the wonderful aqueduct of Eupalinos. These measurements may be compared with those given by Herodotos III, 60.—*Athenæum*, June 12.

ITALY.

PREHISTORIC AND CLASSICAL ANTIQUITIES.

ARENE CANDIDE (Cavern of) (Liguria).—*Prehistoric antiquities.*—Researches and excavations had been undertaken here with success as far

back as 1877 by Sig. Issel, and later by Dr. Wall: lately Don Morelli has continued them, and has enriched his prehistoric collection with many objects, worked and unworked, in bone, shell, stone and terracotta.—*Bull. di Palet. Ital.* 1886, No. 7-8.

CHIUSI.—*Tomb.*—In a *tomba a camera* recently opened was found on the tufa bench, along the front, a polychromic terracotta sarcophagus similar to that of *Seianti Viliania* in the Museum of Florence. The inscription shows it to contain the body of a woman, belonging to the same family: *Seianti Thanunia*, whose reclining figure is carved on the cover. The carving in the Chiusi sarcophagus is far superior, and the coloring simpler. *Seianti Thanunia* is represented as a comely middle-aged matron of the Juno type. The decoration of the body of the sarcophagus is similar to the Florentine sarcophagus.—*Bull. d. Istituto*, 1886, pp. 217-19.

CORCHIANO.—This village situated near Civita Castellana (Falleri), evidently occupies the site of the arx of an Etruscan city: on the W. side, where the rocky descent was least steep, a wall was raised, parts of which still exist and are to be referred to the V or VI cent. B. C. Near the second and outer ditch were found two rows of tombs, facing each other, quite well preserved: their plan is a rectangular chamber preceded by a small vestibule with a door closed by a slab. The length of the tombs is determined by the number of loculi. There were traces of successive burials, and of the probable removal, on these occasions, of the objects belonging to the previous entombment. The usual variety of ornaments and of vases were found.—*Not. d. Scavi*, 1886, pp. 152-56.

FAESULAE=FIESOLE.—*Etruscan Tomb.*—Under the Etruscan walls of Fiesole has been found a tomb, the first one of its kind and form in Etruria. It is a small subterranean chamber 2.15 met. square, and 2 met. high. The rectangular door is closed by a single immense stone. Near the door rises, on a broad square base, a colonnette 1.30 met. high; this is here met with for the first time, though we know from Servius' (*Æn.* VIII, 664) words, *columnae mortuis nobilibus superponuntur*, that it was a mark of distinction. The construction is in large masses of tufa carefully chiselled and accurately joined without cement, forming one of the finest constructions of the Etrusco-Roman period.—*Not. d. Scavi*, 1886, pp. 220-21.

GROSSETO (near).—*Etruscan Tomb.*—In May a fine tomb was opened and found to contain quite a collection of vases of all forms and dimensions, belonging to the Etruscan period.—*Bull. d. Istituto*, 1886, pp. 91-93.

MARZABOTTO.—*Etruscan Museum.*—At this village, near Bologna, there has been organized, by Count Aria, an important Etruscan Museum composed of architectural remains and of several thousand objects found during many years excavations in the tombs of this locality. The tombs themselves have been preserved in their original condition.—*Cour. de l'Art*, Dec. 24.

MILAN.—*Necropolis*.—The important discovery has been made at Milan by Prof. Castelfranco of a necropolis belonging to several periods. The first stratum of cinerary urns with their contents, discovered about two metres below the surface, belongs to the Roman period, and probably to the second century of our era. The second stratum belongs to the Gallic period, and antedates the first by several centuries. There are indications that at a greater depth a third, Ligurio-Etruscan, stratum will be found by the excavators, which would be of the utmost importance for the history of Milan.—*Moniteur de Rome*, Dec. 4.

OSTIA.—This city, which was inhabited and full of monuments down to the IX century, was then abandoned on account of the incursions of the Arabs, and its monuments were not overthrown but simply fell into decay. A systematic excavation of the ruins had never been attempted until lately under Prof. Lanciani. Since the recent completion of the excavation of the Theatre and the adjacent *scholae* of various groups of operatives, the chief aim of the explorers during the season 1885–86 has been to unite this group of buildings with the famous temple of Vulcan, distant 202 met. About a half of this distance has been excavated in every direction, and 4818 square metres of the ancient city were uncovered. There have been found—besides a street, a square, and a public *piscina*—four small temples, and a handsome house containing, among its various rooms, a *Mithraeum* of very singular construction. (A) An important mansion, the *domus*, perhaps, of L. Apuleius Marcellus; it is in a line with the four temples, and has a shop close to the entrance door: the owner was probably a wholesale *mercator frumentarius*. There is mosaic decoration on the floors, and frescoing on the walls. Its spacious atrium has eight columns with its impluvium in the centre. (B) Of far greater importance is the *Mithraeum* of this house, one of the best-preserved and finest known: its pavement, benches and walls are almost entirely covered with mosaics, in which the figures, all of perfect design, are in black on a white ground. Among the figures are, the two lamp-bearers, the six planets (Moon, Mercury, Jove, Saturn, Mars, Venus) and the twelve constellations. (C) Four tetrastyle temples, identical in size and arrangement, built on a continuous platform, which were converted to other purposes at some recent period and much damaged. The platform is of tufa with a cornice of tufa blocks. The walls of the cella and the six columns of each *pronaos* were also of travertine. (D) The building to the W. of the house and temples was probably a tannery. (E) The square which opens up in front of the temples was never paved, and is not very early, having been opened, probably toward the middle or end of the first century, by demolishing an entire square of Republican constructions. (F) The public *piscina*, with its

buttressed tufa walls of *opus quadratum*, on the W. side of the street, was surrounded by granaries constructed in Imperial times.

The small objects found during the excavations are of minor interest, the ground having been already explored at a previous period.—*Athenæum*, Oct. 30; *Not. d. Scavi*, 1886, p. 162 *sqq.*

PERUGIA.—In the suburban property called the "Frontone," several tombs were opened in May and June, whose contents are of considerable interest. In a chamber measuring 2.66 by 2.47 met., the tomb of a warrior, were found: an archaic object in bronze similar to a candlestick, but in reality the first instance recognized of the game called *kottabos*; the statuette of a veiled sacrificing Genius, forming the handle of a bronze cover; a bronze helmet bearing on the apex two elegantly modelled archaic groups in relief of winged horses led by a youth; a fine painted krater (containing many objects in bronze) covered with figures; parts of a metal cuirass; *etc.*: the objects in both these tombs belong to the v cent. B. C. In a tomb, a *fossa*, was a numerous collection of arms of every description, including a complete set of bronze armor. A third contained the perfect skeleton of a young woman with earrings, rings, armlets, spindle, mirror, *etc.*—*Not. d. Scavi*, pp. 221–24; *Bull. d. Istituto*, 1886, pp. 220–28.

POMPEII.—*Street of Tombs.*—From Sept. 14 until now, work has been going on to clear the new 'Street of Tombs' on the road to Nocera. Its importance can easily be estimated from the little that has been uncovered. Four monuments have been found on one side, and three on the other: they are simple, being cubic in form, built of brick covered with stucco and partly ornamented with columns and niches in sandstone. Inscriptions and coins give the approximate dates of the tombs, which probably belong to the time of Augustus. Several marble statues, well-preserved portrait-figures with considerable remains of painting, were found over the tombs. Of especial interest are the many inscriptions either painted in red on the tombs or scratched in the stucco by travellers on the road to Nocera.—*Not. d. Scavi*, pp. 334–37; *Berl. phil. Woch.* Nov. 20.

PORTO.—*Temple of Sarapis.*—The following Greek inscription incised on a marble column has been found here: *Διὶ Ἡλίῳ μεγάλῳ | Σ(αρ)άπιδι καὶ τοῖς | συ(ν)νάοις θεοῖς | τὸν θεοφιλέστατον | πα(τ)ρίῳ Μ[άρκῳ] Αὐρ[ηλίου] | Σαρ(α)πίων παλαιστῆς | παράδοξος σὺν τῷ | πατρὶ Μ[άρκῳ] Αὐρ[ηλίου] Δη(μ)η- τρίῳ | τῷ κ(α)ὶ (Ἀ)ρροκρα(τ)ίῳ | βυ(σ)λευτῇ τῆς λαμ-προτάτης πόλεως | τῶν Ἀλεξανδρέων | εὐξάμενοι καὶ εὐ|τυχόντες ἀνεθήκα-|μεν ἐπ' ἀγαθῶ. It is a dedication "to Zeus-Sol the great Sarapis and to the companion gods" by M. Aurelius Sarapion and his father. It was known already that a sanctuary to Sarapis existed in Porto, where his worship was as fashionable as that of Isis at Ostia; but now for the first time we are certain of the title under which he was worshipped. The expression *καὶ τοῖς συννάοις θεοῖς* = *diis-**

que contubernalibus, is a new and interesting proof of the worship of secondary divinities in this shrine.—*Bull. d. Comm. arch. di Roma*, June.

REGGIO (Calabria).—*Archaic terracottas*.—Prof. Barnabei calls attention to several interesting lots both of terracotta votive figures and of fragments of figured architectural decoration which prove the existence on this site of a temple built in the best early period of Reggian history.—*Not. d. Scavi*, pp. 241–45.

Roman Baths.—The demolition of the Tower of S. Matteo brought to light numerous remains of a Roman bath of considerable extent, including columns, fragments of frescos, mosaic pavements, and the entire ground-plan.—*Arte e Storia*, Dec. 5.

REMEDELLO (near Brescia).—*Tombs*.—The interesting tombs discovered in this locality (*cf. JOURNAL*, II, p. 89) belong to four different epochs and peoples: Pelasgic, Etruscan, Gallic and Roman. Four tombs, containing objects of especial interest, were opened in February, and two, belonging to the Pelasgic or eneolithic period, were transported intact, with all their contents, to the museum of Brescia. Sig. Ruzzenenti, the excavator, describes this important site as containing two necropoli, at a distance of about 50 met. from each other, the Gallic being north of the Pelasgic; and the tombs in the former being 0.40 to 1.20, and in the latter 1.60, met. below the surface. In the space between the necropoli many vases have been found. According to Prof. Castelfranco, the Gallic tombs (twelve in all) belong to a period between the v and the i cent. B. C.; and the majority contained arms of types found beyond the Alps, in Switzerland and France. He also remarks, "it is a curious fact that, while in the Valsassina the Gallic tombs with arms do not contain any ornaments, at Remedello, on the contrary, it is these tombs that furnish the greater number of fibulae." Another difference between the tombs of the Valsassina and those of the Milanese province on the one side and that of Brescia on the other, is that in the former incineration is the rule; while in the latter the rite is mixed, those tombs with unburnt bodies recalling the Gallic tombs in the province of Bologna. Other interesting details are brought out by a study of the contents of these tombs.—*Bull. di Palet. Ital.* 1886, Nos. 7–8, 11–12: *Comment. dell'Ateneo di Brescia*, 1886, pp. 79–81, 255–61.

ROME.—*Topography*.—Among the many points in Roman topography raised by the recent discoveries, none are of greater interest than those grouped about the House of the Vestals. The identity of the Regia with some ruins behind the temple of Julius has just been proposed in the *Bullettino* by Mr. Nichols; and Jordan's interesting researches on the temple and atrium of Vesta have been embodied in a large volume (*Der Tempel der Vesta und das Haus der Vestalinnen in Rom*: Berlin, 1886). The question of the direction of the ancient Via Sacra is also one that is pre-

occupying all Roman archæologists. Excavations undertaken in April, under the direction of Herr Jordan, prove that the Via Sacra did not, as was supposed, pass before the atrium and temple of Vesta, and (following Mr. Nichols' suggestions) that the ruins between there and the Temple of Faustina, must undoubtedly be considered to be the Regia.—*Bull. d. Istituto*, 1886, No. 1.

Pons Aemilius.—In constructing the walls along the bank of the Tiber, on the Trastevere side, was found the head of the ancient Aemilian or Palatine bridge, well built in *opus quadratum* with blocks of tufa. Near it came to light a fine portrait-bust of Julia, daughter of Titus.—*Bull. d. Comm. arch.* Nov.

Fratres Arvales.—An important fragment of an act of the *Fratres Arvales* of the year 145 A. D. has come to light opposite the basilica of San Lorenzo.—*Bull. d. Comm. arch.* Nov.

Monument of Menander.—Outside the Porta Salaria, about 60 met. from the present city-walls, have been found the remains of a grandiose monument of semicircular form built of large parallelepipeds of tufa crowned by slabs of peperino. The inscription, found in twenty pieces, reads [M]IVNIVS · M · L · MENANDER | SCR · LIBR · AED · CVR · PRINCEPS | ET · Q | [V]IVNIA · M · L · CALLISTE | IVNIA · O · L · SOPHIE.—*Bull. d. Comm. arch.* Nov.

Tombs outside the Porta Salaria.—An immense number of tombs are being continually unearthed on the Via Salaria: they had all been despoiled, but several hundred inscriptions have come to light. Under one an archaic tomb was found. In one chamber the end-wall was decorated with mosaics, and it contained many intact cinerary urns.—*Bull. d. Comm. arch.* Aug., Sept., Oct., Nov.

Mausoleum of the Lucilii.—In this Journal of last year (vol. I, p. 444) an account was given of the discovery of a grandiose circular mausoleum. Since then it has been completely excavated. On the side opposite the inscription was found a door leading into the cella, 2.65 by 1.60 met., covered with stucco above and on the sides. A vaulted corridor 11 met. long, paved with travertine and adorned with a frieze of stuccos in relief, leads to the nearly square cella (3.70 by 2.55 met.) whose four projecting angles support the vault. The cell was transformed into a small cemetery in the IV century and despoiled of all its original contents. A descent leads to another corridor below, also used for cemeterial purposes. Several hundred years ago the monument was entered and pillaged. Two finely executed and characteristic portrait-busts which escaped the spoilers seem to represent those to whom the mausoleum was erected, M. Lucilius Paetus and his sister Lucilia Polla.—*Bull. d. Comm. arch.* July.

Basilical hall.—At the corner of the Via Santa Maria Maggiore and Via Quattro Cantoni, was lately discovered a hall of an almost basilical type

with reticulated walls and an apse decorated with an immense stucco-shell in high relief, and with ornamental paintings in bright colors on a white ground. Since then, on a slightly lower level, the workmen came upon the right-wall of a small chamber whose vault was entirely covered with the finest stucco-work. The lower part is painted red with an outer green and white band. Above is an elegant stucco-frieze with terminal hermæ, vases and other utensils, which is surmounted by a cornice that supports the barrel-vault, on the remaining part of which are squares containing fantastic animals and varied decorative groups. In the free spaces are winged sphinxes, genii in boats, and fishes in the sea. All these stuccos are executed in the best style of the Augustan age.

Hall with rustic mosaics.—In the Gardens of Sallust (Villa Spithöver) there have come to light several ruins which seem to have been used as baths. Of greatest interest is a subterranean hall (7 by 3.94 met.) whose walls and vault were entirely covered with a kind of rustic mosaic-work formed of irregular bits of painted marble, intermingled with shells. About two-thirds of the vault-mosaic remain: it consists of circular or square compartments containing single figures, compositions, landscapes, animal and flower scenes. These are surrounded by an elegant decorative framework of great variety of design. Unfortunately, the site, being 17 met. below the present level, has been filled in by the new constructions; but not before Sig. Gius. Spithöver had caused an exact colored drawing to be made of the entire mosaic.—*Bull. d. Comm. arch.* Oct.

Baths of Constantine.—On the site of the new building of the National Bank on the Quirinal, close to the Via Nazionale, has been discovered the south-east corner of the Baths of Constantine. The foundation-walls contain fragments of architectonic marbles, evidently belonging to more ancient buildings. *Pavement.*—Along the southern side of the Baths was discovered the pavement of an ancient Roman street, separating the Baths from various private houses on the slope of the hill opposite. *Pistrinum.*—On the higher level are the relics of a *pistrinum*, a vast establishment for the grinding of corn and baking of bread, the floor of which is paved with huge polygonal stones. *House of Tiberius Julius Frugi.*—On the lower level have been unearthed magnificent remains of an ancient and noble house, which belonged to Tiberius Julius Frugi, pro-Magister of the College of the *Fratres Arvales*. It is composed of various rooms of different sizes, the best preserved of which is the nymphæum. The left-wall of this room was ornamented with simply decorative paintings; in a niche in the end-wall was painted a figure, probably Aesculapius; below the niche, Pegasus and the fountain of Hippokrene, beside which stand some nymphs, each of whom has also a nimbus around her head: though faded, they are assignable to the second half of the III century.—*Athenæum*, Oct. 9.

Pantheon.—In laying bare the wall of the chapel which is to contain the tomb of King Vittorio Emmanuele, there have been found traces of paintings, but so defaced that it is impossible to recognize their subjects. They seem to belong to the Imperial period.—*Mon. de Rome*, Nov. 18.

Artists' Signatures.—Near the *Sette Sale* a number of inscriptions with artists' names have been recently found on plinths originally belonging to statues, from which they have been separated. Several belong to artists from Aphrodisias,—Flavius Zeno (4), Flavius Chryseros (4), Polineikes, Flavius Andronicus, etc. Anaximander seems to be anterior to the Flavii. Of the Aphrodisian artists, Flavius Zeno seems the earliest from the style both of his inscriptions and of the few fragments of sculpture attached to his plinths. Many pieces of sculpture were found with the inscriptions, and doubtless belonged to the statues and reliefs of the above-mentioned artists. Evidently, the school of Aphrodisias was established in Rome in the second century, and enjoyed considerable reputation from that time to the fourth century. The work of putting together the fragments of sculpture is being carried on, and among others there has been reconstructed a fine life-sized statue of Neptune signed by *Flavius Chryseros*, of all the greater interest on account of the rarity of statues of this divinity.—*Bull. d. Comm. arch.* Sept., Oct.

Statues of Diana and a Spartan Girl.—Among the best works in marble recently found are the fragments of these two statues: (1) The trunk of a statue of Diana, more than life-size, of the same type as the Diana of Versailles called the *Diane à la biche*, differing only slightly in the arrangement of the drapery: the art is of the best. (2) A headless statue of life-size, in Greek marble (also without the arms and lower part of limbs) representing, probably, a Spartan girl racing in the stadion (tav. XIV–XV). It belongs to a more advanced and elegant period of art than the similar figure in the *Galleria dei Candelabri*, which is severe and archaistic.—*Bull. d. Comm. arch.* Aug., Nov.

Statue of Antinoüs.—On the Quirinal, in digging for the foundation of the new National Bank building, was found a remarkable statue of Greek marble, in good style and excellent preservation, a little larger than life-size. It represents Antinoüs under the form of Bacchus. It is entirely nude, and the left leg rests against a vine stem, while in the left arm was placed the thyrsus. Evidently, the statue was not executed in Rome. At some early date the statue had evidently lain immersed in water for several centuries: during the Middle Ages or the Renaissance it was rescued, and was scraped and scoured so as to renew its beauty.—*Athenæum*, Oct. 9; *Bull. d. Comm. arch.* June.

Statue of Mercury.—Fragments of this statue, found in *Via Larga*, in May, show it to be slightly above life-size, and of the same type as the well-known Belvedere Mercury.—*Bull. d. Comm. arch.* June.

Marble Krater.—Many fragments have come to light of a vase or krater of Greek marble adorned with a sacrificial scene in relief by some Attic artist at the beginning of the Imperial period. The work is of great beauty. It is to be compared with the vases of Sosibios and Salpion (Overbeck, *Plastik*, 395–96) and to that of Pontios already published in the *Bull. d. Comm. arch.* (1885, tav. XII–XIII), in whose October number the fragments of our vase are described, and one of them reproduced on PL. XIII.

Cylindrical altar.—On PL. X of the *Bull. d. Comm. arch.* (Sept.) are reproduced the charming reliefs on the cylindrical altar found in the *Orti Sallustiani*. They consist of four amorini bearing the emblems of the four seasons, and separated by elegant balusters, each surmounted by a vase, which support flowing drapery. The beauty of the style refers it to the time of Hadrian.

Tripod-base.—Though much injured, this triangular altar or rather tripod-base is of considerable interest, being analogous to the rare one now in the Louvre (Clarac, *Musée de Sculp.* p. 216, n. 318). The reliefs represent (1) Apollo's tripod between laurel branches, (2) an eagle flying over a wreath of wheat, (3) a priest (*quindecimvir*) sacrificing.—*Bull. d. Comm. arch.* July (PL. VIII).

Sculpture.—In July a number of pieces of good sculpture were found: (1) a graceful alto-relievo of Cupid sleeping with the spoils of Hercules; (2) a statuette of the youthful Bacchus; (3) ten life-size heads, mostly of divinities; (4) a circular altar; (5) a fine torso of Diana; (6) a running maiden. The last three are described separately on this and the preceding page.—*Bull. d. Comm. arch.* Aug.

Statue of Bacchus.—Under the bridge *alla Regola* the dredgers brought up a bronze statue of Bacchus with ivory eyes and an aureole of silver and copper.

Ex-votos to Aesculapius.—Near the Island of the Tiber there has been found a large collection of terracotta *ex-votos* to Aesculapius to whom the island was dedicated and where his principal temple was erected.

Roman Dock.—On the Trastevere bank near the wall of the *Giardino di Donna Olimpia a Santa-Maria-in-Cappella* workmen have uncovered a Roman dock. In the wall are enormous blocks of travertine carved with lion-heads through which the cables were passed.—*Mon. de Rome*, Oct. 8.

SIENA.—*The Three Graces.*—On the occasion of the discovery in Rome (JOURNAL, II, p. 223) of a replica of the well-known group of the Three Graces, Comm. de Rossi announces his discovery of the origin of the most famous copy of this group, that of Siena (*Opera del Duomo*). In the collection of inscriptions of Fra Giocondo (end xv cent.) and in a Siennese ms. he finds that, before coming into the possession of Card. Fr. Piccolomini who took them to Siena, the group belonged to Cardinal Colonna; and that

it was found (middle xv cent.) in the Colonna gardens on the Quirinal, on the very site where the two famous bronze statues were recently discovered.—*Bull. d. Comm. arch.* Oct.

SPOLETO.—*Polygonal wall.*—Under and near the church of S. Alò, Sig. Sordini has discovered quite a stretch of finely-built polygonal wall. It corresponds exactly to the old city-wall, and is situated just within it. It formed, probably, part of a sort of internal bastion, such as we find at Ferentino.—*Bull. d. Istituto*, 1886, p. 245.

TODI.—*Tomb of a woman.*—On Sept. 25, a most interesting discovery was made here, outside the Porta Fratta on property of the brothers Orsini: it was that of the tomb, a *fossa*, of a woman of rank, which will henceforth occupy, for a knowledge of the Italic civilization of the III cent. B. C., a position analogous to that of the Regulini-Galassi tomb for that of the VI century. Many gold, bronze, and terracotta ornaments were found in a remarkable state of completeness near the remains of a wooden coffer, to which belonged six leaden griffin-heads. On a large gold ring some 14 or 15 letters are inscribed. The style of the vases and bronzes shows that they belong to the III century before the Christian era. "The cranium of the woman has been placed among the rest of the treasures found, and has the usual very low forehead of the Etruscan type." Among about forty objects Mr. Mercer and Prof. Henzen describe the following:—(1) Earrings 4 or 5 inches in length (equalled in size only by two pairs, in the British Museum and in Perugia) each having a female head and three delicate chains suspending tassels, all of fine gold: (2) a bronze candelabrum (or *thymiaterion*) supported on three seated winged female figures with arms extended; above, upon a wheel ornamented with four inverted fleurs-de-lis, stands a long-tailed satyr with head erect and widely stretched legs, holding a basin in which he is rolling two balls; half-way up the stem is a winged female figure; and surmounting the whole is a square reservoir bearing on each angle a swan in repose: (3) a statuette of Seilenos, standing with legs crossed: (4) a youthful Bacchus standing on a triangular base: (5) a small terracotta vase having on its summit a male and female head back to back. Among the gold ornaments are: "the above-named massive signet-ring, which has two full-length figures impressed on it, and a star over all." "A brooch adorned with a female head. A beautiful medallion (to which a triple chain of gold similar to Genoese filagree-work was attached) with an onyx-stone centre." Two rings, one plain, the other with a revolving onyx. "Twenty large gold buttons, half of them ornamented with a head, and the rest with a star. Two hundred pieces of gold, in equalized fragments, which had formed a long chain, and broken loose from the filament on which they were strung, having originally belonged to a necklace." Leaving undescribed a number of other objects in bronze, we will

pass to the terracottas. These belong to three classes: (1) very inferior productions of an Italian manufacture; (2) Etruscan products of better style; (3) works of Campanian art, best represented by two magnificent painted *orci* with the finest black varnish.—WILLIAM MERCER in *Academy*, Oct. 16; Prof. HENZEN in *Bull. d. Istituto*, 1886, pp. 228–241.

TARQUINII=CORNETO.—The excavations undertaken here between December and April were on two sites: (1) on the W. side, 400 met. from the *Arcatelle*, and (2), after March 22, near the *Secondi Archi*. Prof. Helbig does not enlarge on the early excavations on the first site, as the daily reports were not drawn up with sufficient accuracy. Of the results of the work after February 23 he declares a detailed report superfluous, as the contents of the tombs were identical with those found in the excavations of 1884–85 (see *JOURNAL*, I, p. 440; II, p. 91). Of greater interest was the work at the *Secondi Archi*. In one of the already devastated *tombe a camera* was found a carnelian scarab with a fine intaglio semi-Shemitic with Egyptian reminiscences, probably a Phoinikian product. In another was a unique terracotta box in the form of an irregular parallelepiped, resting on four low feet, adorned on all four sides with paintings on a white ground. Prof. Helbig compares them to the frescos of the *Tomba delle Bighe*. Being found in the same tomb with late black-figured Attic vases is further proof that this archaic stage of decoration was contemporaneous with the decadence of Attic vase-painting of the black-figured period, a fact which Professor Helbig considers important for the chronology of Etruscan art. The usual varieties of *tombe a pozzo*, *a camera*, and *a buco* were opened.—*Bull. d. Istituto*, 1886, pp. 84–90.

NEOROPOLI OF THE VALSASSINA.—In the last two numbers of the *Bullettino di Paletnologia Italiana* (Nos. 9–12, pp. 194, 228) Prof. Castelfranco has given a brief account of a most interesting but almost entirely unknown group of necropoli of the Liguro-Gallic and Gallo-Roman periods, in the district of Valsassina in North Italy. That of Intronobio is the more important: there are others at Ballabio, Piazzolo, Casargo, Pagnona, Esino and Pasturo. All the discoveries in these localities seem to have been made within the last few years. Other localities enumerated are, S. Pietro di Stabio, Legnano, Vizzola, Caravaggio, Bosco Stretto, Guzzetta, Pombia, S. Stefano, Mezzano, Magenta and Garbagnate: most of these are in the province of Milan, and the necropolis of Magenta is of the utmost importance. To this list of eighteen, of which he gives some details, Prof. Castelfranco adds the names of several others, bringing the total up to thirty-four, all of which he attributes to the Gauls, saying: “Although the greater part of the tombs of these necropoli were excavated at a time when the Romans had already established themselves on both banks of the Po, still the funerary rites certainly remained those of the preëxisting population,

and therefore the contents of the tombs are Ligurian or Gallic. A radical difference to be noted is that, in the necropoli of the Transpadana, burial is by *incineration*, in those of the Bolognese province by *inhumation*." The conclusions drawn by Prof. Castelfranco from a careful comparative study, and limited to the region north of the Po, are: "(1) As early as the earliest invasions (I now admit many more than two) the Gallic element begins to make itself felt, almost imperceptibly, on the left bank of the Po, among the Ligurians of the second period of Golasecca, in several of the tombs of that necropolis belonging to the 1st iron age. It also appears in the same manner in some tombs of contemporary necropoli in the provinces of Como and Este. (2) In the more recent invasions the Gauls brought with them the greater part of the elements that constitute the civilization, so-called, of *la Tène*, and little by little obtain the mastery over preëxisting civilizations. Proofs for this period are found in the necropoli of the Valsassina, of Esino, Mezzano, of Magenta and others, which bring us down to the period of the Roman dominion, under which Liguro-Gallic customs last for a considerable period."

VARESE (Lake of).—*Prehistoric Museum on the Isola Virginia*.—The lacustrine stations discovered on the lake of Varese, in 1863, have enriched many museums; but the discoveries of prehistoric antiquities, made in 1885, on the *Isola Virginia*, in this lake, suggested to Cav. Andrea Ponti the formation there of a museum, now called the *Museo Ponti*. The island itself is an artificial elevation on a vast *palafitta*, the abode of prehistoric man. The museum contains the greatest variety of objects carefully classified, and the island is without doubt the most important prehistoric station of North Italy.—I. REGAZZONI in *Archivio Storico Lombardo*, 1886, pp. 968–77.

VETULONIA.—*New discoveries in the necropolis*.—During this Spring the inspector Sig. Falchi has undertaken excavations the results of which far surpass in importance those of any other years (*cf.* JOURNAL, I, p. 447; II, p. 92). All the finds have been stored in the warehouses of the R. Archæological Museum in Florence, and are to be arranged for exhibition in a hall which is to be called the Vetulonia hall. Universal interest has been excited in one of the discoveries made: the great tomb called the *Tomb of the Warrior*, which fully equals in importance the well-known tomb of the same name at Tarquinii=Corneto, and others at Caere=Cerveteri and Tarquinii=Corneto. Accounts of the two large necropoli of *Poggio alla Guardia* and *Colle Baroncio* have already been given in our Journal (I, p. 447; II, p. 92). The tombs found were generally uniform in type, being well-tombs of the *Villanova* class; and a large number of them have been opened during this Spring, adding considerably to the rich collection of Vetulonian antiquities now in Florence.

The Tomb of the Warrior was of peculiar shape. A large circle of stone

surrounded it, which Sig. Falchi considers to have formed the boundary of the space devoted to the deceased. [Two other circles were found in immediate contact with the above, but did not yield anything of interest.] Instead of a single cell within this stone circle there were found five different tombs or simple loculi dug in the friable rock at depths between 0.90 and 2.70 met., covering a space 11.50 met. long. One was quite empty; two still preserved their deposits placed within enormous hemispherical basins of bronze plate (80 cent. in diam.). In a third, on the contrary, the ashes were placed in a rectangular wooden coffer, lined with silver plate with sphinxes in relief: the coffer is unfortunately much damaged. This tomb, evidently belonging to a warrior, contained also, besides a mass of minor objects, the following: a bronze lance; iron paalstabs; a short iron sword; horse-bits; a simple candelabrum surmounted by a cast figurine; a large globular vase in bronze plate; superb *bucchero* vases, one with a long inscription, another with remains of gilding; a small vase of electrum, semi-oval in shape, engraved with sphinxes of most delicate workmanship. In the same group was a large, badly-preserved shield, a bronze helmet, and a number of candelabra, vases and bronzes of secondary importance. At a later date, two most interesting objects were discovered in the above tomb—a bark and an ossuary. The bark is in massive cast bronze, of perfect preservation, and, though more than 2500 years old, might still serve as a model in a ship-yard. A numerous crew is arrayed on deck, nearly all turned towards the prow. On the poop is a staging on which stands a mysterious helmeted figure, behind which rises a large-antlered stag-head, like a trophy, bound to the poop with ropes: three moles or rats are attacking these ropes. On the right, a dog is looking at the man, and, opposite, are a calf eating grass, and a bird. Two oxen, joined by a heavy yoke and by whom is a plow, are also eating from a basket. Then follow sows, pigs, sheep, lambs, calves, *etc.* The ossuary is even more remarkable. It is a bronze chest, in the shape of a temple, fully 68 cent. long, standing on four feet, and entirely covered with plates of silver beautifully embossed, “comparable to the silver coffer of Hephaistos: or still more to the gold coffer in which the Trojans placed the bones of Hektor wrapped in purple cloths; for in this coffer were found the bones of the Vetulonian chief wrapped in cloth that is still preserved.”—*Bull. d. Istituto*, 1886, pp. 243, 244; *Bull. di Palet. Ital.* 1886, Nos. 7–8.

Comm. Gamurrini, after visiting Vetulonia, writes: “I was perfectly amazed to see the numerous and important antiquities which are being discovered by Dr. Falchi in this most ancient necropolis of Vetulonia. It may be said that what has been done up to the present is only a sample of what this field contains; for the tombs, passing beyond the primitive city limits, descend the hill and extend along its slopes, mile after mile,

until they reach the valley of the Bruna and the Ombrone. They are massed closely together through this vast extent, and their number is really incredible. The greater part belong to the earliest Italic or Etruscan civilization, and following its various stages stop at the Roman conquest. It may easily be conceived what a treasure is here hidden for Italy and for science; and it is hoped by those who have just entered upon the field of the origins of Italian civilization that this treasure will be utilized by proceeding with exact method and giving the facts diligently and without preconceptions.

“To speak of what is most important, I will mention the eleven *urne a capanna*, which were mingled with other Italic sepulchres, and evidently belonged to the same grade of civilization; then of the varied *funeralia*, among which are works in silver of Oriental style. But admirable above all is the discovery of the *tomb of the warrior*, which surpasses in importance that of the same name at Tarquinii, and also belongs to the same ancient period. In it, beside the large and highly-ornamented bronze *cinerarium*, there were, in two different compartments, two immense bronze vessels; one had for a cover a large round brass shield worked in relief, with geometric ornamentation, and, above the shield, a bronze helmet; inside were a large number of bronze and silver vases. The other contained not only bronze vases and kitchen utensils, but silver vases, one of which is of especial importance, a *tazza* with figures engraved, in the Phoinikian style; besides, there were vases of black *bucchero*, the most remarkable of which is a *kyliz* with animals in relief and a long Etruscan inscription, which should be considered one of the most archaic known.”—*Not. d. Scavi*, 1886, p. 143.

VISENTIUM=BISENZIO (near Capodimonte).—*Necropolis*.—*La Palazzetta*, on the south bank of Lake Bolsena, five kilometres N. W. of Capodimonte, is the site of the ancient Etruscan city *Visentium* (recognized by Cluver, *Ital. Antiq.* 1, p. 516) now called Bisenzio. Excavations were begun here in 1884 and continued until May 1885 under Sig. Cav. Giovanni Paolozzi on the site called *La Palazzetta*. Ten *tombe a pozzo* and thirty *tombe a fossa* were uncovered. Each of the latter contained rough sarcophagi of tufa within which were human ashes. Two only contained skeletons. The Greek painted vases are of a style not later than the v century B. C. In the layer of tombs nearest the ground-level were found fragments of two black-figured Attic cups, four amphorae, and objects of gold, silver, and iron. In the middle layer were found cinerary urns in shape campaniform. In one of the *tombe a fossa* in the lower layer was found an object of gold interesting in the history of dentistry (see under BUFFALO, p. 505), besides personal ornaments and eight cylinders. On the cover of the sarcophagus

1948

THE UNITED STATES OF AMERICA

DEPARTMENT OF COMMERCE

BUREAU OF ECONOMIC ANALYSIS

WASHINGTON, D. C.

OFFICE OF THE ASSISTANT SECRETARY FOR ECONOMIC AFFAIRS

REPORT ON THE ECONOMIC SITUATION IN THE UNITED STATES

FOR THE YEAR 1948

BY THE BUREAU OF ECONOMIC ANALYSIS

AND THE OFFICE OF ECONOMIC AFFAIRS

WASHINGTON, D. C.

CONTENTS

Introduction

Chapter I. The Economic Situation in the United States

Chapter II. The Economic Situation in the World

Chapter III. The Economic Situation in the United States

Chapter IV. The Economic Situation in the World

Chapter V. The Economic Situation in the United States

Chapter VI. The Economic Situation in the World

Chapter VII. The Economic Situation in the United States

Chapter VIII. The Economic Situation in the World

Chapter IX. The Economic Situation in the United States

Chapter X. The Economic Situation in the World

ancient models will be followed wherever possible. Work is being continued on the walls, clerestory, etc.—*Arte e Storia*, Oct. 5.

ROME.—Hebrew Catacombs.—In April 1885, a Hebrew catacomb was accidentally discovered near the Via Appia Pignatelli, not far distant from the Hebrew catacombs in the Randanini vineyard. Regular excavations were made under N. Müller during the months of April, June and July. A stairway, probably once surrounded by an atrium, leads from the surface of the ground to the principal corridor, which measures 17 metres in length, and not exceeding a metre in breadth. On either side passages lead to six quadrangular cubicles. As deviations from the better-known Christian type of catacombs, may be mentioned the form of the arcosolium, which grows larger toward the back; and the concealment of the loculi. The openings of the loculi were not only walled up but covered with stucco, so that their location was completely concealed from view. Rude vases, lamps, stamped bricks, and a number of inscriptions were recovered. Herr Müller will describe the results obtained in a work entitled *Die altjüdischen Cömeterien in Italien.*—*Bull. d. Istituto*, 1886, pp. 49–56.

Catacombs of San Sebastiano.—An account of the discovery of an untouched ambulacrum in this cemetery has been given by Prof. Marucchi on pp. 339–40 of the JOURNAL.

Paschal Candlestick.—In demolishing the Bandini-Giustiniani palace there was found part of a colonnette which was originally a paschal candlestick, with a mask and two small figures in relief whose style and attributes refer it to the VII century.—*Bull. d. Comm. arch. Nov.*

Mediæval frescos.—In the basement of a house on the Quirinal (now *Salita del Grillo*) belonging to Sig. Fonteanive was found a wall over whose door remained some figures, two of which are well preserved. The inscription under them can be thus completed from similar ones in San Clemente and the oratory of the *Sette Dormienti*: + *Ego Be(no De Rapiza) . . pro tuo a(more) . . pinge(re feci)*. These early Mediæval frescos undoubtedly belonged to the church of San Salvatore *in Militiis*.—*Bull. d. C. arch. Sept.*

Inundation of 1180.—In demolishing a house in front of the Chiesa Nuova, a fragment of a white marble column came to light, with an inscription recording an inundation of the Tiber on January 26, 1180 A. D., the 21st year of the pontificate of Alexander III. The exact date of this inundation had not before been ascertained.—*Bull. d. Comm. arch. Oct. Nov.*

Exhibition of Textiles, etc.—The exhibition of textile fabrics, organized for next March by the *Museo Artistico-Industriale*, promises to be a great success. Sub-commissions have been formed in several large cities, such as Torino, Milano, Genova, Modena, Venezia, Perugia, Napoli, Foligno. Torino will contribute several collections including one of ecclesiastical vestments of the XIII, XIV, and XV centuries. One of the most important

contributions already announced is that of the collection Gaudini, now belonging to the Museum of Modena, which includes over 1,800 pieces, forming an almost complete chronology of the art from the Byzantine period to the 'Premier Empire.'—*Courrier de l'Art*, Dec. 17.

Russian Academy of Arts.—The Russian Government have decided to found in Rome a branch of the St. Petersburg Academy of Arts, for the use and residence of Russian art-students provided with Government grants for studying in the Italian capital. The Palazzo Patrizi, first chosen, was found to be unsuitable, and a site has been purchased near Porta Pia, where a building is being erected which will be finished in the autumn.—*The Builder*, Oct. 2.

SOLAROLO (Romagna).—*Sculpture by Donatello.*—In the *Arte e Storia* of Nov. 24, Prof. Fed. Argnani gives an enthusiastic notice of a fine piece of sculpture of the xv century which is now in the communal palace of Solarolo. It represents the Virgin and Child enthroned within a tabernacle in pure Early Renaissance. The treatment of the figure, of the drapery, and of the ornamentation is described as masterly. It will form part of the great Donatelles exhibition given on the occasion of the uncovering of the façade of S. Maria del Fiore, at Florence.

VASTE (Otranto).—*Church of Santi Stefani.*—This crypt-church with its frescos is described in the *Arte e Storia* of Nov. 24. It is excavated in sandy tufa, and consists of three flat-vaulted naves ending in apses, and was still open for worship in the xvii century. It is filled with interesting frescos of various periods. Some are dated: the earliest date is read under the figure of S. Michael in the right-hand side apse; it is 6540 A. M. (Greek chronol.) or 1032 A. D. Another inscription in the left-hand apse, under SS. Nicholas, Gregory of Nyssa and Basil, gives the year 6601 = 1093 A. D. The third and most recent, on the painting in the central apse representing the Virgin appearing to Zaccharias, is dated 6884 = 1376 A. D. There are several restorations of later date. There being no trace of altars, ambones, or presbytery, as in other crypt-churches of the Terra d' Otranto, it is conjectured that it was intended simply as a place for the veneration of sacred images. The earliest frescos in the side apses, especially those of Christ and St. Michael (rt. apse), are of great majesty and beauty, and are said to surpass any previously known works of Italian painting anterior to the Renaissance.

Necropolis.—From the Messapian and Greek necropolis of this important city there have been recovered many hundred objects: plain and painted vases; objects of gold, bronze, iron; inscriptions; fragments of sculpture. A part have been placed in the provincial archæological museum at Lecce by the duke of Castromediano, but the greater portion have been dispersed.

VENICE.—*Sculptured columns of the High Altar of San Marco.*—These four columns of Greek marble are divided into nine horizontal zones which are subdivided into niches by columns bearing archivolts within which are figures in the round representing New Testament subjects. These have been considered by all authorities to be of the x or xi cent., and by a Byzantine or Venetian artist: but Sig. Zorzi announces that, though the inscriptions belong to that period, they are posterior additions, and that the sculptures date from the v or vi cent., and are by an Italian artist, probably from Ravenna. Prof. Tedeschi approves of this date, though he considers it more likely that these four were among the many columns brought to San Marco from the fine basilica of Santa Maria Formosa of Pola (built by bishop Maximianus of Ravenna in the vi century) when Pola was sacked by the Venetians.—*Arte e Storia*, Sept. 14, Oct. 17.

SPAIN.

CABRERA DE MATARÓ.—*Pre-Roman necropolis.*—In May, Señor J. R. de la Serna undertook new explorations in this necropolis, with interesting results. An early Iberian bronze coin was found, which determines the approximate date of the necropolis.—*Bull. Mens. de la Assoc. d'Excursions Catalana*, July–August, pp. 133–37.

FRANCE.

ANTHROPOLOGY.—The September number of the *Matériaux pour l'histoire de l'Homme* is devoted to a full report of the papers read in the Anthropological section of the French Association at its recent meeting in Nancy. This report has been prepared by the editor, M. Cartailhac, who explained to the meeting that prominence is to be given to anthropology at the National Exhibition to be held next year at Toulouse. It is proposed to erect facsimiles of the dolmens, tumuli, and other prehistoric monuments of the Pyrenees, and also to construct a lacustrine pile-dwelling, all of natural size.—*Academy*, Oct. 9.

KERMARIA (Bretagne).—*Church.*—A fresco has been found here representing the Dance of Death, in which the costume of the figures points to the reign of Louis XI.—*BUILDER*, Aug. 28.

LESOAR.—*Roman Ruins.*—On a plateau separated by a ravine from that on which is the site of a Roman camp, have been found ruins of a large building, apparently the residence of the military commander, which seem to belong to the third century, following the indications of a coin of Gordian III. A hemicycle and a peristyle, both paved with mosaics, bath-rooms and servants' quarters have already come to light. Trenches opened in the

neighborhood have uncovered numerous and important substructures, apparently belonging to the old city of Beneharnum.—*Cour. de l'Art*, Nov. 19.

PARIS.—*Louvre*.—A torso which had been quite generally termed an "Inopos" since the time of Visconti, and thought at all events to represent a water-divinity, is identified by M. Salomon Reinach (*Gazette Arch.* 1886, Nos. 7–8, pl. 22) as a royal statue, dating from the iv cent., of the Alexander-type, probably a portrait-statue of the great conquerer himself, erected by the inhabitants of Delos.

A nameless torso acquired by M. Reinach in excavating at Carthage in 1884 has recently been recognized as part of a statue of one of the Dioskouroi, the head and right leg having been recovered.—*Athenæum*, Oct. 2.

SAINTE-COLOMBE (Rhône).—*Roman houses*.—Since 1885, excavations have been carried on here, with the result of disclosing ruins of magnificent Roman constructions belonging, in some cases, to the best period. Most important are the mosaic pavements, of which several are of great beauty: fragments of frescos were found on the walls, also a great number of vases and of small objects.—*Cour. de l'Art*, Nov. 19.

BELGIUM.

NIEUPOORT.—*Mediæval frescos*.—Some wall-paintings in the church have been freed from their coating of plaster: they appear to belong to the xv century and to be in the best Flemish style. The figures are one-third life-size.—*Cour. de l'Art*, Nov. 5.

GERMANY.

AQUINUM.—*Amphitheatre*.—In this city of Pannonia Inferior the northern half of an amphitheatre has been uncovered: the most interesting feature is that the auditorium was roofed over.—*Wochenblatt für Baukunde*, Nos. 75, 76.

BERLIN.—*Museum*.—Dr. Bode has bought in Paris, for the museum, an important portrait, attributed to John Van Eyck, and said to represent Jean Arnoulfini, who, with his wife, appears in the famous picture by the same master in the National Gallery, London.—*Athenæum*, Oct. 9.

HANAU (near).—*Roman antiquities*.—The work here has been very successful, proving that a large part of the present village of Kesselstadt is built on Roman ruins which extend far beyond it to the N. and N. W. The discovery also of a fort proves the existence of an early Roman "Grenz-wall" in prolongation of the Main line from Steinheim-Kesselstadt to Friedberg. A Roman road and a passage across the Main at Philippsruhe confirm this fact. The topographical reconstruction of the Roman Kesselstadt is assisted by the discovery of the necropolis. That the passage was spanned

by a bridge was proved, November 2, by the discovery of considerable remains of a Roman bridge.—*Berl. phil. Woch.* Nov. 13, Dec. 4.

AUSTRIA-HUNGARY.

VIENNA.—*Ranier Papyri.*—Among late discoveries are fragments of a MS. of Aischines, of the fifth cent., containing, in eight columns, chapters 178–186 of his third oration; parts of the fifth oration of Isokrates (chs. 48 and 49) dating from the first cent. B. C.; a lexicon to the *Midas* of Demosthenes; and a fragment of an unknown grammar. The early Arabic documents, from the dates they bear, are said to greatly modify the chronology until now adopted for the history of the beginnings of Mussulman administration in Egypt. One papyrus has furnished M. Gomperz with the fact that the *Skylia* mentioned in Aristotle's *Poetics* is not a lost tragedy of Euripides but a dithyramb by Timotheos of Miletos; while, at the same time, Prof. Köhler demonstrates from an inscription that this Timotheos was the author of a second dithyramb entitled *Elpenor*.—S. REINACH in *Revue Arch.* 1886, II, p. 100.

Congress of Orientalists.—The Seventh Congress of Orientalists beginning Sept. 26 was a great success. Quite a large share was given to Archæology, especially in the African-Egyptian section. Of especial interest was Miss Amelia B. Edwards' paper on *The dispersion of Antiquities found in certain newly-discovered Cemeteries in Upper Egypt*. It recommended the identification and registration of historical antiquities in private collections and provincial museums in Europe and America. A resolution was passed requesting the archduke Ranier to hasten the decipherment and publication of the *Corpus* of papyri given by him to the Museum (of which the first instalment is ready) on account of their immense importance for Oriental history and linguistics.

Exhibition of Ecclesiastical Art.—It is announced that during the spring and summer months of 1887 (March to August) there will be held, in the Imperial Museum of Art and Industry in Vienna, an exhibition of works of religious art. Its object is to raise the present standard of art and industry in Austria. It will include, principally, works of former periods fully representing the different styles and epochs of art, and, by the side of these, the best contemporary productions. All churches and monasteries throughout Austria, and owners of all private collections, are urged to contribute largely to this loan-exhibition.—*Mith. d. k. k. Oesterr. Museuma.*

ROUMANIA.

BABADAGH (near Kustendjé).—Several Latin inscriptions have been found here: they are to be taken to Bucharest.—*Revue Critique*, Sept. 13.

RUSSIA.

OLBIA.—*Discovery of the ruins of a Greek city.*—The site of the ancient Olbia, in the government of Kherson, is being explored by the Russian archæologist M. Sourouzan. The *Kurgans* or tumuli of the locality are being excavated under the direction of the same archæologist. The ruins of the city are on the banks of the Dneiper about five versts below the village of Bielozersk. Traces have been found of streets regularly laid out, the foundations of houses, stoves filled with cinders, pots, and the remains of bones, pits to hold grain, drainage pipes, many domestic articles, fragments of statues, and handsome cornices, pieces of lead, and some Greek money with the inscription "Olbia." As yet only a tenth part of the ruins has been explored. Next spring the excavations will be continued, and the *kurgans* close by will be examined.—*Athenæum*, Oct. 2; N. Y. *Evening Post*, Dec. 14.

VLADIMIR (Volhynia).—*Cathedral.*—Recent excavations have laid bare the ruins of the Cathedral at Vladimir Volynsk, which was erected in the XII cent. and was dedicated to the Assumption by Mstislav Iziaslovich. It occupied an area but little less than that of Santa Sophia at Kief, and exceeded it in length. In the sanctuary, portions of a fine mosaic pavement have been found. The remaining interior space contained a large number of tombs of the archdukes and bishops. A mound, distant two versts from the town, has also been excavated, and the walls of a very ancient church, probably the earlier cathedral, have been discovered. Portions of frescos and inscriptions are now being investigated.—*The Antiquarian*, Dec. p. 275.

ENGLAND.

COLOMESTER.—A "*Burghold*" *destroyed.*—This building had been so encumbered with constructions of comparatively modern date that it became well known only when the entire group was torn down. It was built, *more Romano*, in the XI century, after the local style of the time, but in the rudest and most primitive character of that style. A full account of it, illustrated by plans, is expected to appear in the *Transactions* of the local Archæological Society.—*Athenæum*, Oct. 23.

DUFFIELD CASTLE (near Derby).—Henry de Ferrers, "who came over with the Conqueror," erected a stronghold at Duffield, in about the centre of his 115 manors: this was destroyed, by order of Henry III, after the battle of Chesterfield in 1266. Recent diggings have proved that the great rectangular keep of Duffield Castle was the largest and most massive of any erected in England in early Norman days, save the Tower of London, which exceeds Duffield by only a few feet. The whole of the foundations, and in many cases several courses of the worked stone, of the

keep and of its large fore-building on the western side are now laid bare. It is 98 ft. square, exclusive of the fore-building; the walls are 15 ft. in thickness, and must originally have stood at least 100 ft. high. The keep is divided by a partition wall, 4 ft. 6 in. thick, into two unequal apartments, measuring 63 by 41 ft., and 63 by 18 ft.: the larger had a pillar in the centre to carry the joists. It is curious that so far no curtain or outer walls have been found.

Further excavations proved the site to have been an important settlement both in Roman and Anglo-Saxon times, as shown by many fragments of pottery, stockade-work around the edge of an irregular *vallum*, etc.—*Athenæum*, Oct. 30.

LONDON.—*A new Oriental periodical*.—Under the title of the *Babylonian and Oriental Record* there has been started a monthly journal devoted to Assyriology and cognate studies. It is issued under the direction of an editorial committee comprising Prof. Terrien de Lacouperie, Mr. W. C. Capper, and Mr. T. G. Pinches, of the British Museum; and the collaboration of the following scholars has been secured: Prof. A. H. Sayce, the Rev. H. G. Tomkins, M. G. Bertin, Profs. Fritz Hommel, C. de Harlez, Carl Bezold, Pleyte, M. E. Naville, and Mr. W. M. Flinders Petrie. A special feature of the *Record* will be the publication, with facsimiles, of inedited texts from the British Museum.

British Museum.—*New Assyrian Gallery*.—A gallery in the British Museum, to be known henceforth as the Central Nimroud Saloon, has been rearranged for the better exhibition of the Assyrian antiquities discovered at Kalah (1847–51), of the collections obtained by the late George Smith and Mr. Rassam, and the objects presented by the proprietors of the *Daily Telegraph*: also a series of inscribed terracotta tablets representing almost every branch of Babylonian literature during a period of over two thousand years.—*The Antiquary*, October, p. 78.

A Painting by Niccolò Alunno.—The famous triptych of Niccolò Alunno, which was in the possession of the nuns of Santa Chiara at Aquila (Crowe and Cavalcaselle, III, 132) and which disappeared when the convent was suppressed in 1861, has made its way to London, after passing through the hands of several persons who are now in prison. It has been bought for the National Gallery.—*Arte e Storia*, Sept. 14.

Nottingham Castle Art Museum.—Sir John Saville Lumley, British Ambassador at Rome, has offered to present to the Nottingham Castle Art Museum a collection of specimens of classical antiquity which he has made on the site of the temple of Diana at Nemi, near Rome. The collection comprises a large number of objects and fragments in terracotta, bronze, and marble, as well as specimens of inscriptions (*cf.* JOURNAL, I, pp. 441–42).—*Academy*, Sept. 11.

EGYPT EXPLORATION FUND: ANNUAL EXHIBITION OF ANTIQUITIES FROM SITES IN THE DELTA.—As was done last year, the Exhibition of objects discovered during the winter and spring of 1885–86, took place at Oxford Mansion in September. They were but a selection, and did not include several colossal works in granite and basalt; but in many respects this exhibition was the most generally interesting yet shown by the Society. It contained Egyptian antiquities, Greco-Roman antiquities, relics from a famous Biblical site (Tahpanhes), and an abundance of domestic curiosities. To be noted were: “four complete sets of funerary amulets, arranged as found upon the mummies in tombs . . . at *Tell Nebesheh* (Am); the inscribed ‘Ushabti,’ or funerary statuettes, of glazed pottery; . . . the very beautiful masonic deposits of Aahmes II (temple of Uati) . . . also at Nebesheh.” From *Tell Gemayemi* came the remains of a large portable shrine of Ptah, consisting “apparently of a large wooden structure inlaid all over with glass mosaics of exceeding beauty, and surmounted by a bronze shrine with bronze pillars supporting a canopy, under which was placed the massive bronze statuette of the god. Two bronze statuettes of kneeling kings, each five inches in height, were placed fore and aft, the whole being carried on poles . . . It is apparently of Ptolemaic workmanship.” From *Tell Defenneh* (Tahpanhes) were a multitude of objects, chiefly from the palace-fort of Psamtik I and his successors, and from the great camp of Karian and Ionian mercenaries by which that building was surrounded (JOURNAL, p. 463): especially to be noticed are some pieces of scale-armor found in a chamber of the palace, this being the first specimen discovered, besides one made of hardened stamped linen now in the British Museum.

Conspicuous in the exhibition are the *foundation-deposits* of Aahmes II found at Tell Gemayemi, and those of Psamtik I found at Tell Defenneh. “These foundation-deposits . . . open a new chapter in the history of Egyptian discovery; a chapter of which Mr. Petrie is distinctly the author . . . Those of Aahmes are extremely beautiful and of very fine workmanship, the tiny gold plaques inscribed with the name of the king, ‘Aahmes-Se-Neith,’ being exquisitely wrought by means of minute puncturings.”—*Academy*, Sept. 4.—The even richer and more diversified foundation-deposits of Psamtik I are spoken of under “Tahpanhes” on p. 463 of this issue of the JOURNAL.

ST. ALBAN'S ABBEY.—Lord Grimthorpe is continuing the destruction of St. Alban's Abbey, and has recently pulled down a great part of the very curious twelfth century slype at the end of the south transept.—*Athenæum*, June 26.

AMERICA.

UNITED STATES.

Archæological Lectures during the winter 1886-87.—The rapidity of the growth of archæology in this country cannot be better proved than by the great interest taken in two courses of lectures which are being delivered during this season throughout the States, one by Professor Rodolfo Lanciani of Rome, the other by Dr. Charles Waldstein of Cambridge, England. Such has been the popularity of Prof. Lanciani's lectures that he has not been able to satisfy all the requests that have come in from all sides. Called to Boston, in December, to deliver the Lowell Institute lectures (12 in number), he delivered the same lectures contemporaneously for Harvard University, in Sanders' Theatre, Cambridge. On January 4, he began his course in Baltimore, having received an invitation from the Johns Hopkins University. The hall at the Peabody Institute was quite insufficient to hold his audience. In February, the same course is to be given in Philadelphia, at the invitation of the University of Pennsylvania. Besides these principal engagements, Prof. Lanciani has delivered or will deliver lectures at Wellesley, Princeton, Bryn Mawr, Columbia College (New York), and probably at Haverford and Yale, *etc.* The subjects of his lectures were announced in the June number of the JOURNAL (p. 232). The unrivalled success attending this course shows an awakened enthusiasm for the cause of archæology, and a great increase of interest in the subject, on the part of the general public.

Dr. Waldstein is delivering several courses of lectures: those which he is to give at Princeton College and at Bryn Mawr treat of Pheidias and Michelangelo and of the two representative periods of which these geniuses were the moving artistic spirits. On the invitation of an influential Committee, Dr. Waldstein is to give a longer course in Boston during the latter part of February and the early part of March, in which he will treat of the Development of Greek Art. The subject of his Harvard lectures will be The Various Influences bearing upon the Development of Greek Art,—a course of extreme interest which will contain much original matter.

Archæology at the University of Pennsylvania.—Dr. Daniel G. Brinton, of Philadelphia, has been elected Professor of American Linguistics and Archæology in the University of Pennsylvania. Dr. Brinton has been for several years Professor of Ethnology and Archæology in the Academy of Natural Sciences of Philadelphia, and is Vice-President of the American Association for the Advancement of Science, for the section on Anthropology. He is the author of numerous works and essays on these branches, and has edited a series of works in the native American languages, under

the title "Library of Aboriginal American Literature;" six volumes of which have already appeared.

Both Egyptian and Assyrian archæology have also been recognized among the courses of instruction, the latter being taught by Dr. Hilprecht, the young Assyriologist, recently arrived from Leipzig.

Classical archæology is represented by the course of twelve lectures on Roman antiquities to be given in February by Professor Lanciani of Rome.

Duty on works of art.—The question of the duty on works of art has until now been one of great difficulty, owing to the lack of any official dividing line between antiquities that are admitted free, and works of art subject to duty. Mr. Henry G. Marquand has recently made a test case of some paintings dating from the xv, xvi, and xvii cents., purchased in Europe. In view of this, Assistant Secretary of the Treasury, C. G. Fairchild, has written an opinion which definitely settles this question regarding the tariff, which until now had been left open. Paintings of this class had hitherto come under the tariff clause which levies a duty of 30 per cent. on oil paintings. The decision was that duty should be levied only on works produced posterior to 1700, and that everything anterior to this date should be placed on the free list. This important decision will doubtless greatly increase the importation of works of art.

BOSTON.—*Art Museum.*—The crowded state of the Art Museum has for some years made its enlargement necessary, not only for the suitable display of the present contents, but for the reception of new acquisitions. In November, a committee began to request contributions for a fund of \$250,000 for the building of two wings, which would nearly double the present accommodation. Already the sum of between \$150,000 and \$175,000 has been secured.

BUFFALO.—The odontological museum of Dr. Barrett has recently acquired the most ancient monument known of the practice of dentistry on Italic soil. This is a gold band holding in position three teeth of the upper jaw of a skeleton discovered in a tomb dating from the beginning of the vi century B. C. at the ancient Visentium near Capodimonte.—*Bull. d. Istituto*, 1886, p. 26.

NEW YORK.—*Metropolitan Museum of Art.*—This Museum will shortly possess the finest collection of Egyptian antiquities in this country, by the arrival of the antiquities selected for the Museum during the last few years by M. Maspéro from duplicates of the Bûlâq collection. They have been acquired by the expenditure of the \$10,000 received from the University of California for a large selection of duplicates in the Kypriote collection. It is reported that among the latest additions to these Egyptian antiquities is a complete tomb excavated since the passing of the new law allowing private excavations.

WELLESLEY COLLEGE.—*A new Art building.*—By a munificent bequest of \$100,000 for the purpose, the college will be able to erect a fine building for an Art School and Museum.

MOUNDS OF THE NORTH-WEST.—Mr. T. H. Lewis of St. Paul continued his private surveys of the ancient earthworks of Minnesota and adjoining regions, during the working season of 1886. Between March 27 and November 18, 1222 mounds were surveyed, including 168 "effigies" proper. Other monuments surveyed were a fortified hill-site and an ancient inclosure of an oval form, together with some not so clearly ancient; also some "garden-beds," and an incised or sculptured boulder. The theatre of field-work was from the valley of the Fox River of Wisconsin, on the south-east, to Devil's Lake and the Assiniboine River, on the north-west.

A few miles above the mouth of the Crow Wing River, between it and the Long Prairie River near their confluence, is a group of 65 mounds, two of which are of the imitative class, representing respectively a bird and a quadruped. This bird is identified as the cross or T-shaped mound of Wm. Pidgeon's "Tomb of the Six Kings," situated on the "waters of the Crow-Wing River." The latter, however, with its surrounding mounds, when compared with the results of instrumental survey, shows a similar state of things to that appearing in the diagrams accompanying the article on his "Monumental Tortoise" published last March in this JOURNAL.

MEXICO.

OAXACA.—*Sepulchre of a Zapoteca King.*—Advices from Oaxaca state that the sepulchre of a Zapoteca King has been discovered near there. In it were several obsidian images, well sculptured, and an idol of gold, which weighed about fifty pounds. In the same spot were found a skull and some other bones of such dimensions as to prove that the ancient ruler must have been a man of gigantic proportions.—N. Y. *Eve. Post*, Dec. 7.

A. L. FROTHINGHAM, Jr.

SUMMARIES OF PERIODICALS.

GAZETTE ARCHÉOLOGIQUE. 1886. Nos. 5-6.—L. HEUZÉY, *The most ancient Chaldean sculpture* (pl. 17). In previous articles in this Gazette, the writer has illustrated monuments which dated back to the earlier period of Eastern civilization and art: the period of the *Patési* of Sirpurla and, still earlier, the kingly period, whose most ancient monument appeared to be the fragment of the eagle and lion belonging to King Ur-Nina. The present article seeks to establish the even greater antiquity of a fragmentary relief in barbarous style, representing portions of four figures: two evidently represent the goddess Ishtar carrying the boy Dumuzi, the prototype of Astarte and Tammuz, and of Aphrodite and Adonis; in the other two we may probably recognize Izdubar slaying Humbaba.—A. CARTAULT, *Female figures grouped with little Erotes*. Two terracotta groups are reproduced on plates 18 and 19. In the first we see a nude female figure gracefully seated on a rock with one leg tucked under her: she is playing with three little Erotes that stand side by side on the rock. The second shows a draped and seated figure holding a toilet-pyxis in her right and a mirror in her left, in which she is gazing with a far-off affected air: a little Eros is pulling aside the drapery which covers her head. The writer sees in the first an Aphrodite, and in the second a mere mortal. He takes occasion to remark on that class of terracottas which are not always easy to characterize, being placed in an intermediate position between the two great classes, (1) those with representations from mythology, and (2) those from real life.—H. BOUCHOT, *The portrait of Louis II of Anjou, king of Sicily, at the Bibliothèque Nationale* (pl. 20) (contin.). The magnificent aquarelle portrait of Louis II was described in a previous article (Nos. 1-2, 1886). In the *Livre d'heures* (*Fonds Latin*, 1156^a) there are two portraits (pl. 20), one of King René of Anjou, the other of Louis II: but the writer proves that the latter must have been added to the ms. twenty years after the king's death, so that it has no value in comparison with the aquarelle portrait.—E. MOLINIER, *The architects of the Château de Fontainebleau* (contin.). The rustic architecture of the *Grotte aux Pins* is attributed to Il Rosso, assisted in its stuccos by Domenico del Barbieri; the portal of the *Cour Ovale* to Serlio; a share in the St. Saturnin chapel and the *Cour Ovale* is claimed for Philibert de l'Orme. Finally, it is confessed that very

little can be proved concerning the share of different architects.—A. CHABOUILLET, *Study on some Cameos of the Cabinet des Médailles* (contin.). IV. Venus, goddess of the Sea, or the Nereid Galéné,—a female divinity carried on the waves by a taurocamp, and escorted by five small amorini, one of whom plays the driver. The authenticity of this cameo being called in question, the writer describes the difficulties to be met in separating the real antiques from the imitations of the Renaissance, often considered as genuine so early as the XVI century. In opposition to Köhler, Brunn and King, M. Chabouillet regards this cameo as genuine, but the signature ΓΛΑΥΚΩΝ to be an addition of the Renaissance. Discussing the authenticity of artists' signatures, the writer denies that a single authentic signature exists on a cameo, and but few on gems. Of those in the Cabinet National, he considers but one to be genuine: ΕΥΔΟC ΕΠΟΙΕΙ, which accompanies a head of Julia, daughter of Titus; another gem now at St. Petersburg has a probably genuine ΔΕΞΑΜΕΝΟΞ ΕΠΟΙΕΙ ΧΙΟΞ. The writer gives details about a gem bearing a bust of Athena with the signature, ΕΥΤΥΧΗC | ΔΙΟCΚΟΥΡΙΔΟΥ | ΑΙΓΕΑΙΟC ΕΠΟΙ|ΕΙ, which would be that of the son of one of the four engravers mentioned by Pliny as engraving the official portrait of Augustus.

Nos. 7-8.—A. CHABOUILLET, *Study on some Cameos of the Cabinet des Médailles* (cont. and end). The signatures of Tryphon and Protarchos are declared to belong to the XVI cent., when the gems were probably cut. Several cameos are then described and illustrated (pls. 2, 3): (1) a late but good "Venus at her toilet"; (2) an episode of the contest between the giants and the gods; (3) Hera (a Greek work); (4) the dispute between Athena and Poseidon (an important cameo, shown to be antique, among other reasons, by its proposed identification with one described in the royal inventory of 1379); (5) a bull.—E. PIOT, *On a Missorium of the collection of M. Eug. Piot* (pl. 21). A general dissertation on the use and character of the circular tray called *repositorium* by the Romans, and, later, *missorium* by the Franks and Goths. These vases or trays were of silver, generally bearing figured compositions, on which the dishes of viands were passed at table.—S. REINACH, *The pretended "Inopos," a Greek sculpture in the Louvre* (pl. 22). This torso is a fine piece of Greek sculpture of the IV century, probably from Delos, which has long lain at the Louvre. Termed by Visconti "Inopos," a river near the city of Delos, it has kept this appellation, though considered unsatisfactory by some, until M. Ravaisson suggested that it represented Alexander the Great. The fillet around the head, the hair tossed back, the thick neck, the small veiled eyes, lead M. Reinach to adopt this attribution, though the bend of the head to the right instead of to the left, and the lowering instead of raising of the eyes, may be considered as difficulties in the way. In this connec-

tion, allusion is made to a royal bust recently found by M. Homolle at Delos, which, he thinks, may also represent Alexander.—P. DURRIEU, *A portrait of Charles I of Anjou, King of Sicily, brother of St. Louis* (pl. 23). The Bibliothèque Nationale possesses a ms. translation, in 5 tomes (*Fonds Latin*, 6912) of Rases' book on Medicine entitled *El-Haidi*, made by the Jew Farag in 1278 for Charles I, King of the Two Sicilies. From contemporary documents it is known that the royal copy of this work was adorned in 1282 with miniatures by the monk John of Monte Cassino. The writer proves the ms. in the Bibl. Nat. to be this very copy, doubly interesting, as the portrait of Charles I, painted by an eye-witness, is repeated in three of the miniatures. The work is of extreme interest both from an iconographic and an historical standpoint, and the portraits must take the front rank by the side of the gold coin and the statue of Charles at the Capitol.—E. MÜNTZ, *Inedited frescos of the Papal palace at Avignon and the Certosa at Villeneuve* (contin., see 1885, Nos. 11–12) (pls. 25, 26). A detailed description is given of the numerous frescos executed in the Chapel of St. John, built by Pope Clement VI (1342) and decorated by artists of the Siennese school. Simone di Martino, who died in July 1344, probably did some part of the work, and may have designed the whole, as the frescos are far superior to those of the chapel of St. Martial finished but a few months later, in 1346, but where Matteo da Viterbo was obliged to rely on his own resources. The frescos of the chapel of St. John have the good qualities and the defects of the Siennese school.—L. COURAJOD, *The statue of Philippe de Morvillier at the Louvre* (pl. 26). This important statue of stone and marble was recently transmitted to the Louvre from Versailles where it has gone under the name of the Canon Renaud de Dormans († 1386). M. Courajod shows, in the first place, that the costume is that of a member of parliament, and that the features resemble strongly those of Philippe de Morvillier, first president of the 'Parlement de Paris,' who died in 1438. The statue was probably executed in his lifetime. It is quite realistic, and an important example of the transformation of French sculpture.

A. L. F. JR.

JAHRBUCH DES K. DEUTSCHEN ARCHÄOLOGISCHEN INSTITUTS. Vol. I, 1886. No. 2.—W. HELBIG, *On the Portraits of Platon* (pls. 6, 7). A portrait-hermes in the Berlin Museum (*Verz. d. ant. Skulp. d. Berliner Museums*, 1885, p. 61, n. 300) formerly in the collection of Alessandro Castellani (*Catalogue Al. Castellani*, Paris 1884, p. 132, n. 1086) is published. It bears the inscription ΠΛΑΤΩΝ, and is the first well-authenticated portrait of Platon. With this hermes as a starting-point, six other portraits of Platon are recognized. Two of these are here published; one in the *Casino di Pirro Ligorio*, the other in the Vatican (*Mus. Pio-Clem.* VI, 35).

This last bears a late inscription, ΖΗΝΩΝ. Perhaps Platon is represented (1) on a double hermes found near Chiusi (*Bull. dell' Inst.* 1879, pp. 232-233) the other half of which represents Sokrates; (2) with Pythagoras, on a double hermes in the Polytechnikon at Athens; (3) on a relief let into the base of the Mattei Amazon (*Gall. delle statue*, 236). The small bust in Florence with the inscription ΓΛΑΤΩΝ is not included in the list of portraits, as the face does not agree with the others, and the inscription does not seem to belong to the same period as the sculpture. These portraits show an intellectual and well-formed head, but the expression is grave and even somewhat discontented.—M. OHNEFALSCH-RICHTER, *A Kyprian Vase from Athienu* (pl. 8). A vase is published with the representation of a man standing before two immense flowers, holding in his hand a flower which he seems to be smelling. A bird is flying over his head, but is apparently attached to his left hand by a string or twig. Other ornaments of lines and dots occur. The colors used are black and two shades of red, on a grayish ground. It is suggested that, in this painting, Phoinikian artisans misrendered Egyptian motives.—P. WOLTERS, *Communications from the British Museum. III. Archaic Reliefs from Xanthos* (3 figs.). Seven slabs with reliefs were found built into a wall on the Akropolis of Xanthos (Fellows, *A Journal . . . in Asia Minor*, p. 233). These are published by Prachov, *Antiquiss. mon. Xanthiaca*, pl. I. 2, 3, 6 B, h. It is shown that five of them belong to one and the same frieze, while the other two do not.

iv. *On the votive offering of Attalos* (3 figs.). A small bronze of the Blacas collection in the British Museum is believed to be a free copy of the same figure of a dying Gaul as the marble figure in Naples published *Mon. dell' Inst.* ix, pl. 20. 4. Two more small bronzes which Murray (*Arch. Zig.*, 1873, p. 60) referred to the group of Attalos are believed, though not positively, to be independent productions of minor art which early turned to the wars against the Gauls for subjects.—F. STUDNICZKA, *On the Hydrapediment*. This relief has been compared with a vase-painting representing the same scene (Gerhard, *Auserl. Vasenb.*, II, pls. 95, 96). Purgold (*Εφημ. Ἀρχ.*, 1885, p. 236 f.) thinks the relief is an independent composition, while the vase-painting is directly or indirectly derived from it. This opinion is here contradicted. The vase in question is ascribed by Klein to the Chalkidic school, and Meier (*Mitth.*, Athens, 1885, p. 326) would ascribe the relief also to Chalkidic artists, or at least Chalkidic influence. Both relief and vase-painting are here shown to be products of indigenous Attic art influenced in some degree by Korinthian style.—E. KROKER, *The Dipylon vases*. These vases form three classes. The first has geometric decoration; the second elements of the geometric style, besides animals and occasionally human figures; the third has genre scenes. The third class is specially discussed. Nude female figures appear here in funeral scenes. This shows

strong Egyptian influence. From the form of ships on these vases, and from the fact that naval battles are represented, while vases of this class occur almost exclusively in Attika, it appears that these vases were made in Attika about the middle of the seventh century. Besides the nude women, many other things, especially the choice of subjects for decoration, point to Egyptian influence. The paintings of the dipylon vases do not correspond to the scenes described by Homer nor to the works of art mentioned in the epic poems. Genre scenes like those here represented are rare in later work, being replaced by mythological representations. Perhaps these great dipylon vases are part of the extravagance at funerals to which Solon is said to have put an end.—**REPORTS.** *Acquisitions of the British Museum in the year 1885.* Extract from A. S. MURRAY's report to Parliament.—*Acquisitions of the royal museums at Berlin in the year 1885.* I. O. PUCHSTEIN, *Collection of Greco-Roman sculptures and casts.* Nine originals and sixty-two casts are recorded. II. A. FURTWÄNGLER, *The Antiquarium.* A number of articles from graves in Kypros and Rhodos head the list. Then follow vases, terracottas and miscellaneous objects. The report is illustrated with forty-two cuts, beside six facsimiles of inscriptions.

—**BIBLIOGRAPHY.**

HAROLD N. FOWLER.

JOURNAL OF HELLENIC STUDIES. Vol. VII. No. 1. April, 1886.—
 A. J. EVANS, *Recent discoveries of Tarentine Terracottas* (PLS. LXIII, LXIV). The scheme of the Italian Government to convert the site of the ancient Tarentum into a great Mediterranean arsenal has advanced considerably towards realization, and the consequent operations have resulted in many interesting archæological discoveries. Within the limits of the ancient akropolis a Doric temple of the first half of the sixth century has been re-discovered, whose capitals of severe and archaic style, as well as the measurements of the columns, correspond closely with those of the temple at Ortygia and with the oldest of Selinous. The remains of another temple of the age of Praxiteles have also been brought to light on the akropolis. Within the town proper, Signor Viola has identified one of the *peripatoi*, and the Roman amphitheatre, which he believes to have stood on the site of the ancient Greek theatre, the scene of the historic insult to the Roman ambassador. A hoard of 2000 Tarentine coins, deposited about the time of the Roman conquest, is among the recent acquisitions, and an enormous accumulation of crushed purple shells, along the shore of the inner sea, bears testimony to one of its important industries. But the chief interest centres in the vast deposits of terracottas, three of which point severally to as many sites of ancient sanctuaries. One of these, upon the southern shore, presents a large number of figurines in which the chief type is Apollon holding a lyre, and their accumulation is believed to mark the

proximity of a temple of that deity. Another site to the north has yielded some 30,000 pieces, and a third at no great distance a large number. To prove that the former represents the site of a sanctuary of Kora and Chthonian Dionysos, and the latter of Persephone, is the main object of Mr. Evans' interesting paper, which is illustrated by three woodcuts with six figures, beside the plates and a valuable map of the district.—A. S. MURRAY, *Antiquities from the Island of Lipara* (PL. LXII). These were discovered in 1879 among the contents of some 20 tombs, and are now in private possession at Glasgow. They consist of bronze and fictile objects: among the latter are two vases of the 4th century B. C., one of which depicts a scene from some comedy, a woman "divinely tall and most divinely fair" between two old men in attitudes of astonishment, perhaps a parody of Helena and the old men of Troy. But vases with comic representations are among the most difficult to explain, and perhaps no incident in any of the plays of Aristophanes can positively be identified on a painted vase. The second vase has a satyr-head done in outline and in fresco style, with the inscription AKPATON, in letters of the 4th century B. C. To this period most of these objects belong; but a seated figure holding a dove is attributable to the 6th century, and in style suggests connection with Rhodes from which a colony is said to have come to Lipara about that time. Some neolithic implements go back to the age of the aboriginal Ausones.—F. IMHOOF-BLUMER and P. GARDNER, *Numismatic Commentary on Pausanias: Part II, books III-VIII* (PLS. LXV-LXVIII). The joint editors continue their valuable work in illustration of Pausanias, in this number, from the coins of Lakonika, Messenia, Elis, Achaia, and Arkadia.—I. R. FARNELL, *On some works of the School of Skopas* (PL.). Nothing certain or satisfactory was known of the works of Skopas until three fragments were proved some six years ago to belong to the pediment of the temple of Athena Alea at Tegea. Against Dr. Treu's belief that these heads reveal Peloponnesian forms, due to the earlier influences which shaped the work of Skopas, Mr. Farnell urges that the Peloponnesian characteristics of the large chin and strongly marked cheek bones are less noticeable in the originals than Dr. Treu conceived from the drawings. The heads are especially distinguished by broad surfaces of the cheeks, a great depth of head as compared with the height, a rather flattened line of the top of the skull, a free and mobile rendering of the flesh upon the forehead the cheeks and the throat, great breadth between the eyes, and violent swellings of the flesh underneath the brow; while all is informed with a unique and vivid power and spiritual quality. The life in the face throbs with a masterful emotion and is penetrated with the excitement of action, thus presenting a distinctly dramatic quality, and a new departure in monumental sculpture. Measured by this standard, the style

of Skopas may be recognised in a terracotta head at Oxford, from the Esquiline; in a woman's head in the Central Museum at Athens, from Delos; and in a colossal female head and a heroic head from the Mausoleum, in the British Museum.—W. WROTH, *Imperial Cuirass-Ornamentation, and a Torso of Hadrian in the British Museum*. A reply by Mr. Wroth to Mr. Newton's impeachment of his attribution of the statue to Hadrian (*Jour. of Hell. Studies*, April, 1885). From a wide comparison of the varied forms of cuirass worn by statues of the Roman period the conclusion is re-affirmed, that this statue must be of Hadrian because its cuirass is practically identical with that of a statue of Hadrian discovered in the excavations at Olympia.—J. T. BENT, *An Archæological Visit to Samos*.—P. GARDNER, *Inscriptions from Samos*. Some excavations conducted here at the expense of the Hellenic Society brought little to light except an inscription of the 2nd century B. C. giving a list of victors at the Heraia or great festival of the island, and forming one of the most complete agonistic lists yet discovered. Twenty-one contests are mentioned, and the victors are not only from the island itself but from various towns of the Asiatic coast.—E. A. GARDNER, *An Inscription from Chalkedon*. This gives the names of persons elected to the office of *aisumnetes* during the month Potamios. It is similar to *C. I. G.* 3794, and, like that, writes the form $\alpha\lambda\alpha\tau\mu\omega\tilde{\eta}\nu$ with ϵ instead of υ , adding another instance to the four already known from Megara and its colonies.—J. B. BURY, *Ἰνυξ in Greek Magic*. This word originally meant a moon-song (a song to the moon-goddess, Io) independently of the wry-neck, which, on account of its cry, was used in magic moon-worship.—J. H. MIDDLETON, *A Suggested Restoration of the great Hall in the Palace of Tiryns*. *Fig. 1* represents the elevation of the front of the hall opening on the great court, with its two Doric columns and antæ, its inner walls covered with bronze, and three bronze-clad doors leading to the *prodomos*. As a reason for the tapering downward of the Mykenai columns, it is suggested that they were originally copied from Oriental buildings in which the trunks of palms were used, a tree that grows thicker at the top than the bottom. *Fig. 2* shows the curves of capitals at Mykenai, Selinous, and the Parthenon; *Fig. 3*, the ground-plan of *aithousa*, *prodomos*, and *megaron*, with its staircase leading up to the *orsothure*; and *Fig. 4*, an elevation, with the central portion of the roof rising into a species of "lantern" forming an exit for the smoke from the *eschara*. The *laure* is divided into an upper and lower story by a mezzanine floor, up to which the staircase leads to the *orsothure* from the *megaron*, thus forming a communication with the women's apartments; and Prof. Middleton believes that there was also another at the N. E. angle of the great *aule* or court of the men.—R. C. JEBB, *The Homeric House in relation to the Remains at Tiryns*. This is a vigorous polemic

against Dr. Dörpfeld's assumption that the palace at Tiryns is in substantial accord with the plan of the Homeric house. He marshals the numerous passages of the *Odyssey* which go to show that the women's apartments were behind the men's hall, with direct communication from the *megaron*, not merely by the *orsothure*, as Prof. Gardner has suggested by way of reconciling the glaring discrepancy.

A. C. MERRIAM.

MITTHEILUNGEN DES K. DEUTSCHEN ARCHÄOLOGISCHEN INSTITUTS. ATHENISCHE ABTHEILUNG. Vol. XL. No. 2.—F. DUEMMER, *Inscriptions from Amorgos and Melos*. Nineteen inscriptions from Amorgos are published. Nos. 1, 2, 3 are archaic sepulchral inscriptions of the sixth century, and are reproduced in facsimile. No. 4 is a dedication: the letters are Hellenistic. No. 6 records the dedication, probably in the first cent. B. C., by a number of officials, of some offering to the gods. No. 7 is a simple sepulchral inscription. No. 8 is a fragment of an honorary decree of imperial times. Nos. 10, 11 are fragments of metrical sepulchral inscriptions. No. 12 A is a fragment of an honorary decree. No. 12 B is a fragment of an inscription relating to public or private money matters. Nos. 16, 17 are sepulchral inscriptions. No. 19 is a fragment of a decree of the Naxians who lived at Arkesine on Amorgos. The assembly met in the temple of Apollon Delios. The inscription is of late (Roman) date. Six inscriptions from Melos are published. Nos. 1, 2 are fragmentary: both are given in facsimile, and show somewhat archaic forms. Both are certainly older than Ol. 91, perhaps older than Ol. 70. No. 3 is a fragment of a decree of the second-cent. B. C. The virtues of a Rhodian Ochidas are recounted, and probably honors were decreed to him. The mover of the decree was Theokritos, son of Theokritos, *Ναζίτης*. The community which publishes the decree is nowhere mentioned by name. Possibly the inscription is not of Melian origin. It may be from Naxia in Karia. No. 4 is in honor of a priest of the emperors Augustus and Julius, not later than the time of Claudius.—H. G. LOLLING, *Communications from Thessaly*. II. *Sepulchral Inscriptions* (contin.). Fifty sepulchral inscriptions are published (Nos. 51–100). All are from Larisa, except Nos. 82, 88, which are from the neighborhood of the village of Kioskiö.—E. FABRICIUS, *Antiquities of Krete*. IV. *Discoveries of the Mykenai age in Knossos* (PLS. III, IV). The former reports (*Bull. de Corr. Hell.* IV, pp. 124–127; *Rev. Arch.* XL, pp. 359–361) of the excavations undertaken in 1877 by M. Kalokairinos are supplemented by a description of a building found by him (*cf. Sec. Ann. Report of Arch. Institute of America*), and the publication and discussion of some of his minor discoveries. The building in question is not completely excavated. From the manner of its construction it appears to belong to the same early time as the buildings recently discovered at Tiryns.

A number of small vases are described, and three published (PL. III), the forms and ornaments of which are similar to those of vases published by Furtwängler and Löschke, *Mykenaische Vasen*. Some fragments of pottery are published (PL. III) with ornamentation mostly similar to that of vases from Mykenai and elsewhere, though some of the patterns here given are new. Twelve pithoi were also found with the early pottery. These are described, and one is published (PL. IV). The pithoi are decorated with 3 to 5 broad bands separated by raised rings or hoops. The broad bands are adorned with serpentine lines in relief. Though the pithos is still a common utensil in Krete, it is probable that these, which are very like one found at Hissarlik and fragments found at Tiryns, are ancient.

v. *Fragment of a Pithos from Lyttos* (PL. IV). The fragment here published and described is in the collection of the syllogos at Drachio. The mouth has a cornice underneath which, about the neck, is a frieze divided by vertical bands into rectangular spaces, each of which contains a horse and rider in rather high relief. The band between the spaces is adorned with a spiral pattern. Below the frieze are lines and rosettes, which last remind one of metal-work.—E. LOEWY, *Sepulchral Relief from Korinth* (PL. v). The relief here published represents a young warrior, with spear, sword, helmet, shield and chlamys, advancing over the body of a fallen youth, upon whose shoulder he places his left foot. The outlines of the relief are free and beautiful, but the whole is treated almost like a silhouette; for the forms of the persons are not naturally rounded, but are left for the most part flat, and cut down almost perpendicularly to the back ground. Perhaps the design was made by a good draughtsman, and the work executed by an ill-trained stone-cutter. The erect warrior is represented almost from the rear. The rear view was frequently chosen about the end of the fifth cent.; rarely before that. The fallen warrior is represented in a natural and effective way. The date conjecturally assigned is the latter part of the fifth cent. The inscription, *Ἀλκίας Φωκεύς*, though carelessly cut, may well belong to about the time designated.—W. DOERPFELD, *On the Excavations on the Akropolis*. The Akropolis before the Persian wars is described as a ridge divided into terraces for dwellings and temples, which was not much changed in general appearance by the extensive buildings of the tyrants. Of these buildings many traces have been found. After the retreat of the Persians the whole crest of the Akropolis was surrounded by a wall, and levelled so as to form one plateau sloping toward the West. As the wall rose, the space within was filled with alternate layers of stone (débris) and earth. The stones of the ancient buildings, as well as the ruined statues, were in such confusion that we cannot affirm that their original position was near that in which they were found in the excavations. A great part of the later arrangement of the Akropolis is attributed

to Kimon.—F. DUEMLER, *Archaic Gems from Melos* (PL. VI). Twenty cut stones are published. One of these (No. 2) is from the pre-Hellenic nekropolis near Phylakopi, the rest from the oldest Hellenic nekropolis. The figures comprise winged horses, etc., birds, fishes, and men. One stone has a Medusa, and one (No. 2) an ornament of curved lines. Such stones are found in the track of the so-called Doric colonization. They seem to belong to a civilization the chief seat of which is yet unknown, but which was closely connected with the ancient civilization of Mykenai. Most of these stones may be ascribed to the VII and VI cents. B. C.—N. NOVOSADSKY, *Kretan Inscriptions*. I. A fragment of an archaic inscription found near Knossos: apparently an account. II. An inscription said to have been found at Hieropytna. The temple of Apollon Dekataphoros, the twelve gods, and Athena Polias was repaired under Kosmoi of the tribe of the Dymanes. The names and patronymics of ten Kosmoi are given. The date assigned is the middle or end of the second cent. B. C.—F. STUĐNICZKA, *The archaic Head of Athena in the Museum on the Akropolis* (supp. plate). The head of Athena was found in 1863 (published *Εφ. Αρχ.* 1883, pl. 4; L. M. Mitchell, *Hist. of Anc. Sculpt.*, p. 214). In 1882 a large fragment of the upper part of a female figure wearing an Aegis was found. These are shown to belong to the same figure, three smaller fragments of which are also published. The position of this figure shows that Athena was engaged with a fallen opponent; probably a giant. Fragments of male figures have been found corresponding in execution to the Athena. One of these seems to have been represented falling backwards. This figure is discolored by drops of the same colors as those used upon the Aegis of Athena. These fragments may, then, belong to the fallen opponent of Athena. As fragments of other figures have been found (several are here published), it is probable that the gigantomachia was represented by numerous figures. The fragments preserved were carefully finished only on one side, and are so broken that it seems likely they fell from some height. We have probably the remnants of a pedimental group from pre-Persian times. Still, this group can be little earlier than the end of the 6th century. It may well have adorned the great pre-Persian temple of Athena.—MISCELLANIES. B. LATISCHEW, *Mittheil.* x, p. 317, No. 5. The inscription referred to mentions a *záθoδoς* at Odessos. This is explained as a reference to the return of the inhabitants after the supposed destruction of the city by the Getae. The date of the *záθoδoς* was, then, about 50 B. C.—E. LOEWY, *Inscriptions from Mughla* (Karia).—*Inscriptions from Tralles*. Two inscriptions, one of them in honor of a Roman knight, C. Julius Philip-
pus, who had been priest of Zeus Larasios.—*Appendix to p. 152, note 2*. The writer testifies to the existence of the picture on the stele of Antiphanes, the cock and the star being visible.—TH. SCHREIBER, *Mitth.* x, p. 392

sqg. (Alexandrian sculptures). The Akka, a tribe of African dwarfs, are described after Ratzel, *Völkerkunde*, vol. I, p. 124. From this and similar tribes the type of pygmies is supposed to be derived.—LITERATURE and DISCOVERIES.

HAROLD N. FOWLER.

MITTHEILUNGEN DES K. DEUTSCHEN ARCHÄOLOGISCHEN INSTITUTS. RÖMISCHE ABTHEILUNG (*Bullettino dell' Istituto archeologico germanico, sezione romana*). Vol. I. No. 2.—G. GATTI, *Some observations on the Horrea Galbiana*. After some introductory remarks on the horrea of Rome, Sulpicius (*ad Hor. carm.* IV, 12, 18) is cited, stating that the *Horrea Galbae* were identical with the *Horrea Sulpicii*. This is confirmed by the sepulchral inscription of the consul Ser. Sulpicius Galba (*Bull. arch. comm.*, 1885, p. 166; *Not. d. Scavi*, 1885, p. 527; *Bull. d. Ist.* 1886, p. 61). Inscriptions (*C. I. L.* VI, 338, 339, 588, 710; *Bull. d. Ist.* 1886, p. 42) mention three *cohortes* in intimate relation with the *Horrea Galbiana*. These *cohortes* are shown to be the three squares or courts into which the horrea were divided.—F. KOEPP, *Archaic Sculptures in Rome* (PL. IV). A head in the *Galleria geografica* of the Vatican (badly published by Pistolesi, *Vaticano descritto*, VI, pl. CI; and Visconti, *Mus. Pio-Clem.*, VI, pl. IV, 1) is published and discussed. It is shown to be a Greek work (or a direct copy of a Greek work) of the early fifth century B. C.—W. HELBIG, *Excavations of Corneto*. An account is given of the excavation of tombs in which were found, in addition to human remains, implements of silver, bronze and iron, scarabei, and vases of Attic and Corinthian origin, besides one rectangular chest of terracotta adorned with paintings.—A. BARBINI, *Tomb discovered near Grosseto*. A tomb is described in which were found human remains along with numerous more or less fragmentary vases and a few iron and bronze objects.—F. M. NICHOLS, *The Regia*. Remains of a building on the *Via Sacra* near the temple of Vesta, behind the temple of *Divus Julius*, are described, and the building is identified with the *Regia* upon the walls of which the *fasti consulares* and the *fasti triumphales* were inscribed.—H. JORDAN, *The Ancient Edifices between the temple of Faustina and the Atrium of Vesta* (PLS. V, VI, VII). In the course of excavations near the temple of Vesta, foundations of two buildings were uncovered, one of republican date, the other of imperial times. The former is believed to have been the old *regia*, the latter the new *regia* erected by Domitius Calvinus. This latter building is the one called *regia* by Nichols (*v. supra*). Five very fragmentary inscriptions are published.—O. BENNDORF, *Observations on the Torlonia Museum*. Thirty-four works of ancient art in the *Museo Torlonio* in the Trastevere are described and briefly discussed, with a general reference to *I monumenti del museo Torlonia di sculture antiche riprodotti con la fototipia*, Rome 1884, and the accompanying text by Carlo Ludovico Visconti, Rome 1885 (*cf.* Schrei-

ber, *Arch. Ztg.* 1876, p. 120 ff.; 1879, p. 63 ff.).—W. HENZEN, *Laurentine Inscription*. A short inscription in honor of the Emperor Tiberius is published, dedicated apparently by the same Sp. Turranius L. f. Proculus who is known to us from *C. I. L.*, 10, 797 (= Orelli 2276).—A. S. MURRAY, *Hera of Girgenti*. In opposition to Furtwängler (*Arch. Ztg.* 1885, p. 275), it is shown that the Hera of Girgenti has undergone some restoration in modern times. Furtwängler's other arguments to show that the head in question is a modern forgery are disproved.—REPORTS OF MEETINGS.

HAROLD N. FOWLER.

REVUE ARCHÉOLOGIQUE. 1886. **Feb.-March.**—A. DANICOURT, *Study of some antiquities found in Picardie* (2 plates, 25 figs.). A double pointed flint pick or hoe found at Mesnil-en-Arronaise, similar to some found by Dr. Schliemann at Hissarlik, and prototype of Gallo-Roman implements of iron at the museum of Saint Germain. A flint crushing-stone found at Misery, used for crushing wheat before the Gallo-Roman *mola versatilis*. Twenty-one Gallic coins, which have been ingeniously arranged in a case the background of which represents a map of Gaul. An enumeration is given of the principal bronzes found in Picardie. Among other objects described, mention may be made (1) of the bone dice with lettered faces and which, like a primitive roulette board, revolved on a central pivot; and (2) of an iron hernia-bandage described by Celsus, Galen and Oribasios.—Dr. VERCOUTRE, *Sacerdotal practice of Medicine in Greek Antiquity* (cont.). The decline of the power of the priests of Asklepios traced (1) to the increased value given to dreams, contact with tongue of the serpent, dog, etc.; (2) to the spread of such practices to the shrines of other divinities; (3) to the introduction of similar foreign practice; (4) to the gradual rise of medical science. Nevertheless reminiscences of the ancient practices exist to the present day.—E. MÜNTZ, *Ancient Monuments of Rome at the time of the Renaissance. New Researches* (cont.) (1 Plate). Text of the *Voyage d'Italie* concerning the gates and roads leading to Rome.—P. DE LISLE DU DRENEUC, *Bretagne: Triangles of menhirs near the mouth of the Loire*. Three large menhirs here form a great triangle with sides of 9,500 m., 9,200 m. and 8,500 m. Each menhir is in form a triangular pyramid, is carefully oriented, and is accompanied by two megaliths which form with it an equilateral triangle.

April-May.—L. HEUZÉY, *King Dungi at Telloh*. Before the discoveries of M. de Sarzec at Telloh, King Dungi and his father Ur-Gur, founder of the staged pyramid at Mughéir, seemed to belong to the most distant period of Babylonian antiquity. A comparison of the inscriptions referring to Dungi with those of Gudea, patési of Sirpurla, shows the former to belong to a period when the cuneiform characters were already well devel-

oped. Small bronzes found at Telloh, bearing the name of Dungi, are superior in workmanship to the similar bronzes of Gudea. From the fragment of a statue comes an inscription, ". . . To the goddess Bau,—his wife, —for the preservation of the life of Dungi,—King of Ur,—King of Sumir and of Akkad,—Sil-la-(an)-dan,—son of Lu-ka-ni,—patési of Sirpurla." If the latter was the patési of Sirpurla contemporary with Dungi, both may, with some hesitation, be considered as later than Gudea.—G. BAPST, *Life of Saint Eloi*. Born at Chatelat in the year 588, he attained great renown as gold and silver smith; practised his art even after being made Bishop; died at Noyon in 659.—M. DELOCHE, *Studies on some seals and rings of the Merovingian period* (cont.). XVIII. Seal ring of Gudinus. The monogram which M. Ch. Lenormant read SIGVDVNVS is better interpreted as GVDINVS. An abbot of the monastery of St. Benignus of Dijon with this name lived during the first third of the VIII century. XIX. Monogram-ring from Airvault. Monogram is deciphered as + GREGORIA, a name well known in the Middle Ages. XX. Seal-ring of DOMMIA. XXI. Centurion's buckle with an inscription.—E. MÜNTZ, *Ancient Monuments of Rome at the time of the Renaissance. New Researches* (cont.). Continuation from the *Voyage d'Italie*; notices of the Porta di San Giovanni, Porta Maggiore with vestiges of an ancient gate (Exquilina) near it, the Porta di San Lorenzo, another ancient gate (Querquetulana), Porta Pia and Porta Salaria.—LEBÈGUE, *Researches on Delos*. Preliminary observations indicating the character of the changes to be made in a new edition of his *Recherches sur Délos*, to appear when the excavations have been completed.—C. JULLIAN, *Greek Inscriptions from Egypt*. The Archæological Museum of Marseilles has acquired five Greek inscriptions found at Alexandria. The most interesting is the epitaph (of the 2nd or 3rd century B. C.) of an Argive named Polykrates and entitled δ ἀρχισωματοφύλαξ, or chief of the body-guards. This institution was adopted by the Roman Empire, where the Imperial guards were called *corpori custodes*. Five more Greek inscriptions from Egypt, now in the Château-Borély, are also published.—H. BAZIN, *The Citadel of Antibes* (pls. VIII, IX). A description of this Roman citadel.—DE CHARME, *Note on the Kanephoroi*.

June.—G. BAPST, *The Tomb of St. Martin* (2 pls.). It is a mistake to attribute the reliquary of St. Martin to St. Éloi, as this was of electrum and made by St. Perpetuus (*Miracula beati Martini*, auctore Hæberno, apud Baluze, *Miscellanea*, t. II, p. 300, Lucæ 1761). St. Éloi was an architect who utilized goldsmiths' motives, rather than a goldsmith proper. It is probable that he executed over the tomb of St. Martin a ciborium, ornamented with gold and gems.—E. MÜNTZ, *Ancient Monuments of Rome at the time of the Renaissance. New Researches* (cont.). Notices of the Via Salaria, Porta Pinciana and the Via Collatina.—M. DELOCHE, *Studies on some seals and rings of the Merovingian period*. XXII. Seal-ring found at

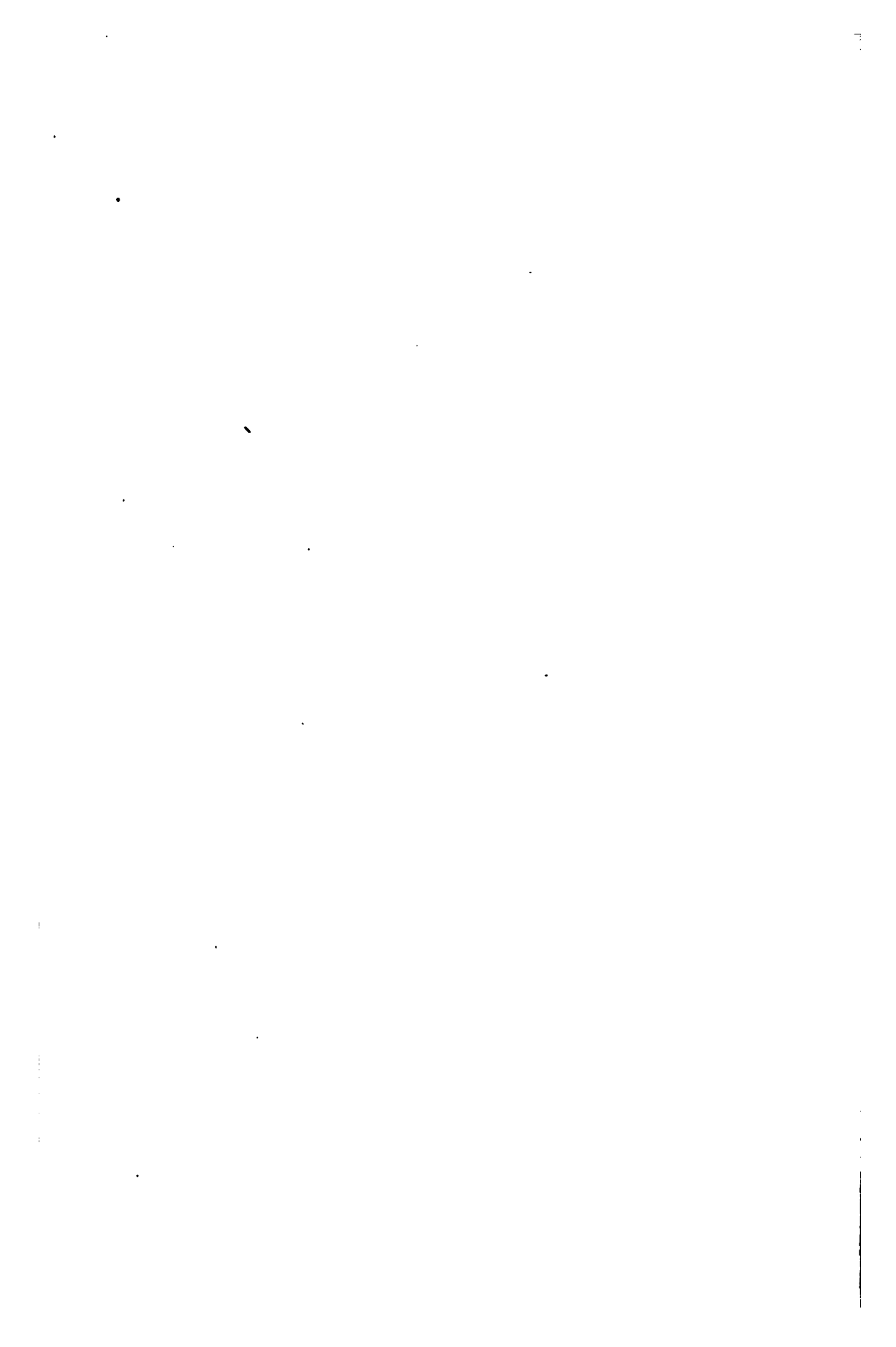
Arcy-Sainte-Restitute (Aisne). The inscription is read ☩ [R]VSTICVS FICIT +. Probably a druggist's or physician's ring, and used to stamp his remedies. XXIII. Seal-ring of Héva. Inscription reads HEVA, a name used at this period.—ANDRÉ LEVAL, *Inventory of Greek mss. of the xvii and xviii centuries preserved in the archives of the Monastery of St. Louis at Péra, Constantinople*. Classified, with brief description of contents, as (1) Patriarchal documents; (2) Papers coming from Constantinople; (3) Papers from the islands of the Archipelago; (4) Various pieces.—PAUL TANNERY, *Arabic numerals in Greek mss.* In Greek mss. prior to the xvi century, four forms of numerals were used, two of Oriental and two of Occidental origin. They are found almost exclusively upon diagrams and geometrical figures.

July-Aug.—G. MASPERO, *Official account of the uncovering of the mummies of Rameses II and Rameses III* (pls. xii, xiii, xiv). See under *News* on p. 461.—S. REINACH, *The Last Counsels: Terracotta group in the British Museum* (pl. xv). This charming group from Myrina represents a recently married woman giving the final counsel to a fiancée. In execution it belongs to the Roman period, but it is probably derived from an Alexandrine original.—CLERMONT-GANNEAU, *Antiquities and inedited inscriptions of Palmyra* (2 plates, 20 figs.). A collection belonging to M. J. Löytved contains a mummy and twenty-seven pieces of sepulchral sculpture. Fifteen of the latter contain inscriptions, which are here edited.—E. MÜNTZ, *Ancient Monuments of Rome at the time of the Renaissance* (cont. and end). Notices of Porta del Popolo and Via Flaminia, and discussion on the size of Rome.—M. DELOCHE, *Studies on some seals and rings of the Merovingian period* (cont.). XXIV. Seal of DIANA + AVIVS found at Breny in 1880. XXV. Seal-ring of Abbon (?) with the inscription ABBONE SO(bscriptio). XXVI. Seal-ring from Hohberg.—A. LEVAL, *Greek inscription in Constantinople*. A more complete reading of C. I. G. 8672 B.—R. DE LA BLANCHÈRE, *History of Roman epigraphy drawn up from the notes of Léon Renier*. This treatise, intended for beginners and not for specialists, was compiled nearly ten years ago, and is, for the greater part, but an adaptation of notes taken from the lectures given by M. Renier in 1862. This first article deals with epigraphical collections, beginning with the Einsiedeln codex, the Signorili, or rather the Cola di Rienzo, collection and those of the Renaissance.—P. MONCEAUX, *The grotto of the god Bacax at the Djebel-Taïa*. After referring to various native African divinities, especially to *Bacax Augustus*, the writer speaks of the many inscriptions to him found in this central locality, and of the immense cavern consecrated to his worship. It is divided into three regions with immense halls.—S. REINACH, *Chronique of the East*. Athens, Constantinople, Macedonia, Thasos, Roumelia, Pamphylia, Asiatic terracottas, Kypros, etc.

ALLAN MARQUAND.

BOOKS RECEIVED.

- Daniel G. Brinton.** Ikonomatic method of Phonetic writing. 8vo, pp. 14. Philadelphia, 1886.
- Philippe Burty.** Bernard Palissy. Ouvrage accompagné de 20 gravures. 4to, pp. 56. Paris, 1886, *Librairie de l'Art*.
- P. Cavvadias.** Fouilles de l'Acropole (Les Musées d'Athènes en reproduction phototypique de Rhomaidès frères). 4to, pp. 8 and eight plates. Athens, 1886, *Karl Wilberg*.
- Champfleury.** Les artistes célèbres.—La Tour. Ouvrage accompagné de 15 gravures. 4to, pp. 100. Paris, 1886, *Librairie de l'Art*.
- Georges Duplessis et Henri Bouchot.** Dictionnaire des marques et monogrammes de graveurs. Deuxième partie: G-N, pp. 123-242 [Guides du Collectionneur]. 12mo, pp. 122. Paris, 1886, *Librairie de l'Art*.
- Gustave Gruyer.** Les artistes célèbres. Fra Bartolommeo della Porta et Mariotto Albertinelli. Ouvrage accompagné de 21 gravures. 4to, pp. 109. Paris, 1886, *Librairie de l'Art*.
- W. Helbig.** Viaggio nell'Etruria e nell'Umbria, con appendice sopra il Kottabos (Estratto dal *Bull. dell'imp. Istituto arch. Germ.* vol. I, pp. 214-43). 8vo, pp. 30 with two plates. Rome, 1886, *Loescher*.
- N. Kondakoff.** Histoire de l'art Byzantin considéré principalement dans les miniatures. Edition française originale, publiée par l'auteur, sur la traduction de M. Trawinski, et précédée d'une préface de M. A. Springer, professeur à l'Université de Leipzig. Tome premier, accompagné de 29 gravures [Bibliothèque internationale de l'Art]. 4to, pp. 202. Paris, 1886, *Librairie de l'Art*.
- J. Ménant.** Les Langues perdues de la Perse et de l'Assyrie: Assyrie. 18mo, pp. xvi-340. Paris, 1886, *Leroux*.
- Emile Molinier.** Les Bronzes de la Renaissance: Les Plaquettes; Catalogue raisonné, précédé d'une introduction [Bibliothèque internationale de l'Art]. Tome I, accompagné de 82 gravures: tome II, accompagné de 26 gravures. 8vo, pp. xl-215 and 238. 1886. *Librairie de l'Art*: Paris, *J. Rouam*; London, *Gilbert Wood & Co.*
- Edward S. Morse.** Ancient and modern methods of arrow release: 1886.
- Eugène Müntz.** La Bibliothèque du Vatican au xvi^e siècle: notes et documents [Petite bibliothèque d'art et d'archéologie]. 18mo, pp. iv-139. Paris, 1886, *Leroux*.
- B. v. Scala.** Vortrag über die wichtigsten Beziehungen des Orientes zum Occidente im Alterthum. 8vo, pp. 35. Wien, 1886.
- Robert Sewell.** Early Buddhist Symbolism [*Journal of Royal Asiatic Society*, vol. xviii, pt. 3]. 12mo, pp. 43, with 23 figs. London, 1886.
- Wilmowsky (von).** Das Coemeterium St. Eucharii. Ein Beitrag zur ältesten christlichen Geschichte Triers. 4to, pp. 24, with three plates.
- Warwick Wroth.** Catalogue of the Greek coins of Crete and the Aegean Islands. Edited by Reginald Stuart Poole, LL. D. 8vo, pp. 152, with 29 plates. London, 1886, *British Museum publication*.





HITTITE MONUMENT AT EFLATÛN-BUNAR.

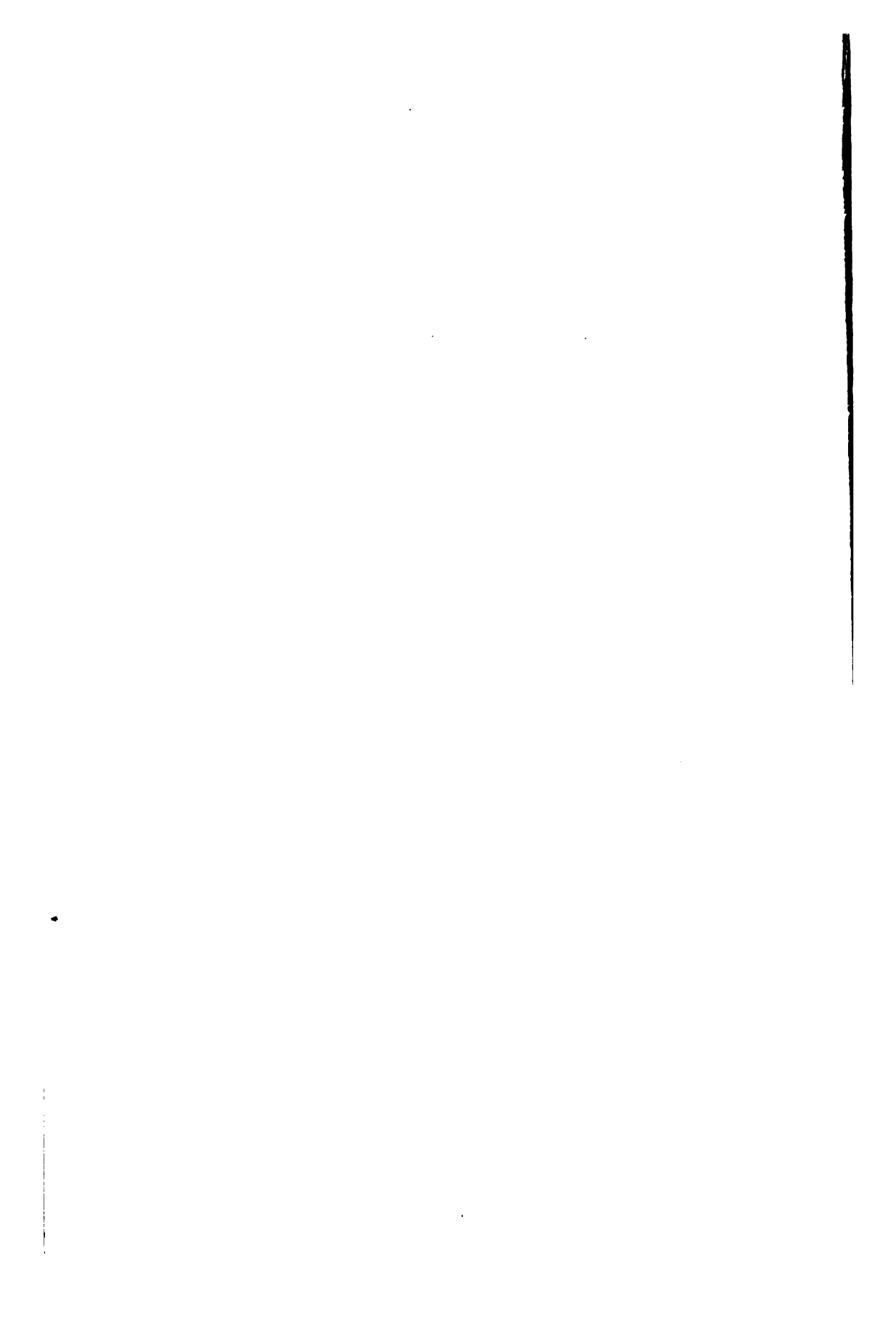
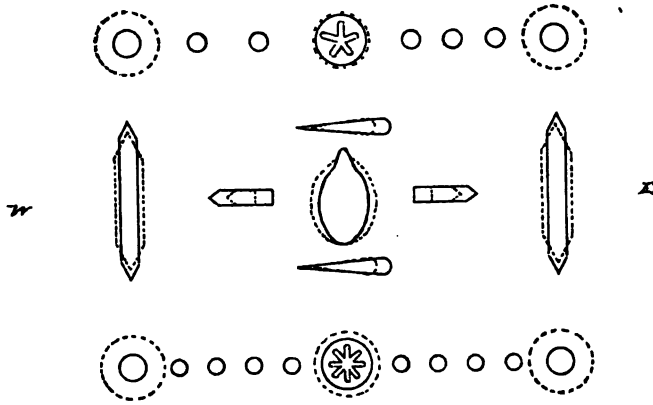
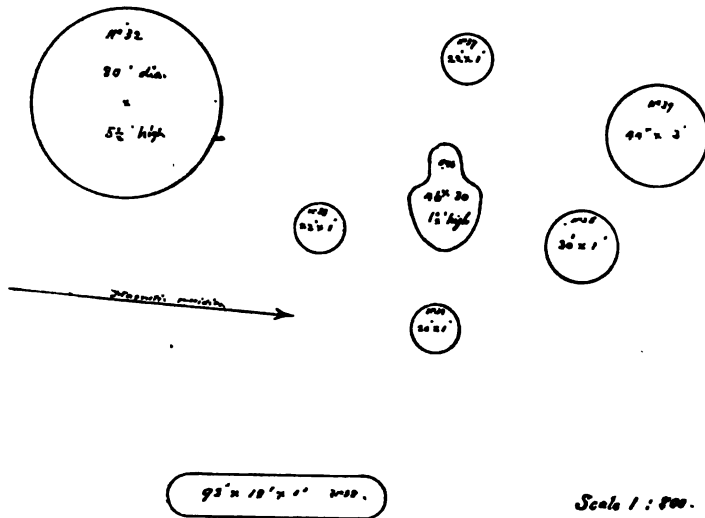


Figure 1. Fiction.



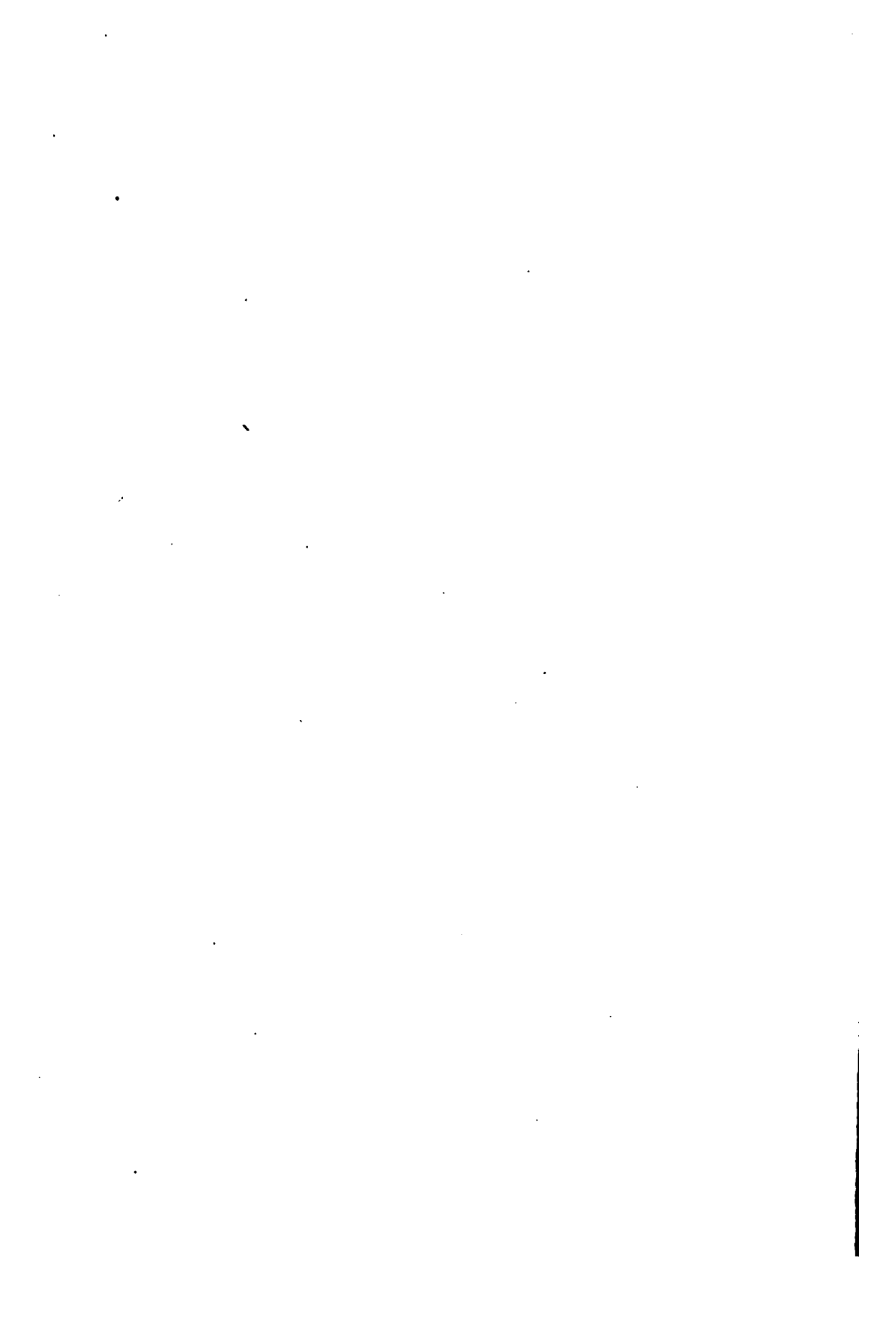
Scale 1 : 100.

Figure 2. Fact.



Scale 1 : 100.

MOUNDS OF DE-COO-DAH.

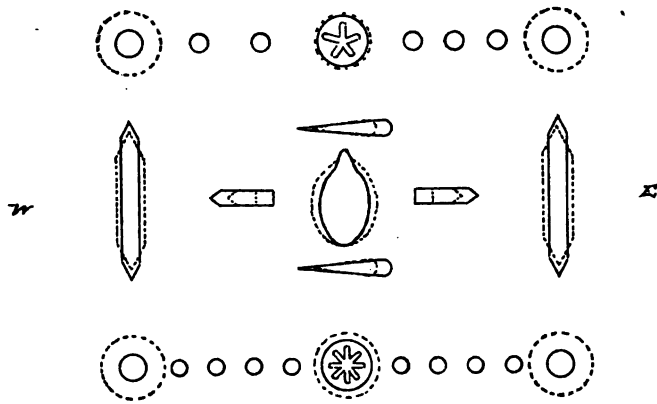




HITTITE MONUMENT AT EFLATÚN-BUNAR.

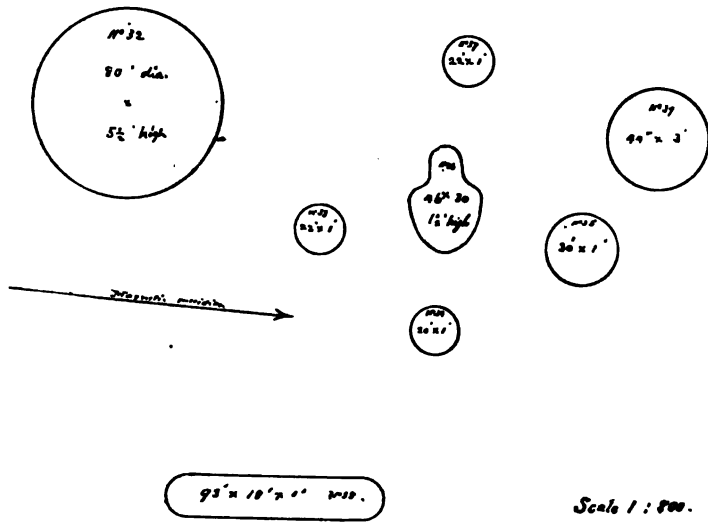


Figure 1. Fiction.

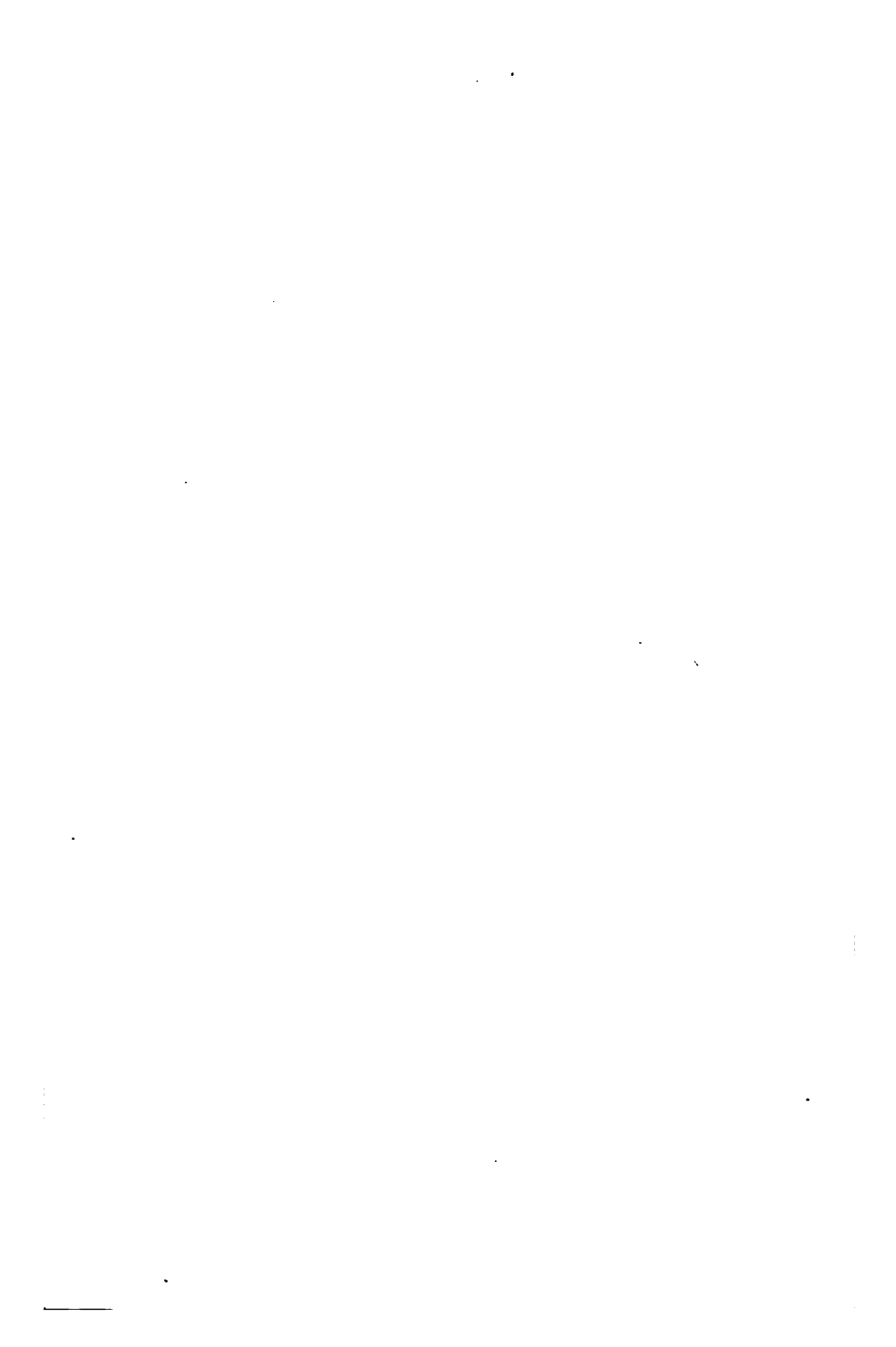


Scale 1 : 500.

Figure 2. Fact.



MOUNDS OF DE-COO-DAH.





1



2



3



4



CL. I-A



I-B



I-C



CL. II-A-1



II-A-2



II-E-1



II-B-2



II-C-1



II-C-2



II-D



II-E-1



II-E-2



CL. III-A



III-B



III-D-1



III-D-2



III-D-3



III-D-4

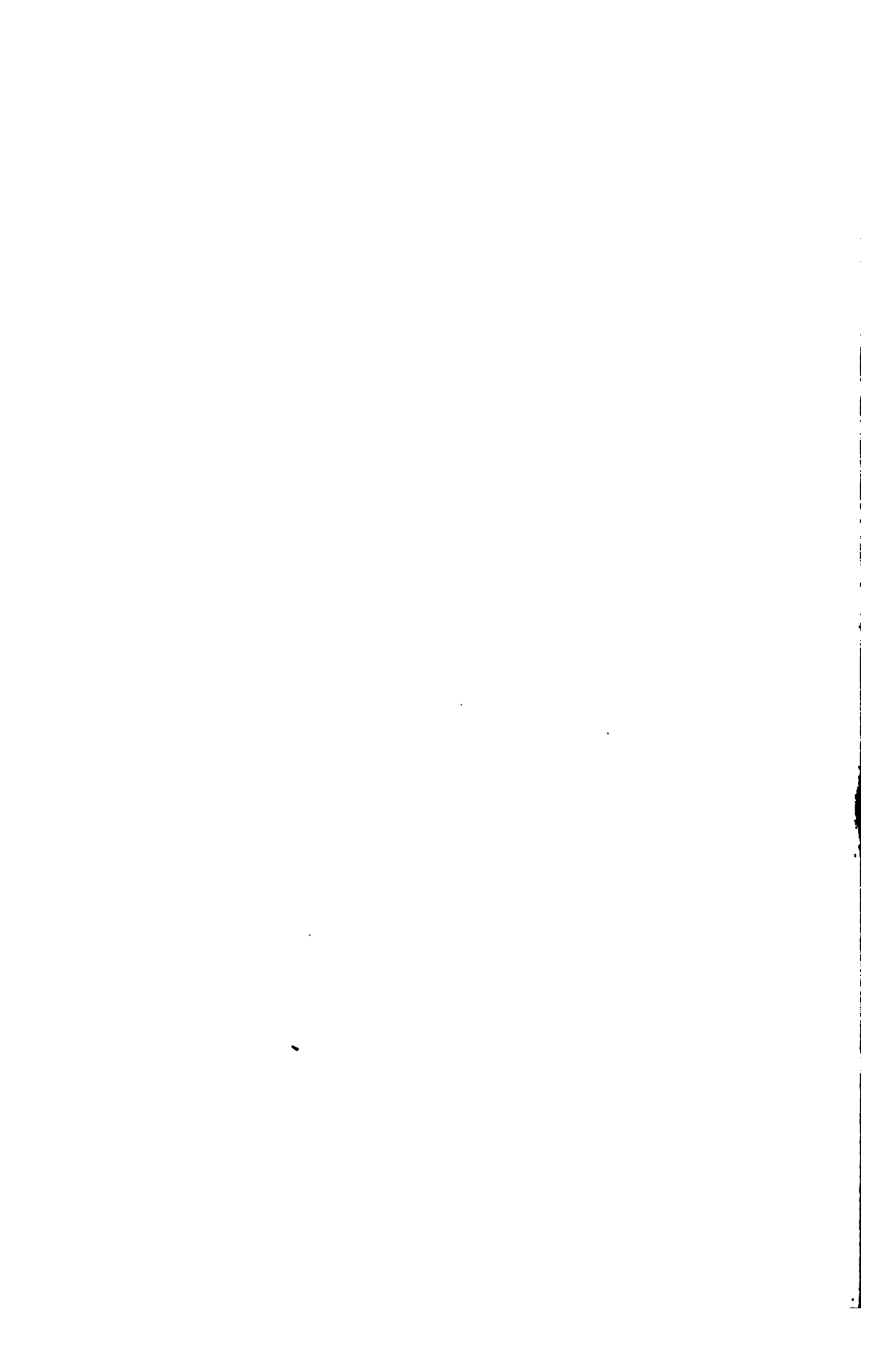


III-E



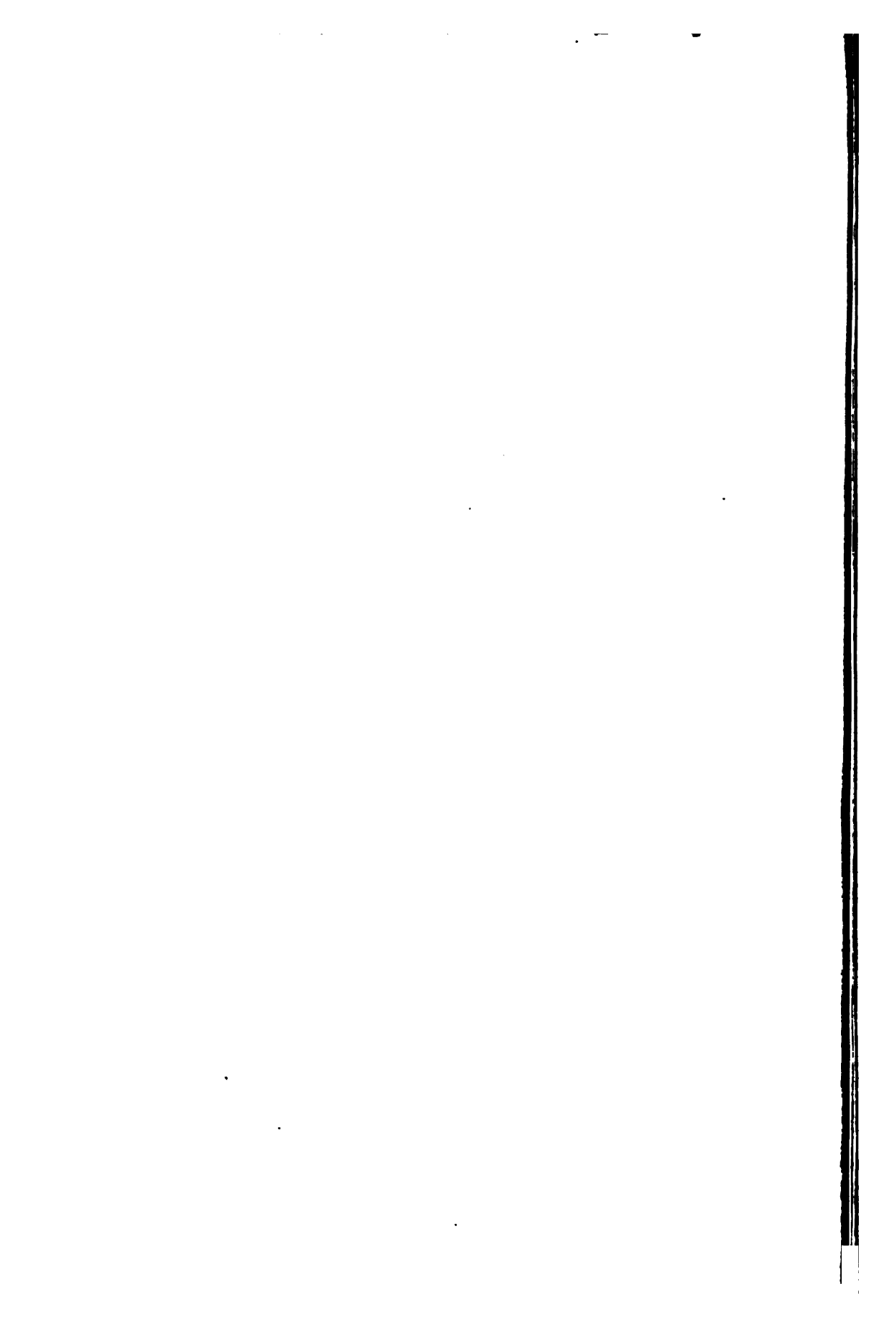
III-F-1

TERRA-COTTA HEADS FROM TEBUTHUACAN.





TERRA-CUTTA HEADS FROM TEOTIHUACAN.



1



2



3



4



5



6

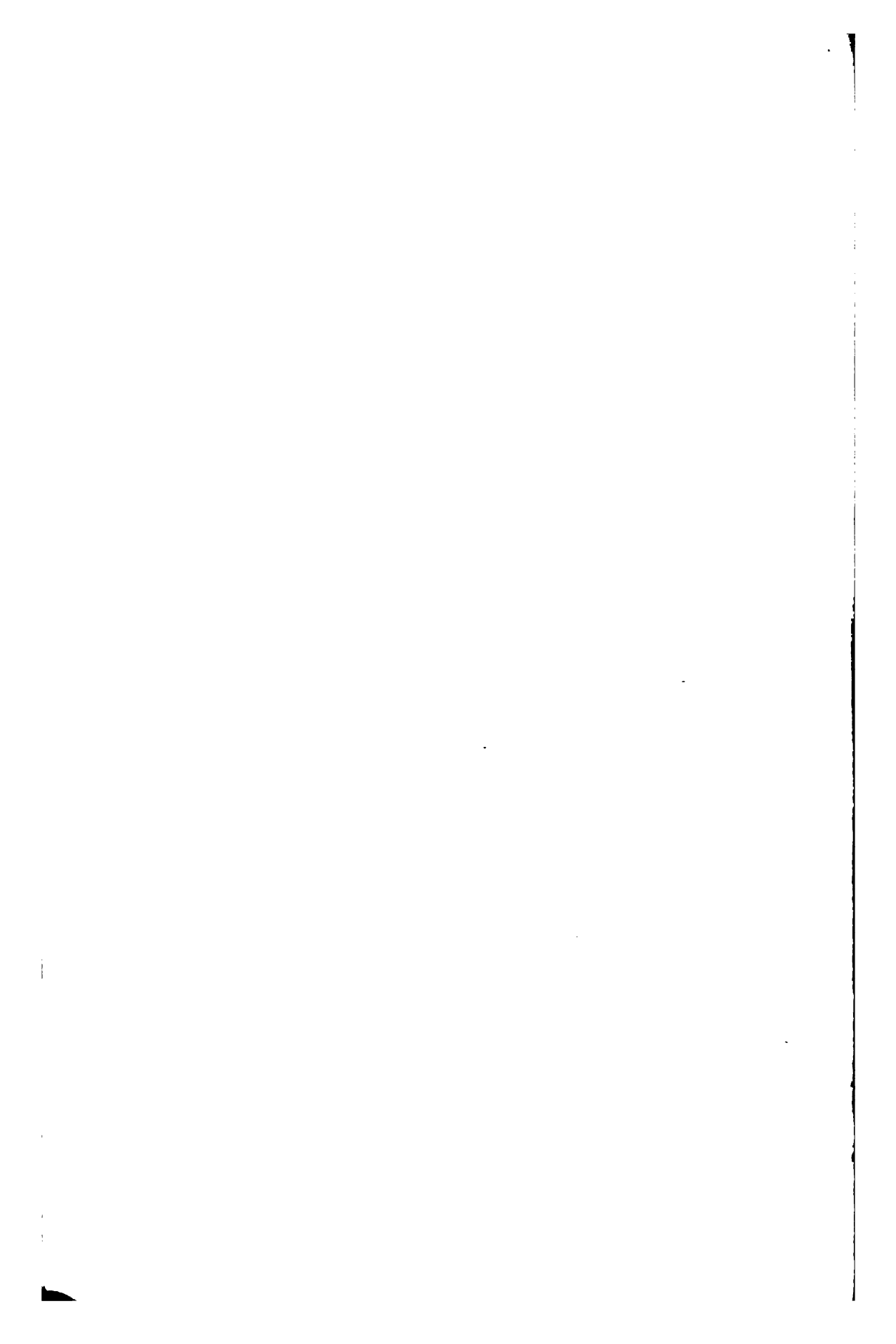


7



8





9



10



11



12



13



14



15



16



17



18



•



I



II



III



IV



V



VI



VII



VIII



IX



X



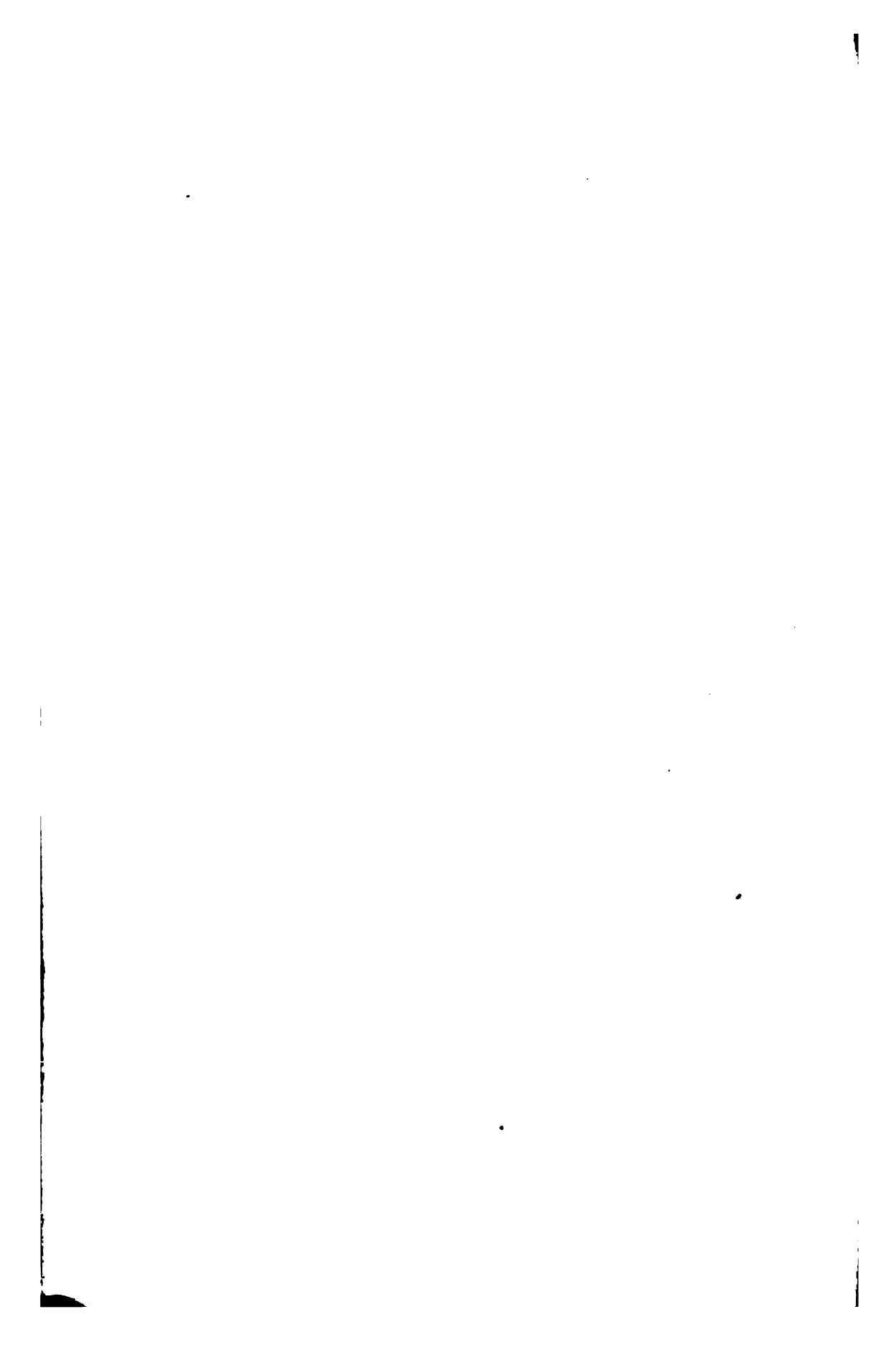


MOSAIC OF PAUL I IN S. MARIA IN TURRI.
(Vatican Basilica, Rome.)





MARBLE HEADS IN THE TCHINLY-KIOSK MUSEUM, CONSTANTINOPLE.





No. 7 (fig. 4).

No. 9 (fig. 6).

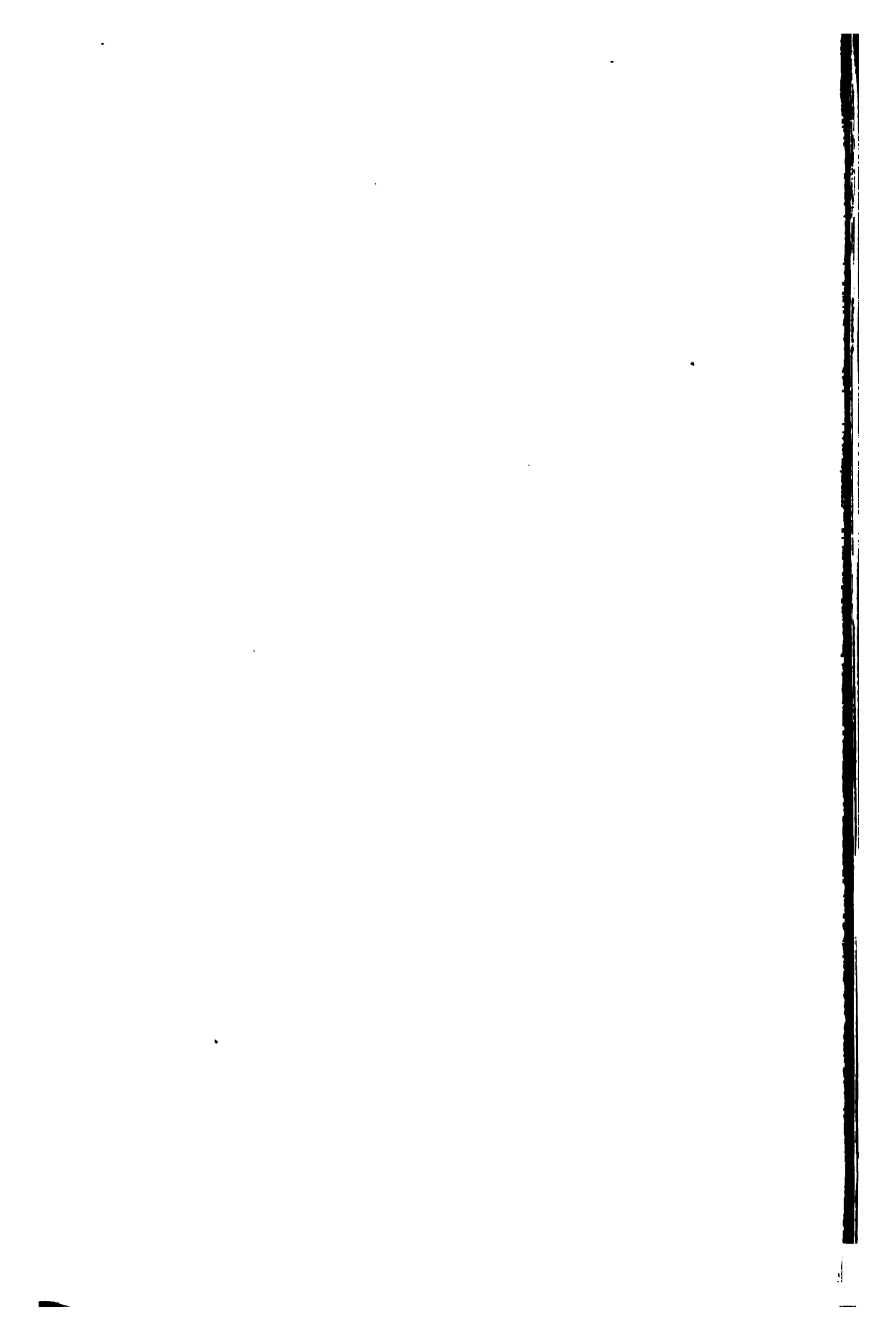
No. 11 (fig. 2).

No. 8 (fig. 1).

No. 10 (fig. 5).

No. 6 (fig. 3).

LEKYTHOI IN METROPOLITAN MUSEUM OF ART, NEW YORK.





1



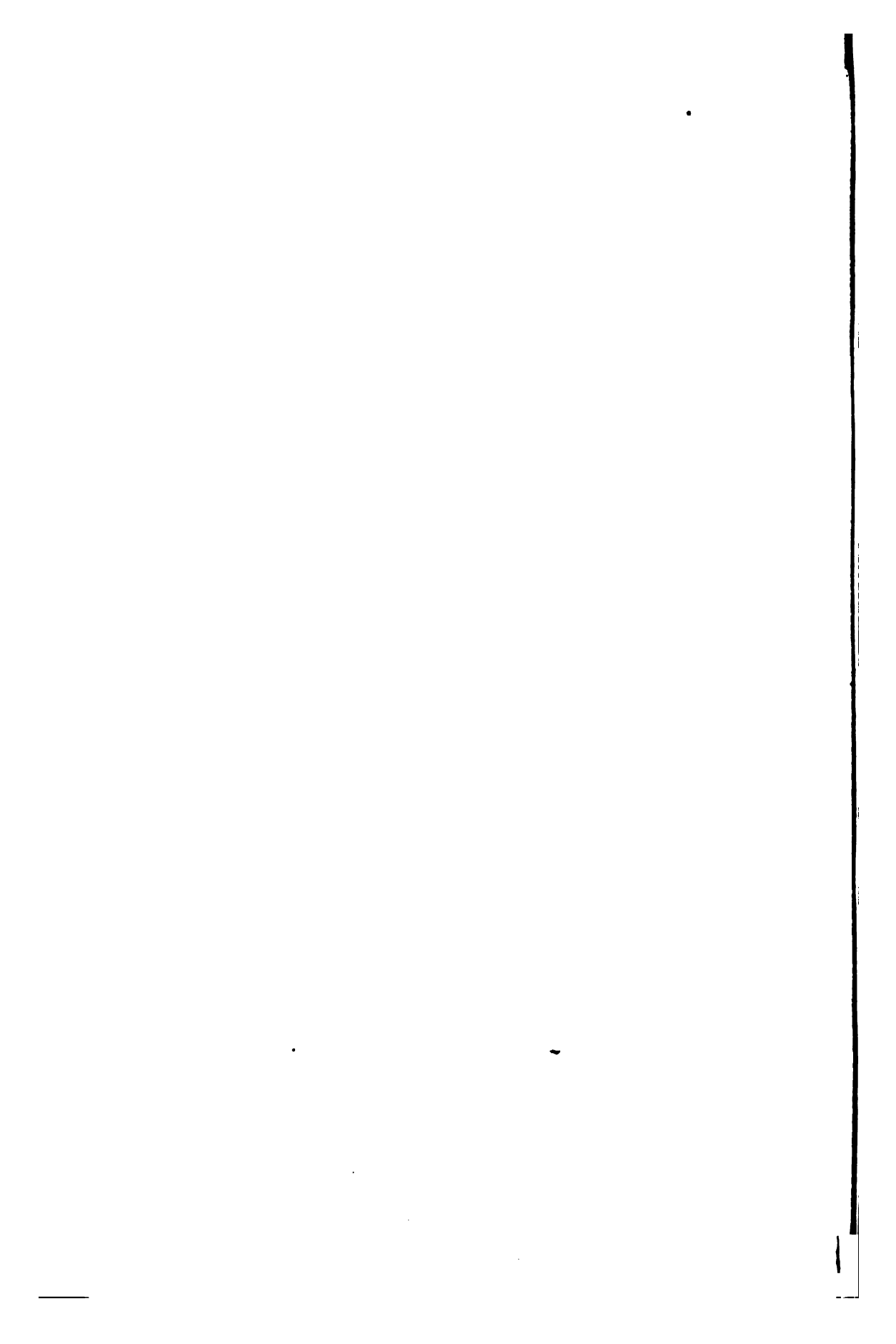
2

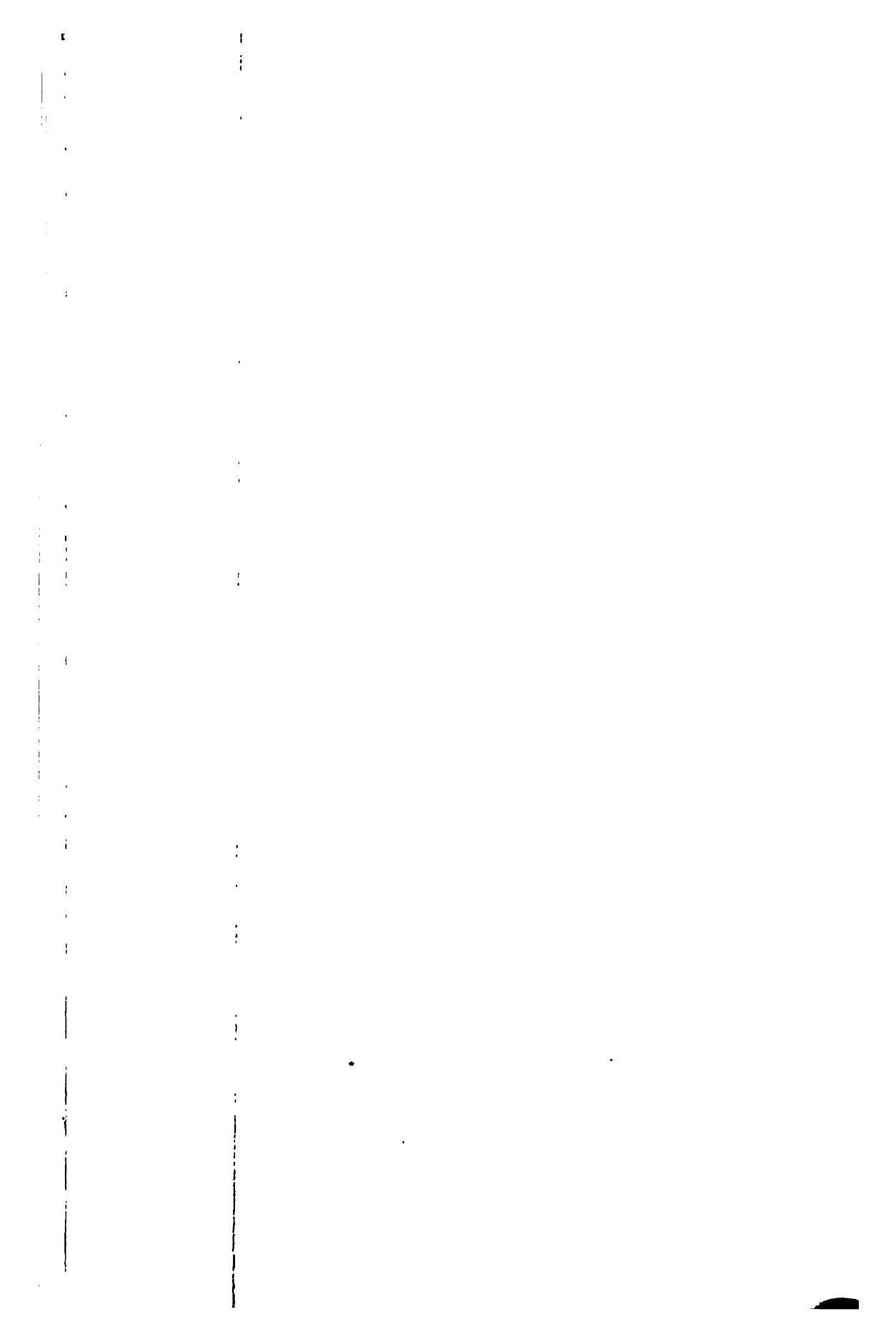
WHITE LEKYTHOS FROM ATHENS.

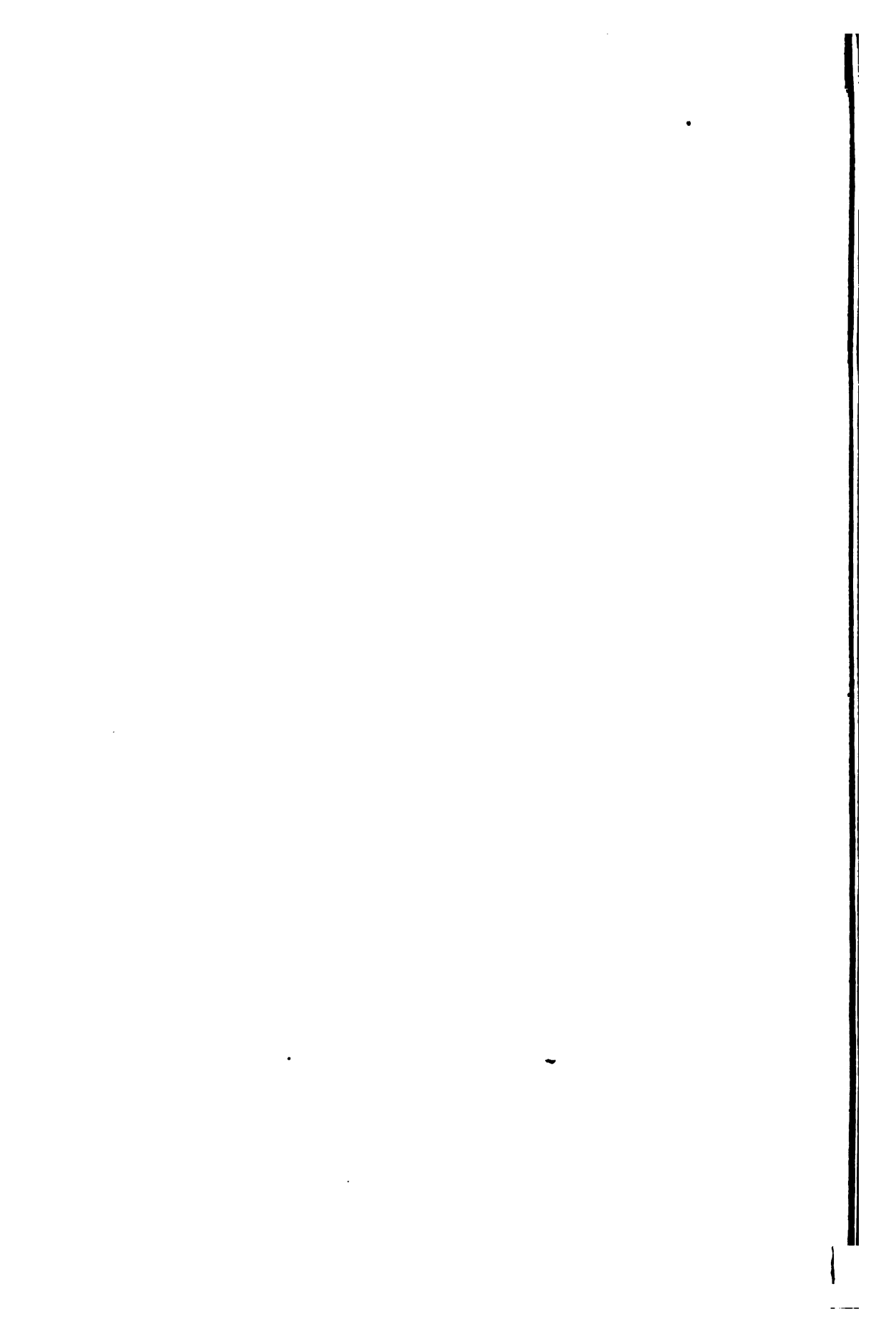
(Described on p. 394, Vase No. 1).

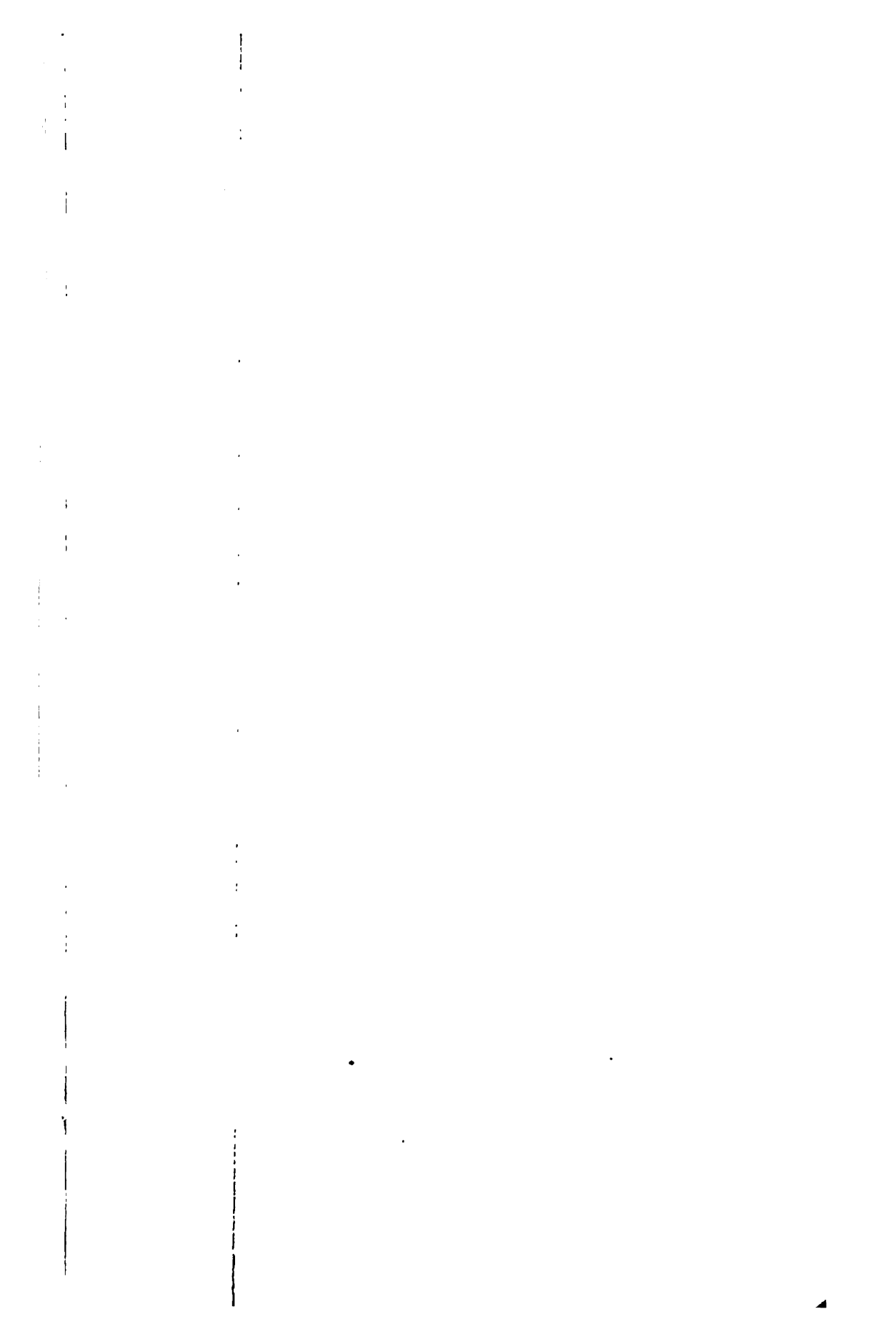
1. Scene at mortuary stele.

2. Palmette ornament on shoulder of vase.

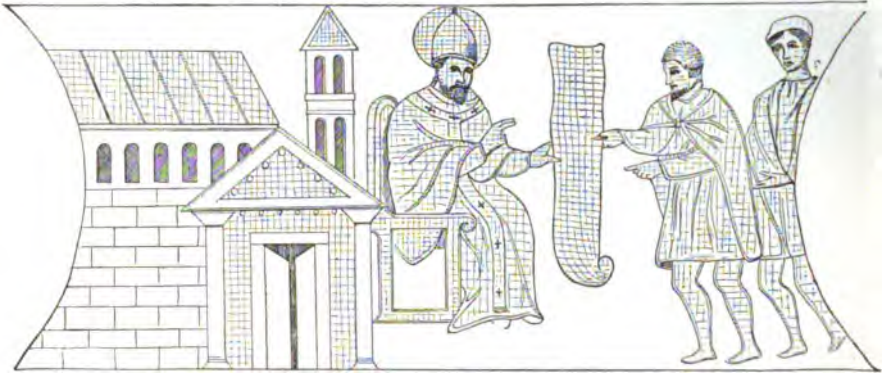




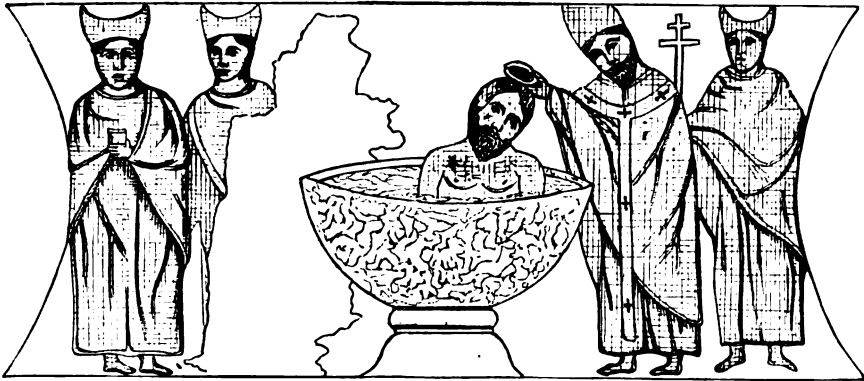








1

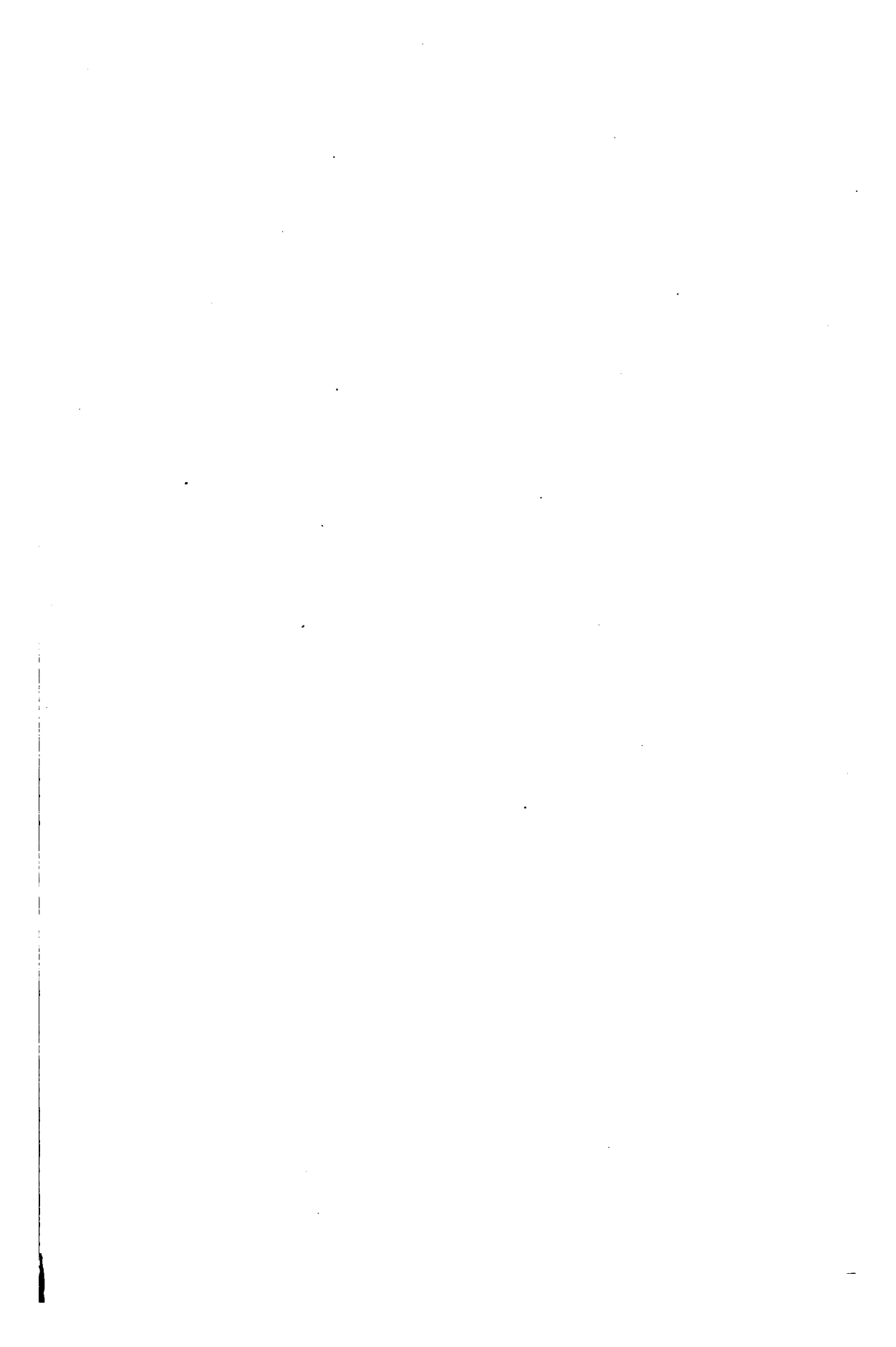


2

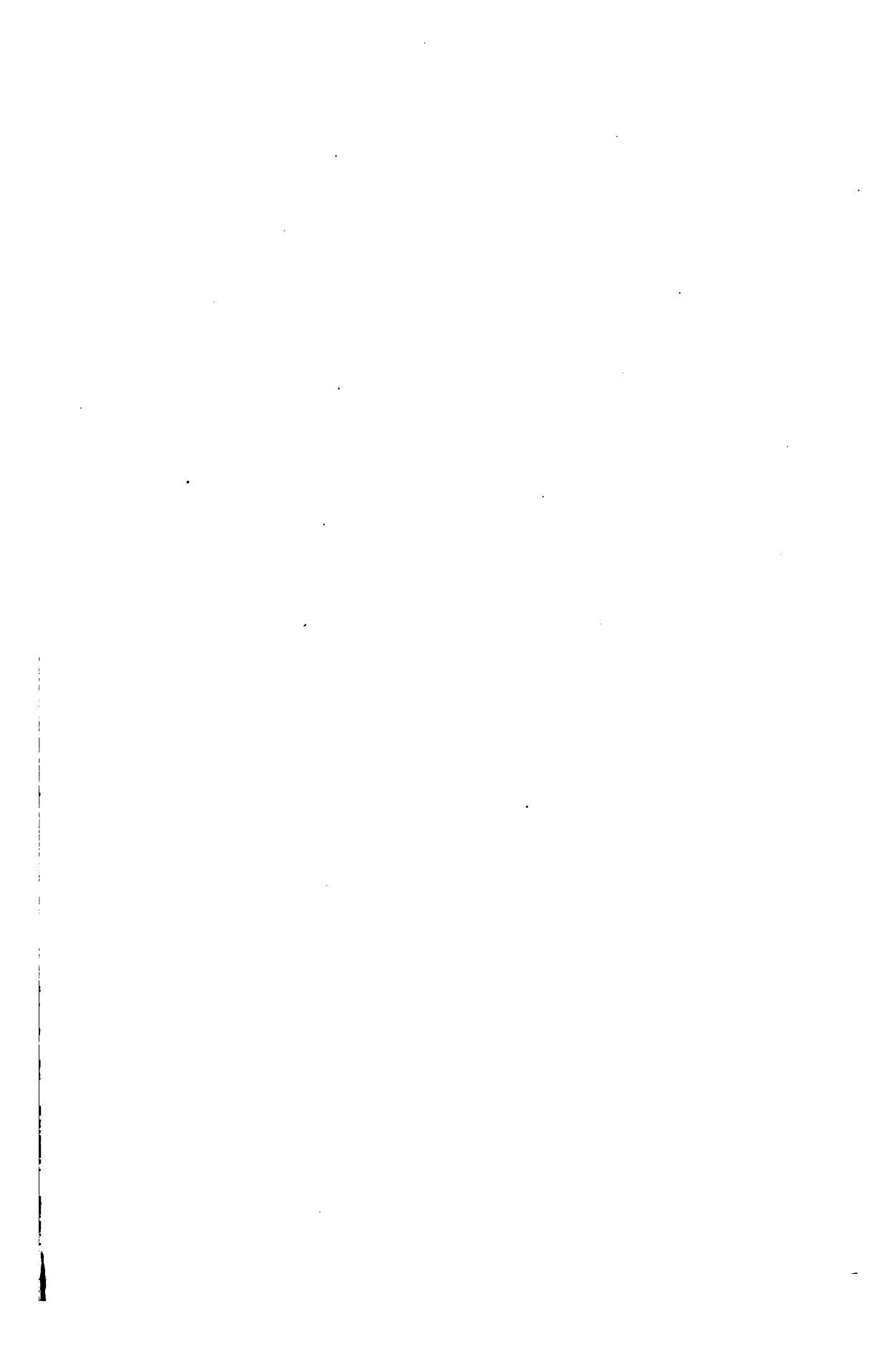
MOSAICS OF THE PORTICO OF THE LATERAN BASILICA (XII CENT.).

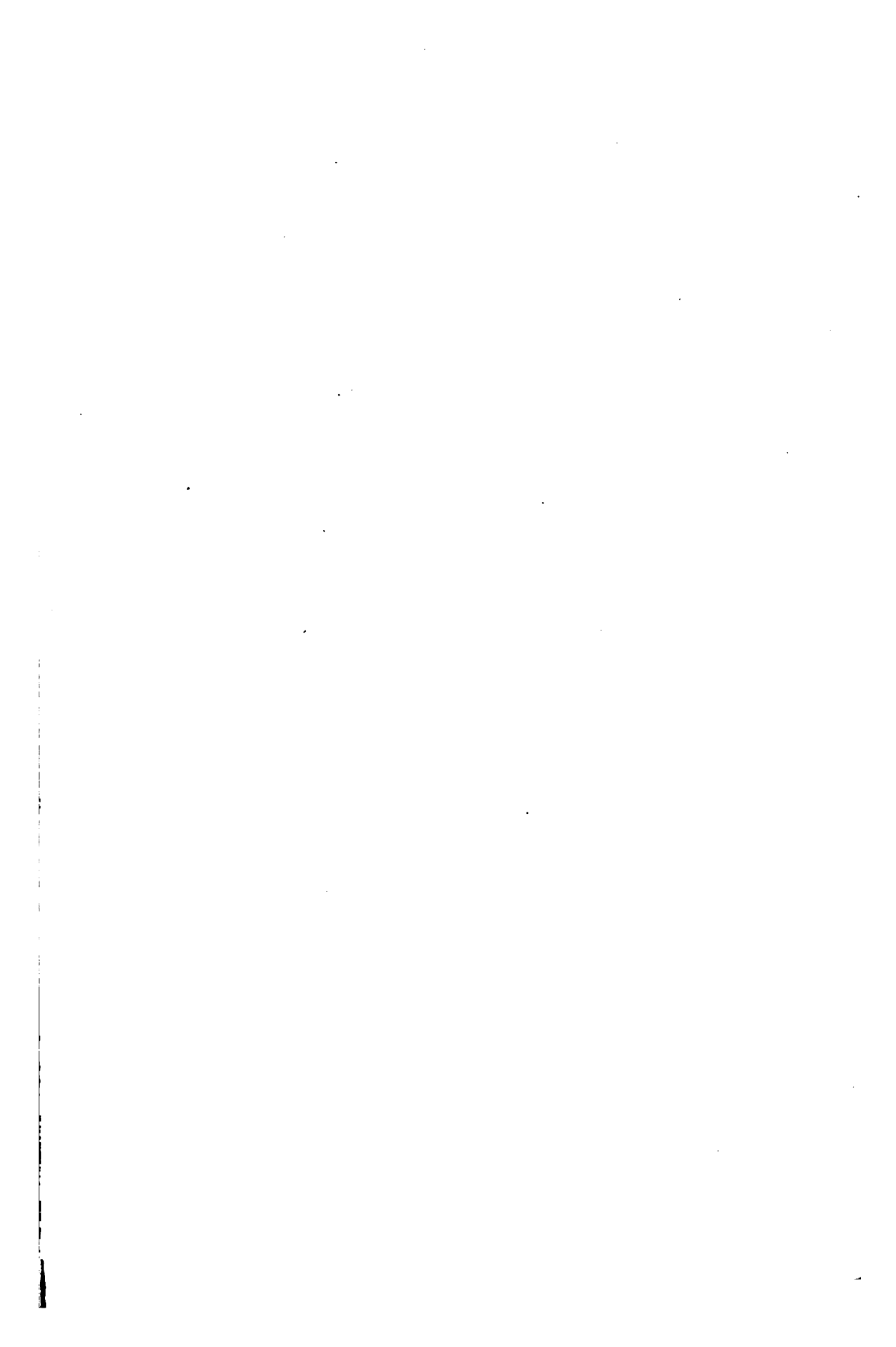
(Reduced from tracings of colored drawings of mid. xvii cent. in Barberini Library, Rome, which were traced from the original mosaics).













FA 1.454(2) 1886

American Journal of Archaeology

DATE	ISSUED TO

FA 1.454(2) 1886

NOT TO LEAVE LIBRARY