





505.73

56

696  
M.H.

THE  
**AMERICAN JOURNAL**  
 OF  
**SCIENCE AND ARTS.**

CONDUCTED BY

**BENJAMIN SILLIMAN, M. D. LL. D.**

Professor of Chemistry, Mineralogy, &c. in Yale College; Corresponding Member of the Society of Arts, Manufactures, and Commerce, and Foreign Member of the Geological Society, of London; Member of the Royal Mineralogical Society of Dresden; of the Imperial Agricultural Society of Moscow; Honorary Member of the Linnæan Society of Paris; of the Natural History Society of Belfast; and  
 Member of various Literary and Scientific Societies in America.

VOL. XVI.—~~JULY~~, 1829.

NEW HAVEN:

Published and Sold by HEZEKIAH HOWE and A. H. MALTBY.  
*Philadelphia*, E. LITTELL & BROTHER.—*New York*, G. & C. & H. CARVILL.—*Boston*, HILLIARD, GRAY, LITTLE & WILKINS.

PRINTED BY HEZEKIAH HOWE.



ALMIRANTE DON ALFONSO

1877

REPUBLICA ARGENTINA

COMANDO EN JEFE

BUENOS AIRES

Excmo. Sr. Ministro de Marina  
Buenos Aires, a los 15 de Mayo de 1877.  
Señor Ministro: Tengo el honor de dirigirme a usted para que se sirva disponer a fin de que se ponga a disposición de este Comando en Jefe el material que se indica en el presente oficio, para que pueda ser utilizado en el momento que se necesite.

Atentamente,  
Alfonso

1877

Excmo. Sr. Ministro de Marina  
Buenos Aires, a los 15 de Mayo de 1877.  
Señor Ministro: Tengo el honor de dirigirme a usted para que se sirva disponer a fin de que se ponga a disposición de este Comando en Jefe el material que se indica en el presente oficio, para que pueda ser utilizado en el momento que se necesite.



## PREFACE.



WHEN this Journal was first projected, very few believed that it would succeed.

Among others, Dr. Dorsey\* wrote to the editor; *I predict a short life for you, although I wish, as the Spaniards say, that you may live a thousand years.* The work has not lived a thousand years, but as it has survived more than the hundredth part of that period, no reason is apparent why it may not continue to exist. To the contributors, disinterested and arduous as have been their exertions, the editor's warmest thanks are due; and they are equally rendered to numerous personal friends for their unwavering support: nor ought those *subscribers* to be forgotten who, occupied in the common pursuits of life, have aided, by their money, in sustaining *the hazardous Novelty* of an American Journal of Science. A general approbation, sufficiently decided to encourage effort, where there was no other reward, has supported the editor; but he has not been inattentive to the voice of criticism, whether it has reached him in the tones of candor and kindness, or in those of severity. We must not look to our friends for the full picture of our faults. He is unwise who neglects the maxim—

—— fas est ab hoste doceri,

and we may be sure, that those are *quite in earnest*, whose pleasure it is, to place faults in a strong light and bold relief; and to throw excellencies into the shadow of total eclipse.

---

\* The late lamented professor of Anatomy in the University of Pennsylvania.

Minds, at once elightened and amiable, viewing both in their proper proportions, will however render the equitable verdict ;

Non ego paucis offendar maculis.—

It is not pretended that this Journal has been faultless ; there may be communications in it which had been better omitted, and it is not doubted that the power to command intellectual effort, by suitable pecuniary reward, would add to its purity, as a record of Science, and to its richness, as a repository of discoveries in the Arts.

But the editor, even now, offers payment, at the rate adopted by the literary Journals, *for able original communications*,\* containing especially important facts, investigations and discoveries in science, and practical inventions in the useful and ornamental Arts.

As however his means are insufficient to pay for all the copy, it is earnestly requested, that those gentlemen, who, from other motives, are still willing to write for this Journal, should continue to favor it with their communications. That the period when satisfactory compensation can be made to all writers whose pieces are inserted, and to whom payment will be acceptable, is not distant, may perhaps be hoped, from the spontaneous expression of the following opinion, by the distinguished editor of one of our principal literary Journals, whose letter is now before me. “The character of the American Journal is strictly national, and it is the only vehicle of communication in which an inquirer may be sure to find what is most interesting in the wide range of topics, which its design embraces. It has become in short, not more identified with the science than the literature of the country.” It is believed that a strict examination of its contents will prove that its character has been decidedly scientific ; and the opinion is

---

\* Of course, with liberty reserved, to return those which are not adapted to his views, or which are beyond his means.

often expressed to the editor, that in common with the Journals of our Academies, it is a work of reference, indispensable to him who would examine the progress of American science during the period which it covers. That it might not be too repulsive to the general reader, some miscellaneous pieces have occasionally occupied its pages ; but in smaller proportion, than is common with several of the most distinguished British Journals of Science. Still, the editor has been frequently solicited, both in public and private,\* to make it more miscellaneous, that it might be more acceptable to the intelligent and well educated man, who does not cultivate science ; but he has never lost sight of his great object, which was to produce and concentrate original American effort in science, and thus he has foregone pecuniary returns, which by pursuing the other course, might have been rendered important. Others would not have him admit any thing that is not strictly and technically scientific ; and would make this a journal for mere professors and amateurs ; especially in regard to those numerous details in natural history, which, although important to be registered, (and which, when presented,† have always been recorded in the American Journal,) can never *exclusively* occupy the pages of any such work without repelling the majority of readers.

If this is true even in Great Britain, it is still more so in this country ; and our savans, unless they would be, not only the exclusive admirers, but the sole purchasers of their own works, must permit a little of the graceful drapery of general literature to flow around the cold statues of science. The editor of this Journal, strongly inclined, both from opinion and habit, to gratify

---

\* A celebrated scholar, while himself an editor, advised me, in a letter, to introduce into this Journal as much "*readable*" matter as possible : and there was, pretty early, an earnest but respectful recommendation in a Philadelphia paper, that *Literature*, in imitation of the London Quarterly Journal of Science, &c. should be in form, inscribed among the titles of this work.

† No scientific communication that has been thought worthy of admission into this Journal, has ever been refused.

the cultivators of science, will still do every thing in his power to promote its high interests, and as he hopes in a better manner than heretofore ; but these respectable gentlemen will have the courtesy, to yield something to the reading literary, as well as scientific public, and will not, we trust, be disgusted, if now and then an *Oasis* relieves the eye, and a living stream refreshes the traveller. Not being inclined to renew the abortive experiment, to please every body, which has been so long renowned in fable ; the editor will endeavor to pursue, the even tenor of his way ; altogether inclined to be courteous and useful to his fellow travellers, and hoping for their kindness and services in return.

Yale College, July 1, 1829.

---

The Chemical Text Book for the students of Yale College, and for other students of Chemistry, is now in the press, and may be expected in the month of September.

CONTENTS TO VOLUME XVI.

NUMBER I.

	Page.
ART. I Prof. E. Mitchell, on the Geology of the Gold Region of North Carolina, - - - - -	1
II. Examination of a substance called Shooting Star ; by Counsellor Dr. BRANDES, of Salztuthen. (Translated from the German,) - - - - -	20
III. Observations and Experiments on Peruvian Bark ; by GEORGE W. CARPENTER, of Philadelphia, - - - - -	28
IV. Observations on a New preparation of Balsam Copaiva ; by GEORGE W. CARPENTER, of Philadelphia, - - - - -	40
V. Notice of the appearance of Fish and Lizards in extraordinary circumstances ; by JOSEPH E. MUSE, M. D. - - - - -	41
VI. Meteorological Observations ; by S. P. HILDRETH, M. D. - - - - -	44
VII. Calendar of Vegetation ; by A. W. BOWEN, - - - - -	48
VIII. Strictures on the Hypothesis of Mr. Joseph Du Commun, on Volcanos and Earthquakes ; by BENJAMIN BELL, - - - - -	51
IX. A Discourse on the different views that have been taken of the Theory of Fluxions ; by ELIZUR WRIGHT, - - - - -	53
X. Variation of the Magnetic Needle, - - - - -	60
XI. Prof. OLMSTED'S Meteorological Report for the year 1828, - - - - -	70
XII. On the variations of level in the great North American Lakes ; by Gen. H. A. S. DEARBORN, - - - - -	78
XIII. On the observations of Comets ; by P. J. RODRIGUEZ, - - - - -	94
XIV. On the Effect of the Physical Geography of the World on the Boundaries of Empires ; by JOHN FINCH, F. B. S., M. S. D. &c. &c. - - - - -	99
XV. On the Manufacture of Glass ; by HORATIO N. FENN, M. D. - - - - -	112
XVI. Polar Explorations, - - - - -	124
XVII. Motion, the Natural State of Matter, - - - - -	151
XVIII. Facts relating to Ohio and Mexico, - - - - -	154

## INTELLIGENCE AND MISCELLANIES.

1. The national historical pictures, By Col. Trumbull,	163
2. New book of Travels,	168
3. The number five, the most favorite number of nature ; by A. E.	172
4. Alcohol, or spirituous liquors, from succulent and farinaceous fruits, and herbage of plants ; by A. E.	173
5. A. A. Hayes, on the use of alumina with pigments designed for the pallet,	173
6. A. A. Hayes, on a fine scarlet pigment for the pallet,	174
7. Dr. B. L. Oliver's use of iodine in gout and angina pectoris,	176
8. G. W. Carpenter's notice of the manufacture of the chloride of lime, and of some of its leading uses, Jan. 1829,	177
9. Specimens in Materia Medica, Pharmacy, and Chem- istry,	179
10. Dr. J. Revere's improvement in the construction of ships and other vessels, as respects their metallic fastenings, and sheathing,	180
11. Steam Pump,	181
12. Dr. Church on the efficacy of ammonia in counteract- ing poison,	182
13. S. Allison, on the Atomic Weight of Mercury,	183
14, 15. J. C. Keeney on the Novaculite in Georgia—Mr. Finch's notice of the locality of the Bronzite, or Diallage metalloide ; at Amity, Orange county, N. Y.	185
16. Dr. L. C. Beck's note on the presence of Iron in the Salt Springs of Salina, N. Y.	187
17. Tin in Massachusetts ; by Professor Hitchcock,	188
18. Mr. C. U. Shepard's mineralogical and chemical de- scription of the Virginia Aerolite,	191
19. C. U. Shepard on Native Soda Alum, in Milo,	203
20. Proceedings of the Lyceum of Natural History of New York,	205
21. Baron de Zach—Liberty of opinion and the press— Education—General views of Europe, &c.	209
22, 23. Literary notice—Obituary,	211
24. Carbonic Acid of the Atmosphere,	214
25, 26, 27. Autumnal coloration of Leaves—Singular Galvanic trough—On a method of measuring some varieties of Chemical action, by M. Babinet,	215
28, 29. Sulphur—Dr. Wollaston,	216

## NUMBER II.

	Page.
ART. I. Analysis of the Meteoric Iron of Louisiana, and discovery of the Stanniferous Columbite in Massachusetts; by C. U. SHEPARD, - - -	217
II. Prof. Bessel, on Mr. F. R. Hassler's views as to an accurate survey of the coast of the United States. Communicated by Prof. JAMES RENWICK, of Columbia College, New York, - - -	225
III. Prof. Mitchell, on the Effect of Quantity of Matter in Modifying the Force of Chemical Attraction,	231
IV. Iodine in the Mineral Waters of Saratoga. Communicated by JOHN H. STEEL, M. D. - - -	242
V. Observations on Ignis Fatuus; by Rev. JOHN MITCHELL, - - - - -	246
VI. Resuscitation by Oxygen Gas, from apparent death by drowning, - - - - -	250
VII. Lieut. Wilkes' account of Hassler's Repeating Theodolite, - - - - -	252
VIII. Prof. Vanuxem, on the characters and classification of certain American Rock Formations, - - -	254
IX. Translations and abstracts from the French; by Prof. GRISCOM, - - - - -	257
X. Action of Sulphuric Acid on Alcohol, and the products which result from it. Translated and abridged from the French, by Prof. GRISCOM,	267
XI. Algebraic Solution; by Mr. C. WILDER, of New Orleans, - - - - -	271
XII. Solution of a Problem in Fluxions; by Prof. THEODORE STRONG, - - - - -	283
XIII. Meteorological Table, with Remarks; by Gen. MARTIN FIELD, - - - - -	288
XIV. Speculations with respect to the cause of the Aurora Borealis or Northern Lights, - - -	290
XV. Chemical Instruments and Operations; by Prof. ROBERT HARE, M. D. - - - - -	293
XVI. Argillite, embracing Anthracite Coal; by Prof. AMOS EATON, - - - - -	299
XVII. Telescopes—Life of Fraunhofer, - - - .	301
XVIII. Cooper's Rotative Piston, - - - - -	313
XIX. Sketches of Naval Life, &c. with remarks and extracts by the Editor, - - - - -	320
XX. Dr. Steel's description of the High Rock Spring, at Saratoga, with a drawing, - - - - -	341
XXI. Real and supposed effects of igneous action,	345

## INTELLIGENCE AND MISCELLANIES.

	Page.
1. Report to the Lyceum of New York, on the splendid work of Mr. Audubon upon the Birds of North America, - - - - -	353
2. Proceedings of the Lyceum of Natural History of New York, - - - - -	354
3. Memorial, - - - - -	358
4. Gold mines of North Carolina, - - - - -	360
5. Pettengill's Stellarota, - - - - -	363
6. Dr. Hare, on the precipitation of morphia from laudanum by ammonia; also a spontaneous deposition of narcotin, - - - - -	365
7. An account of an extraordinary explosion, arising from the reaction of nitric acid with phosphorus; by the author of the preceding article, - - - - -	366
8. Collections in Natural History, - - - - -	368
9. Carpenter's Powders, for making Congress Spring or Saratoga Waters, - - - - -	369
10. Dr. Wollaston's scale of chemical equivalents, - - - - -	371
11. Notice of a projected improvement in the method of blasting rocks, &c. - - - - -	372
12. Mode of decoying wild pigeons in New England, - - - - -	373
13, 14. Ohio oil stone—Report of the Chester county cabinet, Pennsylvania, - - - - -	374
15. Chalcedony, - - - - -	375
16, 17. Uniform nomenclature in Botany—Vegetable Chemistry, by C. Conwell, M. D. Philadelphia, - - - - -	376
18, 19. Group of crystals of common salt—Fibrous gypsum of Onondago County, New York, - - - - -	377
20, 21, 22. Conchology of the United States—Natural History in Canada—Swainson's new zoological illustrations, - - - - -	378
23. Cabinet of the late William Phillips, - - - - -	379
24. Canada, - - - - -	380
25. Remains of the Mammoth, - - - - -	382
26, 27. Two kinds of Sulphate of Manganese—Preparation of Hydriodic Acid, - - - - -	383
28, 29. Pluranium—Bichromate of Potash, - - - - -	384
30, 31, 32. Compound of Cyanogen and Sulphur—Citric Acid from Gooseberries—Medical uses of Gold, - - - - -	385
33. Congress of Savans at Berlin, - - - - -	386
34, 35, 36. Detection of Potash by the Oxide of Nickel—Apparatus for saturating any liquid with gas and without loss of the fluid—Memoir on the Chloride of Lime, - - - - -	387



	Page.
37, 38. Alcohol—Rapidity of the Circulation of the Blood,	388
39, 40, 41. Remarkable phenomenon in a medicinal compound—Discovery of iodine in the ore of zinc—Size of the grains of native platina,	389
42, 43, 44, 45. Observations on the evaporation of ice—Swiftmess of Sound—On the colored flame of Alcohol—Electricity of the Tourmaline	390
46, 47. New method of preserving crystallized salts—Conversion of potatoe flour into nutritious bread,	391
48. Means of detecting the purity of chromate of potash,	392
49. Decoloring action of Charcoal,	393
50, 51. Manufactory of diamonds—Leeches,	394
52, 53 54, 55, 56. Chloride of lime in psora—Iron furnaces in England and Scotland—New process for obtaining gallic acid—Action of iodine on protochloride of mercury—New method of preparing the deutoxide of barium,	395
57. Precipitation of albumen by phosphoric acid,	396
58, 59, 60, 61. New fulminating powder—New compounds of silica and potash—Marine salt—Delicate test of oxygen in a gaseous mixture,	397
62. Optical amusements,	398
63, 64. Corrosive sublimate—Gossamer spider,	399
65. Obituary of Dr. John Gorham,	400

### ERRATA FOR VOL. XVI.

- Page 53, line 13 from top, for *principal* read *principle*.  
" 59, " 10 from bottom, do. do.  
" 94, " 19 from top, for *light* read *slight*.  
" 218, " 10 from top, for *give* read *gave*.

---

### ADDITION.

In Dr. Hare's process for weighing gases, page 294, line 20, after *gas*, read, If the gas be heavier than air, we must add the weight, necessary to restore the equilibrium to 30.5 grains; and the sum will be the weight of one hundred cubic inches of the gas.

---

The editor wishes it to be understood, that the genuineness of Mr. Carpenter's imitation of the Saratoga waters, rests exclusively upon his own authority, no examination of the powders having been made here.

THE  
AMERICAN  
JOURNAL OF SCIENCE, &c.

---

ART. I.—*On the Geology of the Gold Region of North Carolina, in a letter to the Editor, dated Aug. 25, 1828; by ELISHA MITCHELL, Professor of Chemistry, Mineralogy, and Geology, in the University of N. Carolina.*

TO PROFESSOR SILLIMAN.

*Dear Sir*—It is with some hesitation and reluctance, that I crave a place in the Journal, for a paper upon a subject that has already twice occupied the attention of your readers—the gold mines of N. Carolina—of which there is an account from the pen of Professor Olmsted in the ninth, and another by Mr. Charles E. Rothe in the thirteenth volume. Both of these communications include some notices of the geological composition and structure of the district in which the precious metal occurs. The first appears to contain one leading and important error, (such as it is difficult to avoid during a first examination) which is beginning to be propagated into other books;\* and if it contain but one, it will follow that the other has but slender claims to accuracy, since the two are so much at variance with each other, that it must be quite impossible for a person who has never been upon the spot, to arrive *by a collation* of the two accounts, at any probable conclusions respecting the geological character of that part of North Carolina in which the gold is found. This will be evident from a comparison of the following extracts.

Professor Olmsted remarks, that “*The prevailing rock in the gold country is argillite.*” This belongs to an extensive

---

\* See Comstock’s Mineralogy, page 176. Robinson’s Catalogue, page 211.

formation of the same which crosses the state in numerous beds, forming a zone more than twenty miles in width, and embracing among many less important varieties of slate, several extensive beds of novaculite or whetstone slate, and also beds of petro-siliceous porphyry and of greenstone. *These last lie over the argillite, either in detached blocks or in strata that are inclined at a lower angle than that.* This ample field of slate I had supposed to be the peculiar repository of the gold, but a personal examination discovered that the precious metal, embosomed in the same peculiar stratum of mud and gravel, extends beyond the slate on the west, spreading in the vicinity of Concord, over a region of granite and gneiss."

Mr. Rothe says, on the other hand, that "*Granite is the base of the formations of the gold region of North Carolina.*" By this it is not meant apparently that granite is the rock upon which the others are incumbent; and which is therefore covered up by them, but that it is the predominant rock—for a description immediately follows. "It is constituted of coarse crystals, and *its surface is very irregular.* On its more elevated situations it has been much worn by water in early times, and now lies exposed at places on the surface of the earth, in large masses, some of them round, as on the small mountain four miles south-east of Salisbury. *In the lower part of the country greenstone and greenstone slate are commonly found in beds in the granite.*"\* "These remarks," he says again, "were necessary to a correct understanding of the veins in the greenstone formation, embracing the gold region of North Carolina."

With regard to the repository of the gold, Mr. Olmsted remarks, that, "In almost any part of this region, gold may be found in greater or less abundance at or near the surface of the ground. Its true bed however is a thin stratum of gravel inclosed in a dense mud, usually of a pale blue, but sometimes of a yellow color. On ground that is elevated and exposed to be washed by rains, this stratum frequently appears at the surface, and in low grounds where the alluvial earth has been accumulated by the same agent, it is found to the depth of eight feet. Where no cause operates to alter its

---

\*This greenstone is *secondary*, as appears by note *d.* "I have followed this formation of *secondary* greenstone, passing into hornblende, in a north-east direction from Salisbury as far as the Virginia line."—*Rothe's Remarks.*

original depth, it lies about three feet below the surface. Rocky River and its small tributaries, which cut through this stratum, have hitherto proved the most fruitful localities of the precious metal."

"It will probably appear evident to geologists from the foregoing statements, that *the gold of N. Carolina occurs in a diluvial formation.*"

Mr. Rothe says, "We here find the gold in two different situations. 1. As a part of the constituents of the veins. 2. We not only find gold as a constituent of the veins, but also in alluvial deposits in the ranges of the greenstone formation. On a former occasion, I expressed an opinion that this country must, in ages past, have experienced an inundation. This overflowing was perhaps occasioned by an accumulation of waters on the other side of the Blue Ridge, which, breaking over the ridge at some of the points now lowest, spread itself in rapid torrents over this region; and at places breaking up the veins containing gold, scattering them over the surface. An accumulation of water must, at one time, have taken place above the range of little mountains which are cut by the Yadkin river at the place called the Narrows. For at the Narrows, are evident marks on the rocks of the acclivous banks, shewing that the water was once many feet above its present bed, and the highest hills, as you go up the country, are covered with alluvial deposits. The break may have taken place at the Narrows, that happening to be the softest place, and thus gradually letting the waters off."

"By this means, or perhaps others, the *gold now found in the alluvial deposits* has been removed from the veins and scattered as far as the waters had influence over it."

Of the two accounts, that of Professor Olmsted certainly appears to me the more correct, though not (as I have already mentioned) exempt from error. It has occurred to me that if the gold mines of North Carolina were entitled to the space they have already occupied on the pages of the Journal, a few additional observations, which can hardly increase the obscurity and darkness that overhangs the subject, and whose object it will be to remove it, at least in part, will be neither inappropriate nor unacceptable, especially if accompanied by a map that shall render all that has hitherto been written respecting them more intelligible.

1. The discovery of gold in considerable quantity, in veins of quartz, traversing the rock formations of the district, in a number of different places remote from each other, renders less probable the opinion that it belongs, in any instance, to a proper *diluvial* formation. Our attention is drawn at once to the rocks themselves, as the probable source from which *the whole of it* is derived.

2. It does not appear that any such formation or stratum as the diluvial occurs in any of the central or western parts of N. Carolina.

As the opinion expressed in this proposition, together with some others enunciated in a former communication to the Journal, and to be treated of at some length in the following pages, is at variance with what has been heretofore advanced and believed in relation to the geology of this part of the United States, it is perhaps proper that I should mention the circumstances under which a full and undoubting confidence in their correctness has been created.

a. Professor Andrews and myself commenced together an examination of the geology of N. Carolina in the latter part of the year 1825, and were led almost immediately to the adoption of some new views upon the subject; especially we were induced to suspect—1. That no stratum of any kind whatever, except what has been derived from their own decomposition, covers the rock formations of the upper country; and 2. That an extensive tract, extending into Virginia on the one side, and into S. Carolina on the other, laid down as primitive by Maclure, and denominated “The Great Slate Formation,” by Professor Olmsted, (see last Number of the Journal, page 236) is in fact a transition formation—the former opinion originating, as believed, with Mr. Andrews, and the latter with myself. During the three years (nearly) that have intervened, all the counties of the upper country have been visited, and many of them traversed in a number of different directions. Throughout the whole examination, one object—the ascertaining whether our views upon the points above mentioned were correct or erroneous, has never been lost sight of; and though it is impossible to keep the attention at all times so thoroughly awake, that we may be sure nothing has escaped us—the limits of such a stratum, if it exist, must be exceedingly circumscribed, since no where, except in the immediate neighborhood of the rivers, has any soil been *observed*, which did not appear to have resulted

from the decomposition of rocks, which, if they did not occupy the identical spot, at least lay in the immediate neighborhood. Circumstances which I have deeply regretted, have prevented Mr. Andrews from extending his researches to parts remote from the University; for the truth and propriety of the remarks upon which I am alone responsible, but in the correctness of the proposition now before us, we both, as I believe, repose equal and entire confidence.

b. Whilst coming to these conclusions with regard to the upper country of N. Carolina, there has been no disposition to deny that something very different obtains in other parts of the world. The immense collections of sand, loam and gravel, that are piled up over the primitive rocks, in many parts of the New England States, were distinctly recollected.\* It was not therefore through ignorance of the appearances created by a stratum of foreign matter, or through a general scepticism upon the subject, blinding our eyes and unfitting us for the task of observation, that we failed to find any.

c. The tracing of the boundaries of the alluvial district afforded an opportunity of learning to detect, without difficulty, the presence of foreign loam, sand and gravel in the natural soil. I stated in a former communication the existence of a zone of a peculiar character, stretching across the state, and exhibiting these substances upon the high grounds, whilst in the neighborhood of the streams, the soil is evidently

---

\* It has appeared to the writer of this article, that the individual who, without paying any attention to the subjacent rocks, farther than might be necessary to the prosecution of his main design, should make these collections, whatever be the title (and I am doubtful whether it be Geest, Diluvion, Ante, Ultimate or Post-Diluvion, or any other than that by which they are here called—collections of sand, loam and gravel, having their origin perhaps in a cause that has not operated elsewhere upon the surface of the globe) that is appropriate to them, a particular object of investigation—ascertain their northern, southern and western boundary—the route along which the accumulations are most abundant, and the diversity of character presented at points remote from each other—would render an essential service to the geology of these United States—perhaps find a clue that would lead us back to their origin.

In this introduction of the terms recently proposed by Professor Eaton, I trust I shall not be regarded as wanting in respect to that gentlemen, of the value of whose contributions to the science I am well aware, and by the perusal of whose writings I am happy to have profited. I wish however that anterior to the publication of the promised volume he could find leisure to visit the southern States. Werner's principal error lay in generalizing from too narrow an induction of particulars, and making the little mountains of Saxony a type of the world.

formed from rocks that have undergone decomposition in their original beds. After crossing this zone in a number of different directions, and watching for the last sand-bank that communicates a shading to the soil of the upper country, there was the less danger of a mistake in regard to the presence or absence of analogous appearances in the counties farther west, where they are believed to be altogether wanting.

The non-existence of a foreign stratum, whether diluvial or alluvial, may be inferred from such circumstances as the following.

a.) The absence of rounded pebbles and gravel throughout the entire surface of the country.

b.) An intimate agreement and resemblance, every where observed, between the underlying rock, the stones scattered over the surface, and the gravel, down to its minutest particles, in regard to composition, structure and the whole range of mineralogical characters.

c.) When the rocks do not form any gravel at all, but are resolved at once by the decay of their exterior crusts into a fine powder—a similar agreement between the mass of the soil and those half-decomposed crusts, in respect to color and other physical qualities.

d.) Veins, whether of quartz, or of a harder variety of the same rock, remaining only partially decomposed, and enveloped in soil which has proceeded from the softer portions. These appearances are particularly remarkable and striking when a road passes through an ancient forest, or when a gulley is worn in a declivity that has never been cultivated. The veins are here seen ascending, if not to the *very* surface, at least so near, as to render the existence of a diluvial stratum a matter of no uncertainty.

e.) Without descending to these minutiae, if a person moderately acquainted with geology, will ride across the country, and observe how suddenly and invariably, a change in the subjacent rock is attended by a change in the character of the soil, his doubts, if he had any, will be removed.

But as these marks and evidences of the absence of diluvium occur in the gold region as well as in other parts of the country, we infer, that it does not exist there, and of course that the gold of North Carolina does not occur in a *diluvial* formation. I might urge further, if further argument shall be deemed necessary, the improbability that whilst a thin



auriferous stratum, brought no one knows from whence, was spread by the deluge over hill and valley, through an extent of one thousand square miles, so that gold may be found in greater or smaller quantity in any part of this area, the precious metal should be so accumulated on some points as to form a mine—accumulated, for instance, for a quarter of a mile along the bed of Meadow Creek in Cabarrus, in masses weighing from twenty-seven pounds to the fraction of a grain, in such quantity as to be worked to advantage, after having been already explored for a term of twenty-eight years. There is no conceivable mode of diluvial action that would produce this combination of appearances. A gradual rise of the waters is inconsistent with the transportation of such masses of gold—a rapid current with its general distribution over the whole surface of the country.

Mr. Rothe refers the gold, in part, to veins of quartz traversing ranges of *secondary* greenstone and greenstone slate, and in part to an *alluvial* stratum created by a flood of waters which broke over the Blue Ridge; spread itself over the district lying below; tearing up and dispersing over the face of the country the veins of quartz containing the precious metal; and finally forced for itself a passage through the mountains that form the Narrows, and so passed off to the sea.

With regard to the existence of this *alluvial* formation, and the hypotheses proposed to account for it, the following remarks may be offered.

1. Of all the causes that have been called in to explain the appearances presented by the surface of the globe, there is perhaps none that has been more abused, than this of currents and inundations. That these agents have changed the surface of some countries, by covering them with a stratum of foreign matter, there is sufficient evidence. But before we assume the existence of a current, coming no one knows whence, going no one knows whither, and urged onward by a force as unaccountable as its origin and destination, we must be able to point out the traces of its ravages along the whole line of its route. And what kind of appearances may be expected where it is broad and deep, it is easy for any one to conceive who has read Mr. Dwight's well written description of the effects produced by the eruption of two small lakes in Vermont. The crests of hills will be found torn off and transported into the neighboring vallies—rocks dislodged from their native beds and deposited over

strata to which they bear no resemblance, and in general the utmost degree of confusion and disorder, and the mingling of soil, sand and gravel, possessing the most heterogeneous characters. But though I have carefully examined the country in the neighborhood of the mines, and at a distance from them, along the roots and on the other side of the mountain, it has never been my lot to meet with these traces of the ravages of a current.\*

2. If it be said that the researches of Mr. Rothe were crowned with better success; that he found marks of the action of a current—a.) In the granite near Salisbury, which has been much worn by the action of water in early times—b.) In the acclivous banks of the Yadkin, at the Narrows, shewing that the water was once many feet above its present bed—c.) In the alluvial deposits with which the highest hills near the river, as you go up the country, are covered—I reply—a.) That as his water-worn granite has, by his own account, a very irregular surface, it is from its rounded shape only that he infers that it has been subjected to the action of water. But every geologist knows that the decomposing agency of the elements is constantly giving to the rocks a spherical form in all parts of the world—b.) That after passing through the gorge of the Narrows at least a dozen times; inspecting both banks, and extending my examination in three instances below the Great Falls, I have never been able to discover the marks of which he speaks—c.) That I have traversed the mountains about the Narrows in a number of different directions, and have never, except

---

\* Neither the Blue Ridge, nor any other single range constitutes the barrier to be passed, but a body of table land, elevated some hundreds of feet above the general level of the western countries, having its upper surface studded with mountains, and the climate, productions and modes of culture of countries five or six degrees farther north. Ashe county lies upon the head waters of the Kenhawa and Watauga rivers. As an evidence of the wide difference between the temperature of this county and the county lying below the ridge, I may mention that the blackberry (*rubus villosus*) began to ripen in the midland counties this year by the 12th of June, and to decay and drop off three weeks after, but was still green in Ashe at the latter date, and not more advanced on the 16th or 18th of July than it had been in Guilford county four or five weeks before. Strawberries were in perfection in an open pasture and southern exposure, about the summit of the White-Top, a mountain just within the limits of Virginia, on the 10th of July. The forests, throughout this region were whitened with the blossoms of the chesnut and linn (*tilia*) on the 15th. The blackberry (*rubus villosus*) was in flower, and forming its acini near the summit of the Grandfather on the 14th.

close upon the bank of the river, and seldom even there, met with any soil that did not appear to have proceeded from a rock that had undergone decomposition in its original bed. I have been led to suspect that Mr. Rothe may have been mistaken in regard to these alluvial deposits, as he evidently was about the granite in the neighborhood of Salisbury.

3. The appearances about and above the Narrows of the Yadkin, can have little bearing upon the question respecting the existence of an alluvial stratum, in which the gold collected by washing is supposed to be found, because with one, or at most two exceptions, (the Beaver-dam and Cox's, which last is inconsiderable) the mines are below, or without, this mountain barrier, or on ground too elevated to permit of their being reached by the water in consequence of any obstructions interposed at this place.

4. The evidence in favor of the correctness of Mr. Rothe's views, as exhibited in his paper in the Journal, was not so strong as to prevent his entertaining and publishing a very different opinion in regard to the manner in which the gold has been distributed over the surface of the country; and this after he had enjoyed those opportunities of investigating the geology of the district, and examining the mines to which he refers; as will appear from the following extract from a communication of his inserted in the Western Carolinian, and bearing date June 5, 1826.

"It has been incorrectly supposed by some that gold was formed in the alluvial tracts, but this opinion must certainly appear erroneous, when it is known that gold is not unfrequently found on the summits of elevated portions of country, as is the case in Randolph County. We can trace the gold in the fissures of rocks, as well in the higher as in the lesser elevated land. *These veins have been burst asunder by subterranean explosions, and the gold scattered over the adjacent regions, and some of it carried down in the water courses.*"

But without calling in the agency of either an universal deluge, an inundation bursting over the Alleghany Mountains, or subterranean explosions, the circumstances under which the gold of North Carolina presents itself, and is collected, may, I apprehend, admit of a very simple and easy explanation; and that which I would propose is the following.

It formerly existed in the rocks of the region in which it is found—whether in veins of quartz exclusively, or also disseminated through the rock, is in a degree uncertain; but I am inclined to think, disseminated also. As the rocks have undergone decomposition, it has fallen out, and now lies mingled in the soil, near the same spot, and bearing the same proportion to the earthy matter, as when inclosed in its original stony matrix. In a few cases only, where it happened to occupy the side of a steep declivity, it has been carried down during the violent rains into the adjacent low grounds, and the beds of the neighboring streams.

If these views are correct, the rock formations of this region will possess rather more interest, than when they were regarded as a mere substratum, over which a layer of auriferous earth had been brought and deposited, and a few remarks in relation to their geological character, and with reference to a determination of the question, whether they are primitive, transition or secondary; granite, argillite, secondary greenstone, or greenstone slate, will not be inappropriate.

The accompanying map is copied from Price & Strother's large map of the State, and though not very accurate, is sufficiently so for our purpose. I have thought an exhibition of a small extent of country, upon a large scale, admitting of a distinct view of the different formations that traverse the State, preferable to an extension of the map, so as to comprehend the mines of Guilford and Rutherford: our object being *an illustration of the geology of the gold region*, rather than an account of particular localities. These formations, it will be seen, are four in number; one of them admitting of a subdivision—1. Beginning with the uppermost—the alluvial, colored yellow, and coming into contact with all three of the others. 2. What it is agreed, in this country, to call the old red sandstone, colored red. 3. The transition or slate, colored green. 4. The primitive, colored blue, with a red trace passing through it, and indicating the line, along which it is separated into two distinct portions, bearing little resemblance to each other. In noticing each of these more particularly, it will be most convenient to speak of them in the reverse order, commencing with that which is lowest.

*The Primitive.*—The existence of a body of primitive rocks in the central and western parts of North Carolina, has

long been known to geologists. The only remarks which it will be necessary for me to make respecting them, relate to their separation into two distinct formations—the more ancient lying farthest west, adjacent to the transition of Tennessee, and occupying the greater part of the counties of Ashe, Burke, Buncomb, Haywood, Lincoln and Stokes and the whole of Surrey, Wilkes and Rutherford—the more recent extending through the midland counties, Person, Caswell, Rockingham, Orange, Guilford, Davidson, Rowan, Iredell, Cabarrus and Mecklenburg. A belief in the propriety of this separation was induced in the first instance by an observation of the wide difference in the structure and general appearance of the rocks of the two districts. Those of the western division are highly crystalline in their structure, and consist of gneiss; of which there are many varieties, (it is often porphyritic; that having hornblende instead of mica; between the leaves—gneissoid hornblende rock of Eaton is common,) mica slate, hornblende slate, and some granite. I cannot get clear of the opinion that these are some of the very oldest rocks upon the continent. I endeavored for a long time to ascertain, if not the order of their superposition, at least the mode of their distribution over the surface of the country, and the boundaries by which the different species and varieties are separated from each other, but at length found them in a number of places alternating with each other in so many different ways, and in such quick succession, that I was induced to give it up as a hopeless task. Those of the western division, on the other hand, are almost exclusively granite, (understanding this word in the extensive sense in which it is used by Maculloch, as meaning a rock having hornblende as well as mica for one of its ingredients,) having very little tendency to stratification, and a dull, earthy appearance, indicating a recent origin. It is difficult to convey, by a description, an accurate idea of the difference between them, but any person who has seen them placed side by side, will acknowledge that they must have been formed either at different æras or under different circumstances. To the original argument for separation founded on the diversity of appearance and constitution in the rocks, the following have since been added.

1. The western division throughout the greater part of its extent (except along the streams, where there are valuable bodies of good land,) exhibits a soil of only moderate fertili-

ty; the eastern comprises the most fertile, populous and flourishing part of North Carolina.\*

2. The former is generally broken, and in some parts rises into lofty mountains; † the latter presents nothing deserving the name of mountain. This character, and the preceding are of little value in themselves, but taken in connexion with the others, appear worthy of notice.

3. The western division is as rich as other parts of our country, in mineral species, especially in imbedded crystalline forms, such as garnet, tourmaline, staurotide, oxide of

\* A writer in the first number of the Southern Review, observes, that "it has long been known that a belt of very fertile land comparatively narrow, traverses the three southern states," and from a remark in the work under review, draws the conclusion that this belt is "indicative of the slate formation." That there are tracts of good land within the limits of the state, is true, but in general, the soil produced by its decomposition is poor, and the part bordering on South Carolina especially, is infamous through all the adjacent country for its sterility. So far as North Carolina is concerned, this fertile land is indicative of the eastern division of the Primitive.

† I suspect the *highest peaks* to belong to the transition rocks. The most elevated land in this part of the United States, is unquestionably around the base of the Grandfather, as is proved by the fact that here are the head springs of four large rivers; the Yadkin, Catawba, Tennessee and Kenhawa, reaching the sea by widely different routes, but whether the mountain itself is not over-topped by the neighboring summits of the Roan and Black Mountains of Tennessee and Buncomb, especially by the latter, is doubtful. Maclure says, (observations on the geology of the United States, page 43,) "A similar (transition) formation, about fifteen miles long, and two or three miles wide, occurs on the north fork of Catawba river, running along Linneville and John's mountain, near to the Blue Ridge." Instead of constituting a distinct formation, it will probably be found that it lies in a salient angle of the western transition, which here crosses the whole breadth of the Alleghanies, including the Grandfather, and perhaps the Black mountain.

In the accuracy of Maclure's determinations, at the points which he had an opportunity of visiting personally, geologists will repose a confidence as undoubting as it is well merited, and it were to be wished that for the direction of succeeding observers, he had given some indications of his different routes. But the circumstance that the long range of old red sandstone, extending through North Carolina, does not appear upon his map, shews conclusively that he did not traverse *this* state from east to west, and as this part of the Alleghanies is one of the most wild, uninhabited, and difficult passes in the whole range, it may be conjectured that he did not traverse the mountains at this place; that it has never been visited by any person devoted to natural science, except the Michaux's of whom, both father and son, it was a favorite field of observation, but they do not appear to have paid much attention to any but the vegetable kingdom. I had an opportunity of passing along only the north eastern edge of this body of supposed transition rocks, from a point near where the Watanga enters Tennessee, across the head waters of the Linneville to the summit of the Grandfather, and of course to the neighborhood of Maclure's transition formation. I found plenty of clay slate, especially around the sides of the Grandfather, and such other rocks as along the borders of Tennessee occupy the dividing line between the primitive and transition strata.

titanium, beryl, zirconite, kyanite, &c. Graphite is very extensively distributed. Within its boundaries also, are all the iron mines that supply the forges and furnaces (thirty of the former and three of the latter,) with the raw material. The eastern division, on the other hand, is singularly barren of mineral species, and especially of crystalline forms. Indeed, if a line be drawn from the point where the Catawba enters South Carolina, to the north east corner of Stokes county on the Virginia line, with a bend to the westward to make it include the greater part of Iredell, the part of the state possessing much interest for the mineralogist will lie on the western side of this line. On the eastern side of it I am not aware that a single specimen of such common minerals as garnet and schorl, to mention no others, has ever been found. They may exist, especially beyond the formations next to be treated of, in the counties of Warren, Franklin and Wake, where there are crystalline rocks bearing a resemblance to those of the west, but too extensively covered by the sand to admit of our ascertaining their mineral riches.

On the Pedee in Anson and Richmond, as will be seen by the map, is another body of primitive rocks, having no apparent connexion with any other. This is a beautiful granite, crystalline in its structure, porphyritic, quarried for mill stones, decomposing into a good soil, and not known to contain any imbedded mineral species.

The transition or slate, is well described in Professor Olmsted's paper (as having "argillite for its prevailing rock, and embracing amongst other less important varieties of slate, extensive beds of novaculite, petrosiliceous porphyry and greenstone, these last covering the others,") except that one important member of the series—important for determining the age and geological relations of the whole formation is omitted; and that I believe conclusive evidence may be furnished, that *if either rock overlies* it is the argillite, but only in the southern part of the formation. In general, they alternate with each other in every conceivable order of succession. The rock omitted is a conglomerate or breccia, sometimes exhibiting a schistose structure, and sometimes destitute of any tendency to such a structure. *It appears to be the secondary greenstone of Mr. Rothe. His greenstone slate is the argillite of Mr. Olmsted,* and argillite it is unquestionably, as well characterised as is to be found within the limits of the United States.

As this formation stretches quite across the state, in a north easterly and south westerly direction, and is from ten to forty miles in breadth, it is not to be expected that its characters will be uniform in all its parts. Those geologists who delight to accumulate in their cabinets every anomalous and unheard of variety of rocks, might here add largely to their mineral riches, especially a long series of substances varying between compact feldspar and simple quartz or hornstone, colored green by chlorite and epidote; differing too widely from each other to be easily and naturally comprehended under one species, and presenting varieties enough to demand a nomenclature for themselves. The name of greenstone is more appropriate to them than any other, but they are quite a different affair from the rock generally designated by that title in the geological books. It is of fragments of this rock, connected by finer particles of the same, that many of the conglomerates mentioned above are composed, especially those at three of the principal gold mines, Chisholm's, Parker's and Read's. In Mecklenburg and Anson counties, we have very little besides simple clay slate, but as we advance northward, these compounds become more abundant.

The claim of this formation to a place amongst the transition rocks, is founded on such characters as the following.

1. It is not known to include, as one of its component members, any of those rocks which are universally acknowledged to belong to the primitive class, such as mica slate, gneiss, granite, &c.

2. Much of the clay slate included in it has a dull, earthy appearance when broken, and differs widely therefore from that *shining* argillite which is usually referred to the primitive rocks. It resembles very much such of the clay slate of the western country, (Tennessee,) as I have had an opportunity of examining, and this last is universally allowed to be transition. Any one who will look at the map will see that it must be to a prolongation of this formation, that Maclure has given the name of "transition clay slate," at Camden, South Carolina.

3. Starting from the University of North Carolina, and travelling a little south of west, I can point out conglomerate rocks—rocks that appear to have been formed of the shattered fragments and ruins of older strata, at short intervals, through a distance of eighty miles, to within three or four miles of the western border of the formation; and these



not lying upon the surface, but regular members of the series of strata, and inclined at the same angle with the others. It will generally be necessary that they should have been weathered to make the pebbles of which they are constituted, appear distinctly, but the same is true, not only of the transition, but often also of the secondary rocks.\* When they lie in the bed of a rapid stream, the softer cement is worn away by the attrition of the sand, and the pebbles still adhering by one side, give to the rock a wonderfully rugged and fantastic appearance. "See," said a planter who like myself had come to the Beaver-dam mines to witness the operations that were carrying on, but knew nothing of me or my business there, "see," said he, laying his hand upon a large rock which the workmen had just turned over in the bed of the stream, "this is pretty near equal to the millstone grit of Moore." The millstone grit of Moore belongs to the old red sandstone, and is constituted of quartz pebbles, varying from the size of filberts to that of hens' eggs. Geologists are sometimes blinded by prejudice and preconceived opinion, but it will not be doubted that the rock which drew this remark from a man who knew nothing of the science, was truly a conglomerate. It is a rock resembling most intimately that upon which he laid his hand, that constitutes the sub-stratum at the Beaver-dam, Parker's and Read's mines, extending at the former some miles up the creek, but confined to narrower limits at the other two. At Read's it appears to be covered by argillite, but it alternates with argillite, hornstone, siliceous slate, compact feldspar and other rocks at the narrows, and in other places.

Some geologists have been in favor of discarding the transition class altogether, nor if it is to be retained, has the prudence and safety of referring to it the strata under consideration, been perfectly apparent.

But the tendency of modern observations appears to be to shew the propriety of *retaining the class*, employing the term as the name of an assemblage of rocks, not very well defined perhaps, but of which we obtain a tolerably accurate

---

\* See Maclure's observations, page 18, and Buckland on the structure of the Alps, in the *Annals of Philosophy* for June, 1821. Speaking of the oolitic or Jura limestone, he says, "It is full of organic remains resembling those of the English coral rag; but from the compact nature of the matrix in which they are imbedded, these are visible only on the surface of the weathered blocks."

idea, when we find them designated by this title. I am, for my own part, becoming very sceptical on the subject of general strata, and more and more inclined to believe that causes *similar* perhaps, but not *identical*; and limited in their operations, have produced the rock formations of different countries. If so, it will be vain to look for the different members of an European series on this side of the Atlantic. Every part of the crust of the globe will require a nomenclature of its own, similar to that which Professor Eaton has found it necessary to apply to the tract along the grand canal. But when entire kingdoms or continents, are brought under review at once, we shall need a few great divisions, answering somewhat the purpose of the classes and families in botany and zoology, to designate the relations of extensive series of strata to each other, and for answering this purpose I do not see that any preferable to those that have been long in use are likely to be immediately invented.

If the class shall be retained, it does not appear that there is any other to which these rocks can be so properly referred. 1. Because they lie adjacent to a formation itself apparently one of the recent members of the primitive; than which they are more recent. 2. Because of their mineralogical characters already mentioned. Indeed it is such a formation as this that I would select in preference to any other, to stand as a type of the class. The absence of crystalline mixed rocks, granite, gneiss and mica slate, and the presence of an earthy looking clay slate and of conglomerate alternating with it, separate the formation by a wide remove from the primitive, as does the absence of organic remains from the secondary. At the same time, I believe it to be very ancient. If the name of slate shall be thought safer and more appropriate, no considerable objection can be raised. It will be understood hereafter, that it is a slate *alternating with conglomerate rocks*, and that though the greater part of the strata of which it is composed are slaty, this is by no means true of them all.

Appearing as it does, on both sides of the old red sandstone, and with the same characters, at the Grassy Islands in Richmond, and in the southern part of Montgomery, and on the South Carolina line, it will not be doubted that it underlies that formation, at least in this part of its course, or that after plunging under the sand, it is still the same slate that presents itself on both sides of the Pedee, and in its bed at

Parkersford. A similar clay slate is the lowest rock as we descend the Neuse River, and from some indications in the intervening country, I have been induced to suspect that it is upon this rock that the sand immediately reposes in this part of the state.

*Old red sandstone.*—The only circumstance connected with this formation to which I deem it important to call the attention of geologists, is that after coming into contact with the sand near Cape Fear river, it is gradually more and more covered by it, till it finally disappears altogether. It is disclosed in the bed of Drowning Creek, where the sand has been removed by the action of the stream, and finally reappears in Richmond and Montgomery. The part of this formation exhibited upon the map, produces by its decomposition, a better soil than that which is farther north. Throughout the state it is remarkable for the extent of the low grounds upon the banks of its streams. It no where attains an elevation of more than five hundred or six hundred feet above the level of the sea.

*Alluvial.*—The peculiarities of this formation, existing upon the high grounds and wanting along the beds of the streams, are exhibited in the district embraced by the map, though perhaps not so strongly marked as in some other places. It is not supposed that minute accuracy has been attained in the delineation of its boundaries, but a fair representation of the mode of its distribution is given. In every department of science, we arrive at truth by a series of approximations. It is a curious circumstance, that the quarry from which a considerable extent of country is supplied with millstones, (McDaniel's) is on the bosom of the sand hills. A fork of Hitchcock creek has uncovered a granite rock at this place for a distance of from a quarter to half a mile in its bed and along its bank, and from this they are taken. Except directly down the creek, the sand is spread out for miles in every direction.

Of these different formations, the old red sandstone has furnished a few minute particles of gold, collected in the bed of Little river, and apparently brought down from the slate above, and the western division of the primitive, a small quantity in the north eastern part of Rutherford county, where the fragments of crystallized and tabular quartz scattered over the surface indicate the existence of an auriferous vein, but all the valuable mines are in the eastern division of

the primitive, and in the transition, and I have been disposed (though perhaps not on ground sufficiently strong,) to refer them especially to the upper members of the former and lower members of the latter.

It has been already mentioned that the rocks of the primitive district are mostly granite, including under that title unstratified hornblende rocks, as well as what bears the name of granite in the more ancient geological books. But no vein of auriferous quartz has ever, within my knowledge, been found in contact with well defined granitic rocks, whether proper or syenitic. Small veins may traverse them, but no large ones are embraced by them. A rock, of which it is much easier to say what it is not than what it is, covering itself by decomposition with a thick coating of soil of impalpable firmness, which prevents our getting at it to study it, frequently schistone, yet, not well defined slate of any kind, is richer in these auriferous veins than any other. At the Guilford mines I have found chlorite slate tolerably well characterized. Though intimately connected with the formation in which it lies, it has been suspected that it is not without some relationship to the neighboring transition; that some of the lower members of the transition strata, or rather of those rocks by which the one formation passes into the other, here cover the proper granite and furnish the gold. The exploration of these mines (in Mecklenburg and Guilford,) is going on with activity, and more of the precious metal will be brought into the market during the present, than has been in any former year.

Within the limits of the transition *only one auriferous vein* (Baringer's) has hitherto been worked, and that was hard by its western border, and soon abandoned. And yet it was within the limits of this formation that from 1800 to 1825, all the gold of North Carolina was collected. The following circumstances have induced a belief that *this gold* was not derived from a vein, but lay disseminated through the whole body of the rock from the earth produced, by the decomposition of which it is obtained by washing.

1. It differs from the gold of Mecklenburg and Guilford, it being found in grains and fragments of considerable size, admitting of its being detected amongst the sand and gravel, and taken up with the fingers, whilst that is in minute particles, and frequently in the state of a fine brown powder in which the eye can discern no trace of a metal, rendering the

use of quicksilver also, lately necessary. This diversity of character seems to point to a different origin.

2. The conglomerate rock by which it is accompanied, is nearly destitute of veins of any kind. The few which it has are too thin and inconsiderable to furnish the large amount of gold that has been collected, for instance at Read's mine. It is obvious that if there be a vein at this place, from which all this metal is derived, there is no mine in the country, and perhaps none in the world to compare with it for mineral riches, since what has been liberated by the action of the elements has rewarded the labor of so many years. But examinations made with a view of discovering a vein, have not hitherto been rewarded with success.

3. Parker's mine being in a high open field, and the rock having been wholly decomposed to an unknown depth, (at the place from which the auriferous earth is taken; it appears exchanged in the neighborhood,) we have an opportunity of penetrating into it and observing the manner in which the gold is distributed. It appears to occur in every part of the soil, and at all depths that have been hitherto examined, whilst the usual veins of quartz are altogether wanting.

From the foregoing statements it is inferred that the gold of North Carolina is found,

1. In veins of quartz, traversing the ancient primitive rocks, in very small quantity.

2. In veins of quartz, traversing more recent primitive rocks, in considerable quantity.

3. In veins of quartz, traversing transition rocks, and also disseminated, in considerable quantity.

4. In soil produced by the decomposition of these three kinds of rock.

5. In the sand of a stream running over old red sandstone, in very minute quantity.

I am very respectfully yours,

E. MITCHELL.

P. S. Dec. 15th. 1828.—1. Some of the mines exhibited on the map are trifling and unimportant, and inserted merely to shew the limits of the gold region; such is Ingraham's, and perhaps Alexander's. 2. The boundary of the state should cross the South Carolina line a little south instead of a little north of McAlpin's creek. 3. The slate perhaps occupies the bed of Hitchcock creek, in Richmond, in some part of its course.

ART. II.—*Examination of a substance called Shooting Star, which was found in a wet meadow; by Counsellor Dr. BRANDES, of Salzuflen.*

(Translated from the German, for the American Journal of Science and Arts.)\*

MY friend the Counsellor, Dr. Buchner, some time since took a part in the discussion, in *Kastner's Archives*, upon the substance called *sternschruppen*, (shooting star,) which Counsellor Kastner has distinguished by the name of *stern-gallerte*, (star jelly.) A specimen of this substance, having a gelatinous appearance, was found in a wet meadow, which Counsellor Dr. Schultes considered as a *tremella nostoc*. Buchner was of a different opinion, because he could discover in the substance no trace of organic texture, when he came to examine it himself. As respects the question, whether it were of a celestial or of a terrestrial origin, he maintains, that this gelatinous mass could not be either a plant or an animal, *as a whole*, but rather the product of a plant or an animal, an excretion, like gum, mucus, &c.; and he denies the possibility, that such a body could have fallen from the atmosphere upon the earth, or that the idea is sustained by the least probability. The comparison of this mucilaginous mass, which has been made by some, to the manna of the Israelites that fell from heaven, does not appear to him as altogether exceptionable; at least, this mucilaginous mass, like the oyster, may possess very nutritious properties. I readily agree with my learned friend, that the former supposition is probable, viz.: that these masses are animal excretions, or are from gelatinous meteors; but the idea seems to be improbable, that they are like the manna of the Israelites, from their presenting such diversities, both in the nature of their bodies, and in their localities. From the absence of organic structure, in the mass examined and described by Buchner;—further, from the account by R. Graves, of a fireball, (*fuere-meteor*) which fell in Massachusetts in North America, on a place where the next morning a gelatinous substance† was found;—from my own observations of the

---

\* Extracted from the *Jahrbuch der Chemie und Physik für 1827*. Herausgegeben vom Dr. J. S. C. Schweigger, und Dr. Fr. W. Schweigger-Seidel. Halle. Ausgegeben am 26. Juni, 1827.

† We were informed before we saw the present article, that a gelatinous fungus was the next year observed near the place where the meteor mentioned by Col. Graves was supposed to have fallen; we cannot say that the two facts have any connexion, but it appears proper that the coincidence should be mentioned.—*Ed.*

presence of inanimate substances in the atmosphere, at least in rain-water;—and from the narrative, which was several times communicated by a soldier, who had served some campaigns in Spain, that in Spain, while standing as sentinel during cold nights, he had frequently observed shooting stars, and in the morning, in wet places, in the spots where, according to his opinion, the shooting stars had fallen, he had found white gelatinous masses, which soon dissolved;—from all these circumstances, as I have stated in my dissertation upon rain-water, I was strongly inclined to refer the mass, which was examined by Buchner, to an atmospheric origin.

Mr. Schwabe, an apothecary of Dessau, has lately published, in *Kastner's Archives*, a dissertation upon this subject, in which he states, that he has had an opportunity to examine a mass, that had been found in a wet meadow, which was gelatinous, and of a green color. Mr. Schwabe decides this mass to be the real *nostoc commune* Vauch. (*tremella nostoc* L.) because by his microscopic observations, he found in it, distinctly to be traced, the structure of the singular *nostoc*. Not only the exterior form and the locality of this mass agreed with Buchner's, but the chemical examination also exhibited a great similarity between both substances. Schwabe consequently believes, that we must necessarily consider the substance under discussion, as the real *tremella*, and that the one examined by Buchner must actually have possessed the same structure, notwithstanding Buchner, on account of the peculiar nature or condition of his mass, has denied the possibility of discovering in it an organic structure.

However, when we accurately compare the descriptions, which each of these naturalists gives of his particular specimen, we find some diversities, besides the organic structure of Schwabe's specimen, and its absence in Buchner's. Schwabe's mass was of a *greenish* color; that examined by Buchner was *white*, resembling the mucilage of gum tragacanth. The substance of Schwabe emitted an odor while it was burning, *not* of animal matter, but similar to that of burning *conferva*, *rivularia* and *cataphora*, and made a shining coal, which retained the external form of the mass; and being reduced to ashes, he found in them a portion of siliceous earth, carbonate, muriate, and sulphate of potass, to-

gether with a trace of sulphate of lime and oxyde of iron. Buchner's mass swelled very much upon being heated, evolving a strong *animal* odor, giving off a smoke of an empyreumatic smell; at last it took fire, and at the end of the combustion left behind an ashy coal, which contained carbonate of soda and phosphate of lime. Though Schwabe considers the mass examined by him as similar to Buchner's, I yet believe, that the differences here specified, not merely in the color, but also in the chemical results, present many doubts as to the accuracy of his conclusion, and do not authorize us to agree to the identity of both substances.

In confirmation of these views, I am able to exhibit an investigation of my own, which I had occasion to make during the last autumn, that may perhaps shed some further light upon the subject.

A friend and fellow citizen possesses a low meadow in our vicinity. It is situated at the bottom of one of our salt dales, and by much labor, the construction of drains, &c. though it was formerly very boggy, it is now much drier; and by good cultivation, manure, the rubbish of stone coal, &c. produces good grass. In a walk over this ground, my friend found a gelatinous mass, and a laborer informed him that he had frequently seen similar beautiful specimens; though neither my friend, nor I, in my botanic excursions over this meadow, with my assistants and pupils, had ever before discovered them. My friend brought the substance to me, that I might investigate the nature of the mass, the singular appearance of which had excited his curiosity.

As soon as I saw the substance, I was reminded of Buchner's treatise upon the article called shooting star (*sternschnuppen*;) but by a closer inspection of its beautiful exterior, I discovered some diversities from Buchner's description, which determined me to give it a further investigation.

The mass was of a very clear white color, and appeared to be a very glutinous substance, which Buchner has very aptly compared to mucilage of tragacanth; it was of the size of about two cubic inches and a half. Upon minute inspection, it was found in many places to be enclosed with a very thin white pellicle or membrane, which in the middle parts of it was burst or torn. In these places, the contents, as if they were too large, projected through the covering. The fissures of the enveloping pellicle were, without doubt,



occasioned by the contents of the mass absorbing moisture from the wet ground of the meadow, and thus becoming so much distended, that the tender membrane could not contain the whole substance. Around these fissures, the pellicle was so far crowded away or concealed by the gelatinous mass, that no traces of it could be seen, and here no appearance of organization could be distinguished. But, where the covering was entire, the mass, though soft and glutinous, exhibited portions of a vermiform shape, of the size of a goose-quill or larger, the longest of which were extended about three-fourths of an inch. This vermiform conformation, through a slender interlacing network, presented smaller subdivisions, and had throughout the appearance of a calf's lungs. Upon the backside of this vermiform structure, there ran a blackish brown-colored vessel, which spread or divided into a kind of venous system, reaching near to the fore side of it, being lost in blackish points. The back part of the mass was pervaded by the vessel, which passed through it much in the same manner as do the vessels of the lungs.

A part of the mass being put into a dry place, it soon shrivelled, changing its white color to a brownish yellow, and was very viscous, so as to draw out in threads like glue; at last, it dried into a substance like horn.

A portion of the original mass being put into a platina crucible, and exposed to a heat sufficient to burn it, at first swelled, then grew black, giving out an animal, empyreumatic odor; it left behind greyish white ashes, of one and two-tenths\* of the weight of the substance, upon which water very slowly acted, though after some time it became weakly alkaline. The ashes were completely soluble in nitric acid, from which they were precipitated by ammonia.

Twenty grains of the substance were dried in a water-bath heat. It was hard and brittle, and its weight was only four grains. Moistened with water, after a short time, it again resumed its former size and white color.

One hundred grains were boiled in three ounces of water. It swelled into a tremulous jelly, which thickened nearly all the water. The whole was then put upon a cleau, loose, linen strainer, and after standing on it a few hours, a little liquid dropped from it, which became turbid by the addition

---

\* One tenth, and two tenths of one tenth are evidently meant.

of oxyd of mercury, by nitric acid and acetate of lead ; but not by oxalate of lead.

Some of the substance was shaken with alcohol, with no perceptible effect. Water being added, it combined with it, notwithstanding the alcohol. As it shrunk or diminished in size, its color changed.

Liquid ammonia, whether warm or cold, acted but slightly upon it ; on the other hand,

A solution of caustic of potass speedily took hold of it ; when warm, it produced a perfect solution, from which it might be precipitated by any neutral salt.

Sulphuric, nitric, and muriatic acids, act on it cold ; when warm, they effect a complete solution. The solution in nitric acid, is of rather a yellow color ; in sulphuric, it is brown ; and in muriatic, it remains clear.

From these experiments it appears, that the substance cannot be of a nature similar to albumen, but that in its essential properties it accords with gelatine, and resembles what is called spring slime, (*quellschleim*.) This conclusion is justified by the following proportions of one hundred parts of the mass.

Gelatinous substance, . . . . .	18,8
Animal substance, [?] a trace.	
Phosphate of potass and muriate of soda, } with organic [?] acid, }	1,2
Water, . . . . .	80,0
	100,0

To what kingdom does this substance belong ? or from what source is it derived ? The existence of an organization, which was clearly manifest, does not admit of the opinion that it came from the atmospheric regions, but shows that it is of a terrestrial nature, and must proceed from an animal. Its striking resemblance to a calf's *mesentery* at first made me suspect, that it was [an excretion from] the intestines of some bird ; but its contents, a clean jelly, the thin pellicle or membrane that inclosed it, somewhat resembling the peritoneum, the absence of all ordinary contents of the intestines, &c. notwithstanding the similarity to some of their excretions, were insufficient to justify such a view, after a close examination. The resemblance of this substance, as respects its chemical analysis, to the spawn of frogs, sug-

gested to me the thought, whether this might not be the spawn of some animal. It could not be the spawn of a frog, but it might be the spawn of a snail which frequents such meadows, such as the *limax rufus*, *agrestis*, *stagnalis*, &c. I compared the descriptions which are given in Cuvier's Comparative Anatomy, translated by Mekel, in Oken's Natural History, in the Natural History for Schools, in Goldfuss's Manual of Zoology, &c. where I found some light upon the spawn of snails. Oken in his Natural History for Schools remarks of the *limax stagnalis*, that "its spawn is a gelatinous cylinder, an inch long and a line thick, in which a dozen yellow, small eggs are enclosed; that this cylinder commonly adheres to aquatic plants; and within a fortnight or three weeks, the small snails are hatched." He further observes in his Introduction to Natural History, article *limax*, that the eggs are first lodged in a cyst or rather a sack, and as it is found in all snails, it probably secretes the jelly for the egg cylinder or ball. "Its contents are compact, soft like cerate, and reddish brown, on which account they have been considered as purple, which is not the case." Though the cylinders of the *limax* are very small, we must still believe, that our substance was derived from the *limax rufus*, or from some other species, and that the great size of the mass was derived wholly from water; of which we are persuaded, from the experiments which we made with boiling water, showing that the contents of a very small body may be distended to almost any volume by water alone.

This view of mine was further confirmed, after I had put a portion of the substance into a saucer, and placed it before one of the windows of my study; when after some days, a small naked snail, a fourth of an inch long, was found in it. Hence I believe, I am able to decide with convincing reasons in favor of the opinion, that the white gelatinous masses which are found in wet meadows, and which are generally considered as the substance of shooting stars, are by no means derived from the celestial regions; but they are really the spawn of a certain snail, which, though of an insignificant bulk in its natural state, so as scarcely to attract notice, acquires its extensive volume from the water of moist places, and assumes a white, gelatinous appearance. Further, it is the nature of this spawn, that it is found only in wet places.

Whether the real substance of the meteor called the shooting star ever may have been found, I very much doubt. He,

who has observed these luminous meteors, will scarcely be of the opinion, that the point upon which they appear to fall, in the darkness of the night could be easily found with such certainty, that he could exactly discover the supposed substance, and I might say, could be certain that he had in his hand a shooting star, which had fallen from heaven. Before this unsettled point is ascertained, it is to be doubted, whether we can pass any judgment upon the nature of the shooting star. Indeed, the observation of the before mentioned North American meteor, appears to be not without some doubt, as to its accuracy ; and it might be still a subject of inquiry, whether the product of a *fiery* meteor could be a gelatinous mass?

Our knowledge of shooting stars is very much extended by the valuable researches of Professor Brandes of Breslau ; but what concerns the nature of their substance, appears to me to be, as yet, dark and undiscovered ; at least according to my views, the gelatinous masses which are found in meadows, should by no means be considered as the product of shooting stars.

It now remains for me to consider the differences which apparently exist between the results of the observations of Messrs. Buchner and Schwabe, and my own statement. The care with which they have drawn up both their descriptions, allows us to compare them with sufficient exactness.

Both the substances examined by these gentlemen, as I have already suggested, exhibit different properties, which are sufficiently essential to make us look for a different origin for each, so that I cannot coincide with the views of Schwabe, when he considers the mass examined by Buchner as analogous to his own, and confidently comes to the decision, that the substance examined by Buchner was a *tremella*. As respects Buchner's mass, it accords exactly with the specimens which I examined. The chemical composition of both is precisely the same, and the only particular difference, which appears to present itself, consists in this circumstance, that the mass examined by Buchner apparently exhibited no organic structure, while that observed by me, as I have before declared, presented all the signs of an animal product. But if we consider the appearance of the snail spawn jelly, which I have already described, especially in the places where the pellicle was broken, through which the jelly protruded, and all appearance of organic structure

was lost in consequence of the absence of the enclosing membrane, and further, if the substance should be very much distended with water, the grounds of Buchner's conclusions will be easily understood. I believe, Buchner had before him a mass very greatly swelled, which had dislodged all traces of a pellicle, and destroyed the fine vessels; and that as respects his specimen, the learned naturalist was perfectly accurate, when he could discover no sign of organization in such a distended mass. In his specimen, a hundred parts yielded after drying only four and four tenths of solid matter; whereas in mine, a hundred parts, after the water had been evaporated, left behind twenty.

If there is no longer any doubt of the similarity of the two substances, I believe, all which I have said upon snail jelly must necessarily show, that the substance of which Buchner has treated must have had the same origin. I believe also, that the nature of what is called *stern-schnupen* (shooting star) and *sterngallerte* (star jelly) is cleared up. And it is gratifying to me, to have examined and to have traced the difference between Buchner's and Schwabe's observations, and to have shown, that the dissertations of both these able naturalists are equally accurate, each having had a perfectly different substance under examination.\*

---

\* *Note.*—The idea, that the shooting star is a gelatinous body, is perhaps as prevalent in America as in Germany, though the substance may not have been so frequently supposed to be found, on this side of the Atlantic. There is, however, apparently some pretty strong testimony on the subject. A Mr. John Treat, a respectable farmer, and a man of veracity, stated to us, that he was with the army of Gen. Washington, in the campaign against Gen. Howe, after his landing at the Head of Elk. On the night previous to the battle of Brandywine, as he was standing sentinel, a shooting star fell within a few yards of him. He instantly went to the spot, and found a gelatinous mass, which, if we recollect right, was still sparkling, and he had kept his eye on it from its fall. A very respectable lady mentioned, that as she was walking in the evening with one or two others, a similar meteor fell near them, and she pointed out the very place where it struck. The late Gen. Griswold informed us, that a shooting star once fell near him, upon a piece of ice, as he was walking with two other persons, in the street of East Hartford.

We recollect once having seen one of these meteors, called shooting stars, actually several degrees *below us*. We were riding, late in the night, upon the high bank of the Hudson between Newburg and New Windsor, when we observed a shooting star, probably for more than five hundred yards in its track, moving in about a horizontal direction to the north, nearly over the middle of the river. It was far below the horizon, and considerably below the opposite bank. It did not, however, appear to fall into the water, but like a sky rocket it became extinct in the air.

Notwithstanding these statements, if the shooting star, while luminous, *ever strikes the earth*, it must be a very rare occurrence, in this part of our coun-

ART. III.—*Observations and Experiments on Peruvian Bark*; by GEORGE W. CARPENTER, of Philadelphia.

THE cinchona, or as it is more generally denominated, Peruvian Bark, is the product of several species of the genus *Cinchona*, which in botanical arrangement, belongs to the class Pentandria, order Monogynia, and to the natural order Contorta.

The descriptions of the species of this genus, from the limited and imperfect nature of the information possessed, have been generally so confused and indefinite, as to convey little or no information.

*Cinchona* is found in various parts of South America, always inhabiting mountainous tracts, where it grows from a few inches in diameter to the thickness of a man's body. The bark is collected in the dry season, say from September till November, and after being well dried in the sun, is packed up in skins, forming what is called *seroons*, weighing from fifty to one hundred and fifty pounds.

Several species are frequently mixed together in these seroons, which are afterwards separated, according to quality: it is not, however, uncommon to find several species mixed together on their arrival at our markets. The tree has never yet been cultivated by the Spaniards, who procure it by stripping the natural trees of their bark, which ultimately must destroy the genus, as they always die after the operation.

Most of the varieties of cinchona being highly valuable, and consequently very liable to be adulterated with various substances, it is therefore important to adhere to a critical examination of all its characters.

The accounts of the discovery of cinchona are very numerous, and many from their singularity and improbability,

try. Our profession has frequently called us to ride, in every hour of the night, in every season of the year, and in every kind of weather, and we have never seen a phenomenon of the kind. Nor have we ever seen a shooting star in a dark and cloudy night; consequently, these meteors must usually be in a more elevated region of the atmosphere than the clouds; or they are decomposed by the clouds; or they are not formed in cloudy weather. We will conclude by stating, that in all our riding in the night, during a long course of years, we have never witnessed any thing like an *ignis fatuus*; nor have we ever observed the phosphorescent appearance, which is said to be sometimes noticed upon fences, the arms of soldiers, and other slender pointed bodies; though the latter seems to be a well attested fact.—*Translator.*

are no doubt founded in fiction. It has long been esteemed a valuable medicine in Peru, where it is said the natives have adopted its use, from observing that animals recur to it. Be the source of its first employment what it may, it was not used by Europeans until the year 1640, when the countess Cinchon, wife of the Spanish viceroy, was cured of the ague by means of it, and hence the derivation of its name, cinchona. As frequently occurs on the introduction of any *new remedy*, considerable noise was made, and opposition raised against it by several eminent physicians; but when submitted to proper experiments, its efficacy soon suppressed the groundless clamor which had been too hastily excited.

The principle, says Dr. Paris, on which the tonic and febrifuge properties of bark depend, has ever been a fruitful source of controversy. Deschamps attributed it to cinchonate of lime. Westering considered tannin as the active principle; while M. Seguin assigned all the virtues to the principle which precipitates gallic acid. Fabroni concluded from his experiments, that the febrifuge power of the bark did not belong exclusively and essentially to the astringent, bitter, or to any other individual principle; since the quantity of these would necessarily be increased by long boiling; whereas the virtues of the bark are notoriously diminished by protracted ebullition.

Perhaps no vegetable substance, underwent so many analyses, by the most distinguished chemists of Europe, as the cinchona; and yet so little positive knowledge was obtained of its true constituents, and such was the very obscure condition of our information of the active principle of cinchona, when the scrutinizing, critical and successful researches of Pelletier and Caventou, detected the existence of two salifiable bases, in peculiar states of combination, in the different species of cinchona. The medical profession is therefore indebted to these intelligent and enterprising chemists, for one of the most valuable additions ever made to the *materia medica*.

Among all the late discoveries in vegetable chemistry, there is none which claims so much attention from extensive usefulness, as that of quinine. This principle contains all the tonic and febrifuge properties of Peruvian bark, in their most concentrated state. By the substitution of this preparation for the crude bark, the physician can conveniently administer it to the most delicate constitution, in an eligible form,

and by no means an unpleasant dose, what previously was considered the most nauseous and disagreeable medicine, and frequently, from its bulky nature, (when administered in less than ordinary doses,) was rejected by the stomach.

In consequence of the prevailing endemics, ague and remittent fevers, which of late years have visited almost every section of our country, the article *cinchona* has increased very much in practice and demand, and become one of the most important articles of the materia medica.

The descriptions which have been given by most authors, to distinguish the many species and varieties of this extensive and important genus, are so imperfect and confused, that they tend rather to involve research in more dense obscurity, than to develop any information. It is admitted, there is no method so well calculated to ascertain, with any degree of certainty, the comparative activity of the different species of Peruvian bark, as that of analysis; and from this circumstance, I have made trial of some of the most important species, which now occur in our commerce, for the purpose of determining their qualities, which I have done by extracting the alkaline principle, upon which their virtue as a medicine entirely depends, and from the product of which, their comparative strength may be accurately and readily ascertained.

It is a source of regret, that many of our country physicians so little appreciate the quality of cinchona, as to be governed entirely by the price, which from the following statement, will appear to be the most remote and inaccurate grounds for calculation, as the cheapest or lowest priced bark in the market, is far dearer to the practitioner, and particularly to the patient, than that which commands the highest price; for it not only requires the patient to swallow twelve times the quantity to produce the same effect, independent of the loss of time, but also by charging the stomach, when in a weak and debilitated state, with so large a portion of ligneous and insoluble matter, may give rise to diseases more serious than those for which it was administered as a remedy.

The bark of commerce, in this country and in England, is generally designated under the limited nomenclature of red, pale and yellow. There are now no less than twenty five distinct species of cinchona, independent of any additions we may owe to the zeal of Humboldt and Bonpland, as well as of Mr. A. T. Thompson, who states, that in a large collection



of dried specimens of the genus *cinchona* in his possession, collected in 1805, both near Loxa and Santa Fé, he finds many specimens which are not mentioned in the works of any Spanish botanist.

Dr. Paris, in his valuable *Pharmacologia*, justly remarks, that notwithstanding the labors of the *Spanish botanists*, the history of this important genus is still involved in considerable perplexity; and owing to the mixture of the barks of several species, and their importation into Europe under one common name, it is extremely difficult to reconcile the contradictory opinions which exist upon this subject. Under the trivial name *officinalis*, Linnæus confounded no less than four distinct species of *cinchona*; and under the same denomination, the British *Pharmacopœias* for a long period placed as varieties, the three barks known in the shops: this error indeed is still maintained in the Dublin *Pharmacopœia*, but the London and Edinburgh colleges, have at length adopted the arrangement of Mutis, a celebrated botanist who has resided in South America, and held the official situation of director of the importation of bark for nearly forty years.

The apothecaries of this country and England, at the present day, distinguish the denomination of their bark, by terms expressive of the color; and it is a source of still greater surprise, to find the orders and prescriptions of some of our most intelligent physicians, designating the species of bark they wish to employ, by no other than one of the terms signifying red, pale or yellow: thus reducing the extensive genus *cinchona*, of not less than twenty five species into three varieties, and leaving it entirely to the discretion of the apothecary, to give him any species, of a color correspondent to that ordered. Independent of the great insufficiency of these terms to distinguish the numerous species, the color of the powder, is one of the most uncertain and inaccurate methods which could be adopted, of classing or assorting the *cinchonas*; as under the same denomination, the best species of bark in commerce, (*calisaya arrollenda*,) would be confounded with the most inferior, (*carthagena*,) as the color of the powders of both is yellow; hence a physician writing for yellow bark, leaves it to the choice of the apothecary, to give him what species he may think proper, of a correspondent color, but varying in quality from *calisaya* to *carthagena*, or in medicinal activity as from 12 to 1.

The importance therefore of adopting terms more definite to distinguish the several species of Peruvian bark must be obvious, and that the botanical nomenclature of these species is imperfect and inadequate, is equally so. The quality of Peruvian bark appears to be modified and influenced by locality, produced by difference in soil, altitude of situation, exposure, or some other circumstances peculiar to the location, hence the different provinces of Peru afford bark differing very materially in their physical characters and particularly in the activity of their medical qualities, from which circumstances it would appear that a nomenclature derived from the names of the provinces in which the different species grow, would be a systematic arrangement.

The following are some of the most important species which now occur in commerce which I have submitted to experiments, and have given to each the comparative proportion of quinine and cinchonine which they respectively contain. The names which are given to distinguish these several species, are derived from the provinces in which they grow, which at present, (in consequence of the confusion in the botanical history and arrangement of cinchona,) is the most direct and certain mode of distinguishing those species of bark which now are found in our shops.

#### *Calisaya Bark—Two Varieties.*

Of this very important species there are two varieties in commerce.

1st. *Calisaya arrollenda*, (Quill *Calisaya*.) This variety is in quills from three quarters of an inch to an inch and a half in diameter, and from eight inches to a foot and a half in length. The epidermis is thick and may be readily removed from the bark; and hence you find in the seroons or cases a great proportion deprived of this inert part. It is generally imported in seroons weighing about one hundred and fifty pounds, and very seldom comes in cases; it has many deep transversal fissures running parallel, the fracture is woody and shining, the interior layer is fibrous and of a yellow color, and the taste is slightly astringent and very bitter.

This species of bark will yield a much larger proportion of the active principle, (quinine,) than any other bark in commerce, and consequently may be justly esteemed the best.

2nd. Calisaya Plancha, (Flat Calisaya.) This variety consists of flat, thick, woody pieces, of a reddish brown colour, deprived of its epidermis, and the interior layer more fibrous than that in the quill. This variety yields from twenty to twenty-five per cent less quinine than the arrollenda, and is consequently a less desirable article.

*Superior Loxa or Crown Bark.*

Loxa is the name of the province and port, where this bark is obtained and from which it is exported. In this province cinchona was originally discovered. This bark has been highly esteemed by the royal family, and is that which has been selected for their use; hence, the name of Crown Bark. The following are the characters which distinguish this bark.

The Loxa bark occurs in small quills, the longitudinal edges folding in upon themselves forming a tube about the circumference of a goose quill, and from half a foot to a foot and a half in length. It is of a greyish colour on the exterior, and covered with small transverse fissures or cracks, the interior surface is smooth and in fresh or good bark of a bright orange red, it is of a compact texture and breaks with a short clear fracture, it is the bark of the cinchona condaminia and is known at Loxa by the name of cascarilla fina. Yet, notwithstanding this bark appears to have held the decided preference to all other species, analysis fully indicates that it is not equal in medicinal strength by at least twenty-five per cent, to that denominated *Calisaya*; this bark is more astringent and less bitter than the calisaya.

This species yields from twenty-five to thirty per cent, less cinchonine and quinine, than the caylisaya arrollenda does quinine, and the proportion of cinchonine is much greater than that of the quinine.

*Cinchona Oblongifolia or Red Bark.*

The above term appears to be more applicable to the species in question, than any other which can be selected, as under that denomination the best red bark has always been well known, and as there is but one other species affording a red powder, it is not likely to be confounded. The inferior red bark of which there is a considerable quantity in our

market, is no doubt more frequently obtained by colouring low priced yellow bark, than from the product of a distinct species.

There is but one species of bark in addition to the *Oblongifolia* as before stated, producing a red powder which is called *Rosea*, and as that species is seldom or never known in our commerce there can be little or no powder produced by it, hence, all the inferior kinds of red bark of which there is no small quantity to the discredit of those who sell it, evidently must be either such of the *Oblongifolia* as has been rendered almost inactive, by age, weather, or some other exposure, or as before surmised, is inferior yellow bark, coloured, and as the product of the former must be small, it in all probability proceeds from the latter source; hence the *price* of red bark is as various, (and the *qualities* corresponding *with* the prices,) as the yellow bark, although the number of species of which we are acquainted is not one eighth the number of the latter.

The *cinchona oblongifolia* is the *magnifolia* of the flora Peruviana, and is known in Spain by the name of *Colorada*, and is what constitutes the red bark of commerce; it occurs generally in large thick pieces, being the product of the largest tree of the genus *cinchona oblongifolia*. There are two varieties.

1st. *Colorada Canan*, or *Quill Red Bark* which occurs in quills of various diameters, from one fourth of an inch to two inches in thickness. The epidermis is white or grey, with transversal fissures or warty concretions of a reddish color, the interior is of a brick red color, the cross fracture short and fibrous, the longitudinal fracture compact and shining, the taste not so bitter as that of the *calisaya*.

2nd. *Colorada Plancha*, or *Flat Red Bark*. This bark is in very large thick pieces, from half an inch to two inches in thickness, and from one to two feet in length, the epidermis brown, thick and rugged with cracks running in various directions. The fracture very fibrous inside, is of a deep brick color, the taste is less bitter than that of the quill, and of course much less so than that of the *calisaya*.

These two varieties frequently come in the same seroon, and from their appearance are no doubt the product of the same species, or perhaps the same tree; the quill being produced by the branches and the flat thick pieces from the trunk, or the former from young and the latter from older trees.

This bark is generally more scarce in our market than the yellow or pale, and commands a higher price : within a short period however, about fifty seroons of this bark have been imported from Guayaquil by Mr. John R. Neff, which has in a small degree influenced the price of the article. I am informed by a respectable druggist of this city, who has been a long time established in business, that this is the only arrival in quantity, of red bark, direct from South America within his recollection, the supplies heretofore having been received from Europe. These seroons averaged about one hundred pounds each. The bark was very fresh and of a very superior quality. The large flat pieces and quills were indiscriminately mixed and in some seroons in very nearly equal proportions. This bark when first received, was of a very deep and bright color, and particularly the powder produced by the flat pieces ; after being exposed however, in a dry place for about six months, it faded considerably, insomuch that any one not in possession of the proof of the fact, would have doubted, whether the powder had been produced from the same bark.

From experiments on the above bark, I procured twenty per cent less cinchonine and quinine, taken together, than the amount of quinine produced by the same quantity of calisaya arrollenda bark ; and the proportion of cinchonine, was rather more than half of the product of quinine.

It will appear therefore, from what has been said, that notwithstanding the great prejudices, both of eminent authors and skilful practitioners, which have so long existed in favor of the superiority of the *oblongifolia*, (red bark,) over other species ; that it is decidedly inferior to the *calisaya*, (yellow bark,) as the whole product, as before stated, of its active principles, does not equal that of the calisaya and cinchonine, constituting rather more than half the product, which, according to an eminent author, is five times less active than the quinine ; this point however, I think is very far from being settled. An interesting paper was read before the Academy of Medicine, at Paris, which is published in the *Bulletin des Sciences Medicales*, for November, 1825, in which M. Bally states that he has experimented upon the sulphate of cinchonine, with a view to determine its febrifuge qualities. He administered this sulphate in twenty seven cases of intermittent fevers, of different types, in doses of two grain pills, giving three or four in the interval of par-

oxysms; by which treatment he cured the disease as effectually and as speedily as with the quinine: of which twenty seven cases, there were sixteen tertian, nine quotidian and two quartan. He remarked further, that the cinchonine has properties less irritating than those of quinine, and that consequently its employment should be more general, and preferred in all simple cases. I believe few or no experiments have been made by the physicians of this country, upon the medical properties of the cinchonine; it consequently must be very little known by them from their own experience, but it certainly is a medicine which deserves at least a trial.

From the preceding description, the several species of Peruvian bark most commonly met with at the present day, may be readily recognised, as the physical characters are prominent and distinctive in each variety; after however selecting the best species of Peruvian bark, by the several distinguishing and specific characters, one very important adventitious condition yet remains to be investigated. It is a fact established beyond controversy, that age is a very powerful agent in deteriorating the active properties of bark, in-somuch that the best species of Peruvian bark when old, is little superior and sometimes even inferior to the carthagena bark when fresh; hence it is, that large parcels of a superior species of Peruvian bark, which would have commanded two dollars per pound at Cadiz, when fresh, has been offered publicly in this city for one-eighth the sum, twenty five cents, and that without a purchaser; and which it appears has been operated upon by no other unfavorable circumstance but age. In what manner or by what process age, or rather the circumstances connected with it, act upon bark other than by a combination with oxygen or a volatilization of its active principle, I know not. Fabroni states with truth, that cinchona loses its solubility, and consequently its activity, by long exposure to the air, but does not give his opinion as to the manner in which it is thus affected. I cannot, however, conceive under existing circumstances, how the solubility of Peruvian bark can be diminished, except through the agency of oxygen, and it is by this means the extract of bark, prepared according to the common formulas of our dispensaries, is rendered devoid of utility; for owing to the oxygenization of the extractive matter, the solubility of the extract is so diminished during its formation, that scarcely one half is soluble in water.

From a number of experiments which I have made upon Peruvian bark in different states, I have observed as an unequivocal result, that the same species of bark which when fresh is very productive of quinine, when old will produce little or none of this active principle, upon which its virtue as a medicine entirely depends.

It will appear therefore an important duty, critically to examine the state of bark as to age, and it may perhaps be useful in this place, to describe the physical characters of bark in this state, and by which it may be readily known. The prominent features which characterize old bark, and distinguish it from recent, are the following. Old bark has lost nearly all that bitter and astringent taste and peculiar aromatic odor, which are such prominent characteristics of recent bark of good quality. The specific gravity is also sensibly diminished, and the fracture instead of being shining and compact is dull, fibrous and of a loose texture, and the color very frequently passes from a bright orange to a dull brown, as the bark advances in age, particularly if much exposed. By attention to these few conspicuous characters, taste, smell, specific gravity, fracture and color, no mistake can arise in the selection of good bark, unless there is a gross deficiency of judgment. Yet notwithstanding the distinguishing characters of Peruvian bark in these two states are so prominent and striking, we regret to say, that gross mistakes have been made public in this particular, by men whom we might suppose most capable of appreciating the quality, under the influence of every incidental circumstance.

Dr. Paris in the sixth edition of his *Pharmacologia*, makes the following remarks under the article *cinchona*. The frauds committed under this head are most extensive; it is not only mixed with inferior bark, but frequently with genuine bark, the active constituents of which have been extracted by decoction with water. In selecting *cinchona* bark, the following precautions may be useful; it should be dense, heavy and dry, not musty, nor spoiled by moisture; a decoction made of it should have a reddish color when warm, but when cold it should become paler, and deposit a brownish red sediment. When the bark is of a dark color, between red and yellow, it is either of a bad species or it has not been well preserved. Its taste should be bitter, with a slight acidity, but not nauseous nor very astringent; when chewed, it should not appear in threads nor of much length, the odour

is not very strong, but when bark is well cured it is always perceptible, and the stronger it is, provided it be pleasant, the better may the bark be considered. In order to give bark the form of quill, the bark gatherers not unfrequently call in the aid of artificial heat, by which its virtues are deteriorated, the fraud is detected by the colour being much darker, and upon splitting the bark, by the inside exhibiting stripes of a whitish sickly hue. In the form of powder, cinchona is always found more or less adulterated. *This must be recollected as applying to the English market.* During a late official inspection of the shops of apothecaries and druggists, the censors repeatedly met with powdered cinchona having a hard metallic taste, quite foreign to that which characterizes good bark.\* The best test of the goodness of bark, is afforded by the quantity of cinchona or quina that may be extracted from it; and the manufacturer should always institute such a trial before he purchases any quantity, taking a certain number of pieces indiscriminately from the bulk.

Before concluding, it may not be out of season to remark, that the sulphate of quinine, as it is generally termed, is not a perfectly neutral salt, but in the state of a sub-sulphate, and is only partly soluble in water. Its exhibition in water is rendered much more eligible by the addition of a drop of sulphuric acid to each grain of the salt, which makes a perfectly transparent solution, and which, I think, from its obvious advantages, should entirely supercede the common formula: with sugar and gum arabic, a few grains of citric or tartaric acid will have the same effect in dissolving the quinine as the sulphuric acid, and has been preferred by some.

Dr. Paris,† on the exhibition of quinine, states that he lately saw a prescription in which the salt is directed to be rubbed with a few grains of cream of tartar, and then to be dissolved in mint water. This, he continues, is obviously injudicious, since tartaric acid decomposes the sulphate, and occasions an insoluble tartrate which is precipitated.

---

\* Mr. Thompson has suggested the probability of this circumstance having arisen from the admixture of a species of bark, lately introduced into Europe from Martinique, resembling the *cinchona floribunda*, and which by an analysis of M. Cadet was found to contain iron.—*London Disp. Edit. 3, p. 247.*

† *Pharmacologia, Edit. 6, vol. ii, p. 163.*



With due deference to the exalted judgment of Dr. Paris, I must however, on the following grounds, dissent from his opinions. The cream of tartar is objectional, merely from the circumstance that the active part of the compound may be obtained in a more direct and speedy process by the tartaric acid. The combination of cream of tartar and sulphate of quinine in the above prescription, does produce decomposition as Dr. Paris has observed, but the virtue of the medicine is not in the least affected by it, and the precipitate, instead of being an insoluble tartrate of quinine as he observes, is sulphate of potass; tartrate of quinine is a very soluble salt, and is held in solution while the water becomes slightly turbid by the precipitation of sulphate of potass, which, however from its extremely minute division is speedily taken up by the water, when you have a transparent solution of tartrate of quinine and sulphate of potass, and as the latter answers neither a good nor a bad purpose, it of course can very conveniently be dispensed with, and therefore, as before stated, the tartaric acid should be preferred as having a more speedy and direct action.

Piperine has proved a valuable adjunct to quinine; equal proportions of each will act with much more energy than the whole quantity of quinine or piperine alone. Dr. Chapman informs us, he has met with much success in the treatment of intermittent fevers by employing the following prescription.

R Quinine grs ×  
Piperine grs ×  
M. ft. Pill No ×

One to be taken every hour in the absence of fever.

Oil of black pepper is much more active than piperine, one drop being fully equal to three grains of piperine, three drops of oil of black pepper added to ten grains of quinine, will greatly increase the powers of this remedy, oil of black pepper alone is a valuable stimulant in typhus fever, and is a valuable adjunct to many medicines.

All the preceding varieties of bark, sulphate of quinine, cinchonine, and all the preparations of bark and quinine, may be procured at Geo. W. Carpenter's Chemical Warehouse, 301 Market street, Philadelphia.

*Note.*—An alkaline substance somewhat analogous to quinine, has recently been discovered in the cornus florida,

which has been denominated cornine, and which has been very carefully and accurately described by Dr. Samuel G. Morton in the Philadelphia Journal of Medical and Physical Sciences. From the most respectable sources in the medical profession, from various parts of the United States where the article has been sent, the most favourable accounts have been received of the unequivocal success of the cornine in the treatment of intermittent fevers in the same doses as the quinine, and the only circumstance which precludes its competition with that substance, is the extremely minute comparative proportion of cornine yielded by the *cornus florida*.

---

ART. IV.—*Observations on a new preparation of Balsam Copaiva*; by GEORGE W. CARPENTER, of Philadelphia.

† BALSAM Copaiva being a medicine used in the practice of almost every physician, its characters, effects and uses are consequently familiar to them. It is admitted by all, to be one of the most nauseous and disagreeable articles of the *materia medica*. Disguised or mixed as it may be, its unpleasant nature is still manifest, and little if at all diminished, communicating its nauseous taste and imparting to the breath its disagreeable odour which is experienced for several hours after each dose, and frequently acting as an emetic, or cathartic.\* From these circumstances, its use is frequently abandoned in cases where it otherwise would be of the highest utility, and even where it is almost indispensable, and other remedies much less efficient are substituted, thus protracting the cure which could have been speedily effected by the *copaiva*.

Since the introduction of this remedy down to the present period, it has ever been a desideratum to obviate these inconveniences, and it is a circumstance not less unfortunate

---

\* Our distinguished Professor of Practice, in the 1st volume of his *Therapeutics*, page 417, observes, that two circumstances frequently interfere with the exhibition of *copaiva*, and detract from its utility. It sometimes purges, and when it does, its efficacy is lost or greatly diminished. If *laudanum* does not check this injurious tendency, it must be discontinued till the bowels recover their tone. To the stomachs of some persons the *copaiva* is so exceedingly offensive, that it cannot be retained. As it is hardly possible to disguise the taste of the article, it is sometimes very difficult to overcome this prejudice.—*See Chapman's Therapeutics.*

and much to be regretted, *than* it is singular in its character, *that* amidst the rapid march of improvement and discoveries, (which forms a peculiar character in modern chemistry and pharmaceutical knowledge,) an improvement in the exhibition of copaiva, should so long have evaded the vigilant researches of the critical and scrutinizing chemist, and pharmacist. With these premises, I feel happy to inform the medical faculty that I have succeeded in consolidating copaiva to a proper consistence, for being formed into pills. The consolidated copaiva is the oil and resin united, and consequently possesses all the properties of the balsam. It may be made into four grain pills, and one or two pills taken three times a day; two pills are equal to thirty drops of the balsam. These pills may be taken without the least inconvenience, neither communicating taste, nor imparting odour to the breath, it is also retained without the least disquietude or uneasiness to the stomach, and I am informed by Dr. Rousseau, that in large doses, it does not purge.

This article differs, very essentially, from what is termed extract, or resin copaiva, being not in the least deteriorated in the preparation, nor at all weakened by admixture of any foreign substance for the purpose of giving consistence. It is particularly recommended to the faculty for its numerous advantages over the *balsam*, and all its preparations. As the oil of copaiva is an active preparation, it is the best mode of using this article, for being united with the resin it may be made into pills which can be taken without producing the nauseating taste of the oil, while the oil alone cannot be taken otherwise than in draught, which will subject it to the same inconveniences with the fluid balsam, having its disagreeable taste with its unpleasant effects.

The consolidated copaiva is manufactured and sold at Geo. W. Carpenter's Chemical Warehouse, No. 301, Market street, Philadelphia.

---

ART. V.—*Notice of the appearance of Fish and Lizards in extraordinary circumstances; by* JOSEPH E. MUSE.

Cambridge, E. S., Maryland, Jan. 5, 1829.

TO PROFESSOR SILLIMAN.

THE late notice in an English paper, of a shower of herrings witnessed by a Major McKenzie, as he traversed a field

on his farm, leads me to communicate to you a most singular instance of the apparently playful aberrations of nature from those laws, which she had prescribed for herself, and under whose influence, she most usually, and most wisely operates.

In the course of the last summer I ordered a ditch to be cut of large dimensions, on a line of my farm near Cambridge: the line was a plane, ten feet above the level of the neighboring river, and at least one mile from it, at the nearest point of the line; a portion of the ditch being done, the work was interrupted by rain for ten or twelve days; when the work was resumed, on examining the performance, I discovered that the rain water which had filled the ditch, thus recently cut, contained hundreds of fish, consisting of two kinds of perch which are common in our waters the "sun perch," and the "jack perch;" the usual size of the former is from six to twelve inches, the latter varies from ten to fifteen inches long; those in the ditch were from four to seven inches: by what possible means could these fish have been transported so far from their native waters? There is no water communication on the surface, to conduct them there; the elevation and extent of the plane, in regard to the rivers, utterly prohibit the idea; the eggs, if placed there by a water-spout, could not have suffered so rapid a transmigration; no such phenomena had been observed, and the adjacency of the line to the dwelling, would have rendered the occurrence, impossible, without notice.

Already has the theory of Descartes, and the philosophical generation of Trembley and Spalanzani encroached upon the animal dignity, in propagating it by cuttings from the parent stock; yet, that animal life should spring from a fortuitous concourse of lifeless atoms, assisted by the concurrent agency of putrefaction, a suitable element, a suitable temperature, or other such circumstances, apparently adapted to its nascent existence, is a heterodox opinion which I should be averse to entertain.

A similar occurrence a few years ago, I witnessed on the same farm; in a very large ditch, cut on lower lands, on a line equally unconnected with any river, pond, or other surface-water, there were, under very similar circumstances, numerous perch, which afforded fine angling to my children. On a diary which I keep, I have entered, that several of them measured as much as twelve inches in length, and that

the time since their arrival there, could not possibly have exceeded a fortnight. The fall of meteorolites from the heavens has been recorded by the historian, from the earliest ages, and as often discredited, from philosophic vanity. The frequent recurrence of this seeming physical paradox, having been finally established on the fullest evidence, should guard the philosopher against vain presumption, and fortify him in other cases, in the hope of successful research.

While on the subject of mysterious nature, I will introduce, as concisely as possible, a case, where she reconciled animals of the coldest and most meagre habits to the enjoyment of the warmth and luxuries of the human stomach; for these facts, though not personally conversant with them, I have the authority of a medical gentleman of unquestionable veracity, to vouch for their rigid truth; in reply to my request to be informed of the habits, food, drink, employment, &c. of the patient, I received the following account. "On my arrival, I found that she, (the patient,) had puked up two ground puppies and was labouring under a violent sick stomach, with pain, and syncope: the first was dead when ejected, the second was alive when I arrived, and ran about the room; they were about three inches long; she informed me, that on the road that morning she had thrown up two others; the case occurred in the summer, and had made gradual progress, from the first of April, and as she described it, with a peculiar sickness, and frequent sensation of something moving in her stomach; with slight pain and loss of appetite, which increased till her illness. She was about twenty years of age, and had enjoyed good health; her employment had confined her in the swamp, during the winter and spring, and she had from necessity, constantly drunk swamp water." The physician administered an emetic in quest of more puppies, but being disappointed, he gave an opiate; she was relieved, finally, and has been, since, in health.

These animals have, since, been shown to me: they are not the ground puppy, (gecko,) as they are vulgarly called; they resemble it very much, but are easily distinguished from it; they belong to the same genus, (lacerta, or lizard,) but are of the species "salamander;" their habitudes too, are essentially different; the gecko is found in houses and warm places; the salamander in cold damp places, and shaded swamps, and by the streams of meadows; these animals though oviparous, hatch their eggs in the belly, like the viper and pro-

duce about fifty young at a birth. The inference is irresistible, that the patient had, in her frequent draughts of swamp water, swallowed, perhaps thousands of these animals in their nascent, or most diminutive state of existence, and a few only survived the shock; but it is matter of astonishment, that from the icy element in which they had commenced their being, and for which, they were constituted by nature, they should bear this sudden transportation to a situation so opposite in its character, and grow into vigorous maturity, unannoyed by the active chemical and mechanical powers to whose operation they were subjected.

ART. VI.—*Meteorological Observations.*

1. *Abstract of Meteorological Observations, made at Marietta, Ohio, in N. lat. 39° 25', W. long. 81° 30', in the year 1828, by S. P. HILDRETH.*

Months.	Thermometer				Warmest day.	Coldest day.	Fair days.	Cloudy days.	Depth of rain.		Prevailing winds.
	Mean temperature.	Maximum.	Minimum.	Range.					Inches.	Hundredths.	
January,	41.70	63	10	53	2	10	14	17	4	04	S. W. & W.
February,	44.20	70	17	53	2	13	15	14	6	75	S. W. & N. W.
March,	48.30	83	17	66	29	1	23	8	2	13	S. W. N. & N. W.
April,	50.00	82	26	56	23	9	17	13	6	50	S. W. E. & S. E.
May,	62.75	92	35	57	4 & 5	8	19	12	6	58	S. W. N. W. & E.
June,	72.57	94	54	40	26	9	25	5	4	92	S. S. W.
July,	70.90	90	54	36	24	2	23	8	5	08	S. W. & N. W.
August,	72.72	94	53	41	31	19	26	5	3	00	S. W. & N.
September,	62.52	86	42	44	1	11	16	14	3	42	S. & N. N. W.
October,	52.10	80	24	56	24	16 & 17	25	6	2	50	S. S. W. & W.
November,	45.70	70	24	46	3	25 & 26	17	13	3	42	N. & N. W. W. & S. W.
December,	39.17	70	14	56	3	26	22	9	1	16	W. S. W. & N. W.
							242	124	49	50	

Mean temperature for the year, 55.22.

Rain, 49 inches and  $\frac{5}{100}$ ; being 3 inches and  $\frac{2}{100}$  more than fell in the year 1827.

Prevailing winds, S. and S. W.

Hottest month, August—coldest month, December.

N. B. The thermometer has a northern exposure, in the shade. Observations taken at 7 A.M. in winter, at 6 A.M. in summer, and at 2 and 9 P.M.

*Observations on the flowering of plants, ripening of fruits, &c. in the past year.*

*January.*—5th. Day so warm that snakes are seen by several different persons. 6th. Grass as fresh as in May, and a multiflora rose, trained on the north side of my house, putting forth leaves. 7th. Wild geese seen to-day, a circumstance very uncommon at this season of the year. 9th. Frequent and heavy rains caused the Ohio river to rise on the 6th, and by the 9th the water was eight feet deep over the low bottom lands; began to fall on the 10th, doing much damage to the fences, stacks of hay, corn, &c. 12th. Vegetation rapid, peas planted in November two or three inches high—the larva of insects seen in motion in pools of stagnant water. 25th. Small sheets of floating ice in the Ohio for three days, but none in the Muskingum all winter—steam boat navigation good through the season. 27th. Heavy gale of wind, commencing at 4 P. M. preceded by a rainy night; continued for ten hours, with violent gusts from the west; clouds, light, white, fleecy cumuli; full moon at 9. The same gale did great damage on Lake Erie, to shipping, property, &c. with the loss of several lives.

*February.*—1st. Honey bee at work, and returns with its thighs loaded with farina. 4th. Buds of the peach tree nearly swelled. 6th. Peach trees in bloom at Burlington, Lawrence county, being the most southerly bend of the Ohio river bordering this state. 8th. White maple in bloom. 16th. Elm in bloom, on the banks of the Ohio; crocus and snow drop in bloom in the garden.

*March.*—6th. Common robin heard to-day. 8th. Black-bird seen. 9th. Peewe first heard. 10th. Smart shock of an earthquake felt at half past 10 last night. 11th. Some peach trees in bloom. 12th. Blue damison in bloom. 13th. Peas planted the 23d of last month, in open ground, now up. 17th. cerastium vulg. in full bloom. 18th. Sugar maple putting forth leaves, quite green; peach trees in full bloom. 20th. Sambucus opening its leaves, quite green. 21st. Crown imperial in bloom, in my garden. 23d. Spice-bush, sassafras and June berry in bloom, in the woods. 27th. Golden beurè and brown beurè, pear in bloom; Erythr. Amer. or dog's tooth violet in bloom; dodecatheon, ready to blow. 28th. Cornus florida and red bud, or Judas tree, opening their blossoms.

*April.*—2d. Ox-heart cherry in bloom, on the north side of the house, out of the sun's rays. 3d. *Anona glabra* and papaw in bloom; apple trees in full bloom for some days. 4th, 5th and 6th. Smart showers of snow—ice half an inch in thickness; thermometer at 22° on the morning of the 5th, and 28° on the morning of the 6th. Peach blossoms all killed; apples and cherries much injured; snow four inches deep. The same destructive frost felt in Georgia and Alabama, destroying wheat, corn, fruits, &c. with ice an inch in thickness. 9th. Birth-wort in bloom. 11th. Mayduke cherry in bloom. 17th. Coral honeysuckle in bloom. 25th. Horse chestnut in bloom. 29th. Peas in bloom. 30th. *Curculio* or May beetle flying in the evening.

*May.*—1st. Tulips beginning to bloom. 3d. White *Narcissus* and tulips in full bloom; crab apple in bloom. 6th. Bees sending out young swarms. 8th. Yellow and Burgundy roses in blow. 9th. Purple mulberry in bloom. 12th. Butternut and black walnut in bloom. 15th. Yellow locust or pseudo acacia in bloom. 17th. *Liriodendron*, yellow poplar, in bloom. 18th. High blackberry do. 20th. Hickory tree do. 22d. *Prunus Virginiana* in bloom. 24th. Peas fit for the table. 27th. Rye in head.

*June.*—1st. Wild comfrey in bloom. 7th. Purple raspberry ripe. 8th. *Sambucus* in bloom. 9th. *Spiria trifoliata* in bloom. 10th. Purple mulberry ripe. 12th. Early York cabbage and early quaker bean fit for table, raised in open ground. 13th. *Catalpa* beginning to bloom. 14th. Rosebay in bloom, in the woods. 16th. Lamacle in bloom. 17th. Cucumbers fit for table, raised in open ground. 27th. Early Chandler apple fit for eating.

N. B. The crops of grain were very luxuriant, but the wheat was greatly damaged by blight and rust, owing to the very wet and warm season. Hay was very fine. Indian corn suffered from the wet; many ears decaying or rotting within the husks, upon the stalks. Potatoes very good. Apples in abundance, but no peaches; cherries and currants scarce. Grapes, of the tender kinds, affected with rust or blight on the leaves, and the fruit turning black and dropping off near the time of ripening: the purple and more hardy kinds fared better. English gooseberries suffered in the same way. Pears and quinces were all killed by the frost of the 5th of May.

Marietta, Ohio, Jan. 3, 1829.



2. Abstract of a Meteorological Journal, kept in the town of New Bedford, for the years 1827 and 1828.

Six's self registering Thermometer.					Standard Barometer.			10 inch- es.	snow	Therm. Barometer			Rain and atmospheric pressure.				Atmosphere.						
1827. Months	s. r.	2 c'l'k	s. s.	o'clk	mean.	s. rise.	2 o'clk			sunset	10 o'clk	max.	min.	max.	min.	NW	SW	SE	NE	Fair.	Cloudy.	Rain.	Snow.
Jan.	22.	5 29.	0 27.	5 24.	5 25.	9	30.000	29.951	29.983	30.018	2.79	45	-1	30.52	28.82	16	5	3	7	15	9	2	5
Feb.	28.	2 34.	7 33.	1 31.	3 31.	8	30.024	29.967	29.993	30.020	3.55	48	2	30.65	29.33	12	9	4	3	17	9	1	1
March,	32.	8 42.	3 39.	7 36.	6 37.	8	30.072	30.079	30.087	30.109	4.34	60	17	30.68	29.32	11	7	7	6	21	4	6	0
April,	43.	1 54.	4 50.	6 47.	7 48.	9	30.002	29.963	29.958	29.960	3.08	67	29	30.66	29.27	7	13	6	4	16	7	7	0
May,	49.	9 60.	7 55.	2 52.	7 54.	6	29.997	30.004	30.017	30.010	6.17	79	37	30.39	29.54	6	10	10	5	19	5	7	0
June,	53.	5 69.	7 64.	5 61.	2 63.	5	30.132	30.122	30.130	30.132	3.93	81	48	30.49	29.77	6	15	7	2	18	4	8	0
July,	64.	8 76.	2 71.	2 68.	1 70.	1	30.138	30.146	30.147	30.148	3.87	88	53	30.39	29.87	6	13	7	5	20	5	6	0
August,	63.	3 73.	4 69.	4 66.	5 68.	1	30.175	30.168	30.171	30.180	6.78	91	54	30.51	29.71	4	15	8	4	20	6	5	0
Sept.	57.	9 67.	6 64.	3 60.	6 62.	7	30.152	30.142	30.143	30.156	5.02	80	48	30.53	29.82	8	7	7	8	16	8	6	0
Oct.	50.	0 59.	0 55.	6 53.	0 54.	4	30.070	30.057	30.070	30.082	5.94	69	32	30.49	29.46	5	15	2	9	15	10	6	0
Nov.	33.	1 40.	8 38.	5 35.	6 37.	0	29.941	29.881	29.908	29.923	7.48	60	20	30.61	29.00	19	5	4	2	16	10	4	0
Dec.	32.	0 37.	5 35.	8 34.	0 34.	8	30.211	30.189	30.182	30.217	2.96	53	10	30.63	29.19	15	4	6	6	10	17	2	2
The Yr.	44.	7 53.	8 50.	4 47.	6 49.	1	30.076	30.056	30.066	30.080	55.91	91	-1	30.68	28.82	115	118	71	61	203	94	60	8
1828.																							
Jan.	31.	3 37.	0 35.	0 33.	2 34.	10	30.129	30.108	30.137	30.131	2.68	52	6	30.57	29.45	14	6	9	2	12	10	7	2
Feb.	34.	5 41.	4 38.	1 36.	2 37.	55	29.980	29.953	29.950	29.944	2.89	54	17	30.48	29.29	8	13	3	5	13	9	4	3
March,	32.	9 43.	6 39.	7 35.	7 38.	0	30.095	30.061	30.103	30.114	3.83	73	16	30.47	29.57	13	2	9	7	19	7	4	1
April,	37.	6 48.	3 44.	4 40.	8 42.	80	29.955	29.960	29.963	29.976	3.09	64	31	30.33	29.47	13	5	3	9	15	10	3	2
May,	49.	1 61.	0 55.	4 52.	1 54.	40	29.977	29.949	29.946	29.955	3.48	76	42	30.47	29.38	9	6	10	6	13	9	9	0
June,	65.	0 78.	6 66.	8 63.	6 66.	20	30.051	30.046	30.056	30.065	3.59	89	49	30.33	29.59	1	20	7	2	12	12	6	0
July,	61.	8 78.	2 70.	3 67.	9 70.	30	29.905	29.915	29.913	29.923	2.69	88	57 <sup>1</sup>	30.15	29.72	5	21	3	2	17	5	9	0
August,	64.	8 78.	1 71.	3 67.	9 70.	52	30.066	30.065	30.064	30.082	1.02	90	57	30.44	29.78	8	14	3	6	23	5	3	0
Sept.	58.	5 69.	4 63.	7 61.	8 63.	30	30.091	30.083	30.086	30.092	3.23	87	49	30.31	29.85	4	11	4	11	17	7	6	0
Oct.	39.	2 58.	1 53.	2 48.	8 50.	80	30.100	30.085	30.099	30.113	3.22	72	27	30.52	29.64	13	10	6	2	18	10	3	0
Nov.	39.	7 48.	7 44.	9 42.	7 44.	0	29.994	29.970	29.974	29.995	4.58	60	23	30.52	29.28	9	10	5	6	14	7	8	1
Dec.	33.	8 41.	9 38.	5 35.	5 37.	42	30.052	30.010	30.035	30.051	0.40	60	11	30.52	29.49	13	13	3	2	20	9	2	0
The Yr.	46.	12 56.	6 61	51.77	48.85	50.782	30.033	30.017	30.027	30.037	36.00	90	6	30.57	29.28	110	131	64	60	193	100	64	9

## ART. VII.—Calendar of Vegetation.

Germanflatts, Herkimer county, N. Y. July 7, 1828.

TO THE EDITOR OF THE JOURNAL OF SCIENCE.

Sir—The enclosed, very imperfect, calendar of the progress of vegetation, in the vicinity of Newport, Herkimer county, N. Y. was taken during my practice in that place as physician. As to the times of flowering, I would observe, that they are all set down upon the first appearance of any to my own observation, and I believe, may be considered as correct.

Respectfully yours,

A. W. BOWEN.

1826.	Common name.	Systematic name.	State of progression.
May	4. Red Plum,	Prunus chicasa,	leaves 1-2 inch long.
	7. Soft Maple,	Acer rubrum,	in fl'r., leaves opening.
	" Moose-wood,	Dirca palustra,	do. do. 3-4 inch long.
	" Red berried Elder,	Sambucus pubescens,	leaves expanded.
	" Garden Pina,	- - - - -	6 inches high.
	" Violet,	Viola trifolia,	in flower.
	" Mountain Ash,	Sorbus americana,	leaves expanded.
	" Lilack,	Syringa vulgaris,	grown 4 inches.
	10. Currant,	Ribes rubrum,	in flower.
	12. False wake Robin,	Trilium erectum,	do.
	" Swallows,	- - - - -	first observed.
	" Striped Maple,	Acer striatum,	in flower.
	" Whip-poor-will,	- - - - -	first heard.
	14. Dandelion,	Leontodon taraxacum,	in flower.
	" Night Hawks,	- - - - -	appear.
	15. Garden Columbine,	Aquilegia vulgaris,	in flower.
	16. Swamp Oak,	Quercus prinus,	leaves expanding.
	" Apple-tree,	Pyrus malus,	in flower. [houses.
	" Woodbine,	Lonicera hirsuta,	leaves expanded on the
	" Red Plum,	Prunus chicasa,	flowers dropped.
17. Lilack,	Syringa vulgaris,	in flower.	
18. Strawberry, (wild,)	Fragaria virginiana,	do.	
22. Flower De Luce,	Iris virginica,	do.	
26. Snow-ball,	Viburnum opulus,	do.	
28. Mountain Ash,	Sorbus americana,	do.	
" Locust,	Robinia pseudo-acacia	do.	
June	3. Pina in gardens,	- - - - -	do.
	5. Spider-wort,	Tradescantia virginica	do.
	" Canada Thistle,	Cnicus arvensis,	6 inches high.
	6. Horse Radish,	Cochlearia amoracia,	in flower.
	" Wild Strawberry,	Fragaria virginiana,	ripe.
	8. Butter Cup,	Ranunculus acris,	in flower.
	16. Red berried Elder,	Sambucus pubescens,	ripe.
	" Milk-weed,	Asclepias,	in flower.
20. Water Lilies,	Nymphaea lutea,	do.	

1826.	Common name.	Systematic name.	State of progression.
June	26. Thorn Apple,	Datura stramonium,	in flower.
	27. Poison Hemlock,	Conium maculatum,	do.
	28. Red Raspberry,	Rubus occidentalis,	ripe.
July	2. Black do.	Rubus strigosus,	do.
	" Wild Cherry,	Prunus avium,	do.
	3. Flax,	Linum usitatissimum,	in flower.
	" Garden Cherry,	Prunus cerasus,	ripe.
	" Currant,	Ribes rubrum,	do.
	" Sweet Elder,	Sambucus canadensis,	in flower.
	" Willow-herb,	Epilobium spicatum,	do.
	9. Bass-wood,	Tillaea glabra,	do.
	" Senna,	Cassia senna,	do.
1827.			
Feb.	15. Striped Squirrel,	- - -	first appear.
March	20. Robin,	- - -	do. do.
	" Swamp willow,	Salix capria,	opening its buds.
	27. Butterfly,	- - -	seen.
	" Woodpecker, (red)	- - -	do.
	28. Hemlock,	Conium maculatum,	3 inches high.
	30. Blue-bird,	- - -	appear.
April	4. Frogs,	- - -	heard to croak.
	7. Martins,	- - -	appear.
	" Violets,	- - -	in flower.
	13. Elm,	Ulmus nemoralis,	do.
	15. Soft Maple,	Acer rubrum,	do.
	" Black berried Elder,	Sambucus pubescens,	do.
	" Moose-wood,	Dirca palustris, [sis,	do.
	" Blood Root,	Sanguinaria canadensis,	do.
	" Viola, (wild)	Viola striata,	do.
	" Garden Violets,	Viola odorata,	do.
	24. Bath Root,	- - - [nis,	do.
	" Adder-tongue,	Erythronium dens-ca-	do.
	" Daffodil,	- - -	do.
28. Swallows,	- - -	first observed.	
May	3. Red Plum,	Prunus chicasa,	in flower.
	8. Pie-plant,	- - -	do.
	12. Dandelion,	Leontodon taraxacum	do.
	14. Cowslip,	- - -	do.
	" Wild Blue Lily,	- - -	do.
	17. Apple-tree,	Pyrus malus,	do.
	" Bell-wort,	Streptopus roseus,	do.
	18. Celandine,	Chelidonium majus,	do.—frost.
	" Gooseberry,	- - -	do.
	" Strawberry,	Fragaria virginiana,	do.
	" Wild-bird Cherry,	Prunus avium,	do.
	19. Tulip,	- - -	do.
	" Striped Maple,	Acer striatum,	do.
	" Garden Columbine,	Aquilegia vulgaris,	do.
20. Lilack.	Syringa vulgaris,	do.	
21. Mountain Ash,	Sorbus americana,	do.	
" Lily of the Valley,	Convallaria majalis,	do.	
22. Red Plum,	Prunus chicasa,	flowers dropped.	
" Daffodil,	Narcissus,	in flower.	
25. Night Hawks,	- - -	first observed.	
26. Flower De Luce,	Iris virginica,	in flower.	
28. Currants,	Ribes rubrum,	fit to cook.	

	1827.	Common name.	Systematic name.	State of progression.
May	31.	Hawthorn,	<i>Crataegus flava</i> ,	in flower—severe frost.
June	1.	Snow-ball,	<i>Viburnum opulus</i> ,	do.
		Butter Cup,	<i>Ranunculus acris</i> ,	do.
		Garden Pina,	- - -	do.
		Horse Radish,	- - -	do.
	5.	White Clover,	- - -	do.
		Strawberry,	<i>Fragaria virginiana</i> ,	ripe.
		Spider-wort,	<i>Tradescantia virginica</i>	in flower.
		Locust,	<i>Robinia pseudo-acacia</i>	do.
	7.	Sugar Maple,	<i>Acer saccharinum</i> ,	do.
		Rye,	- - -	do.
		Black Raspberry,	<i>Rubus strigosus</i> ,	do.
		Red do.	do. <i>occidentalis</i> ,	do.
		Blackberry,	- - -	do.
		Dog-wood,	<i>Cornus canadensis</i> ,	do.
		Sage,	<i>Salvia officinalis</i> ,	do.
	14.	Asparagus,	<i>Asparagus officinalis</i> ,	do.
	17.	Rase,	- - -	do.
	20.	Sweet Briar,	<i>Marrubium vulgare</i> ,	do.
		Hoarhound,	- - -	do.
		Fox Glove,	<i>Digitalis</i> , (white)	do.
	24.	Peas,	- - -	do.—frost.
	26.	Mullin,	- - -	do.
		Red berried Elder,	<i>Sambucus pubescens</i> ,	ripe.
		Sweet do.	do. <i>canadensis</i> ,	in flower.
	27.	Milk-weed,	<i>Asclepias</i> , [tum,	do.
	30.	John's-wort,	<i>Hypericum perfora-</i>	do.
July	1.	Indian Corn,	<i>Zea mays</i> ,	tassel in sight.
		Green Peas,	- - -	fit to cook.
		Currant,	<i>Ribes rubrum</i> ,	ripe.
	3.	Poppy,	<i>Papaver somniferum</i> ,	in flower.
	4.	Raspberry,	<i>Rubus occidentalis</i> ,	ripe.
	5.	Water Lily,	<i>Nymphaea lutea</i> ,	in flower.
		Raspberry,	<i>Rubus strigosus</i> ,	ripe.
	6.	Garden Cherry,	<i>Prunus cerasus</i> ,	do.
	7.	Indian Corn,	<i>Zea mays</i> ,	silks developed.
		Cucumber,	- - -	in flower.
	8.	Common Thistle,	- - -	do.
		Flax,	<i>Linum usitatissimum</i> ,	do.
	10.	Wheat,	- - -	do.
	14.	Indian Corn,	<i>Zea mays</i> ,	do.
	16.	Rye,	- - -	ripe.
17.	Peas,	- - -	do.	
20.	Senna, (American)	- - -	in flower.	
25.	Indian Corn,	<i>Zea mays</i> ,	fit to boil.	
29.	Cucumbers,	- - -	ripe.	

August 23 and 24, frost; 29th, was seen the *lusus* (*naturæ*?) in the heavens, which at this place extended from east to west, touching both horizons, in the form of a brilliant arch of fog; its particles evidently moved from east to west as fast as clouds do in a storm.

April 24, 1828. Moosc-wood, Blood Root, Soft Maple and Wild Violets, in flower.

ART. VIII.—*Strictures on the Hypothesis of Mr. Joseph Du Commun, on Volcanos and Earthquakes;*\* by BENJAMIN BELL, of Charlestown, Mass.

TO MR. JOSEPH DU COMMUN.

*Sir*—IN accordance with your opinion, as well as with that of Dr. Franklin, Mr. Perkins and others—I will allow that atmospheric air can be compressed to such a degree as to be heavier than water; and that if forced down by means of a bell *lower than* twenty five thousand six hundred feet below the surface of the sea, it *may* stay there, for the present, or may fall to the bottom. We will suppose the lowest depth of the sea-water to be found at the precise point of twenty five thousand six hundred feet from the surface, which, for brevity, I shall call the separating point; and that a stratum of condensed air occupies the space between that point and the liquid oxygen below, a gallon of which stratum being heavier than a gallon of sea-water. At this point of contact (separating point) the air (see page 16, line 30) must be, as you *say*, “exactly of the same density with the water.”

But what would be the density of a bubble of air, if conveyed by the bell and left one foot above the separating point? As this bubble would have a density less than the air *at* the separating point, it must rise to the surface; it cannot fall, or, as you say, “shower through the water.”

If then a bubble of air rises, when formed or left one foot above the separating point, it may be fairly asserted that it would rise if formed one inch, or even  $\frac{1}{100}$  of an inch above it. To maintain this gaseous stratum then, it is necessary to suppose, that the evolution of gas from the water is made precisely *at* the separating point, and that air bubbles (i. e. air surrounded by a liquid) *are not formed*.

But what should cause a separation at all? The air held in solution *near* the separating point ought to be combined with some degree of force, else it would be likely to separate before it was carried there. Supposing however, that it arrives *down to the point*, there is a great objection to its separating at that precise point, in preference to a quarter of an inch above; for no chemical attraction between the

---

\* See Vol. XV. No. 1. Art. iii. of this Journal.

condensed air below, and the air held in solution can be supposed; it being known that the particles of gas, constantly repel each other.

The answer given by you to number six and seven, objections of the Editor, does not give me satisfaction: "That the air should separate from water, saturated and compressed" is *not* as we think supported by analogy, but is contrary thereto, as all soda-water preparers may witness. Indeed, Sir, in support of this part of your hypothesis, a few facts or examples are required.

Allowing however, as fact, that air is conveyed, by natural means *below* the separating point; and that three fluids are formed, resting upon the terraneous bottom, what now would be the effect of subterraneous heat upon the superincumbent mass of fluid? Would not a circulation ensue, effecting an exchange between the lower and upper portions, altogether producing such an operation as is known to occur frequently in our atmosphere? A small movement being once commenced, would not stop till the marine basin were emptied of all its substratified air: moreover, if a whirl be formed under water, as whirlwinds are above it, the rush of the expanding air upward must be tremendous, for the force of which I refer to your observations near the bottom of page 16. Now although violent and deep currents have been detected in the ocean, which are undoubtedly more irregular at the bottom, yet no escape of respirable air at the surface of the sea to the extent here indicated has to my knowledge been noticed by any writer.

On the other hand, if it be allowed that oxygen gas is susceptible of being thus crowded under the ocean, and there kept, what law has interfered to prevent the whole of the oxygen which surrounds our globe from being thus disposed of, leaving none for the use of its supermarine inhabitants? If it be allowed that nitrogen gas can thus be condensed and located, may we not fear that our atmosphere will in course of time disappear, having retired for the increase of the tides, or to prepare for the deluge of the earth?

It seems necessary that some other hypothesis be invented to account for the phenomena of volcanos. Possibly may oxygen be conveyed from the ocean to the interior of the earth by the agency of electricity, forming there a liquid depot, in reserve for the combustion of such metals as may have been deoxidized by a similar agency. But as you have

promised to present your readers with some new considerations of your principle, be pleased to pardon this digression.

BENJ. BELL.

---

ART. IX.—*A Discourse on the different views that have been taken of the Theory of Fluxions; by ELIZUR WRIGHT.*

WHOEVER has made the smallest progress in the science of fluxions, must perceive, that there are difficulties attending the explanation of its first principles, which have never yet been fully removed. The learner in the outset has to encounter apparent errors, or to consider them lost in the incomprehensibility of infinity, or if with Sir Isaac Newton he chooses to view fluxions as illustrated by the philosophical principal of motion, he is still surrounded with mystery. Many of the less aspiring are undoubtedly deterred, on this account, from making any considerable proficiency in this important branch. Although this science may assume a more elevated rank by means of that sublimity, which arises from obscurity, and the ordinary mathematician may look up to the adept in this department with a kind of enthusiastic veneration, as having gained an enviable pre-eminence by mastering abstruse elements; yet to the proficient himself it is in a high degree satisfactory to lay the foundation of science in clear, self-evident principles, and to proceed on in the march of discovery in a path that inspires confidence. The elements of a science should be rendered as plain as possible. An examination of the different views that have been taken of the theory of fluxions, and a discrimination of the parts designed to be elucidated, will contribute in no small degree towards attaining this object. Sir Isaac Newton considered the doctrine of fluxions under the idea of quantities, that arise into existence by one uninterrupted increment according to the laws of continuity. Quantities, according to this method, are augmented in a manner, that does not admit of distinct separable parts. Although Newton applied the calculus to quantities both geometrical and numerical, yet he chose to illustrate the theory by geometrical ones; which by introducing the properties of motion, afford a very clear explanation. For according to the illustration of Vince, in his first section, §7. page 3. "Let the line FK be described with an uniform velocity, and AZ with an

accelerated velocity, and let the increments  $Gs$   $Pm$  be generated in the same time; let also  $Pv$  be the increment that would have

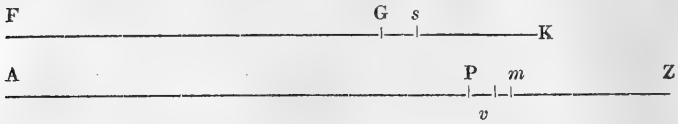

been generated in the same time, if the velocity at  $P$  had been continued uniform; then by Prop. I. the fluxions of  $FK$ ,  $AZ$ , at the points  $G$  and  $P$ , will be represented by  $Gs$  and  $Pv$ . Let  $V$  be the velocity at  $P$ , or the velocity with which  $Pv$  is described, and let  $r$  be the increase of velocity from  $P$  to  $m$ ; then the velocity at  $m$  will be  $V+r$ , and  $vm$  is the increment which is described in consequence of the increase  $r$  of velocity since the describing point left  $P$ . Now let  $V+w$  be the *uniform* velocity with which  $Pm$  would be described in the same time that  $Pv$  and  $Pm$  are described, as before mentioned; then it is manifest, that this uniform velocity must be between the velocities at  $P$  and  $m$ , that is,  $V+w$  is greater than  $V$  and less than  $V+r$ , or  $w$  is greater than  $o$  and less than  $r$ . Also, since the spaces described in the same time are as the velocities,  $V : V+w :: Pv : Pm$ . Now in *every* state of these increments,  $V : V+w :: Pv : Pm$ ; and by continually diminishing the time, and consequently the increments, we diminish  $r$  and  $w$ , but  $V$  remains constant; it is manifest therefore that the ratio of  $V : V+w$ , and consequently that of  $Pv : Pm$ , continually approaches towards a ratio of equality, and when the time, and consequently the increments, become actually  $=O$ , then  $r=O$ ; consequently  $w=O$ ; therefore the *limit* of the ratio of  $Pv : Pm$  becomes that of  $V : V$ , a ratio of equality. Hence the *limit* of the ratio of  $Gs : Pm$  is the same as the *limit* of the ratio of  $Gs : Pv$ , or it is  $Gs : Pv$ , that ratio being constant."

From the foregoing reasoning it is manifest, that the limiting ratio of the increments expresses accurately the rate of increase in the fluent at any assigned point in its generation. An example in geometrical quantities of two dimensions may be derived from the square, in which the two generating lines constitute the limit. The ultimate ratio, then, expressed by its usual representatives will be  $2x : 1$ , or, combining the



fluxional base with the limit  $2xx' : x'$ . An example in quantities of three dimensions is afforded by the cube, in which the three generating squares form the limit; hence the ultimate ratio is  $3xx' : 1$ , or  $3x^2x' : x'$ . This is also called the fluxional ratio. Its legitimate use is to illustrate the manner in which fluents are generated, and to shew their rate of increase at any point in their production.

Leibnitz, in his illustration of this science, contemplated numerical, otherwise termed discrete quantities. Here the increase is made by the continued addition of a distinct separable part, called the measuring unit. But to accommodate the genesis to the nature of variable quantities, he was under the necessity of considering this elementary part as infinitely small, or as some call it an infinitesimal. According to this method the integral is supposed to be produced by the regular aggregation of insensible parts, by which it successively passes through every assignable magnitude, from 0 to the given one. Here it may seem difficult to conceive, how a quantity can arise into existence by the addition of parts that are infinitely small, and consequently such as we cannot arrive at. But the difficulty will be removed by recurring to the clearer method of Sir Isaac Newton, in which the principle is exemplified by a body in motion. Should the subtle metaphysician ask how a fluent can be generated by the addition of infinitely small elements, we have only to place before his eyes a body, moving either with an accelerated, or a retarded motion, and the proposition is illustrated by a familiar fact. In a mathematical view, the co-efficient of the fluxion is the limit, towards which the increment approaches, when it is made to vanish, and is in effect equal to the evanescent quantity, which is supposed to exist at the moment when the fluent is completed; and the fluent is the limit of the aggregate of all the nascent quantities, which are supposed to arise successively during the time of its generation. The differential calculus illustrates the genesis of variable quantities by the aggregation of infinitely small elements, which we must conceive to be a process analogous to motion, and by contemplating quantities having dimensions beyond those of length, breadth, and thickness, the theory becomes more extensive. For, instead of being confined to the second and third powers, we may introduce the general expression  $x^n$ , extending to any higher power. Then supposing  $z$  to represent the increment of  $x$ , the ratio of the

increment of  $x^n$  to the increment of  $x$  will be  $nx^{n-1}z + n \cdot \frac{n-1}{2} x^{n-2}z^2 + n \cdot \frac{n-1}{2} \cdot \frac{n-2}{3} x^{n-3}z^3 + \&c. : z$ . Dividing by  $z$

it becomes  $nx^{n-1} + n \cdot \frac{n-1}{2} x^{n-2}z + n \cdot \frac{n-1}{2} \cdot \frac{n-2}{3} x^{n-3}z^2 \&c. : 1$ .

If  $z$  be diminished by an indefinite subdivision, the increment will approach continually towards  $nx^{n-1}$  as its limit. Suppose  $z$  to be less than any assignable quantity, it will then become equal to  $o$ , and all the terms, in which it is found, will vanish. Hence the ultimate ratio of the increments is  $nx^{n-1} : 1$ , or  $nx^{n-1}x' : x'$ . If  $n=4$ , then  $x^n=x^4$ , the ratio of the increments is  $4x^3 + 6x^2z + xz^2 + z^3 : 1$ , and the ultimate ratio is  $4x^3 : 1$ , or  $4x^3x' : x'$ . Fluxions illustrate the theory by extension and motion, properties which are singularly adapted to explain the nature of those quantities, to which fluxions are applied, and which, when divested of the consideration of matter, are with propriety introduced into pure mathematics. Thus the two illustrious inventors of this science have each taken tenable ground in their mode of explaining it, and have placed this branch of the mathematics on a foundation which cannot be shaken, and which time will never demolish. Each method has its peculiar excellencies; and if either were wanting, the theory would in some respects, be deficient.

But an illustration of the manner in which fluents are generated, and an explanation of the nature of that relation, which fluxions bear to their fluents, are two distinct things, which ought not to be blended together. Whilst the former is accomplished in a satisfactory manner, the latter remains, in my opinion, unexplained. But some mathematicians have thought differently, and have supposed that the properties of the ratio  $nx^{n-1}x' : x'$  are sufficient to develop the nature of this relation. That this is their view, is manifest from their supposing, that the foundation of fluxions is laid in the tacit acknowledgment, that a circle is a polygon of an infinite number of sides, (Brewster's Encyclopædia, Art. Fluxions.) It was upon this supposition, that Carnot admitted that an error actually arises from the rejection of the quantity, which is the difference between the increment and the fluxion; but that this error in the course of the operation, is compensated by an error of a contrary nature, (Tilloch's Phil. Mag. Vol. 8 and 9.) By thus applying principles, which are insufficient

to explain this part of the theory, they have involved it in a greater obscurity and mystery, than the nature of the subject renders necessary. That the principle of cause and effect in the fluxional calculus, which considers the fluxion as the cause, and the fluent as the effect, does not explain the relation, is manifest from the fact, that the fluxion is not the precise cause. To explain it in a satisfactory manner, it is necessary that we assume neither more, nor less than *the entire cause* for the reasoning proceeds upon the principle, that every effect is proportional to its cause. But the fluxion, which operates at the moment the fluent is completed, is in a great measure different from that, which operated, when the fluent began to be produced. In the constantly varying motion by which the fluent is generated, either some part of the generating cause has gone out of existence, or a congeries of new causes has arisen, which did not operate at the commencement. From this consideration it is manifest, that the theory requires some additional principle to be introduced. That it is not embraced in the supposition, that a fluxion is an elementary part of its fluent, is evident, first, from the consideration that the derivation of the fluent from the fluxion does not depend upon any rules for the summation of a series of elements, as the proposition implies; secondly, the very supposition of the relation of a part to the whole, makes it necessary that the element should be assigned, and if assigned, a small part, being the difference between the increment and the corresponding fluxion, is lost. If any dissatisfaction should arise on this account, a new assignment may be made still nearer to the truth: but yet this is found to make no difference in the final result. This consideration is a sufficient evidence, that no use is made of this elementary part, but the relation of fluxion and fluent depends upon other principles.

In a paper communicated to the Connecticut Academy of Arts and Sciences, and published in Vol. XIV. of the Journal of Science, I attempted to supply a few links in the chain of illustration which I judged to be wanting. It may, perhaps, be thought a fruitless undertaking, to presume to add any thing to the elaborate researches of Newton, Leibnitz, Euler, La Grange, La Place, &c. but when it is considered, that they were urged on by the attractions of a most sublime and beautiful discovery, to make still new advances in the practical part, it need not be thought strange, if they have

left the theory in some parts incomplete. The humbler attempt is all that I aspire at, of clearing away the rubbish, and rendering easy and pleasant to the learner, the entrance to this science, by exhibiting a view of its first principles. That this may be fully accomplished, I shall repeat a part of what was laid down in the before mentioned communication, but somewhat varied in the mode of illustration, and containing a more full statement of this part of the theory. By a series of fluxions, or fluents, is to be understood that in which each term is a multiple, composed of an invariable factor, and one that is variable consisting of one or more terms, with, or without invariable coefficients. Here the invariable factors may be of any assignable magnitudes, provided they differ from each other; but the variable factors must be the same, or of equal value. When the invariable factor is not expressed, it is considered as being unity. It will be found on examination, that a fluxion is equal to a multiple, composed of its corresponding fluent, and the quantity  $\frac{nx^{\cdot}}{x}$ .

From the use which is made of the factor  $x^{\cdot}$  in this quantity, it is obvious, that it may be of any finite magnitude, great or small, that can be assigned. To make use of this equation in explaining the relation under consideration, let  $Bx^n$  and  $ax^n$  be two functions of the variable quantity  $x$ . Their corresponding fluxions  $nBx^{n-1}x^{\cdot}$  and  $nax^{n-1}x^{\cdot}$  may be considered as two terms, selected from a series of fluxions, constructed in conformity with the foregoing definition; which selection may always be so made, that one of the terms shall be the fluxional expression, that occurs in the process. The factors  $B$ , and  $a$  represent the invariable part. The magnitude of the variable part is determined by the limits assigned to the fluents at the time of their production.

Theorem. I. Any two terms, in a series of fluxions, will have their corresponding fluents in the same ratio with themselves.

Theorem. II. Any two terms, in a series of fluents, will have their corresponding fluxions in the same ratio with those fluents.

Hence,  $nBx^{n-1}x^{\cdot} : Bx^n :: nax^{n-1}x^{\cdot} : ax^n$ .

Let the antecedent be represented by  $A$ , the consequent by  $C$ , and the ratio by  $r$ . Then by the definition of a ratio  $\frac{A}{C} = r$ . Any two of these being given the other may be ob-

tained, for  $A=Cr$ , and  $C=\frac{A}{r}$ . These equations being applied to the foregoing proportion, we have  $\frac{A}{C}=r=\frac{nx^r}{x}$ , and  $A=Cr=ax^n \times \frac{nx^r}{x}=nax^{n-1}x^r$ , from whence are derived the rules contained in the direct method of fluxions. Again by multiplying the fluxion by the reciprocal of  $\frac{nx^r}{x}$  we have  $C=\frac{A}{r}=nax^{n-1}x^r \times \frac{x}{nx^r}=ax^n$ . From this equation the rules

belonging to the inverse method are derived. According to the present view of the theory, a fluxion is an artificial proportional quantity of a finite magnitude, and may therefore be subjected to examination; and is so constituted, that, in all its various combinations, it invariably maintains the same relation to its corresponding fluent. Although the fluxional expression, that occurs in a mathematical process, like the straggling boulder in mineralogy, stands alone, and the proportion lies concealed; yet this circumstance does not make it the less real. For the remaining terms, to which the fluxion stands related, can at any time be brought forth, and their places assigned. But, in practice, this is not necessary. The ratio is contained in the fluxional expression, which is supposed to constitute the third term, and can be detached from it; which is done by the rules in the inverse method of fluxions. For they are, in reality, nothing more than dividing the third term of four proportionals, or the fluxion, by the general formula of the ratio  $\frac{nx^r}{x}$ , by which the fourth term, or the fluent, is obtained. A theory of fluxions is here presented to the public, in which the fundamental principles depend on finite elements. The relation of quantities, resulting from the principal of proportion, is already known to be of very extensive application. If the reasoning, on which the present theory rests, shall be judged to be valid, it will bring into view a chain, by which unknown quantities are connected with those which are known to an almost unlimited extent. I have endeavored to give it all the variety of illustration, of which I was capable. A desire of contributing something towards the entertainment of those, who take a deep interest in mathematical researches, has been my motive in entering upon these investigations. And especially, I

have had in view the benefit of those, who have but just entered the threshold of this important and extensive science. Whether I have succeeded in the attempt, is submitted to the decision of those, who are skilled in mathematical pursuits.

ART. X.—*Variation of the Magnetic Needle.*

WE are happy to be able to lay before our readers the following important papers, relating to the variation of the needle. The first is from the "Transactions of the Albany Institute," published in June, 1828. It contains a very interesting document, exhibiting a series of observations on the variation of the needle, made simultaneously at Boston, Falmouth, and Penobscot, during a period of one hundred and twenty eight years, namely, from 1672 to 1800. It is also accompanied by some important remarks, by the Hon. Simeon De Witt; from which it appears that at Albany, and at several other places in the state of New York, the needle has, within a few years, ceased its declination towards the north pole, and has begun to retrograde.

The second paper, by Dr. Bowditch, we borrow from the "Memoirs of the American Academy," for the year 1815. It exhibits a series of observations made at Salem, Mass. during the years 1805, 1808, 1810, and 1811, and contains, interspersed, many valuable remarks, some of which relate to the supposed change of declination in the needle from east to west, as observed in the state of New York.

In the third paper, we insert a few results obtained by our lamented friend, Professor Fisher, from a series of observations instituted during the years 1819 and 1820. These, taken in connexion with those of Dr. Bowditch, indicate that the retrograde movement of the needle, is not general, but that, in this part of the country at least, the needle is still approaching the pole of the earth.

I. *Table of Variations of the Magnetic Needle, copied from one furnished by the late Gen. SCHUYLER to S. DE WITT, Surveyor General.*—Presented 27th April, 1825.

I now present to the Institute, for the purpose of having it preserved, what I consider an interesting document. It is

a Table shewing the changes in the variation of the magnetic needle at Boston, Falmouth and Penobscot, from 1672 to 1800, embracing a period of one hundred and twenty eight years, copied from a paper furnished me by the late General Schuyler. The difference of variation between the two epochs appear to be  $5^{\circ} 53'$ , giving a little more than two and three quarters of a minute for the mean annual variation, or the rate at which the north point of the needle approached the pole from the west, during that period.

As long as I can remember, the surveyors in our country, in retracing old lines, have allowed at the rate of three minutes per year, and acquiesced in the correctness of that rule till the year 1805.

Some time after I settled in Albany, which was in 1785, I established a true meridian, on which I occasionally set a compass for the purpose of observing the variation of the needle; and from these observations I found no reason for departing from the old rule until 1807; when to my surprise I found that a sudden change had taken place in the direction of the needle. And, in order to ascertain its extent, I examined a number of lines, which had been run before. Among others, the courses of the Great Western and Schenectady Turnpike Roads, which in 1805 had been surveyed by Mr. John Randel, junr. then attached to my office. The result was as follows:—

1805, July 30. Great Western Turnpike road,	N. $61^{\circ} 45'$ W.
1807, Sept 4. do.	do. N. $61^{\circ}$ — W.
1805, July 30. Schenectady Turnpike Road.	N. $35^{\circ} 20'$ W.
1807, Sept. 4. do.	do. N. $34^{\circ} 35'$ W.
Making a difference on each of	00° 45'

Shewing that in about two years and a month, the needle had changed, contrary to its former direction of annual variation, about forty-five minutes of a degree. An examination of several other lines confirmed this result.

A view along the meridian, which I had formerly established, having for several years been obstructed by buildings, I made observations, assisted by Mr. Randel, on the 1st, 2d, 3d, and 4th October, 1817, with a good transit instrument, for the purpose of drawing a meridian line across the public square in this city; the particulars of which are contained in the 2d part of the 4th volume of the Transactions of the Society for the Promotion of useful Arts.—The needle was then found to point  $5^{\circ} 44'$  to the west of north. An ob-

ervation made on the 1st August, 1818, shewed it to be  $5^{\circ} 45'$ , and on the 24th of the present month of April, (1825) between 9 and 10, A. M. it was exactly  $6^{\circ} 00'$ ; all which shews that there has been since 1817 a retrograde motion of the needle of about two minutes per year—whether this is general or local, I have not had the means of ascertaining. Mr. Joseph Henry, a member of the Institute, surveyed a farm in the town of Coeymans, not many days ago, which had been run by the late John E. Van Alen, one of the best surveyors of our country, in 1798, and the variation was found to be one degree, as nearly as could be ascertained, in the same way; that is, from the north to the west.

It will be recollected that in 1806, a total eclipse of the sun of uncommon duration, took its range over our country. May I be permitted to escape the charge of advancing in absurdity, in suggesting the *possibility* that the lunar effluvia conveyed to the earth by the rays of the sun, on that occasion, might have had an agency in producing the phenomenon I have described.\* Be that as it may, there appears to be something remarkable in the coincidence of these occurrences.

---

\* In a Memoir which I had the honor of reading before the Institute some time since, on "the Functions of the Moon," which will probably appear in some future publication of our Transactions, I have extended my remarks in relation to the *probability*, that the eclipse of 1806, had an effect on the polarity of the magnetic needle.



Table, exhibiting the variation of the Compass in Boston, and the parts adjacent, from the earliest accounts of it to the end of the 18th century, agreeable to actual observations—By John Winthrop, Esq. Hollis Prof. of Math., at Harvard Coll. in Cambridge.

Yrs.	Variations at Boston.		Variations at Falmouth.		Variations at Penobscot.		Diff. Mean annual diff. between each.
	11° 15'	0° 00'	12° 00'	0° 00'	12° 8'	0° 00'	
1672							00'
78	11.00	.15	11.45	.15	11.53	.15	15
89	10.30	.30	11.15	.30	11.23	.30	30
1700	10.00	.30	10.45	.30	10.53	.30	30
5	9.45	.15	10.31	.14	10.39	.14	14 1-3
10	9.32	.13	10.12	.19	10.25	.14	15 1-3
15	9.18	.14	10.3	.9	10.11	.14	12 1-3
20	9.5	.13	9.50	.13	9.58	.13	13
1725	8.57	.8	9.36	.14	9.44	.14	12
30	8.37	.20	9.22	.14	9.30	.14	16
35	8.23	.14	9.8	.14	9.16	.14	14
1742	8.00	.23	8.45	.23	8.53	.23	23
45	7.56	.4	8.41	.4	8.49	.4	4
1750	7.42	.14	8.27	.14	8.32	.17	15
57	7.20	.22	8.5	.22	8.13	.19	21
61	7.7	.13	7.52	.13	8.00	.13	13
1763	7.00	.7	7.45	.7	7.53	.7	7
70	6.45	.15	7.31	.14	7.39	.14	14 1-3
75	6.32	.13	7.17	.14	7.25	.14	13 2-3
1780	6.18	.14	7.8	.14	7.11	.14	14
85	6.4	.14	6.49	.14	6.57	.14	14
1790	5.50	.14	6.35	.14	6.43	.14	14
95	5.35	.15	6.21	.14	6.29	.14	14 1-3
1800	5.22	.13	6.7	.14	6.15	.14	15 1-3

128 years diff. 5° 53'      5° 53' the same

Mean annual diff. 0° 2'.45".28''' .7'''''.3'''''' or 0.2° 75' 81.25" the same

From 1672 to 1700 the mean annual difference is 2'.67871428 which in 11 1-2 years amounts to 30.45

1700 to 1725 do. is 2.52      28.59

1725 to 1750 do. is 3.      34.30

1750 to 1775 do. is 2.8      32.12

1775 to 1800 do. is 2.8      32.12

Mean of all the periods, 31'.43''.

*II. On the Variation of the Magnetical Needle; by Nathaniel Bowditch, L.L. D.*

The variation or declination of the magnetical needle, in the vicinity of Boston, has decreased since the first observations made in this country, at the rate of a degree in thirty or forty years. For, by the papers published in the first volume of the *Memoirs of the American Academy*, it was  $9^{\circ} 00'$  W in the year 1708;  $8^{\circ} 00'$  W in the year 1742; and about  $7^{\circ}$  W in the year 1782. Within three or four years, it has been mentioned in several periodical publications that the variation had ceased to decrease, and was then rapidly increasing. This was stated to be the case, particularly in New York, by persons, who, from their official situations as public surveyors, were supposed to be most competent to judge of the subject; and observations were adduced to prove that this change had taken place between the years 1804 and 1807. Thus one of the boundary lines of Rensselaer parish in Albany, was found in the year 1800 to bear N.  $46^{\circ} 48'$  W by compass; and in the year 1806, N  $46^{\circ} 12'$  W; the true bearing being N  $51^{\circ} 46'$  W. Whence it was inferred that the variation had increased  $36'$  during that period. In Herkimer in New York the variation was observed in the years 1800, 1804, and 1807: in the first interval of four years it had decreased  $4'$ , and in the last interval of three years had increased  $15'$ . A turnpike road, which was laid out by compass in 1805, had varied in its bearing in 1807,  $45'$ , indicating that the variation had increased by that quantity. These are the chief observations, that I have known to be produced, to prove that a change had taken place in New York; but they by no means warrant the conclusion that has been drawn from them, since no notice whatever is taken of the diurnal variation of the needle, which sometimes exceeds any of the changes that have been observed. For if we examine Professor Sewall's observations in the first volume of the *Memoirs of the American Academy*, we shall find that in an interval of two or three months, in the year 1782, the declination changed at Cambridge from  $6^{\circ} 21'$  W, to  $7^{\circ} 08'$  W, varying  $47'$ ; and I have observed at Salem, in the year 1810, that the declination varied  $48'$  in a short period of time. Either of these diurnal changes exceeds the alteration observed at New York; and as there can be no doubt that the diurnal variation is nearly as

great there as at Cambridge or Salem, it follows that the differences observed in New York are not too great to be accounted for by the diurnal motion alone, without resorting to the hypothesis of an irregular increase in the mean quantity of the variation. It may also be observed that the variation found at the same time and place with different instruments will frequently vary half a degree or a degree; and, by changing the place of the instrument a few feet, the same effect will sometimes be produced. This is more particularly the case in compact places, when the observations are made from the windows or on the top of a building; the nails and other iron used in constructing it, having frequently a great effect on the position of the needle. Notwithstanding the difficulty of obtaining the correct values of the variation, it is of importance to ascertain at regular intervals, as correctly as possible, particularly in this country, where most of the boundary lines of lands are determined by the compass. To assist in this object, I shall here give an abstract of my observations made at Salem in the years 1805, 1808, and 1811.

The observations in the year 1805 were made at a house in Summer Street, Salem, with a theodolite, furnished with a quadrant of altitude, telescope, &c. graduated to minutes. After making the usual adjustments, and fixing as nearly as possible the quadrant of altitude, and the north point of the needle at the commencement of the graduation of their respective circles, I estimated the errors of these last adjustments, and applied them respectively to the observed altitudes and azimuths of the sun, in a similar way to the method of correcting for the index error of an observation made with a quadrant of reflection. To ascertain these index errors to a greater degree of accuracy, I generally took the mean of ten observations of the needle, and three observations of the quadrant, before and after each set of observations. The instrument was placed within the house, at an eastern window in the morning, and at a western in the evening, at the distance of two or three feet from the wall, (or farther when it could be done) in order to avoid as much as possible the effect of the iron in the walls of the building. Having obtained in this way the sun's true altitude and magnetic azimuth, the true azimuth was calculated and the va-

*Variation of the Magnetic Needle.*

riation deduced by the usual rules of spherical trigonometry, The observations were as follows.

1805, Nov.	18d. 9h. 15'	A. M.	4 obs.	5° 58' W.
	4	P. M.	5	6 17
19	9	A. M.	6	6 02
	2	P. M.	6	5 56
21	2	P. M.	10	6 15
23	9	A. M.	9	5 56
	2 30	P. M.	6	5 45
26	2	P. M.	10	5 51
27	9	A. M.	12	5 42
	2	P. M.	10	6 01
28	9	A. M.	10	5 43
	3	P. M.	12	6 06
29	9	A. M.	3	5 50
30	9	A. M.	12	6 01

Mean of 115 obs. 5 57 W.

In the year 1808 at a house in Summer Street about an eighth of a mile south of the place where the above observations were made, I observed the variation with another, more highly finished theodolite furnished with a needle of four inches in length, suspended on an agate. The places where the instrument was fixed, and method of observing, were exactly similar to those before mentioned.

1808, June	27d. 7h. 1'	A. M.	12 obs.	5° 11' W.
	5 45	P. M.	20	5 22
28	6 26	A. M.	20	5 25
29	6 44	A. M.	20	5 08
	6 22	P. M.	20	5 26
July 1	7 34	A. M.	20	5 25

Mean of 112 obs. 5 20 W.

In the year 1810, at a house in the northern part of Market Street, Salem, about a quarter of a mile east of the place of observation in 1805, the variation was observed as above by both theodolites, the results are—

1810, h. d. '		Theodolite used in 1808.					Theodolite used in 1805.	
		o ' "					o ' "	
April 1	4 52 P. M.	20 obs.	5 43 32	W.				
	2 4 39 P. M.	20	5 45 29					
	3 7 54 A. M.	20	5 51 12					
	4 32 P. M.	20	5 40 31					
	4 7 57 A. M.	20	5 48 03		20 obs.	5 24 13	W.	
	4 19 P. M.	20	5 36 34		20	4 57 56		
	8 8 15 P. M.	20	6 08 50		20	5 18 06		
Mean of 140 obs.			5 47 44		60 obs. mean	5 13 25	W.	

The difficulty of ascertaining the precise value of the variation appears evidently from these observations. For at the same moment on the eight of April 1810, with two excellent theodolites in the same place, the variation differed about 50 minutes, which is greater than any of the changes observed in New York. I am induced to believe that these differences arose in a great degree from the shortness of the needles; and, perhaps in part from the imperfection of the brass of which the instruments were made. To obviate these difficulties I procured a needle twenty four inches in length, suspended on an agate, and had it neatly fixed in a mahogany box, moveable at one end on a pivot by which the box was attached to a board, marked with a graduated arch of a circle, subdivided in such manner that minutes of a degree could easily be read by means of a nonius. The box was made wholly of wood and ivory, and when fixed in its place there was no iron near it. A table about three feet in height was fixed in the middle of a room of the building in the north part of Market-Street, and by means of the theodolite and the sun's azimuth, I marked on the table, with great care, a true meridian line and then placed the box on it, and observed the differences between the true and magnetic meridian for every hour, when convenient, from 6 A. M. to 10 P. M. from April 1810, to May 1811. The greatest variation observed during this time was  $6^{\circ} 44'$  W. The least  $5^{\circ} 56'$  W. To ascertain whether the building affected the needle, I fixed a true meridian line on a table in the garden adjoining the house, at thirty feet distance from any building, and nearly five feet from the ground, and by the mean of forty eight observations, I found that the variation in the garden by this instrument was less by  $3' 25''$  than in the house

so that it was necessary to subtract this quantity from all the observations to obtain the true variation. The mean variation for each hour of the day, and for each month of the year, as deduced from these observations, and corrected for the error  $3' 25''$ , are given in the following tables.

Time.	Mean Variation for the month.	Hour.	Mean Variation from April, 1810, to May, 1811.
		6h. A. M.	6° 19' 01'
1810, April,	6° 21' 21"	7	6 19 07
May,	6 23 36	8	6 19 09
June,	6 25 42	9	6 20 28
July,	6 28 51	10	6 21 15
August,	6 29 44	11	6 22 46
September,	6 25 21	12	6 24 07
October,	6 21 42	1 P. M.	6 25 47
November,	6 19 11	2	6 27 09
December,	6 12 35	3	6 27 00
1811, January,	6 20 55	4	6 25 57
February,	6 21 19	5	6 24 26
March,	6 20 29	6	6 23 19
April,	6 23 39	7	6 21 55
May,	6 21 38	8	6 21 11
		9	6 20 54
		10	6 20 38

The whole number of observations was 5125, and the mean of all made the variation  $6^{\circ} 22' 35''$  W, which may be assumed as the mean variation at Salem in the year 1810.

These observations were made about two miles south of the place where the late President Willard observed the variation in August 1781 to be  $7^{\circ} 2'$  W, as may be seen by examining his paper on the subject, in the first volume of the Memoirs of the Academy. The difference of the variation at the two places, at the same time, was probably not more than  $2'$ ; so that from 1781 to 1810, a period of twenty nine years, it had decreased about 38 minutes, or  $1' 19''$  in a year, which is at nearly the usual rate. From which I am inclined to believe, that the variation has not experienced any change in its direction, in this part of the country, and that the needle continues to approach the true meridian with nearly the same velocity as at the time of the earliest observations on record.

The variation observed by Doctor Williams at Rutland, in Vermont, leads to the same result. His observations at that place were

1789 April 17	7° 3' W
1810 May 19	6 4
1811 Sept. 9	6 1

Whence he concludes, that the magnetic variation at Rutland, for twenty two years past, has been decreasing at the annual rate of  $2' 49'' \cdot 5$ .

III. In May, 1819, the late Professor Fisher of Yale College, commenced a series of observations on the declination of the needle, which were continued, from time to time, until April, 1820. The instrument employed was a *variation compass*, which had been recently constructed by a skillful artist, and had all the appendages necessary for the nicest azimuth and altitude observations. From Mr. Fisher's notes, we collect the following results, being the *means* of a great number of trials at different hours of the day.

*Declination of the needle West.*

1819, May,	- - - -	4.° 26'
June,	- - - -	4. 28
July,	- - - -	4. 25
August,	- - - -	4. 22
September,	- - - -	4. 30
December,	- - - -	4. 26. 5
1820, January,	- - - -	4. 25. 5
February,	- - - -	4. 25. 4
March,	- - - -	4. 21. 8
April,	- - - -	4. 24
Mean,	- - - -	<hr/> 4.° 25' 42

*Remark.*—It appears from the foregoing observations, that the declination of the needle at New Haven, in the years 1819 and 1820, was less than had been observed at either of the places mentioned in the first of the above articles. The least declination given by the Hon. Mr. De Witt, was in August 1818, and amounted to  $5^{\circ} 45'$ , which is about  $1^{\circ} 20'$  greater than the mean of the observations of Professor Fisher.

ART. XI.—*Meteorological Report for the year 1828*; by  
DENISON OLMSTED, Professor of Mathematics and Natural  
Philosophy in Yale College.

From the papers of the Connecticut Academy of Arts and Sciences.

At the close of the year 1827, I laid before the Academy an abstract of our Meteorological Register, for that year,\* intimating at the same time a hope and expectation that similar reports would be made from year to year, until we should obtain a series of observations sufficiently extensive, to enable us to ascertain the true character of our climate. In accordance with such a plan, I beg leave now to present to the Academy, the meteorological results obtained during the year 1828, comparing them occasionally with the corresponding observations of the preceding year.

TABLE I.—*Shewing the mean Maximum and Minimum of the Thermometer for every month in the year, with the corresponding states of the Barometer.*

MONTHS.	THERMOMETER.				BAROMETER.			
	1827.		1828.		1827.		1828.	
	Min.	Max.	Min.	Max.	Morn.	Eve.	Morn.	Eve.
January,	17.00	28.93	28.88	38.31	30.04	29.98	30.14	30.12
February,	25.90	35.30	33.36	46.50	30.03	29.98	29.84	29.81
March,	32.00	43.30	32.64	47.00	30 07	30.00	29.94	29.93
April,	42.50	57.00	36.37	53.70	29.96	29.93	29.81	29.80
May,	46.40	64.45	50.37	67.46	29.82	29.83	29.80	29.80
June,	56.23	73.80	62.20	80.07	30.09	30.08	29.80	29.76
July,	62.84	77.06	64.51	79.90	30.10	30.11	29.63	29.62
August,	61.10	75.72	63.11	82.42	30.11	30.11	29.80	29.79
September,	57.23	70.46	56.00	72.00	30.11	30.11	29.80	29.79
October,	51.64	60.93	42.50	57.60	30.03	30.00	29.81	29.79
November,	32.25	40.66	39.31	49.26	29.95	29.92	29.68	29.68
December,	31.30	39.00	31.66	45.20	30.18	30.16	29.81	29.74
Mean,	43.03	55.55	45.06	59.95	30 04	30.01	29.82	29.80

NOTE.—For the year 1827, the observations taken at sun rise and at 2 P. M. are assumed as the minima and maxima; for 1828, a more correct maximum has been obtained by varying the hour of observation in the afternoon from 2 to 3 o'clock, at different seasons of the year.

REMARKS.—I. THE THERMOMETER.

1. Mean temperature of the year, as deduced from the foregoing table,	1827.	1828.
	49.29	52.50
Mean minimum for the year,	43.03	45.06
Mean maximum, “ “	55.55	59.95

\* See Vol. XIV, p. 176 of this Journal.



2. For the several seasons.

Mean temperature of Dec. Jan. and Feb.	28.66	37.32
Ditto of March, April and May,	46.70	48.92
Ditto of June, July and Aug.	62.65	72.03
Ditto of Sept. Oct. and Nov.	51.53	52.78

It appears, therefore, that the year 1828 has been throughout warmer than the year 1827, in the ratio of 52.50 to 49.29, and that the winter months of 1828 give a mean about 9° and the summer months about 10° higher than the corresponding seasons of 1827, while the vernal and autumnal months have been more nearly equal. Probably so high an annual mean temperature as 52½° has rarely occurred at this place.

The highest temperature of the year 1828 is 90°, which degree has been marked at four different times, namely, once in July, twice in August, and on the first day of September.

The lowest degree of cold observed this year, is 6 degrees above zero; and this has occurred but twice, namely, on the 12th and the 24th of January; while the minimum for February was 14°, for March 13°, and for December (the last day of the year) 10°. Hence, the *annual range* has been only 84°, whereas in 1827 it was 100° extending from -7 to 93.

July and August were the hottest months, and were nearly equal in temperature, each having a mean of about 72°. The hottest month of 1827 was July, its mean being 69°.

The coldest month was, as usual, January, but its average temperature was 33½°, being 11½° higher than January, 1827.

The greatest monthly range, occurred this year, as it did last, in March, and amounted to 56°; the mercury having, on the 28th of the month, reached the unusual height of 69°, while on the 1st, the minimum was only 13°. In 1827, the greatest monthly range was 49°.

## II. THE BAROMETER.

	1827.	1828.
Mean height for the year,	- - 30.03	29.81
The observations of morning and evening afford, as they did last year, almost the same result, that of the morning, being,	- - - - -	29.82
and that of the evening,	- - - - -	29.80
For the <i>winter</i> months,	- - - - -	29.91
For the <i>spring</i> do.	- - - - -	29.85
For the <i>summer</i> do.	- - - - -	29.73
For the <i>autumnal</i> do.	- - - - -	29.75

Several important inferences are to be drawn from the foregoing facts. First, that the barometer has, during the past year, been remarkably low, the annual mean being to that of 1827, only as 29.81 to 30.03; secondly, that the different seasons of the year have varied much from each other, the difference between the winter and the summer months being .18, while in 1827 it was only .03; and, thirdly, that the mean for the summer is the lowest, being only 29.73, while in 1827, it was the highest, being 30.09, that is, higher by .36 of an inch.

The greatest height of the barometer occurred in January, and was 30.62. During the month of July, the maximum was only 29.86, and the mean only 29.62; and during the succeeding months, quite to the end of the year, the mercury but a few times reached the height of 30 inches.

The *minimum* for the year, is 28.96. It occurred on the night of the 22d of November, and was accompanied by high wind and violent rain. In our climate, the barometer seldom falls below 29 inches. The minimum of 1827 was 29.02. The range of the barometer for the two years is nearly the same, and is in both very limited, being only a little more than 1½ inches.

### III. WINDS.

Comprehending all the winds except those which blow either directly from the east or the west under the heads of northerly and southerly, we arrive at the following result.

TABLE II.

Months.	Northerly.	Southerly.
January, - - - -	27	12
February, - - - -	17	16
March, - - - -	26	10
April, - - - -	24	10
May, - - - -	15	16
June, - - - -	10	19
July, - - - -	14	14
August, - - - -	14	18
September, - - - -	24	14
October, - - - -	25	9
November, - - - -	19	8
December, - - - -	20	16
Ratio, - - - -	59.3	40.7

REMARKS.

1. Northerly winds have been more prevalent than southerly, in the ratio of about 60 to 40. In 1827, the ratio was nearly that of 70 to 30, shewing an increase of southerly winds during the past year of 10 per cent. From May to August, inclusive, southerly winds predominated.

2. In certain parts of the year, the winds have been unusually variable. During the month of July, the wind remained stationary scarcely half a day at a time.

3. Whenever the wind has proceeded directly from the east for a few hours together, it has been accompanied, or immediately followed, by fogs, clouds and rain. Northwest winds, have, as usual, generally brought us fair weather; and when snow storms have occurred, as several have done, with the wind at northwest, they have, invariably, been of short continuance.

IV. WEATHER.

TABLE III.—Shewing the ratios of the different kinds of weather, which prevailed at the time of taking the daily observations.

MONTHS.	Clear.	Broken.	Cloudy	Stormy.
January, - - - -	9	13	9	12
February, - - - -	12	10	7	9
March, - - - -	13	10	10	5
April, - - - -	16	6	7	5
May, - - - -	15	5	10	9
June, - - - -	13	7	4	8
July, - - - -	16	6	5	11
August, - - - -	23	4	1	1
September, - - - -	16	2	7	10
October, - - - -	22	3	4	5
November, - - - -	8	6	11	12
December, - - - -	24	4	2	3
	187	76	77	90

NOTE.—By *broken*, is to be understood partly clear and partly cloudy; and under the head of *stormy*, are included all those days on which there fell rain, hail, or snow.

REMARKS.

Clear days in 1828, 55 per cent.	In 1827, 48 per cent.
Cloudy in part, 22	30
Cloudy entire, 23	22
Falling weather, 27	28

Hence it appears, that the year 1828 has been distinguished for a large proportion of serene weather, the fair days, including all in which the clear sky was seen, having amounted to about three fourths of the whole.

## V. RAIN, &amp;c.

January and February,	2.74 inches.	Winter months,	3.94
March,	3.10	} do.	Spring do.
April,	2.30		
May,	6.01	} do.	Summer do.
June,	3.70		
July,	11.10	} do.	Fall do.
August,	0.50		
September,	8.90	} do.	17.20
October,	1.40		
November,	6.90		
December,	1.20		
Amount,	47.85		

The average fall of rain at this place for a great number of years, has been 44 inches. During the year 1827 the amount was, however, 51.38 inches, and for the present year it appears that the amount is greater than the mean by nearly 4 inches. By inspecting the foregoing table, it also appears that the greater part of this, namely  $32\frac{1}{2}$  inches fell during the summer and fall months, while the winter months were comparatively dry.

## VI. REVIEW OF THE INDIVIDUAL MONTHS.

The first part of the year 1828 was distinguished throughout most parts of our country, for uncommon mildness. According to the Philadelphia National Gazette, the first week in January, passed in that city without frost; and accounts from the States farther south represented the months of December, and January, as having been very remarkable for warm weather. Green peas were gathered in January, as far north as Newburn in North-Carolina; and at Charleston, in South-Carolina, watermelons and strawberries ripened in January, and the fruit trees were in full bloom. A writer from St. Francisville Lou. on the 8th of January represented himself as suffering much inconvenience from

the heat,—that the perspiration was starting from every pore, and that a pestilential disease was beginning to spread its ravages through the country. Great apprehensions were entertained throughout the southern country, that so warm a winter, would be followed by a sickly summer, and autumn. Such, however, as far as we have learned, was not the fact.

At this place, small quantities of snow fell at several times during the month of January, but not enough for sleighing—indeed sleighs were hardly seen abroad during the winter.

The average minimum temperature of this month was no lower than about 29 degrees, or 3 degrees below the freezing point; and its average maximum was as high as nearly  $38\frac{1}{2}$  degrees, the mean being  $33\frac{1}{2}$  degrees, that is,  $1\frac{1}{2}$  degrees above the freezing point of water. So high a mean for January has rarely if ever occurred here. The mean for January 1827, was only 22 degrees. The highest temperature recorded during the month was 53 degrees, approaching a summer heat.

February also enjoyed the mild temperature of May, resembling the pleasantest winter months of the Carolinas. Its average temperature was about 40, which was 10 degrees above that of February 1827. In one instance, on the 10th, the thermometer rose to 60; and owing to the influence of southerly winds, rendering the atmosphere humid, the season appeared even warmer to the senses than was indicated by the state of the mercury. The vegetable kingdom began to give tokens of anticipating its vernal functions. On the first of the month, the lilacs were budding out; on the twentieth, the gooseberry was putting forth leaves; and at the same time, the operations of gardening were commenced. Among the anomalies of the season may be mentioned the fact, that violent thunder storms occurred in various places. On the 2nd. of February, a house was struck with lightning in Ontario County, in the State of New York, and much damaged. The blue bird, one of our early harbingers of spring, was first observed on the 17th.

March had nearly the same average temperature as February, although in one instance, (the 23th) the thermometer rose to 69 degrees. Snow occurred in two or three instances, but it remained only a short time; and although the ground had remained during the greater part of winter, destitute of this warm covering, yet on account of the extra-

ordinary mildness of the air, it had been generally free from frost, the grass had remained almost uniformly green, nor had grain and other green vegetables sustained the injuries which usually result from open winters. The 28th of March (the time already mentioned when the thermometer was at 69) was welcomed by the frogs, by a concert unusually merry for the season.

Notwithstanding the uncommon warmth of the winter in this state, and in the states south of us, yet according to the public papers, the same period was distinguished at certain places north of us, for unusually cold weather. The winter was reported to have been very severe in Nova Scotia and at Detroit; and, at Green Bay on the 4th of March, the mercury was 10°degrees below zero. In April, though the weather was mild, yet the progress of vegetation was retarded by cool nights. Peach trees began to blossom on the 20th, which was no earlier than the same fact was observed in 1827. On the 7th and 8th of this month, the frost returned with some severity throughout the southern states. At Georgetown in South Carolina, the ice was an inch thick although on account of the unusual mildness of the preceding months, summer fruits were in great forwardness, and blackberries were fully ripe.

Early in May our fruit trees were in blossom and gave indications of unusual abundance,—a promise which was not very well fulfilled. The spots on the sun, which have appeared in extraordinary numbers, the greater part of the year, were particularly remarkable during this month. On the 22nd, the telescope with a power of 40, revealed eleven spots on the solar disk, consisting chiefly of clusters. One of the spots was very large and was surrounded by an extensive penumbra. About six inches of rain fell this month; and descending chiefly in showers, it contributed to bring vegetation to a state of great perfection, and our city\* was perhaps never more verdant than in this and the following month. About the 20th of June, commenced a period of uncommonly wet and sultry weather, which lasted until August. A little previous to this time, the hopes of the husbandman were highly elated by the prospect of most abundant crops of grass and grain; but the continual rains which succeeded, prevented his securing either, without great dam-

---

\* Having large public squares, and numerous forest and fruit trees and gardens.—*Ed.*

age. The amount of rain that fell in July was the unexampled quantity of  $11\frac{1}{10}$  inches. This was accompanied by many violent thunder-storms; and the injury done by lightning in different parts of United States, was much greater than ordinary. In the course of this month, two dwelling houses were struck by lightning, in the city, both of which were furnished with lightning rods. Indeed, one of them, (the Tontine Coffee house,) was supplied with no less than four conductors. Still there was nothing in either of these cases, to shake our confidence in the efficacy of lightning rods, when constructed and attached to buildings, according to established rules. The case of the Tontine, demonstrated the necessity of affording special protection to the kitchen chimney, since this is the only chimney in which a fire is usually kept during summer; and it is well known that watery vapour, soot, and the various mixed products of combustion are, to a certain extent, conductors of electricity, and expose the chimney from which they are ascending to peculiar danger. In the present case, the chimney to which the nearest conductor was attached, was distant 34 feet, and therefore too remote to enable the rod to protect the chimney at which the lightning descended, attracted as it was by the cloud of smoke that was rising from a large fire in the kitchen. With regard also to the other house that was struck by lightning, although the electricity first lighted upon the conductor, which seemed therefore rather to have invited the destructive element to enter the building, than to have acted the guardian, yet on examining the rod, it was found to have been very badly constructed—its different parts were loosely linked together, the whole surface was much corroded, it was so nearly broken in one place, as merely to hang by a thread, and it descended into the ground, only about 18 inches. Accordingly, as soon as the conductor had received the feeble charge of which it was susceptible, the residue of the fluid ran off by way of the large timbers, and through the cellar wall of the house, and left traces of its violence, in the different apartments. One of the most singular occurrences was, that a lady sitting in a chamber, on the side of the house, opposite to that where the lightning entered, had her shoe rent on her foot, without sustaining the least injury to her person. The month of August, was very hot, the thermometer having twice reached 90 degrees, and the average maximum, being about 82 degrees.

September was ushered in by a most violent storm of rain. The rapid descent of the barometer, on the first day of the month, indicated an approaching storm, and during the following night it began to rain, and by the morning of the 5th when it ceased, nearly eight inches had fallen, the greater part of which fell during the preceding night, and produced a sudden and destructive inundation.

October was distinguished for fine weather, and the atmosphere being washed by copious showers, exhibited at times, something of the transparency, and deep azure hue, that are so celebrated in the climate of Italy. For several days in the earlier parts of the month, the planet Venus was visible at mid-day. On one occasion being nearly in conjunction with the new moon, the appearance which these planets exhibited through the day, was particularly striking.

The months of November and December, have been also, for the most part, uncommonly warm and pleasant. The barometer has been unusually low, the mean for November, being only 29.68 inches, and for December, only 29.77 inches. In one instance namely, on the night of the 23d of November, it reached the minimum for the year, as has been already noticed.

ART. XII.—*On the variations of level in the great North American Lakes, with documents; communicated for this Journal, by Gen. H. A. S. DEARBORN.*

Brinley Place, Roxbury, Jan. 9, 1829.

TO THE EDITOR.

*Dear Sir*—At an interview with Maj. Samuel A. Storrow, late a judge advocate in the army, in the year 1817, he informed me, that he had observed fluctuations in the waters of Lakes Ontario and Michigan, resembling tides; and that he had alluded to them, in the report of a tour which he had performed, in the north western regions, under the direction of Gen. Brown.

This phenomenon appears to have attracted the attention of Fra. Marguette in 1673, of Baron Hontan in 1689, of Charlevoix in 1721, of Capt. Whiting in 1819, and of Henry R. Schoolcraft, Esq. who accompanied Gov. Cass, in his expedition through the lakes to the Mississippi, during the year



1820. But none of the last named travellers, appear to have noticed a similar flux and reflux of the water, in any of the lakes, except that of Michigan; and have generally expressed opinions, from the limited data which they had obtained, that the effect was produced chiefly, if not entirely, by the winds, rather than by the influences of the moon and sun.

In the autumn of 1826, Capt. Greenleaf Dearborn of the army, informed me, that he had observed a like, but more marked ebb and flow of the waters, in Lake Superior. He had been stationed, for two years, at the Sault de St. Marie, and gave such indisputable evidence, of the existence of a great and regular tide in that immense lake, that I became deeply interested in the subject, and determined to institute an inquiry, which, I was in hopes, would have resulted in the acquisition of more particular and extensive information; and as I had often heard it remarked, that there was a rise and fall of the water, of two or three feet, in some of the great lakes, during periods of from three to seven years, I endeavored, at the same time, to obtain positive data as to this current report. At the close of the year 1826, and early in 1827, letters were written to several gentlemen, who I presumed might furnish the results of their own observations, or of others who had resided on the borders of the lakes, and with whom they had been in habits of intimacy. Very interesting answers were kindly returned to the queries submitted, by Maj. Storrow, Doct. Lovell, surgeon general of the army, and Captains Whiting and Dearborn, but so few and limited have been the attempts, to ascertain the character, extent and periods of the fluctuations of the level of the water, in any of the lakes, that theoretical speculations, as to the cause, would be premature; and I have concluded, that I could not better subserve the interests of science, than by transmitting to you, for publication in the *American Journal*, such information as I had procured, as it may tend to excite investigation, and superinduce more numerous, accurate and continued observations, than have hitherto been made, for the solution of this problem.

It is not sufficiently certain, that tides may not be produced in the great chain of lakes, in the same manner they are in the ocean. The following theory of the distinguished Doct. Young, which has been sanctioned by the scientific, for more than twenty years, not only presumes the possible existence of such tides, but furnishes the means of demonstrating that such is the fact, in deep and broad lakes.

“If the earth were wholly fluid, and the same part of its surface were always turned towards the moon, the pole of the spheroid being immediately under the moon, the lunar tide would remain stationary, the greatest elevation being at the points nearest to the moon and furthest from her, and the greatest depression in the circle equally distant from these points; the elevation being, however, on account of the smaller surface to which it is confined, twice as great as the depression. The actual height of this elevation, would probably be about forty inches, and the depression twenty, making together a tide of five feet. If also the waters were capable of assuming, instantly, such a form as the equilibrium would require, the summit of a spheroid equally elevated would still be directed towards the moon, notwithstanding the earth’s rotation. This may be called *the primitive tide of the ocean*: but on account of the perpetual change of place, which is required for the accommodation of the surface, to a similar position with respect to the moon, as the earth revolves, the form must be materially different, from that of such a spheroid of equilibrium. The force employed, in producing this accommodation, may be estimated, by considering the actual surface of the sea, as that of *a wave, moving on the spheroid of equilibrium*, and producing in the water, a sufficient velocity, to preserve the actual form. We may deduce, from this mode of considering the subject, *a theory of the tides*, which appears to be more simple and satisfactory, than any which has yet been published: and by comparing the tides of narrow seas and *lakes*, with *the motions of pendulums, suspended on vibrating centres*, we may extend the theory to all possible cases.”

“If the centre of a pendulum be made to vibrate, the vibrations of the pendulum itself, when they have arrived at a state of permanence, will be performed in the same time with those of the centre; but the motion of the pendulum will be either in the same direction with that of the centre, or in a contrary direction, accordingly as the time of this forced vibration is longer or shorter, than that of the natural vibration of the pendulum; and in the same manner it may be shown that the tides either of an open ocean, or of *a confined lake*, may be either *direct* or *inverted*, with respect to the primitive tide, which would be produced, if the waters always assumed the form of the spheroid of equilibrium, according to the depth of the ocean, and to *the breadth as well*

as depth of the lake. In the case of a *direct tide*, the time of the passage of the luminary over the meridian must coincide with that of *high water*, and in the case of an *inverted tide*, with that of *low water*.

“In order that the height of the inverted or remote lunar tides may be five feet, or equal to that of the *primitive tides*, the depth of the open sea must be six and a half miles; and and if the height is only two feet, which is perhaps not far from the truth, the depth must be three and five-seventh miles.

“*The tides of a lake*, or narrow sea, differ, materially, from those of the open ocean, since the height of the water scarcely undergoes any variation, *in the middle of the lake*; it must always be *high water* at the *eastern extremity*, when it is *low water* at the *western*: and this must happen at the time, when the places of high and low water, with respect to the primitive tides, are equally distant from the middle of the lake. [Figs. 1. 2. and 3. from Plate 38.]

“The tides may be *direct*, *in a lake*, one hundred fathoms deep, and less than  $8^\circ$  wide; but if it be much wider, they must be *inverted*.

“Hitherto we have considered the motion of the water as free from all resistance; but where the tides are direct, they must be retarded by the effect of a resistance of any kind; and where they are inverted, they must be accelerated; a small resistance producing, in both cases, a considerable difference in the time of high water.”—*Young's Natural Philosophy*, Vol. I. p. 578.

Fig. 1.



Fig. 1. “The dotted ellipsis shows the section of a spheroid, which would be the form of the earth and sea, if it were always in a state of equilibrium, with the attraction of a distant body; and the dark ellipsis, the actual form assumed, in consequence of its rotation round its centre, the depth of the sea being less than thirteen miles.”

Fig. 2. "The surface of the sphere being supposed to be flattened, and the tides spread on it, they would assume the form of the waves here shown. The dotted straight line shows the mean height, which is a little above the surface in the principal sections of the spheroid, although not universally."

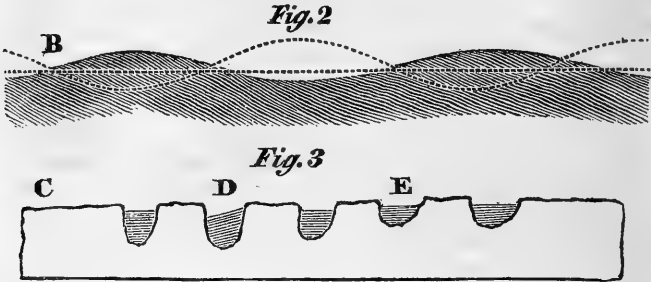

Fig. 3. "The nature of the tides of lakes, the surface being regulated by that of the dotted line in Fig. 2. nearly agreeing with it in direction, as at D, when the lake is narrow and deep; but differing from it, as at E, when shallow." —Young's *Natural Philosophy*, Vol. I. p. 793.

The area and depth of a lake being known, Doct. Young has given a theorem, in the second volume, of his Lectures, page 343, by which the maximum rise and fall of the water, and the time of each oscillation, or in which a tide-wave might pass over it, can be ascertained.

The same causes may operate to elevate the tide in narrow parts of lakes, above the level of that, theoretically deduced for, or actually indicated in, their most expanded portions, as in the gulfs, bays, straits and mouths of rivers connected with the ocean; and it may also be increased, or diminished, by the effect of the winds. Thus a very small tide, of only a few inches, on the margins of the lake, at the points of its greatest breadth and profundity, may be swelled into one of some feet, in the narrow channels of estuaries, and the prolonged indentations of the coast; for although "the primitive tide" is only five feet, and upon the shores of the broad and deep ocean rarely exceeding, from extraneous causes, ten; still, when it is impeded in its course, or enters gulfs, which plunge far into the land, with diminishing extremities, it rises to the height of forty, fifty and even an hun-

dred feet—as at Chepstow on the Severn, at St. Malo on the coast of France, and at Annapolis in the Bay of Fundy.

To obtain full and exact data as to the rise and fall of the water in Lakes Ontario, Erie, Huron, Michigan, and Superior, it is requisite that nilometers should be placed at a number of points, on the shores of each, both in their narrowest and broadest dimensions, and the changes carefully observed, during a whole year, or at least, for several months; and accurate tables kept, of the times and extent of each flux and reflux, in which, the position, as respects the meridian, and the phases of the moon, and also the course of the winds should be noted. This could be most conveniently done by the gentlemen of the army, who are stationed at the various military posts, situated on the lakes. To them we are indebted for nearly all the information, we possess on this interesting subject; and it is desirable, that they should merit, still higher distinction, and gratitude, by furnishing an ample supply of facts, on all the objects connected with, and calculated to illustrate a phenomenon, so little known, and so imperfectly explained.

As to the periodical increase and diminution of the whole volume of water in the lakes, I am not in possession of any definite facts, save those contained in Capt. Dearborn's letter, and in the following extract from the New York Mercantile Advertiser.

“A gentleman, just returned from a tour to the west, informed the editor, that the waters of Lakes Ontario, and Erie, are, at present, nearly two feet higher, whilst those of Lake Superior, are considerably lower, than ever before known.”

*Extract from a printed report, made to Maj. Gen. Brown, commander in chief of the army, of a tour, from Detroit, through Lakes Huron and Michigan, a portion of the North West and Michigan Territories, during the year 1817, by Maj. Samuel A. Storrow, late judge advocate.*

“While at Green Bay I made observations on the ebb and flow of a lake tide. The existence of this phenomenon has been known for nearly a century and a half,\* and yet has occasioned no thought nor investigation. Even Volney has allowed it to pass without a theory! At eleven o'clock,

---

\* Fra, Marguette mentions this tide in 1673.

A. M. I placed a stick perpendicularly in the water ; at half past nine P. M. the water had risen five inches ; at eight the next morning it had fallen seven inches ; at eight of the same evening it had risen eight inches. During this period the wind was in the same direction, blowing gently against the flow of the tide.”—page 18.

*Extract from Schoolcraft's narrative of the expedition under Gov. Cass in 1820.*

“ The junction of this river [Fox,] with Green Bay, affords one of the most favorable positions for witnessing a phenomenon, which has attracted the attention of travellers from the earliest times, without, however, having, as yet, elicited any very satisfactory explication of an apparently reversed order of nature. I allude to the appearances of a regular tide at this place, but in so doing it is more with the view of presenting an outline of those facts, which have been observed by others, than of entering into any disquisition on the subject myself.

“ In the year 1689, the Baron La Hontan, on reaching Green Bay, remarks, that where the Fox river is discharged into the Bay, he observed the water of the lake swell three feet high, in the space of twenty-four hours, and decrease as much in the same length of time. He also noticed a contrariety, and conflict of currents in the narrow strait which connects Lakes Huron and Michigan which” he says, “ are so strong, that they sometimes suck in the fishing néts, although they are two or three leagues off. In some seasons, it so falls out, that the currents run three days eastward—two days to the west—one to the south—and four to the northward ; sometimes more and sometimes less. The cause of this diversity of currents could never be fathomed, for in a calm, they will run in the space of one day, to all points of the compass, without any limitation of time, so that the decision of this matter must be left to the disciples of Copernicus.”\*

“ In 1721, Charlevoix remarks similar appearances, but treats the subject with unusual brevity, evidently, from the difficulties which occurred to him, in giving any satisfactory explanation. He supposes Lakes Huron and Michigan to be alternately discharged into each other through the strait

---

\* La Hontan's voyages to Canada.

of Michilimackinac, and mentions the fact, that in passing that strait, his canoe was carried with the current *against a head wind.*" In another place, in speaking of an apparent flux and reflux of the lakes, he supposes that it was "owing to the springs at the bottom of the lakes, and to the shock of their currents, with those of the rivers, which fall into them from all sides, and thus produce, those intermitting motions."\*

"In 1819, Capt. Henry Whiting, of the United States army, made a series of observation during seven or eight days, upon these oceanic appearances, which serve to shew, that the water at Green Bay, has a rise and fall daily, but that it is irregular as to the precise period of flux and reflux, and also as to the height it attains.

"On reaching Green Bay, during the present expedition, Gov. Cass, directed one of the men, to drive a stake at the waters edge, upon the bank of Fox river, at the spot of our encampment, which was a mile above its discharge into the bay, and to mark the height of the water. It appeared from frequently inspecting this gauge, during the period of our stay, which was, however, but two days, that there was a considerable rise and fall of the water—that there was a difference as to the time consumed in passing from its minimum to its maximum height, and that although it arose against a strong wind blowing out of the river, the rise, under these circumstances was less, than in ordinary cases.

"From all these circumstances there is reason to conclude, that a well conducted series of experiments, will prove, that there are no regular tides in the lakes, at least, that they do not ebb and flow twice in twenty-four hours, like those of the ocean—the oscillating motion of the waters is not attributable to planetary attraction—that it is very variable as to the periods of its flux and reflux, depending upon the levels of the several lakes, their length, depth, direction, and conformation—upon the prevalent winds and temperatures, and upon other extraneous causes, which are in some measure variable in their nature, and unsteady in their operation.

"Lake Michigan, from its great depth of water—its bleak and unguarded shores—and its singular length and direction, which is about four hundred miles from north to south, appears, to be peculiarly exposed to the influence of the cur-

---

\* Charlevoix's Journal, Vol. I. p. 314.

rents of the atmosphere, to whose agency we may attribute, at least in part, the appearances of a tide, which are more striking upon the shores of this, than of any of the other great lakes. The meteorological observations which have been made in the Trans Alleghanian States, indicate the winds to prevail, either north or south, through the valley of the Mississippi; but seldom across it, so that the surface of this lake, would be constantly exposed to agitation from the atmosphere. These winds would almost incessantly operate, to drive the waters through the narrow strait of Michilimackinac, either into Lake Huron or Lake Michigan, until, by their natural tendency to an equilibrium, the waters thus pent, would re-act, often attaining a certain height, against, the current of the most powerful winds, and thus keep up an alternate flux and reflux, which would always appear more sensibly in the extremities and bays of the two lakes; and with something like regularity, as to the periods of oscillation; the velocity of the water, however, being governed by the varying degrees of the force of the winds."—pp. 373—376.

*Letter from Maj. S. A. Storrow.*

Farley, Virginia, Feb. 10, 1827.

*My dear Sir*—An absence of more than three weeks prevented the previous receipt and acknowledgment of your favor, which reached my residence at an early part of the last month.

Respecting the subject of your letter—the ebb and flow of a tide in the great lakes, I regret that accident has prevented me from giving any information, beyond a vague and uncertain remembrance. I made a series of experiments, embracing the following points; the mouth of the Black river near the outlet of Lake Ontario, Fort Gratiot at the outlet of Lake Huron, the island of Michilimackinac, Fort Howard on Green Bay, and Fort Dearborn on the Chicago. The notes and memoranda of these experiments, I was so unfortunate as to lose. On returning from the region of the upper lakes, I was separated from my baggage, of which the notes formed a part. Shortly after they were restored to me, and before I had time to transcribe them, the port-folio that contained them was destroyed by fire. I thus lost them forever. I can therefore give you nothing sufficiently definite



for a place among your data. The slight information conveyed in the conversation to which you refer, and in the narrative in your possession, was furnished by memory. At the present moment, as far as that extends to observations made at so distant a period, it tells me, that each time and place of making the experiment, illustrated the fact in its general outline, without giving it the distinctness and uniformity I sought; and without separating it from certain proximate agents, whereby the same result might have been produced by more obvious and sensible causes.

At two of these places, the Black River and Fort Howard, large rivers disembogue themselves, and at another, Fort Gratiot, a lake. They seem to present the fairest points for experiment. If in such places there appear occasional elevations and depressions of the water, or alternate accelerations and retardations of the stream, the pressure from above would seem to be resisted by a new agent, and an inward current imperviable at once. I know nothing of a variation of the force of the stream, on its outward passage; but a periodical difference in the altitude of the water was, at the time and places of my experiments indisputable. I placed and removed the graduated rod with my own hand; and at stated periods noticed the rise and fall, of which a clear and determinate impress is left upon my memory.

But at the time of making these experiments, two subordinate circumstances presented themselves; the one of them, the wind, the action of which might have forced in or out of the mouths of the rivers a greater or less quantity of water, and that accounted for the difference in its elevation. The other, the force of the current, or the bulk of the water, which might have been increased, or diminished by the difference, between the daily and nightly discharges of the fountains, which afford a supply from above. If the quantity poured forth at one period was greater than at another, the volume itself accounted for the occasional elevation. If the actual increase of the element was not proportioned to the apparent increase of its bulk, still the impulse given to the current, in the centre, by the increase of force from above, might create an increase of counter-current at the margin, and force the water higher up. These are the possible causes to which I have just referred. If any weight be attached to them, and I know not that they are worthy of any, the rise and fall of the water may be accounted for, without the

inference of an inward current. I glanced at them, at the time, merely from a desire to explore all causes that might be at hand. The first suggested itself from finding, as I slowly coasted the southern shore of Green Bay, a breeze to arise, with great regularity, at a certain hour of the morning, and blow gently from the land. My notes contained exact mention of hours, at which the elevation or depression was manifest, and the state and variation of the wind. I have never ceased to regret that it was not in my power to examine and collate them.

The positions of Michilimackinac and Fort Dearborn, render them less subject to the circumstances just mentioned. A small and sluggish stream empties itself at the latter, but I made the experiment at a distance from the mouth of it, upon the margin of the broad lake. I do not precisely remember the result of the trial made at either place. They corroborated those made elsewhere, but, if my recollection serves me, the fact was less distinctly marked.

You refer to Charlevoix and La Hontan. I think the existence of such a tide is referred to by Fra. Marguette in 1673.

It has suggested itself to me while writing, that some of the medical officers, stationed upon the north western frontier, may have made observations upon this phenomenon, and communicated them, with other scientific matter to the head of their Department, our medical friend Lovell. I will make the inquiry of him, and beg that he communicate with you.

*Letter from Doct. Joseph Lovell, Surgeon General in the Army of the United States.*

Washington, April 2d, 1827.

*My dear Sir*—At the request of Mr. Storrow, I enclose you the only document I can find relative to the supposed tides in the upper lakes. It is an extract from a journal of Capt. Whiting of the army. Several others have noticed the same thing at Fort Howard, though they have differed, both as to the height of the rise, and its frequency. Capt. Smith informs me that while he was there the variation never exceeded six inches. I cannot learn that it has been observed at any other place. The general belief of those with whom I have conversed is, that the change is produced by the winds acting on the waters of Lakes Michigan and Hu-

ron, in consequence of the situation of Green Bay, in relation to the former lake. And this appears probable from several circumstances. For in a very short time a considerable rise is produced from this cause, even in the smaller lakes. Thus the day that the second expedition under Maj. Long, arrived at the southern extremity of Lake Winnepeck, the water rose in a few hours to the height of nearly three feet in the Bay, on which the fort is situated.—Vol. II. p. 85—86.

It is also stated that since the erection of the pier at Erie, Penn. by which the entrance of the harbour is rendered narrow and deep, a wind from the opposite shore causes a strong current through this entrance and a proportional rise within the harbour. In the same manner, in consequence of the west and south west wind, which, agreeably to the journal of Capt. Whiting, prevailed on the 4th of June, the water was driven out of the Bay, and continued low at Fort Howard until near 7. P. M. By this time, a very considerable rise had taken place at the western extremity of Lake Michigan, and the water was of course forced rapidly through the entrance of the Bay, at its north western part, the effect of which would be more sensible at the narrow point, at its head, where the fort is situated. In the same manner a long continued east wind would drive the waters of the Huron through the straits of Michilimackinac, towards the entrance of the Bay, and cause a sensible rise at Fort Howard.

As the winds are very variable on these lakes both in direction and duration, the irregularity of the rise, both as to its height and period, is satisfactorily accounted for; and hence, on the 5th of June, the rise and fall was frequent, in consequence of the undulations, produced by the wind, on the 4th.

This, I believe is the manner, in which the supposed tides have generally been accounted for, by those who have often been on these lakes.

*Notes on the tide at the head of Green Bay, made by Capt. Henry Whiting of the United States Army, in 1819.*

Immediately after our arrival at Fort Howard, the phenomenon of a visible tide at that place attracted my attention. It was at once perceivable, that there was a daily change in the level of the river, and I determined to make such observations, as the time and place would admit, in or-

der to ascertain its regularity and succession. The result of these observations, which were necessarily brief, and defective, is annexed; very little satisfactory inference can be drawn from them, as no correspondent observations were made upon the courses of the moon, without which no certain deductions can be made, as to the agency of that planet in producing this change. It will be observed, however, that during three of the six days, in which the observations were made, there was a flux and reflux, twice, notwithstanding the wind prevailed, in the same course, during the day, which affords something like a proof, that it is not the wind, alone, which produces them. The height of the rise and fall, was from twelve to eighteen inches. Both the ebb and flow were very sudden, and in that respect deviate from the general character of tides. It was seldom more than an hour, in attaining its height, and was generally as rapid in making the descent, though several hours would often intervene between the changes.

Supposing the winter to be the most favorable time for making certain observations, when the superincumbent ice would nearly destroy the influence of the winds, and shew the unassisted operations of the tide; I made inquiries, as to the appearance of it, during that season. One gentleman informed me that no tide was then discernible. Another, equally intelligent, told me that it was very apparent, and that there was a regular elevation and depression of the ice. This difference of accounts, may, perhaps, be reconciled, by the probable difference in the closeness of the observation.

*Tide at Green Bay.*

1819.	June 1.	4 o'clock	P. M.	High tide.	
"	"	10,	"	P. M.	Low tide.
"	"	2,	5,	"	A. M. High tide, } wind west.
"	"	"	6,	"	P. M. High tide, }
"	"	3.	No visible change in the height of the water; winds variable, and often high.		
"	"	4.	11 o'clock	A. M.	Low tide; wind west.
"	"	"	6½,	"	P. M. Continues low; wind strong, south west.
"	"	"	7,	"	P. M. High tide; calm.
"	"	5,	7,	"	A. M. High tide, } wind, s. w.
"	"	"	9,	"	A. M. Low tide, }

1819.	June 5.	2 o'clock	P. M.	High tide ; wind strong, south west.
"	"	6,	P. M.	Low tide.
"	"	10,	P. M.	High tide ; calm.
"	"	6, 9,	A. M.	High tide ; wind north.
"	"	1,	P. M.	Low tide.
"	"	7,	P. M.	High tide.

The course of Green Bay is about S. S. W.

The above observations were made by means of a stick, graduated with inches, placed, perpendicularly below low water mark.

*Letter from Capt. Henry Whiting of the U. S. Army.*

Detroit, Sept. 11th, 1827.

*Dear Sir*—I returned a short time since from Green Bay, but my stay there was too brief for any observations upon the waters, even if I had leisure to have made them.

Gov. Cass, as you have probably seen by the newspapers, was too busily engaged while in that country, for other than Indian affairs. I regret you cannot have the benefit of his remarks.\*

I got back the papers, to which I have before alluded, and as I promised, I send you the observations I made in 1819.† I did not recollect, that they were so meagre, and unsatisfactory. I was much engaged in military duty at that time, and had only snatches of leisure. They amount almost to nothing ; and yet I believe they are the only regular attempt that has been made to solve this interesting problem. While on the spot at this time, I asked many questions of the residents, but could not ascertain that any of them had accompanied their observations by any scale, or made any record. Their recollections were of course very loose, and amount to no more than an accordance with the popular belief. One or two mentioned the fact, that a mill, which is placed about ten miles up Devil river, a tributary of the Fox river, near its mouth, is daily stopped by reflux water. Another gentleman remarked, that he had frequently noticed in the winter, when crossing the river, that the ice was often lifted slightly, in the centre, while the two sides were partially cov-

\* See note, at the close of the letter,

† The same as those appended to Doct. Lovell's letter.

ered with water;—again it would be level, and no water apparent.

By a reference to some of my notes, it will be seen that the waters often swelled against the wind. This fact would seem to militate against any theory, assigning the rising to the winds, if it were not known that the outlet of Fox river is very serpentine, forming two or three deep curves in the course of a less number of miles. Hence the wave, heaped up by winds prevailing up the Bay, would be likely still to continue to roll into the river, sometime after the impulse had ceased, and even after the wind had changed.

Existing facts do not establish either the negative or affirmative; though I think it pretty clear, that the Green Bay tides, or whatever they may be called, are independent of all celestial influence; for no one pretends that they ever appeared to acknowledge any fealty to the planets.

It is rather the settled opinion here, among those, who have reflected much on the subject, that whatever changes in the level of the water take place, must be referred to the winds. That there has been a doubt in the case of Green Bay, is probably owing to the singular configuration of that deep inlet, and the sinuous outlet of the Fox river, when the effect is often so tardy, in following the cause, and sometimes, even running counter to it, as to sever all apparent connexion between them.

*Note.*—Capt. Whiting having informed me in a letter of the 16th of April, 1827, that Gov. Cass would hold a treaty, at Green Bay, during the summer, I had requested him, to desire the Governor, to make experiments, and to be so kind, as to communicate to me, the results, which, with his usual liberality, he was so generous as to say he would do; but unfortunately, his higher official duties prevented. H. A. S. D.

*Letter from Capt. Greenleaf Dearborn, of the U. S. Army.*

Monmouth, Maine, March 5, 1827.

*My dear Sir*—By the last mail, I received your favor of the 26th ult. and hasten to answer it, as far as my knowledge extends.

About the 15th of May, 1825, while stationed at the Sault de St. Marie, at the outlet of Lake Superior, I observed, for three successive days, a regular ebb and flow of the

water of the lake. I was led to the observation at that time, by having charge of a fatigue party, which was employed in removing the earth, which was deposited in the bottom of the canal, that conducts the water from the head of the rapid to the saw-mill, situated about three quarters of a mile below. In removing this earth, it became necessary to throw up a temporary dam of stones and sods, at the upper end of the canal, to prevent the water from flowing in. Just as this was completed, the water which had risen considerably while we had been at work, was about breaking over. I informed the men, it would be necessary to raise it higher. Although the wind was but light down the lake, and had not increased while we had been at work, still I attributed the rise of water to its influence. But one of the men, who had been employed the two preceding summers, in floating mill-logs, out of a small stream which empties into Lake Superior, about nine miles above, observed, that it would be unnecessary to raise the dam, for the water was at its height. I was incredulous as to his statement, and asked how he knew the water would not continue to rise. He replied, *that there were regular tides in Lake Superior*; he had observed them, the two previous summers, both in the stream where he rafted logs, and on the shores of the lake, and that the tide was about two hours and a half in rising, and the same time in falling. In consequence of this information, I directed the men, to suspend their work on the dam, for a few moments, to ascertain whether it would be verified. We very soon found the water was on the reflux, although the wind continued the same. We marked the shore, as the water receded; and as the bed of the lake, for several rods from the margin, made but a small angle with the horizon, the fall of the water, was perceptible, every moment; it was from two hours and twenty, to two hours and thirty minutes, in its ebb, and the same time in flood. The rise and fall was about eighteen inches, perpendicular. We observed two ebbs, and two flood tides, during that and the two following days, which were in the same regular manner. I mentioned these facts to the commanding officer of the post, and to several other officers;—they all attributed the phenomenon, to the wind above; but having made personal observations, they concluded it could not be caused by the wind, for it was neither violent, or variable, during the time. After this, I had less opportunity to notice so crit-

ically, the flux, and reflux of the water ; but I was frequently at the lower end of Lake Superior, and found the water either ebbing or flowing, except in violent gales, when it could not be so well observed.

Although I have stated only what came under my own observation, still I feel great delicacy, in making the communication, for none of the inhabitants, had made similar observations. They had noticed a rise and fall in the water, but only such as they attributed to the winds. It would seem hardly possible that the lake should ebb and flow regularly, and continually, and not have attracted the attention of some of them, a few of whom have been there for many years.

The periodical rise of the lower lakes, which takes place in from three to seven years, may possibly, be the effect of the height of water, in Lake Superior, and this caused by an unusual depth of snow on its borders, and tributary streams, or an uncommon rainy season.

I never could observe, at the foot of the rapids of St. Marie, any thing more than a light and sudden rise of water. The rise of the water above never caused a corresponding rise below.

I know but little relative to the tides in Lakes Erie, Michigan, Huron and Ontario, save vague rumor. In 1814, Lake Ontario, was about two feet higher, than in 1813. My situation on that lake, during those years, enabled me to remark this difference.

---

ART. XIII.—*On the observations of Comets ; by P. J. RODRIGUEZ.*

COMETS are the only bodies of the solar system, whose elements are not known with that degree of exactness, which the other parts of Astronomy have attained. This uncertainty, owing principally to the want of correct observations, will gradually diminish, as a greater number of observers shall furnish proper data, to ascertain the orbits of those bodies. It is true that the many able astronomers employed in making celestial observations, leave no doubt of obtaining those data if observations could be always made ; but it sometimes happens that on account of the position of a comet, or of the state of the atmosphere, no observations can be made from the fixed astronomical observatories. Thus,



the comet of 1695, is known only by observations made at sea by a French missionary: several others also are known only by few and imperfect observations; and it is not improbable, that in the antarctic expeditions now preparing, there may be discovered a comet, altogether invisible from any observatory. It is therefore, highly desirable for the advancement of astronomy, that all lovers of science should make all possible observations whenever a comet appears. The want of proper instruments, is indeed a great impediment; but even without a telescope, the positions of a comet might be ascertained with sufficient accuracy by measuring with a circle of reflection, or a sextant, its distances from two other heavenly bodies whose positions are exactly known. This method of which Hevelius and Halley made use in the formation of their catalogues of stars, might for its simplicity, be used at sea, where astronomical instruments could be used only with difficulty. These considerations have induced me to present to the public, the following essay, on the manner of ascertaining the positions of comets from the distances observed.

Fig. 1.

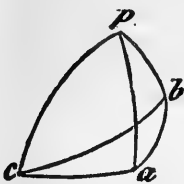

Let  $p$  (fig. 1,) be the pole of the earth,  $c$  the place of a comet, and  $a$  and  $b$  two fixed stars.  $Pc$  will be the comet's polar distance, and the angle  $cpa$  the difference between its right ascension and the right ascension of the star  $a$ . Measure the distances  $ca$  and  $cb$  from the comet to each star, and mark the time. The distances may be taken simultaneously when there are two observers; but when there is only one, the distances from one star must be reduced to the time at which the distances from the other star were taken. A circle of reflection would be the best instrument for these observations; but even with a sextant, the distances may be had with great accuracy, by taking the mean between several.

Fig. 2.

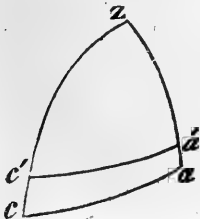

The distances will be affected by the refraction. They may be reduced to true distances by any of the known methods, or by the following, which is sufficiently simple and correct.

Let  $z$  be the zenith,  $c$  and  $a$  the true places of the comet and star,  $c'$  and  $a'$  their apparent places. Making  $c'z = N$ ,  $a'z = N'$ , and  $c'a' = D$  we have

$$\begin{aligned}
 d D &= d N' \cos z a' c' + d N \cos z c' a' \\
 &= d N' \left( \frac{\cos N - \cos D \cos N'}{\sin D \sin N'} \right) + d N \left( \frac{\cos N' - \cos D \cos N}{\sin D \sin N} \right) \\
 &= d N' \left( \frac{\cos N}{\sin D \sin N'} - \cot D \cot N' \right) \\
 &\quad + d N \left( \frac{\cos N'}{\sin D \sin N} - \cot D \cot N \right) \\
 &= \frac{d N' \cos N \cos c N' + d N \cos N' \cos c N}{\sin D} - \frac{d N' \cot N' + d N \cot N}{\tan D};
 \end{aligned}$$

and calling  $a$  the altitude of the comet,  $r$  its refraction,  $A$  the altitude of the star, and  $R$  its refraction, the preceding formula becomes

$$d D = \frac{R \sin a \sec A + r \sin A \sec a}{\sin D} - \frac{R \tan A + r \tan a}{\tan D}.$$

Having corrected the distances, find in the triangle  $pab$  (fig. 1,) the angle  $pab$  and the side  $ab$ . Then, knowing the three sides of the triangle  $cab$ , find the angle  $cab$ , from which subtracting  $pab$ , the angle  $pac$  will remain; lastly, in the triangle  $cap$ , having the sides  $pa$  and  $ca$ , and the angle  $pac$ , the side  $cp$  and the angle  $cpa$  will be ascertained, and therefore the declination, and the right ascension of the comet.

In order to determine the effect produced in the positions of the comet by an error in the distances, let  $cb=a$ ,  $ca=b$ ,  $ab=c$ , and  $cab=x$ . Then we have

$$\begin{aligned}
 \cos x &= \frac{\cos a - \cos b \cos c}{\sin b \sin c} \\
 \cos x' &= \frac{\cos a' - \cos b' \cos c}{\sin b' \sin c},
 \end{aligned}$$

and on account of the little difference between  $\sin b$  and  $\sin b'$ , we may suppose

$$\begin{aligned}
 \cos x - \cos x' &= \frac{\cos a - \cos a' + (\cos b' - \cos b) \cos c}{\sin b \sin c}, \\
 &= \frac{-2 \sin \frac{1}{2}(x+x') \sin \frac{1}{2}(x-x')}{\sin b \sin c} = \\
 &= \frac{-2 \sin \frac{1}{2}(a+a') \sin \frac{1}{2}(a-a') - 2 \sin \frac{1}{2}(b'+b) \sin \frac{1}{2}(b'-b) \cos c}{\sin b \sin c}
 \end{aligned}$$

making  $x-x'=dx$ ,  $a-a'=da$ , and  $b'-b=db$ ; and supposing these are equal to their sines, we have

$$\begin{aligned}
 \frac{1}{2} dx \sin \frac{1}{2}(x+x') &= \frac{\frac{1}{2} da \sin \frac{1}{2}(a+a') + \frac{1}{2} db \sin \frac{1}{2}(b'+b) \cos c}{\sin b \sin c}, \\
 dx &= \frac{da \sin a + db \sin b \cos c}{\sin b \sin c \sin x} \quad \text{nearly};
 \end{aligned}$$

and supposing  $da$  and  $db$  of the same sign, this equation becomes

$$dx = \frac{da \sin a - db \sin b \cos c}{\sin b \sin c \sin x} = \frac{da \sin a}{\sin b \sin c \sin x} - \frac{db \cot c}{\sin x}. \quad (1)$$

which shews that the distances producing the least errors are when  $cab$  is a right angle.

In the triangle  $cap$ , let  $cp=v$ ,  $cap=z$ ,  $ca=b$ ,  $pa=n$ . Then

$$\cos v = \cos z \sin b \sin n + \cos b \cos n$$

$$\cos v' = \cos z' \sin b' \sin n + \cos b' \cos n -$$

$$\cos v - \cos v' = (\cos z \sin b - \cos z' \sin b') \sin n + (\cos b - \cos b') \cos n,$$

$$= (\cos z - \cos z') \sin b \sin n + (\cos b - \cos b') \cos n,$$

$$\text{nearby ; } -2 \sin \frac{1}{2} (v+v) \sin \frac{1}{2} (v'-v) =$$

$$= -2 \sin \frac{1}{2} (z+z') \sin (z-z') \sin b \sin n - 2 \sin \frac{1}{2}$$

$$(b+b') \sin \frac{1}{2} (b-b') \cos n.$$

$$dv \sin \frac{1}{2} (v+v) = dz \sin \frac{1}{2} (z+z') \sin b \sin n + db \sin \frac{1}{2} (b+b') \cos n$$

$$dv = \frac{dz \sin z \sin b \sin n + db \sin b \cos n}{\sin v}$$

$$= \frac{dx \sin z \sin b \sin n + db \sin b \cos n}{\sin v} \quad (2)$$

Let  $cpa=w$ , and we have  $\sin w = \frac{\sin b \sin z}{\sin v}$ ; and taking the differentials,

$$dw \cos w = \frac{(db \cos b \sin z + dz \cos z \sin b) \sin v - dv \cos v \sin b \sin z}{\sin v^2}$$

$$dw = \frac{da \cos b \sin z + dx \cos z \sin b}{\sin v \cos w} - \frac{dv \sin b \sin z}{\sin v \tan v \cos w} \quad (3)$$

As an example, I shall apply the above to the comet of 1819, of which I made the following observations with a sextant.

1819.	True time.	Observ. distance to Arcturus.	Observ. distance to $\alpha$ Lyra.
July 10, - - -	9h 39' 48''	82° 6' 30''	90° 32' 30''
11, - - - -	9 20 37	81 26 26	90 6 34
12, - - - -	9 29 41	80 46 25	89 37 58
13, - - - -	9 9 33	80 17 00	89 18 00
14, - - - -	9 11 29	79 45 30	88 57 30
16, - - - -	9 33 25	78 49 30	88 25 45
24, - - - -	9 35 34	76 2 00	87 28 30

For the first observation we have

	True R. A.	True Declin.
Arcturus,	211° 51' 36"	20° 7' 41"
$\alpha$ Lyra,	277 42 50	38 37 25

To correct the distances, it is necessary to know the altitude of the comet. This may be found, first by the globe, and afterwards when the Right Ascension and Declination are ascertained, the altitude may be calculated correctly, which, if very different from the assumed, the distances should be corrected again with it. We will suppose, then, the apparent altitude of the comet  $5^{\circ} 19'$ .

The latitude of the place of observation was  $39^{\circ} 52' 30''$  N. With this, the altitudes of the stars corresponding to the time, will be found by calculation.

Apparent altitude of Arcturus,	48° 57
Apparent altitude of $\alpha$ Lyra,	71 45

With these data we find for the first distance  $dD=6' 58''$  and for the second  $dD=9' 8''$ . Therefore the true distances will be

True distance to Arcturus,	32° 13' 28"
True distance to $\alpha$ Lyra,	90 41 38

Let  $c$  (fig. 1.) be the comet,  $a$  Arcturus, and  $b$  the other star. In the triangle  $pab$ , the side  $ab$  will be found equal to  $59^{\circ} 0' 44''$ , and the angle  $pab=56^{\circ} 15' 46''$ . In the triangle  $cab$ , the three sides being given, the angle  $cab$  will be found  $=95^{\circ} 31' 27''$  from which subtracting the angle  $pab$ , it will remain  $cap=39^{\circ} 15' 41''$ . Now, in the triangle  $pca$ , knowing the sides  $pa$  and  $ca$ , and the angle  $cap$ , the side  $cp$  will be found  $=39^{\circ} 55' 41''$ , and the angle  $cpa=102^{\circ} 19' 16''$ . Subtracting  $cp$  from  $90^{\circ}$ , and  $cpa$  from the Right Ascension of Arcturus, we shall have ;

	R. A. of the comet.	Declin. of the comet.
July 10th, at $9^h 39' 48''$	$109^{\circ} 32' 20''$	$50^{\circ} 4' 19''$ N.

Supposing  $1'$  of error in each of the distances observed, formula 1 gives  $dx=34'' 8$ , which being substituted in formulas 2 and 3, these give  $dv=50'' 6$  and  $dw=-45'' 2$ .

ART. XIV.—*On the Effect of the Physical Geography of the World on the Boundaries of Empires*; by JOHN FINCH, F. B. S., M. S. D. &c. &c.

Essay, Part II.—Continued from Vol. XIV, p. 18.

To acquire a true knowledge of the history of nations, we must first study the physical structure of the soil.

This is the leading feature, on which the historical details are nearly always dependant.

Mountains, seas, lakes, and deserts, form natural divisions on the surface of the earth, which serve as boundaries to the several nations, and beyond which they can seldom pass with impunity. It is not in the contest between nations as on the chequered table of the chess board, where there are no natural defences, and a plain field of battle lies open to the combatants; on the surface of the world, the natural barriers between nations, restrain them when prosperous, and inclined to invade their neighbours, and serve as a protecting shield in adverse fortune.

These natural barriers separate nations, not only by the amount of physical force which it requires to pass them, but also because the nations, which they surround, have each their peculiar habits, customs, and feelings, which renders it difficult for them to coalesce with the surrounding states. To form a permanent empire, there must be some common feeling to unite the people under its sway; as all governments are founded, more or less remotely, on the opinions of the people, where they are established.

In order to impress these facts on the mind, read an account of the boundaries of any nation of ancient times, let us take Cæsar's description of the limits of the Helvetii. "Undique loci naturâ Helvetii continentur; unâ ex parte, flumine Rheno latissimo atque altissimo, qui agrum Helvetium á Germanis dividit: altera ex parte, monte Jurâ altissimo, qui est inter Sequanos et Helvetios; tertiâ, lacu Lemano, et flumine Rhodano, qui provinciam nostram ab Helvetiis dividit."—*Jul. Cæs. Comm.*

Or examine a map of the kingdoms of the world as they were arranged a thousand years ago, and one of the present time; you will find the great political divisions nearly alike.

In an historial chart, although the divisions do not correspond to the relative size of nations, they afford some guide

as to their increase or decrease of dominion, and we may there perceive how durable is the force of these barriers.

When we compare also the duration of conquests with the existence of nations, we then perceive the decisive and prevailing effect of natural divisions.

When extensive conquests are made, these boundaries may appear to be extinct, but they still remain; although surmounted by force, they are never destroyed; and at the proper period their natural effect will be again produced.

And it is fortunate for humanity that they exist otherwise the world would exhibit one general scene of despotism. Never did one of the race of conquerors, belong to that class who, like the liberals of France, are friends not only to their own country, but to the best interests of man.

The splendor of victories generally blinds us as to their permanent results.

The conquests of Sesostris were scarcely recognized beyond the march of his army.

Twenty times, according to observations of Malte Brun, have the tribes of the elevated regions of Asia, sallied down on the inhabitants of the plains, and subverted the thrones over the whole continent, but the political divisions of Asia, are very similar, at the present day, to what they were at its first colonization.

Nor does it signify by what title nations become possessed of their foreign dominions; by conquest or alliance; by peace or war: Nature compels the disunion.

Normandy was conferred on the brave Duke Rollo, by the French King Charles; when England was conquered, the union of the two heterogeneous countries continued but a short time. All the wars between England and France have terminated in the exchange of a few foreign possessions.

When we read an account of the conquests of Alexander the Great, we are apt to imagine that such mighty achievements, such splendid conquests, must have continued for ever; on turning over the following page of history, we ascertain, that his successor reigned only two years. Then came the struggle of the nations to form separate states, which, after a combat of thirty years in duration, was happily effected.

Conquerors, after traversing the Earth, and subduing nations have often recognized the force of these natural boundaries, and have divided their empires among their sons, ac-

ording to true natural lines of demarcation. Thus Charlemagne, after uniting France, Italy, and Germany, under his temporary sway, established that division of his States, which has remained unaltered to the present time.

Even Napoleon, the ambitious Napoleon, perceived the force of this law; when victory had placed at his disposal many of the finest regions of Europe, he did not attempt, except in a few instances, to unite them to France; he placed his relations and friends on the vacant thrones, trusting to their personal friendship, and to political reasons, for their assistance in war.

At other periods; "how often has the funeral cry which arose at the tomb of the warrior king been the signal for the dismemberment of his empire."

When victorious troops are poured into a country, they gradually coalesce with the original inhabitants. The scenes of nature impress them with irresistible force, and they soon begin to understand, that the independence of nations should be the first law of the world.

Some may suppose, that the boundaries of nations depend on the nature of their governments, but this does not appear to be the fact. In the wars that frequently arise between monarchies and republics, the latter generally have the advantage, for kings are sometimes indolent, but republics never. But a conquest over kings, introduces kings into a republic, not merely those who are captured on their thrones, or taken prisoners in battle, but the pride of success, and the wealth that is accumulated, introduce that state of feeling which cannot be gratified without monarchical government. Thus the same laws apply to the boundaries of nations, under whatever form of government they are placed.

#### RIVERS.

There is probably no opinion more general, and more erroneous, than that of large rivers forming a boundary to nations.

It is wrong to vex a peaceful river with armed garrisons on its banks.

It is no less wrong in a political point of view.

Numerous forces will be stationed on the shores, by either party, and collisions must necessarily ensue. They also afford so easy a communication that numerous custom house officers must be engaged in active service. The river, instead

of favouring commerce, becomes an annoyance to both parties. It is a bad military line in time of war. *A state is powerful, in proportion as she possesses the whole extent of the basin, from which the water flows, to supply her rivers.*

Thus the State of New York, has great national strength, because she possesses the sovereignty of the river Hudson, and nearly the whole country on both shores, without any interference.

The State of Connecticut in a similar way possesses the course of her principal river, for a considerable distance.

The Delaware is not of so much importance, to New Jersey or Pennsylvania, as it would be if the undisputed property of either. In support of this position and of the general fact assumed, I may adduce the opinion of Professor Renwick of Columbia College, New York.

“The Hudson divides New Jersey from the State of New York on one side, and the Delaware separates it from Pennsylvania on the other.

“However definite these may be as territorial limits, they operate, by their facilities of navigation, rather as bonds of union, than as divisions of the inhabitants in their vicinity, from those of the two adjoining states.

“Hence the citizens of East and West Jersey, have different feelings and views upon almost every question of public interest, nor does it appear possible to unite them in exertion.”

The Rhine was a military boundary against the ancient Germans, but could not have been against a civilized power.

The Tay was not so good a barrier against the ancient Scots, as the Roman wall.

The Nile never formed a boundary, even in the intestine wars which sometimes destroyed Egypt. Hostile armies sometimes encamped on the opposite shores, but the contest was always continued, until one was defeated. When two powers, of nearly equal strength, have been in Egypt at the same time, the line of demarcation has generally been across the Nile, one possessing upper, the other lower Egypt.

The late contest between Brazil, and the inhabitants of Buenos Ayres, arose from an erroneous opinion on the part of the former, that the river La Plata was the true boundary.

#### SEAS AND OCEANS.

Some nations appear to dread the water, and to them, the ocean is a boundary which they never attempt to pass.



To others, instead of forming a boundary, it presents a temptation to conquest.

The facility with which naval empires are founded is a most striking phenomenon, and is equalled only by the rapidity with which they are overturned. The example of the Portuguese may be noticed. They first visited India as merchants, then invaded it as conquerors, and the terror of their arms were spread from Mozambique to the Ganges. Nothing appeared to stop their career.

Their armies were so brave, their cities so strong, and their allies appeared so faithful, that the Portuguese statesmen considered their Indian empire, as placed on the firmest foundation.

The appearance of the fleets of the Hollanders in the Indian ocean, soon changed the face of affairs, they were joined by the natives, who were glad to escape from tyranny, and the Portuguese empire crumbled in the dust.

England owes her immense power to the facility of transporting her force on the ocean; with a moveable army of ten thousand soldiers, she has acquired dominion over eighty millions of people, and it requires only thirty thousand disciplined troops to keep them in subjection.

#### MOUNTAINS

*Are on several accounts, good boundaries between nations.*

Numerous bodies of troops, can not without a great expense, be supported upon their summits; so that nations, to whom they serve as barriers, are content with placing a few centinels on the frontiers.

If mountains were always boundaries, wars would be less frequent; the difficulty of marching to combat would often cause even ambitious men to pause.

Thus the armies of France have not so often crossed the Pyrenees and Alps in search of conquests, as they have invaded the valley of the Rhine and Netherlands.

The Andes form a natural barrier to the States on the western coast of South America, and one of the most disastrous military expeditions, perhaps ever recorded, was that under Gonzalo Pizarro, in which this circumstance was disregarded.

Of all those who live within sight of the Blue Mountain, probably not one in a thousand have ever visited its summit. These few were the ambitious inhabitants of the plains, but even they could not establish a permanent residence.

The range of mountains between the New England states and Canada, are a better boundary than the St. Lawrence.

*The inhabitants on the opposite sides of a mountain, seldom think alike on any subject.*

This may be accounted for in the following manner.

The sun never shines equally, on the two sides of a mountain at the same time. An inhabitant of the north, looks upon the mountain, and beholds it enveloped in shade. An inhabitant of the south beholds it resplendent in light and all the landscape enlivened by the rays of the sun. How can two individuals who see the same object in such different points of view, ever be brought to think alike on any subject.

Again, the temperature of the air is always different. A native of the South visiting the country to the north, shivers with cold, while all around him are gay, lively, and happy. How can people who feel so differently in the same climate, ever be friendly subjects of one government.

There is a shield placed on the summit of every mountain, one half is painted white, the other is painted black, the inhabitants on the opposite sides, look upon the same shield, but cannot agree as to its color.

The effect of this has been perceived in the councils of more than one of the United States.

In Pennsylvania, I have been informed by a member of the Legislature, that, on many questions, the opinion of the members is known from their residence on the east or west of the mountains.

The same fact is confirmed as it respects Virginia by the author of "Letters from the south" he says the mountain called the Blue Ridge not only forms the natural, but the political division of Virginia. That on the East, is called Old Virginia, and that on the West, New Virginia, the inhabitants of these several territories, occasionally exhibit a considerable degree of hostile feeling towards each other.

"All the considerable states to the south of New York inclusive, have two distinct and separate local interests, or rather, states of local feeling. The eastern and western sections

of these states are continually at variance, and as the west is generally the most extensive, as well as fruitful, it is gradually moving the seat of power further into the interior." There is a small territory in New-Jersey which exemplifies the difference between rivers and mountains as boundaries of nations. It consists of a tract of land about thirty miles long, and two or three miles wide. It forms the "ultima Thulé" of the state towards the north, and is situated between the Blue Mountain and the river Delaware. The inhabitants of this section belong to New Jersey by political arrangement, but are completely excluded from it by the Blue Mountain, which is near a thousand feet high. The other part of the state would have been almost ignorant of their existence, but that they have recently petitioned the legislature to open a road near the foot of the mountain that they may have a communication with their fellow citizens to the south. All the trade of the district, is carried on across the river with Pennsylvania.

#### MOUNTAINS IN GROUPS.

Where mountains are placed together in groups, with intervening vallies which are susceptible of cultivation, a different rule obtains as to their boundary. It will then be found, not at the summit of the first chain, nor at its base, but extends into the surrounding country in every direction. The inhabitants of these districts resemble the garrison of a fortress, who not only command the fortifications, and the interior town, but also the resources of the country to a distance of several miles.

Thus the mountaineers of Switzerland are not content with the rugged summits, and the picturesque vallies of the Alps, but have conquered and retain Neufchatel, La Pays de Valais, and the city and territory of Geneva.

The mountaineers of Caucasus compel the payment of tribute from their neighbors.

No individual could formerly live within twenty miles of the mountains of Scotland, unless he would submit to contribution. The demands of the king at Holyrood might be evaded, but those of the kings of the Highlands it was impossible to escape.

## DESERTS

*Form a permanent barrier to nations.*

The ancient Egyptians, surrounded nearly on every side by deserts, attempted in vain to pass the boundary which nature had interposed between them and the adjacent nations. They attempted the conquest of Palestine; more than once, when they saw the Jewish chieftains led into captivity, they supposed their triumphs complete, but were still unable to unite the two countries.

Two foreign kings, who obtained possession of Egypt, attempted to establish their dominion over the deserts of Africa by force. The result of the two expeditions was similar, though the immediate fate of those engaged was different. Cambyses the Persian took with him a numerous and flourishing army; he left them buried in the sands of the desert, and returned back nearly alone.

Hussein, the son of Mohammed Ali Pacha, undertook a similar expedition, but his army returned, leaving their commander in possession of as much dominion as his remains would cover.

The empire under the rule of the heirs of Constantine the Great, and those of the monarch of Persepolis, were separated by immense deserts, which served as a barrier between the hostile nations. The Romans of the eastern empire, under a warlike emperor, were accustomed to make inroads on Persia, crossed the Tigris, captured the principal fortresses, and imagined the country subdued. A single year generally witnessed their retreat. The Persians, when their leaders were ambitious, invaded Asia Minor, gained victories and captured cities, but the result was uniformly the same.

Lewis the fourteenth, laid waste Lorraine and Franche Comptè; however detestable this was in a moral point of view, it was correct policy, to prevent the invasion of France.

The desert of Atacama forms a natural barrier between the dominions of Chili and Peru. A desert, twelve hundred miles long, forms a boundary to the United States of America on the west.

The political fate of the nations, residing, in future time, beyond this boundary, is fixed by their situation.

It is not possible that the inhabitants of the coast of the Pacific, if true sons of America, will ever send their representatives to a distance of three thousand miles, over

mountains ten thousand feet high, and a desert five hundred miles wide, to ascertain the mode in which they are to be governed, or to enquire with what foreign nations they shall cultivate the arts of peace, or partake the luxury of war.

1. *The surface of the earth is thus separated into certain natural divisions, which may be called natural kingdoms.*

2. *Small natural kingdoms, in the vicinity of those which are larger, often lose their independence.*

France has united to herself the smaller divisions of Navarre, Franche Comptè, and Lorrain.

Denmark Proper has usurped the islands of Funen, Zealand, Sylt, Nordstrand, and Falstar.

Central England has united to her dominion Cornwall, Wales, Scotland, and the islands of Man, Ireland, and Staffa.

Florida is another example. The language of the American negociator sounded harshly to the monarch of Spain, when he asserted, that a small territorial division, like Florida, could not remain either as a colony, or independent in the immediate vicinity of the United States; but the sentiment was perfectly accordant to facts, which have occurred in the history of all times, and of all nations.

The powerful State of New York comprises within her dominion, Staten Island and Nassau. The first would more properly come within the geographical limits of New Jersey; the latter should form an independent state, in which the inhabitants, devoted to agriculture, to hunting, and fishing, and excluding all commerce from their shores, might shew an example of the happy primeval age of mankind.

3. *Oppression suffered by Dependencies.*

Man, in a small natural kingdom, has seldom his full political rights; it is scarcely possible that he should rise to an equality of privilege, with those who reside in the central or larger division of territory, under the same sovereign. Thus the native of Castile considers himself more noble than the inhabitant of any other province in Spain. A native of the centre of France is esteemed superior to those on the borders, and, in former times, paid a smaller amount of taxes.

The form of government in the central nation makes little difference in the sufferings of the dependencies. Thus the natives of the Pays de Vaud suffered as much under the Swiss Cantons, as the Greeks beneath the government of the Turks. The oppression under which Ireland groans, is more owing to her geographical position, than to any innate love in the government of Great Britain to misrule.

There are however, some advantages to an inhabitant of these smaller divisions; for his interest is identified in some degree with that of the larger empire. They deprive him of some political rights, but they fight his battles on a magnificent scale. Sometimes, the natives of the central districts will pay a larger proportion of taxes merely for the pleasure of keeping so many dependencies in subjection.

4. *Choice of residence.*

Unfortunate is the man who resides near the boundary line of a large kingdom, for it is always a dangerous position; or in a small natural kingdom, unless he is endowed with such a firm disposition of mind, that he would sooner die in battle than submit to oppression. His example, though fatal to himself, would secure better terms to his countrymen.

Therefore, an individual, who has "the world before him where to choose his place of rest" would perhaps do well to avoid a residence on the borders of France, or an island that could be visited by the fleets of the English. A thousand years hence, the defiles of the Rocky Mountains, and the country between Mexico and the United States, will certainly be a dangerous home.

Thus, in former times, no individual, who valued his life or property, would have chosen a residence in the debatable land between England and Scotland, or in the Marches of Wales, where battles and skirmishes were the order of the day for near five hundred years.

5. *On the effect of Geographical shape, arising from the physical structure of the Earth, on the boundaries of Empires.*

The Emperor observed the difficulty which arose in uniting Italy in one kingdom. He said, that if the southern extremity had been placed by nature between Genoa, Sardinia and Rome, Italy would then have made a strong kingdom; which, in its present shape, even his energy was unable to accomplish. The native of Otranto can have no common interest with the inhabitant of Turin or Venice.

The northern coast of Africa, extending from the Atlantic ocean to the confines of Egypt; bounded on the north by the Mediterranean, on the south by the chain of Mount Atlas; is another instance of a country whose destiny is fixed by its shape. It could not be united under one government except by a superior naval power, situated in those seas. This was first accomplished by the Carthaginians, second by

the Romans, last by the Saracens; in the intervening periods it has always presented small independent sovereignties.

The western coast of South America is a narrow district of country, extending between the Andes and the Pacific ocean. It resembles the northern coast of Africa, and like that cannot well be formed into one dominion. The genius of Bolivar will not be able to unite permanently the destinies of Colombia and Peru.

The central valley of Europe, bordering on the Danube, presents a district of country of great length in proportion to its width, and never has any conqueror, in ancient or modern times, been able to combine it in one empire. It is now divided between Bavaria, Austria and Turkey.

The central valley of Africa, bordering on the Niger, bounded by the mountains of Kong and the desert of Zahara, resembles in its shape the central valley of Europe. It is impossible to unite it under one government. The difficulty of discoveries in Africa has arisen from this cause; the traveller incurs the risk of losing his life and property from twenty various robbers; each invested with sovereign power and separate dominion.

6. *Where the natural boundaries are not very definite, the oscillation of dominion may be considerable.*

Thus in the smaller states of Germany, there appears to be no definite rule by which their territory can be determined; in general they possess both sides of the rivers where they are placed.

7. *Influence of internal communications on the boundaries of nations.*

It has generally been supposed that roads and canals, forming extensive lines of communication, are favorable to the extension of territorial power. When these are situated within a natural kingdom or state, they of course tend to unite the people of a country, but it is perhaps questionable whether they can ever be sufficiently numerous, as to join in one sentiment people of distinct national habits.

The five roads across the Pyrenean mountains are not sufficient to unite France and Spain.

The road of the Simplon, however magnificent, did not preserve to the viceroy of France the submission of his Italian subjects.

Roads, however numerous, will not change the seasons; will not alter the geographical situation of a country.

The ocean affords an easy channel of communication between England and France, but it does not combine in one sentiment the people of the two countries.

On this part of the subject I cannot do better than give the written opinion of an individual, who, after occupying the Presidential chair of the United States, carries with him into retirement, all the kind and amiable feelings of human life, united to the deep political discernment of a statesman; and who exercises the rites of hospitality in the most courteous manner.

Montpelier, May 13, 1828.

*Dear Sir*—I have received your letter of the 1st inst. and with it a copy of your Essay. \* \* \* \*

\* \* \* \*  
 On turning from the past to the future, speculation may be invited to the influence on those boundaries, that may result from new modifications of governments, and the operations of art on the geographical features of nature. The improvements in political science, more particularly the combination of the federal and representative principles, seem to favor a greater expansion of government in a free form, than has been maintainable under the most despotic: whilst so many of the physical obstacles, hitherto determining the boundaries of states, are yielding to the means which now render mountains, rivers, lakes and seas, artificially passable, with a facility and celerity which bring distant regions within the compass required for the useful intercommunications. Nor should the telegraph, with its probable improvements, be overlooked, as an auxiliary to the convenient exercise of power over an extended space. \*  
 \* \* \* \*

With friendly respects,

*Mr. Finch.*

(Signed) JAMES MADISON.

8. *Difference in the boundaries of savage or civilized races of men.*

A river is a boundary to a savage; a lake still more so; the ocean is impassable. His bark canoe is not fitted for engagements on the water.

He reveres the mountains, and seldom attempts to pass them.

His empire is always small, and bounded by the more minute physical obstacles on the surface of the earth.



The effect of very small territorial division is unfavorable to the tribes of savages. They fight continually. Civilized nations have some intervals of peace between their combats.

Another point of view, in which the structure of the earth has an effect on the boundaries of nations, is the nature of the soil, whether fertile or otherwise, &c. ; but the limits of the present essay do not admit of noticing this branch of the subject.

In the history of nations, we peruse an account of three states, whose political relations have been governed by the maxims of sound philosophy. China, which refuses to make conquests beyond its natural limits. St. Marino, which, when invited by the chief consul of France, to round the territories of her small republic, refused so tempting an offer. Massachusetts, which surrendered the right of sovereignty to an extensive dominion, when she could no longer exercise power without committing injustice.

I am not of opinion with that French moralist, who said, "Il ne faut jamais songer a la guerre que pour defendre la libertè;" for all those wars may be considered as necessary, and tending to promote human happiness, which are made for the consolidation of natural empires. Thus those are to be approved which took place for the union of the British isles ; for the consolidation of France ; for the establishment of the kingdom of Spain.

Also, all those which are undertaken to reduce large empires to a natural size, which may however be considered as wars for liberty.

All others are adverse to the real prosperity of states.

To some nations, the pomp and magnificence of preparation, and the hope of seizing with violence on the possessions of others, may lead to combat. But far happier are those, who, content with the dominion which Providence has assigned them, use every effort, consistent with true national honor, to avoid the extremity of war.

They are saved from the dishonor of conquests over nations inferior in strength—from the crime of exercising dominion over people who wish to be free—from the intoxication and false glitter of victory—from the mortification and the terror of defeat.

## ART XV.—On the Manufacture of Glass; by HORATIO N. FENN,\* M. D.

## CRUCIBLES.

IT is usual in all *Glass Houses*, for the manufacturers to make their own crucibles. The difficulty and importance of this branch cannot be duly estimated, by those who have never been practically acquainted with the manufacture of glass. If the pottery is bad every thing is in confusion: not only the first cost of the materials, but the labor of their preparation, and the expense of the workmanship is entirely lost. If on the contrary, the crucibles are well made, the manufacturer knows beforehand the products of his fabrication, and directs it to the greatest advantage. He can regulate the action of the heat, vary at pleasure the vitrifiable materials, and in fact manage and control the entire operation at will. It is all important therefore, that the pottery should receive the strictest attention that it may be as perfect as possible.

In the first place it is essential that the materials for the pots, should be of the very best quality. There are still imported into this country, for the consumption of our glass houses, three kinds of clay; the white and blue *German*, and the *English* blue clay. They are all of the class called porcelain clays. The blue clays derive their color from carbonaceous matter, as they all become white in the furnace. Our own country furnishes numerous localities of clay, which are often substituted for those imported. The only kind which I have seen used, is the Philadelphia or New Castle clay, which I am informed is obtained on the Delaware River, near New Castle, below high water mark.

This clay is brought to us in masses as large as one's head; it is white, with rose colored spots of various sizes, scattered through the body of it. These spots are evidently caused by oxide of manganese—as on exposure to the heat of the furnace, they become black. It is very infusible, and when mixed in certain proportions with the other clays, it forms a preferable compound for pots to either of them alone.

---

\* Dr. Fenn having been *practically* concerned in the manufacture of glass, has communicated the following observations for this Journal, at the request of the Editor.

For making pots we use equal parts of raw clay, burnt clay, and pot shells. This last is obtained by breaking the old pots, (that have been thrown out of the furnace,) into pieces and then picking off the adhering glass and glazing. These materials are each separately ground, and sifted through a fine seive—they are then put together into a trough, and intimately blended while in a dry state; water is now poured in, until the whole mass acquires the consistence of mortar. In this state it is suffered to remain ten days or a fortnight, covered with a wet cloth. It is found at the end of this time, of the consistence of dough and nearly as tenacious. A workman is now employed to turn it, and work it with his feet. He commences by cutting it into slips of an inch thick, and three or four inches wide; these he lays on the bottom, at the farther end of the trough, when he has covered the bottom in this manner, he gets upon it, and consolidates it with his feet; he thus continues until the whole mass is thoroughly trodden. This operation is performed daily until the clay becomes solid, or in other words until all the air has been pressed out of it, so that upon cutting it open it presents an even uniform surface. Should it now be of a proper consistence, pots may be made of it. But it is thought to improve if it is suffered to remain in this state six or twelve months before it is formed into pots—and as far as my own experience extends this is the fact.

For making the pots we use cylindrical moulds, formed of plank, bound with iron hoops opening on each side. Upon these the workman places pieces of cloth, moistened so as to adhere to the side of the mould, until the whole inside is covered. This is to facilitate the separation of the pots from the mould. The mould being thus prepared, he cuts off a piece of clay, as much as he judges sufficient to form the bottom of the pot, together with four or five inches of the side—this he places upon a board of a size to cover the bottom of the mould, the mould is now placed over this, and the workman getting upon the clay, treads it down around the bottom. The centre of the clay is then beat down to the proper thickness of the bottom of the pot, by a block of wood made for the purpose, and the remainder of the clay beat up around the sides of the mould by the hands to the desired thickness—the sides of the pot are then extended by beating small rolls of clay, upon the inside of this with the hands, until they are brought to the top. The inner surface of

the pot is now smoothed by an iron instrument, and the top of it trimmed and finished. After which the whole is set aside to dry—when it is thought to be sufficiently firm to sustain itself, which is usually the fact in forty-eight hours, the mould is removed, and the whole outside of the pot is carefully dressed over. This process of smoothing and solidifying is continued daily, until the pot becomes so dry and hard that no impression can be made upon it. The pot is now finished, but it should remain six or twelve months, before being used, experience proving conclusively that a pot twelve months old, when put into the furnace, is much less liable to break, than one that has been but recently made. The frost should be carefully excluded from the room where the pots are stored, as should the water in them, (of which they always contain some,) congeal, it would ruin them.

We usually make our pots two feet in height, twenty inches in diameter at the top, and sixteen inches at the bottom. The bottom is two and a half inches thick,—the sides one inch and a half at the top, and two inches at the bottom. A pot of this size when tempered, will contain 250 lbs. of glass. We ordinarily have from eighty to one hundred pots in the pot room, so that there may be no necessity for using new pots. When perfectly made, and of good materials, a pot will last in the furnace from three to six weeks. When imperfectly made or of poor clay, they are very liable to burst on the side, next the centre of the furnace, and at the time when the melting is nearly perfected. When this accident occurs, the entire contents of the pot are lost, as they at once, flow into the tone of the furnace, and mix with the ashes and coals, with which that part is filled.

When a new pot is to be set, it is taken to the tempering oven, and placed carefully within it. The fire under this oven is then gradually raised to a bright red heat, and retained at that point five or six hours. When the workmen have finished blowing, the furnace is allowed to cool down to the temperature of the oven. The pot is then carried into it, through the stoak hole or door at its end, and placed by means of a large iron bar and hooks, upon the bench directly under one of the rings.

The loss arising from the failure of the pots, (which cannot always be prevented,) notwithstanding that all the care and skill of the most experienced and intelligent workmen has been bestowed upon their manufacture, adds greatly

to the original cost of window glass. Could we substitute or discover, some substance, that, together with the other essential properties of clay, was not liable to fracture, it would supply what is now a great desideratum.

The various works of masonry necessary for the manufacture of window glass, are the following.

1. *Calcining ovens* for preparing the materials.
2. A reverberatory furnace, for fusing them.
3. A flattening oven, for flattening and annealing the glass.
4. Drying ovens or wood kilns, for drying the wood.
5. A tempering oven, for burning pots and clay stone generally.

In the description which follows, of the various steps which the materials are made to pass through, in converting them into window glass, these several structures will be briefly described.

The vitrifiable materials and the proportions in which they are used, are the following.

Verona sand, 100.	Sand, 100.	Sand, 100.
Potash, 34.	Kelp, 65.	Sul. Potash, 45.
Salt, 16.	Lime, 8.	Lime, 8.
Lime, 5.	Chip glass, 30.	House ashes, 15.
House ashes, 15.	House ashes, 25.	Saw dust, 2.
Chip glass, 30.		Chip glass, 30.
Sand, 100.	Sand, 100.	This mixing is the one which we have commonly employed, and on several accounts it is perhaps preferable.
Sul. Soda,* 60.	Potash, 20.	
Lime, 5.	Kelp, 28.	
Ashes, 20.	Lime, 5.	
Saw dust, 2.	House ashes, 15.	
Chip glass, 20.	Chip glass, 25.	

The sand is thrown into the calcining oven and ignited five or six hours. The house ashes are subjected to the same treatment. The object is the same in both—to burn away the vegetable matter, drive off the water, and expel the carbonic acid, which the materials may contain. When this is accomplished, the materials are taken from the oven, allowed to cool, and sifted through a mesh  $\frac{1}{30}$  of an inch in diameter.

---

\* If this salt is used containing the water of crystallization, 140 parts should be taken.

The *lime* is changed to an hydrate and likewise sifted. The *potash* is broken into pieces not larger than a walnut. The *salt* needs no preparation.

*Kelp*.—This term is applied to a salt made from the ashes, collected from under the kettles of the salt works at Salina. It is manufactured in the same manner as potash, by lixiviation and evaporation. It is used in our manufactory as a substitute for salt and potash. I should think it a compound salt, composed of muriate of potash and carbonate or sub-carbonate of soda, in nearly equal proportions. It would be preferable to potash in the formation of glass, could we always rely upon its composition; but this at times varying, causes occasionally serious loss.

The sulphates of potash and soda, when employed, should be finely pulverised. The saw dust is used as being more convenient than charcoal. The effect of either is to decompose the sulphates, by seizing the oxygen of the sulphuric acid, forming carbonic acid, and escaping through the materials, while the sulphur of the sulphuric acid, being left free is driven off by the heat employed, and the alkali remains in its purest form, to unite with the siliceous matter.

The materials being prepared as above stated, are put together, and so intimately blended, that the different articles shall be uniformly distributed through the whole mass. If circumstances will permit, it should remain three months in this condition.

There is but a slight difference in the quality of the glass which these different mixtures produce, and the time required for their fusion is nearly the same. As to the relative cost of either, it must depend upon the comparative price of the several articles in market, which of course varies from time to time.

Sometimes, in consequence of the materials not being sufficiently free from vegetable impurities, the glass will assume a yellowish tinge. To obviate this, or to correct it when it occurs, the white oxid of arsenic, the black oxid of manganese, the nitrate of potash and the oxides of lead are all occasionally used. They all appear to act, by furnishing oxygen, which combining with the carbon, carries it off in the form of carbonic acid gas.

To get these materials to the bottom of the pots, that they may unite with the glass, and produce the intended effect, is best accomplished by wrapping them in a wet paper, and

thrusting this down by means of an iron rod. In this way, with the black oxid of manganese, I have usually succeeded, perfectly. The effect of the lime, (which enters into all the mixtures,) is thought to be, to aid in the fusion of the material; and it certainly produces one other effect, *that is*, it renders the glass a better conductor of caloric, so that in tempering, and in the other operations which it undergoes, there is less liability of loss by breaking, particularly, when under the action of the diamond.

The wood used in the furnace for melting and blowing, is from three to three and a half feet in length, split so fine that no stick will measure more than two inches in diameter, and all of it requires to be kiln dried. Six ovens built in the center of the manufactory, each containing a half a cord of wood, are used for this purpose. The furnace when in operation consumes six cords of this wood in twenty four hours.

The *Furnace* itself is constructed either of artificial stone, made of the same clay as the pots, or of some natural sandstone, that is nearly or completely infusible, when exposed to the elevated temperature requisite in the fusion of glass.

The kind generally preferred is that obtained from *Haverstraw* on the *North River*.

The pots of which there are ten, are placed five on each side of the furnace, upon benches extending the length of it, raised about twenty inches from the bottom of the *tone*, which term is applied to the space in the middle of the furnace between the pots—opposite each pot, is a ring stone, through which a space is left denominated the ring, of about seven and a half inches in diameter. Through this the materials are put into the pots, and the glass taken from them for blowing. They also constitute the only draught to the furnace, which is regulated by small clay stones called *cookies*. At each end of the furnace, is a fire place of sufficient size to admit the passage of the pots into the *tone*, with which it directly communicates. The fire places after the pots have been put into the furnace are closed, by means of a claystone door, eight inches thick, through which is an opening near its center four inches in diameter, to admit the wood—a space is also left at the bottom of the door for the admission of air, and the lock stone which forms the bottom of the fire place is also perforated for the same purpose.

The furnace is supported at the four corners, by pillars of masonry and upon each of these it is usual to build a calcining oven, with a flue communicating with the furnace. This arrangement saves the expense of the fuel which would be otherwise consumed in preparing the materials.

When a furnace is built it requires from three weeks to a month, to raise the temperature, to the desired degree, after which the heat is sustained steadily and uniformly in the following manner. The stoaker, as the fireman is called, commences his tour of duty by taking two sticks of dry wood, he puts one of them into the hole in the clay door near him, then walks deliberately around the furnace, to the further door where he deposits the other in the same manner; continuing his travels, he encircles the furnace, and again supplies himself with wood. Thus moving at the rate of about three miles an hour, he continues his route supplying regularly the furnace with fuel, until he is relieved at the end of six hours, by another stoaker, who is likewise relieved by the first. We usually employ, and always prefer for this business superannuated blowers, as they are familiar with the manner in which the fire should be regulated, so as to produce the quickest melt, with the least quantity of fuel. Although it appears a very simple operation, yet two hours of time will be gained in every melt, by employing an experienced stoaker.

*Melting.*—When the furnace has arrived at what is called a white heat, the vitrifiable materials, (or mixing,) are thrown into the pots through the rings, by means of an iron shovel made for the purpose. After the pots are filled, the cookies are replaced, and the fire increased to its maximum, and regularly continued, until the materials are perfectly fused, during which operation, the superintendant of the furnace or *master stoaker* as he is termed, occasionally examines the glass with an iron rod, to ascertain the state of the melt, and that it is going on prosperously. The fusion of the first *laying in* being accomplished, the pots are again filled with mixing—and this process is repeated, until the melted metal, is within three inches of the top of the pot. To insure an intimate mixture of the different layers of glass, and form a perfectly homogeneous mass; it is now stirred.

This is done either by means of a billet of wood or what is better a potatoe put on the end of an iron rod. This is



thrust down to the bottom of the pot, through the melted glass, when the sudden conversion of the contained water into vapour, creates a motion throughout the whole mass, resembling ebullition, raising the glass to the tops of the pots. This soon subsiding, they are next filled with fragments of glass, and the cookies again placed in the rings.

As the fire is continued, large quantities of air in the form of bubbles rise and burst on the surface, until eventually the fluid mass becomes perfectly clear.

When this fact has been ascertained, the furnace is suffered to cool down, for one hour or until the glass stiffens on the tops of the pots. During this time the doors of the furnace are opened, to clear out of the tone the *slag* ashes and coal which may have accumulated during the melt. The fire is now gradually increased, until the metal becomes of a proper consistence for blowing. The blowers are then called, and the master stoker delivers the care of the furnace to the *master blower*, whose duty is to superintend the fire during the blowing. On an average, it takes twenty four hours in melting when the furnace is new, and thirty hours when it has run six months. It is usual to keep one furnace in operation nine months, from September to June, and then to employ the three summer months, in repairing the works. A furnace of ten pots, of the ordinary capacity, will make from seven hundred to one thousand boxes of glass per month, according to the good or bad success attending its operations.

*Blowing.*—There is one blower and a boy or apprentice, allotted to each pot. The blower commences by first putting the end of his pipe into the ring, leaving it until it is nearly red, then putting it into the water, when the oxide flies off, and leaves a metallic surface—it is then dipped into the metal, and by turning it around a quantity adheres to it—this is taken out, and if necessary, fashioned by an iron, termed a *strike iron*, it is again taken to the pot, and by repeated dippings a sufficient quantity is accumulated to form a cylinder—this usually requires three *gatherings* as it is technically termed. The workman now puts the ball of glass a short distance within the ring, where he holds it a few moments, (constantly turning it,) that it may acquire the precise temperature necessary. It is then withdrawn, and by means of the *strike iron* the semi fluid mass is crowded near the end of the pipe, when it is conveyed to a concavity, formed in a

block of wood, which contains a small quantity of water, where the blower causes it to rotate for a moment to give form to the mass. Then applying the mouth piece of the pipe to his lips, and blowing, he gradually inflates the ball, still continuing the rotation until it becomes of the required size. This process forms a hollow globe on the upper side of the ball. The workman now puts it again to the ring of the furnace that it may regain the heat which it has lost in the preceding process—it is then taken from the fire, and the pipe again applied to the mouth, and standing on a bench, the blower at one and the same time swings it from side to side, gives it a rotatory motion, and inflates it. In this operation the centrifugal force, aided and corrected by gravitation, (while at the same time it is inflated) causes the globe to assume the form of a cylinder, attached to the pipe at one end, and closed by a hollow hemisphere at the other. The cylinder is now held near the ring, so as to soften the extreme ends, a hole is blown through its centre, and then as it is rapidly whirled, the centrifugal force acting upon the softened hemisphere, converts it in the first place into a plane, extending across the cylinder at right angles with its sides, and then as the motion is continued, the central perforation increases in size until it suddenly expands to the diameter of the other parts of the cylinder. It is then held perpendicularly a few moments until the glass cools, when it is given to the boy, who, taking it to a wooden support, cracks it from the pipe, by touching the neck with a moistened iron. One other operation is required to complete the cylinder which is called *cappling*. This is done by taking from the pot a small quantity of the fluid glass on an iron rod, and with the assistance of a pair of pincers, it is applied around that end of the cold cylinder that was attached to the pipe. This ignited thread, coming in contact with the unannealed cool glass cracks the cap off, leaving a perfect cylinder. To fit the cylinders for flattening, an ignited iron is drawn repeatedly from end to end, when withdrawing it, and applying the finger moistened, to the part, it cracks through its whole length, in nearly a straight line; they are then securely stowed away for flattening.

*Flattening.*—There are two objects to be accomplished by this process; first, to convert the cylinders into planes, and afterward, to anneal, or temper the glass. The structure intended for this purpose, is divided into three distinct parts. A, the rear or entrance into the flattening oven. B, the

flattening oven, and C, the cooling, or tempering oven. These ovens are prepared for the process, by raising the temperature of the cooling oven, to about 500° Fah. by means of the flue *a*, which communicates with a fire place, and grate below. The oven B is raised to the temperature of ignition, through the flue *b*, while the rear, communicating with this oven, receives heat from it, but in consequence of the arch covering it being much lower than that thrown over the oven, the heat as you proceed from the oven gradually diminishes so that at its entrance, the temperature is less than that of boiling water. The cylinders of glass being unannealed, it is absolutely necessary to prevent their breaking, that the heat should be cautiously applied. This is effectually accomplished, by constructing the rear as above described. Within the rear on its bottom are placed two bars of iron extending its whole length, which is usually about ten feet. When the ovens have been brought to the desired temperature, an iron plate is put over the flue at *a*, closing it entirely; some splinters of wood, are then thrown into the oven, to sustain its heat and give light to the workmen. A boy is now employed, to bring the cylinders and put them in upon the iron bars, in the rear, propelling them successively forward by means of a rod, until the rear is full. A man standing at the opening D, by means of an iron rod, now brings the cylinder which was first put in, upon the stone E; here the temperature is such, that the glass being flexible, is spread out upon the stone. A block of wood attached to another iron rod, is then passed over it, pressing the glass into close contact with the stone. The workman now, with an iron, called the *cropper*, shoves it under the partition, upon another stone, F. It is allowed to remain upon this stone, until it is sufficiently cool to retain its form. A man at G, then removes it to the back part of the oven, where he places it upon its edge in nearly a vertical position—thus each successive cylinder is made to pass through these several steps of the process, and they are eventually packed away together in the annealing oven. When the oven has been filled, the fires are put out and every passage into the ovens is closed with mortar. It is allowed to remain in this situation, a week in winter, and ten days in summer; at this time the oven is opened, and the glass being sufficiently cool to be handled without inconvenience, is taken out and carried to the

cutting room, where it gradually cools to the temperature of the atmosphere.

Perhaps there is nothing connected with this manufacture, that causes so much pleasure and surprise to the spectator, as the facility with which an experienced glass cutter performs his work; but in reality, no mere manual art requires more time and patience to acquire the requisite skill than this. There have been several opinions as to the manner in which the diamond operates, in dividing plates of glass. When a diamond is drawn across a sheet of glass, so as to produce a good cut, the line which it makes is scarcely perceptible, yet the fracture extends through the plate. The cutter judges of the perfection of the cut, rather by the ear than the eye. A peculiar creaking sound is produced when it is perfectly done. If a rough white line is made, accompanied with a tearing sound, you may be sure that the glass is not cut. In this case it would seem, that the fracture, instead of descending vertically from the point of the diamond, extends laterally from it and returns again to the surface, separating minute fragments of the glass which are conchoidal. In selecting diamonds, I prefer those that are perfect, with triangular rhomboidal faces, the edges not strait but slightly convex, either octahedrons or dodecahedrons. The peculiar delicacy required in the cutting edge of the diamond, is such, that by constant use, (although so very hard,) it is soon destroyed, and this difference is so slight, that to the eye it appears perfect.

Cylinder glass as usually met with, is far inferior to crown glass. Some of its imperfections are necessarily connected with the manner in which it is made, and cannot be entirely obviated. Others there are remediable, with due care and skill.

The inferior lustre or polish, the irregular reflection of light from its surface, and the slight abrasions and scratches, which are perceptible, more or less, upon all specimens of this kind of glass, belong to the class of inevitable evils; most of these however, can be greatly mitigated, by peculiar management and care.

The inferior lustre, is occasioned, by the necessity of heating the glass again, in the process of flattening. Should the temperature be raised no higher than is absolutely necessary to render the glass flexible, the diminution of the lustre would be so slight, as to be scarcely perceptible: but in con-

sequence of an increased heat accelerating the operation, the workmen are tempted to employ it. It is probable this increased heat volatilizes the alkali from the immediate surface of the glass, and thus the silex deprived of its solvent, causes the dimness. The same effect is produced, as it is well known, by a long exposure of window glass to the weather, and is exhibited in a remarkable degree, upon fragments of glass which are left for months in the flattening ovens, which become perfectly opaque, resembling pieces of porcelain.

The imperfect reflection is caused by the impossibility of bringing the sheet of glass, into perfect contact with the stone, in consequence of air and dust getting between them. As the ovens are now constructed, the utmost care will not wholly prevent it. The slight scratches are produced by shoving the sheet from one stone to the other. These may be prevented in the following manner. A sheet of glass is made very thick, from one fourth to one third of an inch. This is placed upon the flattening stone, and the cylinder is brought upon it and flattened. Both sheets are then shoved down upon the other stone, the upper sheet is removed, and the thick one which is called a *legger*, returned to the flattening stone to receive another. All the glass which is called imitation crown, is flattened in this manner; and where all the above precautions are taken, it is nearly equal in quality to crown glass, while it possesses the superior advantage of being thicker.

Imperfect as we commonly find cylinder glass, still its low price, (being but about one half that of crown,) insures for it an immense market, particularly in those parts of our country, where the inhabitants, having cleared their farms, are changing their residence from the rude log cabin, to a more comfortable frame dwelling. In the state of New York there are at this time, no less than eight cylinder glass houses, which together throw into the market from sixty to seventy thousand boxes annually. Indeed at the present moment the domestic competition is so great, that it has reduced the price in twelve years, two thirds. It now bears but about the same value as the amount of the duty imposed upon its importation by government; of course it has entirely excluded the foreign cylinder glass from our market. I believe there is at present but one establishment in our country, for manufacturing crown glass, and that is at or near Boston. This I under-

stand has been hitherto conducted profitably, although their fuel costs four times as much as it would in many other parts of the country. Why, considering our national spirit of enterprise, the many inducements arising out of our peculiar situation, together with the remarkable, local advantages, which we undoubtedly possess for carrying on this manufacture, should not have produced corresponding investments of capital, is mysterious and unaccountable. It would certainly be very desirable if we could be wholly independent of other countries for this necessary and beautiful article.

---

ART. XVI.—*Polar Explorations.*

(Communicated for this Journal.)

THE attempt to obtain a North West passage to the Indies, has been prosecuted with a zeal far surpassing that which turned the commerce of Europe round the Cape of Good Hope from the wearisome overland journeys through the deserts of Syria and Persia, or from the shifting and dangerous navigation of the Levant and Red Sea, by the way of Egypt.

The adventurous spirit awakened by the improvements in nautical science, suggested as early as 1527, the idea of a passage to the East Indies through the Polar sea. The attempt to discover it was first conceived by Robert Thorne,\* a merchant of Bristol, who submitted proposals to that effect to Henry 8th and to the Emperor Charles 5th, and it is supposed probable that Sir Martin Frobisher's attempt to find a North West passage, was in consequence of those representations, although no aid was extended to him by either of those sovereigns. He did not penetrate above 62° N. lat. where he discovered the strait which bears his name.

Mr. Thorne's opinion of the probable success of such an enterprise, was founded upon the great advantage of constant daylight for a length of time sufficient to accomplish the voyage, and from a belief that a perpetual sun would warm those regions, so as to give an open sea from the arctic circle to the pole.

---

\* Hackluyt.

By subsequent voyagers it was imagined, that by crossing the pole, either in a North West or a North East direction, the distance to the Indies would be curtailed, thus giving them the precious commodities of those golden regions, without the long, and then difficult voyage around the Cape of Good Hope.

A North East passage was attempted in 1553 by Sir Hugh Willoughby, who commanded "a fleet of three ships, with pinnaces and boats," equipped and furnished by the "*Company of Merchants Adventurers of London*." At *North Cape* one of the ships left the fleet and returned home. Being separated from the other he proceeded north, until forced by the severity of the weather into a river of Lapland, the ship was frozen up, and he with his ship's company all perished. The notes of his voyage, and his last will, were found lying before him, by which it appears that they lived until January; and it is affecting to observe, that three different companies were despatched in various directions, but after four days journey they returned to the ship, "without finding any people, or any similitude of a habitation."\*

His consort, the *Edward Bonaventure*, commanded by Sir Richard Chancellor, pursued a North East course until they found themselves "in a sea where there was no night;" and at length followed some natives in a fishing boat, into a deep bay, to "St. Michaels, the ARCHANGEL." On learning that this port belonged to Russia, Sir Richard left the ship and proceeded on sledges to Moscow, where he obtained letters from Czar John Bazilowitz to Edward VI, and procured some important commercial privileges for the English merchants.

In 1585, Davies discovered *Cape Desolation*, on the west coast of Greenland, and the strait called by his name.

In 1607, Sir Henry Hudson was sent by some London merchants to "attempt a passage by the North Pole to Japan and China." In this voyage he discovered Spitzbergen, and reached the 80° North lat.; but being stopped by the ice from the north, he concludes that "a passage to China is unattainable in these parts." In the following year he was further employed in a voyage of North East discovery.

In 1609, the *Muscovy Company* despatched Jonas Poole to make discoveries; who after examining the south and west

---

\* Voyage of Sir Hugh Willoughby, Pinkerton's Coll. p. 15.

coasts of Spitzbergen, was unable to proceed beyond 79° 50'. He was further employed in 1611, but after surmounting numberless difficulties, lost his ship at Spitzbergen. In 1514, 15, Baffin and Fotherby were equally unsuccessful.

The Russians and Dutch had not slumbered upon a subject so interesting to commerce, and among many unavailing attempts during a century, the celebrated Dutch navigator Wm. Barentz succeeded so far as to winter in 1596, in Nova Zembla N. 70° 20', which had already been visited by Burchough, master of a pinnace belonging to Sir Hugh Willoughby's fleet.\*

Several fruitless attempts were made by successive adventurers, who never could succeed in doubling a cape which sets far into the frozen ocean beyond the most eastern branch of the *Lena*. Of the parties embarked in these expeditions some were shipwrecked—and others killed by savages—while a few escaping settled in Kamschatka.

After the Dukes of Russia had acquired the throne and title of the Tartar Czars, many enterprising individuals pushed their discoveries to the north and east.† They soon found the metallic treasures of the Uralian and other mountains, but those who survived the rigor of the climate of the arctic circle, reported the existence of enormous rivers under masses of ice, pursuing their dreary way to the frozen ocean, and of fossil islands formed near their mouths by the accumulation of animal remains,—but no new facilities for passing through those seas to the Pacific Ocean.

Thus far, private effort had achieved all that had been done. M. Cuvier asserts that “Peter the Great was the first monarch who conceived those scientific expeditions, which England and France have since carried to their greatest perfection.” In 1715 the Cossack Markoff, accompanied by nine persons, was sent by the Russian government, “to explore the North Sea.” Finding the ocean impracticable, he resorted to sledges drawn by dogs, and left the shores of Siberia under the 71st degree of N. lat. They proceeded north for seven days, when the ice mountains became impassable. He ascended the highest, but could perceive nothing except interminable ice, and having consumed his provisions was compelled to return, which he effected with difficulty, some of his dogs having perished.

---

\* Hackluyt, Vol. 1. p. 274.

† Ed. New Phil. Mag.



In 1744, the British parliament passed an act to encourage the discovery of a North West passage, and Capt. Cook proceeded to the North West coast of America, and ascertained its proximity to Asia, but adopted the opinions of preceding navigators, that no passage could be effected in that hemisphere between the Atlantic and Pacific Oceans.

We pass over many private adventures of intense interest, and many records of suffering, in vain endeavors to extend that part of geographical science connected with the pole, and come to the date of George the 3d, who upon ascending the throne, was eager to promote those discoveries, which might tend to the advancement of knowledge and commerce. Among other plans for this purpose he lent a ready ear to the proposition from the Royal Society, through Lord Sandwich, for navigating the polar seas, and in 1773, directed a voyage to be undertaken under the command of Capt. Phipps, afterwards Lord Mulgrave. This intrepid navigator forced his way to  $80^{\circ} 37'$  north, but could proceed no further, being opposed by "one unbroken plain of ice bounded only by the horizon."

In 1789, Sir Alexander McKenzie discovered the river which bears his name, and followed its course to the frozen ocean, where it discharges its waters in  $69^{\circ} 30' N. 135^{\circ} W.$

Many bold navigators have expressed the opinion that a North West passage is impracticable; yet the English councils seem to have been actuated by the spirit of Lord Bacon, who says, "regarding impossibility, I take it those things are to be held possible, which may be done by some persons though not by every one; and which may be done by public designation, though not by private endeavor; and which may be done in succession of ages, though not within the hour glass of one man's life." Not discouraged by former failures they have fitted out expedition after expedition—science has tasked its power, and art has exercised its most ingenious devices to aid the endeavour—the most daring spirits—the most determined courage—the most patient industry, fortified by a religious confidence in divine superintendence and protection, have been enlisted in this magnificent enterprise. Parties by land, and ships by sea, furnished with every thing that could favour their success, have been employed to push those discoveries which are wanting to complete the survey of the arctic circle.

For this purpose, in 1818 the *Isabella* and *Alexander* attempted to penetrate to the west coast of Baffin's Bay.

In 1819, two expeditions were ordered, one by land under the direction of Capt. Franklin of the royal navy, and the other by sea under the command of Capt. Parry. Capt. Franklin was instructed to proceed to the mouth of the *Coppermine River* (discovered in 1771 by Mr. Hearne) which falls into the arctic sea in  $69^{\circ}$  N.  $110^{\circ}$  W. and thence to navigate the coast of that sea east, if possible, until it washes the north eastern shores of America.

Capt. Parry was placed in command of two ships, the *Hecla* and *Griper*, which were strengthened in every possible way to adapt them to such a perilous service. The number of men amounted to ninety four, including Capt. Sabine, astronomer to the expedition, and the officers of both ships. They were munificently provided with every thing to defend them from the rigors of the climate, with provisions and stores for two years, and a large supply of preserved fresh meats in tin cases, lemon juice, sour kroust, and other approved anti-scorbutics. They were furnished with philosophical instruments, and numerous presents to conciliate any savages with whom they might fall in, or to procure further supplies. Nothing was omitted that might contribute to the success of the enterprise, or to the health and comfort of those engaged in it.

In May the ships left England, and arrived on the 18th of June at the margin of the icy barrier which is perpetual in the centre of Baffin's Bay. This immense body of ice consisting of detached masses of all dimensions, closely packed together, is from eighty to one hundred and fifty miles in breadth. The swelling of the sea, the shifting of the wind, and perhaps the force of unknown currents, are continually changing the position of the pieces, occasionally opening lanes of water, and as quickly closing them, sometimes permitting the ships an unobstructed passage of a hundred yards, and then requiring as many hours to make half the distance. By availing themselves of these openings, and by sawing passages through immovable floes, also by pushing the ships through the ice whenever it was much broken, these daring navigators crossed this extraordinary barrier in forty one days. This was not effected without the most imminent perils. They were repeatedly beset, and the roll of the sea often forced the heavy ice against the rudder with such violence, as to threaten the ships, strengthened as they were, with instant destruction.

On the 29th of July they found themselves in a clear sea, in  $73^{\circ} 51'$  N. lat.  $67^{\circ} 47'$  W. long. and no bottom with three hundred and ten fathoms of line. As the wind freshened the ice disappeared, and they seemed to have arrived at the head quarters of the whales, eighty two having been seen in one day. They made good progress due west in lat.  $74^{\circ}$  meeting with no obstruction from the ice, and were sanguine in the belief that they had found the passage to the polar sea; but on the 6th of August, land was discovered ahead, which proved to be the first of a group of islands, commencing in lat.  $74^{\circ} 39'$  N. on the north west side of Baffin's Bay. They were named the *North Georgian Islands*, by Capt. Parry. Their geognostical character, and their animal and vegetable productions were minutely examined, and their precise latitude and longitude were ascertained, with a due attention to every object interesting to science.

On the 4th of September the expedition reached the 110th degree of west longitude, and thus became entitled to the reward of five thousand pounds, ordered by his majesty for such of his subjects as should penetrate thus far within the arctic circle. The hope of pressing forward through this opening into the polar ocean direct to Bhering's strait, exhilarated every individual with the most animating anticipations: and in imagination they had already obtained the great object which had interested the world for nearly three centuries, and in which more than forty expeditions had failed. But the ice soon arrested their progress, and the rapid advance of winter compelled them to seek a harbor for their ships. At *Melville Island*, the most western of the *North Georgian* cluster, they established their winter quarters, by sawing a channel for the ships through the ice, in many parts eight feet thick, two miles and a half round, into a sheltered anchorage, which Capt. Parry named *Winter Harbor*; where they were to remain during the long darkness of the polar night. This was in  $74^{\circ}$  N. lat. and  $112^{\circ}$  W. long. After their recent escapes and dangers, they rejoiced in their present security and in an intermission from anxiety and fatigue.

The officers were now diligently engaged in arranging every thing which could conduce to their own and the people's comfort. An observatory was erected on the ice, for astronomical purposes, and a snow house for magnetic observations. Divine service was performed upon the sabbath, evening schools were established to instruct the men in read-

ing, writing and arithmetic, and theatrical amusements to cheer their spirits.

The methods adopted for warming and ventilating the ships, the regulations relative to food, fuel, clothing and exercise, the religious order and the exact discipline which prevailed, are subjects of interest and admiration; and the details are of the highest value to succeeding adventurers.

On the 16th of October the sun was seen for the last time during four months, the rein deer took their departure over the ice for the continent of America, the birds had long since flown to other climates, the Esquimaux had retreated south, and the only living things left to dispute the dominion of these frigid regions, were a few white wolves and arctic foxes. When the sky was clear, the glowing twilight in the edge of the southern horizon at noon, with the moon light and the dazzling whiteness of the snow, prevented that deep darkness, during a considerable part of the winter, which would be naturally anticipated. But in walking when the weather would allow, the "permitted two miles, to the summit of the hills," the scene was calculated to inspire involuntary sadness. Not an object was to be seen, not a rock or a shrub, not even a wolf or a fox; nothing but the smoke from the ships interrupted the view of an endless waste of snow. The cold was severe, and in storms it was impossible to pass even from one ship to the other. The whole was a scene of indescribable sublimity and grandeur. The darkness and silence, and cold brooding over creation were apt similitudes of that primeval state, when the Almighty said "Let there be light."

Capt. Parry and his associates were in a situation to contemplate it with awe and admiration. But to Capt. Franklin the season was arrayed in tenfold terrors. No sublime emotions consoled him and his officers. Their people lying dead of famine around them; themselves reduced by fatigue, and cold, and want, to skeletons; dizzy and weak; sleeping on the ground without shelter; without food or fire, and the snow drifting over them: to them the darkness and desolation of the scene were replete with revolting horrors.

Capt. Franklin left England accompanied by three officers, with instructions from the government to the Hudson's Bay and North West companies, to furnish him with guides, boatmen, canoes, provisions, stores, and every facility for which he should make a requisition. The party traversed

the country between *York Factory* on the west coast of Hudson's Bay to *Fort Chippewyau*, one of the company's stations in N. lat. 59, W. long. 110, where they were obliged to stop for the winter, in 1819; and before they could start for the sea, were again compelled to take up winter quarters at *Fort Enterprise*, in 1820. From this place they commenced their northern journey, in 1821, with seventeen Canadian voyageurs, two interpreters, and two English attendants, twenty eight in all, including officers. Their supplies were slender, for provisions were scarce; but had they been plentiful, the expedition had no means of transporting them, as the only practicable mode of travelling was in bark canoes or on foot, over a difficult country. The rivers abounded in dangerous rapids, which rendered the labor of carrying their canoes and baggage over the portages, intolerably fatiguing, and they were therefore compelled to rely upon Indian hunters for meat.

The party arrived at the mouth of the *Coppermine river*, a distance of three hundred and thirty-four miles from *Fort Enterprise*, on the 18th of July, after suffering much from hardships, accidents and want of provisions. The Indian hunters now left them, and Capt. Franklin proceeded to navigate the sea east of the *Coppermine*, with his Canadian voyageurs, to whom the scene was fearfully new, they having been only fresh water navigators. After pursuing an easterly course for six and a half degrees, Capt. Franklin regretted extremely that the scarcity of provisions, and the advanced season of the year, would not permit his pushing on towards Hudson's Bay, where, he fully believed, from the trending of the coast, there was a communication with the Polar Sea; but circumstanced as he was, he was obliged to obtain winter quarters if possible among the Esquimaux near the coast, or hasten his return to *Fort Enterprise*. As they could find no sign of any Esquimaux, they had no alternative but to return, as the country was a barren desert, destitute of fuel, and nearly so of animals, for the men could not by their utmost exertions, procure half a supply of meat or fish. Their return to *Fort Enterprise*, was marked by a series of unparalleled distresses. Several of the people died of want, having often been without food for many days in succession. A little moss scraped from under the snow was their only dependence, and large tracts occurred, where even that was not to be found. The shocking details of

their sufferings need not be here repeated. Those who survived were reduced to the extreme of debility and wretchedness. On reaching the fort they found it in ruins, but were assisted by some Indians to a station of one of the trading companies, from whence they terminated a journey of five thousand five hundred miles, at *York Factory*, in Hudson's Bay, in July, 1821.

After being ten months locked up by the ice in Winter harbor, Capt. Parry, in July, succeeded in extricating his ships and spent the remaining time until September, in fruitless efforts to obtain a passage through the shoreless ice on the western margin of Baffin. Finding their exertions ineffectual, and another winter at hand, they returned to England in 1820.

In 1821, the *Hecla* and *Fury*, of the R. N. were put in commission, and Capt. Parry commanded, to renew the search for a North West passage through Hudson's Bay. The ships were fitted and equipped as before, with every addition suggested by experience. The principal improvement was that of having *the ships of equal size, an advantage* repeatedly noticed by Capt. Parry, *as being of the first importance*.

The expedition arrived in *Repulse Bay* in August, hoping to find a passage through that inlet, but after a minute examination the land was found continuous around it, thus settling the question which had excited particular interest respecting that quarter. Agreeably to their official instructions, the expedition proceeded north, exploring every bend and inlet on the western coast of Hudson's Bay, by boats and walking parties, and found a continuous coast as far as 66° N. lat. The ice and cold increasing, presented insurmountable obstacles to further progress, and by the first of October they were compelled to go into winter quarters. Their occupations and regulations were similar to those that existed during the winter at Melville Island. The cold was equally intense, being at 55° below zero on the 15th of February. The spring did not commence any earlier, and in the following July they were necessitated to saw a passage to release the ships. The Esquimaux were more numerous than at Melville Island, as were the wolves, foxes and bears.

After leaving winter quarters, the most daring attempts were made on the line of coast north, to achieve the object of their voyage. The ships were often in the greatest dan-

ger of being crushed, being beset by immense fields of ice, and once the *Fury* was near shipwreck. The expedition persisted in ineffectual efforts, until again compelled to retire to winter quarters in September, "satisfied that no navigable passage existed for ships in that quarter."

The whole progress made during the summer of 1822 was only 3° north, and that had been accomplished principally by mere drifting, while the ships were beset by the ice. An artificial harbor was made near the land by sawing the ice, and the ships once more frozen up for the winter. At this date, Capt. Parry remarks that, "flattering as were our prospects at the commencement of the past summer, little satisfaction remained at the close of the season, but the consciousness of having left no means untried that could promote our object."

The ships remained bound in fast ice until August, the latter part of which month concludes the Polar summer. They were so immovably fixed, that, had it not been for the skill and industry exerted in sawing the ships out, their fate must have been like that of Eric and his colony in lost Greenland, and no one would have escaped to relate their story.\*

Although they had hitherto enjoyed almost uninterrupted health, scorbutic indications now began to appear, owing to the nature of the service, which exposed them to a great deal of wading in water, at or near the freezing point, and to sudden changes of temperature in passing to and from the warmth of the interior of the ships, to the excessive cold without; among the causes of disease, should be mentioned also, the want of fresh vegetables, the gloom and monotony of their daily prospect, and the absence of those exciting causes, which exhilarate and cheer the spirits. A little sorrel, and an occasional blade of meagre cochlearia or scurvy grass, were almost the only vegetables yielded by the sterile soil. Of these, the little obtained were of essential service to the indisposed. There remained no further service to be performed in this season, as it was now time to provide for the coming winter, and upon weighing these considerations it was determined to return to England. Before coming to this conclusion, Capt. Parry observes, that, "as the sun went down, we obtained from the mast head a distinct view in that quarter, and it is impossible to conceive a more hopeless prospect. One vast

---

\* Crantz, Greenland.

expanse of level solid ice occupied the whole extent of sea to the westward, and the eye wearied itself in vain to discover a single break upon its surface."

In 1824 the *Hecla* and *Fury*, were again ordered to sea, under the command of Capt. Parry, to make further examinations respecting the northern boundary of the American continent, and a passage to the Pacific Ocean. They left England in May, but were eight weeks in crossing the icy barrier in the center of Baffin's Bay, by which delay the most valuable part of the summer was lost, to the main purpose of the expedition. It was not until the 8th of Oct. that they cleared the ice, in 72° W. lon. and 74° N. lat. This extraordinary barrier was fifty leagues broader than when they passed it in 1819, owing probably to the severe winter, and the tardy summer of 1823 and 1824. They had to dread even the possibility of being frozen up for the winter, in the middle of Baffin's Bay. It startles one's imagination, to contemplate two ships in the midst of three hundred leagues of ice, surrounded by mountains towering high above the masts; huge floes of several miles in diameter, with smaller pieces of all dimensions, driving into packs by currents, and dashing and shoving by the roll of the sea. In this condition the skill of the officers seemed unavailing, and the physical strength of the men impotent, but by the aid of divine protection, they were in this, as in many other instances, in this precarious and perilous navigation, rendered effectual to their preservation.

They had only reached the site proper for the commencement of their operations when it was again time to secure quarters for the winter. This was deferred to the last possible moment; and every measure was adopted to effect their purpose, such as "sallying,"\* sawing, and rushing through broken ice under a press of sail. After great fatigue and difficulty they reached *Port Bowen* in Prince Regent's inlet, on the western side of Baffin's Bay, on the 26th of September. The labor of sawing out a basin for the accommodation of the ships, in ice of great depth, was again to be encountered, and on the 1st of October, they were happy to warp their ships into their winter stations. Their arrangements were even more complete than in preceding years; especially in an improved method of warming and drying the ships. The

---

\* "Sallying" is the running of the men suddenly from one side of the ship to the other to break the new ice by the rocking of the vessel.



temperature for one hundred and thirty one successive days, was below zero.

The latitude of the observatory at Port Bowen is  $73^{\circ} 13'$ . This winter passed like those which preceded it; the officers were equally attentive to the regulations established on board the ships, and equally diligent in scientific collections and observations. Their amusements and occupations had not now the merit of novelty, but were in some degree analogous to the season.

Less of animal life was seen at this station, than at any one visited by the expedition. Capt. Parry observes that "the presence of man seemed an intrusion on that dreary solitude which even its native animals had forsaken." No Esquimaux appeared, for days together; except a single seal, or sea horse, no animal was visible on this coast.

After sawing a channel for the release of the ships, they found themselves on the 19th of July, once more at liberty. The remainder of the season was devoted to the same untiring efforts to push their way, as on former summers, but the relentless opposition of the ice, rendered their exertions of little value. In the latter part of August the *Fury* was shipwrecked, and after transferring the men, and as many stores as could be received on board the *Hecla*, Capt. Parry found it necessary to return to England.

Upon the subject of that catastrophe, this undaunted commander remarks, that it was not an event to excite surprise in the minds of those acquainted with the true nature of this kind of navigation. To any thus qualified to judge, it is plain that an occurrence of this kind, was rather to be expected than otherwise. Our previous exemption from serious damage had induced the erroneous notion, that our ships were proof against any pressure from the ice. I confess, that though a moment's reflection would contradict such a notion, I often felt a degree of confidence in their strength, too nearly approaching to presumption. While we trust that it will appear that our own endeavours have never been wanting to preserve the ships committed to our charge, we also feel and acknowledge that it has not been "our own arm" nor "our own strength" to "which we have so long owed their preservation."

Capt. Parry does not despair of the North West passage, but believes "it will be ultimately accomplished," and adds, "I shall be happy if my labours as pioneer shall contribute

to the success of some more fortunate individual, but most happy should I be, to be selected as that individual." The uniformly obliging and friendly manners of his associates, and the courage and willing obedience of the men, are themes to which he frequently recurs with pleasure; and when it is remembered that this series of service was rendered in eight successive years, amidst severe trials, dangers, and disappointments, the eulogium forms no common praise.

Undismayed by former dangers and sufferings, Capt. Franklin in 1825, accepted from the government a second appointment, to explore his way to the Polar Sea.

This party consisted of Capt. Franklin, and three other officers, twenty four Englishmen, two Canadians, and two Esquimaux.

The officers went by way of New York to Lake Superior, and about four or five days march from Mathye portage, overtook their boats and crews, which had left England eight months before them.

They proceeded directly to the junction of the *Bear Lake* river with the *McKenzie* in  $65^{\circ}$  N. lat. and  $123^{\circ}$  W. long. After leaving a sufficient number of men at this place to prepare a house (called *Fort Franklin*,) and other accommodations for the winter, Capt. Franklin with the remainder of the party, in four small boats, proceeded to the sea coast, going down the *McKenzie* to its mouth, where its numerous branches form a large delta of alluvion, enclosing several islands in its various reaches.

They discovered an island thirty miles north of the *Whale Island* of *McKenzie*, which Capt. Franklin named *Garry*, in N. lat.  $69^{\circ}$  and  $135^{\circ}$  W. long. On this island were layers of wood coal, beside a bituminous liquid tricking down the cliffs. It was covered with shrubby plants and thin grasses and mosses, and on the beach were pebbles of granite, quartz, and Lydian stone. The fibrous structure and the twisted state of the woody layers were easily traced in the coal, and several impressions of seed and ferns were observed.

They hastened to rejoin their companions at winter quarters, and arrived at *Fort Franklin* on the 5th of September. This winter although they were straitened for provisions, was still comparatively comfortable. Divine service was regularly attended on Sundays, and the same attention paid to the comfort and improvement of the men, as was practised on board the ships, commanded by Capt. Parry. Capt. Frank-

lin frequently remarks that "the conduct of the men was a striking exemplification of the character of British seamen, for courage, resolution, patience, obedience, and ambition to achieve their purpose."<sup>\*</sup>

The greatest degree of cold was on the 1st of Jan. 49° below zero. In May the spring began to dawn, swans and geese arrived; on the 16th mosses began to sprout, on the 1st of June the dwarf birch and willow, were in leaf, and anemonies and Lapland roses were in flower.

On the 15th the equipments were ready, and the expedition proceeded in four row boats to the mouth of the McKenzie. Capt. Franklin detached Dr. Richardson, surgeon to the expedition, and Mr. Kendal, with a party in two boats, to survey the coast eastward, towards the *Coppermine river*, while he himself and the remainder of the expedition, directed their course westward towards *Icy-Cape*. Capt. Franklin discovered *two large rivers issuing from between different ranges of the Rocky Mountains*, bringing down large quantities of drift wood, which are carried by currents and eddies to remote parts of the coast, and to distant islands.

On the 10th of August, they had attained nearly 150° W. long. and were nearer to *Icy-Cape* than to the *McKenzie*. Their progress, from the nature of the coast, which was muddy and shallow, with naked, sandy, and gravelly reefs, projecting among the ice had been hazardous, and extremely laborious. It cost them nearly a month to push through occasional openings, and it was not until August, that they obtained a clear passage. On one of those naked reefs, they were detained for eight days. They suffered much for want of fresh water, and in one instance were without any for forty eight hours. It is not intended in this paper to eulogise the travellers in the various expeditions under notice; but to show very briefly some of the results of their labors; in this instance however we can scarcely forbear the expression of astonishment and admiration, at the zeal and perseverance of these adventurers.

Vast floes of ice now came down upon them from the North, with evidences of the rapid approach of winter; and it was with great reluctance that Capt. Franklin relinquished

---

\* That no part of the experience of the several expeditions by sea, may be lost in any future attempts of the same kind in either hemisphere, Capt. Parry is preparing a book of minute directions, for the entire equipment of ships employed in similar service.

his favorite object, that of welcoming Capt. Beechy to the Polar Sea. That officer in command of the *Blossom*, had been ordered to wait for him at Kotzebue's Inlet, after passing through Bhering's Strait from the Pacific.

But the brief summer permitted no further progress, and Capt. Franklin turned his course towards Fort Franklin, after tracing "three hundred and seventy four miles of coast from the mouth of the McKenzie, without discovering one inlet or harbor, where a ship could find shelter; the most miserable, dreary and uninteresting coast in any part of the world."

They experienced violent storms, and met with hostile Esquimaux several times on their return, but reached Fort Franklin in safety, where the detachment under Dr. Richardson had previously arrived after a successful voyage of five hundred miles east, to the mouth of the Coppermine river.

Although geographical discovery was the primary object of the enterprise, the officers omitted no opportunity to collect materials, and make observations connected with science. An example of extraordinary scientific devotion occurred in Mr. Drummond, assistant botanist. This indefatigable enthusiast, voluntarily spent a winter alone in the recesses of the Rocky Mountains, sheltered from the inclemency of the weather only by a hut made of the branches of trees. In this situation he depended for subsistence from day to day on an Indian hunter, and being without books he had no means of abating the dreariness of his solitude, except an occasional lonely walk, on wooden shoes, over the untracked deserts of snow, in pursuit of the objects connected with his favorite science.

The greatest degree of cold, experienced this winter, was on the 7th of February, when it was  $58^{\circ}$  below zero, the lowest temperature which has been at any time observed in the Hyperborean regions.

The painful and dangerous journeys conducted by Capt. Franklin have yielded valuable contributions to science, and enlarged the boundaries of geographical knowledge. The survey of thirteen hundred miles, being within eleven degrees of Icy-Cape on the west, and about four hundred and seventy from Melville peninsula on the east, with the trending of the coasts towards those points, lead to the belief of a continuous land shore on the American continent, stretching from Bhering's strait to Baffin's Bay, where there is a probable communication under the ice of those frozen seas between the Pacific and Atlantic Oceans.

The remarkable enterprise of attempting to travel over the ice to the north pole, was undertaken by Capt. Parry, under the auspices of the Lords of the Admiralty in 1827.

He embarked in the *Hecla*, already famous in the annals of arctic discovery, with a crew and officers accustomed to braving the storms and ice of the north, and proceeded to Spitzbergen, where after encountering many obstructions, and delays from the ice, the *Hecla* was placed in a secure harbor of that island.

On the 21st of June, Capt. Parry left the ship accompanied by four officers, in two boats with sufficient crews, and crossed a strip of open sea north east of Spitzbergen, a distance of forty miles, where they commenced their journey over the ice. The boats were fitted with runners to be drawn by the men as sledges, or should they meet with open passages of water to be crossed with paddles and oars. They took provisions for seventy-one days, of the most portable and nutritious kinds, which with the boats, clothing, utensils, and other necessaries made up a weight equal to 200 lbs. for each man. The ice proved very "hummocky" and broken, and was so covered with sludge, and deep snow, as to make the travelling excessively fatiguing and uncomfortable: added to these impediments, lanes of water were of frequent occurrence, occasioning the necessity of launching the boats, and again hauling them up six or eight times, and in one instance seventeen times in one day. The surface was so rough and deep, that the united strength of officers and men could not in every instance transport the boats and baggage, but after conveying a part, they were obliged to return for the remainder until the whole was removed. Capt. Parry and Lieut. Ross preceded the rest to select the best routes. The sledges having been conveyed as far as they had explored, they all returned for the residue of baggage, generally traversing, for the first fortnight, the same road four and five times over, before they could effect the entire transportation of their boats and stores. The whole journey was performed and completed in boots and stockings, thoroughly wet to the knees with snow water. At night, if such it could be called where the sun did not set, the largest surface of ice was selected—the boats hauled up and placed alongside, and an awning made of the sails supported by three paddles, and the bamboo masts. Under this shelter they exchanged their wet clothes for their fur sleeping

dresses, dry stockings and fur boots—ate their slender supper—prepared for the next day's journey—the men smoked their pipes and told stories, and the labors of the day were forgotten. A regular watch was set to look out for any moving or breaking up of the ice, and to attend to drying, as far as possible, the wet clothes. They travelled ten hours, allowing one hour for dinner, and employed the night, generally, for walking, and the day for sleep, for although the sun was all the time apparent, its effects were very different when it was highest in the heavens. The light was then more dazzling—the sludge and water were deeper on the surface of the ice, while by night the snow was somewhat harder for travelling, although there was not a great variation in the temperature during the twenty-four hours. The day was concluded with prayers, and sleep was obtained with a degree of comfort that could scarcely be believed possible. After sleeping seven hours, the man appointed to prepare the breakfast, “roused them by the sound of the bugle.” The allowance for each man per day was 11 oz. biscuit—9 oz. pemmican\*—sweetened cocoa powder sufficient for one pint—rum, one gill—and 3 oz. tobacco for one week. Two pints of spirits of wine was the daily allowance of fuel, which placed in a shallow lamp with seven wicks, served to boil the cocoa, and warm and dry in a slight degree, the interior, covered by the awnings. They were drenched with rain a considerable part of the time “not having had so much, all taken together, in the whole seven preceding summers.”

The ice became more and more broken as the season advanced, and they proceeded north. From the “highest hummocks” they sought for some object to rest their eyes upon beside the sea and sky, but the forlorn waste mocked their expectation—not even a bear, or a sea-bird—not even the dangerous dashing of the waves met their view. The only change from this dazzling desolation, was the fogs, and rains, which obscured the extent of their solitude.

Their way lay often among loose pieces of ice, from five to twenty yards asunder giving all the “trouble of launching and hauling up the boats, without making any progress by water.” In narrow openings where it could be effected, a bridge was made of the boats from mass to mass, over which the men and baggage passed. The snow was three feet deep

---

\* Meat dried and powdered fine, and packed very closely.

near the "hummocks," and it was difficult to get a footing sufficient, to enable one leg to extricate the other; but the average depth of snow was five inches over four or five of water, besides many pools too deep to wade through. In one instance, they were two hours in proceeding one hundred yards, and to accomplish two miles north, they were under the necessity of walking three or four. "If any thing could compensate for this delay" says Capt. Parry, "it would have been the beautiful blue color of these superglacial lakes, which is one of the most pleasing tints in nature."

In defiance of every difficulty, they continued to push forward towards the north, but the quantity of rain which fell, became more and more excessive, and finally, to their utter confusion, they discovered the set of the arctic waters south, drifting them faster from, than their exertions brought them nearer to the pole. On the 15th July, "the rain fell in torrents," and the temperature was warmer than had been known in the arctic regions. The 26th of July, made thirty-five days since they began the journey; a north wind accelerated the drift to the south, and Capt. Parry determined to abandon the undertaking. They had reached the  $82^{\circ} 45'$  N. latitude, and found they had made only one hundred and seventy-two miles, distant from the *Hecla*, in a north,  $8^{\circ}$  east direction. To accomplish this distance, they had travelled six hundred sixty-eight statute miles—nearly sufficient in a direct line to have reached the pole.

The party had enjoyed good health up to this period, but it was visible to the officers that the strength of the men had begun to decline, their allowance of food being insufficient to support men, living constantly in the open air, exposed to wet and cold, and "seldom enjoying the luxury of a warm meal."

Their return to the ship was more arduous than their outward journey, but on the 11th of August, they began to hear "the swell of the sea under the hollow margin of the ice," and soon launched their boats in the open ocean, having been upon the ice forty-eight days. They first landed upon a rocky islet the most northern land known upon the globe, where they left some provisions on their outward journey. Leaving this, they were defeated by a storm in an attempt to land on Walden island,\* where they also left provisions,

---

\* Discovered by Com. Phipps, August 5th, 1773, N. lat.  $80^{\circ} 37'$ .

and came near perishing, having been fifty-six hours without rest, and forty-eight at work in the boats. "We noticed, says Capt. Parry, that the men had that wildness in their looks, which usually accompanies cold and excessive fatigue, and though as willing as ever to obey orders, seemed destitute of the power to comprehend them."

Upon the subject of reaching the pole, Capt. Parry is of opinion, that it will be found of more difficult attainment than has been anticipated. He can suggest no improvement in the mode of travelling which he adopted, and is of opinion, that dogs and rein deer would have been an incumbrance in many of the passages, when the ingenuity of man, and the powerful exercise of human reason, were more essential than physical strength.

The confidence of reaching the Pole in this manner is not diminished in the mind of Mr. Scoresby, the original projector of the plan, who thinks the failure of Capt. Parry and his party was owing to the advanced state of the season, and the meridian upon which they travelled; that upon a more western meridian they would have come upon *fast ice*, and thus have avoided the drift south, which carried them back at nearly the same rate, as that by which they travelled forward; that by leaving Spitzbergen in April, they would find the snow hard; the exhalations would not bewilder them in fogs, nor drench them in rains; and that by taking a suitable traineaux of dogs or rein-deer, and providing for the greater degree of cold, which would then prevail, he has no doubt of the success of the enterprise.

Some who have been conversant with those icy tracts imagine them solid and immovable from  $84^{\circ}$  to the Pole;\* and that in the ardor for research, manifested by these bold and persevering explorers, there remains a pledge, that its secrets will yet be revealed. But in considering the laws which regulate the change of seasons, so far as has been observed by man, it appears probable, that in every summer the ice becomes broken, and every where agitated upon the surface of the deep, from  $68^{\circ}$  to the extreme north, except where it is wedged in straits, or piled up, and screened from the sun's rays by sheltering coasts, and defended by eddies or capes from the washing and drifting of currents, and the motion of tides. The observations of the late expeditions under Capt.

---

\* New Edin. Phil. Jour. Dec. 1826. p. 88.



Franklin and Capt. Parry, represent the degree of cold greater at  $68^{\circ}$  on Bear Lake than at Melville Island, or any of the higher latitudes, and it is reasonable to suppose that it may be within a few degrees of the maximum existing in any part of the frigid zone. The sudden waste of ice occurring immediately upon the return of the sun, after four month's darkness, seems to be a provision of nature *to preserve the arctic circle from total congelation*, and to maintain the balance of the waters in their circuit round the earth. If these views are correct, the travelling in summer must always be more or less impeded by fogs and rains, and by sludge and moving ice; and it is a question which can be solved only by experiment, whether a degree of cold sufficient to prevent these impediments, would not be greater than men could sustain, when travelling in the open air. Capt. Parry observed that when the cold was most intense, if there was any wind, it was nearly impossible to walk even a few yards, without freezing instantly; and that being the fact, although no breeze should ruffle the keen air, there would be danger of defeat to the enterprise from the currents, which their progress through it would occasion.

The north coast of Greenland, and one cape on the Asiatic continent, have not been surveyed. If they are united by an isthmus across the pole, a journey on its eastern shores might be undertaken with some prospect of success, provided the cold essential to the continuity of ice, and a hard surface, should not be more severe than could be supported by the travellers.

During the absence of the party on the ice, the officers left in charge of the Hecla were engaged in scientific enquiries, and particularly in investigating the natural history of Spitzbergen.

This island has occupied a place in the minds of men as being all which is imagined of the Pole. It presents little to the traveller but mountains of ice, and vallies covered with eternal snow. No tree or bush clings to the glaciers; the icebergs stand in solitary grandeur; *no sound breaks the awful stillness*, which is a striking characteristic of the arctic regions. It is as though the elements of nature were dead; one vast, trackless, noiseless desert, forsaken by wild beasts, and shunned by men. In the summer, a few bears prowl among the snows, and the reindeer visit it for the mosses, and scanty vegetables which

grow in favored spots, on the margin of the sea. On the eastern side of the island, immense icebergs stand in the ravines like castellated towers, and being of a beautiful green color, diversified by the strata of the cliffs, offer a highly picturesque appearance. While the *Hecla* waited for the party on the ice, the temperature was milder than it had been found in the islands of Baffin's, or the frozen coasts of Hudson's Bay. On the western coast there is a remarkable tract of open sea, where the whalers resort long after the waters in the lower latitudes are frozen. This is attributable to the remnants of the gulph stream, as it sweeps around North Cape, before it is lost in the frozen ocean.

In many particulars, Spitzbergen, Nova Zembla, the North Georgian Islands, and all the coasts and lands discovered beyond the latitude of  $68^{\circ}$  and  $70^{\circ}$  north, bear a stronger resemblance to each other than more southern parallels, where genial seasons, and the assiduities of man, modify their aspects.

The upper surfaces are seldom thawed more than four or five inches, where in favorable spots ranunculi, poppies, mosses, sorrel, and a few grasses make haste to vegetate, and wither almost as soon. The subsoil is almost impenetrably frozen to a great depth, in some instances to fourteen and eighteen feet. The absence of the sun for four months, during which "the bear dozes in his icy cave" or with all other living beings retreats to southern latitudes; the cold, and above all the awful stillness which cannot be realized, without being witnessed, are circumstances common to them all, as are the fogs, and rains, and dazzling sunshine of summer. The winter lasts ten months, leaving but two that can be relied upon for navigating the seas or exploring the coasts.

Spitzbergen, according to Com. Phipps, is in  $79^{\circ} 56'$  N. lat. The south end of the island is formed of high, barren, black rocks, without the least mark of vegetation, the whole island bristled into high peaks, which are in most parts covered with snow "rising above the clouds." In this as in Melville island, when the summer commences, the changes are very rapid. In a week from the time when not a drop of water could be obtained for drinking, without melting snow by the fire, torrents were rushing through the ravines, and the surface full of pools, and streams of water.

Melville island, whose north coast is in lat.  $75^{\circ} 14'$  N. long.  $113^{\circ}$  W. was traversed in various directions by parties from the

expedition which wintered there in 1819. It differs from Spitzbergen in its extensive snow clad plains, with a few hills of moderate altitude; and although the west and south coasts are bold and precipitous, there is not a mountain on the island. Its north coast is entirely barren, and for many leagues no living animal was seen. On the south shores, a few Musk oxen, and Rein deer were seen and the sunny sides of the ravines, and sheltered vallies were covered with sorrel and mosses, and other arctic productions.

They found no Esquimaux, but some ruinous traces of huts were passed, which seemed to have been long forsaken.

It is extremely interesting to observe the gradation of character in the savages, as they recede from the borders of the Arctic Ocean.

The Esquimaux who inhabit the north coast of America, Greenland and the islands between Bhering's strait and the Atlantic—the Lappes—the Samoieds, and the aboriginal Kamschatdales on the European and Asiatic coasts, abating some slight variations, might almost be taken for members of a family, so striking is their resemblance. Their moral elevation is but little above that of the wolves and foxes with whom they divide the scanty spoils of those frozen solitudes. Like them they are engaged in taking their prey, or dozing in their dens.

They are stupid, and gluttonous, and commonly inoffensive. Their harmlessness arises partly from apathy, and partly from a narrow intellect, whose circuit of exercise is limited to the few modes which they have for procuring subsistence, and defending themselves from the cold. The only touch of humane feeling which they appear to possess, is a strong attachment to their children, and the only social virtue, hospitality. Capt. Parry observes that they never appeared so much gratified as when they were permitted to entertain himself, or any of his people at their huts; but they were insensible to gratitude, however great the favor conferred. A little intercourse, with the ship's company, elicited traits of cunning, which showed itself in petty thefts, and a whining, dolorous kind of complaint, designed to excite compassion, and thus to extract further gifts from their benefactors. A considerable number winter in Hudson's Bay, living in snow huts, and feeding upon seals and walrus taken through the ice. The few who pass the summer at Melville island, forsake it with the deer and other animals in October. They remain in one place until

they have consumed or driven away the seals and walruses, when they remove to some other part of the ice, in sledges drawn by wolf dogs, where they stay until compelled by the same cause to seek another station. In summer they obtain fish, rein deer, and a few birds. They sometimes eat their food without cooking, but when not rendered voracious by abstinence, they boil it in a pot made by hollowing out a stone. This is suspended by thongs cut from seal or deer skin attached to a cross bar made of the ribs of animals, over a lamp, which is also scooped out of a stone—filled with seal oil, and lighted by a wick of dry moss rubbed soft between their hands. They procure fire by striking pieces of iron pyrites against each other, over a plat of rubbed moss. Their dress made of the skin of the rein deer with the fur inside, effectually secures them from the rigors of the climate. When they go out, another entire suit with the fur outside is put over all, and a pair of water tight seal skin moccasins, with similar mittens for their hands. A large deep hood serves the double purpose of covering the head, and carrying the children.

The Esquimaux seen by Capt. Franklin, on the McKenzie, were hostile and quarrelsome; traits acquired from the neighboring Indians, who are always at war with them for the means of subsistence. Those near Hudson's strait are more depraved than any seen on this continent, their capacity for mischief and crime, having been rapidly developed by their intercourse with traders and others.

The Greenland Esquimaux treat their women with more severity—the Samoieds are more dull, and the Kamschatdales, if possible, more brutish than any other tribes of the arctic savages, but the similarity which otherwise prevails among them, appears to spring from the sameness of their avocations—the dreariness of their country, and the hardships which benumb their faculties.

The huts of the Esquimaux are superior in ingenuity and neatness to those of the Kamschatdales. The "balaghans" in which the latter slumber away their existence, are dens, or burrows under ground dark with smoke, and exhibiting the consummation of poverty and wretchedness. The snow hut of the former is constructed with a degree of mechanical skill. The sides are built of blocks of hard snow cut in parallelograms, and so adjusted as to form a rotunda with an arched roof. A circular hole in the side filled with a transparent piece of ice, serves for a window, and throws a mild light over the interior, like that seen through ground glass. Upon

squared blocks of snow in different corners stand their stone lamps, and over them the cooking vessels. When supplied with a store for the present day, from the last day's sealing, the hut of the Esquimaux exhibits the summit of their enjoyment. The men sitting around mending their fishing tackle, the women singing their wild songs, and busily engaged in making clothing—sewing moccasins—playing with the children—and rejoicing in their smoking kettles of food. At other times their gluttonous practices render them equally stupid and disgusting.

They appear to have no idea of a Supreme Being, but their superstitions refer to preternatural spirits, who, as they imagine influence their affairs. Some of the "cunning men" pretend to converse with them, and thus gain an ascendancy over their tribes. Their great care to prevent the earth or any heavy substance from pressing upon the dead, suggests a suspicion that they have some notion of a future state; whether they have or not is problematical. Their arithmetic extends only to counting six or seven, and at the utmost, ten.

From an attentive comparison of the inhabitants of the arctic regions with the lowest Indian tribes who come next south of the Esquimaux, the gloomy Mongols who roam over the vast tracts of Northern Asia, adjoining the south of the Samoieds and Kamschatdales; the Russian Boors and the Finns, who border on the wandering Lappes; it is obvious that they all rise in the intellectual scale, as they advance towards more temperate climates. Their powers of observation are arrested by the greater variety of surrounding objects, and their ingenuity quickened in providing themselves with conveniences and comforts. Their physical capacities, free from the paralyzing effects of perpetual frost, second their activity; their minds expand with various emotions; imagination finds a corner to reside in; and in proportion as their scope is enlarged, they also indulge in those wild and cruel passions which darken and deform savage life.

The scientific officers and gentlemen attached to the expeditions were unremitting in making observations upon the tides and currents, meteorological and astronomical phenomena, the magnetic force, and the variation of the needle. "Professor Barlow remarks, that the magnetic experiments cannot fail to be highly interesting to those who are curious in this important branch of natural philosophy. The needles were carefully watched, and the results registered every hour; and when it is considered that they were made

where nature has placed the great depot of magnetic powers, and where every phenomenon of this kind is exhibited on the grandest scale, we shall be able to appreciate the value of these important results."

Observations made by Capt. Parry, Lieut. Foster and others, during one hundred and seventy two consecutive days, induce them to suggest the following hypothesis :

That there is a *diurnal variation twice in every twenty-four hours past a certain point*, which they denominate a zero, or magnetic meridian; the westerly variation occurring in the forenoon, and the easterly after twelve o'clock. "The *diurnal*\* change of direction appears to have been seldom less than  $1^{\circ}$ , and sometimes to have amounted to  $5^{\circ}$  and  $6^{\circ}$ , and even  $7^{\circ}$ ;" and it is their opinion that the changes in amount are due to the influence of the sun, and probably of the moon, on the terrestrial magnetic sphere. *The particular law of this influence* remains unascertained. It is a question whether the diminishing intensity of a magnetized needle in constant use, may not have caused some disturbance; but if that were the case, the variations should have diminished in a constant and regular ratio. They therefore imaginé a small revolution of the polar point around its own center, produced by the action of the sun. This theory appears to accord with observations in peculiar and various situations in remote parts of the globe. In no instance was the magnetic influence affected by the Aurora Borealis during the three winters of Capt. Parry's residence within the polar circle. The observations upon the needle were made in a snow house, at a distance from the ships, in order to avoid the effect of their attraction.

Capt. Franklin remarks that when the Aurora was streaming with prismatic colors, it had an obvious effect upon the magnetic needle, but that when it was of a steady dense light without motion, the needle remained unmoved. He infers that the feebleness of the electric fluid in the higher latitudes, where it was seen by Capt. Parry, is the cause of this discrepancy; that the prismatic colors and the activity of the phenomenon at  $68^{\circ}$ , the site of his observations, being far greater than in the latitude of  $73^{\circ}$  at Port Bowen, are sufficient to account for the different effects witnessed by himself and Capt. Parry. If *the cause of the variation* of the needle can be ascertained, and the laws which regulate it

---

\* Edin. New Phil. Jour. March, 1827.

settled, it will be a large compensation for the hazards and hardships encountered by the patriotic adventurers, who have confronted the elements and the savages in making the acquisition. Professor Barlow is of opinion that the hypothesis suggested above, viz. "that of the magnetic pole having a daily motion about its mean orbit, of about  $2\frac{1}{2}'$  or  $3'$  in radius, serves to explain all the general phenomena of the observed daily changes in direction and intensity of the magnetic needle in different parts of the globe." The position of the magnetic pole is in  $69^{\circ} 16' N.$  lat. and  $98^{\circ} 8' W.$  long. as computed by Professor Barlow, from the observations of Capt. Franklin, Capt. Parry, and others.

The Aurora Borealis was less brilliant in the high latitudes, than in the Shetlands, Orkneys, and Bear Lake, but was noticed with particular accuracy, though without arriving at any satisfactory conclusion respecting the cause of its appearance. Whenever it appeared, it was in the southern part of the hemisphere, and peculiarly near and low, even below the clouds. Capt. Parry, accompanied by several officers, observed in one instance a column streaming downwards between the ship and the shore, a distance of only three thousand yards. No crackling or noise was at any time heard, and the prismatic colors were of very rare occurrence. The corruscations were generally of an uniform yellow color, in a low arch of steady light, though sometimes in a small degree undulating and streaming, as in lower latitudes.\*

---

\* In a late No. of the Lond. Mechanic's Magazine, it is stated that Professor Hansteen, accompanied by a naval Lieutenant, were to set out in May, 1828, upon a scientific expedition through Siberia. At St. Petersburg, they were to be joined by Dr. Erman of Berlin, who goes with them as astronomer and naturalist. They were to proceed by the way of Moscow, Kasan, Tobolsk, and north along the Obis to Bereson, in order to examine the northernmost branch of the Ural chain, and to observe the temperature of that tract. They hoped to arrive in season, to pass the winter at Irkoutsk. They intend to go thence north east to Jakoutsk, and onward one thousand and fourteen wersts, (six hundred and seventy six miles,) to Ochotsk, over a country entirely uninhabited, carrying provisions for the whole journey. The tour it is calculated will occupy two years.

The grand object of this important expedition, is to observe the phenomena of magnetism and to ascertain if possible, the situation of the magnetic poles.

The British brig *Chanticleer*, commanded by Capt. Forster, left England about the same time, on a voyage to the Pacific Ocean, for scientific objects. The officers who accompany Capt. Forster, have all been selected on account of their scientific acquirements. They are limited to three years absence, and are instructed to proceed as far towards the South Pole as they can without risking the ship.

Geological researches, were also pursued with an avidity not to be checked by the frost, which bound up the solid strata in ten fold chains, nor by the perpetual covering of snow and ice upon the surface. In all these newly discovered lands, primitive and transition rocks prevail, with but few alluvial deposits, and few if any volcanic remains. No new metalliferous compounds occurred but many useful ores, and some of the more interesting minerals of various kinds, such as garnets, rock crystals and beryl. The fossil remains, and the boulders found in tracts remote from their original localities; the arrangement of strata, and the general geognostical character of the arctic regions, indicate that they are similar to other extensive tracts, which have been examined by naturalists. These facts strengthen the opinion that the grand features of nature are every where the same; that they have been subjected to the same changes, and that the same agencies prevailed in forming the solid mass of the earth.

“When these phenomena,” says Prof. Jameson, “are examined in all their relations, and this beautiful and interesting department of natural science, is raised to its true rank, proving that its relations connect it with the extensive arrangements of the planetary system—it is then that the patient observer is rewarded for his toils, and the mind obtains enduring and sublime views of the deity, in contemplating the frame work of the universe.”

But little now remains to complete the survey of the shores of the frozen ocean, and from the examples of intrepidity, skill and perseverance, exhibited by those who have for the last ten years been engaged in exploring those inhospitable regions, and from the valuable additions thus acquired for science, it may be hoped that the zeal for discovery will not slacken; and that those who have proved themselves qualified to contend with the elements—who have so often defied the dominion of cold, and pursued the baffling navigation of icy seas with so much success, will yet ascertain the northern boundary of Greenland, and double the Cape of *Ceverovostochmi*, on the continent of Asia.

These enterprises have added a page to the record of England's glory, more splendid than conquest, and we hope soon to see the annals of our own country dignified by similar achievements. The government of the United States, have ordered the *Peacock* sloop of war, with two smaller vessels, commanded by Capt Jones, on a voyage of discovery to the Antarctic circle. From the character of those officers and gen-



tlements selected for the expedition, we may anticipate important results, both to commerce and learning. A vast expanse of waters, invites the attention of nations, to investigate the islands or continents—the fisheries or other treasures, which may be contained within its unknown boundaries; and we hope the liberality of government will make a provision so ample as to ensure, as far as possible, success to the enterprise; which interests the hopes, and awakens the pride and ambition of the American Empire.

---

---

ART. XVII.—*Motion, the Natural State of Matter.*

(Communicated.)

THE experiments of Mr. Brown, have shown an inherent locomotive power, in the molecules of matter. It is somewhat remarkable that we do not hear of their being repeated in this country. They certainly deserve the attention of our experimental philosophers, and might subserve more useful ends, than exciting the apprehensions of those timid minds, who are pleased to see in propositions of this class, a dangerous moral tendency. Some get a fit of the horrors, at the idea of our being alive as many myriads of times, as we have molecules in our corporeal frames.

What is it that constitutes life, motion, matter?

We must not look for the secret of the great first cause; our province is to reason about the states of matter—a high exercise of our intellectual powers; a source of the purest enjoyment to philosophical minds. This paper does not pretend to create a theory: it purports only to impart reflections suggested by the various phenomena connected with motion.

It will be conceded to Mr. Brown for the present, that his experiments are not illusions; that molecules have inherent locomotive power. Let us see if the phenomena he has detected, are consonant with the known phenomena of motion.

The states of matter are twofold: Matter in motion, and matter at rest.

The first comprehends molecules with inherent motive power; planetary masses, brought into their orbits by a resultant of two forces; animal bodies having voluntary motion; and fixed animal and vegetable bodies having motion of parts.

The second comprehends all bodies at rest.

There are certain true existences, inscrutable to human intellect. The *semper* existence of the first cause, and the re-

al nature of the parts of our own bodies, and of the parts of all things objective to us, to which the name of matter is given, are amongst these.

We come to the knowledge of matter by resistance.

When a body is brought to a certain state of velocity, from a state of rest, it does not attain that velocity co-instanter with the impact of the impelling power. It passes through all the intermediate velocities. The incipience of its motion, describes some part of space; immeasurable to us, because infinitely small, but it is a part of space. So when matter was created, did it not pass through all the stages of creation? If at its incipience, or at that vanishing point between nothing and something which constituted existence, it was subjected to motion, then all magnitudes and phenomena objective to us, may be the effect of motion. For a point infinitely small, having infinite velocity, and moving in a circle, would appear to be in all parts of the circle at the same time. And if other points with differing velocities were contained within the circle, and the whole area were filled with these orbits, the appearance of a solid would be presented.

If any other point with an equal velocity, or with a lesser one, were directed against it, the points of resistance within the disk, being as it were in all the parts of it at the same time, the disk could never be penetrated. It would have the properties of a solid as far as contact is concerned; and would appear to be so to the eye as far as vision is concerned: thus satisfying the two senses by which we judge of every thing. The wheels formed by fireworks, the points of concentrated fire having intense velocity, and which pass with such rapidity through the air in long and zigzag lines, as to appear to be in many places at the same apparent time, and which we call lightning, are familiar illustrations of this effect of motion.

Motion then appears a sufficient means to raise those infinitely small states of matter to the magnitude and phenomena of which we form a part. The same motive law that governs the parts, may govern the masses of the universe, and the planetary bodies be an aggregate of the movements of the infinitely small points, and constituting one grand simple movement from the infinitely small to the infinitely great. The mind rebounds at the simple grandeur of such a scheme of creation, when it pauses to consider the instantaneous disparition of all phenomena, which would result from the suspension of that original motion which omnipotence produced.

It has been said that we come to the knowledge of matter by resistance.

The mind can conceive of one infinitely small point having infinite velocity, being not only apparently in all the parts of the circumference, but in all the interior parts of a disk at the same time; but as such a velocity is necessarily always the same, so it is evident that phenomena like those objective to us, could not be thus constituted, for there could be no resistance. One point projected with infinite velocity, and having an exclusive existence, could not resist itself. Its velocity could not overtake itself because all the parts of the line of motion are of the same degree of velocity.

To produce resistance there must be more than one body, one moving with one degree of velocity, another moving with a different degree of velocity would constitute a resistance when meeting. The greater velocity would repel the lesser.

Motion appears to be a necessary condition of both light and heat. Light is projected from the sun. Heat is projected from calorific bodies. They are both reflected from surfaces. The rays of light coming with a velocity of one hundred and seventy thousand miles in a second, pass through glass into opaque bodies. Yet being greatly diverged, they do not disintegrate bodies by their velocity. They fall with a mild influence upon surfaces, and must be concentrated before they are destructive. Why is the sensation of heat more intense than the sensation produced by light? Is it because the rays projected from a fire, do not diverge, are concentrated, and act in a mass? In proportion as we recede from the source of the heat, is the force of the sensation.

If light and heat were attenuated states of the same power why do we not see a hot iron in a dark room? Is it because the heat or light in the body, in its way to the surface is obstructed, and not coming out in parallel lines cannot be visible? When the calorific quantity is increased, the atmosphere in contact with the surface being charged, the rays come in parallel lines and are visible.

If all the rays which fall upon bodies, were reflected back, would they not be so brilliant that it would be painful to look upon them? Supposing bodies to absorb the greater portion of the light which falls on them, we have thus a source for the maintenance of animal heat, and for the heat which is found latent in all bodies. What becomes of the vast

quantities absorbed by the earth? Do they keep travelling on to the center, and thus become the source of volcanic power, and of the disturbing forces which have effected the geological relations of this planet.

When the sun goes down, animals feel an inclination to sleep, when light returns they awake, and have an inclination to move. Is it light which operates thus upon animals, by giving them an additional impulse? Is the inclination to sleep caused by abstraction of the cause of motion? Animal masses are distinguished from all others, by possessing a principle with the faculty of voluntary motion. When it determines to move, motion commences; when it determines to stop, motion ceases.

Do we gain any thing by asserting that planetary bodies are *projected* in right lines? Would it not be as reasonable to assert that they have an inherent motive power, directing them in right lines?

Is it unreasonable to suppose motion to be the natural state of matter; and rest to be its opposite state, or the equilibrium of motion produced by gravity? FLAMAND.

ART. XVIII.—*Facts relating to Ohio and Mexico.*

I. *Miscellaneous Notices of Rocks and Minerals in the State of Ohio*; by Dr. S. P. HILDRETH—in a letter to the Editor, dated May 13th, 1828.

1. *Boulder stones of primitive rocks.*

Boulder stones of primitive rocks scattered over the surface, and buried in the upper soil of secondary countries are always interesting. Those of the western states and especially of Ohio have been often mentioned in this Journal.\* Among the specimens transmitted by Dr. Hildreth, are some portions of the boulder stones of Ohio. They as well as the other specimens are numbered.—Among them are,

Gneiss, perfectly well characterised.

Granite—one specimen having white felspar and gray quartz, but without mica, others fresh and handsome with reddish felspar, and gray quartz, and black hornblende instead of the mica—Trap in the form of fine grained greenstone—Hornblende slate and crystalized hornblende rock.

\* See Vol. III, p. 49—Vol. XIII, p. 39—Vol. XIV, p. 291.

The fragments of such rocks are found in the vicinity of Newark, Ohio, and from thence onward to Lake Erie, scattered through the diluvial and alluvial earth, from the surface to the depth of thirty-six or forty feet—The fragments are of all sizes from an ounce to several tons.

No. 9 is a granite with red felspar, the rock is partly decomposed: it is from the hills in Knox county, near owl creek, a large branch of the Muskingum River.

No. 10 is a fine leaved mica slate, from the bed of Licking creek in Newark. Whet stones, whose appearance is like this specimen, are sold for sythes in this town, and brought from the waters of the Monongahela, within the primitive range of the Alleghany mountains; it is called the "crumb creek stone."

No. 14. A piece of water lime, found near Newark—it is also found in great abundance, and of an excellent quality, in the neighborhood of Coshoctou, near the line of the canal.

No. 15. A piece of water lime, from Louisville, Ky.

No. 17. Sandstone from the narrows of Licking creek, below Newark.

No. 18. Sandstone.—Feebly agglutinated puddingstone, from the same locality.

No. 19. White, silico-micaceous sandstone, of a rich and beautiful appearance, found in place or beds, on the highest hills in Licking county, about one thousand and fifty feet above tide water, and four hundred and sixty six feet above the waters in Lake Erie; Newark being two hundred and sixty six feet above Lake Erie, leaving two hundred feet for the height of the hills.

No. 20. Calcareous iron ore, Licking county. This ore with a certain proportion of the argillaceous, is used in the furnaces in the Licking valley.

No. 21. Arenaceous sandstone, composed chiefly of quartz and felspar, from Cedar Narrows, Duck Creek, Washington county. This stone has been quite extensively used in the manufacture of mill stones, and stands well, in the grinding of corn. A bed of Turkey hone or stone for joiners' tools, used with oil, is found near it. The "millstone" quarry, is covered with a bed of sandstone. A considerable distance lower in the bed of the creek, stone coal and limestone are found.

22. Fine sandstone, of the quality used for hearths or beds, at the iron furnaces on Bush creek, Scioto county, near the Ohio river; it stands the fire remarkably well.

No. 23. White sandstone, composed chiefly of arenaceous quartz; it is used in the composition of glass, at the manufactory in Zanesville, and found in an extensive bed, three miles above that town, on the Muskingum bank.

No. 24. Three specimens of *common sandstone*, from the falls in the Muskingum river, at Zanesville—taken twenty feet below the surface of the rock—impressed with the scales of a fossil fish, and containing *charcoal*. The figure of the fish, was very finely engraved on the face of the rock, between the fissures made in quarrying, but was broken up into small pieces by the workmen; the whole cast was five feet long. The canal round the falls is cut in this rock; from this canal numerous slips or cuts, are made laterally into the Muskingum, affording sites for mills. In making a cut of this kind last summer, several fossil fish were found, and a considerable bed of charcoal.

No. 25. A primitive rock partly decomposed or disintegrated, and containing much sahlite; found near Newark, in diluvial soil; but found also on the tops of the highest hills in Athens county, and in the waters of Federal creek.

Nos. 26 and 27. Argillaceous iron, in concentric layers, from the hills, two miles south east from Newark.

No. 28. Globular, pyritous iron, found in the sandrock at Zanesville. Large quantities of globular, argillaceous iron ore, are found in the alluvial soil of Licking creek, at Newark, from the size of a four pound to that of a forty eight pound shot; some are very round, others are shaped like an urn. They are sometimes found in digging for iron ore, but mostly in searching for limestone, which is obtained in large and small detached masses, from six to ten feet deep, covered with gravel and earth. The globular iron ore is covered with a coat of rust, one half or three fourths of an inch thick, which easily comes off in scales. I have (says Dr. H.) two of these globes; one eight inches, the other six in diameter.

No. 29. Compact, argillaceous iron ore, very rich; found in scattered nodules, through the hills in Washington county, from one to fifty pounds weight; sometimes in extensive beds.

No. 30. Red iron stone, the ore being apparently in the chemical condition in which it is in the hæmatite; it occurs in beds.

No. 31. Carbonate of iron, or friable argillaceous ore; Marietta—found in large beds, decomposing on exposure to rain and air, and having the appearance of the rust of iron of the shops.

No. 32. Pyrites, imbedded in clay, from Pappaw creek, Washington county; the bed of the creek for a mile in length, is full of pyrites. Numerous furnaces have been erected in the side of the hill near the creek, in which ore of some kind has been melted; the beds of the furnaces are full of cinders. Charcoal and stonecoal, have been used in the smelting. Several wagon loads of scorix are found in one furnace. Large trees are growing over the beds of the furnaces, so that several ages must have passed away since they were built. The bottoms of the furnaces were lined with white clay, and the sides built up with rough stone like a lime kiln. Several mounds, one of stone, are found on the hills near. The country is very hilly and broken on this stream. These furnaces have excited much speculation amongst the ignorant and the curious; they were doubtless made by the Indians. I have partially examined the pyrites, but can obtain nothing but iron.\*

No. 33. Pyrite, in rock, from Union township, March run; bed from four to five feet in thickness.

No. 34. Fibrous or radiated pyrites. It is found in an extensive bed on the Ohio river, some distance below; it is different from any other that I have seen.

No. 35. Pyrites, found near coal beds in Marietta.

No. 36. Slaty clay, saponaceous, ferruginous and glazed; Marietta.

No. 37. Limestone, compact and gray, common to this vicinity—free from shells.

No. 38. Micaceous sandstone; Zanesville.

No. 39. Jaspersy iron ore, common on the beach of the Muskingum, in bent and contorted pieces, as if moulded when soft.

No. 40. Bluish chalcedony, surmounted by crystalized quartz; also, mamillary gray and blue chalcedony on hornstone; also, smoky quartz, from Flint ridge, fourteen miles west of Zanesville.

No. 41. A piece of the cellular hornstone, or buhr-stone. So far as I can learn this ridge can be traced from fifty to eighty miles, in a N. E. and S. W. direction from Coshoctou county, through Perry, Hockhocking, and Jackson counties, except where it is interrupted by water courses, probably to the Ohio river. I have taken measures to learn more particularly its extent and direction. The rock is evidently second-

---

\* It contains nothing but iron and sulphur.—*Ed.*

ry, containing bivalve shells, several of which are in my possession, and the "cells," appear to be made by some aquatic insect. The ridge abounds in different kinds of flint, hornstone, jasper, &c.

No. 42. Three varieties of sandstone, used in buildings, &c. Marietta.

No. 43. A beautiful deep red ochre, here called Terra de Sienna, a name frequently given to ochres, as an indication of excellence; this is said by painters to be good; from the Yellow springs, Green county.

No. 44. Yellow ochre, Fearing township, Duck creek, a large bed.

No. 45. Tufa and earth, deposited in vast beds, at the yellow springs, Green county Ohio.

No. 46. Red ochre, from Little Muskingum creek, Lawrence township.

No. 47. Alum earth, from Wolf creek, township of Waterford; extensive bed.

No. 48. White clay, used for pots in the glass manufactory at Louisville, from Perry county, a few miles S. W. from Zanesville, and near the "Flint Ridge."

No. 49. Pyritous sand, Marietta.

No. 50. Pyrites, found in digging a well on Wolf creek.

No. 51. Clay, from the "deep cut," Ohio canal, thirty feet below the surface.

No. 52. Sulphate of lime, found in digging a well; deposited in the crevices of compact brown clay; commencing six feet below the surface, and extending fifteen feet; earth quite full of it; twenty one feet below the surface a bed of pyrites four feet thick; then a bed of stone coal three feet thick, and then water; well dug on the hills, or broken uplands, eight miles East of Marietta.

The rock formation in that part of the country, where I reside, being altogether of secondary character, is not very rich in minerals; iron ore, and the different sulphurets, being the principal productions that have yet come to light—I have in my possession a very fine piece of copper that was obtained from pyrites, a few miles from Marietta, on Duck Creek—the bed is said to be extensive; the pyrites were first roasted, then pulverized, and melted out in a large crucible by a blacksmith's fire; I should judge they afforded from thirty to fifty per cent of the pure copper; from one crucible, were obtained three or four ounces—should any



person of capital, and the requisite stock of information, enter into the business of working the bed, I have no doubt it would be profitable.

Enclosed, is a small paper of a powder, found in Lawrence County, about eighty miles west of Marietta, in a bank of clay, and when first found, is in a liquid state, of the consistence of cream, and nearly of that color; on drying it becomes blue. It is in separate parcels, confined to small cells in the clay, in the manner that native quick-silver is sometimes found. It is said to be found in considerable quantities. I should be glad of your opinion as to its quality and use.

---

The powder mentioned by Dr. Hildreth, is of a delicate azure, much resembling powder blue, and was not unnaturally, thought to be oxid of cobalt; as however it loses its color by the blow pipe, becomes magnetic, by being heated on charcoal and very decidedly so, if grease be added before the heat is applied, it is probable that is similar to the blue iron earth of mineralogists found in the diluvial country of New Jersey, and elsewhere.—*Editor.*

August 8, 1828.

#### MEXICO.

II. *Extract of a letter to the Editor, from an American resident in Mexico, dated Halcotal, near Temascaltepec, July 13, 1828.*

1. *Geological character of the country.*

With respect to caverns in this country, I do not expect to see many, if even any: I have yet met with very little limestone. Lava, volcanic tufa, trachyte, clay slate and a little granite, with porphyry, are the predominant rocks of all the parts I have yet seen of Mexico. Volcanic tufa, trachyte and lava, form about ninety nine parts in a hundred, of the country yet visited. This country offers probably as extensive a field for volcanic rocks and their debris, as any that I have seen described; none of which appear to be recent: nor is there any volcano at present in activity; a fact which much surprised me, feeling almost certain, when I came to the country, that I should see volcanos in activity.

## 2. *Amalgamation.*

*The separation of the mercury from the silver*, is here a clumsy, and comparatively, an expensive process. Instead of using an iron retort, with two parts like an alembic, placed upon the common open French furnace; the antique *per decensum* method is the one resorted to. The amalgam is placed under a large bell of copper which is encased for each operation with unburnt bricks but so as to leave a space sufficiently great for the quantity of charcoal requisite to produce the heat required. The heat being a lateral one, the mercury rises towards the top, collects in globules and falls through a funnel and tube placed at the bottom of the bell into a vessel of water beneath the whole; or the whole bell is filled with the vapor of mercury, which is condensed at the lower part. Should you wish a drawing of the furnace, it will give me pleasure to send you one. The furnace has a fanciful appearance, like the tombs of the middle ages: the bell being on the top and center of a quadrangle of masonry; at the corners of which are four pillars of the same, supporting a pyramid, which serves as the dome of the furnace.

## 3. *Climate of Mexico.*

This country holds out great advantages to those persons who suffer from those pulmonic affections, which arise from too great action of the lungs on the arterial system, which I think of consequence. Almost every degree of rarity of the air can be obtained in this country, and certain degrees of it can be obtained likewise, which are almost uniform for temperature, from one season to another. In the city of Mexico, breathing is attended with unpleasant sensations to every stranger in ascending an elevation, be it great, or even small. The action of the lungs is a labored one, and the want of strength attendant upon their imperfect function or performance, is very evident. I found there, for the first time in my life, a difficulty of breathing at night, frequently waking with a sense of want of sufficient breath. At this place nothing of the latter kind occurs, the elevation not being greater than about three thousand five hundred feet, but still I cannot climb the hills and mountains here, as I was wont to do in other countries, from deficiency of pulmonic action. Since I have been here, a period of five months, the greatest degree of heat in my room has been seventy-two

and a half degrees of Fahrenheit, and the lowest sixty-six degrees. I arrived in the extreme part of the dry season, the hot one, and this is now the rainy one, and the coldest; the sun nearing us every day. With this small variation of temperature, in addition to the effects arising from the rarity of the air, as mentioned, what can be more favorable than certain parts of Mexico for consumptive patients, whose disease arises from overaction of the lungs, caused or increased by the dense air of our country? Besides these two advantages, there are others, and those of importance; they are fruits, and other esculents, of all climates, and all seasons, which the extreme variableness of level above the ocean, enables this country to produce, and which are produced in sufficient abundance.

#### 4. *Obsidian.*

From the fragments of obsidian which I every where find in this neighborhood, on land susceptible of cultivation, it is evident that it was pretty extensively used by the aborigines of Mexico: it was, so far as I have observed, fashioned in two ways only. The most common of the instruments made of it, presents a parallelogram of about two inches long and an half inch in width, and in thickness two lines, more or less, at the center, from whence it tapers to the longest sides, so as to

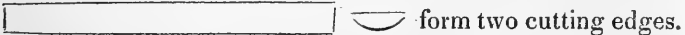
 form two cutting edges.

They were used for cutting, as is evident from the number I find of them with their edges hacked or notched. The form of the other kind is that of the common arrow or spear head of our country. Many are found here, very small, much more so than any I have seen belonging to the former inhabitants of the United States. The most glassy kind of obsidian was used for the former or cutting instrument: the opaque, or lapideous, being the toughest, for the arrow heads. None are now in use, and I should suppose, from a conversation I had with a *Mexican*, that their use was now forgotten. They are here called *chinapis*, (pronounced che-napes.) It is however but a local name.

#### 5. *Geological Classification.*

In your letter you mention a collection of rocks and minerals recently arrived in New York from Europe.\* If well cho-

---

\* The very interesting collection of G. W. Featherstonhaugh, Esq.  
VOL. XVI.—No. 1. 21

sen they will on account of their number be highly useful. I do not perceive that American geologists are turning their attention to the masses or formations which compose the primitive class, and our country is the best for that purpose that has been hitherto explored. From the result of observations made in the United States, from the upper part of New York to Georgia, I have assigned no more than four masses or formations belonging to that class. They are the granite, gneiss, sienite, (including protogine or talcous gneiss) and clay slate. All the other rocks were subordinate to one or more of these four masses. These masses are arranged in parallel lines, the first being nearest the ocean, the last farthest removed from it; the geographic arrangement, as enumerated, according with their supposed geological one. The granite commences in Virginia, and runs through all the States south of it. It contains within its range the shining clay slate or schiste luisante of Brongniart, and the compact mass of the same rock, which furnishes the gold of North Carolina. The limestone of New York, Philadelphia and Baltimore, I found was not a continuous mass; though its direction is uniform. I have walked round it in many places in North Carolina, and in South Carolina. It is generally encased in talcous slate, or mica slate, and both are encompassed or encased by the gneiss, being themselves also subordinates of this great mass. Sienite with quartz, forms the rock of the third range. This rock I have traced from the highlands of New York, (North river,) to Pennsylvania; there it begins to be mixed with talc, which increases in going south, and finally in Virginia and North Carolina, near the Georgia and Tennessee boundaries, it is a well characterized protogine gneiss, resembling Jurine granite of that name; but with the structure of gneiss. To this rock, alternating at the point of contact, is referred the primitive clay slate, which alternates also with the transition slate, which in the southern states, is perfectly analogous with the rocks containing the anthracite of Rhode Island. I long ago intended to communicate to the American Journal a paper upon the classification of the primitive rocks, as well as the succeeding ones; but I found some facts which tended to a more simple classification than the one mentioned, and whilst seeking for others to direct me to the point where to stop, I found myself preparing to sail for Mexico. I have about one hundred observations of the dip of the gneiss of the southern states, all which are towards the east; consequently this rock underlies the

granite of that direction, or if the two masses, are sequent as regards order of deposition, it follows that a change of the position of the one took place, before the deposition of the other, a supposition no more to be admitted than the former one. In vain I sought for a point of sub-position of the two masses, to solve the difficulty, and it was equally impossible to obtain one, for the clay slate in the range of the granite: this latter rock, appearing occasionally in the range of the slate, (forming also its boundaries east and west, as before indicated) like the same rock, with its *killas* or *slate*, as represented in the great sections of Cornwall. The difficulty just mentioned, and some facts drawn from mica and other common minerals of the primitive class, drew my mind insensibly to the consideration of *one map* for the class, varying in parts not only from difference of mineral composition, but from the presence and absence of those causes which promote or embarrass that property of matter, to which there is nothing analogous but life, and which, though the cause of many important geological phenomena, has been too much overlooked. It is hardly necessary to say that I mean crystallization. One effect also, and not the least, of this common property of matter, has been the uplifting of strata, of which none ought to doubt, who favor the igneous origin of the rocks of the primitive class.

## INTELLIGENCE AND MISCELLANIES.

### DOMESTIC AND FOREIGN.

1. *The national historical pictures, by Col. Trumbull.*—The four great pictures, painted by order of the General Government, are at length placed securely in their destined situations. This fact and the means used for their preservation, as well as the building and the particular part of it in which they are placed, are worthy of commemoration. We therefore subjoin an extract of a letter to the editor from Col. Trumbull—also his report to the government, and a memorandum of the size and cost of the Capitol, in which the pictures are deposited.

#### 1. *Extract of a letter from Col. Trumbull.*

The work which I was ordered to do in the Capitol is completed, I believe, to the satisfaction of the House: the paint-

ings which I found in a state of rapid decay, I trust I have left in security; and the great room, which was a perfect nuisance from dampness and cold, is now warm as a greenhouse, the thermometer being easily kept at or near 60°.

I enclose to you a copy of the report which I made to the House, which I will thank you to insert in your Journal of Science, if you think it deserves a place there. It may be important to future artists, to know what has been done, in order that, if time should prove my means effectual, they may be, in future, adopted in similar cases; or be avoided, if they should be proved by that only sure test, to be unsuccessful.

It is a serious misfortune for their successors, that so few of the ancient artists have left written explanations of the mechanical part of their systems. The Venetian coloring for instance, is proved by the test of three hundred years, to be superior to all other works of equal age, in freshness, brilliancy and solidity; but no one now knows what the vehicle was with which they prepared their colors, yet a short memoir would have explained the system.

II. *Letter from John Trumbull to the Speaker of the House of Representatives, on the subject of the National Paintings in the Rotundo of the Capitol.—December 9, 1828—Read, and laid upon the table.*

*To the Hon. the Speaker of the House of Representatives, U. S.*

SIR: On the 30th of May last, I received from the Commissioner of the Public Buildings a copy of the resolution of the honorable the House of Representatives, dated the 26th of May, authorizing him to take, under my direction, the proper measures for securing the paintings in the Rotundo from the effect of dampness.

I had always regarded the perpetual admission of damp air into the Rotundo from the crypt below, as the great cause of the evil required to be remedied; and, of course, considered the effectual closing of the aperture which had been left in the centre of the floor as an indispensable part of the remedy. I had communicated my opinions on this subject to the Chairman of the Committee on the Public Buildings, and had been informed that this had been ordered to be done.

So soon, therefore, as I received information from the Commissioner that this work was completed, (as well as an alteration in the skylight, which I had suggested,) and that the workmen and incumbrances were removed out of the

room, I came on, and proceeded to take the several measures for the preservation of the paintings, as stated in detail in the following report, which I beg leave to submit to the House.

1st. All the paintings were taken down, removed from their frames, taken off from the pannels over which they are strained, removed to a dry warm room, and their separately and carefully examined. The material which forms the basis of these paintings is a linen cloth, whose strength and texture is very similar to that used in the top-gallant-sails of a ship of war. The substances employed in forming a proper surface for the artist, together with the colors, oils, &c. employed by him in his work, form a sufficient protection for the threads of the canvass on this face, but the back remains bare, and of course, exposed to the deleterious influence of damp air. The effect of this is first seen in the form of mildew; it was this which I dreaded; and the examination showed that mildew was already commenced, and to an extent which rendered it manifest that the continuance of the same exposure, which they had hitherto undergone, for a very few years longer, would have accomplished the decomposition or rotting of the canvass, and the consequent destruction of the paintings. The first thing to be done was to dry the canvass perfectly, which was accomplished by laying down each picture successively on its face, upon a clean dry carpet, and exposing the back to the influence of the warmth of a dry and well aired room. The next thing was to devise and apply some substance which would act permanently as a preservative against future possible exposure.

I had learned that a few years ago, some of the eminent chemists of France had examined with great care several of the ancient mummies of Egypt, with a view to ascertain the nature of the substance employed by the embalmers, which the lapse of so many ages had proved to possess the power of protecting from decay a substance otherwise so perishable as the human body. This examination had proved that, after the application of liquid asphaltum to the cavities of the head and body, the whole had been wrapped carefully in many envelopes, or bandages of *linen prepared with wax*. The committee of chemists decided further, after a careful examination and analysis of the hieroglyphic paintings with which the cases, &c. are covered, that the colors employed, and still retaining their vivid brightness, had also been prepared and applied with the same substance.

I also knew that, towards the close of the last century, the Antiquarian Society of England had been permitted to open and examine the stone coffin deposited in one of the vaults of Westminster Abbey, and said to contain the body of King Edward I, who died in July, 1307. On removing the stone lid of the coffin, its contents were found to be closely enveloped in a strong linen cloth, *waxed*. Within this envelope were found splendid robes of silk, enriched with various ornaments covering the body, which was found to be entire, and to have been wrapped carefully in all its parts, even to each separate finger, in bandages of fine linen, which has been dipped in melted wax; and not only was the body not decomposed, but the various parts of the dress, such as a scarlet satin mantle, and a scarlet piece of sarsnet which was placed over the face, were in perfect preservation even to their colors. The knowledge of these facts persuaded me that wax, applied to the back of the paintings, would form the best defence, hitherto known to exist, against the destructive effects of damp and stagnant air; and therefore,

2dly. Common beeswax was melted over the fire with an equal quantity (in bulk) of oil of turpentine; and this mixture, by the help of large brushes, was applied hot to the back of each cloth, and was afterwards rubbed in with hot irons, until the cloths were perfectly saturated.

3dly. In the mean time, the niches in the solid wall, in which the paintings are placed, were carefully plastered with hydraulic cement, to prevent any possible exudation of moisture from the wall; and as there is a space from two to eight inches deep between the surface of the wall and the back of the pannels on which the cloths are strained, I caused small openings to be cut in the wall, above and under the edge of the frames, and communicating with those vacant spaces, for the purpose of admitting the air of the room behind the paintings and thus keeping up a constant ventilation, by means of which the same temperature of air will be maintained at the back of the paintings as on their face.

4thly. The cloths were finally strained upon pannels, for the purpose of guarding against injury from careless or intentional blows of sticks, canes, &c. or children's missiles. These pannels are perforated with many holes, to admit the air freely to the back of the cloths; and being perfectly dried, were carefully painted, to prevent the wood from absorbing or transmitting any humidity. The whole were then restored



to their places, and finally cleaned with care, and slightly revarnished.

5thly. As the accumulation of dust arising from sweeping so large a room, and what is much worse, the filth of flies, (the most destructive enemies of painting,) if not carefully guarded against, renders necessary the frequent washing and cleaning of the surface of pictures, every repetition of which is injurious, I have directed curtains to be placed, which can be drawn in front of the whole, whenever the room is to be swept, as well as in the recess of the Legislature during the Summer, when flies are most pernicious.

6thly. As nothing is more obvious than the impossibility of keeping a room warm and dry by means of fire, so long as doors are left open for the admission of the external air, I have further directed self-closing baize doors to be prepared and placed, so that they will unavoidably close behind every one who shall either enter or leave the room.

When the doors are kept closed, and fires lighted in the furnaces below, to supply warm air, I find the temperature of this vast apartment is easily maintained at about 63° of Fahrenheit; and the simple precaution of closed doors being observed, in addition to the others which I have employed I entertain no doubt that these paintings are now perfectly and permanently secured against the deleterious effects of dampness.

I regret that I was not authorized to provide against the danger of damage by violence, whether intended or accidental. Curiosity naturally leads men to touch, as well as to look at, objects of this kind; and, placed low as they are, not only the gilded frames and curtains, but the surface of the paintings are within the reach of spectators: repeated handling, even by the best intentioned and most careful, will in the course of a few years, produce essential damage. But one of the paintings testifies to the possibility of their being approached for the very purpose of doing injury: the right foot of General Morgan, in the picture of Saratoga, was cut off with a sharp instrument, apparently a penknife. I have repaired the wound, but the scar remains visible. If I had possessed the authority I should have placed in front, and at the distance of not less than ten feet from the wall, an iron railing, of such strength and elevation as should form a complete guard against external injury by ill-disposed persons; unless they employed missiles of some force.

I beg leave to commend to the attention of the House this farther precaution.

All which is most respectfully submitted to the House, by  
JNO. TRUMBULL.

III. *Dimensions of the Capitol of the United States, and its Grounds.*—The ground within the Iron railing,  $22\frac{1}{2}$  acres. Length of foot walk, outside of railing,  $\frac{3}{4}$  of a mile and 185 feet.—The building is as follows:

Length of front, - - -	352 feet 4 inches.
Depth of wings, - - -	121 do. 6 do.
East projection and steps, -	65 do.
West do. do. - - -	83 do.
Covering $1\frac{1}{2}$ acres, and 1820 feet.	
Height of wings to top of Balustrade, -	70 feet.
Height to top of centre dome, - - -	145 do.
Representatives' room, greatest length, -	95 do.
do. do. do. height, -	60 do.
Senate chamber, greatest length, - - -	74 do.
- - - do. height, - - -	42 do.
Great central rotundo, 96 feet in diameter, and 96 feet high.	
The north wing was commenced in 1792, and finished in 1800, cost - - -	\$480,262 57
South wing commenced in 1803, and finished 1808, cost - - -	308,808 41
Centre building commenced in 1818, and finished in 1827, cost - - -	957,647 35
	<hr/>
	\$1,746,718 36

2. *New book of travels.*—We have been permitted to hear read parts of a MS work now in progress, which will, if we mistake not, form a book of a kind somewhat peculiar. The author, a man of mental power and liberal education, taste and acquirements, accompanied an American squadron around the shores of the Mediterranean, and was absent from this, his native country, from the autumn of 1825 to that of 1828. In his character of instructor of the midshipmen, he was, in some sense, a privileged man, was of course exempt from every kind of naval duty, was at liberty to observe the peculiarities of life and character, of incident, discipline and duty, among the members of the navy, was attentive to marine scenery and natural phenomena, and avail-

ed himself of opportunities, in which he was liberally indulged, of visiting many places in several of the interesting countries that surround the Mediterranean.

In observing these regions, the cradle of man; famous alike in song and story, in arts, in commerce and in war; the seats of empire, risen, fallen and gone; the birth place of true and false religion; the theatre of noble struggles for liberty, both ancient and modern, he was not an idle observer, and men and things were alike embraced in his survey.

But his leading object seems to have been, to unfold the interior of the American navy, so that this national institution, so much spoken of, but so little understood, may be displayed to the national eye; and to present such graphic sketches of those scenes which are beyond a landman's view, that he may see them as if he were sailing with the traveller.

We have obtained permission of the author, to insert the following sketch of a night squall.

U. S. frigate *Constitution*, Monday, Sept. 4, 1826.

\* \* \* \* \*

On Friday the green shores of Sicily came in view, but the breeze was light, and we advanced slowly. On Saturday it left us altogether, and, when I turned in at night, the sea was smooth and bright as a mirror; the vast firmament seemed to descend below us; the ship appeared suspended in the centre of an immense sphere, and if I may say so, one felt in awe and silence the majesty of space. The sails hung idly by the mast, and the officers' tread along the deck was the only sound heard. So I left them. About midnight I was awaked by a heavy swing of my cot, succeeded by a sudden dash to the other side: the water was pouring into our room, and I could hear its rush across the upper decks, where all was noise and rapid motion. I hurried on my clothes and ran up: the gun deck was clear; hammocks had already been lashed up and stowed; it was lighted up, and the lamps shewed it flooded in its whole extent. I ascended to the next: the rain came down in torrents, but I did not feel it, so deeply absorbing was the scene. I wish I could describe it. The sky was in a constant blaze: the sea was not high, but the waves were broken, confused and foaming, and taking from the lightning an unnatural hue. Above me were the yards covered with human beings,

thrown by each flash into strong outline, struggling hard to secure the canvass and to maintain their precarious footing: the ship rolled tremendously. And now add the wild uproar of elements, the "noise of many waters," the deep and constant roar of winds, the cries of men aloft, the heavy and rapid tread of those below, the reiterated orders of officers, and the sounds of the trumpet rising above all; and then add to this the heavy rolling of thunder, at times drowning all these sounds. The first lieutenant had the deck; he had sprung to it at the first alarm, and seizing the trumpet had called for Black, his favorite helmsman. The ship was soon under snug sail, and now dashed onwards at a furious rate, giving to the gale a yet wilder character. All at once a rocky island seemed to start up from the waters, but the next broad flash shewed a good offing, and we were safe; when suddenly came a loud shout from the forecastle, "a sail on the starboard bow," and then another, "a sail close on the larboard bow." I trembled then; not for ourselves, for we should have gone over them and have scarcely felt the shock, but for the poor wretches, whom it would have been impossible to save. The helm was put hard down; we shot by, and I again breathed freely, when some one bade me look up to our spars. I did so, and found every upper yard arm and mast head tipped with lightning. Each blaze was twice as large as that of a candle, and thus we flew on with the elements of destruction playing above our heads.

In about thirty minutes the wind, which was from the S. W. changed suddenly to the S. E. and became as hot as air from the mouth of an oven: it was the sirocco, and, I was told afterwards by those most above the deck, brought with it a quantity of fine sand. We were then a few miles from Maratimo, sixty six from Cape Bon, the nearest African shore, and three hundred from the nearest land in the direction of the wind. It lasted half an hour, and was a stiff, smacking breeze, but not near so strong as the one that had preceded it.

A similar electric phenomenon occurred to the ship in which Castor and Pollux sailed, in the Argonautic expedition, only the light appeared on the caps of the two heroes: the storm subsided and they were received as patrons of sailors. Hence the ancient medals represent them each with a star or flame of fire at the apex of his cap. In this way too, we may account for the story, that they often appeared to sailors in dis-

dress, and also to the Roman armies, leading them to victory. The latter was nothing more than the electric fluid on their spears. I recollect hearing Professor Silliman, in one of his lectures, relate a case nearly similar, of the late Mr. Whitney of New Haven. He was riding on horseback, near East Rock in the vicinity of that town, during a night thunder-storm of great severity, and was astonished to find, all at once, his horse's ears tipped with fire: he alighted, but now discovered the same phenomenon at the end of his whip, stirrups, and every prominent object. His own person and that of an attendant, were tipped in the same manner. Similar appearances, probably suggested to Virgil, the fiction of the flame about Ascanius' head, the night Troy was burnt.

Our sailors call them *complaisants*, (from *Corpo Santo*): I went among them yesterday, to discover whether such appearances were common, and began with a group of old quarter-masters: most of them had followed the sea from their youth. I found each had seen them three or four times before, and that they occur most frequently among the West Indies. They tell me, they often appear on the lower yards first, and ascend as the storm abates. "Well," I asked, "what do you think they are?" They shook their heads—it was a hard question. At last one spoke very seriously; "I'll tell you sir, what I think they are: they are foul air that the wind rolls together into a lump: it gets a little lightning in it and sticks fast on the yards."

Yesterday we had a strong wind and a rough sea all day: another squall threatened as evening drew round: the sea was wild and foaming; the waves came rolling on as if eager to overwhelm us: the clouds rose like dark walls on the horizon, appearing to shut us up forever to the treacherous element, while a broad heavy mass rolled on, over head, "*noctem hiememque ferens*." Nothing else could be seen, except the North Carolina, [the flag line of battle ship,] an indistinct mass, several miles distant. She too faded and became a misty speck, but the usual light was raised at her mizen-top to govern our course. But this suddenly disappeared, and nothing could be seen; we answered its disappearance by raising a light to our fore-mast head: all looked in her direction, when suddenly another light appeared, a mere point in the distance; it spread and brightened, and then shot up so as to lighten the whole stern and sails. It

sunk and was succeeded by another, and this by another similar one; then was darkness a moment, and next followed three successive flashes. We lowered our lantern; her mizen light again appeared, and all hands were called to execute the order. This is the first time I have introduced to you a night signal: we had two on Saturday night in the midst of the storm: their effect, in rough or calm weather, is always very fine.

The gale came on soon after; it brought one *complaisant*, and this appeared at our mizen royal-mast head: our main-mast has a chain conductor.

Cum "*magno telluris amore.*" Yours, &c.

3. *The number five, the most favorite number of nature.*—

PROF. EATON.

Although lilies and many other plants have the organs of fructification in sixes, also some in threes, others in fours, and the honey-cells of bees have sides in sixes, &c. yet nature's favorite number appears to be five. At least, the half of all known plants have the parts of fructification in fives, or in a number which is the product of five.

On examining the radiated division of animals, we find the sea star and medusa's head (*asterias aculeata* and *caput medusæ*) have their medullary processes incased in five rays. The genus *actinia* has its rays in fives or in a number produced by some product of five. Every species of the coral rock, called *madrepora*, also the *spongia*, *flustra*, *tubularia*, *sertularia*, *encrinus*, &c. have rays of similar numbers.

Throughout Cuvier's whole vertebral division, five is the leading number. For example we have five fingers to the hand, and five toes to the foot, in common with most of the mammalia. Hence our numbers five, twice five, (ten,) twenty times five, (one hundred,) &c. We have five principles, constituting the highest order of vertebral animals, man—to wit. 1, *inert matter*, 2, the *attractive principle*, 3, the *living principle*, 4, the *sentient principle*, 5, the *intellectual principle*. In proof of this we observe them disappearing in an inverted order at death. I will state a case, which has recently passed under my immediate inspection.

A near and dear relative died of the pulmonary consumption. His intellectual faculties were never more brilliant, than at 11 o'clock in the evening of Nov. 13th, (1828.) In

an instant his intellectual faculties disappeared. His sentient faculties seemed to continue; for groans, and other evidences of pain did not cease. At midnight his body became insensible to pain. His groans ceased, and the mere simple living principle seemed to be all that remained. At one o'clock, on the 14th, the living principle was suspended. Death then becoming triumphant, his body was given over to the laws of chemical attraction. Could matter be divested of this last power, (attraction,) mere inert matter would remain. Hence I would infer, that the most perfect being which comes from the hand of the Creator, consists of *five principles*. 1, Inert matter—2, the attractive principle—3, the living principle, (so far even plants may go,) 4, the sentient principle (so far the lower orders of animals go,)—5, the intellectual principle, peculiar to man; being the immortal soul.

I need not add any remarks upon our five senses—seeing—hearing—smelling—tasting—feeling. No one has overlooked this fact.

4. *Alcohol, or spiritous liquors, from succulent fruits, farinaceous fruits, and herbage of plants.*—PROF. EATON.

I propose for a medical dissertation the following query. Are spiritous liquors obtained from succulent fruits, as grapes, apples, pears, and peaches, more inflammatory than those from grain, as wheat, rye, corn, oats and barley?

From some observations made on the effects of intemperance upon persons within my knowledge, I imagined, that the following results were clearly evinced. Those who drank wine, cider, perry, brandy, and cider-brandy, presented red, bloated, and highly inflamed surfaces. Those who drank gin and whiskey, became pale, and debilitated. Those who drank rum were at a medium in this respect. Hence I inferred, that, although *pure alcohol* is always the same, there is something combined with it, which influences its effects, and that alcoholic liquors from succulent fruits had a tendency towards the surface; that the same from farinaceous seeds, caused a recession of the fluids towards the heart, and that when derived from the herbage of plants, as the stalks of cane, its effects were of the medium kind.

5. *On the use of alumina with pigments designed for the pallet.*—In preparing his paints, by levigating pigments with oil, the artist is often perplexed by the diversities which they ex-

hibit after this operation. Some pigments present a chemical combination with the oil, while others can be suspended in it only by considerable labor, and soon separate when left at rest. These differences can be rendered of trifling importance, by employing such a substance as will retain those compounds which possess no attraction for the oil, in a state of uniform suspension and whose action will be in some respects analogous to that of the gum used in inks and water colors. The property which the hydrate or carbonate of alumina possesses, of mixing freely with oil so as to form a transparent, consistent, and almost colorless compound, admirably fits it for this purpose. At the request of Mr. Rembrandt Peale, I prepared some pigments by mixing them with alumina while moist. When ground with oil, he found them to possess all the most valuable properties of the best colors. The tendency to separate from the oil and the disagreeable property, which some colors possess, of becoming more fluid when an attempt to preserve them is made by immersing the pallet in water disappear, after they have been ground with a small portion of alumina. The artist has it in his power thus, to increase or diminish the fluidity of his paints and to render them uniform. Some pigments become valuable as glazing colors, as the Prussiate of copper, (Hatchette's Brown.) Vermillion and Naples Yellow, acquire new properties.

For printing from blocks, as in the manufacture of ornamental floor-cloths, it is often desirable to increase the fluidity of the paint, so as to prevent the dropping of small thread-like parts on the work, without causing it to spread. This may be accomplished, by adding a small quantity of whiting to the pigment while grinding; the artisan can then load his blocks with paint and consequently give a thick coating to the print.

A. A. HAYES, *Roxbury Laboratory.*

6. *On a fine scarlet pigment for the pallet.*—While prosecuting some experiments on the pigments employed by artists, I prepared a quantity of the biiodide of mercury and gave it to Mr. R. Peale, requesting him to make some experiments on its working properties and permanency. This distinguished artist, obligingly commenced them, but they were not finished, at the time he left this country. He found that it readily mixed with oil; combined with other colors



it gave delicate and beautiful shades and exposed for weeks to the direct rays of a midsummer sun, it remained unchanged. These properties induce me to recommend it as an addition to the number of pigments among which the artist can make a choice.

An economical process for preparing this salt, consists in boiling a mixture of one hundred and twenty five parts of Iodine, and two hundred and fifty parts of clean fine iron filings, with one thousand parts of rain water, in an oil flask. When the brown color of the liquid, is succeeded by a light green, the clear fluid is decanted and the residue washed with warm water; the washings being added to the green solution, two hundred and seventy two parts of corrosive sublimate, dissolved in two thousand parts of warm water, are then added to the former liquor and the resulting precipitate, is afterwards washed and collected.

This salt either in crystals, or in powder, presents two distinct and beautiful colors. If the precipitate, obtained as above, be heated in a small subliming apparatus, or in a glass tube, it melts and sublimes copiously, and the vapor is condensed in large transparent rhombic tables, of a fine sulphur yellow color. These crystals are permanent in the air and unaltered by the direct solar rays; but the slightest friction, or the contact of a fine point, is sufficient to alter their interior arrangement. The point of contact instantly becomes of a *rich scarlet* and the same color spreads over the whole surface if a single crystal, and extends to the most remote angle, if a group of crystals be the subject of experiment. This change of color is accompanied by a sensible mechanical motion, so that a small heap of the crystals, appears as if animated. An ordinary electroscope does not indicate the development of any electricity, nor is there any considerable elevation of temperature, during the change.

By gently warming the crystals supported on paper over the flame of a lamp, the original yellow coloured salt is obtained, and the same experiments may be often repeated; affording an elegant illustration of the connexion between colors and the mechanical structure of bodies. Transparent, but minute rhombic prisms of this salt, may be obtained by allowing a hot solution of it, in a solution of corrosive sublimate to cool very gradually.

A. A. HAYES, *Roxbury Laboratory.*

7. *Use of iodine in gout and angina pectoris; extract of a letter to the Editor from Dr. B. L. Oliver, dated Salem, Mass. Feb. 4, 1829.*—You have kindly inquired concerning my health. I have now the pleasure of stating to you, that the alarming symptoms of angina pectoris, which I have had for several years past, and which were relieved and kept at bay, by the use of a solution of the oxy-muriate of mercury, seem entirely to have yielded to the power of iodine. I took the medicine, dissolved in alcohol, of the strength of twenty grains to the ounce, thrice in the day; beginning with six drops, and gradually increasing it to sixteen or twenty. I think that I derived as much benefit from the iodine in a fortnight, as I had from the solution of sublimate\* in eleven months, and indeed I may say much more. I have never heard of the administration of iodine, in angina pectoris, until my trial of it. The circumstance which induced me to try it was, that I had seen a patient in this town, under the care of Dr. Choat, who had been cured of a fit of the gout by iodine, and had read, that a physician in Europe had, by the same agent, cured several patients suffering under the above malady. I therefore thought it not improbable, that when angina pectoris occurred in a gouty subject, it might yield to the same medicine. My father and great grandfather, were subject to gout; and it is not improbable that I may have a gouty habit. I have not, however, had any regular fits of the disease, but it may perhaps have been a cause of the angina pectoris, under which I have suffered for years. I think that I have known several patients that did not complain more than I have done, that have died very suddenly. They have generally been persons that thought the complaint so slight as not to require the taking of medicines, or putting themselves under medical care.†

---

\* The solution of corrosive sublimate in this disease, was first recommended by Dr. Fisher, of Beverly, (Mass.) who has cured several patients with it.

† Besides my own case, I know of two other cases which have been relieved, and the disease at least suspended by the iodine. I am not ignorant that the angina pectoris has been cured by several other remedies, as by issues recommended by Dr. McBride, by nitrate of silver, by the arsenical solution, by sulphate of zinc, by the application of a solution of tartar emetic, (Mem. in the Memoirs of the London Medical Society,) and in our own country by Dr. Hosack, by bleeding and evacuations. But perhaps they have all sometimes failed; hence the use of a new remedy. Sometimes the disease may arise, no doubt, from such organic affections as will admit of no remedy, and of course must be mortal.

Perhaps sir, if you could find a place in your Journal for the above article on iodine, it might be the saving of some lives, or at any rate, it would give a new peg to hang a hope upon, and thus tend to relieve the patient from that constant dread of impending death, which places him in a situation like that of the person at the feast of the tyrant of Syracuse, who found himself sitting under a sword suspended by a hair.

8. *Notice of the manufacture of the chloride of lime, and of some of its leading uses, in a letter from Mr. G. W. Carpenter to the Editor, dated Philadelphia, Jan. 1829.*—The chloride of lime is manufactured on a very large scale, at the Maryland chemical works at Baltimore. A large chamber lined with lead is made use of, and about 5000 lb. of hydrate of lime is placed thinly on moveable shelves, the chlorine gas is then introduced into the chamber and is absorbed by the lime, the top shelves are saturated first, the lime is then stirred and the shelves reversed, the top placed at the bottom and the bottom at the top, and so on through the whole, introducing additional quantities of chlorine as the shelves are transposed and the gas absorbed or united. The chloride thus made is considered fully equal to the best bleaching salt which can be imported.

It is, you know, an article extensively employed in the arts; especially in bleaching; one grain of it will destroy the coloring matter of two grains of the best Spanish indigo. Although the chloride of lime is applicable to so many important purposes, still its usefulness is as yet so little known, that I will select a few, from its various important applications.

It is generally employed in solution, which is made in the proportion of four ounces to one pint of water, and as only about one half of the lime is dissolved, it will be necessary to filter, in order to obtain the clear solution. Dilute one part of the liquid with 40 parts of water, a pint with five gallons, or a wine glass full to three quarts of water, stir the mixture and it is then fit for use. It is the most powerful, disinfecting agent hitherto discovered, and an instantaneous destroyer of every bad smell. It is an infallible destroyer of all effluvia, arising from animal, and vegetable decomposition, and effectually prevents their deleterious influence, hence, it is particularly recommended to the attention of those, residing in epidemic districts, as there is reason to expect, that the mixture sprinkled about apartments would prevent the access

of contagion to a certain extent around. Its value will be appreciated by the faculty in examinations for inquests, dissections and anatomical preparations. For all these desirable purposes, it is only necessary to sprinkle the diluted liquid in the apartment, or on the object requiring purification.

The effluvia from drains, sewers, and other receptacles of the same nature, will be destroyed by pouring into them a quart of the mixture, added to a pailful of water, and repeating the operation until it is completely removed.

Tainted meat, and animal food of every kind, may be rendered sweet by sprinkling them with the mixture. Water in cisterns may be purified, and all animalculæ destroyed, by putting into it a small quantity of the pure liquid, say about half a pint to one hundred and twenty gallons of water, and consequently it is highly valuable on board ships.

The nuisances arising from disagreeable and unhealthy manufactories, may be equally obviated by the mere sprinkling of the chloride of lime, and the health of the workmen very materially preserved in such deleterious processes as the preparation of oil colors. It destroys the smell of paints so effectually, that a room painted in the day may be slept in at night, without any smell of paint being perceived, if it be sprinkled some hours before with the mixture.

Smelters of lead, glue and size makers, tallow and soap manufacturers, skin dressers, &c. may deprive their premises of all offensive smell, by the same processes. The close and confined air of hospitals, prisons, ships, &c. will be almost instantaneously purified by sprinkling the diluted chloride of lime in small quantities from a watering pot. The stains from fruit, &c. &c. may be removed from table linen, &c. by dipping the article stained in water, applying the chloride of lime until the stain is removed, and then rinsing well in cold water previous to being washed.

The chloride of *soda* has lately been most beneficially introduced into the materia medica. The chlorides have the instantaneous effect of arresting animal and vegetable decomposition, more especially, when generated in certain putrid disorders. It appears evident, that chlorine acts chemically upon the pernicious matter, and resolves it into innocuous principles; the application of the chloride of soda is therefore limited only by animal and vegetable decay, and the cause of its action in the following instances, extracted from M. Labarraque, will be readily perceived, viz. carbun-

cle, hospital gangrene, ill conditioned ulcers, gangrenous sores of the worst description; the fetid discharge of cancer, herpes ulcerata, porigo favosi, atonic ulcers, ulcers of the uterus, mortification, &c. &c.

The proportions to be used vary of course with the virulence and state of the disease; when applied externally the weak solutions, frequently repeated, are likely to be more effectual than the stronger mixtures. From the French mode of preparing it, the use must be suspended when the sores are red and inflamed. In this country it has been most successfully used in all the foregoing cases; as a gargle in ulcerated sore throat, pyalism, and tumours. Diseases of animals of a similar nature will be cured by the same means.\*

9. *Specimens in Materia Medica, Pharmacy, and Chemistry.*—We are informed that Mr. George W. Carpenter, No. 301, Market-street Philadelphia, puts up complete collections of chemical and pharmaceutical preparations, with the various subjects of the materia medica, embracing an entire suite of specimens, to illustrate lectures on pharmacy and materia medica, giving a full and complete idea of each species, from their physical and sensible properties and external characters, by which the genuine, and inferior or spurious, may be recognised and distinguished; also articles resembling each other in external characters, such as color, crystalline form, &c., as epsom salts, oxalic acid, sulphate of zinc. The different varieties of Peruvian bark, with the quantity of quinine they respectively contain, the varieties of opium, rhubarb, ipecac, jalap, &c. &c. and the articles they are generally adulterated with. These specimens have been found highly useful in public lectures, and are in fact, almost indispensable in a course of instruction. We understand that Dr. Carpenter has furnished collections for the medical colleges of Pennsylvania, New York, North and South Carolina, and Virginia, to the entire satisfaction of their respective professors, and that a similar collection has been ordered by Prof. Ives, for the Medical Institution of Yale College. The specimens are neatly put up in square bottles, handsomely labelled and fully described at 40 cts. a specimen; a complete suite consists of about one hundred and twenty specimens.

---

\* The chlorides of lime and soda may be procured from Carpenter's Chemical Warehouse, 301, Market St. Philadelphia—price, by the small quantity, 25 cents per lb.

10. Patent "*for an improvement in the construction of ships, steamboats and other vessels and boats as respects their metallic fastenings, and sheathing, by John Revere.*"—At the meeting of the Lyceum of Natural History of New York, March 17th, 1829, Doctor Revere communicated to the Society the results of an experimental investigation of the electro-chemical relations of iron and some of the other metals with a view to their application to the useful arts, especially ship building. After adverting to the different substances that have been employed for the fastenings and sheathing of vessels, and the advantages and disadvantages of each, he pointed out the great superiority of iron for the fastenings of that stupendous, moveable fabric, a modern ship, in every respect, except its liability to oxidate in sea water, especially when the vessel is sheathed with copper. He remarked that with this exception, iron combines for this purpose all the valuable properties of all the other metals. It is most abundant; its malleability is sufficient for all useful purposes; in strength or tenacity it surpasses them all, being in this respect to copper as five hundred and forty nine to three hundred and two, and it possesses the property of being welded, which is peculiar to it and platinum. Having pointed out the cause of the rapid oxidation of the iron fastenings of vessels when sheathed with copper, which was first suggested by Fabroni, viz. a galvanic influence; and having spoken particularly of the admirable researches of Sir H. Davy on preserving the copper sheathing of ships, he observed that since it was so desirable an object to use iron fastenings, and inasmuch as the cause of the rapid decay of the iron fastenings in copper-sheathed vessels was understood, it seemed to him surprising that no one had attempted to correct this defect by means founded on this knowledge. In the autumn of 1826, he formed the resolution of undertaking the solution of this problem but did not commence his experiments until the spring of 1827; and from that time to the present, this experimental investigation had occupied all his leisure. He observed, that the problem first proposed to himself was the preservation of the iron fastenings in copper sheathed vessels, but that as he advanced in the inquiry, he became satisfied of the practicability not only of preserving the iron fastenings under these circumstances, but also of employing iron sheets for sheathing. He added that he now thought himself authorized to announce to the Society

that he had demonstrated the practicability of accomplishing both these objects, by electro-chemical agency. He then exhibited to the Society two iron spikes which after being filed bright, had been driven into a block of wood, and kept immersed in sea water since June 14th, 1827. A part of one of the spikes had been accidentally exposed in chipping the block in consequence of a knot in the wood; the heads and the parts of the spike exposed were bright as at first, and without the slightest appearance of corrosion. He also placed before the Society a small iron plate which had been scoured bright and fastened with iron nails to a piece of board. This had been likewise immersed in sea water since June 14th, 1827—the iron plate exhibited its metallic lustre without having undergone the slightest oxidation. Dr. R. concluded by remarking, that the chief merit to which he could aspire was having perceived the practical value of the inquiry and perseveringly followed in the path indicated by Sir Humphrey Davy; that the practical importance of the subjects as connected with many of the useful arts must be apparent to all; that his object at present was merely to announce to the Society some of the results, but that he proposed at a future period to publish an elaborate account of this investigation. He invited the Society to examine his experiments made on a larger scale, and among others a boat sheathed with iron, and placed at the Navy Yard at Brooklyn.

### 11. *Steam Pump.*

Communication.

West Point, Feb. 15, 1829.

*Sir*—I take the liberty of laying before you the result of some experiments made with the *steam pump*, an invention described in this Journal, Vol. XIV, p. 169.

The experiments were made at the West Point foundry, where a machine has been constructed of cast iron. The boiler used is fifty inches in length and fifteen in diameter; giving a surface exposed to the fire of about ten square feet, or sufficient for a one horse engine of the usual kind. The cylinders or receivers are each of about three cubic feet or twenty four gallon capacity. The pumps are fifteen feet high and four inches in diameter. The escape tubes are ten inches long and of diameters the same as the pumps. The operation of the machine was to make five strokes per minute, or to fill and discharge one receiver three times and the

other twice in a minute. Now after making the greatest deductions for incomplete strokes that can be demanded, there will remain, for the actual performance of the machine, at least eighty gallons of water, raised fifteen feet. It is to be observed that, as the steam is used in precisely the same manner, whether the receivers are twenty feet or but one foot high, there will be the same quantity of steam used in the above machine, as though it were to work at its greatest height, or about twenty eight feet. The maximum effect then of the steam that would move a one horse engine, when applied to work the above machine, will be to raise eighty gallons of water twenty eight feet per minute.

The work of a horse of the average strength, is found, when reduced to the raising of water, equivalent to raise seventy gallons, twenty five feet per minute, one fifth less than the above performance.

But let it be supposed that the work of this machine is the same, or something less, than the power of the same steam, as commonly applied: it is obvious, that for many purposes, it would be beneficial to use it as a mechanical power; for instance, where fuel is cheap, and the required power will not be sufficient for an expensive engine.

The principal object proposed by this invention, is to afford a cheap method for raising water, where it is required to be raised in large quantities, to heights less than twenty eight or twenty nine feet. It will be seen that the expense of all working machinery will be saved by this invention, as well as the force lost by keeping it in motion, two very material points in the use of machinery.

It is believed that this machine could be used to great advantage in *dry docks*, and for all other purposes where water is required to be raised in a similar manner. These are the objects of the invention, and should any farther explanations be thought necessary, they will be promptly furnished.

G. W. L.

12. *Efficacy of ammonia in counteracting poison; extract of a letter from Dr. Austin Church to the Editor, dated Cooperstown, N. Y. Feb. 6, 1829.*—A young man in this place had accidentally upset a hive of bees, and before he could escape, they had settled, in great numbers, on different parts of his body and limbs and stung him very severely. It was about half an hour after the accident happened, when he came to



my office in great agony, and he had scarcely time to give an account of it before he fainted. I immediately applied the ammonia to the parts that had been stung, his legs, arms and breast. He directly recovered from his faintness, and experienced no pain or other inconvenience afterwards.

It is several years since I first used the aqua ammoniæ, to counteract the effect of the bites of insects and stings of bees, and it has invariably produced instant relief—generally complete. I have often seen children crying in excessive pain from the sting of a bee, and on the application of the ammonia they would immediately cease complaining and become cheerful; so complete and sudden is the relief it produces. I always use it for musquito bites, and they never trouble me farther. I was led to the use of it in these cases, from the instantaneous effect it was said to have in counteracting the operation of prussic acid. In the second number of the American Journal of Medical Sciences, (Philadelphia,) for last year, it will be seen that Dr. Moore, of Alabama, used it with great success in the cure of bites of venomous serpents. From his account, it is probable that the pure uncarbonated aqua ammoniæ is most efficacious. I have sometimes noticed that the application is more efficacious than at others, and I think it must be on account of its being sometimes carbonated and at others not.

### 13. *Atomic Weight of Mercury.*

(Communicated.)

In a recent examination of the powder, supposed to be a protoxide of mercury, my attention was turned to the subject of the atomic weight of mercury, and upon applying to some of its combinations, the generally received theory, that binary compounds are more difficult of decomposition than ternary, I have been led to the conclusion, that its equivalent number has been mis stated by chemical writers.

The protosulphuret and protochloride, are both more easily decomposed than the compounds containing double the proportion of their respective electro negatives. The only cyanide of mercury is now considered as containing two atoms of cyanogen. The protoxide I believe exists only in combination with acids.

I have very frequently decomposed several of the proto-salts of mercury with alkalis, and the resulting powder has uniformly contained metallic globules, either visible to the

naked eye, or easily rendered so by a slight degree of friction with my finger; the pressure attending which could only have brought already existing uncombined particles within the sphere of each other's attraction. When calomel (protochloride of mercury) is decomposed by an alkaline solution, if the latter be cautiously dropped upon it, a reddish powder is at first apparent.\* This fact and the subsequent evidence of the existence of metallic mercury in the powder, may serve to explain each other. A *muriate* of the alkali is formed at the expense of a portion of water, and the oxygen being left to the free exercise of its affinity, forms with half of the metal—a binary compound—the red oxide, through which the remaining proportional of mercury, in a state of extreme comminution, is mixed. The powder will be found capable of amalgamating gold, and the uncombined metal may be rendered evident, by friction, percussion, or elevation of temperature, or by pouring upon it a minimum quantity of diluted acetic acid. The supernatant liquor will contain peracetate.

I do not know that more conclusive evidence of an error in the atomic weight of any body could be adduced. Annexed is a table of the corrected atomic weights of a few of the mercurial combinations.

SAMUEL ALLINSON, Jun.

Philadelphia, 11mo. 11th, 1828.

	<i>Proportions by analysis.</i>	<i>Atomic Proportions.</i>	<i>Atomic Weights.</i>
Suboxide, - - - -	100M + 4Ox	2M + 1Ox	208
Oxide, - - - -	100M + 8Ox	1M + 1Ox	108
Subchloride, - - - -	100M + 18ch	2M + 1ch	236
Chloride, - - - -	100M + 36ch	1M + 1ch	136
Subiodide, - - - -	100M + 62I.	2M + 1I	324
Iodide, - - - -	100M + 124I	1M + 1I	224
Subsulphuret, - - - -	100M + 8s.	1M + 1s	216
Sulphuret, - - - -	100M + 16s	1M + 1s	116
Cyanide, - - - -	100M + 26c	1M + 1c	126

\* A careful repetition of this experiment has placed its accuracy beyond a doubt. On calomel, (prepared by precipitation from a solution of crystallized protonitrate of mercury, with muriate of soda) which was repeatedly washed with warm distilled water, with solution of muriate of ammonia and with warm alcohol, I dropped a small quantity of potass water. A reddish powder was very distinctly observable. When sufficient alkali was added to decompose all the calomel, the powder was of a brownish black color, and when dry contained visible globules of metal. This shows the fallacy of one of the reputed tests for the purity of calomel.

14. *Novaculite in Georgia.*—*Extract of a letter to the Editor, from Mr. J. C. Keeney, dated, "Sparta Female Academy," Jan. 16th, 1829.*

"I take the liberty of addressing you relative to a mineral which I have been examining, and pronounced novaculite, believing it identical, if not with the Turkey oil stone, with that found in N. Carolina, and described, I think, in the thirteenth volume of the American Journal of Science and Arts.

"Since I came to this conclusion, I polished a specimen of it, and prepared it by boiling in oil, after the manner of the Turkey oil stones, and put it into the hands of a carpenter, who, after trial, pronounced it 'a Turkey oil stone of a superior quality.'

"This mineral is found in Lincoln and Oglethorpe counties, Georgia. I have recently visited the locality in Lincoln. It is situated on a low hill, about two miles from Lincolnton court-house. It is seen projecting above the surface of the earth, through four or five acres of ground, and is therefore probably quite extensive. It is found very much inclined, or nearly in a vertical position. There are several varieties of color in the same locality. That which is found exposed to the atmosphere, is mostly of a yellowish straw color; but that which is taken from beneath the surface of the earth, is mostly of a greenish white, a fair specimen of which I now send you."

Prof. D. Olmsted, to whom we have exhibited the above named specimen, and who, from his familiarity with the extensive beds of novaculite in North Carolina, is well qualified to judge, agrees in opinion with Mr. Keeney; and if it were of any importance, we could add our own assent.—*Ed.*

15. *Notice of the locality of the Bronzite, Jameson; or Diallage metalloide, Haüy and Brongniart; at Amity, Orange county, State of New York; by J. Finch, Hon. Mem. West Point Lyc. Nat. Hist. &c.*

On an excursion, in the autumn of 1828, over the calcareous formation of Orange county, and the Northern part of the state of New Jersey, accompanied by Wm. Horton, Jr. M. D. of Goshen, N. Y. and Lieut. Mather of the U. States' Army, we discovered the above mentioned mineral, which had not, I believe, been previously noticed in the U. States.

The Bronzite occurs in foliated masses, composed of laminae, which vary in size, from minute scales, scarcely two lines

in diameter, to large plates, eight or ten inches in length, and six or seven inches wide; sometimes, though rarely, it is found in thin hexahedral tables.

The laminæ vary from one tenth part of a line to two lines in thickness; they are usually parallel to each other, but are sometimes divergent, and at no very uniform angle; they are generally straight, but sometimes curved, and are occasionally separated from each other by thin plates of calcareous spar. They are traversed by seams dividing the whole surface into very minute rhombic tables, which are also crossed by other lines, that pass through them obliquely or diverge from a centre.

The plates will usually break, in a direction perpendicular to their surface, without separating any of the laminæ which adhere together with such tenacity as to require a considerable degree of force to divide them. Cross fracture of the plates uneven and splintery.

The surface of the laminæ, exhibits a constant and brilliant metallic lustre, so strong as to reflect very distinctly the images presented to it. Color, deep brownish red, varying occasionally in some specimens to a copper color; the powder, after it has been acted upon by acids to free it from the carbonate of lime, is of a beautiful orange red.

It is infusible when exposed to the action of the blowpipe, but loses its color.

The thin laminæ, are usually translucent, sometimes transparent; the foliæ are opaque or but slightly translucent on their edges.

It marks glass with difficulty.

Specific gravity, 2.86; but as the specimen which was experimented upon contained some calcareous spar, it is probable that pure specimens would be 3.0 or even 3.10, which latter may perhaps be regarded as a near approximation. The bronzite occurs disseminated in a vein about four inches wide in calcareous rocks in a field about two hundred yards from the church at Amity.

It is associated with brown and red brucite or condrodite, xanthite, talc and graphite, crystalized magnesian carbonate of lime and spinelle.

16. *Note on the presence of Iron in the Salt Springs of Salina, N. Y. by Lewis C. Beck, M. D.*—The question whether the Salina waters contain iron has been frequently discussed. Drs. Benjamin Dewitt and McNevin, and Mr. Chilton, in their analyses do not mention it as an ingredient; and the only affirmative statement is by Dr. Noyes, who conducted his researches in iron kettles, and whose testimony on this point is therefore open to objection. In the paper which I published upon these waters, I stated the reasons which induced me to believe that they did not contain iron. These were that the ferrocyanate of potash and nutgalls, did not produce the changes of color to be expected from the presence of any of the known salts of that metal.

In a notice of the Salt Springs published in a late number of your Journal, (Vol. 15. pa. 6,) by Mr. Stephen Smith, my analysis is quoted with the remark, that there is an omission of the iron, "which evidently exists in the salt water of every spring discovered in this vicinity." The experiments which the author adduces in proof are as follow. "Water has repeatedly been taken from the different wells, as it flowed in from the earth, and where it could not possibly have been in contact with the iron of any part of the pumping machinery, and on scraping into it some nutgalls with a piece of broken glass, there has been observed, in a short time, a change from limpid transparency to a purple color, which soon became green and finally of a reddish brown; and after standing two or three weeks, there was a dark brown deposit that covered the bottoms of the tumblers in which the experiments were made."

Now whatever may be the final decision upon this point the facts above presented are in no degree conclusive. Nay, the changes of color here described, are I believe in no case, offered by a combination of galls and iron. The only change occurring under these circumstances is from that of a blue or purple to a black, which last is invariably the color of the precipitate when it is exposed for any length of time to the air.

The facts stated by Mr. Smith may, I think be satisfactorily accounted for without the necessity of referring them to the presence of iron. The Salina waters are known to contain lime in various states of combination. Gallic acid, one of the constituents of the gallnut, is also known to com-

bine with lime and to afford an insoluble precipitate of a brownish color.

The following experiment which I have often performed, and which may be easily repeated will show the fallacy which attends Mr. Smith's conclusion on this point.

To some perfectly limpid lime water, previously ascertained by the ferrocyanate of potash, to be free from iron, add a few drops of infusion of galls. The whole immediately assumed a purplish color, and in a short time there is deposited at the bottom of the vessels a greenish brown precipitate.

It may not be amiss to refer to higher authority. According to Dr. Thomson, gallic acid when dropped into barytes water, strontian water, or limewater gives them a bluish red color and occasions a flaky precipitate composed of the acid combined with the earth. (Vol. 2. p. 158 Amer. Ed.) The same fact is mentioned by Thenard and Brande, the latter of whom states the precipitate to be of a brownish color. This acid also decomposes the earthy carbonates.

Again "when barytes, strontian or lime water is poured into the infusion of galls, an olive colored precipitate falls, which consists not only of tannin, but also of the extract and most of the gallic acid combined with the earth." (Thomson Vol. 2. p. 158.)

But I need not occupy time with other quotations. I may however remark, that the difficulty which attends the detection of iron has been sufficiently shown by Mr. Richard Phillips in his "analysis of the Bath Water;" where it will be seen that other processes, besides mere precipitation, are necessary to prove its existence.

### 17. *Tin in Massachusetts.*

AMHERST, March 10th, 1829.

*To the Editor of the American Journal of Science.*

SIR—I am happy in being able to send you herewith a specimen of genuine *New England Tin*. I can indeed spare you but a very small quantity—only a single globule, reduced before the compound blowpipe: yet, as it is well characterized, and the first, if I mistake not, that has been found in the United States, I trust that it will prove acceptable.

It occurs at Goshen, Massachusetts; at the well known locality of spodumene, limpid and rose beryl, rose mica,

green tourmaline, indicolite, and siliceous feldspar, three miles north west from the center of the town, on the farm of Mr. Stearns. I have found only a single crystal, which I obtained several years ago, in the granite containing the above minerals: but I did not examine it till lately. A recent visit to the spot did not furnish me with any additional specimens.

The prevailing rock in the vicinity is mica slate, with occasional veins and beds of granite. At the spot no granite appears in place; but numerous large bowlders are scattered over an extent of several rods, where there appears to be a considerable depth of soil. Unquestionably these were broken up from a bed or vein beneath. It may be hoped, therefore, that further research will discover a deposit of this interesting metal: For in Cornwall "it is generally in the vicinity of a vein of tin ore, that disseminated grains of tinstone are found in the rock."

The specimen which I found consists of a single crystal, weighing about fifty grains: or rather of a portion of one large crystal, with parts of several smaller ones, projecting from it *hemi-tropically*. The form is evidently an octahedron, with a square base; but its angles, as measured with a common goniometer, differ several degrees from the measurements of the primary form of tinstone, as given by W. Phillips. His results (making use of Brooke's notation) are,

P on P' 133° 30'

P on P'' 67 52

That from Goshen gives

P on P' 125°

P on P'' 86

Whence this discrepancy arises I am unable to say. I would suggest, however, that it is not impossible, that I have mistaken the true form of the crystal; as only a few of its faces are exhibited in perfection.

As to the external characters of this mineral, it will be sufficient to say, in general, that they correspond almost exactly with the oxide of tin from Cornwall and Bohemia. Its specific gravity is 7.14.

On charcoal it was readily reduced before the oxy-hydrogen blow pipe, without decrepitation; and after reduction, it burnt with the brilliant white light of tin. Tinstone from Bohemia was not reduced so easily.

In order to ascertain whether the reduced globule would give the crackling sound, so striking in metallic tin, I placed

it between my teeth; and upon pressing it between them, I was surprised at the distinctness with which this property could be perceived.

The quantity reduced was so small, and the balance I used so poor, that I could not ascertain very accurately the specific gravity of the metal. It appeared however to be not far from 7.

In color, hardness, and malleability, it corresponds exactly with common tin.

“In muriatic acid, with a gentle heat, it was entirely dissolved. Hence I infer its comparative freedom from those alloys which remain as a black powder when common tin is dissolved in this acid.

While the solution thus obtained was in the state of a protomuriate, the following tests of tin were applied. For comparative experiments, a piece of common block tin was dissolved in muriatic acid, and the same tests applied. *In every case the results were exactly alike.*

1. Muriate of platinum gave a deep orange precipitate.
2. Muriate of gold, a purple do.
3. Ferrocyanate of potassa, a white do. slightly tinged with blue.
- \*4. Perchloride of mercury, a white do.
5. Protosulphate of iron soon acquired the reddish hue of the persulphate.

The following tests were tried to ascertain whether the metal under examination were not cadmium. They are given by Joyce in his Practical Chemical Mineralogy, page 225. Here too comparative experiments were made with the solution of block tin, and the results corresponded precisely with those on the metal from Goshen.

1. Pure caustic potassa gave a slight precipitate, of a white color.
2. Aqua ammonia, a white do. *not soluble in excess of ammonia.*
3. Hydrosulphuret of ammonia, an orange do. *inclining to brown.*

The second experiment would seem, according to Joyce, to indicate that the metal under examination is not cadmium.

\*Joyce in his Practical Chemical Mineralogy, states that this test gives a black precipitate with tin: but this is obviously a mistake.



Upon the whole, there seems no reason to doubt that it is genuine tin.

Respectfully yours, &c.

EDWARD HITCHCOCK.

18. *A mineralogical and chemical description of the Virginia Aerolite*;\* by Charles Upham Shepard, Assistant to the Professor of Chemistry and Mineralogy in Yale College.—Since collections of meteoric stones have begun to be formed, and a more nice attention to be bestowed upon their differences and resemblances, our information concerning their nature, as might have been expected, has been greatly augmented; and although we may still be far from solving the curious problem of the origin of these singular bodies, we are nevertheless certain, that a minute observation of all the facts connected with the subject, affords the only rational promise of our ultimately attaining so desirable an object.

In giving a description of the Virginia aerolite, I shall in the first place consider the specimen before me in relation to its compound character, or, so to speak, as a rock; and afterwards I shall attempt to point out the nature of the individual substances of which it is composed.

The weight of the fragment is a little short of two pounds, which is about half that, as we are informed, of the mass from which it was detached. That portion of the external surface which remains in the specimen, indicates that the entire piece was less oval in its figure than is usual in these stones. Besides this difference in general shape, the surface exhibits hollows and circular cavities, some of which are half an inch in diameter and about the same in depth; and is invested with the black coating which always accompanies such bodies, although this is interrupted in a few places, and no where appears to have resulted from a very perfect fusion.

Its interior, at first glance, reminds one very forcibly of certain volcanic rocks. Its color is a bluish ash grey, interspersed with a sprinkling of white, and here and there with specks of brownish rust. It contains numerous ovoidal, irregular shaped cavities, varying in size from one tenth to half an inch in diameter, which are lined in many instances with brilliant metallic crystals. Its compound character be-

---

\* Which fell seven miles from Richmond, Virg. June 4, 1828—for the particulars, see Vol. 15, pa. 195 of this Journal.

comes sufficiently obvious on bringing it near the eye, when it appears to be composed principally of a bluish grey substance, in globular masses, from the size of a mustard seed to that of a pea, and a white, loosely cohering mineral: the former in much the largest proportion. After these, on closer inspection, are visible minute hook shaped, and sometimes slightly flattened globular masses of a metallic nature, which are often partially coated by rust, and minute steel grey grains and crystals, which for the most part occupy the cavities before mentioned, and are sometimes arranged so as to resemble the characters used in the eastern languages. Besides these, by the aid of a microscope, we discover occasionally a greenish transparent laminated substance, and more rarely a honey yellow mineral in minute grains.

In comparing it, in its general aspect, with such meteoric specimens as the cabinet of this college embraces, we observe in it a considerable resemblance to the Weston aerolites. Like these, the two substances of which it is chiefly composed are in masses sufficiently large to appear quite distinct to the naked eye, although from the description already given, it will be perceived that it differs considerably even from them, by its numerous cavities and their crystallized contents. It differs very essentially from the Maryland stones, which are almost wholly made up of a white feldspathic substance; as well as from those of l'Aigle and Stannern, the former of which being quite compact and homogeneous, and the latter abounding mostly in albite.

The firmness of the Virginian stone is superior to that of either of those above mentioned, except perhaps those of l'Aigle, it requiring a pretty smart blow of the hammer to produce a fracture, and the small masses refuse to separate by the mere strength of the fingers. Its specific gravity, as determined in two fragments, one weighing 82.3 grs. and the other 38.5 was 3.29, and 3.31.

After these observations upon the general character of the specimen under examination, I proceed to the separate description of the minerals it contains.

### 1. *Chrysolite.*

The globular shaped bodies which compose the chief part of the Virginia aerolite are thus denominated, because in their mineralogical characters, they approach very closely our species chrysolite. I offer the following *description of its characters.*

External shape spheroidal, or sub-angular.

Structure lamellar, cleaving in two directions; at right angles to each other, or as nearly so, as the perfection of the planes will allow us to observe. One of these cleavages is effected with greater ease than the other, and presents imperfect horizontal striæ. The lamellar structure is often interrupted by a sub-conchoidal fracture.

Lustre vitreous, and splendent in the most perfectly cleavable masses, but glimmering only, on the conchoidal surfaces. Color grey, often with a tinge of blue, and rarely, olive green. Translucent on the edges, and in a few instances, transparent.

Hardness equal to that of crystallized adularia: the one impressing the other, only when great mechanical violence is exerted. It scratches the crystallized pyroxene of Mussa.

Specific gravity was determined upon a mass, which before its fracture into two pieces, weighed 6.1 grs.; the entire mass gave 3.3, and the largest fragment 3.38. Another mass weighing 3.4 grs. gave a specific gravity of 3.90. The mean of the three experiments is 3.259.

#### *Chemical Examination.*

Before the blow pipe, in small fragments, with the most intense heat that could be urged, it fused with ebullition upon its thinnest edges into a shining black glass, and the fragment became immediately attractable by the magnet. With borax, in powder, it dissolved, forming a greenish transparent glass. With carbonate of soda it entered into fusion, with difficulty, becoming transparent, or nearly so in the full heat of the blowpipe, but immediately turning dark reddish brown and becoming opaque on being removed from the flame, and finally changing to white. With microcosmic salt, it dissolves with readiness, and the glass assumes a deep straw yellow color, which on cooling becomes of a paler tinge and contracts a degree of cloudiness.

1. A small portion of the mineral reduced to the state of an impalpable powder was introduced into a flask upon which diluted muriatic acid was affused. To the flask was fitted a glass tube to deliver over the gas which might be extricated, into a vial containing a solution of acetate of lead. A gentle heat was applied to the flask, when sulphuretted hydrogen gas made its appearance and the precipitation of the lead commenced. The apparatus was disengaged as soon as it was perceived by the smell (through the means of

a glass tube coming from the flask, upon which the finger was placed, and which was used as a safety tube to prevent the contents of the vial from rushing over into the flask) that the evolution of sulphuretted hydrogen had ceased. Floculi of silex were seen floating through the solution, thus indicating that the integrity of the substance was partially overcome. It was separated from the insoluble residue by the filter, and a stream of chlorine gas passed through it, to bring the iron it was supposed to contain, to the maximum of oxidation.

2. A portion of the solution (1.) was decomposed by ammonia. The precipitate was of a deep reddish brown color, and the supernatant liquid remained perfectly colorless.

3. The colorless liquid (2.) was evaporated to dryness in a platina capsule, over an alcoholic lamp. As it approached to dryness, a smart decrepitation was noticed. The residue was heated to redness, after which, water was boiled upon it for a few moments, and the solution separated from the insoluble part by the filter.

4. To a portion of this solution (3.) oxalate of ammonia was added, which occasioned no cloudiness.

5. To another portion was added nitrate of silver: a precipitate immediately made its appearance.

6. Another portion contracted no cloudiness from muriate of platina or tartaric acid.

7. A portion of the solution (3.) was now evaporated nearly to dryness, and set aside to crystallize by spontaneous evaporation. After the liquid was entirely evaporated, small cubic crystals were seen by the aid of a magnifier.

8. The residue, (3.) not soluble in water, was treated with muriatic acid, in which it was immediately taken up. To the solution was added carbonate of potash: no precipitate made its appearance until after the ebullition of the liquid, when a copious one ensued.

9. The precipitate by ammonia (2.) was dissolved in muriatic acid, and to the liquid, rendered neutral by evaporation, was added a few drops of chloride of lime: no red flocks made their appearance.

10. A part of the original muriatic solution was decomposed by potash in excess, and after being boiled for some time was separated from the precipitate. To it was added muriate of ammonia, which occasioned no cloudiness.

11. The portion of the stone (1.) which refused to dissolve in muriatic acid, was treated with double its weight of

potash, and heated to redness for half an hour in a silver crucible. The mineral entered into perfect fusion, and the mass assumed an intense green color. By the affusion of warm water, it was transferred to a wedgewood capsule, and on the addition of nitric acid, a clear yellowish solution was obtained.

12. The nitric solution (11.) was evaporated to perfect dryness, in order to decompose the nitrate of iron and separate the silic. Warm water was added to the residue, and a solution of a yellow color was formed, leaving behind the oxide of iron and silic.

13. To the yellow solution (12.) was added proto-nitrate of mercury, which occasioned an orange colored precipitate: this when dried and heated assumed a grass green tinge, and communicated to borax while in a state of fusion a deep green color, but in cooling, it faded to a pale yellow.

The conclusions which these trials enable us to form, with regard to the composition of the mineral under examination, appear to be the following. No. 1. proves the existence of sulphur; though with regard to this ingredient, subsequent trials, in which I repeated this experiment upon larger quantities of the mineral, without obtaining any very appreciable precipitate, satisfied me that it was wholly due to minute particles of the proto-sulphuret of iron (a substance hereafter to be noticed) adhering to the surfaces of the globular masses of our mineral. No.'s 2. and 3. prove the absence of nickel, and 4. that of lime. No. 5. exhibits the presence of an alkali, which 6. and 7. prove to be soda. No. 8. shows the existence of magnesia; 9. and 10. the absence of manganese and alumine: and 13. the presence of chrome. Besides the above mentioned ingredients, silic and oxide of iron are to be added, whose existence in a large proportion became sufficiently obvious during these trials.

I went through the process of analysis by fluoric acid, invented by Berzelius, with the hope of ascertaining the proportion of the soda, adopting the expedient of Rose for the separation of the sulphates of magnesia and soda,\* but as I was operating upon 10 grs. only of the mineral, the quantity of carbonate of soda was too trifling to enable me to ascertain its weight with precision.

---

\* Ann. de Chim. t. xx, p. 334.

In two trials also, which I made, one upon 14 grs. and the other upon 20 grs. of the mineral, to learn if possible the exact proportion of chrome it contained, (in one instance separating it from its acid combination with potash, by the addition of muriate of barytes, and in the other by the proto-nitrate of mercury,) I became satisfied from the smallness of its proportion, which was such as to prevent my estimating it by weight, that it did not form an essential ingredient in the composition of the mineral.

After these preliminary experiments, I entered upon the following

ANALYSIS.

A. 17.8 grs. reduced to powder, were mingled with double their weight of potash and 10 grs. of nitrate of potash. The mixture was kept at a red heat in a silver crucible for one hour. The calcined mass which had evidently undergone fusion, presented a yellowish green color, which it communicated to its solution in water. On the addition of nitric acid, the fused mineral became perfectly soluble, with the exception of a few white flocculi of silex, which were seen floating through the solution.

B. The nitric solution was evaporated to dryness, in which state it was kept at a heat of  $212^{\circ}$  for upwards of half an hour, to ensure the complete decomposition of the nitrate of iron and the separation of the silex. The dried mass, which was reduced to the state of a powder, and frequently stirred, assumed throughout a deep reddish brown color. Warm water was now affused, and the oxide of iron and silex separated by means of the double filter.

C. This solution, (B.) reduced by evaporation to a convenient bulk, was boiled for upwards of an hour with an excess of carbonate of soda. The precipitate which ensued was washed, dried and heated to ignition in a platina crucible for twenty minutes, after which its weight was 5.5 grs. Its color was pure white, and upon the addition of dilute sulphuric acid it was wholly taken up, with the exception of a few flocculi of silex, whose weight it was not attempted to ascertain. The solution was partially reduced by evaporation, and set aside to crystallize. In two days, it shot into crystals of Epsom salt.

D. The insoluble oxide of iron and silex (B.) was heated to redness in a close platina crucible over an alcoholic lamp,

after which they weighed 11.62 grs. The mixture was now digested with muriatic acid until the oxide of iron was wholly dissolved; the silica remained behind in white flocks, and was separated by the double filter, washed, dried and ignited. Its weight was 7.53 grs. This amount, deducted from 11.62 grs. gives 4.09 grs. per oxide of iron, which, reduced by calculation to the protoxide, the condition in which it probably exists in the mineral, equals 3.68 grs.

The constituents of this mineral therefore appeared to be, in this instance,

Silex, . . . . .	7.53.
Magnesia, . . . . .	5.50.
Protoxide of iron, . . . . .	3.68.
Soda, . . . . .	} . . . . . 1.09.
Oxide of chrome, . . . . .	
Sulphur and loss, . . . . .	
	17.80.

Or per hundred,

Silex,	42.30. containing oxigen,	21.27.
Magnesia,	31.46. . . . .	12.17.
Protoxide of iron,	20.67. . . . .	4.59.
Soda,	} 5.57.	
Oxide of chrome,		
Sulphur and loss, . . . . .		
	100.00.	

Considering the soda and oxide of chrome as accidental, the preceding analysis, it will be observed, agrees very well with the supposition that the present variety of chrysolite is a compound of one atom bisilicate of iron, with three atoms silicate of magnesia; and its coincidence with the mineralogical formula  $fS^2 + 3MS$  will be still more striking, if we suppose the oxigen of the iron is estimated a little too high, in consequence of the probable union of a small portion of that metal with sulphur, to form the proto-sulphuret of iron,—a substance whose mechanical admixture, in a slight degree, with this mineral was sufficiently evinced by our first experiments.

I am aware that the difference in composition between the specimens just examined, and those of the chrysolite analyzed by Klaproth and Stromeyer\* may seem opposed to

---

\* The specimens examined by Klaproth came from the Levant; the formula of whose composition is  $fS + 4MS$ . For Stromeyer's analysis of meteoric chrysolite, see Vol. 13, p. 184, this Journal.

the idea of their specific identity: perhaps it might really be so in a *chemical* system; but their strong affinity in natural properties, certainly proves them to belong to the same *mineralogical* species,—the only difference between the common chrysolite and the present substance being, that the former possesses a livelier color, a higher lustre, and in general, a more perfectly conchoidal fracture; though even this disagreement is not always observable, for fragments are occasionally met with, in the Virginia aerolite, which it would be impossible to distinguish from the most strongly marked specimens of chrysolite.

The proportion formed by this mineral, in the Virginia stone, does not fall short of two thirds of its entire bulk. I find it also constitutes the principal ingredient in the Weston meteorites, and is occasionally seen in those from Maryland. In endeavoring to ascertain if the small black grains disseminated through the Stannern meteoric stones might not be this substance, I was led to conjecture from their easy fusibility before the blowpipe, that they were pyroxene; a mineral, from the researches of G. Rose, well ascertained to exist in aerolites.\*

## 2. *Feldspar.*

Under this name I allude to one of the most common ingredients of meteorites, although in the present specimen it forms somewhat less than one quarter of the mass. It is every where dispersed through the stone, filling up little interstices and investing the chrysolite in thin coatings.

### *Mineralogical description.*

External shape, exceedingly minute grains, possessed of feeble degrees of coherence and appearing like powder to the naked eye.

Structure lamellar, and visible only with a microscope.

Hardness such as not to allow of its impression with the point of a knife.

Lustre vitreous: color white, rarely with a faint tinge of green; translucent.

### *Chemical characters.*

It was with some difficulty that pure pieces of sufficient size could be obtained for blowpipe trials. A thin scale in

---

\* Ann. de Chimie et de Physique t. xxxi. p. 81.



the most powerful heat of this instrument, melted down into a pearly white translucent glass, or enamel. With microcosmic salt it appeared to dissolve, with the greatest reluctance, into a transparent colorless glass, leaving behind small skeleton-like masses of silex. With borax, it dissolved with difficulty and without effervescence, into a transparent, and colorless glass.

The present mineral appears to correspond with that alluded to by Rose in the memoir before mentioned, and which he found to compose nearly half of the Juvéнас meteorite. He ascertained that it contained 0.60. p. c. of soda: a quantity so small, that he suggests unless it be a new mineral, it belongs to his species, labradorite,—a substance better known generally under the name of labrador feldspar. Its general aspect, however, as it appears in the Virginia stone, would render it more probable that it belonged to the variety albite, than to the labradorite.

It also forms a large proportion in the Maryland and Stan-  
tern aerolite, and exists in the stones of l'Aigle and Weston, though in the last, in but very small proportion.

### 3. *Phosphate of Lime.*

The only remaining earthy mineral distinguishable in the Virginia stone, I take to be the above mentioned substance. Its proportion in the mass is so trifling that it is scarcely perceptible without the aid of a microscope, and even then, only in a few points. When a fragment of the stone is broken down, however, we rarely fail to distinguish a few grains which are at once recognized by their color.

#### *Mineralogical description.*

External shape, globular and reniform. Structure lamellar. Brittle: fracture conchoidal.

Lustre vitreous. Color honey yellow: transparent. Hardness such as to scratch crystalized arragonite from Bilin, but not asparagus stone: is scratched itself by the knife.

#### *Chemical characters.*

Before the blowpipe upon charcoal it phosphoresces with great distinctness, and becomes rounded on the edges without undergoing any perceptible ebullition, and without loss of transparency. With microcosmic salt, it forms a transparent glass, at first with a tinge of yellow, but becoming

colorless when cold. Comparative experiments were made with the asparagus stone attended by similar results.

Several small angular fragments were put into a flask, to which colorless nitric acid was added; and a slight heat applied for nearly an hour, when their complete solution was effected.

I was the more particular in my examination of this substance, not being aware that phosphate of lime had ever before been detected in these stones; and I regret that the smallness of the quantity prevented me from making still farther experiments, by means of which, my conclusion concerning its nature might have been rendered quite certain.

#### 4. *Meteoric Iron.*

This hitherto nearly invariable ingredient of meteoric stones is not wanting in the present instance. Its proportion however is very small, as may be judged of from the fact, that I did not find above eight grains in breaking down nearly half a pound of the stone.

Its form was for the most part that of rounded grains slightly flattened, the largest of which did not exceed a mustard seed in size. It also existed in little hook-shaped masses, as well as in the most delicate filaments, resembling the finest wire, and capable of being straightened out in single pieces, to a length exceeding half an inch. Its color was of a silvery whiteness, except in those instances where the fragment was situated in a large cavity, when it was partially invested by rust, and in some cases by a thin coating of the proto-sulphuret of iron.

#### *Chemical Examination.*

1. Upon a portion of the meteoric iron, rendered as free as possible from foreign matter, was poured nitro-muriatic acid. A brisk action ensued, and every thing was taken up except a few grains of earthy matter.

2. To the solution was added ammonia in excess; and after a few moments' simmering, to effect the complete decomposition of the muriate of iron, the precipitate was allowed to subside. The supernatant liquid was withdrawn by the dropping tube. It exhibited a very distinct blue color, indicative of the presence of nickel.

3. The ammoniacal solution (2.) was evaporated to dryness in a platina capsule. The residue presented an apple-

green color, and after the volatilization of the muriate of ammonia by ignition, a brown powder remained, which, with borax, before the blowpipe, gave an orange red color, but on cooling, became almost colorless. The heat was urged for some time without inducing any tinge of blue. This residue therefore, consisted of the oxide of nickel, without containing any trace of cobalt.

4. A portion of the precipitate by ammonia (2.) was mingled with nitrate of potash and ignited. To a watery solution of the mass was added proto nitrate of mercury, without occasioning any precipitate, from which the absence of chrome was inferred.

5. Another portion of the precipitate by ammonia (2.) was dissolved in muriatic acid, and rendered neutral by evaporation. The addition of chloride of lime produced no red flocks indicative of the presence of manganese.

## ANALYSIS.

From the foregoing trials I inferred that the meteoric iron was alloyed with nickel only, and accordingly I endeavored to form an estimate of the relative proportions of these metals by determining the weight of per oxide of iron, afforded by a certain quantity of the compound. For this purpose 3 grs. of the mineral were dissolved as usual in nitro-muriatic acid. The solution was perfect, with the exception of 0.05 gr. earthy matter, which remained undissolved. Ammonia was added, and the liquid heated for a few moments. The precipitate, separated, washed, dried and ignited, amounted to 3.96 grs. equal to 2.77 metallic iron; thus, leaving by deduction, 0.18 gr. nickel, in 2.95 grs. of the alloy, or per hundred,

Iron,	-	-	-	93.90
Nickel,	-	-	-	6.10
			—	100.00

5. *Proto-sulphuret of Iron.*

This is the only remaining constituent of the Virginia aeorolite, I have to describe.\* Although every where dissemi-

---

\*I must not however, omit to mention a green capillary fibre, which I noticed occupying a cavity, and two other specks of the same substance, engaged in the stone, all of which I had the misfortune to loose, in separating them

nated through the stone, and almost completely lining its cavities in little grains and semifused crystals, yet such is their minuteness, that it scarcely forms a more considerable ingredient than the meteoric iron.

*Mineralogical description.*

Form : distinct crystals, of which I obtained three, of sufficient dimensions to enable me, with the aid of a magnifier, to ascertain their shape, and to determine the value of their principal angles by the reflective goniometer. The most perfect of the three, offered only the sides  $M$ ,  $M'$ , and their four adjoining pyramidal planes  $c$ ,  $c'$ , and  $c'$ , with the truncature  $a$ , as seen in the annexed diagram :—the other planes of the figure were inferred from the relations of these, the regular six-sided prism being known to be the fundamental form of the species.

$M$ , on $M'$ , - - - - -	$120^{\circ}$
— on $c$ , - - - - -	$153.30'$
$c$ , on $a$ , - - - - -	$117.30'$

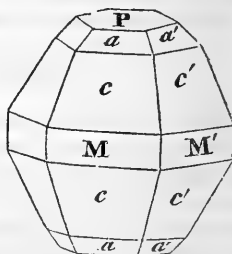

Structure : cleavage imperfect. Brittle. Lustre steel like and splendent. Color steel grey upon the crystalline faces ; copper yellow on fractured surfaces. Extremely subject to tarnish, of which the steel blue and red form the most frequent colors.

Hardness : not impressible by steel.

*Chemical characters.*

Before the blowpipe, on charcoal, it enters into immediate fusion, emitting at the same time sulphureous fumes : the globule formed assumes a deep red color while hot, but turns to a dull black, and becomes strongly magnetic on cooling.

To 0.4 grs. in powder was added muriatic acid. The flask was fitted with a tube dipping into a solution of acc-

from their gangue, for the purpose of submitting them to trial before the blowpipe. Their intense green color reminded me of *malachite*.

tate of lead. An action immediately commenced, on slightly warming the fluid, and a copious precipitate of sulphuret of lead ensued.

The difference in magnetic properties between the meteoric proto-sulphuret of iron and the same mineral belonging to our globe, led M. Rose to examine the former for nickel; conceiving that as the sulphuret of nickel of Johann Georgenstadt is not magnetic, a portion of this metal combined with our mineral, might perhaps be the cause of its not affecting the needle. He was unable, however, to detect the smallest trace of nickel in the pyrites of the Stannern stone. Nevertheless, as the common magnetic pyrites possesses but feeble and very variable degrees of magnetism, the slight discrepancy here observed between the two substances in question, does not interfere in any force with the idea of their specific agreement.

Yale College, March 20, 1829.

### 19. *Native Soda Alum, in Milo.*

Mr. George Jones, at present, a tutor in Yale College, and recently returned from the Mediterranean, brought with him among many other valuable minerals, a rich case of alum specimens from the ancient locality of Milo; and which he has had the kindness to present to the cabinet of this institution. The following is a memorandum of the circumstances under which it occurs as observed by himself, and with which he has favored me to be inserted in this place, in connexion with the remarks I have to offer concerning its nature.

“The alum comes from two places in the island of Milo. One of these is upon the south west side of the island, called by the natives *Calamo*, where it occurs near to the shore in a cave, above which rises a steep hill consisting of a decomposing lava of various colors, and strongly impregnated with sulphur. The cave is about twelve feet deep and five feet high, and is completely lined upon its roof with alum. The bottom of the cave is composed of a loose earth through which is constantly rising heated sulphureous air, which during its passage through the crevices precipitates the most brilliant crystals of sulphur. In front of the cave is a hot spring, and near by, are other caves, in none of which, however, the formation of alum is at present taking place.

“The other spot alluded to, is called Stipsy by the inhabitants. It is near the centre of the island, and was well known to the ancients, being spoken of by Pliny, as affording an alum, held next in estimation to that procured from Egypt. This is a cave also, and at the bottom of a hill. Its entrance is low and narrow, but it forms a chamber one hundred and twenty feet in length. Its atmosphere preserves a heat of 90°, and in some places of 100° Fah. The rock forming the roof and sides is of a pasty consistence, and every where inflated into oval cells often a foot in length. It is in these cells that we find the alum, which lines them all around with the most delicate incrustations or frost work. Towards the entrance of the cave occur masses of branchy gypsum, and within delicate acicular crystals of the same substance.”

As soon as I saw the Milo alum, I was struck with its want of similarity in appearance to the specimens of English and Scotch alum which I had seen in cabinets, and I was immediately led to think of the native soda alum of South America, recently analyzed and made known by Dr. Thomson.\* I accordingly made use of the following process, to render my conjecture concerning its nature, certain.

A portion of it was dissolved in water, to which was added in excess, carbonate of ammonia, to precipitate the alumine and other earths, as well as any metallic oxides which might be present. The residual liquid was evaporated to dryness and heated to redness in a platina crucible to dissipate the ammoniacal salts. The residue was dissolved in water, in which it proved highly soluble. By its taste it was recognized to be sulphate of soda. The solution was set aside for spontaneous evaporation. It shot into short prismatic crystals, which on being slightly heated underwent the watery fusion. In the course of a few days, the entire mass became covered with a white efflorescence. Therefore, there can remain no reasonable doubt concerning the nature of the substance in question.

The specimen examined was from the cave first mentioned, between which and the specimens from the other, there is a slight difference in appearance; they are both however the same in all important respects. The former consists of parallel straight fibres not very closely aggregated, from one

---

\* Annals of the Lyceum of Natural History of New York, Vol. III, p. 19.

to two inches in length, none of which are composed of continuous masses, but are often interrupted by fissures and occasionally corroded or broken off. They are white of a vitreous lustre and transparent except at their termination upon the surface, where they are opaque from the loss of water of crystallization. The specimens from the latter spot, on the other hand, present a botryoidal surface like prehnite, from which radiate perpendicularly, perfectly straight and almost inconceivable minute crystals, much resembling, except that the fibres are shorter, some of the most delicate Zeolites from the Giant's Causeway. The fineness of the fibres which form these tufts communicates to them a degree of silkiness like the native alum of Hurlet, near Paisley, in Scotland, but they differ strikingly from this last in never being curved, and in rarely being closely aggregated.

Dr. Thomson finds the composition of the native soda alum to be,

3 atoms sulphate of alumine,	-	-	21.75.
1 atom sulphate of soda,	-	-	9.00.
20 atoms water,	-	-	22.50.
			53.25.

and the only difference between it and the artificial soda alum is, that the former contains 20 atoms of water, while the latter contains 25 atoms. To this circumstance he attributes their difference in crystallization,—the artificial soda alum assuming the octohedron, whereas the native affects, apparently, a quadrangular prism.

CHARLES UPHAM SHEPARD.

Y. C. March 22d.

20. *Proceedings of the Lyceum of Natural History of New York.*

(Continued from Vol. XV. page 360.)

JULY, 1828.—*Mr. Barnes* made a report on the Helices from the West Indies presented at a former meeting. He stated that great difficulties existed in determining the American species, and that he had received many from the Caribbean seas of which he could find no descriptions in the systems.—*Dr. Mitchill* submitted specimens of plants occasionally sold in the shops for *Digitalis*. *Mr. Halsey*, to whom it was referred for examination, reported it to be the

*Stachys germanica*.—*Dr. Dekay*, read a paper on two fossil Ammonites from the Red river and Cahawba, (Alabama.)—*Prof. Buckland* of Oxford, in the place of Dewit Clinton deceased, and *Prof. Thomson* of Glasgow, in the place of Sir James Edward Smith, deceased, were elected honorary members. H. Brevoort and Rev. T. C. Levins, were elected resident members.

AUGUST.—*Mr. Featherstonhaugh* presented a specimen of transition limestone charged with organic remains, occurring in thin layers in greywacke at Duaneburgh, (N. Y.) perfectly identical in arrangement, composition and fossil contents with the Dudley limestone of England.—*Dr. Dekay* read an amended description of the *Amia calva* of Linneus, from a specimen sent by *H. R. Schoolcraft, Esq.* from the Sault de Ste Marie, (Michigan.) The specimen was nearly two and a half feet in length, mottled, highly prized as an article of food, and is the first known example of this species inhabiting the western waters.—*Mr. Featherstonhaugh* presented specimens of a root highly prized by the Indians as an article of food. It is the earliest food used by them in the spring of the year, and is called Itapineeg by the Chipeways. It is the *Dentaria diphylla*.—At the request of the secretary of the navy, instructions were ordered to be drawn up for the use of the naturalists, to be attached to the contemplated voyage of discovery in the South Seas, and committees were appointed for that purpose. Joseph C. Hart elected a resident member.

SEPTEMBER.—*Mr. Featherstonhaugh* reported upon the specimens presented at a former meeting by *Dr. Swift*, of the U. S. navy. They consisted of well defined oolite, fragments of echini, flint, white chert, &c. &c. from Florida and Cuba. Of these it was remarked, that the white chert is said by Williams, (View of Florida,) to abound in the chalky rock (oolite) at Tampa, but of this chalky rock we have no specimens. But as we have well defined specimens of the Key West oolite with the cherty matter; it is a proper deduction that the same oolitic formation underlies all that region comprehending the south and west coasts of Florida, as well as the island of Cuba.—A valuable collection of animals was received from corresponding members, *Drs. James and Pitcher*, of the U. S. army, collected by them on the north western frontier.—The president deposited in the cabinet of



the Lyceum, a mass of pure native copper, the property of H. R. Schoolcraft, Esq. This mass weighs 47 lbs. and was obtained at the mouth of the Ontonagon river. It is not to be confounded with the larger mass lying higher up the river, and which is composed in part of serpentine disseminated through it in veins.—*Dr. Dekay* read a description of a new species of reptile from Paza, belonging to the genus *Leposternon* of Spix. It was thus characterized. *L. oxyrhinchus*. *L. flavido-albidum*; sulcis tribus longitudinalibus dorso lateribusque. Rostro acuminato non mucronato.—*Dr. Torrey* read an extract of a letter from *Prof. Thomson* of Glasgow, containing analyses of several American minerals. That of Sillimanite corresponds in the main with that of Mr. Bowen, but contains 18 pr. ct. of zircon. Cumingtonite is undoubtedly a new mineral species allied to Kapholite. *Prof. T.* has also made a partial analysis of Dislute. It is not an aluminous mineral, but a new species allied to spinelle.—*Dr. Torrey* announced that he had received from *Mr. Nuttall*, a mineral from Nova Scotia, which he is inclined to believe will prove to be Nepheline, a new mineral species for this country. It is the same mineral which has been considered as a new species and termed *Lederite*.—*Dr. Hosack* presented the hydrophytologia of Lyngbye with other valuable works; also a rich collection of marine plants from the coast of Sweden, illustrating the work of Lyngbye.—*Dr. Mitchill* read a portion of a paper entitled “a notice of occurrences in natural history and the sciences connected with it, for the last few years in the U. S.—*Mr. Henry Carey* was elected a resident member.

OCTOBER.—*Mr. Reynolds* read a communication containing the result of his enquiries among the whalers and sealers, and the observations and discoveries made by this class of citizens in the Southern Seas. About 10,000 whales are supposed to be annually destroyed. *Mr. R.* has collected and embodied a mass of evidence sufficient to show the probable existence of nearly two hundred islands, rocks and reefs not laid down in any chart.—Specimens of phyllite from Lancaster, (Mass.) described in vol. 3d, of the annals, and crystals detached and mounted, of the American topaz from Monroe, (Con.) were presented by *Dr. Torrey*.—*Dr. Dekay* read a paper entitled, “description of a fresh water fish of the Linnean genus *Gadus*, from Lake Superior.”—*Mr.*

*C. T. Jackson* of Boston, presented a box of minerals collected by himself, illustrating the geology and mineralogy of Nova Scotia, and a part of Massachusetts. The collection consisted of upwards of seventy choice and well selected specimens, among which the following were more particularly noticed. Laumonite, Thomsonite, and radiated Mesotype; purple Scapolite, white Heulandite, yellow Chabasie, Petalite, (pink variety,) with crystals of ferruginous oxide of cerium, &c. &c.

NOVEMBER.—*Messrs. Cooper and Cozzens*, who have recently returned from an extensive tour through the western states, presented a mass of tertiary rock from the shore of the Potomac, sixty miles below Washington. It contained casts of *Turitella*, *Arca*, *Calyptra*, *Pectunculus*, *Ampullaria*, &c. and was considered as precisely similar in fossil contents with the clay of the London basin.—A letter was received from the secretary of the navy, returning thanks to the Lyceum for the interest they had taken in the proposed voyage of discovery, and for the ample instructions with which he had been furnished by the Lyceum.—*Dr. Mitchill* read a continuation of his paper on the progress of the natural sciences in the United States.—*Dr. Torrey* presented specimens of the rare mineral Glaukolite, from the vicinity of Lake Baikal.—The same gentleman announced the discovery of Cadmium among the zinc ores of New Jersey.—*Prof. Buckland*, of the university of Oxford, presented a series of excellent casts of the *Mastodon latidens* and elephantoides recently discovered in the kingdom of Ava.—The president delivered a discourse founded upon the recent decease of a member, Mr. D. H. Barnes.—*Messrs. Cooper and Cozzens* presented specimens of the rock formations in the neighborhood of Bigbone Lick, (Kentucky,) with two maps illustrating the geology of that place. They also exhibited an extensive series of specimens of the teeth and bones of the mastodon of various ages, and the elephant.—They propose to give a detailed description of these specimens at some future meeting.—*Mr. Louis Janin* of Paris, was elected a corresponding, and *Dr. I. Brinkerhoff*, and *Mr. Isaac S. Hone*, resident members.

DECEMBER.—*Dr. Torrey* stated that having treated a portion of a fossil tusk from Kentucky, (probably that of a mastodon,) with dilute muriatic acid, the animal matter still re-

mained, though somewhat modified.—*Mr. I. L. Williams* of Florida, a corresponding member, presented a box of specimens illustrative of the geology of that region.—*Col. Totten*, of the U. S. engineers, a corresponding member, presented a large collection of fossil plants from the slate formation of Rhode Island, among them were casts of doubtful fossils which were referred for examination and report.—Messrs. T. G. Cary and G. C. Peterson, were admitted resident members.

21. *Baron de Zach—Liberty of opinion and of the press—Education—General views of Europe, &c.*

Extract of a letter from an American gentleman, to the Editor, dated,

“HOFWYL, Switzerland, Dec. 22, 1828.

“Baron de Zach, as you have probably heard, underwent a very dangerous operation in Paris, but seems now restored. He passed the summer in Switzerland, but I was unable to discover his residence in time to visit him. One of his friends who received the account from himself, told me that the reason assigned, on the demand of the Prussian ambassador for his banishment, by the Sardinian government, was that he had maintained in his astronomical journal the revolution of the earth around the sun, which was in direct contradiction with the decrees of the church! It is almost incredible that such darkness should prevail in the midst of light, as one finds in Italy, and even in some parts of Switzerland. It is painful to an American to find even on political subjects so much of the illiberal spirit of past ages, in this land, which boasts so much of its freedom. The press is in many cantons under severe restrictions. Exterior and formal instruction is indeed encouraged; but efforts to produce real illumination among the people are often frowned upon or censured, or even persecuted by the still powerful aristocracy. The Jesuits, driven out of France, have taken post in Switzerland, and promise to involve its catholic cantons in grosser darkness than ever. Indeed the promises and institutions to which the princes of Europe have been driven by the force of public opinion, are but a cloak under which, in *most states*, views as tyrannical, and measures as illiberal, as ever are concealed.

“Still the efforts of individuals, and of individual states in Europe, are doing immense service to the cause of education

in general, and providing materials which will produce great effect, when they are allowed to operate freely on the mass of the people. I have but just begun to examine this subject, and so important and extensive do I find it, that if Providence permit, I shall return to complete observations and inquiries which my state of health has scarcely allowed me to commence until the present summer. I shall deem myself happy if I can, in this way, become a humble instrument of promoting that moral elevation of character, that intellectual light among the mass of the people, so necessary for the security of institutions like ours, so little thought of as a part of the business of education, and so little valued in comparison with those mechanical acquisitions made in our schools, which for want of proper direction are often only the instruments of evil. I have come hither to pass the winter in the examination of an institution, which for the extent and rationality of its means of education, is among the first in Europe.

The season is thus far very mild, and it is singular that at the height of one thousand seven hundred feet above the level of the sea, we have had scarcely any severe cold, while in most of the adjacent countries the winter is long since set in, and even in Turkey, the Russians have almost realized the sufferings of the French at Moscow. I find that the most liberal men here rather rejoice that the proud steps of the northern colossus are somewhat arrested, and that Russian despotism is kept at bay by the Mahomedan, to the greater security of the rest of the world. The great objects which humanity had to desire, the independence of Greece, and the repose necessary to build up its ruins, and the better protection of Wallachia and Moldavia seem to be secured; and if the success of the Russians had been complete, who can answer for the ambition of Nicolas, or the passions of his semi-barbarous subjects? You will probably have heard that the ambassadors of the allied powers have been occupied with the President in preparing to fix the boundaries of Greece, which it can scarcely be hoped (if desired) will *at present* be extended beyond the Isthmus. It is a striking evidence of the deplorable state of this country, that at their meeting at Poros, the best houses which could be found for them, were destitute both of doors and windows. There is not enough wealth remaining to replant the desolated vineyards and olive yards. The price of two or three crops will purchase the land. Candia is at present the scene of the same

sanguinary contest which has desolated the Morea, but the ambassadors have interfered, with the hope of checking it.

I am surprised to find how much interest our presidential controversy excites in Europe; and to hear and see the names of Jackson and Adams in every language. God grant that the issue, whatever it be, may be overruled for good, and that the storm of evil passions it appears to have excited, may subside. This seems to me a more alarming circumstance than the character of any *individual* could be in reference to our prospects and institutions.

22. *Literary Notice*.—Mr. H. Howe, Bookseller, of this city, has just published in one octavo volume, a neat edition of "Bakewell's Introduction to Geology," the first American, from the third London edition, which came from the hands of the author the past year, entirely recomposed and greatly enlarged, and illustrated with new plates.

This is probably the most attractive and intelligible book on Geology in the English language.

To this edition is added "an Outline of the Course of Geological Lectures given in Yale College."

### 23. OBITUARY.

Died, on the 26th of January, in the 67th year of his age, NATHAN SMITH, M. D. Prof. of the Theory and Practice of Physic and Surgery, in the Medical Institution of Yale College.

An interesting eulogium, pronounced by Professor Knight, one of the colleagues of the deceased, exhibits a very just delineation of his character. Dr. Smith was born at Rehoboth, in Mass. Sept. 30, 1762: he was furnished in early life, with only the common elements of knowledge, usually taught in the New England schools. His father, having removed to Vermont, he was occupied exclusively in agricultural pursuits, although with occasional calls, during the war of the revolution, to perform arduous military duty, in repelling the incursions of the savages.

At the age of 24, he was accidentally present at a surgical operation, performed by Dr. Josiah Goodhue.\* This circumstance kindled in his mind an ardent desire to know

---

\* This venerable man has survived his early and favorite pupil, and now, in honorable old age, lives at Hadley, Mass.

something more of the structure of the human frame. By the recommendation of Dr. Goodhue, Mr. Smith went through such a course of preparatory study, as would have qualified him to enter the freshman class in Harvard college, and was then received as a private pupil by Dr. G. After studying medicine and surgery for three years, and practising in his profession two or three more, at Cornish in New Hampshire, he resorted again to Harvard, to attend the courses of Medical and Philosophical lectures, under the eminent professors, who adorned that institution, among whom was the elder Dr. Warren. Dr. Smith received a medical diploma at Harvard, and gained much credit by his inaugural dissertation *on the circulation of the blood*. He now returned to his practice with increased advantage, and prosecuted it with so much vigor and success, that he was, in the course of a few years, able to compass a very favorite object—the establishment of a medical school in connexion with Dartmouth college, at Hanover, N. H. This light was raised in a region, where the darkness was before palpable, and its rays shone with such lustre as to attract the eyes of multitudes even at a distance. Professor Smith's school soon became eminent, and it was esteemed both an honor and an advantage to have been his pupil. In the earlier years of this institution, Dr. Smith discharged the duties of all the departments, and at the same time attended to an extensive medical and surgical practice, which led him, often by night, almost always on horseback, and in every vicissitude of the seasons and weather, over the rugged mountains of that region, then comparatively wild, and furnished with few good roads.

Although engaged in an honorable and lucrative course of professional duty—impelled by an ardent desire to perfect his knowledge, Dr. Smith left his practice and his school, and resorted to Edinburgh, where and in London he passed a year, under illustrious masters, among whom were Doctors Black and Monro, and returned to his own station with powers of usefulness greatly augmented. His career was alike useful to others and honorable to himself; his practice was greatly extended; his school was augmented to the number of sixty pupils or more; and having trained those who could in some good degree supply his place, he accepted, in 1813, an invitation to a professorship in the newly instituted medical department of Yale College,

which station he occupied, with the most distinguished honor and usefulness, till his death.

Dr. Smith possessed a powerful and active intellect. He loved knowledge in every form, and gave the whole of his influence to promote its progress. His industry was unwearied, and his mind was always employed, even when he was engaged in his active duties.

As a practical surgeon he had few equals, and his operations—numerous, various, and often dangerous—were remarkably successful.

As a practitioner of medicine, he was devoted; full of resource, and so absorbed in the case before him that he rarely despaired while life continued.

Although not indifferent to the rewards of his profession, they seem never to have been his primary object.

The writer of this brief notice speaks from personal knowledge, when he states, that Dr. Smith was equally prompt to leave his repose at midnight in a winter's tempest, to resort to the bed side of a suffering African, who could give him no reward, as to that of the most wealthy and munificent patient.

With him, duty was discharged as much from impulse as from principle; and both conspired to produce prompt, vigorous and unremitting effort. The kindness of his temper was inexhaustible; the suffering infant was watched with as much assiduity as the most valued adult; and in anxious hours, when hope and fear were conflicting in filial or parental bosoms—multitudes can testify, that this devoted man often spent the night by the sick bed, or, without leaving his post, caught only a transient and often interrupted repose.

Not only beloved and revered in his own family, in training whom he was very successful in the formation of intelligent and virtuous character—he was *every where at home*, for he was every where welcome. Great in his profession—rich in his stores of general knowledge—delighting in conversation—holding the female character in high estimation, and uniting assiduity with purity—he was the favorite of a wider circle of personal acquaintances and friends, than (as his respected eulogist observes) any other man probably ever enjoyed in New England.

He did more than any other man ever did to extend medical and surgical knowledge in the northern states; and the

beneficial effect of his exertions and example will remain to distant generations.\*

*Foreign extracts, by Prof. J. GRISCOM.*

24. *Carbonic Acid of the Atmosphere.*—A memoir on this subject, by Theodore De Saussure, read before the Helvetic society, in June, 1828, contains some interesting facts. The author determined the amount of carbonic acid in a given portion of air at any one time, by enclosing barytic water in a large glass balloon, full of the air to be examined, and ascertaining the weight of the carbonate formed. The portion of carbonic acid, he observes, is undergoing almost continual changes. The mean quantity as determined by experiments commenced in June, 1816, and continued to 1828, in a meadow at Chambeisy, near Geneva, is, at mid-day 4.9 parts in 10,000 of air. The maximum was 6.2; the minimum 3.7.

The mean quantity of carbonic acid in the atmosphere is greater in summer than in winter. The author finds that the relative proportions are as 100 to 77.

There are occasional exceptions to this difference. In the month of January, 1828, which was extraordinary for the mildness of its temperature, the quantity of carbonic acid rose to 5.1. In the month of August following,† remarkable for its being singularly cold and rainy, the quantity at mid-day, the mean of four observations, was only 4.45.

The author finds that there is an increase of carbonic acid during the night. The mean of 9 results, obtained at mid-day, is 5.04, and of corresponding observations at 11 in the evening, 5.76.

A comparison of the air over the middle of Lake Lemman, with that at 200 yards from the shore, showed a slight difference. The quantity over the land being to that over the water, as 100 to 98.5. The air of Geneva was found to contain more than that of the country, in proportion of 100 to 92, by simultaneous observations in the two places.

\* For a just and affectionate notice of Dr. Smith's character, see the *Christian Spectator* for March, 1829; some traits of character not peculiarly appropriate to this Journal, are there noticed.

† These experiments were made after the reading of the memoir before the Helvetic society.



The author designs to publish a more circumstantial account of his observations.—*Annales de Chimie et de Physique*, Aout, 1823.

25. *Autumnal coloration of Leaves*.—A memoir on this subject, by M. Macaise-Princep, read before the Société de Physique et D'histoire naturelle de Geneve, concludes as follows:

1. All the colored parts of vegetables appear to contain a particular substance, (which the author, in conjunction with Prof. DeCandolle, agrees to call *Chromule*,) susceptible of a change of color by slight modifications.

2. It is to the fixation of oxygen, and to a sort of acidification of the chromule, that we are to ascribe the autumnal change in the color of leaves.—*Idem*.

26. *Singular Galvanic trough*.—M. Watkins, philosophical instrument maker of London, has constructed a Voltaic pile, with a single metal and without any liquid. It consists of from 60 to 80 plates of zinc, four inches square, fixed in a wooden trough at a short distance from each other, having only a thin plate of air between them. One side of each plate is smoothed and polished, the other left rough. The polished faces are all turned in one direction. If one extremity of the pile be made to communicate with the ground, and the other with an electroscope, the latter immediately indicates one or other of the two electricities, according to the pole with which it is in contact. The humidity of the air favors the action of the pile, which may be considered as a kind of dry pile in which air is substituted for paper, and the two surfaces of the zinc do the office of two heterogeneous metals. It appears to be owing to the stronger oxidation of the polished surface that we are to ascribe the development of electricity in each plate of the zinc; the intermediate strata of air, and perhaps the trough permitting this electricity to accumulate as in the ordinary pile.—*Idem*.

27. *On a method of measuring some varieties of Chemical action*, by M. Babinet.—In producing the disengagement of a gas in close vessels, the chemical action ceases when the gas acquires a sufficient elastic force; and this action is suspended until the compressed gas is liberated, the force of

which, by some means, forms an equilibrium to the chemical action which disengages it.

In producing gas in an apparatus similar to Papin's digester, surmounted by a little copper ball closed by a stop cock, the ball was unscrewed and opened under a graduated bell glass, in order to measure the volume of gas which it contained, when it was ascertained that hydrogen disengaged from water by zinc and sulphuric acid, possessed an elastic force of more than 33 atmospheres, at 25° c.—*Ferussac's Bulletin, Juin, 1828.*

28. *Sulphur.*—The manner in which this substance is affected by heat and by sudden cooling, has often claimed the attention of chemists. The following detail of some experiments on this subject, is given by J. Dumas.—*Annales de Chimie, Sep. 1827.*

<i>Temperature.</i>	<i>Sulphur.</i>	<i>Suddenly cooled by immersion in water.</i>
110° Cent.	very liquid, yellow.	very friable, common color.
140°	liquid, deep yellow.	very friable, common color.
170°	thick, orange yellow.	friable, common color.
190°	more thick, orange.	soft and transparent at first, but soon friable, common color.
220°	viscid, reddish.	soft and transparent, amber color.
230 to 260°	less viscid, reddish brown.	very soft, transparent, reddish brown.

30. *Dr. Wollaston.*—The death of this eminent philosopher is announced in the London Journals. We hope to insert a notice of him in the next number. He has had few equals, and has probably left no superior. His inventions and discoveries have been numerous, and every thing he did was finished. Of him it may be truly said, *nihil tetigit quod non ornavit.*

We regret that the pressure of domestic articles, although we have added a sheet, has obliged us to omit a copious collection of foreign intelligence, which shall appear in our next.

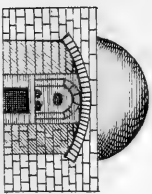

*End view of the furnace.*

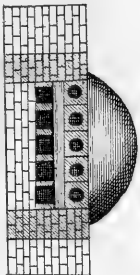

*Side view of the furnace.*

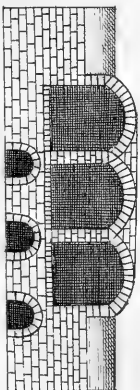

*Front view of the Wood Ovens.*

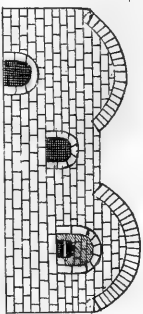

*End view of the Platting Ovens.*

Mixing Room

Store Room

Pot Room

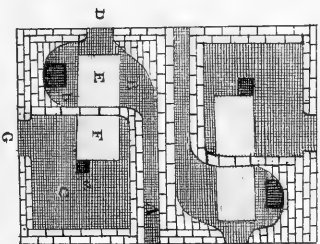
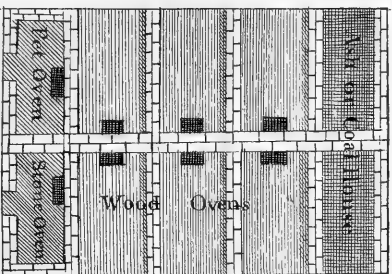
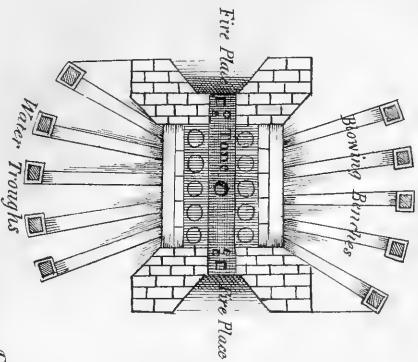

Box Shop

Packing Room

Cutting Room

**A CYLINDER GLASS HOUSE.**

GROUND PLAN OF



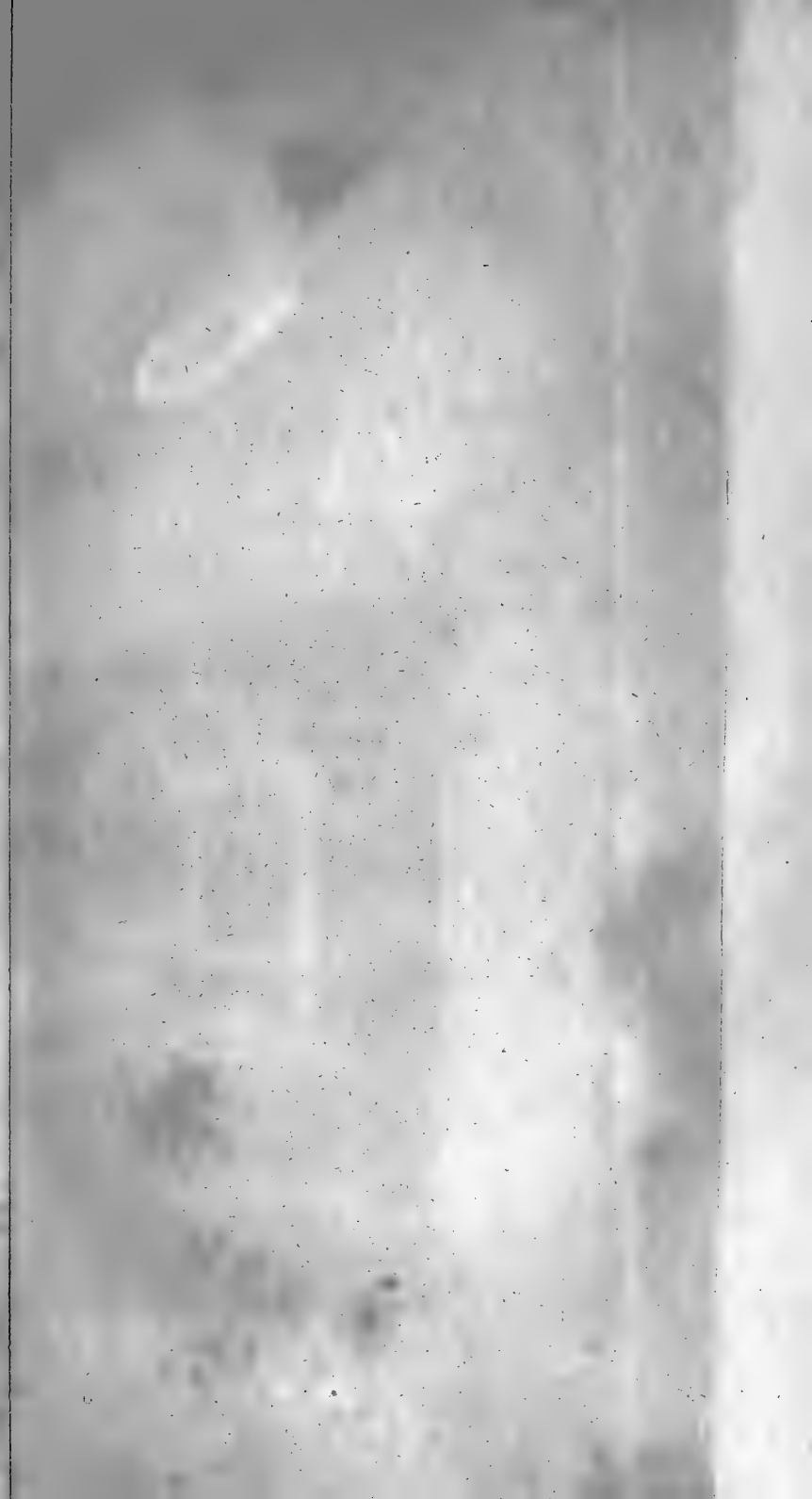

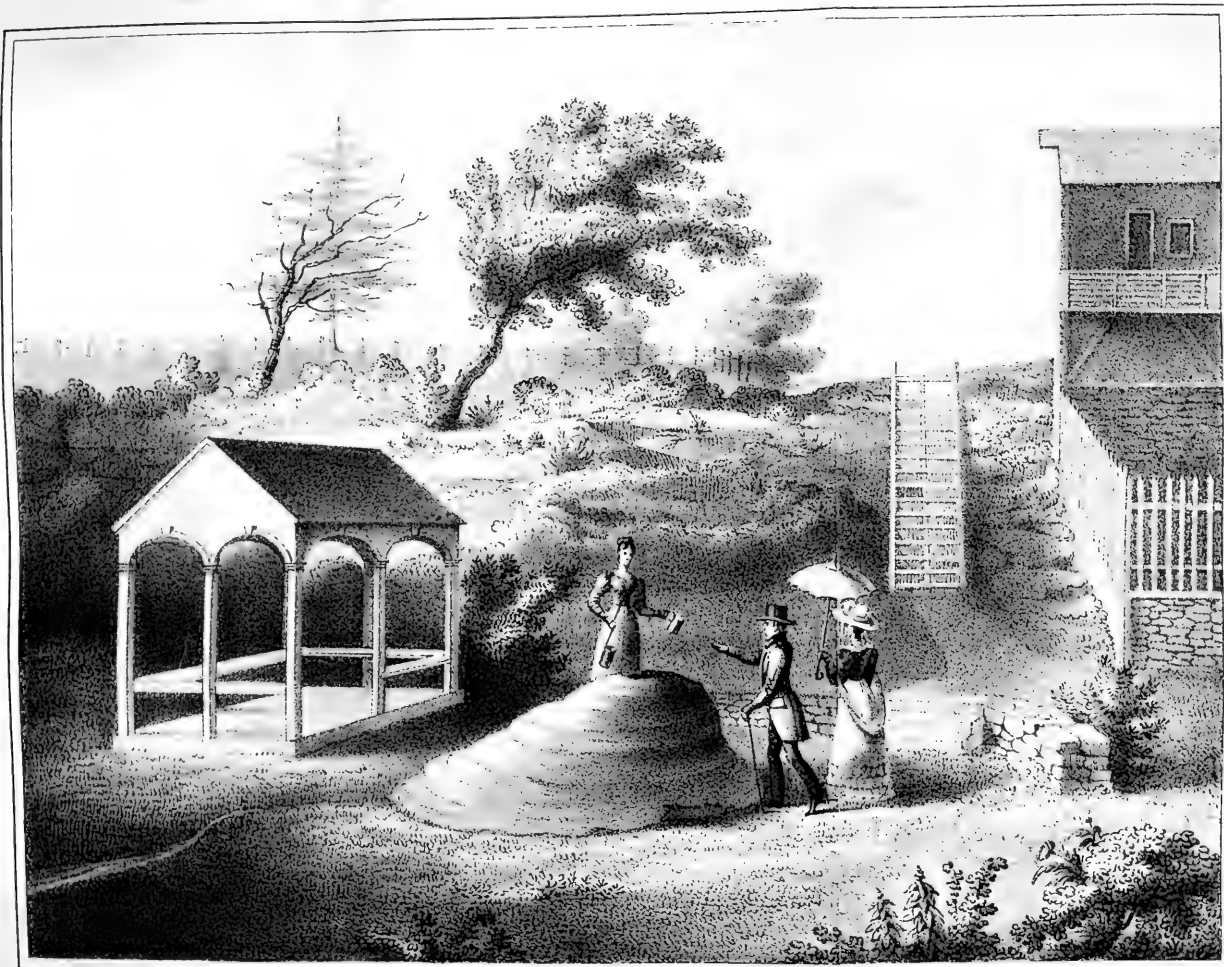

*H. Walton Pinet*

*Fendler's Lithography, Boston.*

*M. Swett del.*

VIEW OF THE CELEBRATED ROCK SPRING AT SARATOGA.

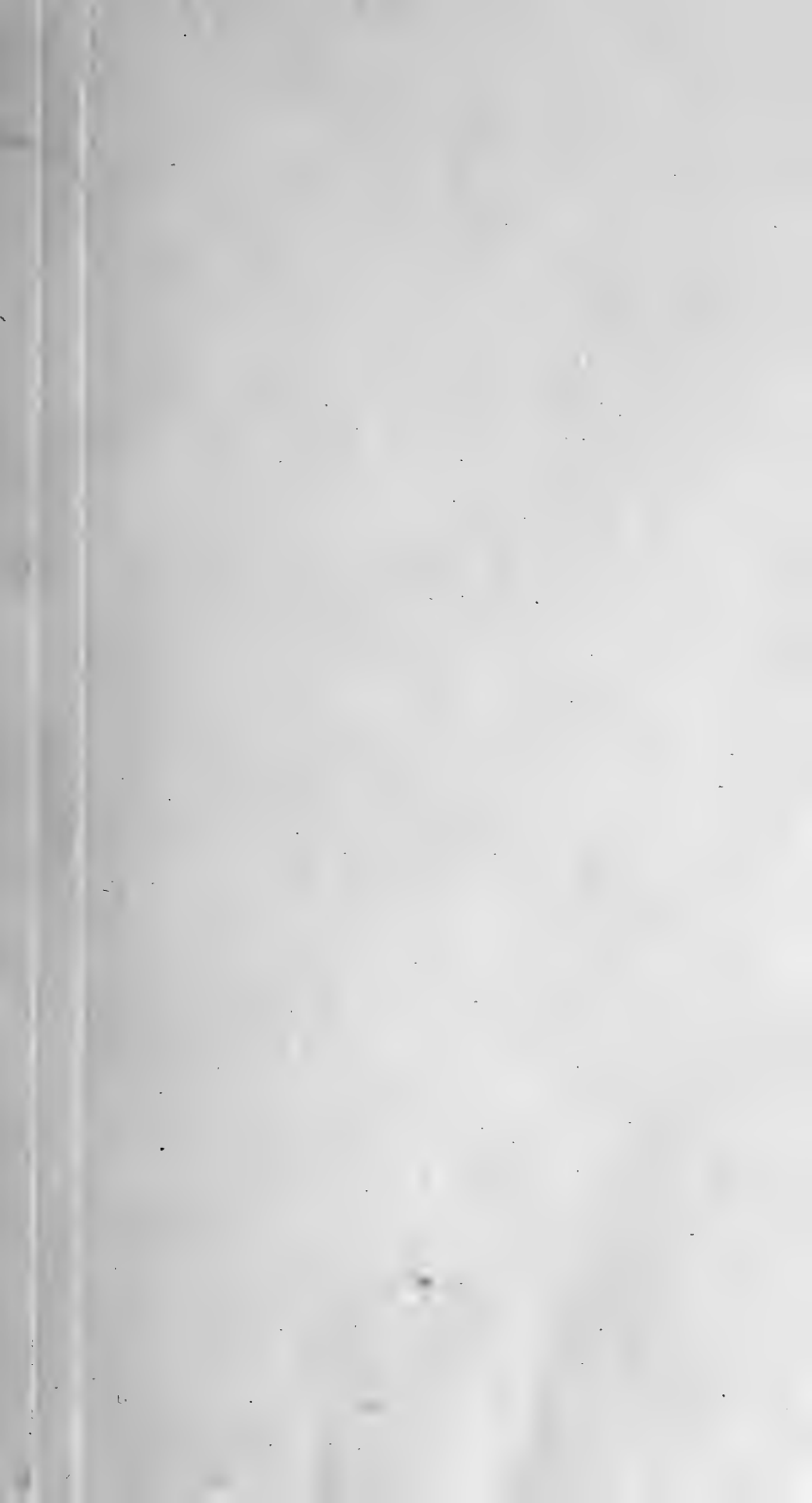





THE  
AMERICAN  
JOURNAL OF SCIENCE, &c.

---

ART. I.—*Analysis of the Meteoric Iron of Louisiana, and discovery of the Stanniferous Columbite in Massachusetts;* by CHARLES UPHAM SHEPARD, Assistant to the Professor of Chemistry, Mineralogy, &c. in Yale College.

THE circumstances relating to the occurrence and natural properties of the Louisiana iron, as well as the detection of nickel in its composition by Prof. Silliman, have, for several years, been before the public;\* but no extended examination with a view to determine the presence or absence of other metals, or to ascertain the relative proportions of the iron and nickel, so far as I am informed, has hitherto been attempted. Having been permitted to detach a few fragments from the fine specimen of this iron, belonging to the Cabinet of Yale College, I engaged in the following examination.†

1. Upon a fragment of the meteoric iron, was poured nitro-muriatic acid. Its entire solution was effected without the aid of heat, and the liquid assumed a reddish brown color.

2. To a part of the solution, was added muriate of barytes; no precipitate took place, from which the absence of sulphur was inferred.

3. The remainder of (1.) was decomposed by ammonia in excess; and the liquid after being warmed for a few moments

---

\* See Vol. VIII, p. 218 of this Journal.

† The mean specific gravity of three specimens, whose greatest difference was one tenth of a grain, was 7.543. This result differs slightly from that obtained by Dr. Bruce, who places it at 7.400. A want of perfect agreement in different trials may be expected, however, notwithstanding the homogeneity of the mass; since the fragments examined, will rarely possess the same density, owing to the different degrees of mechanical force applied, to effect their separation.

upon its precipitate, was separated by the filter. It presented very distinctly, a blue tinge; which on evaporation grew more intense, and passed to a shade of green.

4. The ammoniacal solution, (3.) was transferred to a platina capsule, in which it was evaporated to dryness, and heated to redness for the purpose of expelling the muriate of ammonia. A greenish gray powder incrustated the capsule after its ignition.

5. A portion of this residue, (4.) when treated with borax before the blowpipe, give no indication of cobalt; the remainder was dissolved in muriatic acid, and characters traced with its solution on paper, which failed to become visible, on being warmed. Cobalt was therefore inferred, not to exist in the iron under examination.

6. The muriatic solution, (5.) from its peculiar green color, and from its affording, with prussiate of potash, a greenish white precipitate, was recognized as containing nickel.

7. A part of the ferruginous precipitate, (3.) was heated in a platina crucible along with nitrate of potash; and to the residue, water was added, and the excess of potash neutralized by nitric acid. The colorless solution was not affected, either by the proto-nitrate of mercury, or by nitrate of silver. Accordingly the absence of chrome was inferred.

8. Another portion of the precipitate by ammonia, (3.) was dissolved in muriatic acid; and the solution, after being rendered neutral, was decomposed by the succinate of ammonia. The supernatant liquid, on being boiled with carbonate of soda, afforded no precipitate; by which, the absence of manganese was proved.

Satisfied by these preliminary experiments, that the Louisiana iron was alloyed only by nickel, I proceeded as follows, to ascertain the proportion in which it was present.

#### *Analysis.*

A. 50 grs. of the meteoric iron, were dissolved as usual and decomposed by ammonia in excess. After a slight simmering, the supernatant liquid was separated by means of the filter, and the ferruginous precipitate thoroughly washed. This fluid, whose bulk, from the washings of the oxide of iron, was very considerable, was reduced by evaporation to half a pint; and the double salts of nickel and ammonia it contained decomposed by potash. The evaporation was continued to dryness, in order to expel every portion of ammo-

nia. To the residue was added warm water, which dissolved the salts of potash, and left the oxide of nickel floating in the solution, in the form of a flocculent, apple green precipitate. Separated by the filter, dried, ignited and weighed, it amounted to 5·8 grs.; which being in the condition of the protoxide, equals 4·837 grs. of the metal.\*

B. To another portion of the meteoric iron, weighing 10 grs. nitro-muriatic acid was added, and the solution decomposed as before. The oxide of iron, after being thoroughly drenched with warm water, was dried and heated to redness in a close platina vessel, over an alcoholic lamp. It weighed 12·89 grs.: which in the metallic condition would be 9·002 grs.

We have, therefore, in the meteoric iron of Louisiana,

Iron, . . . . .	90·020.
Nickel, . . . . .	9·674.
	99·694.
Loss, . . . . .	.306.
	100·000.

The similarity which was before known to exist, between the meteoric iron of Louisiana and Santa Rosa, in South America, as regarded the circumstances of their situation and general properties, heightened as it now appears to be by their close agreement in composition,† seems almost to lead to the supposition, that they were derived from one and the same meteorite, which traversed the atmosphere of our planet in a direction, lengthwise of the American continent.

\* Since the method for separating the nickel here adopted had been objected to, on the ground, that a portion of the oxide of nickel remains behind along with the precipitated iron, I examined that precipitate by acetic acid, without obtaining any indication that such had been the fact in the present instance. And that this is not always the case, the experience of Dr. I. Nöggerath may be mentioned, who in his examination of the Bitburg meteoric iron, was, in like manner, unable to detect any remaining oxide of nickel in the precipitate by ammonia.—*Journal für Chemie und Physick.* B. XIII. S. 15.

† The meteoric iron of Santa Rosa, is composed of iron 91·41. and nickel 8·59.—*Ann. de Chimie et de Physique*, tom. xxv, p. 438.

COLUMBITE.

In May, 1828, while on a visit to the remarkable deposit of tourmalines in Chesterfield, Mass., my attention was called to a loose rock in the foundation of a stone fence, by the large and delicate folia of yellow mica it contained. The mass bore signs of having had fragments detached from it before; but the wall being now displaced for the purpose of affording a passage to cattle, I was enabled with the aid of a hammer, to reduce it completely to fragments. Towards its centre, I found imbedded, a number of black metallic crystals, whose form and weight led me at once to think of Columbite. They were situated within a few inches of each other; sometimes engaged in feldspar, at others in beryl, and occasionally, between the folia of the mica. They presented much diversity in their dimensions; the smallest of them not weighing above 15 grs., and the largest a little above 400 grs. The weight of all the crystals and fragments obtained, as near as I can estimate them at present, did not exceed 12 or 1400 grs. Not having until very lately, been able completely to verify my conjecture, concerning their nature, I have withheld until the present moment all notice of the locality; which I now take much pleasure in making public, together with a minute account of the steps followed in arriving at the conclusions here announced.

*Mineralogical Description.*

Form. Right rectangular prism: the height of which may be represented by 8, the length of the base by 6, and the breadth by 4. The annexed figure, presents the most frequent modification observed among these crystals. Their angles are determined, by the common goniometer.

P on M, or T. . . . .	90°,00
M on T. . . . .	90,00
T on $\alpha'$ . . . . .	133,00
M on $\alpha'$ . . . . .	116,00
T on $\alpha$ . . . . .	156,00

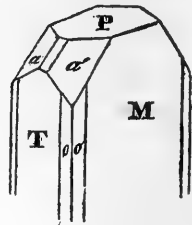

Cleavage, parallel with M, quite perfect; in other directions uneven. Lateral planes vertically streaked.

Lustre, shining, sub-metallic. Color, iron black. Tarnished upon the cleavage planes, mostly blue. Streak, brownish black: powder, chocolate brown: opaque.

Hardness. Scratches glass. Brittle.

Specific gravity, 6.00.

#### *Chemical Examination.*

Alone before the blowpipe, in very thin fragments, it becomes rounded upon the edges, and assumes a glossy black color; but is not taken up by the magnet, even when reduced to powder. When pulverized, it enters into fusion along with borax, to which it communicates a faint bottle green stain: with phosphate of ammonia and soda, it also dissolves, affording a lemon yellow glass, which on cooling, becomes clouded and fades to a cream color.

Digested, in the state of an impalpable powder, with nitromuriatic acid, it offered no signs of decomposition.

1. After having tried to effect its decomposition, by igniting it alone, first with potash and then with carbonate of soda, neither of which succeeded perfectly, I employed a mixture of five parts of carbonate of soda, and two of calcined borax. This process proved nearly effectual; and by the addition of two parts of nitrate of potash to the same proportions, in a succeeding trial, the whole of the mineral employed was decomposed.

2. The fused mass indicated manganese by an intense green color, which it communicated to the water, added to effect its separation from the crucible. With muriatic acid the green color passed to a red, and finally to a rich lemon yellow; at the same time, occasioning an abundant white precipitate.

3. The muriatic solution, (2.) separated from its insoluble precipitate, was digested with nitric acid; and a part of it decomposed by potash in excess, and the solution boiled for a few moments upon its precipitate.

4. To the alkaline liquor, (3.) separated by the filter from its precipitate, was added muriatic acid, and through the solution a stream of sulphuretted hydrogen passed; a copious orange colored precipitate made its appearance, and immediately settled to the bottom. The precipitate was collected on a filter, dried, and exposed upon charcoal to the intense

heat of the blowpipe, when globules of metallic *tin* made their appearance.

5. To another portion of the muriatic solution, (2.) rendered neutral by ammonia, was added oxalate of ammonia: a slight cloudiness was perceptible, and after several days a small precipitate collected at the bottom of the solution;—thus indicating the presence of *lime*.

6. The remainder of the original muriatic solution, (2.) was neutralized by the cautious use of ammonia, and to it was added succinate of ammonia; a copious precipitate of *oxide of iron* made its appearance.

7. The solution from which the iron had been thrown down, (6.) was boiled with an excess of carbonate of soda, which occasioned a precipitate of *oxide of manganese*.

8. The white precipitate, insoluble in muriatic acid, (2.) was thoroughly boiled with warm water. A portion of it was digested in aqua ammoniæ; the liquid, after having been passed through the filter, was saturated with muriatic acid, without producing any cloudiness. Therefore it was inferred, that no tungsten exists in the mineral under examination.

9. I then engaged in the following examination of the remainder of the white precipitate, (2.) in which I took the greater interest, from never before having had it in my power to repeat any of the experiments that have been made upon the compounds of columbium, on account of the rarity of that metal; and I have thought it worth while to connect an account of them with the present notice, for the satisfaction of those whose confidence, with regard to the nature of a doubtful mineral, is increased by its chemical examination; although I am aware, it may appear superfluous to the mere mineralogist, who is accustomed in such cases, to rely solely upon the characteristics of his science.

A small portion of it, still moist, was placed upon a piece of bibulous paper, which had been moistened with a solution of nut galls; the mass immediately assumed a rich orange color.

A portion of it was heated to redness in a platina crucible along with six times its weight of carbonate of soda. The resulting mass presented upon its surfaces delicate silky white, prismatic crystals. Warm water was added until the whole was dissolved. The solution when treated with the following reagents, produced the following effects.

1. Prussiate of potash. No change.
2. Gallic acid. An orange red color, without a precipitate.
3. Solution of nut galls. The same.
4. Sulphuric acid, )
5. Nitric acid, ) A milk white precipitate.
6. Muriatic acid, )
7. Hydriodic acid. )
8. Phosphoric acid, )
9. Chromic acid, ) A milk white cloudiness.
10. Acetic acid. }
11. Arsenic acid, )
12. Oxalic acid, ) No change.
13. Tartaric acid, )
14. Tartrate of potash. }
15. Nitrate of lead, } A copious, milkwhite precipitate,
16. Nitrate of silver. } not re-dissolved by nitric acid.

If any one will be at the trouble of comparing these various results, with those obtained by Mr. Hatchett, in his original memoir upon columbium,\* or with those of Dr. Thomson, in his attempt to ascertain the atomic weight of columbic acid,† he can entertain no doubt that the substance just examined, was the columbate of soda.

I now introduced about ten grains of the columbic acid, into a small gimblet hole, made in a very compact piece of charcoal, stopping the orifice by means of a plug of the same substance. The charcoal was surrounded by sand in a covered Wedgewood crucible, and subjected to the heat of a powerful forge for one hour. On the cooling of the crucible, the columbic acid was found to be completely reduced into a porous, firmly cohering, metallic mass, of an iron grey color; and occupying nearly the same bulk as before its reduction. It was with difficulty impressible by the knife, and when recently scraped, showed a feeble metallic lustre. Specific gravity, 5.571. It was brittle, and reducible to powder under the pestle. A portion of the powder was boiled for one hour in nitro-muriatic acid, without being made to undergo any change; but when fused along with potash, it afforded a solution in water, from which the strong acids threw down the previously obtained white precipitate. Thus there appears to remain no doubt of the identity of the metal here obtained and the columbium.

\* Phil. Trans. for 1802, p. 49.

† First Principles of Chemistry, Vol. II. p. 77.

It was not my object to determine the proportions among the constituents of the present mineral, and I am therefore unable to make any precise statement upon the subject: but having paid some attention to the relative bulks of the precipitates in one or two instances, I was led to conjecture, that the columbic acid does not form less than two thirds of the mineral, and that the tin is present in a proportion, but little inferior, either to the iron or the manganese; while the lime exists only as a trace.

Before concluding this account, I would remark, that I am not without hope, that a further supply of this desirable mineral, may be found in Chesterfield; although all search which has been made, since the discovery of my specimens, has proved ineffectual. The fact, that the loose mass which afforded them, was situated, at a little distance from the south end of the tourmaline ledge,\* and that it corresponded so very remarkably in its general structure with that part of the rock, seems to indicate that this was its original deposit; and holds out, I think, sufficient inducement to the collector to search for it, in this direction.

It may also appear worthy of notice, as it seems to indicate that columbite is probably a more widely diffused substance, than has been supposed, that, I possess minute masses of it from two places in Goshen: one, from the farm of Mr. Weeks; and the other, four miles distant, from the first discovered locality of spodumene. In both of these instances, they are engaged in the spodumene, in the form of imperfectly tabular crystals. I have also noticed the same substance, in very distinct, though minute crystals in Middletown; (Conn.) upon one of the high granite hills, about half a mile north east of the tourmaline deposit. It occurred in a loose fragment of granite, consisting chiefly of beryl.†

---

\* Now famous throughout the mineralogical world, for its beautiful parti-colored tourmalines.

† When at Haddam, about a year since, one of the quarry men, showed me a black crystal, nearly an inch in diameter; which he informed me, had been considered columbite. It was black spinelle; but the summits of two of its opposite pyramids being wanting, its form was not at first distinguishable. I mention this fact, not as doubting at all the existence of columbite at Haddam, for this is established upon the best authority; but to put the collector, who visits that spot, on his guard, lest he should be deceived in the specimens offered him, since both these substances occur together in the chrysoberyl rock and often in masses so minute, that their crystalline form cannot well be distinguished. The spinelle, is more abundant than the columbite; an opinion of the scarceness of which, may be formed from the fact, that I never have met with a single specimen of it, among the products afforded by three blasts of this rock, which I have had, at different times.



ART. II.—*Translation from Mr. Schumacher's Astronomical Journal, (Astronomische Nachrichten,) Hamburgh, No. 137. On the plans, arrangements and methods, proposed and used by Mr. F. R. Hassler, with a view to an accurate survey of the coast of the United States, by the Chevalier F. W. Bessel, Professor in the University of Königsberg. Communicated by PROF. JAMES RENWICK, of Columbia College, New York.*

IN 1807, Mr. Hassler then in Philadelphia, was requested, on the part of the government of the United States, to furnish a plan for the survey of the whole coast of that country. This was done in a letter to Mr. Gallatin, which proves great insight into the nature of such operations. It is evident from it, that the survey was to have been a work of great extent, and such as should satisfy the requisites both of geography and of navigation.

In consequence of this plan, Mr. H. went to England to procure the necessary instruments, &c. A most complete apparatus was brought together, consisting principally, of instruments constructed upon Mr. H's own ideas, and in the year 1816, the operation itself began. It appears to have been interrupted soon after, and therefore not to have given the expected results.\*

But Mr. H. describes his arrangements and methods in a paper which has also been printed, as an extract from the Philosophical Transactions of Philadelphia, which contains so many new views in relation to instruments, that I believe I shall make an agreeable communication to the readers of this journal by an extract from this paper, which has probably not become very extensively known (in Germany.) Mr. H. appears by it as a man, who would rather think for him-

---

\* The suspension of the operations for the survey of the coast of the United States, begun in so admirable a manner by Mr. Hassler, may be considered as a national misfortune. It is such in truth, not so much from the loss of the previous expenditures, in consequence of the delay, or from the deferring of its advantages to a future period, as from the fact, that the principles and methods proposed, and some of them actually used by Mr. Hassler, were in advance of the science of Europe at the period. As these principles and methods require the highest proficiency in mathematical and physical science, their application to practice originally in the United States, would have redounded to the national honor.

self, than imitate others, and whose arrangements therefore, always bear an independent character.

It is to be lamented that circumstances should have occurred, which hindered the complete execution of the work. To judge from the contents of the publication, not only complete success, in reaching the intended object would have been obtained, but also many other useful results.\*

According to Mr. H's plan, two observatories were to be established, one in Washington, and one in New Orleans,† these were calculated not only for the purposes of the survey, but also to subserve the general objects of astronomy. Of the observatory for Washington, the whole plan is given, which appears to me very appropriate; it recommends itself by a minute attention to all that can secure the accuracy of the observations; we miss in it none of those arrangements which on this side of the Atlantic have been made in the most modern observatories; in its special arrangements this observatory often agrees with the most modern one in Germany, that of Altona.‡ The instruments are, a *transit*, of five feet of Troughton; a *clock* of Hardy, an eighteen inch *repeating circle*; there were also to be placed in it finally a *zenith sector* and a *meridian* (mural) *circle*, &c. I cannot describe the building in detail, but I will remark that it was to be surrounded by a ditch in order the better to avoid the oscillations of the ground, by the passage of waggons, &c. The pillars of the instruments were to be placed upon solid bases six feet thick, standing in a cellar of five feet depth, and to pass through the floor of the observatory, which was

\* The opinion thus expressed by Mr. Bessel, is praise of the highest description, for no man has ever stood higher as an astronomer, than that distinguished professor.

† According to Mr. Hassler's original plan, one of the observatories was to have been established in the State of Maine, near the north eastern frontier, the other in Louisiana near the south western boundary of the United States. Circumstances led to the choice of Washington for one, the exact place of the other, although it must have been near New Orleans was not decided.

‡ The close coincidence between the plan proposed by Mr. Hassler for the observatory at Washington, and that erected under the superintendence of Schumacher at Altona is very remarkable. This last is unquestionably the best in Europe, as well as the most modern. Mr. Hassler's plans were presented to our government in 1816, but his papers were not published until 1826. The observatory at Altona was finished in the last named year. Thus it appears that these two astronomers deduced from obvious principles two plans of the closest similitude, each without any knowledge of the other's proceedings, while the American project is prior in point of date by several years.

to be supported independent of them. The axis of the transit is thirty three inches long, which also corresponds to the views of Reichenbach, who considers long axes as not advantageous; the cylindrical parts are of bell metal, as usual with the English artists. The supports are not between the pillars, but upon them; a strong metal plate is fixed upon the middle of the pillar, bearing the parts which move the Ys, and these are moved in the direction of the meridian by screws, by which the adjustment to that direction is made; the usual vertical screw is not in the arrangement; instead of this, the piece bearing the Ys, is formed like an arch, the middle of which is supported by a screw, the higher or lower position of which, elevates or depresses it by the different degree of tension of the metal which is produced by the action of the screw and its own elasticity. This method promises to secure complete stability; but it is supposed that the two pillars have the same altitude, and also that no remarkable change should take place in them. The counterpoising apparatus is placed about five inches from the end, and consists of springs, which press rollers under the axis, performing what Reichenbach effects by levers and weights. By Mr. H's arrangement, this counterpoising apparatus occupies the place on the pillars, which the supports formerly did; this arrangement likewise appears to me good; whether it would be applicable to very heavy instruments remains still to be tried.\* The two conical axes are not joined by a cube in the centre, but by a zone of a sphere of eight inches diameter, to which the two parts of the telescope tube are screwed; this arrangement is made with a view to greater stability.

Of the other instruments of Mr. H. it will not be possible to give an adequate description without drawings, but I may however indicate some of their peculiarities. The theodolite of two feet, not constructed for repetition, appears to me to possess a peculiarly good construction. From a hexagonal centre piece emanate six horizontal conical arms, whose bases are three inches, and ends one and a half inches in diameter. Upon these arms the two feet horizontal circle is made fast; three of these cones are longer; these contain

---

\* The transit of the observatory at Greenwich is adjusted in this manner, and as it is ten feet in length, the doubt whether the plan be applicable to large instruments is settled by actual experience.

at their ends the screw work for the stands by which the instrument rests upon three vertical cones of brass, fastened to the wooden stand of the instrument; between this and the six horizontal conical arms there is room for the verification telescope, which has precisely the arrangement of a transit, and hangs in its Ys, which are fastened underneath to two opposite radii. This telescope has no lateral motion, but the wires in the focus are directed by means of a screw, to the object which is taken as the point of comparison during an observation. In the same hexagonal centre piece is fastened the vertical axis, eleven inches long, and two inches in diameter. Upon this revolves a drum nine inches in diameter, and five and a half inches high; upon the upper surface of this, stand two columns bearing the Ys for the transit telescope by which the observations are made; this is a complete transit, and the columns are sufficiently elevated to allow its passage through the zenith. The horizontal angles are measured by the revolution of this upper part of the instrument, upon the vertical axis, and are read off by three microscopes, which are fixed at the end of as many conical arms, coming from the central drum, each having a micrometer screw. The illumination is made through the axis of the telescope, the one side of which is perforated, the other has an altitude circle of six inches diameter. The axis is about twelve inches long, which is more than the interval between the columns. Its supports are therefore set upon pieces of brass, elevated above the columns, and extending outwards; they have the same kind of vertical adjustment as the large transit described above.

In relation to the observations with this instrument, Mr. H. properly remarks: that the eccentricity is equally corrected by means of three equidistant readings, as by two, four, or so on; he also shews, that when the vertical axis is not perpendicular to the plane of the horizontal circle the errors of the angle will be corrected if the position of the instrument's place is alternately changed to the three truncated cones of the stand, so as to give the three regularly succeeding positions of a full revolution. These three observations, each made in the two diametrically opposite positions of the telescope, and by a half revolution of the instrument, give a mean which is free from eccentricity, from any error arising from the inclination of the circle towards the axis, or from any inequality in the supports of the axis, the readings being be-

sides made upon twelve different parts of the division. This two feet theodolite is very properly considered as the main instrument for the survey. For the other observations, repeating circles of eighteen inches, repeating theodolites of twelve inches, and repeating reflecting circles of ten inches diameter, smaller theodolites, needles, planetables, &c. are provided. To the most of these instruments Mr. H. has given a peculiar construction, but it would be too long, and perhaps without figures not sufficiently intelligible, to give a description of them here.

As signals Mr. H. employed truncated cones of block tin, about nineteen inches high, seventeen inches diameter at bottom and fourteen at top; these were erected upon poles eight feet high, and rendered the best services. At a distance of about forty (English) miles they appeared as a luminous point, when the sun stood so that the rays of it were reflected towards the observer, which lasted during a sufficient length of time. At shorter distances the light was so strong, that a dark glass was often required for the observation. Here the same principle is made use of which in Mr. Gauss's heliotrope, produces such a decided effect, but the advantages of the different arrangements are very unequal, because the cones of Mr. H. do not constantly reflect an image of the sun to the observer, while the heliotrope is constantly kept in the proper position to produce this effect. If the angle of the cone is represented by  $2m$ , then the cosine of half the azimuthal angle, when light shall be reflected to the observer, must be equal to the sine of half the sun's altitude divided by the sine of  $m$ . This would take place only during a moment if the sun had no diameter, and generally speaking, one signal would be invisible, when the other is visible, but as,  $m$ , is only a small angle, in the cones used by Mr. H. it is only  $4^{\circ} 58'$ ; and as from the altitude of the sun, on account of the magnitude of its disk, two limits may be accepted, which are at  $32'$  distance from each other, the azimuthal distance corresponding to the altitudes of the sun, which admit of a reflection to the observer in a direction nearly horizontal, has a considerable magnitude within these limits; it therefore can have rarely happened, that both the signals needed for the measurement of an angle, could have shewn at the same time, an equally well reflected image of the sun; it seems therefore, that the use of these signals might rather be recommended in particular cases than generally. How-

ever Mr. H. says, that even without the direct light of the sun, they also rendered good service, and were visible at great distances.\*

Mr. H. has also communicated his methods for the comparison of the standard measures of length, and the results of their application; we gain by this a new comparison of the French and English measures, which I shall quote more in particular. There were three meters present. One of iron, which was one of those made by the committee of weights and measures in Paris 1799, and distributed as authentic among the foreign deputies; the two others, the one brass, the other iron, were of Lenoir, but not compared directly with the original, they therefore were not considered as principal in the results of comparison. These meters were compared with a scale of Troughton, of eighty two inches in length, divided upon silver to tenths of inches, to which is added, a micrometric apparatus to take off measures from the scale. Instead of the usual method in comparing a meter *à bouts* with one *à traits*, to place butting pieces with lines drawn near to the end of them, the distances of which, are measured by the microscopes when these pieces are laid together, Mr. H. employed the end planes themselves, for that purpose he constructed the butting pieces exactly of the same thickness as the meters, and obtained, by the close juxtaposition of both, a line, which presented itself like a division line of the scale. By means of several experiments, (reduced to 32° Fah. and adopting the expansion of the iron and the brass, as Mr. H. determined it by his own experiments, namely between the point of melting ice and the boiling heat of water;)

---

\* To use the heliotrope, two conditions are indispensable: the attendance of an assistant at each signal station to direct it to the observer, and its actual illumination by the rays of the sun. Had Mr. Hassler's operation been intended to include no more than a net work of great triangles, the heliotrope might perhaps have been used, as no more than two signals need have been observed from each station, and two assistants would have sufficed for their management. But the survey being necessarily conducted with a view to its immediate application to geographical and hydrographical purposes, it would have been necessary to multiply the signals to such an extent as to have rendered it impossible to employ so many separate attendants. Mr. Hassler's signals also answer well even in a cloudy state of the atmosphere, if the other circumstances be favorable, as frequently happens. The objection that two signals could rarely have shewn an equally well defined image of the sun, does not hold good, when a fixed instrument observing without repetition is employed. We cannot therefore but think, that for all general purposes, the signals of Mr. Hassler are preferable to the heliotrope of Gauss.

$$\left. \begin{array}{l} \text{iron} = 0,0012534363 \\ \text{brass} = 0,0018916254 \end{array} \right\}$$

the length of the meter was determined to be 39,381022708 inches of the scale, which, as the standard temperature of the English measure is 62° Fah. gives the length of the meter in English inches

$$= \frac{39,381022708}{1,0003152709} = 39,36861 \text{ inches English.}$$

The two copies of meters give less, (0,001 inch,) but these were compared with both: the scale of Troughton in America, and that which this artist himself uses in London, and had upon both very nearly the same length; whence it may be concluded, that both English scales agreed very nearly. Thus according to Mr. H.'s comparison the meter is 39,36861 English inches: according to the comparison of two other copies by Kater = 39,37079. According to Vol. III. of *Base du Systeme Metrique*, page 369, the meter of platinum was = 39,382755; that of iron = 39,382649: both measured upon the brass scale of Mr. Pictet, reduced to the temperature of melting ice; at a mean = 39,3827, which, according to Borda's expansion for brass, (0,001783,) by which the experiments made in Paris were reduced to the point of melting ice, from a temperature = 12°,75 centigrade, at which they were made, gives 39,37100. The two last comparisons agree very nearly, and their difference lies entirely within the limits of the uncertainty of the thermometrical influence. The authentic meter of Mr. H. appears, however, really to be shorter, though it could be brought nearer to the others by accepting other proportions for the expansion of metals.\* This, however, appears not to be allowable, when the results of different comparisons are to be collected; for the determination of the expansion is as important as the comparison itself; therefore, each observer must remain answerable for that one which he adopts. I think it should be enquired whether two metals of the same chemical composition, have always the same proportion of expansion; or if

---

\* The meter used by Mr. Hassler in his comparisons, and which the Chevalier Bessel suspects to have been too short, was *an original issued by the French commission*, and is therefore far more authentic than the copies used by Kater. We are happy, however, to be able to state, that Mr. Hassler has recently been engaged at Washington in further comparisons, and will probably make his results public in a short time. They are said fully to confirm his former experiments.

a small chemical difference may not have a remarkable influence upon it: this investigation is more easy than that of the absolute expansion itself. It can be known only after a previous experiment of this kind, whether the results of two observers must agree in the same metal; or if it is really necessary to determine the expansion for each piece of metal in particular: I fear that without this enquiry there must always remain an uncertainty in respect to the comparisons of standard measures.\*

Among the various copies of the toise, which Mr. H. compared to the English scale, that constructed by Lenoir and compared by Messrs. Bouvard and Arrago, appears worthy of being accepted as authentic. When both measures are at the temperature of melting ice, this toise measures 76,74192710 inches of the scale of Troughton. By the normal temperature of both,

$$=76,74192710 \frac{1,0002036843}{1,0003152709} = 76,73336 \text{ English inches.}$$

As the meter is = 443,296 lines of the toise, (Base metrique, tome iii, page 433,) the proportion between the English and French feet, according to Mr. H. will be by the

$$\begin{aligned} \text{meter,} &= \frac{39,36861}{443,296} 12 = 1,0657063, \\ \text{toise,} &= \frac{76,73336}{72} = 1,0656411. \end{aligned}$$

According to Kater's comparison, it is = 1,06576411.

It appears then, that the different copies of the meter do not always agree together. Mr. H. deduced from several comparisons the value of the meter in parts of the toise, but this, I consider, is not allowable; for the ratio between the two is determined by a law, by which the meter has received its true definition; and the earlier one, that it shall be the ten millionth part of the earth's quadrant, was lost. If certain copies of these measures do not agree together, it shews only that the law is not exactly fulfilled by them; and as it is much more difficult to transfer to another metallic bar 443,296 lines of the toise than the whole length of the toise, the comparison of the meter is a circuitous and unprofitable

---

\* Copies of the meter have been made of platinum, but it will be obvious from these remarks of Bessel, that it is by no means a fit substance for such purposes, inasmuch as it is both difficult to work and to free from adventitious substances.



way, as long as the toise itself is yet obtainable as easily as it was at the time of the construction of the meter.

The apparatus which Mr. H. had constructed for the measurement of the base line, differs essentially from all that are known to me; therefore I will describe it somewhat more particularly. The ends of the bars are not planes, but cut

out, so that viewed from above they present the form 

over this middle excavation the hair of a spider's web is stretched, which therefore indicates the end of the bar: over each of the ends a compound microscope is placed, which stands upon a separate support, and therefore does not change its place when the bar is moved or taken away. When this microscope is placed over the spider's web, the place of the end of the bar is determined by it; the bar can then be taken away, and the other end of it can be made to coincide with the point where the first had been before seen to coincide with the cross strokes of the microscope, which in the mean time has retained its position independently. The microscope has the following arrangement: the object glass consists of two half lenses of different foci, one of which makes, in the focus of the eye glass, an image of the spider's web of the bar, and the other an image of two rectangular crossing black lines, drawn upon an ivory plate, which is fastened to the microscope: this arrangement can be elevated and lowered, and moved in two horizontal directions at right angles to one another. In the use, the stand being first properly placed, the microscope is brought to that elevation in which the spider's web thread is distinctly visible, then it is moved until this thread appears exactly to cut the cross upon the ivory plate; the bar is then removed and advanced one length forwards, the end of it is next brought into the proper position by the mechanism of the bar, and it is moved by it until the spider's web of this other end coincides again by an optical contact with the cross on the ivory plate. Of these microscopes there are three with all their arrangements; the last ones always remain standing during the next subsequent operation, that in case of any accident the work might be begun again from them. The bar itself is a junction of four pieces, each of two meters in length, held together by iron clamps: the inclination of this bar to the horizon is measured by a sector, nearly as in Delambre's apparatus. When the work is interrupted during the night,

the last position of the bar and the microscopes remain undisturbed in their position until morning. The arrangement of the boxes in which the bars are contained and the mechanism of the movements appear to me very well planned.

From what little I have quoted, it may be easily seen, that the paper of Mr. H. deserves the attention of those who take an interest in the mechanical arrangements necessary in practical astronomy and geodesy. It is to be lamented, that such a complete apparatus as that now on hand in America, has not been applied according to its intention and by its author. (Signed,) F. W. BESSEL.

ART. III.—*On the Effect of Quantity of Matter in Modifying the Force of Chemical Attraction*; by ELISHA MITCHELL, Professor of Chemistry, Mineralogy, and Geology, in the University of North Carolina.

IN my present communication to the Journal, I do not propose to bring forward any new fact or argument. With reference to the subject of which it treats, both have already been sufficiently multiplied. My object is merely to call the attention of chemists, to some facts that appear to have been unaccountably neglected, and to correct mistakes respecting others, which have found their way into books of the greatest authority.

It is stated, in substance, in our treatises of chemistry, that the force of chemical attraction is modified by the quantity of matter by which it is exerted, and in some of them, the opinion is advanced, that quantity of matter may in some cases, compensate for a weaker affinity. But the statement is generally made in such a way, and accompanied by so many qualifications and expressions of doubt and hesitation, that it appears like a reluctant admission of a disagreeable truth rather than a free and willing enunciation of a law of nature. The following extract from one of the best of our elementary books, may serve for illustration.

“Though this mode of determining the relative forces of affinity, cannot be admitted, it is possible that quantity of matter, may some how or other, compensate for a weaker affinity, and Berthollet attempts to prove it by experiment. On boiling the sulphate of baryta, with an equal weight of pure potash, the alkali is found to have deprived the baryta

of a small portion of its acid, and on treating oxalate of lime with nitric acid, some nitrate of lime is generated. As these partial decompositions are contrary to the supposed order of elective affinity, it was conceived that they were produced by quantity of matter acting in opposition to force of attraction. But they by no means justify such a conclusion. In the decomposition of sulphate of baryta by potash, no care was taken to exclude the atmospheric air during the operation: the alkali must consequently have absorbed carbonic acid, and it is an established fact, that carbonate of potash, decomposes partially the sulphate of baryta. A similar omission appears to have been made in the other experiments, where decomposition was attempted by pure potash or soda. In many instances, the result may fairly be attributed to other causes."—" *On the whole, therefore, we may infer that Berthollet has given no satisfactory case, in which quantity of matter is proved to compensate for a weaker affinity.*"\*

To the experiments of Berthollet, we shall presently have occasion to return. In the mean time, we may remark that the influence of quantity of matter in modifying the force of chemical attraction, in some particular cases, is universally admitted.

1. In the case of solution. It is well known and acknowledged, that a given weight of any salt thrown into so much water as is barely sufficient to effect its solution, will not disappear as rapidly as when the quantity of water is considerably greater.

2. In those cases where an element A. enters into combination with another element B, in two, three or more different proportions; each *additional* dose of A, appears to oppose a feebler resistance to any force that may be employed to separate it from B. A familiar example is furnished by the black oxide of manganese, which from a tritoxide, is converted into a deutoxide, by the application of a low red heat, whilst no elevation of temperature to which it can be subjected, effects a perfect decomposition and the separation of all the oxygen.

---

\* Turner's Chemistry, p. 87.—See also, Davy's Elements of Chem. Philosophy, Div. 1, Chap. 6, Sect. 13—18. Paris's Med. Chem. Sect. 237. Ure's Dictionary, Art. Attraction. Brande has neglected this subject while he has introduced a minute account of such obscure subjects as uranium, tungsten and molybdenum into a work intended for persons obtaining a knowledge of Chemical Philosophy, and "the *principal* facts of the science."

But does not this substance, in the common process for obtaining oxygen, afford a striking instance of the effect of a relative increase in the quantity of matter, in modifying the force of attraction, even beyond those limits at which definite proportions are formed? It is not necessary for us to attend at all to what remains after the operation is finished, or to enquire whether it be a pure deutoxide or a mixture of that and the protoxide. It is sufficient to observe that a low red heat determines the separation of the oxygen—that a continual elevation of the temperature is necessary to maintain a regular and uniform flow of the gas—and that the process is stopped when the gas-bottle is heated to whiteness, and the gas still continues to come over, though but slowly.\* The carbonate of lime affords corresponding results. A low red heat drives off the carbonic acid but for its entire separation, a violent heat is required, even when the carbonate has been procured from the muriate, by means of a carbonated alkali, and is therefore in the state of an impalpable powder.

These examples are valuable on account of their simplicity, and because they are not embarrassed by the question about sub-salts and super-salts, and the state in which the chemical elements exist in a solution. Why is it that the low red heat which decomposes one particle of the carbonate, does not decompose every particle? The fact may be explained, (and the explanation extended, *mutatis mutandis*, to other chemical combinations,) upon either of two suppositions.

1. The improbable one that between different atoms of lime and carbonic acid, there is a difference in the strength of their affinities, so that there may be a separation of the component atoms of one particle of carbonate of lime, by a force that is altogether inadequate to the decomposition of any other particle.

2. That the force of affinity reaches beyond the distance at which atoms combine, and compounds definite in their proportions are formed, so as to exert an influence upon atoms between which there is no proper chemical combination, and enable a large number to compensate by the strength of their united action for the feebleness of the force

---

\* Lorsque l'oxide sera près de la chaleur rouge il commencera à se dégager du gaz oxigène. Vous pourrez regarder l'opération comme faite lorsque le fourneau étant plein de feu il ne se dégagera presque plus de gaz.—*Thenard*.

exerted by each. This hypothesis admits of the following illustration.

a a a æ a a a æ a a a

The letters (a) represent atoms of lime; the letters (e) atoms of carbonic acid, and all of them together, a quantity of carbonate of lime, which has experienced the decomposing agency of heat. The double letters (æ) represent atoms of carbonate of lime undecomposed; upon the carbonic acid (e) of which a force is exerted by the surrounding particles of uncombined lime (a) to prevent its escape. The force exerted by each uncombined (a) upon the (e) of the carbonate, is very small when compared with that exerted by the (a) in proper chemical union; and capable of being overcome by the weak affinity of water or other agent—and yet the united force of all the uncombined (a's) though amounting to only a third, a half, or some other larger or smaller fraction of that of the single (a) in chemical combination, is such as to require a considerable elevation of temperature to overcome it. The *tendency* to definite proportions, in all cases, and its existence in most, is here fully admitted.

But passing by this, which is merely an hypothesis, destitute of proof and incapable of it, we return to the principal subject of this paper: That it is a law of *extensive application*, that the quantity of matter modifies the force of chemical attraction, and compensates for a weak affinity. The recollection of every practical chemist, will suggest to him other examples analogous to the above, and pointing to the same conclusion, but perhaps no facts are more to our purpose than those collected by Berthollet, and laid by him as a foundation on which to build his theory of chemical affinity, if once the mistakes and misapprehensions prevailing respecting them are cleared away.

At the beginning of the present century, few names were more honored and respected amongst chemists than that of Berthollet. He was always spoken of as the profound and accurate. That the quantity of matter modifies the force of chemical attraction, so as to compensate for a weak affinity, was his favorite theory. In support of it when first advanced, he brought forward seven new experiments, instituted by himself for the express purpose of testing at once, and demonstrating its correctness, besides calling into view some important facts with which chemists had long been familiar.

But Berthollet was not content with the establishment of this law. He drew the additional conclusion that except where the existence of definite proportions is determined by the forces of cohesion, elasticity, etc. chemical agents combine in all proportions indiscriminately. As this was altogether at variance with the views which chemists were presently engaged (with a zeal hardly commensurate to its vast importance) in establishing, respecting chemical combination, comprising the doctrine of definite proportions and the atomic theory, they looked with an evil eye upon Berthollet, his experiments and conclusions—regarding him apparently as a powerful antagonist, who might suddenly demolish their favorite doctrines. Two of his experiments were attacked by Sir Humphrey Davy, who in the *Elements of Chemical Philosophy*, supposed himself, and was supposed by others, to have “pointed out several sources of fallacy, which had escaped the observation of Berthollet.”\* The confidence of men of science in the accuracy of the French chemist, was thus shaken and his experiments and opinions alike neglected.

And yet Berthollet was by no means that inaccurate and short-sighted being he has sometimes been represented to be—and I think it will appear on a careful examination of his experiments, that the fallacy was on the side of his critics and commentators.

“I have kept an equal quantity of potash and sulphate of barytes in a small quantity of boiling water. The potash had been prepared by alcohol and contained no carbonic acid: the same served for the following experiments. The operation was performed in a retort, and consequently *not* in communication with the air; and it was continued until the mixture was desiccated; the residue was washed with alcohol, which dissolved the potash, and after that with water, which also produced an alkaline solution, the alkali of which I saturated with acetic acid; after which by evaporation, the solution yielded crystals possessing all the characters and qualities of the sulphate of potash. Whence it appears that the sulphate of barytes was partially decomposed by the potash, and that the sulphuric acid was divided between the two bases.”—*Berthollet's Researches into the laws of Chemical affinity.*

---

\* Paris's Med. Chemistry.

“Berthollet has asserted, indeed, that a large quantity of potassa, is capable of separating a small quantity of sulphuric acid from the sulphate of barytes; but his experiments were made in contact with the atmosphere in which carbonic acid is always flying about; but it is well known that the carbonate of potassa and sulphate of baryta, mutually decompose each other.”\*—*Davy's Elements of Chemical Philosophy.*

It appears therefore, that “the sources of fallacy” *did not* “escape the observation of Berthollet,” and that he supposed himself to have obviated them. He knew very well that carbonate of potassa and sulphate of baryta mutually decompose each other and that carbonic acid is absorbed by potassa, when it is boiled in contact with the atmosphere. He took care therefore, to employ such potassa as “contained no carbonic acid,” and then carried on the process in a retort, which being kept constantly filled with watery vapor, the contact of the atmosphere was effectually prevented. Even if this had not been the case, the quantity of carbonic acid that could have entered by the beak and travelled along the neck of the retort to the materials, must have been inappreciable; certainly not adequate to the production of a quantity of sulphate of potassa that could be crystallized. It is obvious however, that Berthollet's experiment did not differ from the common process, *invented by him*, for procuring pure potassa, except that the retort was filled with the vapor of water instead of the vapor of alcohol.†

---

\* As I have no English copy of the Chemical Philosophy to refer to, I subjoin so much of Van Mons' French translation, as is retranslated above. “M. Berthollet a posé en fait qu'une grande quantité de potasse peut séparer une petite quantité d'acide sulphurique d'avec le sulfate de baryte; mais ses expériences furent faites en contact avec l'atmosphère dans laquelle voltige toujours de l'acide carbonique; ou le carbonate de potasse et le sulfate de baryte se décomposent mutuellement.”

† I have sometimes suspected, that a trivial mistake of the translator of the Researches into the laws of Chemical Affinity, in writing out his copy for the press, or of the corrector of the proof sheets of the first edition, has been the source of these errors. In my copy, Berthollet is made to say, “The operation was performed in a retort, and consequently in communication with the air;” and with this the quotation of Dr. Murray, (*Chemistry*, Vol. I. p. 81.) agrees. Berthollet, instead of any such confession, says in fact, “L'opération s'est faite dans une cornue et par conséquent *sans* le contact de l'air.” The conditions of Berthollet's experiment, were such as should have suggested the appropriate correction. That lesser men should commit such blunders as this, must evidently be, if the case be as I have supposed, it is quite natural: but that Sir Humphrey Davy should build an argument, to overturn the theory of

Turner says, "A similar omission [to exclude the atmosphere] appears to have been made in the other experiments, where decomposition was attempted by pure potash or soda." Though Berthollet does not state in express terms, at the commencement of every experiment, upon the results, of which the carbonic acid present in the atmosphere could have an influence, that it was excluded, he does make this statement in substance, respecting the second as well as the first;\* and where we find these marks of scrupulous caution in two cases, it is but a piece of common justice, to suppose they were not wanting in the others, and that the mention of these was omitted, merely because it was supposed to be unnecessary.

The language of Davy, in the objections he has framed to the seventh, or last and least valuable of Berthollet's experiments, shows that he did not recur to the writings of that chemist, to see what the experiments really were; and though it is barely possible, there might be something like the play of affinities supposed by him: the view of the change taken by Berthollet, is far more simple and has a stronger probability in favor of its correctness. Of the facts long known to chemists and cited by Berthollet—that no amount of quick lime, for instance, will completely decompose the carbonate of potash, no explanation is attempted.

All these arguments and experiments therefore, by which Berthollet was once supposed to have proved, and proved decisively, that the quantity of matter modifies the force of chemical attraction so as to compensate for a weak affinity, remain unanswered and unshaken; at least so far as Sir Humphrey Davy and the English chemists are concerned.

Experiments were brought forward by Pfaff, tending to show, that in *some cases* quantity has *no influence*. These it was necessary for Berthollet to explain, in accordance with his views, and he published an answer to the paper, in which they were detailed. *But with this dispute we have here no concern*, though Pfaff's experiments are sometimes absurdly enough cited to prove that quantity of matter has

a distinguished chemist, solely on his own misconceptions of the experiments by which that theory is supported, and the error be propagated from one book to another for years, is lamentable.

\* "Le sulfate de potasse ayant été soumis à la même épreuve avec poids égal de chaux," etc.



*no influence in any case.* The probability is, that like the attraction which it is supposed to modify, (and which, powerful as it is well known to be between oxygen and the bases of the alkalis, becomes evanescent in the case of carbon and the metals,) its influence varies through the whole range of chemical agents, and that it sometimes produces no effect whatever. But unless we will abandon the fundamental maxim of the Baconian philosophy—that our opinions are to follow in the track of observation and experiment, it appears to me that we must admit it to be a law of *extensive* application, *that the quantity of matter modifies the force of chemical attraction, so as often to compensate for a weak affinity*: and having admitted it, apply it in the explanation of the fact, that in the manufacture of nitric acid, it is of advantage to employ more sulphuric acid than is barely sufficient to neutralize the potash of the nitre; and other corresponding cases, without resorting to the intricate and roundabout hypothesis of Bergman.

The principal obstacle to the general reception of these views, seems to have been found in their supposed inconsistency with the truth of the doctrine of definite proportions and the atomic theory, though it would be difficult to show that they are absolutely incompatible. Thus with regard to Berthollet's first experiment with potassa and sulphate of baryta, instead of supposing with him, that the sulphuric acid detached from the baryta, combines in the first instance with *all* the potassa, and that the existence of the sulphate, with definite proportions, is determined by the force of cohesion, we may hold, (if it be safe to hold any opinion about the mode of existence of the chemical elements in a solution,) that there are in the boiling liquid, four different substances, sulphate of baryta, sulphate of potassa, baryta and potassa; the influence of the uncombined baryta, being exerted to prevent the decomposition of the sulphate of baryta from proceeding any farther, and that of the uncombined potassa to maintain in existence the sulphate of potassa that has been already formed.

I will, in closing, only call the attention of any reader of the Journal, who may have had the patience to accompany me thus far, to the following extract from the preface to Thomson's First Principles of Chemistry.

“But it is much more difficult to obtain substances in a state of complete purity, than chemists in general are aware:

it was in reducing the different salts which I employed, to the greatest possible degree of purity, that the greatest part of my time was wasted. I have in all cases, in which it was in my power, deduced the atomic weights of bodies from the rigid analysis of the neutral salts into which they enter, because it is much easier to obtain neutral salts pure, than any of the metallic bodies which constitute their bases. Indeed, not a few of the metals have never yet been exhibited in a state of absolute purity."

This obstinate adhesion of contaminating substances, appears very little like the effect of either mere mechanical mixture or ordinary affinity. It indicates rather a modification of that affinity, by a relative increase of the quantity of matter, so as very greatly to add to the energy of the attractive force. And it is probably in the prosecution of the very business, in which Thomson was at this time engaged, (that of accurate analysis,) that chemists are destined, hereafter, to find this law of chemical action, interposing obstacles in their way, which it will require all of their skill to elude, or of their perseverance to overcome.

ART. IV.—*Iodine in the Mineral Waters of Saratoga.*—*Communicated for the Journal of Science, by JOHN H. STEEL, M. D. of Saratoga Springs, in the State of New-York.*

THE Mineral waters of Saratoga, which have become so celebrated for their Medicinal qualities, are situated in a low marshy valley, along the termination of a ridge of secondary limestone; they discover themselves in a bed of blue marl, which covers the valley throughout its whole extent, and to an unknown depth. On digging into this marl, to any considerable distance, in almost any direction, we are sure to find a mineral water; in some places, at the depth of six or eight feet, it is discovered issuing from a fissure or seam in the underlying limestone, while at other places, it seems to proceed from a thin stratum of quicksand, which is found to alternate with the marl at distances of from ten to forty feet; at this last depth, the marl is interrupted by a layer of bowlders of a considerable size, beyond which no researches have yet been made.

All the mineral fountains that have yet been examined in this valley, and there are more than twenty, are found to possess uniformly, the same *qualities*, differing only in what is usually termed their *strength*, or, in other words, in the quantities of the articles which the water of each is found to hold in solution. They belong to a class which may with propriety be styled the *acidulous saline chalybeate*. The best analyses agree in demonstrating that they contain the following ingredients, viz.

Carbonic acid.

Muriate of soda.

Carbonate of soda.

Carbonate of lime.

Carbonate of magnesia, and

Carbonate of iron, together with a very minute quantity of Silica and alumina.

The great efficacy of these waters in a variety of strumous affections, for which their known properties did not very satisfactorily account, gave origin to the conjecture, that they might contain *Iodine*, and the fact of that substance having been recently discovered in some of the mineral springs of Europe, gave confidence to the opinion which led to an investigation; as soon, therefore, as leisure would permit, an examination was commenced, with a view to that particular point, and the result of the following experiments will, I trust, be considered as sufficiently conclusive on the subject.

Having procured a quantity of the salts of one of these fountains, soluble in distilled water, I dissolved thirty grains of them in a weak solution of starch in cold water, and then let fall into the solution a drop or two of sulphuric acid; this produced a slight effervescence and the liquor immediately assumed a deep purple tinge,—on suffering this to stand at rest a short time, the color was precipitated with the starch giving it the well known characteristic blue tinge. The clear liquor was now turned off and the colored starch placed upon the surface of a warm stove, when the color was immediately dispersed.

Having thus ascertained the fact of the existence of *Iodine* in these salts, it became important to acquire a knowledge of the manner in which it is combined and retained in the water.

Iodine may exist in a mineral water in the state of *iodic* or *hydriodic* acid combined with either of the alkalies, potassa

or soda, forming the iodate or hydriodate of the alkali, with which they are united. As the presence of *potassa*, in any of its combinations, in these waters, has not been indicated by any of the appropriate tests used for the purpose, it follows that soda is the alkaline base, which retains the acid in question, forming the iodate or hydriodate of soda. To ascertain which of these acids forms the salt in question, I poured over a quantity of the dry *soluble* salts of the water, an ounce of very pure alcohol, which, after standing a short time, was filtered off; this was found to contain the whole of the matter, which indicated the presence of iodine, and as *iodate* of soda is not soluble in alcohol, I infer that the substance taken up by the alcohol is the *hydriodate* of soda.

With a view to illustrate the position still further, and to arrive at the proportion of this salt, contained in a given quantity of the water, I evaporated one gallon of water in a porcelain basin placed in a sand bath, which was kept at the temperature of about 150°, and the evaporation was continued until crystals of muriate of soda began to form on the sides of the basin; it was now removed from the bath, and when cold the whole contents of the basin were thrown on a filter and the residuum, being well washed with recently distilled water, was removed and the filtered liquor again placed on the sand bath in a small basin, and suffered to evaporate to dryness, in a temperature of 150°.

Alcohol of the specific gravity of .825 was thrown over these salts, and after being frequently stirred, was filtered and the filtered solution evaporated to dryness. The residuum weighed, while warm, a trifle over three grains. It consisted principally of the hydriodate of soda, with a very minute quantity of common salt, which the small quantity of water in the alcohol used, and, possibly, the imperfectly dry state of the salts, before the alcohol was added, contributed to render soluble in that menstruum.

I now dissolved the salts thus obtained in a small quantity, of starch and water and having placed the solution in a Florence flask, over a spirit lamp, added to it a few drops of sulphuric acid; as it became warm, the blue color of the starch, which had settled to the bottom of the flask, began to disappear, and at the same time the well known *purple fumes* of iodine, appeared very conspicuous at the neck of the bottle, furnishing the most incontestible evidence of the presence of that highly volatile substance.

Nearly all the mineral springs at this place have been carefully examined and found, uniformly, to agree in affording indications of the presence of iodine. The waters of Ballston, have not yet been examined, with a view to this particular object, but, from the striking similarity of the waters in the two places in other respects, there can be but little doubt of their agreeing in this. I had expected to have discovered it in the brine springs of Onondaga, but a bottle of that water, procured through the politeness of Dr. Kirkpatrick, afforded no indications of it.

I subjoin the result of an analysis of the Hamilton Spring, with a view to illustrate the relative quantities of the various saline ingredients contained in its water.

This fountain is situated in the low ground immediately behind the Congress Hall; it was discovered and named by Mr. Gideon Putnam, one of the early settlers of the place, not long after the discovery of the Congress Spring. It was cleared out to the depth of only a few feet, and the water secured by a small wooden curb, and in this situation it remained for a number of years, its water being devoted mostly to the supply of a bathing establishment, erected in its immediate vicinity. After the decease of Mr. Putnam, the property passed into other hands, and the well has been recently sunk to a much greater depth, and more effectually secured against the intrusion of foreign substances; by which means the water has been materially improved.

The surface of the spring, within the curb, is constantly agitated, by the escape of large quantities of gas; and as the water passes off, it leaves on the surface of the earth, an abundant deposit of a brownish color, evidently ferruginous and calcareous.

The water, when first dipped from the fountain, is remarkably clear and sparkling, but on standing exposed to the atmosphere, soon becomes turbid. It is saline, and acidulous to the taste, and when taken to the quantity of five or six half pints, is usually, powerfully cathartic and diuretic.

The temperature at the bottom of the well is uniformly at 50°; and its specific gravity, at the temperature of 60°. Barometer at thirty inches, is\*

The analysis was conducted upon the most approved principles of modern analytic chemistry, and affords conclusive

---

\* As there was evidently an error in copying the number in the MS. we leave the specific gravity blank, rather than hazard the filling of the space erroneously.—EDITOR.

evidence of the correctness of the results here given; the details I am constrained to omit, as they would, obviously, extend this communication to too great a length.

One gallon, or 231 cubic inches, of this water, when first taken from the well, contains

Muriate of soda,	-	-	-	grains	297.3
Hydriodate of soda,	-	-	-	-	3.
Carbonate of soda,	-	-	-	-	19.21
Carbonate of lime,	-	-	-	-	92.4
Carbonate of magnesia,	-	-	-	-	23.1
Oxide of iron,	-	-	-	-	5.39

grains 440.4 together

with a minute quantity of silica and alumina, probably 0.6 of a grain, making the solid contents of a gallon amount to 441 grains.

Carbonic acid gas,	-	-	-	316 cubic inches.
Atmospheric air,	-	-	-	4

Gaseous contents in a gallon, - 320 cubic inches.

It may be proper to observe, that the gas was extricated from the water, by the application of heat, but was kept in the receiver, at the temperature of 60°, and under a pressure of the atmosphere, indicated by the mercury in the barometer standing at 29.5 inches. A part of the atmospheric air was undoubtedly obtained from the tube used to conduct the gas to the receiver.

ART. V.—*Observations on Ignis Fatuus; by* Rev. JOHN MITCHELL.

THOSE luminous appearances, which are popularly called “Will-o’-the-wisp” and “Jack-a-lantern,” have been alike the object of vulgar superstition and philosophical curiosity; and notwithstanding all attempts to apprehend and subject them to examination, they are not much more the subjects of knowledge now than they were centuries ago. They are still but an ignis fatuus to the philosopher, and a thing of mystery to the credulous.

I was myself, formerly, familiar with these appearances; they were of frequent occurrence near my father’s residence, owing, probably, to the proximity of extensive wet grounds, over which they are usually seen. The house stood upon a

ridge, which sloped down on three sides to the beautiful meadows which form the margin of the Connecticut, and of its tributary creeks, and which, owing to their own luxuriance and the deposits of the vernal freshets, are covered with rich and constantly decaying vegetable matter. From the circumstance, also, that we had no neighbors in the direction of these grounds, a light could not be seen over them without attracting our notice. I mention this by way of suggesting, that probably the ignis fatuus, in consequence of its not being always distinguished from the lights of surrounding houses, and therefore exciting no curiosity, is often seen than it is supposed to be.

These mysterious luminaries used often to be seen by the fishermen; who plied their nets by night as well as by day. They commonly reported that they saw them a little above the surface of the meadow, dancing up and down, or gliding quietly along in a horizontal line. Sometimes two, or even three, would be seen together, skipping and dancing or sailing away in concert, as if rejoicing in their mutual companionship. I might entertain you with abundance of fabulous accounts of them—the offspring of imaginations tinctured with superstition, and of minds credulous from a natural love of the marvellous. Fables, however, are of little value for the purposes of science: if the following account of some of the phenomena of the ignis fatuus, shall, with the observations of others, contribute towards a true theory of its nature, you will think them worthy of a place in your Journal.

A friend of mine, returning from abroad late in the evening, had to cross a strip of marsh. As he approached the causeway, he noticed a light towards the opposite end, which he supposed to be a lantern in the hand of some person whom he was about to meet. It proved, however, to be a solitary flame, a few inches above the marsh, at the distance of a few feet from the edge of the causeway. He stopped some time to look at it; and was strongly tempted, notwithstanding the miriness of the place, to get nearer to it, for the purpose of closer examination. It was evidently a vapor, [phosphuretted hydrogen?] issuing from the mud, and becoming ignited, or at least luminous, in contact with the air. It exhibited a flickering appearance, like that of a candle expiring in its socket; alternately burning with a large flame and then sinking to a small taper; and occasionally, for a moment, becoming quite extinct. It constantly appeared over the same spot.

With the phenomena exhibited in this instance, I have been accustomed to compare those exhibited in other instances, whether observed by myself or others; and generally, making due allowance for the illusion of the senses and the credulity of the imagination in a dark and misty night, (for it is on such nights that they usually appear,) I have found these phenomena sufficient for the explanation of all the fantastic tricks which are reported of these phantoms.

They are supposed to be endowed with a locomotive power. They appear to recede from the spectator, or to advance towards him. But this may be explained without locomotion—by their variation in respect to quantity of flame. As the light dwindles away, it will seem to move from you, and with a velocity proportioned to the rapidity of its diminution. Again as it grows larger, it will appear to approach you. If it expires, by several flickerings or flashes, it will seem to skip from you, and when it reappears you will easily imagine that it has assumed a new position. This reasoning accounts for their apparent motion, either to or from the spectator; and I never could ascertain that they moved in any other direction, that is, in a line oblique or perpendicular to that in which they first appeared. In one instance, indeed, I thought this was the fact, and what struck me as more singular, the light appeared to move, with great rapidity, directly against a very strong wind. But after looking some time, I reflected that I had not changed the direction of my eye at all, whereas if the apparent motion had been real, I ought to have turned half round. The deception was occasioned by the motion of the wind itself—as a stake standing in a rapid stream will appear to move against the current.

It is a common notion that the ignis fatuus cannot be approached, but will move off as rapidly as you advance. This characteristic is mentioned in the Edinburgh Encyclopædia. It is doubtless a mistake. Persons attempting to approach them, have been deceived perhaps as to their distance, and finding them farther off than they imagined, have proceeded a little way and given over, under the impression that pursuit was vain. An acquaintance of mine, a plain man, told me he actually stole up close to one, and caught it in his hat, as he thought;—"and what was it?" I asked. "It was'nt nothin."\* On looking into his hat for the "shining jelly," it

---

\* In the colloquial double negative of the common people of New England.—*Ed.*



had wholly disappeared. His motions had dissipated the vapor, or perhaps his foot had closed the orifice from which it issued. To this instance another may be added. A young man and woman, walking home from an evening visit, approached a light which they took for a lantern carried by some neighbor, but which on actually passing it, they found to be borne by no visible being; and taking themselves to flight, burst into the nearest house, with such precipitation as to overturn the furniture, and impart no small share of their fright to the family.

The circumstance that these lights usually appear over marshy grounds, explains another popular notion respecting them; namely, that they possess the power of beguiling persons into swamps and fens. To this superstition Parnell alludes in his Fairy Tale, in which he makes Will-o'the-wisp one of his dancing fairies;

“Then Will who bears the wispy fire,  
To trail the swains among the mire,” &c.

In a misty night, they are easily mistaken for the light of a neighboring house, and the deceived traveller, directing his course towards it, meets with fences, ditches, and other obstacles, and by perseverance, lands at length, quite bewildered, in the swamp itself. By this time, he perceives that the false lamp is only a mischievous jack-a-lantern. An adventure of this kind I remember to have occurred in my own neighborhood. A man left his neighbor's house late in the evening, and at daylight had not reached his own, a quarter of a mile distant; at which his family being concerned, a number of persons went out to search for him. We found him near a swamp, with soiled clothes and a thoughtful countenance, reclining by a fence. The account he gave was, that he had been led into the swamp by a jack-a-lantern. His story was no doubt true, and yet had little of the marvellous in it. The night being dark, and the man's senses a little disordered withal, by a glass too much of his neighbor's cherry, on approaching his house, he saw a light, and not suspecting that it was not upon his own mantel, made towards it. A bush or a bog, might have led to the same place, if he had happened to take it for his chimney top.

ART. VI.—*Resuscitation by Oxygen Gas, from apparent death by drowning.*

## LETTER I.

TO THE EDITOR.

Cambridge, Md. March 31, 1829.

*Dear Sir*—At the close of my chemical amusements of this winter, an accident occurred, which gave rise to an experiment, whose result deserves, I think, to be classed among the subjects of your invaluable Journal; it is one, upon the efficacy of oxygen Gas, in an extreme case of Asphyxia.

A favorite young beagle hound had fallen into a neighbor's cellar, full of water, and was drowned; how long he lay there, (which is a prominent point in the case,) can be only conjectured, from the following facts; he was heard flouncing and yelping in the water; and the family believing he was a mad dog, did not venture in, to his relief, until their negro man returned from a ride of two miles, on which he had been sent, shortly before the accident; when they supposed he had got out, as he had been long silent; but on searching, he found him lying dead under the water, and dragged him out; finding it was my dog, he informed my servant, who obtained a wheel barrow, and brought him home, and then went in quest of me; when I arrived, with some gentlemen, who accompanied me, to witness the experiment, which I proposed,—we found the dog's body and limbs, so cold, hard and inflexible, that, taking him by the foot, he was turned over, as a block with four pegs attached to it.

Having at hand some jars of gases, and fortunately, one of oxygen, which I had recently prepared for a similar experiment, with smaller animals, to be placed under asphyxia, from carbonic acid gas, but not having executed my design, I filled a large bladder with the oxygen, not diluted with any portion of nitrogen, because I wished to produce the greatest possible excitement, in a case so desperate; I attached to the bladder, a small brass stop-cock, with a long beak, and infused into his lungs, by a violent pressure of the bladder, a copious dose of the gas; upon which, he instantly made a convulsive and solitary yelp, to the full pitch of his usual and

shrill voice in the chase; the dose was repeated with the same effect, until the gas was consumed; he was placed by the fire, in warm blankets, friction constantly applied, and a strong dose of diluted volatile ammonia, forced into his stomach; his body and limbs became relaxed; his respiration short and rapid, with subsultus tendinum.

This experiment commenced at one o'clock, and at eleven that night, he raised himself on his feet, and made a few feeble steps; the next morning, he left his bed, in the kitchen, and walked to his kennel, a distance of fifty yards; but during the second, and also the third day, he suffered under a total anorexy; I ordered an enema of sulphate of magnesia, and the following night, tinct. opii 11 drachms. On the fourth day he took a small portion of meat; on the fifth and sixth days, he shows the marks of excessive atrophy; in fact, his vital functions are restored, but I am candid to say, those of the animal will (I fear) never be fully regained.

I have been minute with this case, not from a belief, that it is the first instance of the revival from asphyxia, by oxygen gas, for I have read of one, and one only; and that arose from carbonic acid gas, inhaled for experiment, by a Prof. Higgins, in Europe; but I have never met with a case of recovery from apparent death by drowning, and if any exist, they are rare; it is certainly a subject worthy of attentive prosecution. I have the honor to be yours very respectfully.

JOSEPH E. MUSE.

In answer to a request, that the history of the case might be continued, the editor received the following:—

## LETTER II.

Cambridge, Md. April 24, 1829.

*Dear Sir*—In reply to your inquiry, I am gratified to be enabled to state, that my experiment, in the case of asphyxia has become more perfect. In the course of eight or ten days, after my communication to you, the health of the subject began to improve rapidly and his *appetite, repletion* and *vivacity*, now indicate a thorough renovation of the animal functions; which candor had compelled me to declare, I did not then anticipate.

One other incident may be worthy of notice,—that his voice, which was naturally sharp and shrill, has astonishingly altered into the full and coarse; though his cough, resulting

from the accident, has, with every other symptom of disease, wholly disappeared.

Allow me to acknowledge my obligations, for the respectful sentiments, you have done me the honor to express, in your last,\* and on former occasions; which, in truth, I cannot too highly appreciate, as coming from the founder of a Journal, which is dispensing the fruits of science, to an ungrateful community; and which, though suffered to expire, will have erected, by its kindly influence, on the moral condition of man, a monument imperishable.

I am, dear Sir, truly and respectfully yours,

JOSEPH E. MUSE.

ART. VII.—*Hassler's Repeating Theodolite.*

Notice of this instrument, in a letter to the Editor, dated New York, May 8, 1829.

*Sir*—Permit me to make known, through your useful Journal, an improved repeating theodolite, by Mr. Hassler, who is so well known both in this country and in Europe, for his improvements on repeating and reflecting circles and theodolites. This instrument has just been constructed, for the first time, by Mr. Richard Patten, instrument maker of this city, for the exploring expedition, and will be found on examination as near perfection in principle, as it is possible to arrive at; compensating not only the faults of workmanship, but the errors of observation. Its adjustments are those of the repeating circle and theodolite, so well and fully described by the inventor, in his paper on the coast survey. An inspection of the drawing with the annexed description, I hope will make the superiority of this instrument well understood. It will be seen that its proportions are well adapted to give it solidity, and all its adjustments permanency. The centers, collars and axis, are all of bell metal truly turned. The triple center work, of different sized cones, moving in each other, is a very great improvement, giving great solidity and little friction, and making the instrument susceptible of any number of repetitions. I should be doing great injustice to

\* Alluding to the letter to which this is an answer: I should hardly have been willing to allow the above paragraph, (of certainly too partial commendation,) to remain, had it not been for the *present posture of affairs*, as regards the prosperity of this Journal.—*Ed.*

Mr. Patten, if I omitted to bear testimony to the excellency of his work, not only in the construction of this, but also of other instruments for the expedition. The beauty and accuracy of the division, (an operation hitherto deemed by many impossible in this country,) would not suffer in comparison with that of European artists. He cannot be too highly recommended to the patronage of the public.

Your obedient servant,

CHARLES WILKES, Jr.

Professor Silliman.

Lieutenant U. S. Navy.

Fig. 1 is a perspective view of the instrument.

Fig. 2. The horizontal circle with its alhidades, &c. &c.

Fig. 3. The vertical circle with its alhidades, &c.

Fig. 4. A section of the whole instrument.

The letters of the perspective view answer to those of the sectional parts.

*a, a, a,* are three horizontal radii of six inches radius, in the ends of which are simple levelling screws, which fit in sockets on similar radii, *á, á, á,* screwed to the top of a three legged stand, which serves as the support of the instrument in the field. *b, b,* is the horizontal or azimuth circle, of nine inches diameter, with a silver arch attached to the middle conical center, *y,* divided and read off, by means of verniers, to fifteen seconds. *c, c,* is the lower or standing alhidade, attached to the outer centre, *x,* having four arms, three bearing verniers, the fourth a clamping and tangent screw, for slow motion to the circle. *d, d,* is the upper or moving alhidade, attached to the inner conical centre, *z,* having four arms, three of which bear verniers, the fourth a clamping and tangent screw, for slow motion, on two of these arms are placed the hollow conical pillars, *e, e,* of an inch and a quarter diameter at their basis; to the top of these is fixed the *Y*'s, for the axis of the telescope, having a vertical adjustment in one of them. *f, f,* is the telescope, of twelve inches in length, with its conical hollow arms, *g, g;* the pillars, *e, e,* are of sufficient height to allow the telescope to have a free motion through the vertical; on one of the arms is fitted the vertical circle, *h, h,* of six inches diameter, with a silver arch moving on a bell metal collar, and read off by means of verniers to fifteen seconds, having two alhidades similar in every respect to the horizontal circle. *i, i,* is the inner alhidade, attached to and moving with the telescope, having four arms,

three bearing verniers, the fourth the clamping and tangent screw. *k, k*, is the outer alhidade, having also four arms, three bearing verniers, the fourth a clamping and tangent screw, for slow motion to the circle, the fourth is extended downward to a projecting piece, *m, m*, from the pillars, *e, e*, and furnished with a clamping and tangent screw, for the adjustment of the level, *l*, fixed to the outer alhidade. On the upper horizontal alhidade is placed a compass, *n, n*, for the magnetic bearings, and two small levels, *o, o*, for adjusting the instrument more readily. *p, p*, is a larger level for the adjustment of the axis of the telescope, which passes through the arms of the vertical circle and its alhidades, and rests on the axis of the telescope, as shown in fig. 4; it is removed after adjustment. An illumination is effected through one of the conical arms, *g, g*, by means of a small lamp, *r*, fastened to a support, *s, s*, that is attached to the three legged stand, by which it is detached entirely from the instrument, and of course can have no influence on its adjustments.

---

ART. VIII.—*Remarks on the characters and classification of certain American Rock Formations; by LARDNER VANUXEM, late Professor of Chemistry, &c. in the College of South Carolina, in a letter to Professor Cleaveland.\**

IN *American Geology*, there are, in my opinion, many alterations to be made, and which would have long since been made, if observers, of different schools, had examined the regions, to which my assertions have reference. The alluvial of Mr. Maclure, (as I made known in a paper left with the Academy of Nat. Sci. of Phil.) contains not only well characterized alluvion, but products of the *tertiary* and *secondary* classes. Littoral shells, similar to those of the English and Paris basins, and pelagic shells, similar to those of the chalk deposition or latest secondary, abound in it. These two kinds of shells are not mixed with each other; they occur in different earthy matter, and, in the southern states particularly, are at different levels. The incoherency or earthiness of the

---

\* To whom the communication was originally made, in reference to the forthcoming new edition of his *Mineralogy*, and it is now published by the consent both of the author and of his correspondent.

mass, and our former ignorance of the true position of the shells, have been the sources of our erroneous views.

The second error of American geology, is the extending or covering of the western country, and the back and upper parts of New York, with secondary rocks. It was taken for granted, that all horizontal rocks are secondary, and as the rocks of these parts of the United States are horizontal in their position, so they were supposed to be secondary; and as such are copied by every writer I am acquainted with. With those writers, who do not admit a transition or intermediate class, the generalization of inclination, and no inclination is admissible; but is not so, when a transition class forms a part of the system. This class, (the transition,) is formed of mechanical particles, and nothing is more certain than the tendency of such particles, when undisturbed, to form horizontal layers or masses. It is also certain that an uplifting or downfalling force, or both, have existed; but it is not certain that either or both these forces have acted in a uniform manner, giving the same or nearly the same inclination to rocks of the same age, and to every part of the same rocks. These two suppositions are to be admitted, before the characters drawn from *inclination* can be generalized, as has been done by Mr. Maclure.

Innumerable are the facts, which have fallen under my observation, which show the fallacy of adopting *inclination* for the character of a class, and the geological boundaries of the two classes in question, in the United States, abound in such facts. Those rocks are highly inclined, whose prototypes are horizontal towards the west, or otherwise removed from the mountain range. The analogy or identity of rocks I determine by their *fossils* in the first instance, and their *position* and *mineralogical characters* in the second or last instance. One observation, and then I shall terminate this part, with the facts observed in the western country and in the state of New York, which place certain rocks in a more advanced geological period, than has been ascribed or given to them. It appears from what I have been able to observe, that where the primitive or even the first transition rocks, exist as mountain or level ranges, those rocks, which are not nearer than the bituminous coal depositions resting upon them, are usually more or less inclined; but if the primitive be far removed from such rocks, no rule can be given; they may be horizontal or inclined. Also, the greater the extent

of such rocks, (old rocks with mechanical products,) and the nearer they are to the level of the ocean, the more likely they are to be horizontal. This rule is the result of observation, and of a theory, which I may, hereafter, give to the world.

In the states of Ohio, Kentucky and Tennessee, the oldest rocks, or those lowest in position, I found to be characterized by the same shells and fossils found at Trenton Falls in New York, which are similar to the shells and fossils, which characterize the transition rocks of Europe, namely, the *orthocerata*, *trilobite*, *productus spirifer*, and others of the new genera of Sowerby. To these may be added the many species of *favosi*, and the *isotelus* of De Kay, which I found in this, at Frankfort in Kentucky, and at Nashville in Tennessee. All these products I observed were below the bituminous shale; for where it commenced these products disappeared, the *encrinite* taking their place along with *terebratula*.

Above the coal shale were *terebratula*, and that species of Linnæan *madrepora* now the genus *stylena*. Those formed the characteristic of the most modern rocks I met with. It is worthy of remark, that all the *barrens* I crossed over, consisted of the rocks above the shale; and the finest lands of the three states I visited, had their soil underlaid with the rocks below the shale. In these latter, little or no siliceous particles are observable, whilst, in the rocks above the shale, they abound; they form nodules, irregular masses, &c. All the *stylena*, which are very numerous, are replaced with silex. It is to these siliceous masses, that the *barren* nature of the country is owing; for drought being frequent, and they being good conductors of heat and bad absorbers and retainers of moisture, vegetation does not find the conditions for vigorous life, as is found where they are absent.

Most of the French geologists I studied with, assigned to the transition the bituminous coal deposition, making it the last member of that class; so with those, who are governed by authority, I presume, this will have weight. With myself it is sufficient to know, that the shells and fossils mentioned, are of the same genera with the transition rocks of Europe—*our types*; that, as in our country, they abound in such rocks, and if found in more modern rocks, they occur but occasionally; that such rocks in the western country contain no coal; all the coal there, is in rocks posterior to them.



ART. IX.—*Translations and abstracts from the French*; by  
PROFESSOR GRISCOM.

1. Perchloride of Cyanogen and Cyanic acid.
2. Specific gravity as a mineralogical character.
3. Effects connected with Magnetism.
4. Effects connected with Galvanism.
5. Maximum density of water.

1. *Perchloride of Cyanogen and Cyanic Acid*.—A compound of chlorine and cyanogen, not before described, has been discovered by M. Serulas. Its formation and properties are stated in an interesting memoir read before the French Academy, on the 28th of July and 1st of Sept. 1828.

The new substance is obtained by pouring into a quart flask, full of dry chlorine, fifteen grains of pure hydro-cyanic acid, prepared by Gay Lussac's method. The flask being well corked, is exposed to the light for several days. A solid substance forms on the sides, which is to be removed, (after blowing out with a bellows the remaining gas,) by pouring in a little water and a number of fragments of glass, which, by agitation loosens the solid particles. These after being separated from the glass, are to be washed on a filter until the water no longer reddens litmus paper, nor forms a precipitate with nitrate of silver. The washed substance is then pressed and slightly warmed, between folds of blotting paper, until perfectly dry. It must next be distilled from a small retort, in the neck of which, or in the receiver, (which must be kept cold,) it crystallizes in needles of a dazzling whiteness. Its odor is so pungent as to excite tears, especially when warmed, and has some resemblance to chlorine, but its analogy to the odor of mice is very striking. It is but slightly soluble in cold water; but much more so in hot, and is then soon decomposed. Alcohol and ether dissolve it easily, and from these solutions it is separated by water. Its aqueous solution at common temperature, is slowly decomposed, and the liquid becomes acidified more and more. By ebullition, somewhat prolonged, all the perchloride disappears; there is no disengagement of gas, but a production of hydro-chloric acid, and *cyanic acid*, which in this case, must be formed of one atom of cyanogen and two atoms of oxygen.

The action of the perchloride of cyanogen on the animal economy, is very deleterious; a grain dissolved in alcohol and introduced into the esophagus of a rabbit killed it instantly. An ounce of water in which another grain had been agitated, and filtered so as to separate the greater portion which remained undissolved, killed in twenty five minutes another rabbit which had been made to swallow it. The experiments of M. Serulas, to ascertain the composition of the chloride of cyanogen, results as follows:—

Chlorine, - - - .7346=2 atoms.

Cyanogen, - - - .2654=1 atom.

*Cyanic Acid.*—This is also a new compound, evidently differing in some important particulars, from either of the two substances described as cyanic acid—the one by Wöhler who did not succeed in isolating it,—and the other by Liebig and Gay Lussac, who ascertained the existence of a cyanic acid in the fulminating compounds of mercury and silver.

M. Serulas has shown that among the most remarkable characteristic properties of perchloride of cyanogen, is that of decomposing water, and producing hydro-chloric acid and cyanic acid.

All that had been previously known of cyanic acid, would lead to the opinion that its elements possessed but little stability, and that it could exist only in combination with a base. But M. Serulas, perceiving the tendency of this acid to give rise to an acid salt, and not very soluble, inferred that in its natural state it ought to be solid, for he had long thought that no acids except those which are susceptible of becoming solid, have the property of forming fixed acid salts, such as tartrates, oxalates, phosphates, iodates, &c. This conjecture he has fully verified. The cyanic acid is solid, very white, and crystallizes in brilliant transparent rhombs, not very soluble and consequently without any very marked taste. It reddens litmus: its density is rather less than that of sulphuric acid, in which it remains suspended, but sinking when the acid is in the least diluted.

It is volatilized at a heat a little above that of boiling mercury: strongly heated a portion is decomposed, leaving only charcoal: if it is not well dried it yields ammonia and carbonic acid, in quantities proportional to the humidity it may contain.

It dissolves in both nitric and sulphuric acid, by heat, but undergoes no change of properties even if those acids are boiled down upon it. Neither nitrous nor sulphurous acid gases are disengaged, and the cyanic acid remains without the least alteration, perfectly crystallized, in plates of the purest whiteness. These are remarkable evidences of its stability.

With potassium it combines, forming potash and a cyanuret of potassium, which produces a blue color with the sulphate of iron and an acid.

It unites with bases, producing salts, some of which are perfectly characterized by their crystalline forms, and by interesting chemical properties.

It appears to have no decided effect on the animal economy.

Cyanic acid is obtained, by submitting to slight ebullition, perchloride of cyanogen in much water. As a portion goes off with the vapor of the water, before it is converted into hydro-chloric and cyanic acids, it is best to use at first a balloon with a long neck, in order to condense and throw back what may be volatilized, until the entire disappearance of the solid substance and the odor peculiar to it. The fluid, being then a mixture of hydro-chloric and cyanic acids, is to be gently evaporated in a porcelain capsule, almost to dryness, in order to expel the greater part of the hydro-chloric acid. The cyanic acid begins to crystallize at the commencement of the evaporation, in the midst of the hydro-chloric. It is to be washed on a filter, with a little cold water to remove the last portions of the hydro-chloric acid, till the washings give only a slight precipitate with nitrate of silver, soluble in nitric acid, and insoluble in ammonia, not in excess, which, on the contrary increases the precipitate. It must be redissolved in hot water, filtered and evaporated to a certain point, and on cooling the cyanic acid separates in small rhomboidal crystals, transparent and very pure.

The analysis of this substance has rigorously confirmed the composition presumed from that of the perchloride of cyanogen, which gives rise to it.

It is formed of

Cyanogen,	-	-	-	-	0.6189=1 atom,
Oxygen,	-	-	-	-	0.3811=2 atoms.

---

1.

It is evident from the preceding statement, that chlorine combined with cyanogen, exerts an action upon water analogous to that of other chlorides, iodides and bromides; that this combination is transformed, by the decomposition of water into hydro-chloric and cyanic acid; that the latter being more fixed and very stable, may be separated, by evaporation, from the other, which is very volatile.

The discovery of the perchloride of cyanogen, independently of the interest which it presents in itself, becomes more important by the discovery of cyanic acid, which results from it, since the latter creates a class of salts before unknown to chemists.

M. Serulas has combined the acid with several oxides, but as the cyanates may be numerous, he reserves them for the subject of another memoir.—*Annales de Chimie et de Physique*, Aout, 1828.

*Preservation of Hydro-cyanic Acid*, by M. Schütz.—A quantity of hydro-cyanic acid, prepared agreeably to the process of Ittner, having begun to turn yellow in the course of a month, M. Schütz rectified a part of it from calcined sulphate of zinc, and obtained a colorless acid, which preserved its qualities three years and a half: ten drops were sufficient to kill a large dog.—*Ann. de Chim. et de Phys.*

2. *Specific gravity considered as a mineralogical character*.—The statement given in treatises of mineralogy, of the specific gravity of different varieties of the same substance, shews so much discordance among these varieties, as to prevent specific gravity from being worthy of any reliance as a character. F. S. Beudant, suspecting that this difference has arisen in part, from the presence of foreign substances in the specimens examined, and partly from the want of perfect accuracy in the different persons who have described them, has taken pains to ascertain what actual agreement there is, in the specific gravity of the same substance in a pure state in its different forms.

The specific gravity of carbonate of lime, varies according to the books, from 2.324 to 3.672. M. Beudant, in limiting himself strictly to those varieties which were identical in chemical composition, so as to avoid the influence of mixtures, finds indeed in different varieties some difference of specific gravity, but far more limited in its extent than ap-

pears to have been noticed by others. Carbonate of lime rhomboidal, hexagonal and metastatique, Iceland spar, of various modifications; lamellar, saccharoidal, fibrous, compact and stalactitic spar, varied in the extremes, from 2.7041 to 2.7234. Pure arragonite, crystallized, fibrous and fibro-compact, varied from 2.9467 to 2.9053; coralloid translucent, 2.8321; opaque, 2.7647. Malachite, pure, from 3.5907 to 3.3496. Carbonate of lead, from 6.7293 to 6.7102. Sulphate of lime, from 2.3257, in small crystals, to 2.2615, nivi-form. Sulphate of strontian, from 3.9593 to 3.9297. Sulphate of lead, from 7.7593 to 7.7398. Quartz, pure, from 2.6541 to 2.6354. It results from the researches of M. Beudant, that small crystals always have the greatest specific gravity, and hence it follows that it is in small crystals we are to look for the greatest homogeneity, as well as what has been long known, the greatest perfection in form.

The lowest specific gravity is always found in the fibrous or epigene varieties. Hence it appears that the difference of specific gravity in the same substance, depends on the manner in which the rudimental crystals are aggregated to form masses more or less considerable, and M. Beudant has accordingly found that when reduced to powder, all the varieties of the same substance present what may be considered as the same absolute specific gravity, the differences being such only as come with the limits of possible errors in the operation. He therefore recommends that the absolute specific gravity of the substance be taken, as a mineralogical character, by reducing it to powder, and allowing it to imbibe the liquid which serves as a common measure.

When thus treated, the following is given as the specific gravity of the eight following substances, which is constant in all the varieties, and which may serve to distinguish them when pure.

Carbonate of lime—rhomboidal,	-	2.7231
Arragonite,	- - - - -	2.9466
Malachite,	- - - - -	3.5904
Carbonate of lead,	- - - - -	6.7290
Sulphate of lime,	- - - - -	2.3316
Sulphate of strontian,	- - - - -	2.9592
Sulphuret of lead,	- - - - -	7.7592
Quartz,	- - - - -	2.6540

*Idem.*

3. *Influence of Magnetism.*

(a) *On chemical action in general.*—The Abbe Rendu, professor of chemistry at Chamberry, communicated to M. Biot the following experiment.

A tube bent in the form of the letter V was filled with the tincture of red cabbage. An iron wire was plunged in each branch, and one of them was supported by the north pole and the other by the south pole of a horse shoe magnet. In a quarter of an hour the color of the tincture became of a beautiful green. It was the same in both branches of the tube.

The same change was effected, though in much longer time, (two days,) when the wires in two small tubes closed at the extremities, which were plunged in the liquid.

The discoloration was not the effect of a spontaneous change, for the fluid, of itself, becomes red and not green.

It was found, by Ritter, that a magnetized iron wire, combined with another not magnetized, produced a galvanic palpitation in frogs. Ritter placed a magnetized iron wire on pieces of glass, in an earthen plate, and poured over it weak nitric acid: the north pole was more rapidly attacked than the south pole, and was much sooner surrounded with a deposition of oxide.

When three small flasks were filled with water, either pure or slightly acidified, and in the first, the north pole of a magnetized wire was placed, in the second, a wire not magnetized, and in the third, the south pole of a magnetized wire; the oxidation began with the south pole, and was considerably advanced in that, and sensibly with the non magnetized wire, before it was perceived in that with the north pole. In this experiment it was necessary to cover the water with fresh oil of almonds, to prevent oxidation from the air, and to avoid all difference of exposure to solar lights. —*Annales de Chim. et de Phys. Juin, 1828.*

(b) *Effect of terrestrial magnetism on the precipitation of silver.*—A singular result with respect to terrestrial magnetism was obtained in 1817, by Prof. *Muschman* of the University of Christiana, and has since been confirmed, by Prof. *Hansteen*. A tube of the form of the letter V, about half an inch wide and four or five inches long—each branch has a quantity of clean Mercury poured into it, but not sufficient to close the communication between the two branches.

A solution of nitrate of silver, with excess of acid, is then poured in so as nearly to fill the tube. When this tube is placed in a plane, coincident with that of the magnetic meridian, the precipitation of the silver and the formation of the *arbor dianae*, is abundantly more rapid than when the tube is placed at right angles to the meridian, and it is more rapid in the north branch than in the south, and the crystals at the same time are more brilliant and more perfectly needleform.

After the crystallization had become very manifest in the north and south tube, and while little or no change had appeared in that placed east and west, two artificial magnets were placed opposite to the mercury in the latter tube, one with its north pole adjacent and the other with its south pole. The silver then began to appear in the usual manner.

To give the silver greater freedom to extend itself during precipitation, in a certain direction, small squares of glass were procured, on which were described circles with tallow; within these a solution of silver was poured, and in the center was placed a round piece of zinc. The silver immediately began to form in circular zones; but in such a manner that the circles extended much more towards the north than towards the other point of the globe. The zinc and its oxide was in this case observed to incline towards the south.

The glass plates were afterwards placed at two inches distance from the pole of a strong magnet, while others were placed at a distance beyond its influence. The effect was then striking, for on the plate near the south pole of the magnet, the silver was formed rapidly in that direction, and the entire precipitation was effected in one fourth the time of that on the plate distant from the magnet.

These results appear to demonstrate the influence of magnetism, terrestrial and artificial, on chemical action.—*Ibid.*

4. *Galvanic protection by the contact of heterogeneous metals.*—A communication of A. Van Beek, of Utrecht, in Holland to the editors of the *Annales de Chimie et de Physique*, furnishes the following remarkable examples of chemical influence.

1. I placed in a vase filled with sea water, a plate of copper: the metal was promptly oxidized, and the water acquired in a short time a deep green color.

2. A plate of copper, placed under the same circumstances, but to which I had attached a small plate of iron, tin or

zinc, was completely preserved. The copper retained its brightness, while the iron, tin or zinc were strongly oxidated.

3. A simple plate of very thin mica placed between the copper and the iron of the preceding experiment, promptly destroyed the preserving effect of the iron: the copper was oxidated.

4. A platina wire was placed so as to unite the copper and the iron, the immediate contact of which had been broken by the mica: the copper was again perfectly preserved, and not an atom of oxide of copper appeared in the fluid. This phenomenon of the preserving effect of iron, even when it is not in immediate contact with the copper, and when connected with it only by a conducting wire of another metal was perfectly demonstrated by the following experiment.

5. A plate of copper was connected by a platina wire with a plate of iron, and the plates were placed separately in two vases filled with sea water, while the fluids themselves were connected by moistened cotton or by a syphon filled with the same fluid. The copper was completely preserved—the water retaining its perfect transparency—while the iron in the other vessel was highly oxidated.

6. Having kept the apparatus as last described, in action during forty seven days, I took it into my head to cut the platina wire, in the expectation of finding the copper soon corroded, as is commonly apparent within twenty four hours after its immersion in sea water. But to my great surprise, the copper remained perfectly clean and bright, and the fluid retained its transparency. On the fourth day I interrupted the communication between the fluids by taking away the cotton: this circumstance had no influence on the preservation of the copper—it remained perfect. Imagining at first that the sea water might have lost, by the chemical action which had taken place, the power of oxidizing the copper, I took a small quantity of the fluid, and placed in it another piece of copper, which was oxidized within the first day. The water therefore had lost none of its power and the phenomenon admits of no explanation on that ground.

Neither had the copper lost the property of being oxidizable by sea water, for the same piece, placed in another vessel of sea water was quickly attacked. It would seem then that the electric preserving action which iron and sea water exert upon copper, prolonged during a certain period, produces between the elements of the copper and those of the fluid



a certain continued electric tension, which invincibly opposes the combination of oxygen with the metal, though that action is so strongly manifested on ordinary occasions.

I assured myself that a certain duration of contact of the metal is necessary to effect this state of things, for when I interrupted the contact in a similar apparatus, which had been in operation but a few days, the copper was speedily oxidated. I am engaged in new researches to ascertain the limit of time necessary to effect this preserving power, and also the limits of the preservation itself.\*

The copper of the apparatus whose contact was interrupted after forty seven days, still continues, (now more than twenty days,) perfectly preserved, and no indications of oxidation appear in the vessel.

5. *Maximum density of water.*—A series of experiments to determine the question of the probability of there being a superior current in the ocean, setting from the equator towards the poles, and an inferior current from the poles to the equator, has been made by G. A. Ermann, Jr.

This question, the author observes, depends necessarily and exclusively on the solution of another, that is whether the water of the sea, like fresh water, attains its maximum of density before it arrives at the point of congelation.

Four methods of trial were pursued.

1. By taking the specific gravity of the water at different temperatures by an excellent hydrostatic balance.

2. By Nicholson's areometer.

3. By the method of Dr. Hope, in determining the temperature of ascending and descending currents.

4. By a simple and elegant method suggested by the other, viz. the determination of the intervals of time in the cooling of the water under examination, through every successive half degree, from 15° or 20° F. above, to the freezing point.

---

\* My experiments have led me to perceive that Sir H. Davy, in the Bakerian Lecture of 1826, has committed a serious error in recommending the use of zinc or tin in the preservation of steam boilers in which sea water is used. I have found decisively, that tin, far from preserving iron, is on the contrary preserved by it. Hence a piece of tin introduced into a boiler, instead of diminishing the danger of explosion by preserving the boiler, would powerfully contribute to its destruction.

The author states, that agreeably to this last method, he placed a Reaumur's thermometer in a glass vessel full of fresh water, one inch and a half high and an inch in diameter, so that the ball was about a line from the bottom. On exposing it to a cold atmosphere, the intervals of cooling were as follows.

Temperature.	Intervals of time.
+6.6	50"
5.5	55
5.0	50
5.0	50
4.5	65
4.0	198
3.5	60
3.0	70
2.0	

The influence of a maximum density is abundantly manifest in this experiment. The sudden retardation of cooling between  $4^{\circ}$  and  $3^{\circ}$  would be inexplicable without a previous knowledge of the anomalous dilatation of water.

But in salt water the effect is different. The result of the several series of experiments is

1. That salt water, specific gravity 1.027, has no maximum density while it remains liquid; and even when ice has begun to form, the part which remains fluid, increases constantly and considerably in density.

2. Salt water at 1.020 attains no maximum density; or at least none while it is sensibly distant from the freezing temperature,  $1^{\circ}.25$ .

3. Salt water at 1.010 acquires a maximum density, but at a temperature inferior to that of the greatest quantity of fresh water, viz.  $+1^{\circ}.5$ .

It thus appears that a mixture of marine salt lowers the maximum temperature, and, in proportion to its strength, and finally causes the maximum to disappear. It is probable that it is only the maximum repelled to the point of solidification. This circumstance which is demonstrated in the metallic mixture of Rose, would probably be met with in other bodies, if their changes of volumes in the vicinity of the fusing point were carefully examined.—*Bib. Univ. Oct.* 1828.

ART. X.—A memoir on the Action of Sulphuric Acid on Alcohol, and the products which result from it. Read before the French Academy; by M. SERULLAS, on the 15th and 22d of September, 1828.

Translated and abridged by Prof. Griscom.

IN this valuable memoir, the author states that the substance called *sweet oil of wine*, results from the decomposition of the yellow liquid formed of sulphuric acid and carburetted hydrogen: a decomposition produced either by its prolonged contact with the colorless liquid which distils with it, or by the operations to which it is subjected in order to separate and dehydrate it.

M. Serullas calls this substance *neutral sulphate of carburetted hydrogen*, or, *sulphate of ether*. Although it has been seen and handled by all those who have prepared sulphuric ether, it is no less true, that its real nature remains unknown. To obtain it pure the author directs that a mixture of  $2\frac{1}{2}$  parts of sulphuric acid and 1 part of alcohol at 36 should be distilled as for the preparation of ether. After a little ether has come over, the oily liquid, more or less yellow, will make its appearance, sometimes sinking below and at others floating above another colorless liquid which comes over at the same time. In the former case, it is mixed with more sulphurous acid and less ether than the colorless liquor, and in the latter, the acid is mingled in greater quantity with the colorless liquid.

To purify it, after having separated it from the colorless liquid, it must be immediately washed by agitating it with a certain quantity of water to deprive it of sulphuric acid, a portion of alcohol, ether and sulphurous acid; then placed in a capsule under the receiver of an air pump, within which in another vessel is a portion of sulphuric acid, and the vacuum must be carefully continued until the volatilization of the sulphurous acid, ether and alcohol causes an active ebullition. When this terminates, the liquid becomes colorless and transparent, but the vacuum must be continued in order to free it from water. In the course of twenty four hours the sulphate of carbonated hydrogen is of a beautiful deep green, after having passed through the successive shades of clear green, bluish green and emerald blue.

In this state it is pure, and if kept in a closed bottle, it undergoes no alteration.

M. Serullas concludes that the green color is owing to the absence of air. It has a peculiar, penetrating, aromatic odor, a fresh, sharp taste, somewhat bitter, resembling mint; its specific gravity is 1.133; it is slightly soluble in water; alcohol and ether dissolve it easily, and from these solutions it can again be abstracted.

Placed under water, at the end of a certain time, it is transformed into a light oil, (sweet oil) which rises to the surface, and into an acid sulphate of carbonated hydrogen which remains in solution.

The light oil is opaque; left at rest it deposits crystals of the same nature as itself.

This separation of the neutral sulphate, into an acid sulphate and sweet oil, may be hastened by heating it with water. In this case a few minutes are sufficient.

The most remarkable property of this acid sulphate of carbonated hydrogen is that of being transformed by ebullition into sulphuric acid and alcohol, without any disengagement of sulphurous acid or gas of any kind.

This acid sulphate of carbonated hydrogen has been hitherto considered as a sulpho-vinic or hypo-sulphuric acid, united to some vegetable matter.

Thus, my analyses of the neutral sulphate, incline me to regard it as a double sulphate of ether and carbonated hydrogen.

When treated with bases, it abandons, as with water, the sweet oil, and forms with them, salts which have been called sulpho-vinates, but which must be considered, as Faraday and Hennell first advanced, only as salts with a double base, one of which is the carbonated hydrogen.

This oil, observed in the decomposition of sulpho-vinates, the nature of which no one has hitherto pointed out, is no other than the neutral sulphate of carbonated hydrogen, obtained in such cases in large quantity; so that I may recommend this as a method to be employed in the preparation of the neutral sulphate and consequently of the sweet oil. For this purpose, we may heat for a few moments, without distillation, equal parts of alcohol at 38° and sulphuric acid; if the mass is considerable, the elevation of temperature on mixing will be sufficient, for even in the cold we obtain a certain quantity. Saturate with clear lime water (bouillie

claire de chaux eteinte) and filter. After concentrating it a little by a gentle evaporation, cool it, filter again and allow it to evaporate in a stove. It crystallizes slowly but perfectly, and we have thus a large quantity of sulpho-vinate, very pure. This sulpho-vinate of lime, being dried with great care, and heated in a retort, the principal product collected is the neutral sulphate of carbonated hydrogen.

The sweet oil of wine obtained in the best manner, by treating the neutral sulphate of carbonated hydrogen with water and heat, is slightly yellow like olive oil, has an aromatic odor, density .921, greases paper like oils, thickens by cold without losing its transparency, and at 35° is solid. When perfectly deprived of water it is a non conductor of electricity, and may be taken as a type of non conducting oily fluids.

The author infers from his analyses that it consists of 6 parts of carbon and one of hydrogen.

The crystalline matter which separates from it has the same composition.

The inferences which M. Serullas draws from his investigation, are on the whole, as follows.

1. That in the action of sulphuric acid on alcohol, there is not formed, as has been believed, hypo-sulphuric acid, united to vegetable matter, (sulpho-vinic acid.)

2. That there is produced, on this occasion, a combination of sulphuric acid in excess, carbonated hydrogen, and elements of water in proportions which constitute ether (bi-sulphate,) which abandons successively, by ebullition the ether which it contains; consequently the sulphuric acid has taken from the alcohol, an atom of water.

3. That the bi-sulphate of ether, in the reaction observed at a later stage, in the same operation, loses the part of sulphuric acid which rendered it acid, or rather becomes saturated with carbonated hydrogen, and forms then a neutral sulphate of ether, or a double sulphate of ether and carbonated hydrogen, one part of which distils, while another is decomposed and gives rise to all the products which are known to appear at the same time.

4. That the neutral sulphate of ether, which must now be ranked among well characterised chemical compounds, and which may be assimilated with ethers of the third kind, is susceptible by its exsiccation, and remaining in a vacuum of acquiring a fine green color; that it passes by prolonged

contact with water, at common temperatures, to the state of bi-sulphate, by abandoning the portion of carbonated hydrogen which rendered it a neuter or double sulphate, which carbonated hydrogen having experienced during combination, a condensation of its elements, preserves that form, even after its separation from the compound of which it constituted a part, forming liquid carbonated hydrogen, (sweet oil of wine,) and solid crystallised carbonated hydrogen.

5. That the bi-sulphate of ether (sulpho-vinic acid,) is transformed by ebullition in water, into sulphuric acid and water, without any disengagement of gas.

6. That the compounds which the bi-sulphate of ether is susceptible of forming with bases, which in this case, replaces carbonated hydrogen, compounds which have been called sulpho-vinates, are double salts, which, also by ebullition in water, are entirely transformed into alcohol and a sulphate of the base with excess of acid.

7. That the sweet oil of wine, and the crystalline matter which it abandons by repose are formed, as M. Hennell has stated, of hydrogen and carbon in the same proportions as that in which these two bodies exist in bi-carbonated hydrogen.

8. That the sulphuric ether, from the first period of its distillation contains bi-sulphate of ether, and at a later stage, a greater or less quantity of neutral sulphate of bi-carbonated hydrogen, products which are quickly isolated by the evaporation of the ether.

9. Finally—that a means of obtaining the neutral sulphate of carbonated hydrogen, and consequently, of sweet oil of wine, is to decompose the sulpho-vinate of lime, as the most economical mode of preparation, by heating it in a retort, after having dried it, and collecting the product.—*Annales de Chim. et de Phys. Oct. 1828.*

ART. XI.—Algebraic Solution; by Mr. C. WILDER, of New Orleans.

REMARKS ON the determination of  $y$ , in  $y^n + ay^{n-1} + by^{n-2} + cy^{n-3} + dy^{n-4} \dots + ky + l = 0$ .

If we assume the function  $\frac{x^2 + S_2}{x + y}$ ,  $\frac{(A)}{(B)}$ , and then determine  $S_2$ , so that (B) may be a factor of (A), independently of  $x$ , we shall have

$$\frac{x^2 - y^2}{x + y};$$

by writing  $y + z$  for  $y$ , it is changed to

$$\frac{x^2 - y^2 - 2zy - z^2}{x + y + z},$$

which gives to (A) the form of the function

$$y^2 + ay + b = 0.$$

Now if we make (B) = 0, we shall also have (A) = 0; hence, by comparison,

$$2z = a, \quad (1),$$

$$z^2 - x^2 = b, \quad (2),$$

together with  $x + y + z = 0$ , (B), are sufficient to determine  $y$ ; for from (1) and (2),

$$x^2 = \frac{a^2 - 4b}{4};$$

and from (1) and (B),  $y = -\frac{a}{2} - x$ , which is the common rule.

In like manner, assuming the function

$$\frac{x^6 + S_3x^3 + S_6}{x^2 + yx + p}, \quad \frac{(C)}{(D)},$$

we shall have, when (D) is a factor of (C) independently of  $x$ ,

$$\frac{x^6 + (y^3 - 3py)x^3 + p^3}{x^2 + yx + p};$$

writing  $y + z$  for  $y$ , and it is changed to

$$\frac{x^6 + (y^3 + 3zy^2 + (3z^2 - 3p)y + z^3 - 3pz)x^3 + p^3}{x^2 + yx + p}.$$

Now when (D) = 0, we also have (C) = 0, and we may therefore, after dividing (C) by  $x^3$ , compare it with the equation

$$y^3 + ay^2 + by + c = 0,$$

which gives

$$3z = a, \quad (1)$$

$$3z^2 - 3p = b, \quad (2)$$

$x^3 + z^3 - 3pz + \frac{p^3}{x^3} = c$ , (3). These three equations joined to  $x^2 + (y+z)x + p = 0$ , (D), are sufficient to determine  $y$ .

For brevity make  $z=0$ , then

$$(2) \quad p = -\frac{b}{3},$$

and (2) and (3)  $x^3 = \frac{c}{2} + \sqrt{\frac{c^2}{4} + \frac{b^3}{27}} = \phi(bc)$

for then (D)  $y = -\frac{(x^2 + zx + p)}{x}$  becomes

$$y = -\frac{(x^2 + p)}{x}, \text{ which is the rule of}$$

Cardan.

So also the function  $\frac{x^6 + S_2x^4 + S_4x^2 + S_6}{x^3 + yx^2 + px + q}$ ,  $\frac{(E)}{(F)}$ , becomes, when (F) is a factor of (E) independently of  $x$ ,

$$\frac{x^6 - (y^2 - 2p)x^4 + (p^2 - 2qy)x^2 - q^2}{x^3 + yx^2 + px + q};$$

writing  $(2ny + 2z)$  for  $y$ , and  $(2n^2y^2 + 4nzy + 2z^2 - p)$  for  $p$ , and it is changed to

$$\frac{x^6 - 2px^4 + (4n^4y^4 + 16n^6zy + (24n^2z^2 - 4n^2p)y^2 + (16nz^3 - 8npz - 4nq)y + 4z^4 - 4nz^2 + p^2 - 4qz)x^2 - q^2}{(2n^2y^2 + 4nzy + 2z^2 - p)x};$$

dividing by  $4n^4x^2$ , the function (E)=0, and then comparing with

$$y^4 + ay^3 + by^2 + cy + d = 0,$$

we shall have

$$\frac{4z}{n} = a, (1)$$

$$\frac{1}{n^2}(6z^2p) = b, (2)$$

$$\frac{1}{n^3}(4z^3 - 2pz - q) = c, (3)$$

$$\frac{1}{n^4}\left(\frac{x^4}{4} - \frac{px^2}{2} + z^4 - p^2z^2 + \frac{p^2}{4} - qz - \frac{q^2}{4x^2}\right) = d, (4).$$

These equations joined to

$x^3 + (2ny + 2z)x^2 + (2n^2y^2 + 4nzy + 2z^2 - p)x + q = 0$ , (F), are sufficient to determine  $y$ . When  $z=0$  and  $n=1$ , we have  $x^6 + 2bx^4 + (b^2 - 4d)x^2 - c^2 = 0$ , which is the reduced of Des Cartes. When  $z=0$  and  $n=\frac{1}{2}$ , we have



$x^6 + \frac{b}{2}x^4 + (\frac{b^2}{16} - \frac{d}{4})x^2 - \frac{c^2}{64} = 0$ , which reduced is given in most books of algebra.

Again, let us assume  $\frac{x^{12} + S_4x^8 + S_8x^4 + S_{12}}$ , (G), which becomes, when (H) is a factor of (G) independently of  $x$ ,

$$\frac{x^{12} - (y^4 - 4py^2 + 4qy + 2p^2)x^8}{x^3 + yx^2 + px + q} + \frac{(p^4 - 4qyp^2 + 4q^2p + 2q^2y^2)x^4 - q^4}{x^3 + yx^2 + px + q}.$$

(H)=0 and of course (G)=0, we have by comparison with  $y^4 + by^2 + cy + d = 0$ , after having divided

(G) by  $x^8$   $4p + \frac{2q^2}{x^4} = -b$ , (1)

$$4q - \frac{2p^2}{x^4}q = c$$
, (2)

$$x^4 - 2p^2 + \frac{(p^4 + 4q^2p)}{x^4} - \frac{q^4}{x^8} = -d$$
, (3):

eliminating  $x^{-4}$  from (1) and (2) by the process indicated  $2p^2(1) + q(2)$ , we have  $8p^3 + 4q^2 + 2bp^2 - cq = 0$ . This equation is satisfied by making  $4p + b = 0$ , (4), and  $4q - c = 0$ , (5). The three equations, (3), (4) and (5) joined to (H), are sufficient to determine  $y$ , for from (3) we have

$x^{12} + (d - 2p^2)x^8 + (p^4 + 4q^2)x^4 - q^4 = 0$ , then we obtain by the second example,  $x^4 = \sqrt[4]{bcd}$ , and from (H),

$$y = \frac{(x^3 + px + q)}{x^2} = -\frac{(x^3 - \frac{b}{4}x + \frac{c}{4})}{x^2}$$
,

we evidently have  $(-4qyp^2 + 2q^2y^2)x^4$ , identically nothing, otherwise, there would be a relation between  $a$ ,  $b$  and  $c$ , which is not the case.

Let us write in  $\frac{(G)}{(H)}$   $2y$  for  $y$ , and  $2y^2 - p$  for  $p$ , which changes this function to

$$\frac{x^{12} + 8y^4 - 8py^2 - 8qy - 2p^2)x^8 + (16y^8 - 32py^6 - 32qy^5 + 24p^2y^4 + 32pqqy^3 + (16q^2 - 8p^3)y^2 - 8p^2qy + p^4 + 4pq^2)x^4 - q^4}{x^3 + 2yx^2 + (2y^2 - p)x + q}$$
;

and then we have, by a comparison with the function

$$y^8 + ay^6 + by^5 + cy^4 + dy^3 + ey^2 + fy + g = 0$$
,

$$2p = -a, \quad (1)$$

$$2q = b, \quad (2)$$

$$x^4 + 3p^2 = 2c, \quad (3)$$

$$2pq = d, \quad (4)$$

$$px^4 + p^3 - 2q^2 = -2e, \quad (5)$$

$$qx^4 + p^2q = -2f, \quad (6)$$

$$\frac{x^8}{16} - \frac{p^2}{8}x^4 + \frac{p^4}{16} - \frac{q^2p}{4} - \frac{q^4}{16x^4} = g, \quad (7);$$

or better,  $x^{12} - 2p^2x^8 + p^4 - 4q^2p - 16g)x^4 - q^4 = 0$ :  
eliminating  $x^4$  from (3), (5) and (7) by the process indicated,  
and we have

$$p(3) - (5) \quad p^3 + q^2 = pc + e, \quad (8)$$

$$q(3) - (6) \quad p^2q = qc + f, \quad (9)$$

$$p(6) - q(5) \quad q^3 = qe - f. \quad (10).$$

The equations (3), (9) and (10) are satisfied by making  $p^2 = c$   
and  $q^2 = e$ ,  $f$  being equal to nothing. This changes the  
given equation, by writing  $-2p$  for  $a$ , and  $-2q$  for  $-b$ , into

$$y^3 - 2py^6 - 2qy^5 + p^2y^4 + 2pqy^3 + q^2y^2 + g = 0, \text{ or better,}$$

$$y^4 - py^2 - qy + \sqrt{g} = 0:$$

which shows that the reduced is nothing but the rule of  
Des Cartes, applied to the above equation.

Since the given is parted into two factors,

$(y^4 - py^2 - qy + \sqrt{g})(y^4 - py^2 - qy - \sqrt{g}) = 0$ , the rule ap-  
plied to  $y^4 - py^2 - qy + \sqrt{g} = 0$ , gives for the reduced

(a),  $x^6 + 2px^4 + p^2x^2 - p^2 = -4\sqrt{g}$ ; changing the  
signs of the second and fourth term of the first number,  
we have (b),  $x^6 - 2px^4 + p^2x^2 + q^2 = -4\sqrt{g}$ . These two  
equations give  $x^{12} - 2p^2x^4 + (p^4 + 4pq^2)x^2 - q^4 = 16g$ ,  
which is (7). It is easily seen that we have another equa-  
tion,  $(x^4 - p^2)y^4 - py^2 - qy = (x^4 - p^2)\sqrt{g}$ , which is the  
same as the given equation.

We might have treated the function  $\frac{(G)}{(H)}$  otherwise by  
writing it thus,

$$\frac{x^{12} + (8y^4 - 8py^2 - 8qy - 2p^2)x^8}{x^3 + 2yx^2 + (2y^2 - p)x + q} +$$

$$\frac{(4y^4 - 4py^2 - 4qy + p^2)^2 - 4pq^2}{x^3 + 2yx^2 + (2y^2 - p)x + q} x^4 - q^4, \quad \frac{G}{H};$$

and when  $(G) = 0$ ,  
we have by transposition, and extracting the square root, and

making the absolute term equal to  $\sqrt{g}, y^4 - py^2 - qy + \frac{p^2}{4}$   

$$\frac{+\sqrt{4pq^2x^4 - x^{12} - (8y^4 - 8py^2 - 8qy - 2p^2)x^8 + q^4}}{4x^4} = 0 :$$

reducing  $x^{12} + (8y^4 - 8py^2 - 8qy - 2p^2)x^8 + (p^2 - 4\sqrt{g}^2 - 4q^2p)x^4 - q^4 = 0$ , but  $8y^4 - 8py^2 - 8qy = 8\sqrt{g}$ ; hence, our reduced is

$$x^{12} - (2p^2 - 8\sqrt{g})x^8 + (p^2 - 4\sqrt{g}^2 - 4q^2p)x^4 - q^4 = 0,$$

which is the product of the factors  $(a) = 0$  and  $(b) = 0$ , resulting from the transposition of  $-4\sqrt{g}$ .

From the foregoing examples, one would be led to think the method pursued here was applicable to all rational algebraic equations; but let us, before we attempt to follow the analogy, recall, and demonstrate the following propositions.

First, let 
$$\frac{x^{m(n-1)} + S_m x^{m(n-2)} + S_{2m} x^{m(n-3)} + S_{3m} x^{m(n-4)} + \dots + S_{(n-2)m} x^m + S_{(n-1)m}}{x^{n-1} + yx^{n-2} + px^{n-3} + qx^{n-4}}$$

$$\frac{\dots + S_{(n-2)m} x^m + S_{(n-1)m}}{\dots + tx + u} \quad \begin{matrix} (A') \\ (B') \end{matrix}$$

be a function in which  $x, y, p$ , etc. are independent functions of any number of other quantities whatever, then I say that  $S_m, S_{2m}, S_{3m}$ , etc. can always be determined in functions of  $y, p, q$ , etc. independently of  $x$ , so that  $(B')$  shall be a factor of  $(A')$ ; for, continue the operation indicated till the index of  $x$  in the remainder is  $n - 2$ , and then make the remainder equal to zero independently of  $x$ , which can always be done, since the whole number of unknowns,  $S_m, S_{2m}, S_{3m}$ , etc., and the whole number of equations is  $n - 1$ ; and it is evident that they are of the first degree, relative to  $S_m, S_{2m}, S_{3m}$ , etc.

It is plain that the function  $(A')$  may be decomposed into  $(n - 1)$  factors,  $(x^m + \alpha^m)(x^m + \beta^m)(x^m + \gamma^m)(x^m + \delta^m)$  etc.; and if we put

$$\begin{aligned} \alpha + \beta + \gamma + \delta, \text{ etc.} &= y \\ \alpha\beta + \alpha\gamma + \alpha\delta + \beta\gamma \text{ etc.} &= p \\ \alpha\beta\gamma + \alpha\beta\delta + \beta\gamma\delta + \alpha\gamma\delta \text{ etc.} &= q \\ \dots \dots \dots &\text{etc.} \\ \alpha\beta\gamma\delta \text{ etc.} &= u; \end{aligned}$$

then adopting the notation and formula of Lacroix *Complements des Elemens d'Algebre*, we have

$$\begin{array}{l}
 \left. \begin{array}{l} +S'1S'm-1 \\ +pSm-2 \\ +pSm-3 \\ \dots \\ +tSm-(n-2) \\ +uSm-(n-1) \end{array} \right\} x^{m(n-1)} \\
 \left. \begin{array}{l} +S'1S'm-1 \\ +p'S'm-2 \\ +q'S'm-3 \\ \dots \\ +t'S'm-(n-2) \\ +u^2S'm-(n-1) \end{array} \right\} x^{m(n-2)} \\
 \left. \begin{array}{l} +S''1S''m-1 \\ +p''S''m-2 \\ +q''S''m-3 \\ \dots \\ +t''S''m-(n-2) \\ +u^3S''m-(n-1) \end{array} \right\} x^{m(n-3)} \\
 \left. \begin{array}{l} +S1^{n-3(1)}S^{n-3(1)}m-1 \\ +p^{n-3(1)}S^{n-3(1)}m-2 \\ +q^{n-3(1)}S^{n-3(1)}m-3 \\ \dots \\ +t^{n-3(1)}S^{n-3(1)}m-n-2 \\ +u^{n-1}S^{n-3(1)}m-(n-1) \end{array} \right\} x^{m(n-4)} \dots \dots \dots \left. \begin{array}{l} + \\ + \\ + \\ \dots \\ + \\ + \\ + \\ \dots \\ + \\ + \\ + \end{array} \right\} x^{m(n-3)}
 \end{array}$$

for the general expression of (A'); the accented letters having the same relation to  $\alpha\beta + \alpha\gamma + \alpha\delta + \beta\gamma$  etc.,  $\alpha\beta\gamma + \alpha\beta\delta + \alpha\gamma\delta + \beta\gamma\delta$  etc.,  $\alpha\beta\gamma\delta + \text{etc.}$ , that S1, Sm-1, p, Sm-2, etc., have to  $\alpha + \beta + \gamma + \delta$  etc.,  $\alpha^{m-1} + \beta^{m-1} + \gamma^{m-1} + \delta^{m-1}$  etc.,  $\alpha\beta + \alpha\gamma + \alpha\delta + \beta\gamma$  etc.,  $\alpha^{m-2} + \beta^{m-2} + \gamma^{m-2} + \delta^{m-2}$  etc.

Proposition second. Let  $\phi(xypq \text{ etc.})$ , and  $\phi'(xypq \text{ etc.})$ , be two functions of the independents  $xypq \text{ etc.}$ , and let  $\phi$  be a factor of  $\phi'$ , then I say that if any function  $\phi''(xpq \text{ etc.})$ , written for  $y$  in  $\phi'$ , makes it identically nothing, it will also, when written for  $y$ , make  $\phi$  identically nothing. For if not, we shall have by putting  $y' = \phi''(xpq \text{ etc.})$ ,

$$\frac{\phi'(xy'pq \text{ etc.})}{\phi(xy'pq \text{ etc.})} = \frac{0}{\phi(xy'pq \text{ etc.})}, \text{ or nothing divisible by some-}$$

thing. And, reciprocally, if  $\phi''$  when written for  $y$  in  $\phi$ , makes it identically nothing, it will when written for  $y$  in  $\phi'$ , make it identically nothing. For if not, we shall have

$$\frac{\phi'(xy'pq \text{ etc.})}{\phi(xy'pq \text{ etc.})} = \frac{\phi'(xy'pq \text{ etc.})}{0}, \text{ or 0, a factor of } \phi', \text{ which is impossible.}$$

Proposition third. If the function  $\phi''(xpq \text{ etc.})$ , written for  $y$ , makes both  $\phi$  and  $\phi'$  identically nothing, then I say that either  $\phi$  is a factor of  $\phi'$  or  $\phi'$  is a factor of  $\phi$ , for we either have  $\frac{\phi'(xy'pq \text{ etc.})}{\phi(xy'pq \text{ etc.})} = \frac{0}{0}$  or  $\frac{\phi(xy'pq \text{ etc.})}{\phi'(xy'pq \text{ etc.})} = \frac{0}{0}$ ; and, if the division does not take place independently of  $y'$ , or what is the same,  $y$ , we shall have a relation between  $x, p, q$ , etc., which is contrary to the hypothesis. We either have therefore  $\phi(xypq \text{ etc.})$ , a factor of  $\phi'(xypq \text{ etc.})$ , or  $\phi'(xypq \text{ etc.})$ , a factor of  $\phi(xypq \text{ etc.})$ , according as  $\phi' >$  or  $<$   $\phi$ .

Proposition fourth. Let  $\varphi(xypq \text{ etc.})$  be a factor of  $\varphi'(xypq \text{ etc.}) + \varphi''(xypq \text{ etc.})$ , independently of  $x, y, p, \text{ etc.}$ ; then I say that if  $\varphi'''(xypq \text{ etc.})$  written for  $y$ , makes  $\varphi'(xypq \text{ etc.}) = 0$ , it will also make  $\varphi''(xypq \text{ etc.}) = 0$ , and  $\varphi(xypq \text{ etc.}) = 0$ ; for writing  $y' = \varphi'''(xypq \text{ etc.})$ , we shall have

$$\frac{\varphi'(xy'pq \text{ etc.}) + \varphi''(xy'pq \text{ etc.})}{\varphi(xy'pq \text{ etc.})} = q;$$

or better  $\frac{\varphi''(xy'pq \text{ etc.})}{\varphi(xy'pq \text{ etc.})} = q$ ; since therefore  $\varphi(xy'pq \text{ etc.})$  divides the whole  $\varphi'(xy'pq \text{ etc.}) + \varphi''(xy'pq \text{ etc.})$ , and the part  $\varphi''(xy'pq \text{ etc.})$ , it must also divide the remainder  $\varphi'(xy'pq \text{ etc.})$ ; consequently,  $\frac{\varphi'(xy'pq \text{ etc.})}{\varphi(xy'pq \text{ etc.})} = \frac{0}{\varphi(xy'pq \text{ etc.})}$ , and  $\varphi(xy'pq \text{ etc.}) = 0$ ; but  $\varphi(xy'pq \text{ etc.})$  is a factor of  $\varphi''(xy'pq \text{ etc.})$ , therefore,  $\varphi''(xy'pq \text{ etc.}) = 0$ .

Further, it may not be amiss to observe; that a function is equal to the continued product of all its factors; and if  $a$  is a root of  $(z^n + 1) = 0$ , different from unity, then the roots of this equation are,

$$1 \quad a \quad a^2 \quad a^3 \quad \dots \quad a^{n-1}.$$

Let us now return to the second example, and continue to denote by  $x^3, \varphi(bc)$ , we have then,

$$\begin{aligned} x &= \varphi(bc), \\ x &= a\varphi(bc), \\ x &= a^2\varphi(bc), \text{ and consequently} \\ y &= \frac{(x^2 + p)}{x}, \\ y &= \frac{(a^2x^2 + p)}{ax}, \\ y &= \frac{(a^4x^2 + p)}{a^2x}; \text{ thus } (c) \text{ admits of but} \end{aligned}$$

three simple factors.

The continued product  $(y + \frac{x^2 + p}{x}) (y + \frac{a^2x^2 + p}{ax}) (y + \frac{a^4x^2 + p}{a^2x})$  ought to reproduce  $(c)$ ; and accordingly we have

$$y^3 + \left\{ \begin{array}{l} \frac{(a^2x^4 + px^2(1 + a^2) + p^2)}{ax^2} \\ \frac{a^4x^4 + px^2(1 + a^4) + p^2}{a^2x^2} \\ \frac{a^6x^4 + px^2(a^2 + a^4) + p^2}{a^3x^2} \end{array} \right\} y + \frac{x^6 + p^3}{x^3} = (\text{by having})$$

regard to 1  $a$   $a^2$ .) to  $y^3 - 3py + x^3 + \frac{p^3}{x^2}$ , the function we parted from.

We may further observe the function,

$$x^6 - \frac{S_2^3}{4} + S_6$$

becomes, when the

$$\left(x^3 - \frac{S_3}{2}\right)^{\frac{2}{3}} + (y+z) \left(x^3 - \frac{S_3}{2}\right)^{\frac{1}{3}} + p$$

denominator is a factor of the numerator, independently of  $x$ ,

$$x^6 - \frac{(y^3 + 3zy^2 + (3z^2 - 3p)y + z^3 - 3pz)^2}{4}$$

$$\frac{(x^3 - \frac{y^3 + 3zy^2 + (3z^2 - 3p)y + z^3 - 3pz}{4})^{\frac{2}{3}} + (y+z)(x^3 - \frac{y^3 + 3zy^2 + (3z^2 - 3p)y + z^3 - 3pz}{4})^{\frac{1}{3}} + p}{z^3 - 3pz} + p^3$$

$$\frac{3zy^2 + (3z^2 - 3p)y + z^3 - 3pz}{2} \Big)^{\frac{1}{3}} + p$$

hence, when  $z=0$ , we have the following equations,

$$3p = -b,$$

$$(x^6 + p^3)^{\frac{1}{2}} = c,$$

$$(x^3 - c)^{\frac{2}{3}} + y(x^3 - c)^{\frac{1}{3}} + p = 0; \text{ from which } y \text{ is known.}$$

The function  $\frac{(y^2 + py + q)^3 - x^3}{y^3 + ay + b}$ , is also proper to reduce cubics; for if we make

$$\frac{(y^2 + py + q)^3 - x^3}{y^3 + ay + b} = y^3 + Ay^2 + By + C, \text{ and determine } A,$$

$B$ , and  $C$ , so that the denominator is a factor of the numerator, we shall have,

$$A = 3p,$$

$$B + a = 3q + 3p^2,$$

$$C + Aa + b = 6pq + q^3,$$

$$Ba + Ab = 3q^2 + 3p^2q,$$

$$Ca + Bb = 3pq^2,$$

$$Cb = q^3 + x^2; \quad \text{or}$$

$$\begin{aligned} A &= 3p, \quad (1), \\ B &= 3q + 3p^2 - a, \quad (2), \\ C &= 6pq + p^3 - 3ap, \quad (3), \\ 3aq + 3p^2a - a^2 + 3pb &= 3q^2 + 3p^2q, \quad (4), \\ 6apq + p^3a - 3pa^2 - 2ab + 3bq + 3p^2b &= 3pq^2, \quad (5) \\ x^3 + q^3 &= 6pqb - 3pab - b^2, \quad (6). \end{aligned}$$

If we multiply (4) by  $p$ , and subtract it from (5), we shall have  $(3q - 2a)p^3 + (3q - 2a)ap + (3q - 2a)b = 0$ . This equation is satisfied by making  $3q = 2a$ .

Writing  $\frac{2}{3}a$  for  $q$ , in (4) and (6), and we have,

$$\begin{aligned} ap^2 + 3bp - \frac{a^2}{3} &= 0; \text{ and} \\ x^3 = bp^3 + abp - b^2 - \frac{8a^3}{27}; \end{aligned}$$

we have  $y$ ; for when  $y^3 + ay + b = 0$ , we have  $y^2 + py + q - x^3 = 0$ ; and we have already  $p$ ,  $q$  and  $x$ , in functions  $a$  and  $b$ . This is the rule of Tschirnaus. We may still vary the calculation, by assuming the function,

$$\frac{(\alpha^3 + a^2 + (a+p)\alpha + b + q + x)(\beta^3 + \beta^2 + (a+p)\beta + b + q + x) \times (\gamma^3 + \gamma^2 + (a+p)\gamma + b + q + x)}{y^3 + ay + b};$$

for, making the coefficients of  $x$  and  $x^2$ , equal to nothing, and eliminating the symmetrical function  $\alpha + \beta + \gamma$ ,  $\alpha^2 + \beta^2 + \gamma^2$ , etc. by means of  $a$  and  $b$ , we obtain,

$$\begin{aligned} 3q &= 2a, \\ ap^2 + 3bp - \frac{a^2}{3} &= 0, \text{ and} \\ x^3 = bp^3 + abp - b^2 - \frac{8a^3}{27}; \end{aligned}$$

now, if we make  $y^3 + ay + b = 0$ , we also have  $y^2 + py + q = 0$ , from whence  $y$  is known,  $y$  standing for one of the letters  $\alpha$ ,  $\beta$ , or  $\gamma$ .

Let us next recall the function,

$$\frac{x^{12} - (y^4 - 4py^2 + 4py + 2p^2)x^8 + (p^4 - 4qyp^2 + 4q^2p + 2q^2y^2)x^4 + q^4}{x^3 + yx^2 + px + q};$$

$$\frac{2q^2y^2x^4 + q^4}{(H)}; \quad (G)$$

here, writing  $y' = -\frac{x^3 + px + q}{x^2}$  for  $y$  in (G), we have

$$y'^4 - 4py'^2 + 4qy' + 2p^2 - \frac{(p^4 - 4qy'p^2 + 4q^2p + 2q^2y'^2) + \frac{q^4}{x^3} - x^4}{x^4} = 0.$$

And since  $p, q$  and  $x$  are independent, we may make any three hypotheses we choose; accordingly, comparing

$$y'^4 - 4py'^2 + 4qy' + 2p^2 - \frac{p^4 + 4q^2p}{x^4} + \frac{q^4}{x^3} - x^4, \text{ with}$$

a function  $y'^4 + by'^2 + cy' + d = 0$ ,  $y'$  being the same in both functions, we have  $4p = -b$

$$4q = c \text{ and}$$

$$x^{12}(d - 2p^2)x^8 + (p^4 + 4q^2p)x^4 - q^4 = 0,$$

the same as obtained before.

The fourth proposition gives the same result, perhaps more satisfactorily. Continuing to denote by  $x$  the function  $\varphi(bcd)$ , we shall then have,

$$y' = -\frac{(x^3 + px + q)}{x^2},$$

$$y' = -\frac{(a^3x^3 + apx + q)}{a^2x^2},$$

$$y' = -\frac{(a^6x^3 + a^2px + q)}{a^4x^2},$$

$$y' = -\frac{(a^9x^3 + a^3px + q)}{a^6x^2}; \text{ let us transpose the}$$

second members, and it requires no great skill to see that the continued product of the four factors will be,

$$y'^4 - 4py'^2 + 4qy' + 2p^2 - \frac{(p^4 - 4qy'p^2 + 4q^2p + 2q^2y'^2)}{x^4}$$

+  $\frac{q^4}{x^3} - x^4 = 0$ ; but by the hypothesis,

$$y'^4 - 4py' + 4qy' + 2p^2 - \frac{(p^4 + 4q^2p)}{x^4} + \frac{q^4}{x^3} - x^4 = 0, \text{ conse-}$$

quently,  $\frac{-4qy'p^2 + 2q^2y'^2}{x^4} = 0$ ; hence, the product of the four factors is  $y'^4 + by'^2 + cy' + d = 0$ .

Let us now take  $y^5 + by^3 + cy^2 + dy + e = 0$ , for the given equation. Here  $n = 5$ , and if we make  $m = 5$ , the function  $\frac{(A')}{(B')}$  will be proper to resolve this equation.



It would be useless to repeat the calculation by which we have determined the functions,  $S_5, S_{10}, S_{10}$ ; it is sufficient to say that  $(A')$  will be,

$$\begin{array}{r}
 +y^5 \\
 -5py^3 \\
 +5qy^2 \\
 x^{20} + 5py \\
 -5ry \\
 -5pq
 \end{array}
 \left. \vphantom{\begin{array}{r} +y^5 \\ -5py^3 \\ +5qy^2 \\ x^{20} + 5py \\ -5ry \\ -5pq \end{array}} \right\} x^{15}
 \begin{array}{r}
 +5p^5 \\
 -5qyp^3 \\
 +5ry^2p^2 \\
 -5rp^3 \\
 +5q^2p^2 \\
 -5q^2y^2p \\
 -5qry^3 \\
 -5q^3y \\
 +5p^2y^2 \\
 -10r^2p \\
 +5q^3r
 \end{array}
 \left. \vphantom{\begin{array}{r} +5p^5 \\ -5qyp^3 \\ +5ry^2p^2 \\ -5rp^3 \\ +5q^2p^2 \\ -5q^2y^2p \\ -5qry^3 \\ -5q^3y \\ +5p^2y^2 \\ -10r^2p \\ +5q^3r \end{array}} \right\} x^{10}
 \begin{array}{r}
 +p^5 \\
 -5prq^3 \\
 +5r^2yq^2 \\
 -5p^2r^2q \\
 -5r^3q \\
 -5pr^3y
 \end{array}
 \left. \vphantom{\begin{array}{r} +p^5 \\ -5prq^3 \\ +5r^2yq^2 \\ -5p^2r^2q \\ -5r^3q \\ -5pr^3y \end{array}} \right\} x^5 + p^5;$$

and  $B', x^4 + yx^3 + px^2 + qx + r$ .

Let us now suppose that such a function  $\phi(xpqr)$  is written for  $y$ , as renders  $x^{20}(y^5 - 5py^3 + 5qy^2 + 5p^2y - 5ry - 5pq)x^{15} + (p^5 - 5rp^3 + 5q^2p^2 - 10r^2p + 5q^2r)x^{10} + (q^5 - 5prq^3 + 5p^2r^2q - 5r^3q)x^5 + r^5 = 0$ , we may then compare it with  $y^5 + by^3 + cy^2 + dy + e = 0$ , after dividing the first equation by  $x^{15}$ ; this done we have,

$$5p = -b, \quad (1),$$

$$5q = c, \quad (2),$$

$$5p^2 - 5r = d, \quad (3),$$

$$x^5 - 5pq + \frac{(p^5 - 5rp^3 + 5q^2p^2 - 10r^2p - 5q^2r) + r^5}{x^5} +$$

$$\frac{(q^5 - 5prq^3 + 5p^2r^2q - 5r^3q)}{x^{10}} + \frac{r^5}{x^{15}} = e, \quad (4),$$

or better,

$$x^{20} - (e + 5pq)x^{15} + (p^5 - 5rp^3 + 5q^2p^2 - 10r^2p - 5q^2r)x^{10} + (q^5 - 5prq^3 + 5p^2r^2q - 5r^3q)x^5 + q^5 = 0.$$

These four equations, joined to  $y + \frac{(x^4 + px^2 + qx + r)}{x^3} = 0$ ,

are sufficient to determine  $y$ .

It is very evident, that it is a matter of indifference, which of the letters  $y, p, q$ , or  $r$ , we treat as the unknown; for they are all of five dimensions in the function before us.

This remark is applicable to other cases; as, for example, the function  $\frac{(C)}{(D)}$ , which is  $\frac{x^6 + (y^3 - 3py)x^3 + p^3}{x^2 + yx + p}$ ; here, ma-

king (D)=0, then (C)=0; treating  $p$  as unknown, and comparing with  $p^3+bp+c=0$ ; we have

$$3x^3y = -b, \quad (1),$$

$$x^6 + x^3y^3 = c, \quad (2),$$

$$p = -(x^2 + yx), \quad (D).$$

From (1) and (2) we have  $x^{12} - cx^6 - \frac{b^3}{27} = 0$ ;

from (1) then  $y = -\frac{b}{3x^3}$ ; these two equations joined to (D), determine  $p$ .

Let us take for the last example

$$y^6 + by^4 + cy^3 + dy^2 + ey + f = 0.$$

There are several functions, resulting from different values of  $m$ , equally proper to resolve this equation. The one, in which the function is most easily calculated, is that in which  $m=2$ . Our function is then,

$$\frac{x^{10} + S_2x^8 + S_4x^6 + S_6x^4 + S_8x^2 + S_{10}}{x^5 + yx^4 + px^3 + qx^2 + rx + s}, \quad \begin{matrix} (A') \\ (B') \end{matrix}$$

Calculating  $S_2, S_4$ , etc., and afterwards writing  $\frac{y^2-p}{2}$  for  $p$ , and  $\frac{y^3-3py-2q}{6}$  for  $q$ , we shall have,

$$x^{10} - px^3 + 8qy \left. \begin{matrix} -y^4 \\ +6py^2 \\ +3p^2 \\ +24r \end{matrix} \right\} \frac{1}{24} x^6 + 36ry^2 \left. \begin{matrix} -y^6 \\ +6py^4 \\ +4qy^3 \\ -9p^2y^2 \\ -12pqqy \\ -72sy \\ -4q^2 \\ -3pr \end{matrix} \right\} \frac{1}{36} x^4 + 3psy \left. \begin{matrix} +r^2 \\ +sy^3 \\ +2qs \end{matrix} \right\} \frac{1}{3} x^2 - s^2 (A')$$

$$x^5 + yx^4 - \frac{(y^2-p)}{2} x^3 + \frac{(y^3-3py-2q)}{6} x^2 + rx + s \quad (B')$$

Now, if we make (B')=0, (A') will also be equal to nothing; and the five independents  $x, p, r, q$ , and  $s$ , allowing as many separate hypotheses; we therefore make  $y$ , being the same in (A'), and  $y^6 + by^4 + cy^3 + dy^2 + ey + f = 0$ ,

$$6p = -b, \quad (1),$$

$$4q = -c, \quad (2),$$

$$9p^2 - 36r = d, \quad (3),$$

$$12pq + 72s = e, \quad (4),$$

$$x^{10} - px^3 + \frac{1}{4}(p^2 + 8r)x^6 - \frac{1}{9}(288f + q^2 + 9pr)x^4 -$$

$$\frac{1}{3}(r^2 + 2qs)x^2 - s^2 = 0, \quad (5).$$

These five equations, joined to (B')=0, are sufficient to determine  $y$ .

We evidently have, at the same time,

$$\frac{1}{6}(3py^2 + 4qy)x^6 + \frac{1}{3}(sy^3 + 3psy)x^4 = 0;$$

or better,

$$(3py + 4q)x^2 + 2sy^2 + 6ps = 0, \text{ an identical equation.}$$

ART. XII.—*Solution of a Problem in Fluxions; by Prof. THEODORE STRONG.*

TO PROFESSOR SILLIMAN.

New Brunswick, June 8, 1829.

*Dear Sir*—Should you consider the following solution of a well known problem of sufficient importance, you will oblige me by giving it a place in the Journal.

*Problem.*—Supposing that a particle of matter, projected from a given point, in a given direction, with a given velocity, is deflected from its rectilinear course into a curve line; It is required to determine the equations of its motion.

*Solution.*—Let its motion be defined by the three rectangular axes ( $x, y, z$ )  $x = r. \cos. \theta \cos. v, y = r. \cos. \theta \sin. v, z = r. \sin. \theta, \therefore r^2 = x^2 + y^2 + z^2$  (1),  $\frac{y}{x} = \tan. v$  (2),  $\frac{x}{z} = \cos. v$

$\cot. \theta$  (3),  $\frac{y}{z} = \sin. v \cot. \theta$  (4). Let  $t$  denote the time, (or the independent quantity, which varies as the time, increasing by equal elements  $dt$ , in equal elements of the time.)

The question requires that  $x, y, z, r, \theta, v$ , be found in terms of  $t$ , and constants, (which are to be determined from the initial circumstances of the motion,) in other words,  $x,$

$y, \&c.$  are to be considered as functions of  $t$ . Put  $X = -\frac{d^2x}{dt^2}$ ,

$$Y = -\frac{d^2y}{dt^2}, \quad Z = -\frac{d^2z}{dt^2}, \quad (a); \quad \frac{xd^2x + yd^2y + zd^2z}{r \times dt^2} = -F, \quad (b);$$

$$d\left(\frac{xdy - ydx}{dt}\right) = F', \quad (c); \quad \cos. v \times d\left(\frac{zdx - xdz}{dt}\right) + \sin. v$$

$$\times d\left(\frac{zdy - ydz}{dt}\right) = -F'' \quad (d); \quad s = \text{the portion of the curve de-}$$

scribed, (in the time  $t$ ), its concavity being supposed to be turned towards the origin of the co-ordinates; it is evident that  $r$  = the distance of the particle from the origin of  $(x, y, z)$ ; let  $d\phi$  = the elementary angle contained by  $r$  and  $r + dr$ ; then  $rd\phi$  and  $dr$  are the legs of a right angled triangle, whose hypotenuse is  $ds$ ;  $\therefore ds^2 - dr^2 = r^2d\phi^2$ , (e); but  $rd\phi$  is the hypotenuse of another right angled triangle, whose legs are  $r \cos. \theta dv$  and  $rd\theta$   $\therefore r^2d\phi^2 = r^2 \cos.^2 \theta dv^2 + r^2d\theta^2$ , (f). The second differential of (1) relatively to  $t$ , (considering  $dt$  as constant,) gives

$$\frac{dr^2 + rd^2r}{dt^2} = \frac{dx^2 + dy^2 + dz^2}{dt^2} + \frac{xd^2x + yd^2y + zd^2z}{dt^2}, \quad (g);$$

but it is evident that  $dx^2 + dy^2 + dz^2 = ds^2$ ,  $\therefore$  by substitution in (g) of  $ds^2$  and by (b), I have  $\frac{dr^2 + rd^2r}{dt^2} = \frac{ds^2}{dt^2} - rF$ ,

or  $\frac{rd^2r}{dt^2} = \frac{ds^2 - dr^2}{dt^2} - rF$ , or by (e) and (f) I have

$$\frac{r \cos.^2 \theta dv^2 + rd\theta^2 - d^2r}{dt^2} = F, \quad (A).$$

Multiply the differential of (z), (taken relatively to  $t$ ), by  $x^2$ , and I have  $\frac{r^2 \cos.^2 \theta dv}{dt} = \frac{xdy - ydx}{dt}$ , the differential of this gives  $d\left(\frac{r^2 \cos.^2 \theta dv}{dt}\right)$

$$= d\left(\frac{xdy - ydx}{dt}\right) = F', \quad (B), \text{ by (c).}$$

Multiply the differen-

tials of (3) and (y), by  $z^2$ , and there results  $\frac{zdx - xdz}{dt} = \frac{(r^2 \cos. v d\theta + r^2 \sin. v \cos. \theta \sin. \theta dv) zdy - ydz}{dt} = \frac{r^2 \sin. v d\theta}{dt}$

$$+ \frac{r^2 \cos. v \cos. \theta \sin. \theta}{dt};$$

multiply the differential of the first of

these by  $\cos. v$ , and that of the second by  $\sin. v$ , then add the products, and by (d) I have  $d\left(\frac{r^2 d\theta}{dt}\right) + \frac{r^2 \cos.\theta \sin.\theta dv^2}{dt^2} = F''$

(C). The equations (A), (B), (C), are those which I purposed to find. The solution of the question is now reduced to the integral calculus, and the integrals of (A), (B), (C), manifestly depend on the values of  $-\frac{d^2x}{dt^2}$ ,  $-\frac{d^2y}{dt^2}$ ,  $-\frac{d^2z}{dt^2}$ , or their equals, X, Y, Z, which are involved in F, F', F'', as given by (b), (c), (d), respectively. The quantities  $-\frac{d^2x}{dt^2}$ ,

$-\frac{d^2y}{dt^2}$ ,  $-\frac{d^2z}{dt^2}$ , are supposed to be given at the commencement of the motion, or at some determinate point of the described curve, and to vary according to some given law; by which means their general forms of expression (or X, Y, Z) become known. In the language of dynamics, X, Y, Z, are the forces which cause the changes  $-\frac{d^2x}{dt^2}$ ,  $-\frac{d^2y}{dt^2}$ ,  $-\frac{d^2z}{dt^2}$ ,

in the velocities of the particle  $\frac{dx}{dt}$ ,  $\frac{dy}{dt}$ ,  $\frac{dz}{dt}$ , in the direction of

the axes  $x, y, z$ , respectively in an assumed unit of time, (as (1) second for instance in terms of which  $t$  is supposed to be given; that is, if the unit is (1) second,  $t$  denotes seconds.) Also, F, as given by (b) is the expression which would result by decomposing X, Y, Z, in the direction of  $r$ , by the usual rules of decomposing forces, and F', F'', respectively denote the changes caused by the action of the forces (in the assumed unit of time) in the areas described by the orthographic projection of  $r$  on the plane of  $(x, y)$ , and by the motion of  $r$  in a direction perpendicular to the plane of  $(x, y)$ ; in other words, F' is the moment of the forces which act upon the particle decomposed in the direction of the plane  $(x, y)$ , and F'' is their moment decomposed in the direction of a plane passing through  $r$ , at right angles to the plane  $(x, y)$ . The equations (A), (B), (C), are the same as the equations (H); given by Laplace at page 149 of the *Mec. Cel.* they become much simplified when the conditions of the question are such that the motion of the particle is always in the same plane; for supposing  $(x, y)$  to denote the plane, I have  $z=0$ ,  $\therefore \theta=0$ , and the equation (C) does

not exist; also (A) becomes  $\frac{rdv^2 - d^2r}{dt^2} = F$ , (A'), and (B) becomes  $d\left(\frac{r^2dv}{dt}\right) = F'$ , (B'). These results can readily be

found from the equations  $r^2 = x^2 + y^2$ . . .  $\frac{y}{x} = \tan. v$ , by the same method as before. Again, if  $F' = 0$ , I have  $r^2dv = c'dt$  (G), ( $c' = \text{const.}$ ), hence  $dv^2 = \frac{c'^2 dt^2}{r^4}$ ; substitute this in (A'), and there results  $\frac{c'^2}{r^3} - \frac{d^2r}{dt^2} = F$  (D), multiply by  $dr$ , and integrate relatively to  $r$ , and reduce, and there results  $dt = \frac{rdr}{\sqrt{-c'^2 - 2r^2SF}dr}$ , but  $c'dt = r^2dv$ ,  $\therefore dv = r\sqrt{\frac{c'dr}{-c'^2 - 2r^2SF}dr}$  (E), which agrees with Laplace's result, (Mec. Cel. Vol. I. p. 113,) and is the same as that of Newton, (Principia, Vol. I. sec. viii. prop. 41.)

The equation (D) may be put under the form  $\frac{c'^2}{r^3} - d\left(\frac{dr^2}{dt^2}\right) = F$ , substitute for  $dt^2$  its value  $\frac{r^4dv^2}{c'^2}$ , and it

becomes  $\frac{c'^2}{r^3} - \frac{c'^2}{2} d\left(\frac{dr^2}{r^4dv^2}\right) = F$  (H), which agrees with

(4) of Laplace, at the place before cited; (H) can also be put under the form  $\frac{c'^2}{r^3} - \frac{c'^2}{2} d\left(\frac{\cot.^2\psi}{r^2}\right) = F$  (I), ( $\psi$  being the

angle at which the radius vector  $r$  cuts the curve and  $\frac{dr}{rdv}$  its cotangent. By substituting in (A') for  $dt^2$  its value as

given by (G), I have  $\frac{rdv^2 - d^2r}{\left(\frac{r^2dv}{c'}\right)^2} = F$  (K), or  $F$  varies as  $\frac{rdv^2 - d^2r}{r^4dv^2}$ , (since for a given centre of force in a given curve,  $c'$ , is constant) which agrees with Newton's result, (Prin. 1st, sec. second, prop. 6. cor. 1st. his QR being the

same as  $\frac{rdv^2 - d^2r}{2}$ , and  $SP^2 \times QT^2 = r^4 dv^2$ .) The use of the equation (E) is to determine the curve when the force F is given, and it is obvious that it requires F to be a function of  $r$ , since it involves the integral  $SFdr$ ; also (H), (K), and (I), are for the purpose of determining the law of force for a given point in a given curve; either will answer, but that one ought to be used which will accomplish the object most expeditiously. It appears to me, however, that (I) will generally be found to be quite as easy in practice as either of them: an example of this may be given in the case of the logarithmic spiral, the centre of force being at the centre of the spiral; in this case  $\psi$  is invariable; since  $r$  always cuts the curve at the same angle,  $\therefore$  by (I)  $\frac{c'^2 \operatorname{cosec}^2 \psi}{r^3} = F$ ,

$\therefore F$  varies as  $\frac{1}{r^3}$  for different points of the curve, (which agrees with prop. 9th, sec. second, Prin.), if  $\psi =$  a right angle, the cosec.  $\psi = 1$ , and the spiral becomes a circle, and  $\frac{c'^2}{r^3} = F = \text{const.}$  for the same circle, and for different circles substituting for  $c'^2$  its value  $\frac{dv^2 r^4}{dt^2}$ , it becomes

$$\left( \frac{dv^2 r^2}{dt^2} \right) = \frac{V^2}{r} = F, \text{ by putting } \frac{rdv}{dt} = V = \text{the velocity, (which}$$

agrees with Prin. sec. second, prop. 4th, cor. 1st.) Again, by taking the finite difference of (D), relatively to  $c'^2$  and  $F$ , regarding  $r$  and  $\frac{d^2r}{dt^2}$  as constant, I have  $\frac{Dc'^2}{r^3} = DF$ , (D being the characteristic of finite differences,) if  $Dc'^2$  is considered as constant,  $DF$  varies as  $\frac{1}{r^3}$  (which in prop. 44th, sec. 9th, Prin.) I shall here leave the subject, as I suppose I have said enough and perhaps too much already.

CORRECTIONS.

Page 284, 6th line from bottom, dele (z) and insert (2).  
 " " 3d " " " (y) " " (4).  
 " " bottom line, insert  $dv$  after  $\sin. \theta$  in numerator thus,  $\sin. \theta dv$ .  
 Some smaller corrections, not deemed important, have been omitted.—Ed.

Meteorological Table, &c.

ART. XIII.—*Meteorological Table, with Remarks; by Gen. MARTIN FIELD.*

PROF. SILLIMAN—*Dear Sir*—I send you the following Meteorological Table, extracted from a Meteorological Journal of observations, made at Fayetteville, Vt. from the 30th day of April, 1828, to the 1st day of May, 1829, in lat. 42° 58' North, and long. 4° 20' East from Washington.

I am Sir, yours respectfully.  
MARTIN FIELD.

1828 and 1829.	THERMOMETER.										WEATHER.						MISCELLANEOUS.																			
	Mean temperature at sunrise.	Mean temperature at 2 o'clock, P. M.	Mean temperature at 9 o'clock, P. M.	Aggregate of mean temperature each month.	Day.	Hour.	Maximum of temperature.	Highest degree.	Day.	Hour.	Minimum of temperature.	Lowest degree.	Range of Thermometer.	Fair.	Cloudy.	Rainy.	Snow and hail.	N.	N. E.	E.	S. E.	S.	S. W.	W.	N. W.	Inches of water in rain, snow and hail in day time.	Inches of water in rain, snow and hail at night.	Aggregate of water each month.	Inches of snow and hail.	Lightning and Thunder, No. of days.	Aurora Borealis.					
May,	47° 5'	66° 5'	54° 9'	56° 3'	17	3 P. M.	75	8	4 A. M.	32	43°	20	11	6	2	7	1	2	7	1	2	7	4	5	3	3	8	6	4	2	7	8	1			
June,	59° 8'	75° 7'	66° 1'	67° 2'	27	2 "	90	2	4 "	42	48	18	12	12	1	2	1	2	3	2	4	3	5	3	5	3	3	3	1	0	4	3	11			
July,	60° 3'	75° 8'	64° 6'	66° 9'	23	2 "	86	12	4 "	52	34	11	20	20	1	2	1	2	5	10	10	2	6	7	5	0	11	7	5	0	11	7	18			
Aug.	60° 3'	80° 8'	66° 0'	69° 3'	26	1 "	90	21	5 "	50	40	25	6	4	1	2	2	2	9	6	9	2	2	6	4	8	7	3	10	7	—	7	3			
Sept.	54° 3'	69° 3'	57° 6'	60° 4'	12	2 "	88	30	6 "	42	46	15	15	5	2	7	2	1	4	5	3	6	3	4	7	3	10	7	—	—	—	3	3			
Oct.	37° 1'	57° 2'	41° 7'	45° 3'	9	1 "	75	20	6 "	15	60	24	7	4	1	3	4	1	5	11	14	—	6	1	9	2	5	—	—	—	1	1	1			
Nov.	32° 5'	42° 4'	34° 7'	36° 5'	5	2 "	66	15	7 "	18	48	16	14	7	2	1	3	4	3	7	5	7	4	4	5	3	9	7	10	—	—	—	1	1		
Dec.	27° 2'	36° 0'	29° 0'	30° 7'	9	2 "	52	31	7 "	0	52	22	9	3	—	—	—	—	4	12	7	8	—	—	—	—	—	—	—	—	—	—	—	—	1	
Jan.	10° 3'	24° 0'	12° 0'	15° 4'	7	1 "	51	11	7 "	-22	73	13	15	1	3	7	4	1	2	4	12	6	3	4	5	0	8	4	32	—	—	—	—	—	—	
Feb.	5° 2'	24° 3'	11° 1'	13° 5'	25	2 "	32	5	6 "	-18	50	19	9	—	5	5	3	1	2	4	12	6	3	4	5	0	8	4	32	—	—	—	—	—	—	
March	20° 4'	34° 0'	26° 5'	27° 0'	4	3 "	60	3	6 "	5	55	20	11	2	3	3	3	1	4	4	16	1	4	4	16	1	5	3	0	15	—	—	—	—	—	
April,	36° 0'	51° 0'	40° 0'	42° 3'	23	2 "	75	5	5 "	27	48	20	10	3	2	3	4	2	3	2	8	6	2	8	6	2	5	1	8	4	3	5	—	—	—	—
ag.tem.	37° 6'	53° 1'	42° 0'	44° 2'			Recapitulation.					226	189	67	15	27	37	9	12	35	68	63	94	32	7	40	6	73	3	100	45	10				



REMARKS.

From the foregoing table, it appears, that the mean temperature of the last twelve months was 44.2, which was about 1° colder than the twelve months preceding. The temperature of the summer months was - - 67.8  
 winter do. - - - 19.9

Difference, - - - 47.9

That August was 2° warmer than the other summer months, and February about 2° colder than the other winter months. That March was 3° colder than December, and June warmer than July. The highest temperature was 90°, and was the same on the 27th day of June, and on the 26th day of August. The lowest temperature was on the 11th of January, and was 22° below zero. But it fell below zero eighteen nights within the months of January and February. We had lightning and thunder on forty five days; Aurora Borealis was seen on ten evenings only.

The quantity of water which fell in rain, hail and snow, was 73.3 inches, which is believed to be beyond a parallel in the recollection of any man living. The whole quantity of snow was 100 inches, which is only 3 inches more than fell in the winter of 1826—7.

On the 2d, 3d and 4th days of Sept, there fell 9.7 inches of rain, which produced a most destructive freshet, throughout Vermont and New Hampshire, the ravages of which will probably be visible for half a century.

For many years, since I have resided in Vermont, I have been of opinion, that much more water falls annually in rain, hail and snow, upon the Green Mountains, than in most other parts of the United States; and from three years' accurate observation, I am confirmed in the belief. In the winter months it is a common occurrence that there are storms upon the mountains, when ten or fifteen inches of snow fall, and at the same time, only a few miles distant, at the foot of the mountains, on the west side, they have very little or no storm of any kind. So in the summer, the clouds are often seen to accumulate over the mountains, and there exhaust themselves, in violent showers, and their extension is limited to a few miles.

It appears by Dr. Hildreth's observations, made at Marietta, Ohio, for three years past, (published in the Journal of  
 Vol. XVI.—No. 2. 10

Science, Vol. xvi, No 1,) that the whole quantity of rain which fell, within that time, was 132.6 inches ; and from my observations made in Vermont, for the last three years, the quantity of water, which has fallen is 189.9 inches—difference, 57.3 inches. I believe, however, so great a difference would not be found by a long series of observations, made at both places, for the seasons have been unusually humid in Vermont, during the three years above mentioned.

From thirty years' observation, I am confident that lightning, thunder, and hail, in summer, are far less severe in the mountainous region of Vermont, than in level champaigne districts, situated in the same degrees of latitude. The elevated peaks, probably, serve as conductors, which convey the electricity from the clouds without shocks ; and almost universally, when the lightning strikes the earth, it occurs in vallies, or on the sides of mountains, far below their highest points.

In conclusion, I would remark, that notwithstanding the great quantity of rain, which fell during the last summer, in Vermont, some of our crops were abundant. The grass and hay crop, perhaps were never better. Indian corn, potatoes and some garden vegetables were light. Spring wheat, rye and oats suffered severely by blight.

Fayetteville, Vt. May 1, 1829.

ART. XIV.—*Speculations with respect to the cause of the Aurora Borealis or Northern Lights.*

VARIOUS have been the attempts to account for this phenomenon ; as yet no satisfactory theory has been offered to the public, most of the essays on the subject, being destitute of a sufficient number of facts on which to erect any lasting hypothesis.

If the positions herein taken as 'true, are, as they are believed to be, founded on admitted facts, some progress will, perhaps, have been made in explanation of a subject hitherto so obscure. The first question that presents itself is, what is the *immediate* cause of the Aurora Borealis ?

It seems to have been generally conceded, that electricity in some form, is the immediate cause of this phenomenon. The extreme rapidity with which the Aurora climbs and over-spreads the heavens, assimilates it in this appearance, to no other substance known to us but electricity.

At some remarkable periods when it has assumed its most terrific forms, something strongly resembling the electric chain of the thunder cloud has been observed: If we add to these facts, the late discoveries of the French philosophers, of the effects of those lights on the magnetic needle, there can be little doubt as to the nature of the agent that produces the northern lights. The next question; How comes there to be such an accumulation of electricity toward the northern pole, and by what means does it ascend to produce the alleged effect—is an enquiry of vastly more difficult solution, and on the correct and clear explanation of the causes producing these effects, depends the whole of this hypothesis.

Before I proceed farther in developing the theory, I would remark, that the different kinds of minerals, although found combined with others, in various forms, and scattered by the convulsions of nature, over the whole globe, still abound (whether agreeably to some established law, I will not pretend to decide,) in particular regions, and are in a great measure absent from other regions. For instance, gold, silver, platinum and quick silver, although found in other zones, are particularly abundant in the tropical regions; copper, lead and tin occupy the latitudes next north; iron, (except meteoric,) is the native product of the northern regions. In the further discussion of this subject, I shall assume as historically true, the following mineralogical facts. First, that south of the equator, there are not to be found any considerable masses of iron under any form; our knowledge as to the mineralogy of a portion of those regions, is admitted to be extremely limited. So far as those regions on this continent have been explored by Humboldt and other modern travellers, no masses of this mineral have been discovered, nor as far as our knowledge extends, have we any reason to believe, that any such masses are to be found on the eastern continent. The next fact assumed is, that no great masses of iron, are to be found within  $32^{\circ}$  north of the equator; that near that point the iron region commences and continues northerly as far as the land continues, towards the north pole, the greatest accumulation being between the 45th and 65th degrees of north latitude. As to all purposes of this discussion; this iron region may be considered, as a world by itself, and the centre of electrical attraction, in other words, the theory is this, that the electric fluid is gradually drawn off from the clouds and incumbent atmosphere by the peaks of

the high mountains, and the iron region generally. The power of iron gradually and noiselessly to disarm the clouds, is strikingly exemplified by the following simple experiment, Take and insulate an iron rod through the roof of your house; bring it down to your chamber, and when the thunder storm comes within two miles of the rod, sparks of electricity may be drawn from the rod; connect the rod by a chain with the ground and the effect ceases, as the fluid passes imperceptibly to the earth. Now if such are the extensive effects of a small rod in disarming the clouds and atmosphere of the electric fluid, what must be the effect of those immense masses of iron, situated in those northern regions, in gradually drawing down the same fluid? This hypothesis derives support from the following well known facts, to wit; that south of the equator, the thunder storms are much more frequent and terrific than north of the line, particularly within the iron regions. This remarkable fact cannot be so well and satisfactorily accounted for, as upon this hypothesis of the accumulation of the electric fluid south of the equator, until seeking an equilibrium natural to all fluids, it bursts forth in torrents to the land and to the water; whereas at the north and within the specified region, it is gradually drawn off without noise or struggle. A point of much difficulty still remains to be discussed, to wit, what causes the electric fluid to ascend near the pole; and what is the medium of conveyance? And here I must assume another fact, if that indeed can be called an assumption, that is proved by the strongest evidence that can be produced, except by absolute and perfect knowledge or demonstration, to wit, that around the north pole there is an open sea, at all seasons of the year. Without citing authors by name, I refer to all the accounts published, as well by those who have sailed on scientific voyages of discovery, as to the accounts of those who have been employed in the whale fishery. And more particularly to the latter, who have penetrated still farther to the north than any scientific expedition. This fact being taken as historically true, the theory is as follows. The electric fluid, seeking an equilibrium, spreads itself by attraction in all directions from the centre of the iron regions, but of course most in that direction where most attracted, which is northerly, until it reaches the open sea near the pole where it rises in the vapor that constantly ascends from the water in that region. That electricity ascends as well as descends,

is demonstrable, *a priori*, and is proved by an abundance of historical facts. That vapor is a powerful conductor, is proved by the multitude of cases of persons struck standing at doors and windows at the approach of a thunder gust. The mist thus ascending, rises to the upper regions of the atmosphere, and then spreads itself, accompanied by the electric fluid, which causes those wonderful displays that baffle description, and exceed the power of imagination. It is not incumbent on me, but foreign to my subject, to explain what becomes of that portion of electricity that goes southerly; but it is not irrational to conjecture, that it may be one of the causes that produce those extensive earthquakes, that have traversed the ocean and have been felt in different parts of the globe. This theory also accounts for, and derives strength from the fact of the detachment of those immense masses of ice from the polar regions; no philosophical reason or adequate cause, has been or can be assigned, for this singular and wonderful fact except electricity. No other cause that we are acquainted with, is sufficiently powerful to separate those frost bound masses and set them afloat. It is a well known fact, that those floating continents of ice are much larger, at some periods, than at others; and that they have greatly increased within the period that the northern lights have been observed to increase, is certainly true; but to decide whether the former have followed so soon as to be coupled as cause and effect, requires a knowledge of facts beyond my observation and research. Many facts in confirmation of these views, might indeed be added, but they would introduce other subjects vastly more important, which I am not prepared now to discuss: and perhaps enough has been offered to determine whether the discussion is worth pursuing. S.

Whitesborough, Oneida county, N. Y. Feb. 16, 1829.

---

ART. XV.—*Chemical Instruments and Operations*; by ROBERT HARE, M. D. Professor of Chemistry in the University of Pennsylvania.

*A modification of the process for ascertaining the specific gravity of the gases.*

The principal difficulty in weighing the gases accurately, arises from the small proportion which the weight of any

gas, can have, to that of any receiver, capable of sustaining the unbalanced atmospheric pressure, consequent to exhaustion. It has been already mentioned that the accession of weight, produced in an exhausted glass globe by filling it with hydrogen, cannot be ascertained by an ordinary balance. This led me to adopt another mode of manipulation, which I shall proceed to describe and explain.

The weight of a bladder is exactly the same, however large or small the quantity of atmospheric air which it may include, provided the air which may be within it, be under no greater compression, than that without. Hence, if by means of a volumeter, we introduce a known quantity of any other gas, one hundred cubic inches for instance, whatever the bladder gains or loses in weight, will be the difference between the weight of the gas introduced, and that of a like volume of air. If the gas be lighter, we must deduct the weight necessary to restore the equilibrium from 30.5 grains, which is the weight of one hundred cubic inches of air. The remainder will be the weight of one hundred cubic inches of the gas. A varnished silk bag might be preferable to a bladder.

The accuracy of this process may always be subjected to trial, by ascertaining whether the weight of the bag or bladder employed, is the same when nearly void, as when containing a volume of atmospheric air, equal to the volume of gas, which it is intended to weigh. When a bladder is used, it must be dry; as otherwise the loss of moisture, during the experiment, may influence the result.

It must be evident that this process is predicated upon the idea, that the gravity of atmospheric air, has been already determined with a sufficient degree of accuracy.

As there is no method by which a bag, or bladder, can be exhausted of air, so that a portion will not remain between its folds; neither nitric oxide, nor phosphuretted hydrogen could be weighed, by the process last mentioned, unless the residual air were previously washed out by the gas to be weighed, by hydrogen, or some other gas with which they exercise no chemical reaction. A portion of nitric oxide might be introduced, and then expelled as a mean of getting rid of oxygen.

*Another process suggested.*

I will take this opportunity of suggesting, that the comparative gravities of the gases might be found, by means of two bodies, counterpoised, as represented in the accompanying cut, by ascertaining the rarefaction or condensation of each gas, which would make the bodies equiponderate in it, as if it were atmospheric air. In that case, the smaller body should be of platina, which of all bodies is the heaviest in proportion to its bulk; and the larger should be of glass, as thin as would be competent to sustain the requisite changes of pressure; since I know of no body, equally firm, and impervious, which would be as light in proportion to its bulk. The changes of density being effected by the air-pump or condenser, might be measured by means of a barometer gage.

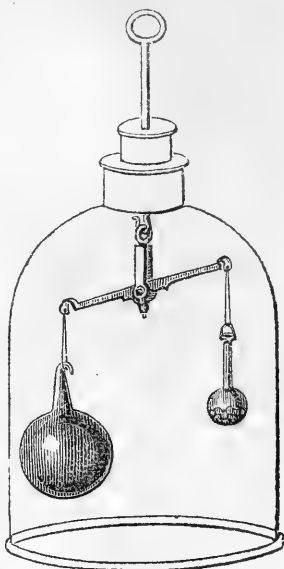
*Protoxide of nitrogen or nitrous oxide.*

This substance does not exist in nature. When artificially obtained, it is gaseous; yet the experiments of Mr. Faraday have taught us that under great pressure, it may be converted into a liquid.

*Means of obtaining nitrous oxide.*

It may be obtained by the action of dilute nitric acid upon zinc: by exposing nitric oxide gas to iron filings, sulphites, or other substances, attractive of oxygen. It is best procured by exposing nitrate of ammonia to heat, and receiving the product in an apparatus described in the following article.

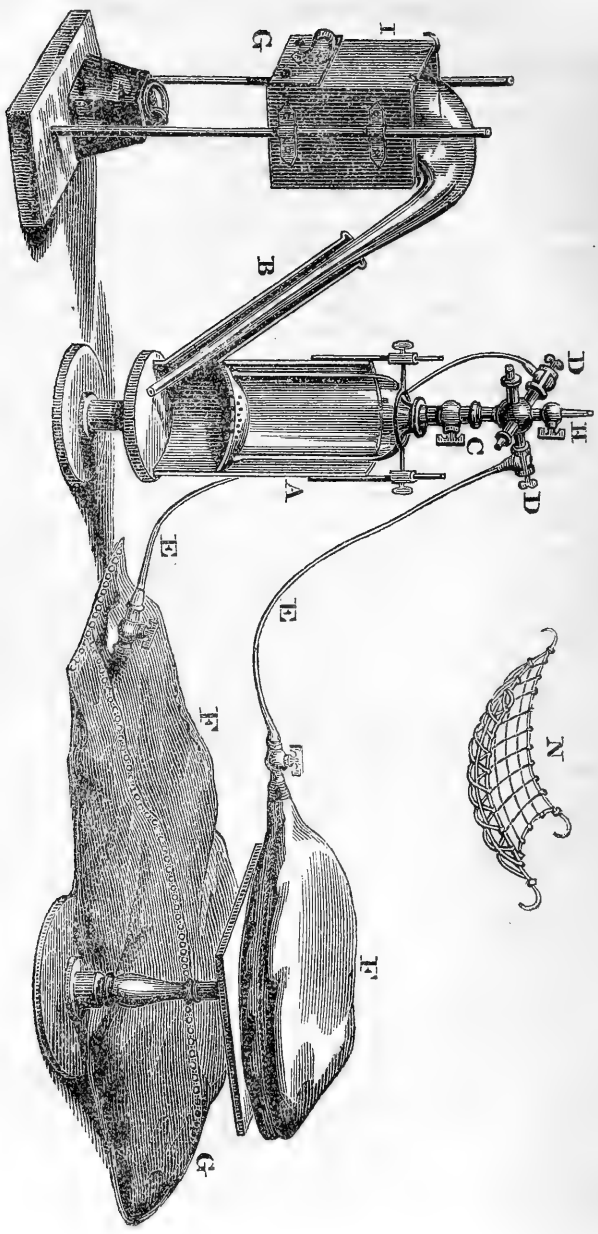



*Apparatus for evolving and preserving nitrous oxide gas.*

A, represents a copper vessel of about eighteen inches in height, and nine inches in diameter, which is represented as being divided longitudinally in order to show the inside. The pipe, B, proceeds from it obliquely, as nearly from the bottom as possible.

Above that part of the cylinder from which the pipe proceeds, there is a diaphragm of copper, perforated like a culender. A bell glass is surmounted by a brass cock, C, supporting a tube and hollow ball, from which proceed on opposite sides, two pipes terminating in gallow screws, D D, for the attachment of perforated brass knobs, soldered to flexible leaden pipes communicating severally with leathern bags, F F. The larger bag, is capable of holding about fifty gallons, the smaller one, about fifteen gallons.

The beak of the retort must be long enough to enter the cylinder so that the gas in passing from the mouth of the beak, may rise under, and be caught by the diaphragm. This is so hollowed as to cause it to pass through the perforations already mentioned, which are all comprised within a circle, less in diameter than the bell glass. The gas is, by these means, made to enter the bell glass, and is, previously to its entrance, sufficiently in contact with water, to be cleansed from the acid vapor which usually accompanies it. On account of this vapor, the employment of a small quantity of water to wash the gas, is absolutely necessary; and for the same reason, it is requisite to have the beak of the retort so long, as to convey the gas into the water, without touching the metal; otherwise, the acid vapor will soon corrode the copper of the pipe, B, so as to enable the gas to escape. But while a small quantity of water is necessary, a large quantity is productive of waste, as it absorbs its own bulk of the gas. On this account, I contrived this apparatus, in preference to using gasometers or air holders, which require larger quantities of water.

The seams of the bags are closed by means of rivets, agreeably to the plan of Messrs. Sellers & Pennock for fire hose. The furnace is so contrived, that the coals, being situated in a drawer, G, may be partially, or wholly removed, in an instant. Hence the operator is enabled, without difficulty, to regulate the duration or the degree of the heat. This control over the fire, is especially desirable in decom-

posing the nitrate of ammonia, as the action otherwise may suddenly become so violent, as to burst the retort. The iron netting, represented at N, is suspended within the furnace, so as to support the glass retort, for which purpose it is well qualified. The first portions of gas which pass over, consisting of the air previously in the retort, are to be allowed to escape through the cock, H. As soon as the nitrous oxide is evolved, it may be detected by allowing a jet from this cock, to act upon the flame of a taper.

To obtain good nitrous oxide gas, it is not necessary that the nitrate of ammonia should be crystallized; nor does the presence of a minute quantity of muriatic acid, interfere with the result. I have employed advantageously in the production of this gas, the concrete mass formed by saturating strong nitric acid, with carbonate of ammonia.

The saturation may be effected in a retort, and the decomposition accomplished by exposing the compound thus formed, to heat, without further preparation.

*Rationale.*—*Of the production of nitrous oxide, by the destructive distillation of nitrate of ammonia.*

Nitrate of ammonia, consists of nitric acid and ammonia. Nitric acid consists of five atoms of oxygen, and one of nitrogen; ammonia, of one atom of nitrogen, with three atoms of hydrogen. In all five atoms of oxygen, three of hydrogen, and two of nitrogen are present, in one atom of the salt. It must be evident, that if, in consequence of the heat, each atom of hydrogen takes one of oxygen, there will be but one atom of oxygen left for each atom of nitrogen. Hence, the whole of the salt is resolved into water, and protoxide of nitrogen, or nitrous oxide.

*Properties and composition of nitrous oxide.*

It is a permanent gas. One hundred cubic inches weigh about fifty grains. It supports the combustion of a candle flame vividly; though nitric oxide gas, containing twice as much oxygen, does not. Phosphorus is difficult to inflame in it, but burns with rapidity, when once on fire. The habitudes of sulphur are, in this respect, analogous to those of phosphorus. An iron wire burns in it nearly as well as in oxygen gas. Nitrous oxide may be exploded with hydrogen, forming water, and sometimes nitric acid. It has no attri-

bute of acidity. It stimulates and then destroys life. Its effects on the human system are analogous to a transient, peculiar, various, and generally very vivacious ebriety. It is much more rapidly and extensively soluble in water, than oxygen.

Mr. Faraday has shown that nitrous oxide may be liquefied under great pressure. When nitrate of ammonia was heated at one end of a sealed recurved tube, nitrous oxide was condensed into a liquid at the other end.

One volume, or one atom of nitrogen =	-	1.75
And half a volume, or one atom of oxygen =	-	1.
Condensed into one volume, constitute one atom of		
nitrous oxide, equivalent to	- - -	2.75

ART. XVI.—*Argillite, embracing Anthracite Coal*; by Prof. AMOS EATON.

TO PROF. SILLIMAN.

ADDITIONAL geological surveys, having been directed by Mr. Van Rensselaer, the regular course of the report, commenced in your Journal, will be interrupted for a few months. In the mean time, I hope that a few isolated facts may not be unacceptable.\*

I shall not, at present, discuss the question whether we have a primitive and a transition argillite, or a transition argillite only; but shall briefly state a few facts now established by careful observation.

The glazed or japan-varnished variety of argillite, extends from Baker's Falls, near Sandy Hill, Washington county, N. Y. to the Highlands, on Hudson river, a distance of one hundred and forty miles. Throughout its whole extent, it embraces in small quantities, anthracite coal, passing into a mixture of anthracite and plumbago. Talc and argillite are

\* The Hon. Stephen Van Rensselaer, of Albany, N. Y. well known for his munificent contributions in aid of science, has directed Prof. Eaton, aided by Mr. Courtland Van Rensselaer, to extend the geological principles developed by the Erie Canal survey, to all parts of the state of New York, and the adjoining parts of New England, New Jersey and Pennsylvania. These gentlemen have already commenced a course of examinations, for obtaining the necessary materials for completing the work. The result of their labors may be expected in this Journal in due time.—*Editor.*

also often intermixed, and grains of quartz frequently enclosed. The anthracite is always between the layers of argillite, and these layers are considerably inclined, dipping at their south eastern edges. On traversing these layers in a south easterly direction, they are found to pass into talcose slate, sooner or later—generally at the distance of about twenty miles from the Hudson. In some localities of the glazed argillite, on the banks of the Hudson, we find remains of bivalve, moluscous animals and chambered univalves, which are in some cases, intermixed with the anthracite. Troy and Waterford, in N. Y. afford the best localities yet discovered. No beds of anthracite have hitherto been discovered in the argillite on the Hudson, of sufficient extent to promise a reasonable reward to the miner.

Between two and four miles west of Bellow's falls, on the Connecticut river, in the town of Rockingham, Vt., there is also a north and south range of argillite. The position of its layers, is perfectly vertical; and it passes into talcose slate at its eastern side. But it has not yet been thoroughly examined, and no anthracite has been found in it, in the state of Vermont. Its extent north and south, is not precisely known; but it has been traced about one hundred miles. Anthracite has been found near Hadley falls, in Southampton, Mass. which may have some connection with it. This last range is nearly parallel to the first, at the average distance of forty miles, east of it, in a straight line.

Another range of argillite, in all its characters, precisely like that along the Hudson, runs in a direction parallel to the other two, about forty miles east of the last mentioned; but the dip of its edges, is in the contrary direction. It passes on through Worcester in Mass., two miles east of the village, to Providence in R. I., exactly under Brown college; and probably dipping under the waters of the Narraganset, passes through the island of Rhode Island, on which Newport is situated. Its northern extent is not ascertained. Like the two other ranges, it passes into talcose slate every where on the eastern side. Like the Connecticut river range, its breadth is very limited. Larger beds of anthracite have been discovered in this range than in either of the others. One bed is now wrought in Worcester, which is five feet wide, sixty feet deep, and five hundred feet long. About one hundred and sixty tons of anthracite coal have been already taken from it. It often contains asbestos, plumbago, and grains

of quartz. A well has been sunk into it at Providence, but nothing is yet known of its extent there. At Newport, large quantities of anthracite have been taken from the same range, and the beds are still extensively wrought.

A fourth range of argillite crosses the stage road at Cambridge, about three miles west of Boston, Mass. It is about forty miles east of the Worcester range. Its extent north and south has not been ascertained. I believe no anthracite has yet been discovered in it, but as it agrees with the other three ranges in all its characters, it is probable that it contains anthracite.

It is a remarkable fact that these four ranges of argillite, are nearly parallel to each other, and about equidistant, leaving the intervals occupied with primitive rocks of very similar character. Granite, hornblende rock, and talco-micaeous rocks, are present in all the intervening ranges. Granular limestone and quartz, occur in some, and mica slate in others.

Having myself made an examination of all the localities to which I have referred, I speak from personal knowledge; excepting as to quantities of coals taken from the beds, and as to a few other facts, for which, it will be seen, that I must rely upon information given by others. In these cases, I was particular to collect unquestionable testimony. William N. Greene, Esq. of Worcester, was with us, at that bed, on the 2d of June, and gave me the information which I could not obtain from inspection.

Finally, I am willing to stand pledged to the scientific public, for the foregoing statement of facts. I am thus particular, because it appears to me that here are facts enough to answer the great question—*Have we such a rock as primitive argillite?*

AMOS EATON.

June 9, 1829.

## ART. XVII.—Telescopes—Life of Fraunhofer.

### REMARK.

THE subjoined extracts from a letter to the editor, written by Dr. B. Lynde Oliver, dated May 21, containing important information, appear worthy of publication, and we subjoin the memoir of the life of Fraunhofer, mentioned by Dr. Oliver, being willing that an article of such high interest should be made more extensively known in this country.

*Letter from Dr. Oliver.*

TO THE EDITOR.

*Dear Sir*—I have recently been favored with an answer to a letter which I had addressed to that eminent artist Lerebours, of Paris,\* which makes me regret that Yale College should have sent to London for an achromatic telescope.† Nothing can more fully evince the great superiority of the telescopes of Lerebours, than this consideration, that while the English thirty inch telescope has an aperture of two inches diameter, and magnifies seventy five or eighty times; the best thirty two inch achromatic of the above eminent artist, has an aperture of four inches, and magnifies three hundred times.‡ The reported excellence of his instruments does not rest on the artist's word, but on the report of a committee of the National Institute, composed of M. Arago and several other astronomers of the first rank among the philosophers in Europe. The telescope made for the Royal Observatory of Paris, had an aperture of nine inches, and cost three thousand dollars. He has made one since of nine inches aperture, and which magnifies from nine hundred to a thousand times, according as the atmosphere is more or less favorable for the application of a great power. You will recollect that Fraunhofer's great telescope made for the observatory of Dorpat, magnified with its greatest power, only seven hundred times. M. Lerebours informs me that he is now engaged in making a telescope of twelve inches aperture, which he expects to finish this year. M. Tully wrote to me, that a disc of flint glass of seven inches diameter was out of the question, as a piece of glass of this size could not be obtained either at Paris or Munich, since the death of Guinand senior. But I am informed by Lerebours, that the glass-house in which he is interested, in company with the son of Guinand, now make discs of twelve and fourteen inches in diameter. There are also, two very good artists besides, that make good flint-glass for telescopes.

---

\* Dated Paris, Dec. 12, 1828.

† Dr. Oliver alludes to a telescope presented to Yale College, by a private individual, of whom more particular mention may be made when the instrument arrives, which we trust will shortly be the fact, and we indulge the hope that it may prove that the British artist, Mr. Dollond, is not far behind his continental brethren.—*Editor.*

‡ The price of such an instrument is eight hundred dollars, and several of them are placed in the Royal observatory of Paris.

I hope to see a specimen of Lerebours' telescopes, as a person belonging to Salem, has, by my advice, sent out for one that will cost two hundred dollars; this is the price of a small instrument, but still it will show the skill of the artist. An eminent philosopher in Great Britain, in a letter to me, remarks, that the continental achromatic telescopes surpass them all; [the different telescopes lately made in England,] and he rebukes the negligence of the British government. I wrote to Europe, with the special view of obtaining information which might be useful to all our scientific institutions. But it was so long before it arrived, that I do not wonder your college should have engaged an English artist; although I am now sorry for it. You have, sir, no doubt, read the beautiful memoir of the life of Fraunhofer, published in Brewster's Journal, 1827, page 1. How feelingly the writer expresses himself on the death of this truly great and eminent artist and philosopher, and how indignant he seems to be at the neglect of the English government to Dollond, the inventor of the achromatic telescope.

Permit me sir, to inquire of you, if you have repeated the experiments of the French chemists on the making of diamonds? \* It is a very remarkable circumstance that the diamond, should unite a very high *refractive* with a low *dispersive* power. I do not recollect any other instance of it.

*Rapport du Jury Central Exposition, 1823.*

M. Lerebours, opticien, à Paris, place du Pont-Neuf, qui reçut en 1819 une médaille d'or, a exposé plusieurs instruments d'optique qui sont tous très dignes de la réputation dont il jouit dans le monde savant. Deux de ses lunettes, dont une a neuf pouces et demi d'ouverture, ont fixé l'attention du jury. Rien de plus parfait n'est certainement sorti des ateliers d'aucun opticien.

Le jury décerne une nouvelle médaille d'or à M. Lerebours.

---

\* The materials mentioned by the French chemists, namely, sulphuret of carbon and phosphorus, were placed in contact as soon as the facts were announced, in February, but, as it requires the greater part of a year to produce the result, it cannot be expected as yet. It is said that the phosphorus operates by detaching the sulphur from the sulphuret of carbon, and that thus the carbon is gradually made to crystallize, so as to produce diamond, in small masses, but transparent and hard, so that the Paris jewellers have pronounced them to be identical with the natural diamonds.—*Editor*.

Since this note was written, we observe that this reputed discovery is disputed by some of the most eminent of the French chemists.

*Life of Fraunhofer—from Dr. Brewster's Journal, No. XIII.*

Of all the losses which science is occasionally called to sustain, there is none which she so deeply deploras as that of an original and inventive genius, cut off in the maturity of intellect, and in the blaze of reputation. There is an epoch in the career of a man of genuine talent when he embellishes and extends every subject over which he throws the mantle of his genius. Imbued with the spirit of original research, and familiar with the processes of invention and discovery, his mind teems with new ideas, which spring up around him in rapid and profuse succession. Inventions incompleted,\* ideas undeveloped, and speculations immatured,\* amuse and occupy the intervals of elaborate inquiry, and he often sees before him, in dim array, a long train of discoveries which time and health alone are necessary to realize. The blight of early genius that has put forth its buds of promise, or the stroke which severs from us the hoary sage when he has ceased to instruct and adorn his generation, are events which are felt with a moderated grief, and throughout a narrow range of sympathy; but the blow which strikes down the man of genius in his prime, and in the very heart of his gigantic conceptions, is felt with all the bitterness of sorrow, and is propagated far beyond the circle on which it falls. When a pillar is torn from the temple of science, it must needs convulse the whole of its fabric, and draw the voice of sorrow from its inmost recesses. To those who have not studied the writings, or used the instruments of the illustrious subject of this memoir, these observations may seem extravagant and inapplicable; but there is not a philosopher in Europe who will not acknowledge their truth, as well as their application; and there is not a practical astronomer within its widest boundaries, that has not felt the tide of grief for the loss of Fraunhofer flowing within his own circle.

Joseph Fraunhofer was born at Straubing, in Bavaria, on the 6th March, 1787. His occupations in the workshop of his father prevented him from giving a regular attendance at the public schools. At the early age of eleven he was deprived of both his parents, and the person to whose charge he was entrusted destined him for the profession of a turner; but his weak frame being ill suited to such an occupation,

---

\* These are the words in the Edinburgh Journal.



he was apprenticed to M. Weichselberger, manufacturer and polisher of glass at Munich. Being too poor to pay any thing to his master, he was taken on the condition that he should work for him six years without any wages.

At Munich Fraunhofer frequented the Sunday school, but as his attendance was irregular, it was a long time before he learned to write or to count. In 1801, in the second year of his apprenticeship, an accidental circumstance gave a new turn to his fortune. Two houses having tumbled down suddenly, Fraunhofer, who lived in one of them, was buried under its ruins; but while others perished, he fortunately occupied a position to which it was considered practicable to open a passage. While this excavation was going on, the King Maximilian often came to the spot to encourage the workmen and the young prisoner; and it was not till after a labor of four hours that they were able to extricate him from his perilous situation. His majesty gave directions that his wounds should be carefully attended to, and as soon as he had recovered, he was sent for to the palace to give an account of the peculiarities of his situation during the accident, and of the feelings with which he was actuated. On this occasion his sovereign presented him with eighteen ducats, and promised to befriend him in case of need.

Mr. Counsellor Utzschneider, afterwards his partner in the great optical establishment at Benedictbauern, took him also under his protection, and occasionally saw him. Fraunhofer, full of joy, showed him the king's present, and communicated to him his plans, and the way in which he proposed to spend the money. He ordered a machine to be made for polishing glass, and he employed himself on Sundays in grinding and finishing optical lenses. He was, however, often baffled in his schemes, as he had no theoretical and mathematical knowledge. In this situation M. Utzschneider gave him the mathematical treatises of Klemm and Tenger, and pointed out to him several books on optics. Fraunhofer soon saw, that, without some knowledge of pure mathematics, it was difficult to make great progress in optics, and he therefore made them one of the branches of his studies.

When his master saw him occupied with books, he prohibited him from using them, and other persons whom he consulted did not encourage him to undertake the study of mathematics and optics without assistance, and at a time when he was scarcely able to write. These obstructions, how-

ever, served only to redouble the efforts of our author ; and though he had no window in his sleeping chamber, and was prohibited from using a light, yet he acquired a considerable knowledge of mathematics and optics, and endeavored to apply them to his own schemes.

In order to obtain more leisure, he employed the remainder of the royal present in buying up the last six months of his apprenticeship ; and that he might gain some money for his optical experiments, he engraved visiting cards without ever having been taught the art of engraving. Unfortunately, however, the war which then desolated Europe put an end to the sale of his cards, and left him in greater exigencies than before.

Notwithstanding the kind assurances of protection which the king had given him, Fraunhofer had not courage to request it, and he was therefore compelled to devote himself to the grinding and polishing of glasses, still continuing to devote his Sundays to the study of the mathematics.

Mr. Utzschneider was at this time seldom at Munich, and could do nothing for our young artist ; but he recommended him to a professor of the name of Schiegg, well versed in mathematics and natural philosophy, who paid frequent visits to Fraunhofer.

About this time was formed the celebrated establishment at Benedictbauern, near Munich, by MM. Reichenbach, Utzschneider, and Liebherr, and in August 1804, they began the manufacture of optical and mathematical instruments, which were divided by the new machine of Reichenbach and Liebherr. The whole of the apparatus was made there excepting the lenses, for they could not procure good crown and flint glass, and wanted also a skilful optician. With this great defect, the establishment would certainly have failed, unless they had endeavored to supply it.

Mr. Utzschneider now undertook a journey to make inquiry respecting crown and flint glass, and respecting a skilful working optician ; but, after all his labors, he was convinced that the new establishment had no alternative but to form an optician within its own bosom. Through Captain Grouner of Berne, he had heard of the labors of Louis M. Guinand, an optician at Brenetz, in Neuchâtel, and having received from him some specimens of his flint glass, he was so pleased with them that he paid a visit to Brenetz, and engaged Guinand to accompany him to Munich. As soon as he arrived there, which was in

1805, M. Utzschneider constructed furnaces for carrying on the experiments upon a well organized plan. The first attempt created much expense, on account of the repeated experiments which it required, but it nevertheless furnished several good pieces of both kinds of glass. The optician, Riggl, polished the first lenses in 1806 and 1807. At this period Fraunhofer found himself in a very critical situation. Professor Schiegg always encouraged him to go to M. Utzschneider, but Fraunhofer was long in resolving to do this, believing that the latter had forgotten him, and knowing that he was well satisfied with his own optician.

M. Utzschneider received Fraunhofer in a very friendly manner, and after a short conversation, it was agreed that he should also become an optician in the establishment. Fraunhofer was then employed to calculate and polish lenses of considerable dimensions which came from the furnaces of Benedictbauern. These lenses were destined for the instruments of the observatory of Buda. It was afterwards agreed to transfer all the optical part of the establishment to Benedictbauern, and to give the complete direction of it to Fraunhofer. Our philosopher had already studied catoptrics, and had even written a Memoir on the aberration which takes place without the axis in reflecting telescopes. He showed that hyperbolic mirrors are preferable to parabolic ones, and he also communicated the invention of a machine for polishing hyperbolic surfaces. He now, however, resolved to give up this branch of the subject, as his time was fully occupied in the preparation of lenses.

One of the most difficult problems in practical optics is to give to spherical surfaces the last polish with that degree of exactness which theory requires, because this final operation destroys in part that form which had been previously given to the surfaces. M. Fraunhofer succeeded in remedying this evil by a machine which not only did not injure the fine surface obtained by grinding, but which actually corrected the irregularities committed in the first operation. It has also the advantage of making the result independent of the skill of the workman.

In examining the glass which he used in reference to the undulations and striæ which it contains, he found that, in the flint glass manufactured at Benedictbauern, there was often not a single piece free of those irregularities which disperse and refract the light falsely. Pieces of the same melting had not even the same refracting power, and this was

perhaps more common in the English and French flint glass. After obtaining these results, Fraunhofer reconstructed the furnaces, procured the necessary instruments, and took the direction of all the meltings.

He had learned from experience, that flint glass could be made so that a piece at the bottom of the pot had exactly the same refractive power as a piece from the top; but his success was of short duration, for the succeeding meltings showed that this was merely accidental. Undaunted, however, by failure, he recommenced his experiments, in which he always melted four quintals at once, and after long and severe labors, he discovered the numerous causes which occasioned his want of success.

As the English crown glass had many undulations and impurities, Fraunhofer resolved to manufacture it also. Difficulties of a new kind here presented themselves, so that he did not partly succeed till after a whole year's labor. He found also, that with whatever degree of accuracy he followed the theory in the construction of achromatic object-glasses, his expectations were never realized. On the one hand, he was convinced that it was wrong to neglect certain quantities, such as the thickness of the lens and the higher powers of the apertures, merely to obtain commodious formulæ; and on the other hand, there was no exact method for determining the exponents of refraction and dispersion in the glass, used for achromatic object-glasses. The first of these inconveniences he avoided by a new method, in which he neglected no quantity upon which the required degree of exactness depended. Hitherto, achromatic object-glasses had only been calculated for rays proceeding from a point in the axis of the lens, but Fraunhofer considered the deviations from all points situated without the axis, and this is always a minimum in his object-glasses. In this consists principally the difference between his glasses and those made in England.

The difficulty hitherto experienced in determining the refractive and dispersive powers of bodies, arises chiefly from the circumstance that the spectrum has no definite termination, and that the passage from one color to another was so gradual, and indistinctly marked, that in large spectra the angles could not be measured with a greater accuracy than from ten to fifteen minutes. In order to avoid this inconvenience, Fraunhofer succeeded, by a very ingenious contrivance, in obtaining homogeneous light of each color in the spec-

trum. In these experiments, he discovered in the orange compartment of the spectrum, produced by the light of the fire, a bright line, which he afterwards found to exist in all spectra, and by means of which he was enabled to determine the refractive powers of the bodies which produced them.

By using prisms entirely exempt from veins,—by carefully excluding all extraneous light, and even stopping those rays which formed the colored spaces that he wished to examine, he discovered that the spectrum was intersected by a great number of black lines parallel to one another, and perpendicular to its length.\* In the spectra formed by all solid and fluid bodies, he not only discovered the same lines, (of which he has reckoned five hundred and ninety in all,) but he found that they had fixed positions, and that the distances between them in different spectra afforded precise measures of the action of the prism on the rays which formed the corresponding colored spaces. The valuable Memoir in which these discoveries are consigned, was published in the fifth volume of the *Memoirs of the Academy of Munich* for 1814 and 1815, and also in a separate pamphlet entitled *Bestimmung des Brechungs, und Farbenzerstreuungs, Vermögens verschiedener Glasarten*. The writer of this notice had the satisfaction of first translating this memoir into English, and of publishing an abstract of its results in the article *Optics* in the *Edinburgh Encyclopædia*.

About this time, in 1817, Fraunhofer was elected a member of the Academy of Bavaria, of which he was an active supporter.

In speculating on the cause of the dark lines of the spectrum, our author was led to consider them as arising from the interference of the rays, and he was induced to make a complete series of experiments on the inflexion of light. These experiments he published in the eighth volume of the *Memoirs of the Academy of Munich*, under the title of *Neue Modifikation des Lichtes durch gegenseitige Einwirkung und Beugung der Strahlen und Gesetze derselben*. In these experiments, of which we have given a full account in the article *Optics* in the *Edinburgh Encyclopædia*, Fraunhofer employed a heliostate for giving a fixed direction to the solar ray, and he examined all the phenomena through a telescope

---

\* Above twenty years ago, lines were discovered in the spectrum by Dr. Wollaston. See *Phil. Trans.* 1802.

mounted upon a large theodolite, by means of which he measured the deviation of the inflected light. The object-glass was twenty lines in diameter; its focal length was 16.9 inches, and its magnifying power from 30 to 110. The heliostat was placed thirty eight feet seven and a half inches French measure from the centre of the theodolite. The diameters of the apertures were measured by a micrometer microscope, which showed distinctly the *two hundred thousandth part of an inch*, and sometimes even half that quantity. All the phenomena which he thus observed and measured, he considered to be perfectly explicable on the undulating system, with certain modifications; and upon these principles, he afterwards constructed a general analytical formula, to express these new laws of light. From this formula, it followed that these phenomena would be modified in a manner not only singular, but apparently extremely complicated, if a number of parallel lines could be made so fine, that eight thousand of them were contained in one inch. After another set of experiments, he invented a machine, by means of which he could construct these systems of lines with that accuracy which the theory required. The details of these experiments were read before the Academy of Munich on the 14th June 1823, and will be found in this and the subsequent number of this *Journal*.

M. Fraunhofer likewise applied himself to the study of various atmospheric phenomena, such as halos, parhelia, &c. which he published in Professor Shumacher's *Astronomische Abhandlungen*, and of which we have given a notice in the last number of this *Journal*, p. 348.

Such is a brief sketch of the scientific researches of Fraunhofer, but, valuable though they be, they are in no respect to be compared with his practical labors as an optician. His minor inventions are a new *Heliameter* a *repeating wire Micrometer*, and an improved *annular Micrometer*. The principal instruments which he has made, are the great parallaxic telescope, constructed for the observatory of Dorpat, and of which we have given a full description and a drawing in No. iv. p. 306 of this *Journal*. The prime cost of this instrument was L. 950. Its aperture is *nine* inches, and its focal length  $13\frac{1}{3}$  feet. His next great work was another achromatic telescope, ordered by the King of Bavaria, and which has an object-glass *twelve inches* in diameter, and eight feet in focal length, but it is not yet completed. Although en-

gaged in works of such magnitude, Fraunhofer was at the same time carrying on others on a less scale, though not of less importance to science. The Astronomical Institution of Edinburgh, in the year 1825, ordered from him a very large and complete transit instrument, with a telescope eight feet and a half in focal length, and six inches aperture. Upon the receipt of this order, he constructed three object-glasses of these dimensions, one for the Royal Observatory of Edinburgh, another for a heliometer for M. Bessel, and a third as a spare one in case M. Bessel's object-glass should meet with any accident in the bisection; and, fortunately for science, these object-glasses are all completed.

In the year 1820, when M. Reichenbach left the copartnery, MM. Utzschneider and Fraunhofer entered into a new contract for continuing their optical establishment. The former presented to Fraunhofer a share in the concern, equal to about 24,000 francs, so that, from having several other sources of income, he was now comfortable and independent. Inspired by his success and good fortune, all the activity of his mind was called forth, and he took the establishment entirely under his direction. Since 1817 it had been transferred to Munich, and the business had increased to such a degree, that *fifty* workmen are at present employed.

In 1823 M. Fraunhofer was appointed keeper of the physical cabinet of the academy of Munich, a situation to which a pension was attached. In 1824 after the public exhibition of the great telescope of Dorpat, the King of Bavaria honored him with the rank of a chevalier of the order of Civil Merit. He was also elected a member of several foreign societies, among which we may mention the Society of Arts in our own city. The university of Erlangen also conferred upon him the title of Doctor in Philosophy.

Thus honored and respected both at home and abroad, Fraunhofer was enjoying all the happiness which character and reputation and a moderate independence never fail to yield. His mind was occupied with great views of scientific ambition which he could not have failed to realize, and such was the perfection to which he had brought his art, that he was willing to undertake an achromatic telescope, with an object-glass *eighteen inches in aperture*, and we have now before us a letter in which he fixes even the price of this stupendous instrument. But he was not destined to accomplish so great an undertaking. In October 1825 he was attacked

with a pulmonary complaint, from which he never recovered. The injury which he sustained by the fall of his house seems to have left some effects behind it, and for several years he had suffered from glandular abscesses. He was, however, seldom obliged to discontinue his labors, and there is reason to think that he suffered from exposure to the heat of his furnaces. His faculties never for a moment left him; and in his few last days, his mind was occupied with the idea of a journey to France and Italy for the recovery of his health. He was cut off on the 7th June 1826, in the fortieth year of his age. A few days before this event he had received from the King of Denmark the diploma of Chevalier of the order of Dannebrog. The whole of the city of Munich took a lively interest in his disease, and felt the most sincere sorrow for his death. The magistrates of the city permitted M. Utschneider to choose a place for his tomb, and he was interred by the side of the great mechanician M. Reichenbach, who had died a short time before.

Bavaria has thus lost one of the most distinguished of her subjects, and centuries may elapse before Munich receives within her walls an individual so highly gifted and so universally esteemed. But great as her loss is, it is not rendered more poignant by the reflection that he lived unhonored and unrewarded. His own sovereign Maximilian Joseph was his earliest and his latest patron, and by the liberality with which he conferred civil honors and pecuniary rewards on Joseph Fraunhofer, he has immortalized his own name, and added a new lustre to the Bavarian crown. In thus noticing the honors which a grateful sovereign had conferred on the distinguished improver of the achromatic telescope, it is impossible to subdue the mortifying recollection, that no wreath of British gratitude has yet adorned the *inventor* of that noble instrument. England may well blush when she hears the name of Dollond pronounced without any appendage of honor, and without any association of gratitude. Even that monumental fame which she used to dispense so freely to the poets whom she starved, has been denied to this benefactor of science, and Westminster Abbey has not opened her hallowed recesses to the remains of a man who will ever be deemed one of the finest geniuses of his age, and who had exalted that genius by learning and piety of no ordinary kind.

Thus neglected and mortified, it is not a matter of surprise that this branch of science and of art should seek for



shelter in a more hospitable land, and that the pre-eminence which England has so long enjoyed in the manufacture of the achromatic telescope should be transferred to a foreign country. The loss of Fraunhofer holds out to us an opportunity of recovering what we have lost, and we earnestly hope that the Royal Society of London and the Board of Longitude will not allow it to pass. Great Britain has hitherto left the sciences and the arts to the care of individual enterprise, and to the patronage of commercial speculation; but now, when all Europe has become our rivals, when every sovereign, like the Ptolemies of old, is collecting round his throne, the wisdom even of foreign states, is it not time that she should start from her lethargy, and endeavor to secure what is yet left? The British minister who shall first establish a system of effectual patronage for our arts and sciences, and who shall deliver them from the fatal incubus of our patent laws, will be regarded as the Colbert of his age, and will secure to himself a more glorious renown than he could ever obtain from the highest achievements in legislation or in politics.

---



---

ART. XVIII.—*Cooper's Rotative Piston.*

Communicated for this Journal, by the Inventor and Proprietors.

REMARKS.

As we have had good opportunities of seeing, in full operation, the engines described in the following papers, and have been much impressed with a conviction of their superiority over those in common use, we publish the following account, designedly left imperfect, as regards the construction, but not as regards the practical effect; hoping, with the aid of the prints, to draw the public attention to the subject. The first part of this article is original, and it is completed, by extracts from the printed papers issued by the proprietors, who appear to us not to have overrated their engines. At a future time, after they have secured their invention abroad, as well as at home, a more detailed account may be given.—*Ed.*

THIS invention originated with John Milton Cooper\* of

---

\* A young man of a vigorous intellect, and strong inventive powers, who (living until that time, in the forest,) by a happy thought, hit upon this fine invention; before he had ever seen or heard the word *hydraulics*, or knew that there was such a thing as *atmospheric or hydrostatic pressure.*—*Ed.*

Vermont, and was matured by him without the aid of science, or the benefit of a practical knowledge of mechanics.

The legislature of Vermont incorporated Mr. Cooper and his associates, by the name of the American Hydraulic Company, who are now manufacturing machines under the patent. As this principle and one similar to it are applicable to steam and a variety of other purposes, for which the company are taking patents from some of the European governments, a detailed description of the principle, and explanatory plates will be delayed for a succeeding number.

Plate 1 represents the engine of size No. 7, worked by sixteen men in three positions—*a* is a side view with the suction hose upon the carriage, and without the cranks—*b* shows the rear of the engine and the situation of the cranks when in the working position; *c* the front of the engine with the cranks reversed, as when the engine is moved from place to place.

Plate 2 represents the engine of size No. 3, worked by eight men. This number has but one pair of cranks as will be seen by the side view in *a*. The three positions are represented as in plate 1.

The result of several experiments is given, to enable the reader to make a comparison with the engines of the old construction.

An engine on the rotative principle, of the size marked No. 11, worked by sixteen men, with eleven inches lever, discharged through a four inch pipe, more water than three eight inch cylinders, with nine inches stroke and fifteen inches lever worked by thirty four men—and as much water as four six and a half inch cylinders, nine inches stroke, worked by thirty six men with twenty four inches lever. This experiment was made at the corporation yard, in the city of New York, in September 1827.

The same engine with twelve men, eleven inches lever, threw more water than two engines (New York and Hydraulion,) in the city of Boston, worked by thirty six men with twenty four inches lever. This experiment was made in State street, Boston, in September, 1827.

No 7, rotative engine, with twenty men exerting an estimated power of thirty five pounds per man, with seven inches lever, threw from an inch pipe one hundred and fifty six feet horizontal, and one hundred and nine feet in height. The atmosphere was at the temperature of 42° and perfectly calm.

No. 2, rotative engine with eight men, exerting an estimated power of fifty pounds per man, threw from a half inch pipe, one hundred and forty eight feet horizontal, and one hundred and three feet in height. The atmosphere was nearly calm and the thermometer at 53°. The two last mentioned engines were made to discharge a large quantity, without particular reference to power. One constructed for power alone, would probably much exceed either of the above.

The quantity of water discharged by a No. 11 engine is five hundred and twenty five gallons for each hundred revolutions. By a No 7, three hundred and four gallons, each hundred revolutions. By a No 3, one hundred and twenty eight gallons, each hundred revolutions.

In the No. 11 engine, the revolving cylinder is thirteen inches long, and eight inches in diameter, and the surface acting upon the water is forty square inches. In No. 7, the revolving cylinder is twelve inches long, six and a half inches in diameter, and it has a surface of thirty square inches. The No. 3 cylinders are nine inches long, five inches in diameter, and eighteen square inches acting surface.

The result of experiments upon it as a pump proved satisfactorily, that the only deduction from the power applied, after the inertia of the water and pump had been once overcome, was short of seven per cent, including friction. In the old pumps ten per cent is lost in the reciprocating motion alone, exclusive of friction. (Allen's Mechanics, p. 229.)

When, upon examination of this pump, it is found that the quantity of water raised is sufficient to fill the pipe through which it is discharged to its full extent, and to keep it continually filled, and moving at almost any velocity of which machinery is capable; it is difficult to imagine what more can be effected by any machine, as nothing can give an increase of quantity, where no room is left unoccupied. The only chance for improvement then, is to so construct a pump as to give as much in quantity and with less power, or in other words, one which by the application of one hundred pounds power, will raise more than ninety three pounds of water.

The rotative piston is applicable to a variety of purposes, in some of which, particularly steam, the experiments have been very satisfactory.

\* \* \* \* \*

To protect life and property against fire has ever been an object of great importance, and the ingenuity of man has from time to time invented and adopted a variety of means to enable him to resist with success the inroads of this dangerous element. To the individual, safety is found in some degree by insurance, but the root of the evil is still untouched, and nothing short of actual care and exertion can be sure of operating as a perfect safeguard. Experience has long since shown, that the simple power of man, without the aid of mechanical ingenuity, is not sufficient to arrest the progress of fire, after it has once overstepped its proper bounds. It becomes then an object of vital interest, that that ingenuity should be so directed as to secure the object in the best, while prudence dictates it should be done in the most economical, manner. It would be wasting time, to go into a minute examination of the machines which have been, from time to time, invented for the purpose of discharging water upon fire, and useless to point out the advantages or defects of every invention which human ingenuity has placed in the possession of the public: suffice it for us to point to those which are now in use. Even here the variety will preclude a minute description of each, and we will only state what is known to all, that they are generally made with one or more piston cylinders, placed either perpendicularly or horizontally, with solid or valve pistons playing in them, with a reciprocating motion. In this way one object is accomplished, viz. the discharging of water to a much greater distance, than it can be thrown with simple power. But with this advantage there is a disadvantage, in as much as the stream being operated upon directly by the power, gives, in its motion, an exact representation of the mode of its application; consequently the stream is as unequal as the force applied, and, at every change of the piston, stops. To remedy this defect, a vessel filled with air is placed in the vicinity of the piston cylinder, and the water, ere its final discharge, is forced into the bottom of this vessel and then allowed to escape. As the pipe, through which the water makes its final escape, is generally much smaller than the piston cylinder, consequently the motion of the piston will produce compression on the water at every stroke, while the air, in the air chamber, becomes compressed in like manner. The advantage, then, of the air chamber is, that this compressed air operates upon the water as a spring, and exerts its power during the suspen-

sion of the other power, while changing the brakes. The engines in New-York are all of this construction, and are so made as to allow the brakes to run the whole length of the engine on each side. The leverage is generally twenty four inches, and the number of men required to work them about twenty. The engines, manufactured in Philadelphia and Boston, likewise work with pistons, but the levers are differently constructed, there being generally one long lever running the whole length, having its fulcrum in the centre, while the brakes are placed at each end. Some of the Philadelphia engines are of great power, allowing from thirty to forty men to work at once, and have from two to four feet levers. Another mode of making engines has been tried with success, which is to place a small cylinder within a large hollow one, and attach a wing or arm to the small cylinder, and make it sufficiently long to fill the space between the two: a stop is then placed on the opposite side of the small cylinder, fitted at the end next to the inner cylinder, so as to allow it to play on that end, while the other is attached firmly to the outer cylinder. Heads are put upon the outer cylinder, secured to it by flanches, and the gudgeons of the inner cylinder are secured by stuffing boxes; levers are put in the ends of the gudgeons of the inner cylinder, to which the brakes are attached. Two sets of valves are made use of, one between the outer cylinder and pipe, the other between the cylinder and air chamber. An engine of this kind is now used by the Sun Fire Insurance Company of London, and one of nearly the same construction, by the name of the Cataract, has been in Boston for several years, and is still in use.

In many of our cities the organization of the fire departments is excellent; and particularly in New-York, Philadelphia and Boston, the vigilance and success of the firemen have inspired a confidence which does honor to them, and to the cities to which they belong. The engines, in these places, are always found in excellent order, and at first sight, it would seem that human skill and ingenuity had been exhausted in rendering them perfect; but, upon investigation, many defects will appear, which should be remedied as far as practicable. The first of these defects is the expense necessary, not only to construct, but to work them and keep them in repair. The best New-York engines cost from seven to eight hundred dollars, including suction hose, and throw through their pipes (3-4 inch) from eighty to one hundred gallons per

minute, and require twenty men to work them. The price and power of the other engines do not materially vary from the New-York engines. Another defect, or objection, is the weight, which uniformly exceeds a ton, and in some approaches nearly two tons. They are likewise liable to be more or less out of order, and the expense of keeping them in repair is not inconsiderable.

Aware of the disadvantages of the engines now in use, and desirous of benefitting others, while advancing our own interest, we have devoted considerable time and attention in constructing fire engines on a principle entirely new. This principle was invented by Mr. Cooper, a partner in our concern, and we have made a number of engines, all of which have equalled our most sanguine expectations, and placed their utility beyond the shadow of a doubt. Simple in construction, and comparatively light, the expense bears but a small proportion to that of those now in use. Our general rule is to afford them for about one half the price which equal sizes of the old ones are sold for; and although our profits at this price are not large, we hold it to be the duty of proprietors of a patent, where the invention is of great public utility, to fix such prices as will enable all to purchase.

The following is a summary of the advantages claimed by the inventors and proprietors for their engine.

The simplicity of its construction, its rotary motion, its admirable compactness and unquestioned durability, are advantages, of no slight importance, over those on the old principle, which this machine possesses. Independently of these advantages there are others of still greater magnitude. It will raise and discharge *double* the quantity of water, in a given time; or, in other words, it requires the application of only *one half the power*, to produce the same effect. It discharges a more dense column. It is as little affected by the frosts of a northern winter as by the heat of summer: and it can be made for one half the expense.

*It will raise double the quantity of water.*

The fact is self-evident, that in working the old engines, to discharge the chamber or cylinder *once*, the piston must pass *twice* through it: an ascending stroke to create a vacuum, and a descending one to force the water. Half the time is consequently lost. In the rotative, on the contrary, it is equally evident, that a continued vacuum is created, and

a continued discharge effected, by one and the same operation. As a further illustration of the point in question, it may be observed,

*It can be worked with one half the power.*

The air vessel is totally dispensed with, and the power is applied *directly* upon the water. It operates on no more than it discharges. On the other hand, as a consequence of the alternating motion of the piston engines, twice the surface is acted upon, and the *friction* of course is comparatively *twofold*. This is not all. The power necessary to overcome the *inertia* of the water is both exerted and suspended at every stroke of the piston. But in the rotative the current flows instantly, continuously, and uninterruptedly.

Connected with this part of the subject is a fact of the first importance. The extreme necessity of prompt and efficient action in case of fire, is beyond controversy. A sufficient number of men to work the rotative engine with effect may be readily and easily convened, either in cities or villages; while a *delay*, waiting the arrival of the number necessary to work the old engines, might result in a total destruction of property.

*It is comparatively proof against frost.*

Those acquainted with the old engines, know, by sad experience, the evils of frozen valves and obstructed pistons, and that it is necessary to resort to means of *thawing out the machine*, or to suffer it to remain useless, even at times of fire. But a single revolution of the rotative, discharges the ice that may have collected on the surface exposed, and an effective operation is not retarded for a moment.

*It discharges a more condensed column.*

It is apparent to the man of chemical science, if not to the common observer, that water, *in the form of spray*, thrown into an intense flame, is instantly decomposed,\* and, instead of diminishing, increases its fury. The advantage of the rotative herein, as before observed, consists in dispensing with the air vessel. In the old machine it is indispensable. Yet, notwithstanding its use and importance to them, it constantly imparts a portion of air to the water discharged, and thus far produces the evil complained of.

---

\* Giving its oxygen to the carbon, to increase its ignition, and its hydrogen to augment the volume of flame.—*Editor.*

Hence it is evident, that the following are among the most material advantages of Cooper's Rotative Fire Engine, over all others hitherto invented, viz :

*They are more simple in their construction, more durable, and less liable to get out of order.*

*The number of hands necessary to work them does not exceed one half.*

*They are proof, with proper care, against the effects of frost.*

*The column of water is more condensed, and consequently strikes with more effect.*

*And last, though not least in the estimation of the wise and prudent, they can be furnished for half the expense.*

*Prices.*—No. 1. Discharging one barrel per minute, fifty feet high, eighty feet distant; or through the hose, each one hundred revolutions, two barrels; plain, and plain mounting, four men, \$150—with extra finish, \$175.

No. 2. Discharging from two to three barrels per minute, sixty feet high, ninety feet distant; or through the hose, each one hundred revolutions, about four barrels; eight men; plain, and plain mounting, \$225.

No. 3. Discharging about one hundred gallons per minute, sixty feet high, ninety feet distant; or through the hose, each one hundred revolutions, about one hundred and fifty gallons; eight men, plain, and plain mounting, \$250.

No. 4. With arms of the size of No. 3, but with increased diameter, and suction throats, throwing more water; twelve men; plain, and plain mounting, \$275.

No. 7. Equal in power to the engines used by the Corporation of the city of New York, and discharging the same quantity, \$400.

No. 11. Discharging double the quantity of the best engines in the city of New York, \$600.

No. 20. Discharging three times the quantity of the best engines now in use in the United States, \$1000.

Intermediate numbers, not named, in the same proportion. Force-pumps, for the supply of cities, villages and manufactories, will be charged at about one half the prices named above. Suctions for Nos. 1, 2, 3 and 4, will be charged at \$100 extra—for No. 7, \$125—for No. 11, \$150—for No. 20. \$200.

ART. XIX.—*Sketches of Naval Life, with notices of Men, Manners and Scenery, on the shores of the Mediterranean, in a series of letters from the Brandywine and Constitution frigates, in two volumes; by a CIVILIAN.* New Haven, printed and published by Hezekiah Howe.

Remarks and extracts by the Editor.

THE intellectual history of this country is becoming more and more interesting; both its science and its literature are advancing with rapid steps, and it is no longer true, as be-



fore the revolution, that our authors could be found only here and there,

Rari nantes in gurgite vasto.

The country is so eminently free, that its more active and intelligent spirits turn themselves every way, in pursuit of wealth or honor; wealth has hitherto had the ascendant, but honor sounds her trumpet loud, and the number of those who enlist under her banner, is constantly increasing. They do not all take the political field; the *many* will continue to throng there, but literature and science have now many votaries; and if their honors are not so easily obtained, they are more enviable and durable. The man who has written a good book, will be remembered and revered, when the vulgar great, of courts and cabinets have passed into oblivion. The mental character of this country will take its hue, in a degree, from our institutions: the people, supreme in our laws and policy, will cause their sway to be felt, at least as far as is proper, in our intellectual productions. Attractive, *readable*, and above all, practical books, whose useful tendency is immediately perceived, will continue to acquire the public favor.

Antiquities we have few; libraries, extensive on the European scale, we have fewer still; and neither our materials nor the public taste will permit the appearance of many of those ponderous tomes of erudition, demanding a life for a single work, which were so numerous, in the former ages of literature.\* But, the materials which we have, we are turning to good account; and in no form perhaps more interesting than in that of travels.

We are a nation of travellers. Our people are not only intelligent but inquisitive; fond of looking into the concerns of other countries; pleased with useful matter, done up in an attractive form, and as we are a young people, making the experiment of a new kind of government, and therefore capable of profiting by the errors of others, we have in our hands the means of establishing or destroying our own institutions. The writings of intelligent travellers, exhibiting to us, other systems in operation: other customs ornamenting or depressing the species; other principles, in the full tide of experiment, or already well tried, are of real importance to

---

\* Webster's Dictionary is a late exception, equally honorable to the author and his country.

us. To Americans, there is a voice in every thing from other nations, and such books are the medium through which it speaks. As the bee extracts the sweets of every flower and brings them to the common hive, so the traveller accumulates and deposits, for common use, the stores of knowledge which he has obtained. A traveller should be vigilant, inquisitive, industrious, candid and honest. He should have enlarged and comprehensive views of men and things; he should be both a scholar and a man of the world; he should unite keen perception and a cool judgment; and he should be actuated by pure and elevated moral feeling, quickened by a healthful sensibility, and a chastened taste, which will make him equally accessible, to the beauties of nature and the productions of art. He should attend not only to what is "awfully vast" but that which is "elegantly little;" he should be bold and firm, yet modest and unpretending, for only such men will succeed well in a strange land. Above all, as an American, (for such we suppose him to be,) he should give all his observations a practical character; he should bring every thing to bear on his own country, and blend the warm patriot, with the man of information and feeling. With all this he should have a ready pen; he should be able to describe well; to seize on our feelings and make us sharers in the pleasures of the journey, *while he excuses us from its fatigues*; seizing the striking points of view, whether of men or of nature, he should place before us, a graphic representation of events and things; and in a word should make us see as he saw, and feel as he felt.

It is giving our opinion of the volumes of Mr. Jones, when we say, in a word, that if this *beau ideal* of a traveller is rarely seen, he has come nearer to it, than most of those who publish their observations in the form of travels. In our last number, page 168, we gave an extract from the MS of Mr. Jones' work, and many have since, not only through our own pages, but through those of our newspapers, enjoyed the pleasure, which we experienced from seeing the ship, her spars tipped with fire balls, and her canvass emblazoned by lightning, reeling in the night squall, while we contemplated the uproar, from the snug harbor of our own safe tenement, on land.

We have already mentioned, that the author's prominent object is to display the police and character of our navy, especially as they struck a landsman;—a *civilian*, as he chooses

to style himself. He says, "I was among ships, as a traveller in a strange country—I give things, just as they affected me, and as I believe they would affect all landsmen, for whom, chiefly, the book is intended. As our men of war present the singular spectacle, of a thorough monarchy, sheltered under the wings of republicanism. I well recollect, too the pleasure, with which I saw our navy, slowly but surely building up a fair character for our nation abroad, and my first wish, after enjoying these things myself, was to have people at home enjoy them too, and hence the copious journals from which the materials for these letters have been drawn."

He says, that yielding to the judgment of persons whose opinions he respected, he has said more than he intended of the countries which he visited, but he did this the more readily, "as the countries are interesting and he wished to make the book just what the cruise was, a mixture of land and sea, or in other words, to give in all their characters, sketches of a sailor's life."

We look at the progress of our navy, as we do at every thing connected with the country, with pleasure and surprise. In October, 1775, a committee was appointed by Congress, to provide two fast sailing vessels, one of ten guns, the other of fourteen. We have now our men of war in every sea; they are spoken of with admiration wherever they appear; we are founding navy yards and docks; amassing stores and filling magazines; and shall soon launch the largest ship in the world; efficient in a tremendous degree, but, after all, probably a pageant of national vanity; and a pageant may she always remain!

Such a rapid increase has necessarily been attended, as in the case of every sudden growth, with imperfections and errors, and as each minute of the present is doubly valuable, from its necessary influence on the future, he merits the thanks of his country, who will place before us these imperfections and errors with their remedy. Naval men are, of course, best qualified to do this, but from them it must not be expected; the strictness of naval discipline will not suffer it; he who should venture to point out an error would fall under the charge of censuring his superiors, and subject himself to arrest. Still this subject, like most others, is capable of deriving benefit from candid investigation. The volumes before us open the way. The author seems to have felt

that a "civilian" is not the best judge of such matters, and he has contented himself, as most citizens would have done, with barely narrating facts, leaving to others the business of making deductions or suggesting improvements. Still in the complicated machinery of a man of war, there are many things that belong to science as well as seamanship, and on these he has dwelt more at length. We have an instance of this in Vol. II. p. 220, where the arrival of the Delaware, American line of battle ship, at Port Mahon, is mentioned: her crew had been in a sickly condition, and several deaths had occurred on her passage.

"Two causes" says the author "are assigned for it: the ship was fitted out in winter, and the inner coat of paint, it is said, was not well dried before the others were put on: another, and probably a more powerful cause, is the quantity of salt among her timbers. It is thought to preserve the wood; probably with some truth, but in the Delaware, has been laid on in such quantities, as to stream down her sides, I understand, in every part, and send up the most noxious exhalations: their passage too has been a rough one, and the ports could seldom be opened. One can hardly imagine any thing more horrible than to be shut up many hundred miles from shore, in such a vessel: to see the paint darkening around you, and the beams sweating, and all this from an atmosphere you are constantly breathing, and from which there is no escape. Our ships in the West Indies, along the African coast, and on the Brazil station, are constantly exposed to similar evils. I have heard of cases where, for many days in succession, the question regularly put by the officer coming on relief was, whether there were any dead to be buried, and how many. In the vessels sent to the African coast, they tell me, it is not uncommon to see a man carry up his hammock in the morning hale and stout, and at noon he is sewed up in it and thrown overboard. I refer you to Niles' Register for November of 1823, for a distressing account of sickness in the Macedonian, while on the West India station.

"Ships are all more or less exposed to miasmata. Our own hold, although this vessel is kept in remarkably good order, frequently sends up the most noxious effluvia. I have seen the paint, in our cock-pit, turned from white to brown, simply from the removal of some casks in the spirit hold below. The bilge water is always nauseating. We use every precaution, and I believe ships are seldom found with an atmosphere even as pure as that we breathe. Lime is scattered largely through the hold; the casks are whitewashed, and wind-sails are let down into it, as

well as into other parts of the ship. they are an excellent contrivance; but are not adequate to the evil.\*

“Chloride of lime has been found a most useful agent in such cases, and I have little doubt, would succeed in ships. I wonder the experiment has never been made. It is not an expensive article; it is portable as lime itself; it may be procured at the manufactories at home, or be easily made abroad, and for all purposes of convenience, is equal to the simple lime, the article now universally employed. Allow me to refer to an article, by Professor Silliman, on the properties of this agent.”†—*Vol. II. pp. 120—2.*

We would add by way of confirmation, of what Mr. Jones has stated, that in our opinion the chloride of lime, *in large quantities*, ought to be a regular part of the outfit of every ship, and especially of every man of war. It stands unrivalled among those agents that counteract morbid tendencies, and that correct the smell and destroy the power of noxious effluvia. It is now manufactured abundantly in our large cities; it is obtained for about eight or nine dollars a cwt.; it is attended with no inconvenience; nothing can be more simple than the mode of applying it; if kept in tight casks, it is liable to very little change, and can, with the greatest convenience, be carried on the longest voyages. Dissolved in the proportion of four ounces to one pint of water, and this solution being diluted with forty times as much water, that is, a wine glass full of the first solution to three quarts of water, it will remove every foul odor and arrest contagious influence, if occasionally sprinkled about the apartment and even on the patient, and it is found to be very effectual in curing many diseases. The navy board, we presume, will not permit so important an article to be any longer omitted in the fitting out of our ships of war, and our merchantmen ought to be not less attentive to their own safety, and to the comfort and cleanliness of their ships.

It is evident, that the superior officers of a ship of war, are very responsible men, and of course, ought to possess high qualifications: the following portraits are from our author, Vol. I. p. 40.

---

\* Capt. Elliott, on his late return from the Brazil station, I am informed, passed a leathern hose to the bottom of the hold: a pump was attached to the upper part of this, and the foul air pumped out. It is said to have had an excellent effect.

† See the Journal of Science, for October, 1826, and for April, 1829.

“The captain is an officer, so high in dignity and rank, that he ought not even to show himself often to vulgar eyes; and those, it is said, who succeed best, confine themselves most to their cabins. He, consequently, seldom interferes with the active duties of the ship: his orders are given, generally, to the first lieutenant, or through a midshipman, to the officer of the deck; and, though exercising a close scrutiny over every part, it is without appearing to do so.

“Such is this officer, in the ship: but he has other, and much higher duties; and these should never be lost sight of, in forming our estimate of his character. The other officers feel themselves members of a single vessel: he must take more enlarged views; for he is the connecting link between his own ship and other ships; between his own nation and other nations. In official intercourse abroad, he, of course, appears, and his character gives a tone to all such proceedings. To fit him for this, requires an assemblage of qualities seldom found in one man—a mind well disciplined; expanded views of society; thorough knowledge of history, laws and governments; sound judgment; quickness, decision, firmness and intrepidity.

“I come now to the other officers. The first lieutenant has the actual superintendence of the ship. He is the oldest\* lieutenant on board, and on his character, that of the ship very much depends. His powers are very great, and reach to every part; and, as it is most felt, the office is apt to be an invidious one: but murmurs, if any, are silent ones. He can even thwart the captain, and often does so, while his actions have the semblance of obedience. He ought to be a man, ready and prudent; not harsh, but decisive; and above all, well skilled in all the duties of a ship. In times of danger, he takes the trumpet; as he does also in getting under way and coming to anchor; but, in all other cases, is excused from the services of the deck: but he is responsible for the cleanliness and good order of the ship: complaints of grievances are made to him: he decides on duties and rights: gives permission to leave the ship, when for the day only: signs orders on the store rooms; and, when the captain is absent, is commander of the ship.

“To a frigate of this class, there are five more lieutenants, each taking rank according to his date.”

We will venture to add, that besides such a share of literature, as shall give to his common intercourse, and especially to his official returns, the lustre of perspicuity, correctness and good taste, he ought to possess a share of science. No

---

\* In *official* age.

reflection is intended upon those able and patriotic men, who, in the earlier periods of our navy, rose from obscure situations, or from common pursuits, to usefulness, rank and honor; but, the state of things is now changed, and, till a regular school for the navy, under the direction of the government, shall supply the means, the elements of science ought to be sought by naval men, in the seminaries of our country, and from highly qualified individuals. Natural Philosophy, Astronomy and Chemistry are fruitful in facts and principles with which the naval commander must be daily conversant, and there can be no doubt, that an acquaintance with them must be of great advantage in the practice of the profession, and in giving success to efforts to advance its interests. The British navy is adorned by some men of this character, and Capt. Basil Hall, deserves to be mentioned among the most conspicuous of them, both for his real merits in this way, and for the eclat which he has imparted to the naval character.

If naval men are acquainted with the outlines of the most important branches of natural history, they will enjoy many opportunities of making interesting and useful observations, and of selecting specimens of value; this portion of science although highly ornamental, is however, no necessary part of naval knowledge, like the important sciences first named.

The author's twenty second letter in which he gives an account of grog serving and its effects, is deserving of an attentive perusal, and were it proper to occupy our pages, to such an extent with this topic, (which is however, physical as well as moral,) we would copy the whole letter.

No one can read Mr. Jones's pathetic and eloquent appeal on this subject, fraught as it is with every just sentiment, without regretting, that the respectable author has conceded, however reluctantly, that "to banish grog from our ships of war would be a fatal experiment." The difficulty is no doubt great, but is it insuperable; this cannot be known until it is tried, and has the experiment been made in the navy of this or of any country? If so, the report of it has never come to our ears. It has been completely successful on board of a considerable number of merchant ships, and one, as we are assured, has just sailed from New York for China, with no ardent spirits on board, no not even in the medicine chest! But how! will not the crew mutiny? for they were not consulted. This will be known in due time; but the better pro-

vision, both in kind and variety, laid in for the crew—the greater attention paid, in every way, to their comfort; and the alleviation found in coffee, spruce beer, diluted acids, and even French wines, will probably reconcile them entirely to their new regimen. Who can say that a similar experiment cannot be successfully made in the navy, even without using those abundant means of enforcing submission, which should be resorted to only in the last extremity, and which are so effectual on other occasions. Who can decide, that a war ship, on whose colors was inscribed, *no grog, but more comfort and better pay*, would not enlist a crew of contented sober men, who, in battle would be sustained by cool moral courage, and who, on coming into port, would not disgrace their country's flag, by immoralities which our author, elsewhere, so feelingly laments, and so justly attributes to strong drink.

In accordance with the spirit of this work, we may be allowed to add, with respect to the physical effects of stimulus; that *it creates no power*, it only *acts on power already existing*, and excites to effort; a wasting effort of course, if often repeated, under the influence of stimulus. The spur quickens the generous courser to leap the ditch, or to scale the fence; but, both the stimulus and the effort tend to impair the animal energy, which can be renewed only by repose and food. It would, perhaps, be hard to say, that there is no possible contingency, in which it may be proper to prompt human effort, by a measured stimulus of alcohol; but certain it is, that such cases *are few, and far between*. The continued use of the stimulus of ardent spirits creates local disease in the organs; and ultimately in the system; and as in its pure state, it is decidedly and powerfully a poison, operating with rapid and fatal energy; so in its more diluted forms, it works the same way, and produces a sure although a more tardy catastrophe.

Mr. Jones's travels contain a number of notices of natural, or other objects connected with science. In the harbor of Mahon, where the squadron passed so much time, he found many interesting things. He says,

“As I sauntered along its shores, my attention was drawn to a beautiful flower, at the bottom, where the water was near a fathom in depth. It grew on a stalk about three eighths of an inch in diameter, and about ten inches in length; was, in shape,



like an inverted cone about five inches in diameter; and was variegated with brilliant colors, red, yellow and purple\*. It was a

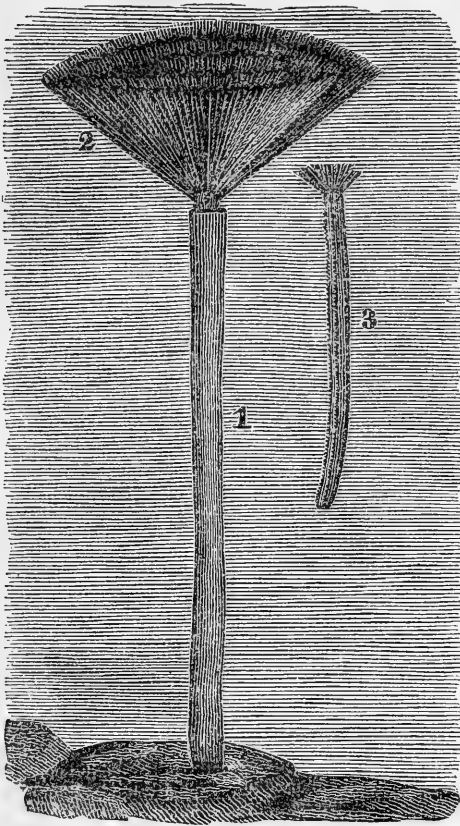

1. Stalk.  
2. Flower.

3. The animal with part of  
the flower attached.

beautiful thing, and I wanted it: so I determined to knock it off, hoping some chance might bring it to the shore. I threw, and saw I struck it; when the water cleared up, the stalk was there, but I could not discover the flower. After a vain search, I went on further, and came to another, near the shore. I thought I was sure of this, and got a stick to draw it to me, when, as soon as I touched it—the whole disappeared. It was all animal,—flower and all. I have since procured several, and have preserved them. The stalk is formed by concentric coats of gristly matter, which is transparent when the outer one is removed: it is attached to the rocks below. This forms a

tube, in which is an animal, about seven inches long, with two rows of feet in its whole length: at its upper end is the head,

\* By permission of the publisher, we here insert the wood cut of this remarkable zoophyte, which appears to be, substantially described in Ellis, on corallines, pa. 92, under the name of a tubular coralline, from Malta.

and rising from the latter, the flower, I have spoken of. This is formed by a vast number of very delicate fibres, each with an exceedingly fine and variegated fringe, placed like that of a feather: they do not form a single cup, but several; and their roots are so ranged, as to produce a spiral channel, reaching to the animal's mouth. They have a strong sensitive power, and, as soon as touched, are dragged by the animal into the stalk. After a few minutes, it ascends again, and the flower spreads out as before: doubtless they are intended for taking food. A touch will spoil them, so delicately are they formed: I cut off the flower, and pass a paper under it, in water: then, by laying it on a board, and pouring water on, spread it out as I wish it: when dried, it looks like a very fine painting. They are of the coral-line species, and are called *water pinks* by the natives. I can take you too, to parts of the harbor, where the bottom is covered with tufts of grass; some green; some dark colored; some in plain tufts, and others with a star in the middle: this grass too, is all animal, and if you touch it, will disappear in the ground. There is a large quantity of it, just North of hospital island. I find abundant amusement in the harbor: there is an old fisherman, whom I sometimes accompany, and watch at his operations. He sprinkles oil on the water, to smooth its surface, and can then distinguish objects at a great depth. He is now mostly employed in procuring *date* fish. This is a curious shell fish, so called from its shape, which has a strong resemblance to a date. It is procured only here, at Malta, at Trieste, and at another place, whose name I have forgotten. It is always found *in* the rocks, generally approaching within an inch of their surface, with which it communicates by a small orifice. This hole is formed, probably, by some corrosive fluid thrown out by the animal, as it is smooth and shaped exactly to the shell, which is attached to the rock, at one end, by some very small fibres: the shell is bivalve, thin and delicate, usually three inches and a half in length, and one inch in its greatest diameter. They procure them, by chiselling off fragments of the rock, with a long iron chisel; these are drawn up, and when the boat is filled, are carried ashore to be broken up. They export them in the rock, to the neighboring Spanish coasts. The rock is a soft free-stone, prevailing also, all over the island. The fish has a peculiar taste, and is considered a great delicacy: it is most abundant at the depth of two or three fathoms. There is another shell fish; the largest, two feet in length, and about four inches thick at the thickest part: it is shaped like a fan half open, and always found with the pointed end lowermost, at which part, and attaching it to the ground, is a silky substance, often manufactured, by the natives, into stockings and gloves. The upper part of the shell, inside,

is red; the lower, white and pearly: pearls are usually found in them, sometimes of large size, but colored: I have some, however, that approach the true pearl, in color. The sea-horse is a curious little thing. It is not more than three inches long, hard and bony, but with a head bearing great resemblance to that of a horse: it has no fins: but has the power of coiling up the lower part of the body, and, I suppose, moves by throwing this out again; for, though we often meet them in a dried state, I have not been able to see any in their proper element. The finer Nautilus, (*Argonauta* or *Argo*,) a beautiful thing, is also found here. The natives work the smaller shells into handsome mantle ornaments: I have seen Neptune in his car, with trident and sea-horses, and they are now making for me, two urns, with flowers; all of marine substances."—*Vol. I. pp. 80—3.*

The catacombs of the island of Milo are interesting if for no other reason, on account of their containing lachrymatories made of glass.

"The catacombs are mostly single chambers, cut in the soft rock, about eight feet square, and of proportionate height: at each side, is a low recess, running the whole length: this is paved with large flags, and under these flags, in a rectangular cavity, just large enough to contain a full grown person, the body was deposited. Some consist of a succession of chambers, like this. There are no inscriptions; but among the decayed bones, are found coins, ornaments of gold and precious stones for the ears, lamps, lachrymatory vases, with large quantities of glass, earthen and copper vessels, probably, for oils and perfumes. You know the ancients were in the habit of coming, at stated seasons, to weep over the dead: the lachrymatories, (long slender vessels,) it is supposed, were used at such times, to catch their tears. One of the first visitors we had on board our ship, was a man, with a basket of these cups: for the natives dig open the catacombs, whenever the ground is soft enough; and drive a good trade, with these relics of the piety of their ancestors. One would naturally doubt the genuineness of wares, where deception is so easy; but I have satisfied myself, that they are what they profess to be: they would form an interesting study to the antiquarian. Many of the earthen cups are of the form, we call Etruscan: the larger are painted with a light pencil; often only the outlines are given, but, generally, with much force and spirit. The question, whether the ancients knew the use of glass or not, was settled some time since, by the discoveries in Pompeii: this is the first I have heard of, among the Greeks. The vessels discovered are generally flat at the bottom, and four inches over: they rise one inch, of this

diameter, and then suddenly narrowing into the diameter of an inch, and a half pass thus to the height of seven or eight inches. their shape is, consequently, much like that of a candlestick. But I have several of other forms, running through a considerable variety; and among them, a set of pateræ found together, consisting of three dishes, very much like those brought on our tables with sweetmeats. The glass is, sometimes, like the common glass of our country; and in this case, the vessels are very thin. Others are thick, and composed of a curious matter: it has a pearly lustre, and in every position, presents beautiful green and purple hues, on the surface. This last has suffered from the damps, and the exterior scales off; the lustre I spoke of, however, is in the glass, with which some metal appears to have been fused; it is very brittle.\*

“Some of the Commodore’s men have been digging here; but have found only an earthen jar, containing the bones of a child.”  
—*Vol. I. p. 60.*

Milo contains interesting minerals.

“Tournefort calls it a natural laboratory: and it is so. In many places chemical operations are still going on; in all others their results are deposited in the greatest abundance; the common rock of the island is a tufa: the way up to Castro leads over hills of baked and whitened earth, filled with round masses of obsidian: but the most interesting parts of the island, are on the South and South Western sides. In the latter is a place called Calamo, which we visited yesterday. They first took us to a hill of considerable elevation: its summit was covered with burnt rocks, of ragged surface, tossed confusedly on one another: among them are crevices, through which hot sulphurous vapors ascend, and deposite round, large quantities of crystallized or sublimated sulphur. Proceeding South from this, three fourths of a mile, you come to the locality of the plumous or feathered alum: it is in a cave, on the sea shore: above it is a steep hill, blue, yellow, white, red, and smelling strongly of sulphur. The cave is about twelve feet deep, and five in height: its vault is formed of this mineral, of which you may get some idea from its name. Suppose fibres of nearly pure alum, an inch or more in length, white and fine as silk, put together so as to form a compact, but not firm mass: sprinkle this with handsome green and yellow colors, and you have an idea of the cave as it ap-

---

\* By permission of the publisher, we insert, on the opposite page the wood cut of these lachrymatories.

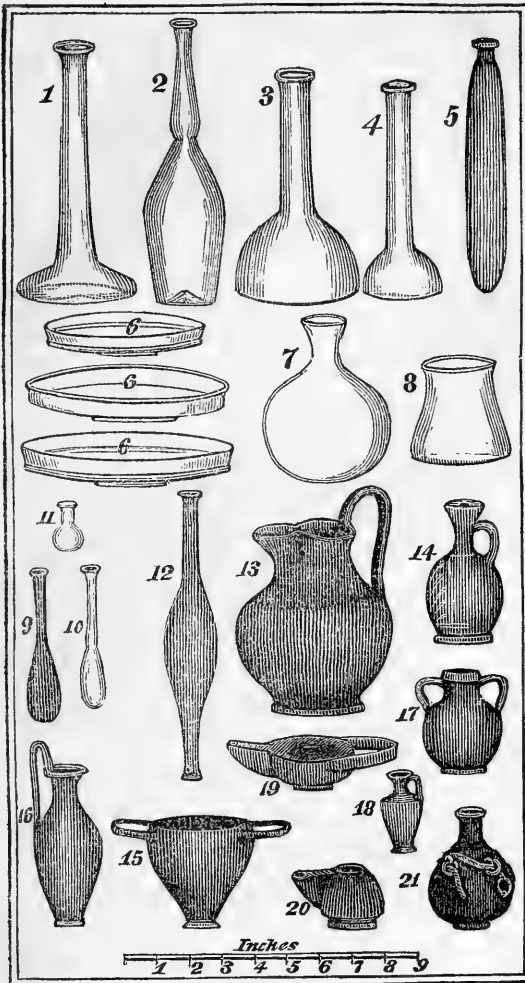

No. 1. Glass lachrymatory from Milo. The glass is like our common window glass, but very thin.

2. Glass, from Milo. Glass, lighter in color than the former, and not more than one fiftieth of an inch in thickness

3. Glass, from Egina. Glass, very thick, silvery and irised.

4. Glass, from Egina: darker colored than the former, and beautifully irised. All the glass which I have from Egina, has the silvery and irised appearance.

5. Alabaster lachrymatory, from Milo.

6. A set of glass pateræ, from Milo. Glass, like No. 1. but purer. They were found together, in a pile.

7. Glass, from Milo: qualities, like those of No. 1.

8. Glass, from Milo: in color, like No. 2.

9. Glass, from Milo: qualities, like those of No. 3.

10. Glass, from Milo: color, a very dark green.

11. Glass, from Milo: qualities, as in No. 3: it is a beautiful little thing.

12. Lachrymatory of *terra cotta*, Milo. These are common.

13, 14, 15, 16, 17, 18. Vessels of *terra cotta*, from Milo.

19, 20. Lamps, from Milo.

21. A copper vessel, from Milo: a beautiful article, though greatly rusted.

pears above.\* The bottom is an earth, from which puffs up hot air: this is strongly impregnated with sulphur, and deposits about each crevice, beautiful small crystals of the mineral: in front of the cave is a hot spring; and at its sides are other caves, that have ceased to act.

“There is another one, called by the natives, the Stipsy or alum cave. It is near the centre of the island, and was worked by the ancients: the alum, as Pliny tells us, being the best, after that of Egypt, that could be procured. Towards the bottom of a high reddish hill, we entered a hole on all fours; and working our way backward awhile; and then proceeding more erect, through a narrow passage, came to a large chamber, one hundred and twenty feet long, and with an atmosphere that makes the thermometer rise to ninety, in some places to one hundred degrees of Fahrenheit. The earth above is filled with specks of alum, and blown into the consistency of baker’s bread, to compare large things with small. The cells, often a foot in length, are lined on the upper side with crystals of alum; some small, but clean and pure, sometimes with a slight green tinge: others are white and silky, with a covering of the most delicate white down. Among them are spots, from which are suspended crystals of acicular gypsum, each crystal distinct, and falling at the slightest touch. The entrance is lined with branchy gypsum; and selenite is scattered over the rocks without. Advancing from this to the harbour, you come to a cave, called Loutra, about ninety feet deep; at the end of which is a fountain of hot salt water: the exhalations have coated the rocks around it with salt. Our guide to this, was a priest: he stripped off his upper garments, before entering, and judge of our surprise, when we saw two pocket pistols among his trappings. It will shew the state of the island: we met shepherds with their flocks, in our excursions; but the “piping times of peace” are over; and instead of the “*tenui avena*,” each carried a good long gun. The natives consider this fountain as endued with good medical properties, and frequently use it as a bath, as well as the waters on the shores just below: there are several hot springs there, in the sand; and a still larger number, a few rods in the water: the thermometer rises to 128° in the spring, and in the sand, to 135° of Fahrenheit.—*Vol. I. pp. 137—9.*

---

\* This very rare mineral has been examined by Mr. Charles U. Shepard, of Yale College; and proves to be the native soda alum, a new species in mineralogy, lately established by Dr. Thompson.—See *American Journal of Science*, Vol. XVI, No. 1, 1829.

Mr. Jones visited the long celebrated grotto in the island of Antiparos, and the following passages are cited from his account of the excursion.

“ Antiparos is about seven miles in length, narrow, and separated from Paros by a channel, one mile in its narrowest part.”

“ The grotto is on the Southern side of the Island, facing the South-West : our approach was from the North-Eastward : we crossed the ridge of a high, bare eminence ; then descending a little, and turning, had the entrance before us. A large cavern yawned, with the giant, an immense stalagmite ; and the whole nearly as the book tells us. This is fifteen feet high, forty feet wide, and thirty deep : but this is not the grotto : it is only the vestibule. At the back part of this cavern, we descended a little, and then halted before a hole, dark and silent, down which we were to descend. While we were preparing to enter, noises began to issue from it, and a light to glimmer ; and then a midshipman from the North Carolina emerged, pale and sick with the damps and fatigue. The cave seems to be now frequently visited, and the Greeks have a rope and ladders prepared, for which they charge : but the former is weak, and we were cautioned against trusting ourselves to it, as near a dozen would have to cling to it at a time. They made ours fast to a stalagmite at the entrance, and passing in, we saw no more of them ; but, after a while, were informed that all was ready : so we lighted our tapers, and clinging to the rope with our right hand, began the descent. No one thought of danger ; for directly after entering, one of the grandest sights opened upon us, that eyes have ever seen. At first we heard hammering, and voices within, without being able to tell whence they proceeded : but soon a cave of vast dimensions presented itself, its ceiling covered with stalactites, and its sides glittering with spar. A party from the North Carolina was below, and as they were scattered in every direction, and every one had a light, we were able to see at one view the whole extent of this immense chamber : our party added very much to the effect, as they were seen, by the dim lights they bore, descending along its side. The lower part of the descent was effected by a rope ladder : after this, we passed over some slippery rocks, and found ourselves at the bottom. On our right, was a slanting chasm, which we avoided by passing over a heap of earth towards the left ; and then found ourselves in the most brilliant part of the grotto. The spar, in many places, had been injured by visitors, but it is still exceedingly beautiful. Its purity is without a speck or shade : it is very clear, and its fracture of dazzling brightness : those parts that are protected from the air, are covered with shining

crystals, and in many parts, it has formed itself into singular nodules, and other grotesque forms. Some of them our officers not inaptly compared to cauliflowers. In two things, my impressions were different from those of former travellers. The lights below, enabled me to see that we passed at once into the large chamber, and did not enter it, through a succession of others, as I had expected to do. The size too is smaller than I had anticipated. It is difficult to judge amid such obscurity; but I should think it not more than one hundred and fifty feet long; about seventy in breadth, and of equal height: but the shape is very irregular. The shelving descent on our right, leads, doubtless to other grottos: part of the way down is a figure, bearing a strong resemblance to a woman with a child in her arms, which the Greeks call "the Virgin." An active imagination, indeed, could find abundant employment in the fantastic shapes, into which many of the spars have formed themselves; and might easily discover in them human forms, beasts, and flowers. The handsomest parts, however, are fast disappearing; for as each traveller considers its beauties as a lawful prey, and selects his pieces, without caring for the injury done in procuring them, much is carried off, and more destroyed.

"Towards the further end of the cave is the altar, spoken of by Magni, the Italian. The resemblance is exceedingly striking; and is still greater, as the whole stands isolated in the chamber, with a neat little area in front. A number of large stalactites descend from the vault above: the droppings from them have caused numberless smaller columns to ascend; some plain and straight, others irregular, and forming altogether a very good imitation of a Roman Catholic altar, with its tapers and fanciful decorations."—*Vol. I. pp. 141—44.*

"Over the centre of the altar is a very large stalactite: I climbed up, and on striking it with a hammer, it rung like a bell. Our officers had last year, broken one of them from its place: it is Arragonite, with radiating crystals. Near the altar, is a small chamber, neatly partitioned off by the spar.

"The brilliancy of this article forms the characteristic of the cave. Nearly the whole Island is a rock of marble, equal in purity to the Parian: the deposits are, therefore, the most brilliant imaginable: when it is well lighted up, the scene must be a splendid one. Commodore Rodgers, in a visit last year, had it illuminated with blue lights, I understand with admirable effect.

"I should have liked to spend many hours there: but light after light had ascended the shelving sides, and at last I heard the voices of my companions chiding my delay. So I hurried to a fountain, near the spot where we finished our descent; sip-



ped a little of its hard waters, and soon after was breathing fresh air in the light of the clear day."

"Some of our officers spent the day in rambling over Paros, and took the Marpesus quarries in their way. They are not far from the road between Aüsa and Parechia, and extend to a great depth in the mountain: the cuttings were all rectangular, and such are the numerous blocks still lying about the entrance. There are two quarries: over the entrance of the smaller, is a large bas-relief, with an inscription. I forgot to say that there are also Greek inscriptions, in the outer grotto of Anti-Paros; but they are defaced, and of doubtful import. From the Marpesus quarries came the marble for the Venus de Medicis, the Belvidere Apollo, and the Antinous: the Arundelian marbles, you know, are also from this Island.

"Our ships spent some days, last year, at Aüsa; where they watered from a fine clear stream, running through the town: but the water was so highly impregnated with lime, as to bring on the dysentery throughout the squadron."—*Vol. I. pp. 14b—6.*

To minds as inquisitive as those of our countrymen, the information which this work communicates must be gratifying. We have seen our ships of war in our harbors, and occasionally those of other nations in theirs; we have looked at the dark frowning battlements and tasteful spars, and have now and then caught a glimpse of the skilful evolutions on board; we have passed along their decks and have admired the neatness and good order, visible in every part; and we have wished to know more of them, a desire only increased by the occasional letters of our officers while abroad, or notices of their appearance, in foreign papers. Our wish is now gratified. The whole system is laid open to us; we open the book and are carried forward, and made to live within the wooden walls and to traverse the seas, and witness the complicated but beautiful movements of our ships of war; and we are thus enabled to gaze on scenes seldom accessible to landsmen; and we lay the book down, surprised to find ourselves possessed, after a few hours reading, of an experience of three years among scenes, characters and events, possessing in so high a degree, the charm of novelty. It seems to have been the original intention of the author, to confine himself to events and scenes in the navy, and to take only such notices of countries visited, as to keep up the connexion between the parts. He found himself however, on classic ground; the spirit of antiquity seized on his feelings, and

carried him forward with a power which he seems to have been as little disposed as able to resist. We do not wonder at it, for who could speak of, much more who could see and tread the ground of Salamis, and Argos, and Athens, and Corinth, and Constantinople, and old Rome, without having a strong impulse imparted to his feelings.

If this Journal were exclusively literary, we should introduce various passages illustrating the author's manner of writing on the principal subjects that came under his observation. We shall however, limit our additional quotations to a few scenes, relating principally to the manœuvres, that involve movements depending on the principles of mechanics.

The following passage describes the unfurling of the sails.

“We will suppose, then, a fine morning, after a wet day; and there are many such days here, I find. Suppose yourself looking at the ships, black, silent masses, without signs of life about them, except a sentinel or two pacing to and fro. All at once, a few little flags are run up at the stern of the Commodore's ship, as if by magic; for no one is seen to produce this effect. Soon after, a single one ascends, in like manner, to the mast head of each of the other ships; and then all pass down again. A shrill whistle and a cry are now heard; but still there is no motion; and no sign of any; except a hat, here and there, appearing just above the bulwarks. So it remains a few minutes; and then, as the trumpets sound, the shrouds become in a moment alive with men. They pass rapidly to the tops; and all is silence again. Another sound; and the rigging is again darkened with men, new sets passing up, and those in the tops ascending to the highest spars: they throw themselves out upon the yards, and a busy scene ensues; but all settles again into inactivity. And then, at the words “let fall,” the ships simultaneously, and in a moment, drop their thousand folds of canvass; the ensign is run up, and the pendant throws itself open to the breeze. What I have described, is loosing sails to dry, an operation we frequently have, and always a beautiful one.”—*Vol. I. p. 62.*

The sailing of the squadron from the port of Mahon, is thus described :

“Spring has considerably advanced, in these countries; and this morning rose clear and bright, with balmy air, and a gentle breeze from the North. Our ship had been well stored; her boats were all stowed away; every rope was in its place, and

every eye was fixed in expectation, on the Flag ship. At eight o'clock, the looked for signal, to "unmoor ship," was made; and was quickly and cheerfully answered. There was a few minute's silence; and then, through the whole squadron, arose the din of whistles and calls, and oft repeated orders. I wish, earnestly, I could place the whole scene before you; and give you, too, a heart light as we had, to enjoy it. The little Porpoise first dropped her white sails; glided down the harbor; rounded a high point and disappeared. The flag ship came next: they warped her first to the windward side of the harbor; she rested there a moment; her shrouds first, and then, by simultaneous motion, her long yards were covered with men; the trumpet thundered; she dropped her huge sails, that shook themselves a moment, rejoicing "like a giant to run his course," and then spreading out to the breeze, and throwing back the bright morning rays, gave motion to the dark proud mass below. You could almost think she had sensibility; so graceful, yet majestic was her motion. Some hundreds of spectators lined the edge of the precipice; and we could see admiration in all their actions. She swept by the point; but her upper sails, with the broad pendant and its stars, were still seen far above it. The Ontario followed; and next came our own ship, with music and happy hearts. As we neared the Holland, a Dutch seventy-four, in port, her band struck up, "Hail Columbia:" we answered with their national air: she gave us Yankee Doodle, and we again replied. They also sent their boats to tow us, if there should be occasion.—*Vol I. pp. 110—11.*

Tacking depends on a nice adjustment of forces between wind and water, and is beautifully illustrated in the following passage, describing the tacking of the ship in the midst of the Turkish fleet.

"You may suppose our ship gliding on in quiet among them. She is close hauled to the wind: it is a light breeze, and all her sails are spread out, tapering aloft almost to a point. Thus she speeds on, when all at once her head begins to come gracefully round; the sails lose their fulness, and tasteful curve; shake in the breeze, and then swell back against the masts: thus they remain a few moments; and then, on a sudden, and by simultaneous motion, the two hinder sets, from skysail down, whirl speedily round, and again spread out to the breeze: thus again we rest a moment or two; then the head sails all take a similar motion, and the heavy mass again starts forward in its course: and in all this, scarcely a man is seen. You will recognize, in this, the operation of tacking ship: it was, to-day, a beautiful operation,

as the sea was smooth; but I have seen it done in seas, where one would think the ship would sink instantly, without the use of her sails to steady her; and where her bow is acted on by waves that produce a convulsive quivering throughout, at every blow. They sometimes throw the vessel back again: it is called missing stays, and often produces dangerous consequences: on a lee shore, it is nearly certain destruction.”—*Vol. I. p. 168.*

Anchoring in the straits of Salamis is thus described :

“ There are nine men of war, English, French, and Austrian, around us, watching the course of events. I wish you could have seen our ship as she anchored among them this afternoon. Coming to anchor is always an interesting operation, and always greatly enjoyed; for hearts then beat high, with the hope of shore again; and, generally, we have new scenes close around us. If it is in a frequented place, the men are always ordered to clean themselves and dress; mats are taken from the rigging; every rope is carefully adjusted, and the ship is made to look as neat as possible. The character of a vessel, and of her officers, depends much on the skill and expedition with which this manœuvre is performed; for she is then closely watched, and every evolution noted. The idea that all eyes are upon you, gives a touch of the sublime, at least, gives a deep interest to the occasion. The ship seems to swell out in her dimensions; every event takes importance, and, landsman as I am, I have learnt to be a critic, and detect the least impropriety, at such times. Then, no one dares shew himself: if the men stoop to peep through a port, they are driven away; if an officer steps on a gun carriage, he first gets a cross look, and then a message to come down. So we glide on in deep silence, broken only at intervals, by the lead-men’s cries—“*by t-h-e m-â-r-k, tén;*” “*bē t-h-e d-ê-ê-p, nine;*” “*quâr-t-ê-r l-ê-s-s, nine.*” The first lieutenant has the trumpet, but it is not used; officers stand near him, to carry his orders to every part of the ship: you catch the infection, and words of pleasure or surprise are in low tones; you tread softly, and a spell seems to be on the ship. But all at once, the trumpet is used again; “stand by the larboard anchor,” is thundered along the deck; “let go the larboard anchor;” and a heavy plunge is the reply. The men now gather thick around the lower part of the shrouds, the foremost with hands and feet on the ladder, ready for a spring; and at the order, follows one of those scenes of fearlessness, activity and skill, which I have described. There is a contest between the yardsmen, who shall do his work soonest and best, and where this is wanting, the boatswain’s colt supplies the lack.”—*Vol. I. pp. 272—3.*

Where we find so much to commend, we cannot be strongly disposed to censure, and the light faults of style, if such they are, seem hardly worthy of notice.

To a man, who in a cheerful and engaging manner, is constantly imparting to us valuable and interesting information, we feel little disposed to say ; sir, your style, delightful as it is, is sometimes a little careless, abrupt and elliptical. It is evidently not intended by the author, to march in stately gravity, although on subjects of a grave and moral cast, he is considerate and judicious, and never leaves us in doubt as to his good principles.

The freedom of the author's style, make us more and more, parties to his adventures, and we feel that had we been with him, we should have talked, (or wished to talk) in the same animated and free style in which he has written.

---

ART. XX.—*Description of the High Rock Spring, at Saratoga Springs, in the County of Saratoga, and State of New York, with a drawing, communicated for the Journal of Science, by JOHN N. STEEL, M. D.*

THE *High Rock Spring*, one of the number of Medical springs which have given so much celebrity to Saratoga as a watering place, is very justly distinguished among the many interesting natural curiosities which our country affords, and is, unquestionably, entitled to a conspicuous place in the scientific journals of the day ; and, although it has been discovered, and its water in high repute for its medicinal properties for more than half a century, yet, I believe, it has never been noticed, except cursorily, if at all, by any of them.

The late Dr. Valentine Seaman, of New-York, in the last edition of his “ *Dissertation on the mineral waters of Saratoga,*” published in 1809, gave a very imperfect drawing of the rock, which, I believe, is the only one ever published.— In remarking upon it, the venerable Dr. very justly observes : “ The more we reflect upon it, the more we must be convinced of the important place this rock ought to hold among the wonderful works of nature. Had it stood upon the borders of the *Lago d' Agnano*, the noted *Grotto del Cani* which burdens almost every book which treats upon the carbonic acid gas, since the peculiar properties of that air have been known, would never have been heard of beyond the environs

of Naples, while this fountain, in its place, would have been *deservedly* celebrated in story, and spread upon canvas, to the admiration of the world, as one of its greatest curiosities.

The valley, in which all the mineral springs at this place are situated, is terminated, on both sides, by steep banks which rise from twenty to forty feet above the level of the little stream, which passes between them. On the eastern side, this bank consists of sand and coarse gravel, evidently resting upon a bed of marl, which, every where forms the bed of the valley. From near the base of this bank burst numerous fresh water springs, which, by the help of a forcing pump, supply a great part of the village, which stands upon the opposite bank, with a very pure and wholesome water.

On the western side, the bank is composed of materials altogether different. It consists of a very pure shell limestone of a blue color, alternating with a kind of calcareous sandstone, in the latter of which are imbedded large masses of hornstone, together with crystals of quartz in great abundance. It contains likewise chalcedony and agate, and some few specimens of organic remains, but they are not found in it in so great abundance as in its associate limestone.—The whole of this formation seems to terminate here, and nearly in a perpendicular direction, as none of it is discoverable on the opposite side of the valley. All the rock formation found in that direction belongs to the transition class.—The mineral springs occupy stations which warrant the belief that they have their origin, or pass up from a greater depth, at, or near the junction of these two formations, transition and secondary.

The spring, which it is the object of this memoir to describe, is situated but a few steps from the bottom of the limestone ledge, on the western border of the marsh; and the rock, which surrounds and encloses it, rests on the surface of the marl, or is but slightly connected with it. This rock is of a conical shape. It narrows rapidly as it rises from the earth, and terminates in a rounded top, in the centre of which is a circular opening which leads to the interior cavity; it gradually widens as the rock enlarges, leaving its walls nearly of an equal thickness throughout. In this cavity the water rises some distance above the surrounding earth, and is there seen constantly agitated by the incessant escape of carbonic acid gas, for which the vacancy, above the water, forms a capacious and secure reservoir, where the curious

may, at any time, make the experiment of its deleterious effects on animal life.

The following dimensions of this singular production of nature, are taken from actual measurement : Perpendicular height, four feet ; circumference at the base, twenty six feet, eight inches ; length of a line drawn over the rock from north to south, eleven feet, seven inches ; length of the same from east to west, ten feet, nine inches ; from the top of the rock to the surface of the water, two feet four inches ; depth of water in the cavity of the rock, seven feet eight inches ; the hole is nearly circular, and measures ten inches across.

This rock, very properly, belongs to that species of limestone termed *calcareous tufa*, being evidently the product of the water. It is composed of the carbonate of lime, magnesia, and the oxide of iron, together with a proportion of sand and clay. It likewise exhibits, when broken, the impressions of leaves and twigs of trees. It is somewhat undulated on its surface, and, about the top, compact and indurated, while near its base it is of a more spongy and friable character, but every where sufficiently compact to render it impervious to water.

That the water, at some former period, issued from the cavity, and descended upon the sides of the rock, will scarcely admit of a doubt, but the precise manner in which the rock was formed, or the time when the water ceased to flow upon its surface, is not quite so obvious ; the most probable conjecture is, that the basis of this mass was commenced beneath the surface of the earth, that the water, thus confined within the limits of its own sediment, continued to rise, and as it escaped over the sides of its prison, constantly added to the dimensions of its walls. In this manner it would continue to rise, until the column of water in the rock balanced the power that forced it up, in which case it would become stationary, and it is but just to infer, that, in process of time, the power so propelling the water might be diminished in its force, when the water in the spring would of course sink in exact proportion to the loss of that power.

There was an opinion prevailing among the early settlers, that the rock had been fractured by the fall of a tree, and to this accident they imputed the failure of the water to run over its top, believing that it escaped through a fissure, which, although invisible, they still imagined must exist. This conjecture however, does not appear to be well founded ; the spring

was visited as early as the year 1767, and no appearances to justify such an opinion then presented itself, although the water did not reach the top of the rock by several inches.

Loran Tarbel, an aged chief of the St. Regis tribe of Indians, told the present Chancellor Walworth, that he visited this spring, when a boy, and that he was told by the Indians, that it once ran over the top, but owing to some of their women\* bathing in it, the water sunk into the rock, and never afterwards showed itself.

The conspicuous appearance which this rock presents, must have introduced itself to the notice of the natives at a very early period, and, although it was probably known and visited by individuals whose business called them into the woods, it does not appear to have attracted much attention from the white population of the country, until about the year 1767, when it was visited by Sir Wm. Johnson, who then resided at Johnstown, about thirty miles to the west of the Springs, in the capacity of Indian Agent. From this period, "the Spring," as the place was then termed, came more rapidly into notice, and, for some years, was the only one to which much consequence was attached. The extravagant stories, told by the first settlers, of its astonishing effects in the cure of almost every species of disease, are still remembered and repeated by their too credulous descendants, which, in conjunction with the mysterious character of this rock, continue to attach an importance to the character of this water, in the eyes of the vulgar, which no other fountain will probably ever arrive at.

From a recent analysis made with a view to the strictest accuracy, the details of which will ere long be laid before the public, this water is found to contain the following ingredients in one gallon, or 231 cubic inches :

Muriate of soda,	-	-	-	-	-	189.18 grains
Carbonate of soda,	-	-	-	-	-	12.464
Hydriodate of soda,	-	-	-	-	-	2.5
Carbonate of lime,	-	-	-	-	-	69.29
Carbonate of magnesia,	-	-	-	-	-	40.425
Oxide of iron,	-	-	-	-	-	3.85

---

317.709

---

\* *Εν Αχάθαρσία οντες.*



Silica and alumine, in very small quantities.

Carbonic acid gas, - - - - -	304 cubic inches
Atmospheric air, - - - - -	5

Gaseous contents in a gallon, - - - - - 309

Specific gravity of the water at the temperature of 60° is 1006.85, pure water being 1000,\* and its temperature at the bottom of the rock is uniformly 48° Fahr.

ART. XXI.—*Real and supposed effects of igneous action.*

I.—*Letters from the Sandwich Islands ; by* JOSEPH GOODRICH.

II.—*A letter from Mexico ; by* WILLIAM MACLURE.

I. MR. GOODRICH'S LETTERS.

*Remarks.*

IN a note to an account of the volcanic character of the island of Hawaii, published in Vol. XI. of this Journal, mention is made of a box of minerals destined for the Editor.—They having arrived, we shall annex to the extracts, from a letter preceding and another accompanying them, such remarks as may serve to explain the characteristic appearances of the specimens. The first letter is dated Byron's Bay, Hawaii, Oct. 25, 1828. The writer says:—"I embrace this opportunity of sending you a small cask of minerals, of my own collecting. They are chiefly from the great volcano, an account of which I gave you in a letter of 1825 ;† the crater is not so deep now as it was then, by three hundred, or four hundred feet, the lava having boiled up from beneath. I have been there several times since I formerly wrote to you. I can easily perceive that great alterations are taking place at the bottom ; it is filling up gradually, and slight shocks of earthquakes occur here frequently.

The minerals that are at the upper part of the cask, I collected upon the summit of Mōuna Kea. Some of them appear to me to be fragments of the granite rock. The shells that are with them, the largest‡ is from the Gulf of California ; the remainder are from this island. The volcanic specimens in

\* The sp. gr. of the Hamilton spring water (left blank, p. 245) is, as we since learn, 1008.5, pure water being 1000.—*Ed.*

† Which is published in Vol. XI. p. 2. ‡ A magnificent pearl oyster.

the cocoanut shells, are some of the more delicate sort ; I am unable to say of what kind they are, not having time and means for trying them by experiment. The white, or light colored ones are from the bottom of the crater, together with the capillary volcanic glass ; some of the cocoanut shells contain what I suppose to be pumice stone, (although they much more resemble a sponge,) they are much lighter than any of the kind that I have heretofore seen. These light materials are very abundant about the crater, being driven about by the winds in every direction. The remainder of the minerals are almost all from the inside of the crater, some from the bottom ; others from the sides and from various places within the crater. Such as they are, I forward them for your inspection, and I should like to receive your remarks upon them. Should any of them be worth notice, I should be happy to forward more hereafter. If there are any researches that you would like have made, (as you will think of many things that do not occur to me) be so kind as to inform me what they are, and I will attend to them with pleasure, and send you the result by the first opportunity.

The second letter is dated Oahu, June 12, 1828. Mr. Goodrich, speaking of the account which was formerly published, of the volcanic character of the Island of Hawaii, says : " There is nothing incorrect in the account of these Islands in the American Journal, except in the spelling of a very few words, such as names of places, &c. I gave you in my letter of April 25, 1825, a short account of my tour through the interior of the island, from Kailua to the volcano, and from thence to Byron's Bay. The interior of the Island presents to the traveller the same dreary mass of lava, that is to be seen in most parts of the island. Mouna Roa appears to be but one huge pile of lava, estimated at about eighteen thousand feet high. In some places I have observed the fragments of lava forming something resembling the sandstone of the coarsest kind ; the particles varying in size from that of fine sand to that of massy rocks, the angles of which appear to have been worn off by attrition. Some of the strata of lava are horizontal ; others vary in their position from that to an elevation of eighty degrees. They are in every shape that one can imagine possible ; nor can I adequately describe the appearance of lava, so that you can form any correct apprehensions of the picture it presents. The horizon-

tal strata vary from a few inches to hundreds of feet in thickness ; next above one of these strata is seen a space from one to ten feet wide, or high, that appears to have been in a state of fusion long after the mass above and below had become consolidated, in which forms it may be seen alternately for hundreds of feet high, shewing caverns and fissures of all forms and sizes ; some not unlike a common oven externally, but much more spacious within, many of which were formerly used as repositories for the dead, especially when they were difficult of access. The volcano, of which I have made frequent mention, was measured by a surveyor of lord Byron's, and estimated to be nine hundred and thirty-two feet down to the black ledge, and four hundred more down to the bottom ; in all, thirteen hundred and thirty-two feet, so that you may form some judgment of the dimensions of the crater ; the depth of a place that we supposed, on our first visit there, to be four hundred feet, is found, by measurement, to be nine hundred and thirty-two. Many times have I wished that you could accompany me to that wonderful scene."

*Remarks on the specimens transmitted by Mr. Goodrich.*

They contain most of the usual volcanic products, and are remarkably interesting.

1. *Sulphur*, of all the shades between white and yellow ; the more delicate specimens, mentioned as being in the coconut shells, are pieces of sulphur. In the collection are numerous crystals of sulphur, more remarkable for delicacy and richness of color, and finish of form, than for size. The sulphur is found also investing or penetrating the proper lava.

2. *Siliceous sinter*, white, porous, light, tasteless, harsh to the touch, readily scratches glass—resembles that of Ireland and the Azores. Mr. Goodrich remarks, that the white specimens are from the bottom of the crater ; if he means these, as he probably does, may we not presume that the siliceous matter, dissolved in water, probably containing alkali, and heated intensely under great pressure, was liberated when the water was rapidly evaporated, and thus the siliceous matter was deposited in a spongy form, as the steam and gases made their way through it.

3. *The fragments resembling rocks*, consist of quartz, glassy feldspar, augite, hornblende, mica, and olivine, more or less blended, and mutually adherent, so as to form solid masses. It is impossible to say whether they are the products of re-crystallization after fusion, or whether they are ejected fragments thrown out from the primitive rocks, lying beneath the bed of the Pacific. They have a strong resemblance to some of the masses ejected by Vesuvius, and perhaps it is most probable that they are types of the rocks, in which these subterraneous and submarine fires of Kirauea are fed and sustained.

4. *Among the solid masses are some that very nearly resemble varieties of the Trap Rocks, basalt, and green stone, &c.* and if there had been no mistake in associating them with the lava, and other decided volcanic products of these Islands, they would go decidedly to sustain the igneous origin of the trap rocks.

Mr. Goodrich has expressed this opinion very clear in his letter, Vol. XI. p. 2.

5. *Obsidian*, very brilliant, black and heavy. It is rarely quite free from incipient vesicular cavities, which, on the one hand, graduate into those that are palpable and large, and in the other, becomes evanescent in the solid substance, or are discovered only by the microscope.

6. *Olivine*, imbedded in large and small masses; when viewed with a magnifier, it is brilliant and beautiful, with a delicate wine yellow color, resembling, in this respect, the Saxon topaz; it appears to be very abundant in the lava of Kirauea.

7. *Augite* is probably still more abundant, for the melted materials often exhibit decisive proof, in the black color, and great weight and firmness, of having resulted extensively from the fusion of this mineral and hornblende, and there appears to have been a large proportion of iron present.

8. *Scorie* in vast variety, and in every state of inflation, from those pieces that are just beginning to pass from the condition of obsidian, and compact lava, into the vesicular

form, to those that are blown up into innumerable cavities, scarcely connected by the thinnest partitions, like the membranes between the air cells and blood vessels of the lungs, and having vastly more pore and space than solid matter.— In many pieces, the cavities are so large, that the thumb is easily introduced, and we perfectly understand how to conceive of those volcanic caverns described by Mr. Goodrich and the other Missionaries, and which are occasionally large enough to be used as cemeteries, or as refuges from hostile pursuit, or as habitations. Similar caverns in lava are numerous, as is well known, in the Azores, and in Iceland, and other distinguished volcanic regions.

Among the cavities in the vesicular lava of Kirauea, there is the most beautiful exhibition of colors that can be imagined. The surface is glossy, as if covered with the most perfect enamel or varnish, and the iris and columbine hues are richly displayed by every change of position. This splendid effect is undoubtedly due, chiefly, to the large dose of iron, and the very perfect manner in which the intense heat has blended its oxides with the other materials.

9. *Fine spun volcanic glass.*—This exists sometimes in masses which are scarcely coherent, and seem like what they evidently were originally, congealed froth and foam, the floating scum of igneous fluidity. Their color is like that of olivin.

The most interesting form is that of fine filaments, resembling spun glass, bundled together in confused masses of incoherent fibres. Among them are portions of a dark color and firmer texture, of a tadpole shape, and very strongly resembling Prince Rupert's drops; only they are much smaller, and the fracture of the bulbous part which takes place on breaking the stem, seems to result more from a crushing, than an explosion of the mass; so that we cannot say that they are formed like Prince Rupert's drops; doubtless the bath in which they were suddenly congealed was air, although it is possible, that water might have been, at least in some cases, concerned. It is this filamentous glass that is mentioned by Mr. Goodrich in his letter, (Vol. XI. pa. 2.) as being blown away by the winds and carried to the distance of many miles from the volcanos.

It very strongly resembles some of the capillary products of the great iron furnaces. I have some which I obtained from those of Salisbury in Connecticut, which could scarcely be distinguished from this volcanic glass.

10. *Igneous stalactites.*—These, which the missionaries have so well described, as falling from the currents of lava and congealing either in the caverns, or on the lips of projecting precipices, are perfectly intelligible from inspecting those transmitted by Mr. Goodrich. They are sometimes tolerably regular cones; at other times, twisted, protuberant and convoluted in various fantastic forms, and exhibit in their black glassy surfaces, most legible records of the effect of fire.\*

It is obvious on inspecting the lavas and various products of this, *the most stupendous and magnificent volcano on our globe,*† that its products have undergone the most powerful effects of volcanic heat; every fragment (those alone, resembling the primitive rocks, being *perhaps* excepted,) being replete with the records of fire.

Indeed how can it be otherwise! Kirauea is evidently only the chimney of that vast furnace of fire, which is in ceaseless activity beneath the bed of the Pacific ocean, and whose seat is many miles below the crater. These submarine volcanos have, probably by accumulation, raised many of the Pacific islands from the bottom of the ocean: the same tremendous agent may hereafter blow some of them to atoms, and scatter their fragments among the trade winds; and other islands may, and probably will hereafter rise, where navies now plough the ocean, without encountering a rock.

\* A magnificent specimen of stalactical lava has been loaned to me by Major Howard, boarding officer of New York. It came from Hawaii, and is reported to have belonged to Capt. Cook. It is larger than one's head, and in form it is not unlike a pine apple, only the scales are represented by convoluted and interwoven ropes of lava of a bronze color.

† See the descriptions, Vol. XII. of this Journal, especially that of the Rev. Mr. Stewart.

II. MR. MACLURE'S LETTER.

*Remarks on the igneous theory of the earth, in a letter to the editor from William Maclure, dated Jalapa, Mexico, February 3, 1829.*

*Dear Sir*—Although M. Cordier sent me his essay upon the temperature of the interior of the earth, being at Harmony when it arrived at Philadelphia, I had not seen it, until I read the analysis of it in your Journal of October last. As in the pendulum, motion proceeds from one extreme to the other, so it seems that our moral faculties, as well as our physical appetites, must be stimulated by something extra, to afford pleasure, or satisfy curiosity; not having lately attended to the process of fire against water, I was a little surprised at the magnitude and respectability of the proofs of the existence of this immense reservoir of melted matter, occupying the earth's centre, with all the operations of the molecules of heat perpetually radiating from it; my limited experience in the chopping of rocks, having almost convinced me that the two agents, fire and water, had been alternately at work, in covering the primitive, as I thought I could discover rocks, with the volcanic characters, alternating with the transition, secondary and alluvial. Perhaps, when any phenomenon can be accounted for by visible causes, subject to the evidence of all our senses, the inventing of mysterious and hidden agents to account for them, rather augments than removes the difficulties, in which nature has veiled all her actions. The common opinion of mankind, that the sun is the evident cause of the heat of the earth, seems to agree with all experiments made by Perone, Phillips, and others, on the temperature of the ocean; (as you may see by some memoirs read before the French Institute by Perone, to be found in the Journal de Physique,) proving that heat decreased in the exact ratio of the distance from the surface, until even under or near the equator, the thermometer descended to two degrees above freezing, which, if I recollect well, corresponded with some experiments made on the waters of the lake of Geneva, and had induced me at one time to attempt experiments on our lake Ontario, but which I never had an opportunity of trying. At the time those theories

were pushed so far as to lead philosophers to suppose the ocean to be frozen at a certain depth, which perhaps would account for the vast masses of ice, of all figures and dimensions, that the currents bring from the north, along the coast of Newfoundland, during the end of February, and the month of March, at least three months before the breaking up of the winter in those latitudes, for which I could not assign any feasible cause. The diameter of the earth at the poles being less than at the equator, brings the imagined central mass of melted metal nearer to the poles, with its perpetual radiation of molecules of heat, which would prevent the freezing of the earth to the depths, as experienced by Hearne and other travellers, who found it difficult, even in summer, to prevent water from the earth being frozen at the depth beyond the sun's influence; how could this emanation of heated minerals proceed all in the direction of the equator, and avoid the nearer surface for escape at the poles; certainly not on the principle of radiation.

Volcanic eruptions thrown out of such a fluid mass, revolving and mixing up all its constituent parts for such a great period of time, ought to have acquired, by its constant motion, some homogeneity in its composition, which is contradicted by the variety of materials thrown out; no two eruptions being exactly alike, and the eruptions of water and cinders being so easily accounted for, on the supposition of the diminution of combustibles, and of course of heat, and increase of water in the cavities, made by the ejection of lava; where in this vortex of melted metal could either water or cinders find a place?

Werner's error, in forming the crust of the earth solely by the agency of water, ought to have warned the disciples of fire from falling into the same fault, by employing fire only, and limiting nature to the confined scale of our imaginations, which although they take an extensive range, yet cannot go beyond ideas procured through the medium of our senses; it is probable that nature has many ways of acting that our short lived experience has not yet brought us acquainted with, for it is only yesterday that we were capable either of observing or registering the natural phenomena, and much as we have lately done, an immensity remains yet to be examined.



## INTELLIGENCE AND MISCELLANIES.

## DOMESTIC AND FOREIGN.

1. *Report of a committee appointed by the Lyceum of Natural History of New York to examine the splendid work of Mr. Audubon upon the Birds of North America. May, 1829.*

It is almost five years since our associate Mr. Audubon exhibited his rich port-folio of nearly four hundred original drawings of American Birds, at a meeting of this Lyceum—Having afterwards carried his collection to Europe, the publication of them has been commenced in London, and the first volume, embracing forty nine species, is now submitted to the inspection of our society; and it will hardly be denied that it forms the most magnificent work of its kind ever executed in any country.

Every species is represented of the natural size, the Wild Turkey and the largest Eagles appearing in their full dimensions, the size of these regulating that of all the other plates. When the birds are too small to occupy so large a sheet, it is filled up either by giving several figures of the same species of different sex or age, or by introducing the plants on which the bird is usually found, and in most instances by both these embellishments. In others are represented Quadrupeds, Reptiles, or Insects, the mortal enemies, or the favorite prey, of the principal species. Thus we see in one plate, three figures of the Baltimore Oriole, male, female, and young; and a splendid representation of the Tulip tree, the pride of the American forest. In another, the graceful foliage and brilliant corolla of the Trumpet-creeper are tastefully grouped with the portraits of a numerous family of the Ruby-throated Humming-bird, and in a third the soft hues of the Carolina Dove are seen to harmonize with the no less soft and elegant *Stuartia* of our Southern States. The Rattlesnake, the Harlequin snake, the American Hare, the Squirrel, many insects, and even fishes, are brought in to give effect to the picture, at the same time that they illustrate in the most striking manner the habits and economy of the birds. These latter have been all drawn from life. We see them in their living and most spirited positions. All is activity and energy, and each is busily engaged in some peculiar em-

ployment, procuring food, rearing or nursing its young, attacking or avoiding its enemies, enjoying its prey, or preparing for its capture.

Although these elegant productions might be justly cited as masterly specimens of pictorial composition, yet they are scarcely less remarkable for zoological and botanical accuracy, being thus equally illustrative of both the great departments of Natural History. Many things there so well depicted have often come under the observation of members of this Society, who are thus enabled to judge, from the unquestioned truth of these, of the fidelity of others which they have had no opportunity of personally verifying. We see contrasted the luxuriant vegetation of our Southern and Western States in the splendid Magnolias, Hibiscus, Gelsemium, and even in the grasses of those regions, with the related species, but of stunted growth, of our more northern climes.

The work will require about fourteen years to complete it, and will then form a collection of figures such as will leave nothing to be wished for in American Ornithology. The letter press will be comprised in three 4to. volumes; two on the Land Birds, and the third on the Water Birds, now preparing for publication, and which will be delivered to subscribers without additional expense.

Although the costly nature of this work precludes its being in the possession of many individuals, yet it is hoped that all public institutions whose object is the encouragement of science or the liberal arts, may be induced to patronize it: and your committee beg leave to conclude with the recommendation, that if it be deemed advisable in the present situation of the affairs of this society, its title be placed on the list of subscribers to Mr. Audubon's work.

2. *Proceedings of the Lyceum of Natural History of New-York.*

Continued from page 209.

JANUARY, 1829.—The President offered some observations on the doubtful fossil from the coal slate of Rhode Island, of which a cast was presented at the last meeting by *Col. Totten*. He considered it to be closely allied, if not identical, with the *Thrinax parviflora*, a specimen of which he presented from the coal pits of Somerset, (England.) A valuable collection of fossil invertebrated animals from the

neighborhood of the Ohio Falls, was presented by Messrs. Cozzens & Cooper. Dr. Eights of Albany presented specimens of a singular variety of quartz crystal, from Palatine, N. Y. One end was a regular hexahedral pyramid, while the other was globular and smooth as if fused. It is noticed in Emmon's Manual of Mineralogy under the name of globular quartz. Messrs. Cooper & Cozzens exhibited a part of a second collection of fossils from the Big Bone Lick, (Ky.) consisting of teeth and bones of the *Megalonyx*, *Elephant*, and *Mastodon*. The public Lectures for the season were arranged in the following order. Prof. Moore, on the mineralogy of the ancients. Prof. J. A. Smith, on human happiness as connected with knowledge. Mr. Featherstonhaugh, Geology. Prof. Torrey, Chemistry. Mr. Halsey, Botany. A number of valuable works were received from Prof. Buckland and Mr. Duncan, Curator of the Ashmolean Museum at Oxford, (England.)

FEBRUARY.—The committee appointed at a former meeting reported the draught of a memorial to the Legislature of the State of New York, requesting an efficient examination of the mineral formations of this State, more particularly for bituminous coal. The Report was accepted, and accompanied by the formal approbation of the Common Council of the city, was forwarded to the Legislature. At the anniversary meeting, held during this month, the following gentlemen were elected for the ensuing year.

JOSEPH DELAFIELD, President.

ABRAHAM HALSEY, 1st Vice President.

J. E. DEKAY, 2d Vice President.

JER. VAN RENSSELAER, Corresponding Secretary.

JOHN. J. GRAVES, Recording Secretary.

WM. COOPER, Treasurer.

J. E. DEKAY, Librarian.

JOHN REVERE, Anniversary Orator.

The Annual Reports of the Corresponding Secretary, Librarian, Treasurer, and Committee of Publication, exhibited a gratifying view of the present state and future prospects of the Lyceum. Drs. Eights, of Albany, and H. Gates, of Whitesborough, were elected Corresponding, and Messrs. H. Parish and O. M. Lownds, Resident Members.

MARCH.—Specimens of the *Fringilla linaria* or lesser redpoll, of which large flocks are noticed in the city, were laid on the table. Messrs. Cooper and Cozzens presented a spe-

cimen of that rare and remarkable reptile, the *Menopoma Alleghaniensis* from the river Ohio. Dr. Revere read a paper on the electro-chemical relations of iron and some other metals with a view to their application in the useful arts, more particularly in ship building. Specimens of native copper from the neighborhood of *Two Rivers* between Green Bay and Chicago, were presented by Mr. McCleary, of Michigan. Three papers were presented through Dr. Wagstaff from Dr. Graham of Glasgow. One, on the absorption of vapor by liquids, another on the formation of alcoates, and a third on the influence of the air in determining the crystallization of saline solutions. Specimens were laid upon the table of scoriae from an iron smelting furnace in New Jersey, resembling, precisely, in appearance and specific gravity volcanic pumice. Also specimens resembling the green sand of European Geologists from the lower part of the marle beds (so called) in Monmouth Co. New Jersey. Dr. Orville Brooks and Mr. Augustus Fleming, were elected Resident Members.

APRIL.—Dr. Pitcher, of the U. S. A., a corresponding member, presented a collection of reptiles and other zoological objects made by himself, at Fort Brady, on our North-western frontier. A number of books were received from Messrs. D. B. Warden and Victor Audouin of Paris. Fine specimens of the *Emys geographica*, *Trionyx muticus*, and *T. ferox*, from the river Ohio were added to the Erpetological Cabinet. Thos. Graham, Esq., of Edinburgh was elected a corresponding, and Messrs. H. McCrackan and J. Cromwell, Resident Members.

MAY.—Mr. Cooper read a report on several mammalia and reptiles sent from the N. W. Territory, by Messrs. Schoolcraft, James, and Pitcher. Mr. Cooper also read a paper on the American species of the genus *Sorex* with a description of a species supposed to be new, under the name of *Sorex exiguus*. Prof. Torrey presented a new and remarkable variety of fibrous quartz from the Rhode Island anthracite. Mr. J. L. Williams, a corresponding member, transmitted a communication upon the supposed chalk formation of Florida. An extensive suite of geological specimens from the North and South shores of Lake Superior was received from Dr. Pitcher, and a large and valuable collection of animals from Messrs. H. R. School-

craft and Geo. Johnson, from the same region. Among them were *Falco furcatus*, *F. cooperii*, *Corvus pica*, *Tetrus albus*, *Ardea exilis*, *Testudo serpentina*. Dr. Darlington, of West Chester, Penn., a corresponding member, communicated a paper entitled "Description of the *Prunus Americana*," with a drawing illustrating the same. Mr. Cooper, from the special Committee made a report on the magnificent work of Audubon upon the Birds of North America, which was exhibited at a former meeting. The President announced that he had received from Prof. Zipzer of Neusohl, Hungary, and arranged in the cabinet, one hundred geological specimens. They consist of a great variety of porphyries, trachytes, and other volcanic rocks, as well as fossils, illustrating the geology of a very interesting part of Hungary. The Corresponding Secretary read a letter from Mr. Schoolcraft, announcing his intention of visiting the Upper Mississippi, as far possibly as the Porcupine Mountains, and offering to make any inquiries the Lyceum may suggest. Information was also received of a proposed private expedition up the Rio del Norte, Mexico. The Curators were charged with the subject of both expeditions, with powers. Dr. Del Rio, Professor of Mineralogy in the College of Mines, Mexico, now present in the city, presented his *Compend of the new Mineralogical system* of Berzelius. A specimen of native gold in its gangue from North Carolina was presented by Mr. Nash.

Dr. De Kay read a paper entitled "Remarks on certain phenomena exhibited upon the surface of the primitive rocks in the vicinity of this city." The author alluded in his paper to those singular parallel furrows or scratches on the surface of rocks, having an invariable N. N. W. and S. S. E. direction, and supposed to have been caused by the agency of an overwhelming current. The writer indicated several localities where these appearances had been more particularly noted, and the paper was accompanied by diagrams illustrating the relative position of these furrows, with the direction of the stratified rocks. Mr. T. P. Allen presented specimens of proto carbonate of iron from Baltimore, (Md.) manganese from Brookville, Frederick Co. Md. and sulphuret of lead, with blende from Eaton, (N. H.) The latter containing forty ounces of silver to the ton—Mr. John I. Glover was elected a Resident Member.

3. *Memorial.*—The following memorial to the Legislature of the State of New-York was presented at the last session. A Bill was introduced in accordance with the memorial, but owing to the pressure of business it was not acted upon. Geological surveys similar to that proposed in this memorial have been authorized by the Legislatures of North and South Carolina, and of Virginia, and have developed, in no small degree, the mineral riches and resources of these States. It is to be hoped that their example will be followed by other States, and in the mean time we think the following memorial, as embodying a variety of useful facts, worthy of being more extensively circulated.

*To the Honorable the Legislature of the State of New-York,  
in General Assembly convened.*

The Members of the Lyceum of Natural History in the City of New-York respectfully represent—

That the object for which their Society was originally incorporated is the advancement of Natural Science; in the which pursuit they have steadily persevered, unaided by legislative patronage, and contributing from their individual resources, the means requisite for the establishment of a scientific library, and an extensive collection of objects in every branch of Natural History, which is open at all times gratuitously for the gratification and information of their fellow citizens and of strangers.

Your memorialists have especially turned their attention to the investigation of the mineral riches of the State, and to this effect have cultivated geological knowledge with much assiduity. They would respectfully state, that they have been long satisfied of the probable existence of bituminous coal in the State of New-York in situations and in quantities offering the strongest inducement for instituting a research for that valuable fuel, upon the approved principles derived from the Science of Geology, which teaches that all the extensive and profitable beds of bituminous coal which have been hitherto discovered and worked, are found in constant relation to, or connexion with other mineral formations analogous to those known to exist in this State.

Accident has already discovered many seams of bituminous coal in our State, but the quantity contained in them has not been sufficient to warrant their being worked, and they are only to be considered as indications of more abund-

ant beds within the reach of a skilful and vigorous research. Your memorialists are free to declare, that such is their confidence in the numerous indications which are presented, and so strong are their desires to develop a resource of such magnitude to the State, that if they possessed adequate means and were authorised to carry on the requisite investigations by a set of careful borings in the appropriate strata and otherwise, they would not hesitate to employ them, but as has been before stated, they possess no funds to apply to so valuable a purpose. That it is of the utmost value, it would be superfluous on this occasion to attempt to prove. The new branches of industry that would ensue upon the opening of coal mines in the western part of the State; the arrestation of the rapid destruction of wood fuel; the abundance and cheapness of the finest qualities of coal for domestic and manufacturing purposes; the augmentation of canal revenue for its transportation; the stoppage of the present supply from abroad and the exportation of it from our own State; all these circumstances are of obvious and immediate application to the reasonableness of the proposition, that no further time should be lost in commencing the investigation.

In respect to the present supply from abroad, your memorialists conceive that they would not do justice to the subject, if the following statements, which they are enabled to make from what they deem sufficient authority, were withheld.

During the seven years preceding the year 1828, and including the years 1821 and 1828, five million seven hundred and ninety-four thousand one hundred and sixteen bushels of bituminous coal were imported into the United States, the whole of which might as well have been furnished from the coal districts of this State and supplied by the coasting trade from the port of New-York. But this great amount is inconsiderable when we look at the consumption which an increased population and a reduction of the price would in a very short time effect. It is estimated that about eight hundred million bushels of bituminous coal are raised annually for general purposes in Great Britain.

As to the present annual consumption of coal in this city, the following approximation may be considered as not far from the truth.

English and Scotch bituminous coal,	chaldrons, 20,000
Virginia,	20,000
Lehigh and Schuylkill Anthracite,	16,000

The average price in the New-York market is \$8,53 per chaldron of thirty-six bushels, making a gross sum of \$478,000 per annum paid out of the State for coal in the present amount of population. The quantity of Rhode Island coal consumed cannot be accurately ascertained; but it is thought not to exceed 4000 chaldrons at an average of \$6,50 per chaldron.

The annual consumption of wood fuel in this city may be considered as amounting to 280,000 cords, and it is stated in a publication recently made, that the steam vessels which ply from New-York consume annually more than 200,000 cords beside. Valuing the whole 480,000 at \$5 per cord, we have a gross amount of two millions and four hundred thousand dollars annually expended for wood fuel. It is universally known that this article is becoming scarce, and with a population rapidly pressing upon us, the substitution of coal is the only measure that can save us from the inconvenience of a scarcity of timber.

In bringing these important facts and general views before the Legislature, your memorialists have been solely governed by the desire of making the sciences they cultivate, conducive to the advantage of the country; and they respectfully hope not to be deemed obtrusive if they express a confident expectation, that the Legislature will take the subject into consideration and make provision by law for a practical and efficient examination of the mineral formations of this State for bituminous coal.

And your memorialists will ever pray.

Signed JOS. DELAFIELD, *Pres't. &c.*

Lyceum of Nat. History of New-York, }  
February 2, 1829. }

4. *Gold mines of North Carolina.*—This remarkable locality of the most precious of the metals, continues to attract an increasing share of public attention; and the territory of the "Gold Country," has within three or four years been greatly enlarged. Until within a short period, these mines were supposed to be confined to the small county of Cabarras, in the western part of North Carolina. The neighboring counties of Montgomery, Anson, and Mecklenberg, were successively found to contain a share of the same treasure; but in 1823, the extent of the gold country was estimated by Pro-



fessor Olmsted,\* at only one thousand square miles. Since that time, successive discoveries have extended it over the counties of Guilford, Chatham, Rowan, Davidson, and over the adjacent counties of South Carolina. Indeed, very recent observations have carried it westward more than one hundred miles from the original mine of Cabarras, to the very base, and even among the valleys of the Blue Ridge. The following letter, from D. Reinhardt, Esq. of Lincolnton, in the western part of North Carolina, addressed to Professor Olmsted, of Yale College, contains the most recent accounts we have seen of the new discoveries of gold in that region.

“Lincolnton, N. C. June 4, 1829.

“*Dear Sir*—I suppose you have seen some statements in the newspapers, respecting the recent discoveries of Gold in this section of country, and will excuse the liberty I take in offering you a few additional particulars.

“In the course of last summer, an old man who had worked the mines in Cabarras, found some small parcels of gold in Rutherford county, between First and Second Broad Rivers. In the month of March last, near the same place, a few more specimens were found. Of these I purchased to the value of thirty seven dollars. Shortly afterwards, similar discoveries were made in rapid succession, near the South Mountains, and on each side of them, in the counties of Rutherford and Burke.† So well were those rewarded who searched for gold, that in a short time, all the common laborers were engaged in digging for it; and one dollar’s worth of gold to the hand per day, was thought to be only tolerable business.‡ Companies were soon formed, and lands that

---

\* See this Journal, Vol. IX.

† At the base of the Blue Ridge, on the east, lie the counties of Rutherford, Burke, and Wilkes, in each of which the face of the country is very uneven, being traversed by numerous spurs of the Alleghany mountains. The county of Lincoln lies still farther east, and is less broken, but is remarkably distinguished for the abundance, variety, and excellence of its iron ores, which are, to some extent, manufactured into castings, and bar iron. The South Mountains above mentioned, are seen on the west, from the village of Lincolnton, presenting a grand and interesting outline. All the foregoing counties lie westward of the Catawba river, beyond which it was not supposed until recently, that the gold country extended.—O.

‡ This amount is obtained by merely collecting the earth in small parcels, and washing it by hand.—O.

would not bring one dollar per acre, were sold as high as thirty dollars.

“The gold is got out of the small streams, and is called “Branch gold.” Digging is generally commenced at the bed of the streams, and continued on each side to the adjacent hills. After the top earth and sand are removed, round flint rocks (quartz?) are found, such as usually occur in the bed of streams.\* Among this earth and sand, the gold is found in particles from a very small size, to masses of two penny weights. I understand it was thought that no gold was to be found below this deposit of pebble and flint rocks; but lately, after penetrating the layer of flint stones and pebbles, the miners came to a bed of very fine sand, varying in thickness from six to twelve inches, and below this another deposit of *round flint stone* and *pebbles*, which is more abundant in gold than the former.

“The quantity of the precious metal collected since the first of March, cannot be accurately ascertained; but two weeks ago, about one thousand hands were at work, averaging each a dollar per day. New discoveries of gold are daily making in this county, (Lincoln,) but our mines have not as yet proved so rich as those of Rutherford and Burke before mentioned.

“Quicksilver has been found connected with the gold. I had doubted this fact, though it had been repeatedly asserted; but this day, a man who can be relied on, and has worked at one of the mines in Burke, shewed me a small quantity of quicksilver, which he asserted that he obtained at that mine.†

“Many exaggerated reports are put in circulation respecting the value of the gold mines, with the view of enhancing the price of land within that region; but so fair are the real motives for enterprize, that many of our most prudent and wealthy citizens are making arrangements to enter largely into the business. So eager are people to find large pieces of gold, that they hurry through the process of washing in a

---

\* That is, probably, exhibiting the appearance of having been worn by attrition—shewing that this peculiarity marks the deposit of gold here, as well as in Cabarras. (See “Olmsted on the gold mines of N. Carolina,” in this Journal, Vol. IX.) The account here given, by a gentleman not at all interested in the theories of these formations, appears to favor the opinion that they are deposits from water, and not merely, (as Professor Mitchill has maintained in a late Volume of this work) the result of a decomposition of the associated rocks.—O.

† Probably this was not of native origin.—O.

very wasteful manner. It is even thought that the earth which has already passed through their hands, would, by careful management, yield another product as great as that which they obtained in the first instance. Very little of the dust is collected, nor is the business reduced to any system. We have great need of a few ingenious Yankees, to invent labor-saving and economical machines for us.”

5. *Pettengill's Stellarota*.—The Rev. Amos Pettengill of Salem, Conn., has contrived a very ingenious instrument for the use of students of astronomy, to which he has given the name of THE STELLAROTA. It is in fact a *moveable planisphere*, and affords, at a very cheap rate,\* many of the facilities for studying the heavenly bodies, usually supplied only by celestial globes.

Celestial *maps* are apt to produce much confusion in the mind of the young learner; and since the appearance of the heavenly bodies, which they represent, does not correspond to their actual position at any given time, his progress in studying the constellations is little aided by them. On the contrary, the celestial *globe* is capable of such an adjustment, as to bring the stars, as delineated on its surface, to correspond with the actual appearance of the concave, at the very moment when he is viewing it. Various astronomical problems also of the most instructive kind can, as is well known, be performed on the celestial globe, which cannot be wrought on the common maps or planispheres. But the stellarota is capable of being adjusted to the time and place in the same manner as the globe, and affords the means of solving nearly all the problems that can be wrought on the latter.

This instrument consists of a disk or circular card seven and a half inches in diameter, fixed into a circular opening of the same dimensions, cut in a thin rectangular slab of wood. The disk is turned on its axis by means of a thumb-piece attached to the centre on the back side of the slab. The centre of the card representing the projected pole of the earth, the various circles and constellations of the spheres, take their respective stations around it. In order to understand the manner in which these are severally laid down, let us take an *orange*, and mark on its rind circles representing

---

\* The price of the instrument neatly framed, does not exceed two dollars.

those of the sphere, namely, the meridians, the equator, the ecliptic, &c., and let us inscribe in their respective places the leading constellations. Let us now cut off the end of the orange next to the south pole, for the space of forty degrees from it, and making the necessary incisions, (as is usual in peeling an orange,) let us double back the respective portions of the peel, so as to form them into a circle surrounding the north pole as a centre. The various circles and constellations before inscribed, will now occupy their appropriate places on the circle, constituting in fact, a projection of the surface of the sphere, north of  $40^{\circ}$  south latitude, on a plane parallel to the equator. If we reflect upon the position which each of the inscribed objects would take, we shall perceive that the north pole would occupy the centre; that the meridians would be projected into straight lines proceeding in radii from the centre; that the equator would be projected into a circle, described at the distance of 90 degrees around the pole, and cut by the ecliptic at an angle of  $23^{\circ} 28'$ , on each side of which, in a belt of 16 degrees, would lie the constellations of the zodiac; that the meridians which were fifteen degrees asunder, would constitute true hour circles, and might be numbered accordingly at the extremity of the radii, or the circumference of the circle; and, finally, that when the circle was turned round on the pole, in its own plane, the sun's place in the ecliptic for the given time, being brought against the hour, (as before numbered) the position of all the various objects represented on the plane would correspond to the actual appearance of the skies at the same moment.

Such is, in general, the plan on which the stellarota is constructed, and so far the construction appears to be extremely simple and easy. But a greater difficulty presented itself in devising means to represent the horizon corresponding to any given place, since every different parallel of latitude, would seem to require its own horizon to be represented on the plane of projection. To recur again to the orange, let us see how the horizon of the equator, of the parallel of  $45^{\circ}$  N. L., and of the pole, would severally arrange themselves, as we *double back* the rind into the plane of projection. The horizon of the equator being, or coinciding with, one of the meridians 90 degrees distant, and all the meridians being projected into straight lines, this horizon would of course be a straight line cutting the meridian of the place at right an-

gles. The horizon of the pole being the equator itself, it is a circle coinciding with that which represents the equator. The horizon of the parallel of 45 degrees, being oblique to the plane of projection, would be projected into an ellipse, which would come nearer to a circle as the place to which it belonged approached the pole, and nearer to a straight line as the place approached the equator. The inventor has adopted a very ingenious contrivance to represent truly all these different positions of the horizon. The method however, cannot be rendered very intelligible without the aid of a drawing, or without reference to the instrument itself. It consists, substantially, of a small brass wire, coincident with the equator when the horizon of the pole is represented, but moveable southward for any other place, at the same time being made by compression to assume an elliptical figure, and thus including, in every situation, the part of the heavens which is visible at each place respectively. We cordially recommend this little instrument to the attention of preceptors of academies, who are not already furnished with a celestial globe, and especially to private learners, who will find in it a most useful guide and auxiliary; and it is with the view of rendering its construction and principles intelligible to such of our readers as may procure it for their own use, that we have been thus particular in our description of it.—O

6. *Of the precipitation of morphia from laudanum by ammonia; also a spontaneous deposition of narcotin; by R. HARE, M. D. Professor of Chemistry in the University of Pennsylvania.*—I believe it is not generally known that the addition of ammoniated alcohol, to common laudanum, will cause a crystalline precipitate of morphia in the course of a few hours. If the precipitate thus obtained, be dissolved in acetic acid, again precipitated by ammonia, and afterwards collected and dried upon a filter, the morphia will be obtained nearly white, and may be rendered perfectly so, by repeating the solution by acetic acid, and precipitation by ammonia. I have by these means obtained thirty grains of morphia from an ounce of opium.

Instead of alcohol impregnated with ammoniacal gas, a mixture in equal parts of strong aqua ammonia and common alcohol will answer.

Narcotin is I find sometimes spontaneously precipitated in a crystalline form from a solution of opium in proof spirit.

The circumstances under which I procured it are nearly these. A quarter of a pound of opium was boiled in a quart of proof spirit, and strained while warm through a coarse cotton cloth. The solution, thus obtained, being allowed to stand for about twenty four hours, crystals were observed to be spontaneously deposited on the sides of the containing glass jar. These being dissolved in acetic acid, on the addition of ammonia a precipitate took place which was collected by a filter, and dried. Narcotin was thus obtained in the form of white, beautiful silky crystals, which were readily soluble in sulphuric ether.

When we consider how often opium has been dissolved in proof spirit by chemists and pharmacopists, it is surprising that crystalline principles so easily evolved, as are morphia and narcotin, by the process above described, should have escaped observation until lately, when Sertuerner by a much less obvious route had the honor of discovering them.

7. *An account of an extraordinary explosion, arising from the reaction of nitric acid with phosphorus; by the author of the preceding article.*—In the winter of 1827–8, having made some unusually strong nitric acid, (above 1.5 in specific gravity,) I proceeded, with more than usual caution, to arrange the apparatus for exhibiting to my class the reaction between it and phosphorus. A tube, about seven eighths of an inch in diameter, closed at one end, was placed within a stout hollow glass cylinder, of about three inches diameter, of which the glass was nearly three eighths of an inch thick. The whole was situated about four feet in the rear of my table. About five grains of phosphorus, in two or three lumps, was thrown into about as much of the acid, as occupied the tube an inch and a half in height. Very soon afterwards there was a flash, followed by an explosion, like that of gunpowder, and the fragments of the glass cylinder as well as of the tube were driven in all directions so as to break many glass articles at the distance of from five to twenty feet, and to wound slightly some of the spectators. After my lecture was over, I repeated the experiment, with a smaller quantity of materials, when an explosion again took place proportionably violent. It fractured the containing tube, but did not break a stout glass cylinder by which it was surrounded. I have been accustomed annually to exhibit to my class the combustion of phosphorus in nitric acid, and I have, on dif-

ferent occasions, known the phenomena to vary much in activity; having in some instances seen the phosphorus thrown up against the ceiling of my laboratory. It was therefore known to me, and I presume it is generally known to chemists, that the reaction of the substances employed in the case above mentioned is liable to become explosive. Accordingly in giving directions for making phosphoric acid by means of nitric acid, the necessity of a very cautious and gradual addition of the phosphorus is usually mentioned, but that an explosion so violent as that which I have described, could arise, under the circumstances in question, I was not led to apprehend, either from my reading or experience.

I ascribe the result to the extraordinary strength of the acid employed, probably caused by using in the evolution of it from nitre, one half more of sulphuric acid than the equivalent proportion, with a view of rendering the residuum less difficult to remove from the retort. The presence of an excess of sulphuric acid, reduces the water in the nitric acid to a minimum.

#### REMARKS BY THE EDITOR.

I am pleased that the above facts and cautions have been communicated by D. Hare to the public; and it may perhaps, add to their effect, if I state, that I saw a similar explosion at a public lecture of Dr. Woodhouse in Philadelphia, in 1803 or 4, and also at one of Dr. Pearson in London, in 1805: the burning phosphorus was thrown about, and as the occurrence was unexpected to both gentlemen, they apologised to their hearers for the explosion.

I will here give an extract from the MS of my Chemical Text Book, now in the press.

“Phosphorus is converted into phosphoric acid by the action of the nitric acid: if weak, it merely boils, with red fumes of nitrous acid; if very strong, and especially if warm, it burns with a splendid combustion: it is thrown about in jets of fire, and requires great caution: to render it the most beautiful, a tall narrow deep vessel should be used, but when the quantity of both substances is considerable, there is sometimes a dangerous explosion.”\*

---

\* This circumstance has happened so often, in my own experience, with nitric acid distilled from very pure nitre, and *without any water in the receiver*, that I cannot but repeat the caution that the operator should be much on his guard. With a stick of phosphorus as long as a finger, dropped into two or

8. *Collections in Natural History.*

Extract of a letter to the Editor, from Professor John Torrey, dated New-York, June 17, 1829.

*My Dear Sir*—I take the liberty of sending you a printed Circular, which a number of gentlemen of New-York, devoted to Natural History, have had prepared, in order to obtain subscribers, towards a project, which will be sufficiently explained by the paper itself. About forty-five shares have been taken up. The gentleman alluded to, (Dr. Gales,) has accepted the appointment of Collector to the Association, and has already reached New Orleans. A letter received from him a few days since, states, that owing to the lateness of the season, he has been advised not to proceed to Natchitoches until next spring. He will therefore ascend the Washita to the Saline, in Arkansas, where he will take up his summer residence at the house of Judge Franklin, a former member of Congress—also one of the Legislature of Louisiana. This gentleman resides about eighty miles from the junction of the Saline with the Washita, in a little settlement consisting of thirty families. This place will be the centre of his excursions during this summer, whence he will proceed at different times to the Little Missouri, Cadeau, up the Washita to the Hot Springs, and across the Three Forks of the Saline, to the Kettle Rock, on the Arkansas. Dr. G. has collected a considerable number of plants and animals, in the neighborhood of New Orleans, and remitted them to New-York. There is every prospect of his succeeding to the utmost of our wishes, in the object of his mission. We need a few more subscribers to our funds, and, perhaps, by inserting our Circular in your Journal, we might receive some additional names. It would be desirable to retain the present collector in the interesting regions to which he has been sent, for a longer term than a single year, and if sufficient encouragement is given to our project, we propose to extend our contract with him for the spring and summer of 1830. Persons desiring to take shares, can address Mr. William Cooper, Capt. Le Conte, or myself, on the subject.

---

three ounces of strong nitrous acid, I have known an explosion like that of a swivel, and the fragments of glass wounded persons at a distance, although the experiment was performed out of doors, and the spectators, formed into a ring, were, none of them, nearer than fifty feet, and some who were hit were at double that distance.



## CIRCULAR.\*

New-York, March 2, 1829.

*Sir*—Several gentlemen in this city have formed an Association for the purpose of sending a suitable person to collect objects in Natural History in some of the more remote parts of the United States; to which you are invited to contribute, provided the plan meets your approbation.

The route to be taken is the following:—From New-York, by sea, to New Orleans; thence to Red River; remain at Natchitoches until July; then proceed to the Arkansas Territory, and if the country should be healthy, proceed up the Arkansas River as far as possible; should any time remain before the setting in of cold weather, examine the country between that River and the Missouri. At the beginning of winter, descend the Mississippi, and make collections in the lower parts of Louisiana, the farther south the better. Early in the spring, return through Mississippi, Alabama, Georgia, and the Carolinas.

Collections are to be made in the department of Botany, (dried plants, roots, and seeds,) animals of all kinds, (except those common in the Atlantic states,) particularly birds, insects, and shells; and geological and mineralogical specimens.

The collections, when received, will be divided by the subscribers, or their proxies, into as many parcels as there are shares subscribed for, with the addition of two shares for the Collector, all the parcels being made equal in value, and distinguished by a number. Lots will then be drawn for them. In case any subscriber who wishes plants only should draw animals, or vice versa, he can exchange the one with the other with some other subscriber.

Shares are fixed at \$10 each. The expense of the journey for one year, exclusive of transportation of collections, is estimated at \$600. Dr. H. GATES, a gentleman well qualified, is engaged, and will depart about the 15th of March, provided forty shares shall have been then subscribed for.

Please reply to this as soon as convenient, stating the number of shares wanted, and the name of the person resident in this city, who is to act as your proxy. Direct to *John Le Conte*, *John Torrey*, or *Wm. Cooper*, at the Lyceum of Natural Hist.

9. \**Carpenter's Saratoga Powders, for making Congress Spring or Saratoga Waters.*—There is perhaps scarcely an

\* Inserted by request.

individual in the United States who is not acquainted, either by experience or report, with the salutary effects of the Congress Spring Water at Saratoga. From thirty to fifty thousand persons annually visit these springs, many from the remotest sections of the United States, and some from the West Indies, and other foreign places. The great expense in visiting the Springs excludes the greater portion of the community, (more than nine out of ten,) and the bottled water, from its high price, prevents its use to the extent of being serviceable, and confines it to a small number; it appears to be a serious evil that so valuable an article should be so restricted that comparatively few should be able to enjoy what is so conducive to general health in the hot weather of our summer months. From these circumstances, George W. Carpenter is pleased to announce the preparation of the above powders, containing all the essential substances with which these celebrated Springs are impregnated, and from which the waters of the Congress Springs at Saratoga are precisely and effectually imitated. With a view to accommodate the public, and to bring into general use so convenient and valuable a substitute for these waters, he has been induced to go very extensively into the manufacture of them, and to put them at a price to be within the reach of most persons. For the accommodation of the public, agents will be appointed in all the cities and principal inland towns to give a general circulation to so useful an article throughout the country. The public are recommended to make trial of these powders, as he finds by experience, and from the opinion of the most eminent of the faculty, that the water made from them possesses the same medicinal qualities, is as effectual in its operations, and precise in taste, as that immediately taken from the Springs. These powders are therefore recommended as a valuable remedy in all cases where the Saratoga Waters are prescribed.

Persons on sea voyages, or residing at a distance from the Springs, and in warm climates, will at once perceive the great advantage of making use of these powders, which besides being more portable, and less expensive than the bottled water, will keep without injury for any length of time; and as they are equal in medical effect to that taken fresh from the Springs, they are certainly much preferable from the many advantages they possess.

No. 301, Market street, Philadelphia.

10. *Dr. Wollaston's scale of chemical equivalents.*—We have already mentioned that an improved edition of this very useful instrument has been published in this country by Professors Beck and Henry of the Rensselaer school: it appears that still another edition is about appearing at Middletown, Conn.

Messrs. *Hedge & Co.* of that place, have just commenced the manufacture of Wollaston's Scales. The one before us, says a writer in the *American Sentinel*, is the most finished specimen of workmanship of the kind we have ever yet seen; and the first attempt in box wood, to our knowledge, in this country. The scale is 21 inches in length, by 3 and 2-10ths in breadth.

The graduation is done by machinery, and is executed with a degree of beauty and accuracy we have never seen equalled by any thing of the kind.

Those who are acquainted with the use of rules, know how difficult it is to obtain such as are accurate. Mr. Hedge, by means of his machinery, is enabled to make the best rules in this country, and they are, in consequence, highly esteemed by all competent judges.

Great care has been taken in the plan of arrangement of the chemical substances. The elementary bodies, metals, and metallic oxides, are arranged on one side of the slide, by themselves—the names of the metals are printed in larger type, which adds not only to the beauty of the scale, but renders it much easier to find their respective places.

With regard to the representative numbers of the chemical substances, the greatest care has been taken in consulting the latest tables of Drs. Henry, Thomson, and others so as to correct the errors of former tables.

The scale, thus improved, was made at the suggestion and under the superintendence of Doct. J. Barratt.

Uniformity in the scales can be depended upon because the graduation of the line of numbers on the slide, is done by machinery. The names are printed upon the scale with moveable steel types, and therefore advantage can be taken of any improvements; or any list of names can be printed, to suit the particular wishes of chemists.

We may remark farther, that Messrs. Hedge & Co. have been engaged some time past in the manufacture of gunter's scales and carpenter's rules, of every description. The apparatus for effecting the graduations, is of a novel and

ingenious kind, and is the invention of Mr. Hedge. So superior are the scales made at this establishment, that they are fast gaining, if they have not already acquired, the entire ascendancy in the market.

There are none manufactured in this country or elsewhere, that can compare with them, either in cheapness, in style of finish, in the number of subdivisions, or in accuracy of graduations. We speak with more confidence of the superior accuracy of these scales, as we have *thoroughly tested* them in practice, and we *know* that the method of execution is such as to insure the greatest uniformity in all that are constructed.—(*Communicated.*)

11. *Notice of a projected improvement in the method of blasting rocks, making tunnels through mountains, &c. with the result of some preliminary experiments—in a letter to the editor from a correspondent, dated New York, June 2, 1829.*—The projector conceives that a block of several tons might be separated from a large mass, at once, by making five or six blasts, tending like radii, towards the center of the block; all the charges being fired at the same instant; but, as this cannot be accomplished by trains, he proposes to mix detonating silver with the gunpowder, and to apply it in the following manner. The holes being bored, he places a cork upon the charge of powder, through which he passes a double wire, whose ends nearly meet, in a small cylinder of glass filled with a compound of gunpowder and one tenth of detonating silver; the wires are secured in the cylinder by bees wax. Thus prepared, he lowers the cork and wires down till it meets the charge. Now supposing all the borings thus charged, he puts about an inch of powdered rosin upon the corks, and fills the remainder of the holes with melted rosin. Then connecting one of the wires of each hole with the outside coating of an electrical jar, the others are so joined as to receive the spark, which produces an instantaneous explosion of the whole. He has tried this method in wood, by boring augur holes, one in each of five logs, and it answers his expectations.

By leave of the corporation, a trial has been made at Blackwell's island, where they are blasting rocks for the new Penitentiary. Five holes, each three feet deep, were made by the prisoners, at the distance of seven feet from each other,

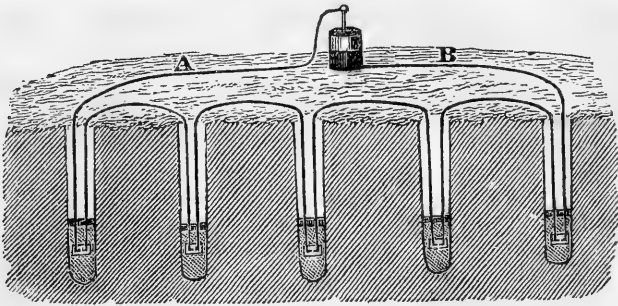

forming a line. The extreme wire, A, connected with the inside of the jar, and the other extreme, B, with the outside, show the circuitous route of the influence after the knob of the jar was touched. The report was simultaneous, but owing to the wires of two of the interior holes crossing and touching each other, they did not explode. The rock was cracked but the portion was not thrown off. The gentleman thinks that if these two holes had exploded, the full expected result would have been obtained; but perhaps the melted rosin is not the best thing to be poured in the holes, as it would shrink on cooling, and if so, it would be like a loose cork, having little hold of the rock. I advised him to fill up with sand, in Jessop's manner, and, from a trial made to-day, it promises to answer. The iron wire, being a much better conductor than sand, the latter did not seem to divert the influence at all. He has gone to the island to prepare a more magnificent experiment, the result of which I shall hasten to communicate to you.\*

12. *Mode of decoying wild pigeons in New England.*—The flight and stool pigeons, as they are called, are prepared by passing a thread through the edges of both their eyelids which are thus closed—their legs are booted, and the flights, being fastened to long strings, are thrown into the air, and fly as far as they are permitted, while the stool pigeon is tied to a narrow board, which, at the end where the bird is fixed, rises and falls, and both kinds of decoy, by the flapping of their wings, draw the attention of the passing flocks of wild pigeons, which are thus made to alight, on prepared ground, within reach of the concealed spring-net, or on a long pole,

\* We cannot but recommend *extreme caution*, in using detonating silver, especially in such quantity as to form one tenth of the charge.—*Editor*.

rising a little from the horizontal line, so as to give the greatest effect to the discharge of the gun from the bush-house which conceals the sportsman.

The net, concealed by cut grass, is sprung by a rope which is pulled at the moment after the pigeons alight upon the prepared ground.

13. *Ohio oil stone.*—In this useful mineral this country appears to be well furnished. Professor Olmsted first directed the public attention to the very extensive beds existing in North Carolina, and whose excellent quality, we have had occasion to prove by experiment. In the last number of this Journal, page 185, we mentioned the novaculite of Lincoln and Oglethorpe counties, Georgia, and on a former occasion, that of lake Memphremagog. It now appears that the oil stone is found in Rocking county, Ohio: specimens have been presented to the Lancaster Mechanics Beneficial Society, and stated to possess a fine and uniform grain. Specimens were presented to the society by John P. Melfenstein, Esq.

14. *Report of the Chester county cabinet, Pennsylvania.*—The principal minerals of Chester county have been described by Mr. Carpenter in this Journal, and the distinguished President of the cabinet, has favored this Journal with valuable communications. The society which is forming a cabinet in Chester county, as appears by its second report, recommends itself to public favor by its zeal and activity, which, with the aid of its friends and correspondents, has, already enabled it to accumulate a considerable museum, in the principal departments of natural history. This institution appears well worthy of encouragement, and the friends of natural history throughout the United States cannot better dispose of a part of their duplicate specimens, than by sending them to this institution.

In that part of their report which relates to birds, they quote from Dr. Tinton's preface to Linné's System of Nature, the following interesting passage, relating to the instinctive wisdom of the *Loxia Phillippina*, a native of the Philippine islands.

“It constructs a curious nest with the long fibres of plants or dry grass, and suspends it by a kind of cord, nearly half an ell long, from the end of a slender branch of a tree, that it may be inaccessible to snakes, and safe from the prying intru-

sion of the numerous monkies which inhabit those regions : at the end of this cord is a gourd-shaped nest, divided into three apartments, the first of which is occupied by the malè, the second by the female, and the third containing the young ; and in the first apartment, where the male keeps watch while the female is hatching, is placed on one side, a little tough clay, and on the top of this clay is fixed a glow-worm to afford its inhabitants light in the night time."

A similar fact is familiarly known with respect to the hanging bird of this country. Its nest, formed like a purse, is pendulous from the high and slender branches of the trees, and is scarcely accessible in any way to invasion.

### 15. *Chalcedony.*

TO PROFESSOR SILLIMAN.

New York, January 9th, 1829.

*Dear Sir*—Mr. John C. Thomson, of Brooklyn, has handed to me a specimen of chalcedony, to be forwarded to you, for your mineralogical cabinet.

It came into his possession a few years since, from the ballast of a vessel. He does not recollect what port she arrived from, and of course cannot assign to the stone a geographical location. Yours, very respectfully,

J. M. ELY.

The above remarkable specimen is a geode, of from six to eight inches in diameter, lined with blue, white, and grey chalcedony, in mamillary, and botryoidal, and stalactitical concretions. It is indistinctly agatized, and altogether presents a remarkable appearance. It has evidently been an imbedded specimen, and we should not hesitate to say, that it was probably derived from a trap rock, (the most usual repository of chalcedony,) were it not that there is no portion of this kind of rock adhering to its outside ; but, on the contrary, it seems to have been enclosed in madreporé coral, with which a good deal of the exterior surface is thinly covered. This makes us the more regret that its locality is unknown, as such an association, if not novel, is singular. Perhaps it may have proceeded originally, from a trap rock near the sea, whose decomposition may have allowed it to fall into the water, where coralline animals may have constructed their cells around it, and it may have been again detached by de-

composition or violence, and thus obtained for a ballast stone. The surface of the chalcedony is somewhat clouded, as it has been long subjected to the action of sea water.

16. *Uniform nomenclature in Botany.*—A correspondent who writes from Georgia, under date of February 26, suggests, that a Convention be called of one person or more, from each State Medical School, or Botanical Society, in the United States, to some central place; and that they adopt, after the manner of the United States' Pharmacopeia, a nomenclature of known plants, which shall be uniform.

Our correspondent adds—The proceeds of such a work might defray the contingent expenses, and the societies might pay that of their own delegates; and to this convention may be united all literary gentlemen friendly to the cause.

It is supposed that it would "throw much light" on the science, by convening members from the different parts of the Union, who may be requested to bring all rare specimens or drawings of plants with which they are acquainted, and a liberal intercourse on the interests of science might be cultivated.

17. *Vegetable Chemistry, by C. C. Conwell, M. D. Philadelphia.*—This tract, of thirty three pages, contains an interesting exhibition of the principal facts in vegetable chemistry, whose most important proximate principles are arranged in genera, according to the element which prevails in their composition. They are called

Genus I. Carbonaria,

II. Hydrogenia,

III. Nitrogenia,

IV. Oxygenia,

V. Hydroxygenia—oxygen and hydrogen being in them in the proportion to form water.

Dr. Conwell has added a number of new vegetable alkaline principles, among which are *Quassa*, *Serpentaria*, *Columbia*, *Gentia*, *Gallia*, *Angusturia*, *Quercia*, &c. It would appear that Dr. Conwell has very materially simplified the processes by which such principles are obtained, and his researches tend to confirm the opinion, that the active powers of medicinal and poisonous plants, generally reside in some principle which is capable of being isolated, and which is in many instances so far alkaline, that it is capable of combining with acids and forming peculiar saline compounds.



18. *Group of crystals of common salt.*—Mr. Henry Silliman, of New-York, has forwarded to us, a mass of crystals of common salt of uncommon size and beauty. It is from the island of Curracoa, and was formed around a branch of wood, suspended in the cistern from which the salt water was evaporated; the cavity left by the branch is very distinct, and is two inches deep and three fourths of an inch wide. The mass of crystals is from six to seven inches in diameter; it is of a snowy whiteness, with considerable lustre, and presents about fifty distinct cubes, the largest of which are three and a half inches long. They are grouped, with salient and re-entering angles, and the assemblage of crystals has an appearance not unlike that of the large groups of the (so called) crystallized sandstone of Fontainebleau, or, more still, like the richest masses of crystals of fluor spar. The increments and decrements of crystallization are singularly distinct, and the whole forms a specimen well worthy of a place in a cabinet of crystals.

19. *Fibrous gypsum of Onondago County, New York.*—Some specimens of gypsum, recently transmitted to the editor, by an unknown hand, are thus labelled: "Found in digging a salt well, in Liverpool, Onondago County, N. Y. twelve feet below the surface, in strata of black mud, intermixed with slate stone; both above and below the strata, was found soft red rock or indurated clay, full of seams, through which the salt water passes."

These specimens are fibrous, foliated and crystallized, blended more or less. The fibrous has evidently formed thin strata or veins between layers of loose incoherent slate or slaty clay. In one of the specimens these layers alternate, in their natural connexion with the gypsum, which being white and brilliant forms a pleasing contrast.

One specimen, of a foliated structure, is blended, and still, distinctly contrasted with, a bluish green clay. In this gypsum, which is mainly white and beautiful, there are spots and veins of ferruginous quartz—decidedly red, but not so deeply stained with iron as to become opaque, like that of Compostella in Spain. The association is similar to that of the Compostella quartz, so remarkable for the perfection of the crystals; but in the present specimen the crystallization is indistinct, and there are only traces of a regular form.

The association of gypsum and salt is an established geological fact, and this adds only another instance.

We are indebted to Lockport, and other places in the state of New York, for splendid specimens of gypsum and selenite, in most of the forms found in other countries.

20. *Conchology of the United States.*—The transactions of the American Philosophical Society for 1827, contain a valuable article upon the family of the Naiades by Mr. Isaac Lea of Philadelphia; in which are described eleven new species of the genus *Unio*, and a new genus, named *Symphynota* including eight species, four of which are new. The distinctive character for *Symphynota*, is the testaceous connexion of the two valves of the shell above the hinge. Mr. Lea removes from the existing genera all the connate shells without regard to the forms of their teeth, with the belief, that should this family be hereafter remodeled, it will present only two natural genera; one having a testaceous connexion of the valves, the other dispossessed of it. He suggests that *Symphynota* will in all probability, embrace the *Hyria* of Larrck, the *Dipsas* of Leach, and the *Cristaria*, *Prisodon*, and *Paxyodon* of Schumacher, whose species he thinks, when they shall be found perfect, will turn out to be connate shells.

21. *Natural History in Canada.*—It affords us much pleasure to announce to such of our readers as may be unacquainted with the fact, of the existence of two very flourishing societies in Lower Canada, whose object is, mainly, the promotion of natural history; both of which were founded under the patronage of his excellency, the Earl of Dalhousie, late governor of the British provinces in North America. One of these, “the Literary and Historical Society of Quebec,” has already commenced the publication of its transactions, which, so far as they have come under our observation, appear both interesting and valuable in the elucidations they afford of the mineralogy and geology of those regions. The other, called, “the Natural History Society of Montreal,” from a printed report of their progress for one year, in forming collections in the different departments of natural history, promises to contribute eventually, no less for the cause of science in Canada, than its sister society.

22. *Swainson's new zoological illustrations.*—The fourth number of this beautiful and highly finished work on natural

history, has just made its appearance in this country, the first series consisting of 3 vols. royal, 8vo, is well known to the scientific world, and in the present series the able author has profited by his experience in the previous volumes.

The object of Mr. Swainson is to illustrate and describe "new, beautiful, or interesting animals, arranged according to their natural affinity." As the work has already been embellished with some of the shells of this country, and it being the intention of the author to devote a still greater space to them, the work must become peculiarly interesting to American naturalists. The admirers of natural history will find in this work the most beautiful specimens of birds, shells, insects, and fish, executed by the accomplished author himself, in a style superior to any thing of the kind which has been published in England. We sincerely wish him success in this arduous and enterprising undertaking.

23. *Cabinet of the late William Phillips*.—We have received a pamphlet of 82 pages 8vo, of which the following is the title:—"Catalogue of a rich and valuable cabinet of MINERALS; and, also, of a select CRYSTALLOGRAPHICAL CABINET, containing a great variety of curious crystals, to the extent of some thousand specimens, with drawings and measurements annexed;—the property of the late WILLIAM PHILLIPS, F. R. S., F. L. S., F. G. S., author of the "Introduction to Mineralogy;" and (jointly with the Rev. W. D. Conybeare) of the "Geology of England and Wales:"—*now to be disposed of by private contract.*" "Further particulars may be had, by application to G. B. SOWERBY, No. 156, Regent street, London, to whom communications on the subject may be addressed."

The "Notice" prefixed to the catalogue contains the following information;

"The collection of minerals, which forms the subject of the following catalogue, was in part made by a Cornish gentleman many years ago, and under very favorable circumstances: it is indebted for the remaining part, to the care and judgment of the late William Phillips, whose devotion to the science of mineralogy, during a period of many years is well known.

"This collection, consisting of select specimens, embraces nearly all the mineral substances now known, as well as very many of their almost endless varieties. It is particularly

rich in crystalline forms; and, with few exceptions, furnished its late proprietor with the numerous varieties of crystals, which are figured in the last edition of his mineralogy, as well as the plates accompanying his papers on the oxide of tin, red oxide of copper, &c. published in the Transactions of the Geological Society.

“Of British, and more especially of Cornish, minerals, the cabinet contains a large number of rare and valuable specimens; amongst which may be particularly enumerated the fluates of lime, the native and red oxide of copper, the arseniates and phosphates of copper, the oxide of tin, and many others; it contains, likewise, many very valuable foreign specimens—as a reference to the catalogue will show.

“The collection is now offered to the public, just as it was left at the decease of its late proprietor; and, together with a considerable crystallographical cabinet, will be sold entire.”

The contents of this uncommonly fine and rare cabinet are contained, as we perceive by the catalogue, in one hundred drawers. The specimens referred to and figured in the authors excellent work on mineralogy, have numbers attached to them corresponding with the figures. Such a cabinet, having such a relation to one of the best standard works on the science of which it treats, will doubtless claim the attention of scientific institutions and amateurs of natural history.

24. *Canada*.—We are informed, that under the direction of Col. Bouchette, of Quebec, so well known as the author of a splendid geographical and statistical work and map, which has been some years before the world, there will be soon published, Topographical Maps of the province of Lower Canada, exhibiting by districts the divisions and subdivisions, local ameliorations, and actual state of the settlements of the colony, preceded by a general map of the British North American provinces.

This work is to be entirely of a public nature, and so calculated, from the scale of its construction, and the mode of its engraving, as to admit of future correction and amelioration. The growth of a new country is naturally rapid, and the map, which to-day portrays it, with all possible detail, must, in ten years hence, be deficient of that information which might then be sought for. With a view to this object, therefore, has the plan of the proposed topographical maps been formed: a plan which will, at once, be found compre-

hensive and explanatory, admitting of the most elaborate detail, and in the mean time conveying all the collective information at present desirable.

The whole work to consist of

*First*, A geographical map of the Canadas, New Brunswick, and part of Nova Scotia, and a large section of the United States of America, compiled with the greatest care and precision from the latest surveys, and adjusted from the most recent and approved astronomical observations, forming a map of six feet by four feet.

*Second*, A topographical map of the district of Montreal, on a scale of two and three fourth miles to an inch, extending westward to Fort Coulogne on the Ottawa River, and comprehending part of that section of Upper Canada traversed by the Rideau Canal. The map to be seven feet two inches by three feet eight inches.

*Third*, A topographical map of the districts of Quebec and Three Rivers, on the same scale, forming a map of seven feet three inches by four feet three inches.

*Fourth*, A map of the district of Gaspé, on a scale of eight miles to one inch. Length, two feet six inches by one foot six inches.

Each map will be executed with all possible topographical minuteness, indicating rivers, streams, roads, bridges, villages, settlements, churches, mills, &c. &c.

The maps to be accompanied by a descriptive work, in three volumes, royal 8vo.

The 1st volume to contain a general geographical and brief description of the British North American provinces, and summaries of the statistical tables of Lower Canada, &c.

The 2d volume to be a topographical and statistical description of the district of Montreal, tables, &c. embellished with several landscapes.

The 3d volume a topographical and statistical description of the districts of Quebec, Three Rivers and Gaspé, with tables, &c. also embellished by several landscapes.

In each of the volumes will also be contained tables of distances, post-routes, &c. &c. and a variety of other useful information relative to each district. The whole to be published under the immediate patronage of the local governor and the legislature, and to be dedicated to the king.

The maps to be engraved by the most eminent English artists.

Price of the whole work, maps, &c. seven guineas.

That of the geographical map, the 1st volume of the work, the district of Montreal, and the volume descriptive thereof, five guineas.

The geographical map, the 1st volume of the work, the districts of Quebec, Three Rivers, and Gaspé, and the volume descriptive thereof, five guineas and one fourth.

25. *Remains of the Mammoth.*—On Saturday, two tusks of the Mammoth, brought home by Captain Beechy, were exhibited, and described to the Wernerian Society, by Professor Jameson. They are in fine preservation, and not bent in one direction, but twisted spirally, like the horns of some species of cows. The smallest, which is quite entire, is nine feet nine inches in length; the largest, which wants a small part of the point, must have measured originally twelve feet. Judging from analogy, Professor Jameson stated, that the mammoth to which the largest belonged, must have been fifteen or sixteen feet high, and consequently larger than the elephant, which is an animal of the same species. They were found on the west coast of America, near Beering's Straits, at Escholz Bay, latitude 66, in a very remarkable bluff, which has been described by Kotzebue.—The bluff has a covering of earth and grass, but Kotzebue, while encamped on it, having cut through the surface for some purpose, was surprised to find, that what he took for a portion of terra firma, was in reality a mountain of ice, a hundred feet in height above the level of the water, but attached to the land, as such icebergs generally are. This discovery led to another still more interesting. It was found that this mass of ice had imbedded in it a vast number of the tusks, teeth, and bones of the mammoth, of which the objects we have described, are a part. These remains must have been enclosed in the ice by the same catastrophe that buried the mammoth, which was found entire in a singular envelope on the banks of the Lena, thirty years ago; and that catastrophe, beyond a doubt, was no other than the general deluge, which extinguished the race of animals to which these remains belonged. The bones, tusks, &c. were numerous, and some parts of the ice near the place where they were deposited, had a smell of decayed animal matter, arising, no doubt, from the decomposition of the flesh. The tusks are in their

natural state, but of two teeth which accompanied them, one seems to be petrified, having doubtless been in contact with stone. The mammoth seems to have been an inhabitant of nearly the whole northern hemisphere, its teeth or bones having been found on both sides of North America, in Siberia, in England, Scotland, Italy, and other European countries. The remains, however, found in Ayrshire, and in various parts of England, belong to a smaller species than that which furnished these tusks. The Edinburgh Museum is indebted for these valuable relics, to Lord Melville, who has never been unmindful of its interests, when his official station enabled him to do it a service.—*Scotsman*, Nov. 14.

*Foreign extracts, by Prof. J. GRISCOM.*

26. *Two kinds of Sulphate of Manganese.*—When black oxide of manganese is treated with sulphuric acid (as in preparing oxygen gas) and the mother water is evaporated, two kinds of sulphates are obtained, distinct in their physical as well as chemical characters. One of these sulphates crystallizes in long prisms with four faces, perfectly white, transparent, and truncated obliquely at their extremities;—the other is in the form of rhomboids and of a rose color. The first contains a greater proportion of oxide than the second, and is composed of water 28, sulphuric acid 28.66, and oxide of manganese 43.34. The second is formed of water 44, of sulphuric acid 32, oxide of manganese 24. In the latter, the sub. carb. of potash produces no change. In the first it gives rise to a precipitate which appears to be a carbonated oxide of manganese, and which speedily becomes brown by the action of the air.—*Ferussac's Bulletin*, Sept. 1828.

27. *Preparation of Hydriodic Acid; by M. W. BRANDES.*—Dissolve 60 grains of iodine in a sufficient quantity of alcohol, and add to it drop by drop, four ounces of water, in which has been stirred an ounce of starch finely pulverised. When the ioduret of starch has subsided, decant a portion of the supernatant fluid. Into the remainder, pass a current of sulphuretted hydrogen; this gas soon produces an orange yellow color, occasioned by the formation of sulphuret of iodine—the color afterwards becomes a pure yellow, and finally disappears entirely, the starch again becoming white. The liquid

is then to be filtered; the starch which remains on the filter is washed with small quantities of water, and this being added to the former liquid, the whole is gently heated, in order that the hydro-sulphuric acid may be expelled. It may be evaporated to the spec. grav. of 1.5, and the hydriodic acid is thus obtained pure.—*Idem.*

28. *Pluranium.*—Two new metals have been discovered in the platina of Oural in Russia, by M. Osann, to which he has given the name of *pluranium*, (formed from the initials of *platina* and *Ural*,) and *Ruthenium*. (*Ruthenia*, Russia.) The process for obtaining the first has been published, and the correctness of the inferences which determine the existence of a new metal, has been confirmed by Berzelius.—*Idem.*

29. *Bichromate of Potash.*—The solution of this salt, which is used extensively in dyeing at the manufactory of Borrowfield near Glasgow, was found to produce ulcerations upon the hands of the workmen, which without extending much on the surface had so remarkable a tendency to increase in depth, that in one case it perforated the hand from side to side. Some individuals were found to be much more easily affected by it than others. Not only were the hands ulcerated, but swelling of the face and inflammation of the eyes were produced. Even the simple handling of the stuff, after it came from the vat, was sufficient in the more susceptible cases, to produce eruptions. Other solutions employed in dyeing, occasion sometimes inflammations and various affections of the parts exposed. Thus, the solution of chloride of lime softens and sometimes destroys the nails and causes painful excoriations.

Guided by these observations, Dr. Cumin employed a saturated solution of bichromate of potash in the treatment of warts and syphilitic excrescences. In some instances they disappeared without any ulceration—in others, ulcers were produced, but always circumscribed and easily cured, and in these cases the remedy was more prompt. Dr. C., by this application, in a short time, and without occasioning much pain, cured a female of an immense number of warty eruptions, which had resisted all other means of treatment.—*Idem*  
—*Sept.* 1828.



30. A solid *compound of cyanogen and sulphur*, in definite proportions, has been obtained by M. Lassaigne. His process is to put into a small glass balloon some crystallized cyanuret of mercury in fine powder, and pour upon it half its weight of bichloride of sulphur. In the course of twelve or fifteen days, in a diffuse light, it sublimes in the neck of the glass, which is kept shut, and forms small crystals—white, transparent, or of a rhomboidal shape and highly refractive. These crystals when sublimed, have a strong, penetrating odor, exciting tears. A small fragment, placed on the tongue, occasions a most pungent sensation, and the spot which has been touched soon becomes red and painful.

One of their characters is to produce, with the per salts of iron, a red color altogether similar to that produced by the sulpho-cyanic acid: Agreeably to the author's analysis, this compound is formed of four atoms of cyanogen and one atom of sulphur.—*Idem.*

31. *Citric Acid from Gooseberries.*—M. Tilloy, of Dijon, has obtained from about 6200 lbs. of gooseberries, about 47 lbs. of citric acid, and 48 gallons of alcohol at 20. The cost of the gooseberries and other materials, labor, &c. was 227 francs; and the value of the alcohol was 91 francs. The balance 136 francs, brought the cost of the citric acid to about 3 francs per lb. whereas its value in the market is 12 francs per lb.

The juice of the gooseberries is fermented and distilled,—the materials of the still are then pressed and strained, and while the fluid is warm it is saturated with chalk, and the citrate of lime, being well washed, pressed, and diluted with water so as to bring it to a clear creamy mass, it is decomposed by sulphuric acid, diluted with twice its weight of water, and by the aid of heat. The liquid acid thus resulting, is again saturated with carbonate of lime, the precipitate strained and well washed is again decomposed, and being deprived of its color by animal charcoal is finally evaporated. The crystals being colored and clarified by claying as in refining sugar. They are redissolved and again crystallized.—*Idem.*

32. *Medical uses of Gold.*—Preparations of this metal, as a substitute for those of mercury, in the treatment of venereal diseases, were introduced, or at least, more exten-

sively employed, some years since, in consequence of the recommendation of Dr. Chrestien of Montpellier. Contradictory statements of its value have been since published by physicians in different parts of Europe and America. Magendie, in the latter editions of his formulary is unfriendly to the uses of gold, as a remedy in syphilis, but it does not appear that he judges of it by his own experience. Dr. Le Grand, of Amiens, in an octavo volume, published in 1823, maintains the opinion that the employment of gold is the most efficacious and least dangerous means of combating syphilis. The volume contains a mass of near 400 observations, all favorable to its employment.

Dr. Chrestien, has also addressed, within the past year, a letter to Magendie, on the different modes of preparing and administering gold, 8vo. 79 pp. 2 fr.

"This pamphlet," says the reviewer, "written with the dignity worthy of a practitioner, almost a septuagenarian, written to a brother professor, placed in so elevated a sphere, is of such a nature as to induce the honorable academician, to modify the opinion which he may hereafter give of auriferous preparations. We have no doubt that if he will make trial of it, he will become one of its partisans and most zealous defenders."—*Rev. Ency. Nov.* 1828.

33. *A Congress of Savans*, assembled on the 18th of September, 1823, at Berlin, under the favor and patronage of the King of Prussia. The whole number assembled on the occasion was four hundred and sixty-seven, of whom three hundred and twenty-four were Prussians, one hundred and nine Germans, and thirty-four were from different States of Europe, including France, England, Holland, and Russia.

The session was opened by a discourse from Alexander De Humboldt, President, in which he stated the object of the convocation, and pointed out the advantages of such a union of the friends of science, from different parts of the world, and its influence on the discovery and propagation of useful truths.

The meeting was continued during a week. Committees were appointed on Astronomy, Geography, Chemistry, Mineralogy, Botany, Zoology, Anatomy, Physiology, and Medicine. Some of the discourses have been printed, among which are those of A. De Humboldt, at the opening of the congress, and a memoir of M. Reinwardts, of Leyden, upon

the character of the vegetable kingdom in the Indian Archipelago.

The session was closed by a speech of the President's, and it was decided that the Congress should be convoked the next year at Heidelberg.—*Rev. Enc. Nov.* 1828.

34. *On the detection of Potash by the oxide of Nickel.*—As the method of Harkorts for the detection of potash is but little known to chemists, and as it promises great advantages, especially in mineralogy, we think it right to state what Berzelius says of it in the new edition of his treatise on the blow pipe, about to appear. According to this chemist, the method of Harkorts has answered perfectly to the trials to which he had subjected it, to ascertain its correctness. It is sufficient to dissolve the oxide of Nickel in borax, and to add to the vitreous matter a little nitre, feldspar, or any potassuretted substance, to obtain immediately a glass of a very distinct blue color. The presence of soda does not prevent this reaction. Among the preparations of Nickel, we may employ the nitrate or oxalate of this metal. It must not however contain cobalt, as that gives the glass a brown color.—*Ferrusac's Bull. Juillet*, 1828.

35. *Description of a very simple Apparatus for saturating any liquid with gas and without loss of the fluid*, by M. Hessel.—The gas is to be enclosed in a bladder, which is to be connected by a hollow cylinder with an elastic tube, (a gut, or something of that kind.) This tube is to be adapted to a bottle containing the fluid to be impregnated, and which is not to be quite full of the liquid. In the neck of the bottle adjust a cork pierced with two holes, into one of which fasten a tube, which shall pass downward into the fluid, and over the hole place a valve opening upwards.

When the bladder is pressed, the gas passes through the tube into the fluid, and rising to the top, it ascends through the valve to be again pressed downwards into the fluid, until the absorption is complete.—*Ibid.*

36. *Memoir on the Chloride of Lime*, by M. Morin, Ann de Chimie and de Phys. Fev. 1828.—The author, in saturating hydrate of lime by gaseous chlorine, has found the following results.

## Hydrates formed of

2	lime and 1 water, absorb	1-2	chlorine
2	2	1	do.
2	3	1	do.
2	4	1	do.

The second only of these chlorides should therefore be employed in the arts, as pointed out before by Wetter. The author has further observed that when the action takes place in the cold, the chlorine remains entirely in the state of chloride of oxide, but with heat, one third or more of chlorine cease to react as chloride of oxide; and if we afterwards apply heat to this solution, the two remaining thirds of the chlorine cease also to be in the condition of chloride of lime, by disengaging an equal volume of oxygen. All the chlorine of the chloride of lime prepared in the cold, undergoes a like modification, by disengaging the half of its volume of oxygen, and by transforming itself into chloride of calcium, and chlorate of lime.—*Idem.*

37. *Alcohol.*—By distilling alcohol of 98 1-2 per cent. by a gentle heat, and receiving the products of the distillation successively in small flasks, numbered and of equal size, it was found that

	Density.
The 1st portion which passed had	0.7972 or 97.86 per cent
2d	0.7970
3d	0.7969
4th	0.7966
5th	0.7965
6th	0.7964
7th	0.7962
8th	0.7959
Mean,	98.32 per cent.

It thus clearly appears that absolute alcohol is less volatile than that which contains a portion of water, and that when the degree of 97 per cent. is passed, the weakest alcohol goes off first, and the strongest last, consequently the volatility of alcohol is not in proportion to its specific levity or its anhydrous condition.—*Idem.*

38. *Rapidity of the Circulation of the Blood.*—A solution of ferruretted hydrocyanate of Potash, introduced into the jugular vein of the horse, entered the circulation and arrived

at the opposite jugular in an interval of from twenty to twenty-five seconds. It arrived in twenty-three to thirty seconds in the opposite external thoracic vein, in twenty seconds at the large saphena vein, in fifteen to thirty seconds in the masseterine artery; in ten to fifteen and in twenty to twenty-six seconds in the external maxillary artery, and from twenty to twenty-five and from twenty-five to thirty seconds in the artery of the metatarsus, in each case on the side opposite to that of the injection. Experiment by E. Herring, of Stutgard.—*Ferrusac's Bull*, July, 1828.

39. *Remarkable phenomenon in a medicinal compound.*—M. Ehrenberg, apothecary at Cannern, having, agreeably to the prescription of a physician, made a solution of acetate of potash in cinnamon water, found twenty-four hours afterwards, that the solution exhaled a decided odor of hydrocyanic acid. Thinking that some mistake had been made in the preparation, he renewed it and obtained the same result. M. Blei, apothecary at Pemberg, has also confirmed the fact.—*Fer. Bul. Sep.* 1828.

40. *Discovery of iodine in the ore of zinc.*—It is known that M. Vauquelin is the first who discovered iodine in the mineral kingdom. He found this simple substance in some silver ores from the neighborhood of Mexico, and according to M. Del Rio, these mineral are found in the province of Zacatecas. M. Bustamente has since found indications of it in an ash colored lead ore, from the mines of Catorce. Lastly, M. Mentzel has just proved the presence of iodine in an ore of zinc from Upper Silesia.—*Fer. Bull. Nov.* 1828.

41. *Size of the grains of native platina.*—The cabinets of Europe scarcely contained any grains of native platina larger than a line in diameter until M. Humboldt brought one from South America weighing 1088 grains. This was the largest known until 1822, when the Museum of Madrid was enriched with a native specimen two inches and four lines in diameter, weighing eleven thousand six hundred and forty-one grains, obtained from the gold washings of Condoto. But these have been outdone by a mass from the mines of Demidoff, in Oural, proved by Professor Lubarsky of St. Petersburg, in 1823, to be native platina, containing an alloy of iridium and osmium. It weighs four thousand

three hundred and twenty kilogrammes, about nine and a half pounds avoirdupois.—*Idem.*

42. *Observations on the evaporation of ice*, by M. Schuebler.—It results from these observations that the evaporation of ice is much more considerable than is generally imagined, and that under certain circumstances, it may surpass that of water. In a dry cold air on the 9th of January, the evaporation from ice in twenty four hours, was twice as great as from an equal surface of water in the middle of February, during mild and cloudy weather. We may perceive from this the manner in which snow disappears gradually by long exposure to a cold atmosphere.—*Ibid.*

43. *Swiftness of Sound*.—At the temperature of melting ice, the experiments of

Parry and Foster give	333.15 metres
Moll and Van Beck	332.05
Stampfer and Myrbach	333.25
Arago, Matthieu, and Biot	331.05
Benzenberg	333.70

Mean,	332.64
-------	--------

*Idem.*

44. *On the colored flame of Alcohol*, by Prof. Vogel of Munich.—After mentioning the experiments of Brewster, Pallo, Herschell, Blackadder, &c., the Professor entertained the assembly with the yellow, red, and green flames of Alcohol. The yellow was produced by kindling alcohol on salts with bases of ammonia, soda, manganese, iron, mercury, platina, gold, nickel, cobalt, and bismuth. A red flame was obtained from salts with bases of lime, strontian, lithia or magnesia. On the salts of copper, uranium, or alumine, the flame is green. The salts should all be soluble in alcohol. A green flame is also produced in burning the solution of boracic acid and alcohol, or from weak hydrochloric ether. The oxid of copper, according to M. Vogel, is reduced, by burning alcohol, into protoxide and metallic copper, the green flame itself containing copper.—*Ferrusac's Bull. Nov. 1828.*

45. *Electricity of the Tourmaline*.—We have announced that, according to M. Becqueret, the fragments of the tour-

VOL. XVI. No. 2.

Page 391, line 21 from top, for *burning* read *becoming*.

1. Particulars of the striking of lightning over a great surface,	193
2. Electro-galvanic phenomena,	194
3. Test for lead in oil of vitriol	195



maline are more electric by heat than the entire tourmaline, and that when the latter is very long, it cannot acquire the pyro-electric virtue. We were then ignorant that M. Brewster had made analagous experiments under date of Aug. 2d, 1824. The following are the expressions of the Scotch philosopher: "In examining the electricity of the tourmaline. I have found that it is much more easily observed with a small fragment broken from any part of the prism. The experiment succeeds better when the fragment has its faces perpendicular to the axis of the crystal. When such a fragment is placed on a glass and heated to a boiling temperature, the fragment adheres to the glass with so much force that on inverting it, the fragment remains suspended during six or eight hours. In this manner, pieces of considerable thickness and surface are capable of supporting their own weight. He adds further, that the dust of the tourmaline adheres in a mass when heated on a glass, and stirred with a dry substance.—*Ferussac's Bulletin, Nov. 1828.*

46. *New method of preserving Crystallized Salts; by M. Deuchar.*—Agreeably to the statement of the author, salts may be prevented from efflorescing or burning liquid, by charging the air of the vessel in which they are kept with the vapor of the spirits of turpentine. It is sufficient for this purpose to pour a very small quantity on the bottom of the vessel.—*Ibid.*

47. *Conversion of potatoe flour into nutritious bread.*—M. Darcet proposes, in order to render the bread of potatoe flour as palatable and nutritious as that of wheat, that some animal substance should be added to the mixtures, and this he finds may be gelatine, or caseous matter. In 1821 he proposed to add gelatine to wheat flour for the purpose of making a more nutritious biscuit for the use of the navy, and some of these were prepared under his direction for the voyage of circumnavigation now under the command of M. De Dürville. The wheat flour used by the bakers of Paris, contains about,

Water,	-	-	-	-	-	10
Gluten,	-	.	-	-	-	10
Starch,	-	-	-	-	-	73
Saccharine matter,	-	-	-	-	-	4
Gummo-glutinous matters,	-	-	-	-	-	3

---

 100

Potatoes, obtained in the market, contain per hundred weight,	Water, - - - - -	72
	Ligneous fibre, - - - - -	2
	Starch, - - - - -	26
		<hr/>
		100

To bring potatoes to a near equality with wheat flour, in relation to bread, there must therefore be added to 100 parts of potatoe flour, 4.63 of animal, and 1.53 of saccharine matter. In mixing these three substances, we should evidently obtain a flour as nutritive, and as easy to be converted into bread, as the flour of grain.

To prepare 100 kilogrammes of animalized potatoe flour, take 264 kilogrammes of potatoes, worth	-	4.95 francs.
Coal for dressing these potatoes by steam,		.66
12 kilogrammes of gelatine,	- - -	12.00
4 kilogrammes of grape, or other sugar,	-	2.00
Manual labor in cooking and mixing the materials,	- - - - -	4.00
Add one tenth for all other expenses,	-	2.36
		<hr/>
		25.97 or 26 fr.

This mixture rises like wheat flour, and makes good bread.

The cost of 100 kilog. of *good* wheat bread at Paris, is 60 franks, and it appears that the same quantity of animalized potatoe bread can be made for less than one half that sum.

We shall give in the next number of our Journal, a note explanatory of the process employed by M. Darcet, in extracting gelatine from bones with facility and economy.

*L'Industriel Fev. 1829.*

48. *Means of detecting the purity of chromate of potash.* Add to the sample to be tried, a great excess of tartaric acid. The chromate is immediately decomposed, and the liquid acquires, in the course of ten minutes, a deep amethystine color, and then no longer forms a precipitate with nitrate of barytes, or nitrate of silver, when the chromate of potash is pure; while these reagents will indicate the slightest traces of sulphate or hydro-chlorate contained in the liquid. A necessary precaution is to have the solution of the chromate sufficiently diluted not to precipitate tartrate of potash, which it will do if not diluted with sixty parts of water at least; and the solution cannot be assayed until the amethystine hue is well established, otherwise the decomposition is not complete. —*Idem.*

49. *Decoloring action of Charcoal.*—An elaborate memoir on this subject, by Mr. Bussy, which obtained the prize proposed by the Society of Pharmacy, of Paris, contains the following results :

1. That the decoloring property inherent in charcoal, manifests itself only when the charcoal is in certain physical conditions, among which, porosity and division hold the first rank.

2. That the azote is devoid of effects ; that the foreign substances which the charcoal contains exert no decoloring action, with the exception of sulphuretted hydrogen, and the sulphurets under some circumstances only : if the foreign matters appear to have an influence in the decoloration, it is occasioned by the development of surface merely in consequence of the mixture.

3. That no charcoal can discolor when it has been heated so strongly as to become hard and brilliant ; that all its varieties on the contrary enjoy this property, when they are sufficiently divided,—not by mechanical action, but by the interposition of some substance which opposes their aggregation.

4. That the superiority of animal charcoal, such as that of blood, or gelatine, arises from its great porosity ; which may be considerably increased by the effect of matter with which it is calcined, such as potash.

5. That potash is not limited in its effect of increasing the porosity of the charcoal, by the abstraction of the foreign substances it may contain, but it acts on the charcoal itself, in attenuating its molecules, and that by calcining vegetable substances with potash, a decoloring charcoal may be obtained ; add also by the calcination of vegetable, or animal matters, with phosphate of lime or clay.

6. That the decoloring force of different charcoals, ascertained with respect to one substance, generally follows the same order in all others ; but that the difference between them diminishes in proportion to the difficulty of decoloration in the different liquids on which they are tried.

7. That charcoal acts upon coloring materials by combining with them without decomposing them, as alumine would do, and that, in some cases the color can be made alternately to appear and disappear.

8. The the following are the relative numerical forces of the decoloring power of the charcoals employed, *first*, upon

a test solution of indigo, and *secondly*, upon a test of diluted molasses.

	Indigo.	Molasses.
Blood calcined with potash, - -	50	20
Blood calcined with chalk, - -	18	11
Blood calcined with phosphate of lime,	12	10
Gelatine calcined with potash, - -	36	15.5
Albumen calcined with potash, - -	34	15.5
Fecula calcined with potash, - -	10.6	8.8
Charcoal of acetate of potash, - -	5.6	4.4
Charcoal obtained by the decomposition of sub-carbonate of soda by phosphorus,	12.	8.8
Lampblack calcined, - - - -	4	3.3
do. calcined with potash, - -	15.2	10.6
Charcoal of bones treated with muratic acid and potash. - - -	45.	20.
Charcoal of bones treated with muriatic acid,	1.87	1.6
Vegetable or animal oil calcined with phos- phate of lime, - - - -	2.	1.9
Charcoal of bones—crude, - - -	1.	1.

*Idem.*

50. *Manufactory of diamonds.*—Several accounts of the crystallization of pure carbon by artificial means and the consequent formation of diamonds possessing the hardness, transparency and refractive power of that most valuable of all the gems, have been published in the journals, and have attracted public attention. But on the 24th of Nov. last M. Thenard stated to the academy of sciences, that in conjunction with Dumas and Cagniard de la Tour, he had carefully analysed these crystals, and had ascertained that they were only silicates and not artificial diamond.—*Ann. de Chim. Nov. 1828.*

51. *Leeches.*—In a journal entitled the Westphalian Indicator, a physician states a case in which leeches that had been employed on a person affected with syphilis, were afterwards used on a child and communicated to the infant the same disease. Hence, when leeches are used a second time, care should be taken with respect to the nature of the disease of the person on whom they are at first employed.\*—*Fer. Bul. Jan. 1828.*

---

\* Dr. Salle of Fontainbleu, proposes as a means of economising leeches, to cut them in two while in the act of suction. The animal, notwithstanding this operation continues to draw blood, and it can be made to fall at pleasure by putting on the adhering part some salt or tobacco.

52. *Chloride of lime in psora.*—M. Derheims proposes the following solution as a cure for itch.

Chloride of lime, - - - 3 ounces.

Distilled water, - - - 1 pint.

Dissolve and filter, and use it as a lotion on the thighs, legs and arms, two or three times a day. From six to ten days treatment will be sufficient.—*Idem.*

53. *Iron furnaces in England and Scotland.*—The number of high furnaces in 1740 was but fifty nine. This number has been increased as follows,

1740,	59 furnaces producing	17.000 tons.
1788,	85 “ “	68.000 “
1796,	121 “ “	125.000 “
1806,	“ “	250.000 “
1820,	“ “	400.000 “
1827,	284 “ “	690.000 “

Of the two hundred eighty four furnaces last mentioned, ninety five are in Staffordshire, and ninety in South Wales.

54. *New process for obtaining gallic acid, by M. Le Roger.*—Exhaust the soluble matter from the gall nut by repeated decoctions: add to these concentrated decoctions a solution of gelatine, which precipitates the tannin; filter; add very pure animal carbon—boil during eight or ten minutes; filter again, and then by evaporation and cooling, crystals of gallic acid will be obtained, of a silky texture, and perfectly white. Gall nuts of the first quality furnish by this method, the fourth of their weight of acid; whereas, by the process of Braconnot, they yield only a fifth.—*Mem. de Phys. de Geneva.* 23, p. 79.

55. *Action of iodine on protochloride of mercury, by Planche and Soubeiran.*—When iodine and protochloride of mercury are triturated together with water, decomposition ensues, and there are formed deutochloride and ioduret of mercury.—*Jour. de Pharm.* 1826.

56. *Note on a new method of preparing the deutoxide of barium, by M. Quesneville, fils.*—Having obtained, in a simple manner, the deutoxide of barium, I think it right to make known the process, because being less expensive than that which is followed, it will enable chemists to procure at

a cheaper rate, the oxygenated water, the employment of which will then become more common.

The method which I follow is this: I take nitrate of barytes, which I put into a porcelain retort, to which I lute a Welter's tube, and extend the latter under an inverted jar of water. I then gradually heat the retort, and maintain it at a red heat, as long as any nitrous acid and azotic gases are disengaged, which indicates that a portion of nitrate of barytes remains to be decomposed; but from the moment that the oxygen gas passes perfectly pure, I remove the fire and let the retort cool. The product of this decomposition is a deutoxide of barium, which possesses all its known properties, among which is that of slacking with water without being heated, of disengaging oxygen, when boiled in that fluid, and of being brought to the state of protoxide by a strong heat. Its purity is easily proved by treating it with sulphuric acid, for no disengagement of nitric acid ensues. Pure nitric acid does not disengage deutoxide of azote. We may thus obtain a deutoxide of barium, as well charged with oxygen, and as pure, as that which is procured by the other process. Its formation is, in fact, very natural; the protoxide of barium, finding itself in contact with a great quantity of oxygen gas in the nascent state, combines with it and retains it, if the heat be not too great, afterwards to disengage it.—*Annales de Chimie, &c. Sept. 1827.*

57. *Precipitation of albumen by phosphoric acid.*—Berzelius and Engelhart have discovered that phosphoric acid, prepared by dissolving phosphorus in nitric acid, evaporating the solution in a platina vessel and heating it to redness, would, when dissolved in water, precipitate both vegetable and animal albumen very abundantly, but that the power of the acid to cause this precipitation, diminished from day to day, and was entirely lost in the course of a few days. The same effects in all points ensued with phosphoric acid obtained by burning phosphorus in a bell glass, and dissolving the acid thus formed in water. This change in the acid took place as well in closed vessels of glass or platina as in open vessels, nor was it accelerated by ebullition.

The power of precipitation was renewed by evaporation and heating to redness, but was again lost in the course of a day. The cause of this phenomenon, (Berzelius observes,) it was impossible to discover.—*Idem.*

58. *New fulminating powder.*—Two parts of nitrate potash, two of the neutral carbonate of potash, one of sulphur and six of marine salt, all finely powdered, produce a fulminating mixture of great energy, the explosive force of which has the peculiar property of being continually directed downward!—*Ferrussac's Bulletin, Aout 1828.*

59. *New compounds of silica and potash, by M. Fuchs.*—The best method of obtaining this combination is the following. Melt together 10 parts of carbonate of potash, 15 of pure quartz and 1 of carbon. The melted mass after having been reduced to powder is subjected to the action of 4 or 5 parts of boiling water, which dissolves it slowly, but almost entirely. The solution is evaporated to the consistency of 1.24 sp. gr. It then presents itself under the form of a viscid, opaline liquid, which by further evaporation either spontaneously or by heat, is converted into a solid vitreous transparent mass, fixed in the air, and perfectly similar to glass, except that it is less hard.

This substance has an alkaline reaction; it scarcely dissolves in cold water, but easily in boiling water. Exposed for some weeks to the air, it attracts moisture, which gradually penetrates it, without lessening much its aggregation. The surface merely splits and is covered with powder. Alcohol precipitates the aqueous solution. Acids decompose it in the same manner as the liquor of flints; many salts form with it insoluble precipitates. This new silicate of potash is composed of 62 parts of silica, 26 of potash and 12 of water. It may be employed as a covering of wood and other objects, to preserve them from fire, or as a substitute for lute in the laboratory.—*Idem.*

60. *Marine salt.*—If a concentrated solution be exposed to a temperature of 8° or 9° Reaumur, fine crystals may be obtained, which are often an inch or more in length. In a cold atmosphere they effloresce,—but with heat they liquify in their water of crystallization.—*Idem.*

61. *Delicate test of oxygen in a gaseous mixture.*—Fill a flask or bottle with a ground stopper with hot water. Boil it by placing it on a plate of sheet iron and applying underneath a spirit lamp, and then add 5 per cent of green vitriol recently prepared, and continue for an in-

stant the ebullition. Then add to the solution still warm, ammonia till there is an excess. Stop the bottle and wait until the precipitate is entirely formed. Then decant the liquid by means of a glass tube, wash the precipitate with water previously boiled, and lastly, fill the bottle with warm alcohol.

When this protoxide is used, a small spoonfull of it is to be rapidly withdrawn, and put into a vessel filled with water, deprived of its air by boiling. Into this vessel the gas to be examined must be passed. If it contain one part of oxygen in a thousand, its presence will be indicated by the ochreous color assumed by the reagents.—*Idem*.

62. *Optical amusements*.—Pierce a card with a small hole, and holding it before a window or white wall, a pin being held between the eye and the card will be seen on the other side of the orifice inverted and enlarged. The reason of this phenomenon as M. Lecat has observed, is, that the eye sees only the image of the pin on the retina; and since the light which is arrested by the head of the pin, comes from the lower part of the window or wall, while that which is stopped by the lower end of the pin comes from the upper part, the image must necessarily appear inverted relatively to the object.

The phenomena of the *mirage* may be completely imitated, as Dr. Wollaston has shown, by directing one's observation to a distant object along an iron bar heated to redness, or through a saline or saccharine solution, covered with alcohol.

The following experiment, suggested by Dr. Brewster, explains very agreeably the formation of halos:

Put a few drops of a saturated solution of alum on a piece of glass; it will rapidly crystallize in small octahedral plates, scarcely visible to the naked eye. When this is held between the eye and the sun, or a lamp, the eye being nearer the smooth surface of the glass, three beautiful halos of light will appear, at different distances from the luminous body. The interior halo, which is the whitest, is formed by the images refracted by two of the surfaces of the crystals, but little inclined to each other. The second halo, whose colors are finer, is formed by two faces more inclined; and the third, which is very large, and highly colored, is formed by two faces still more inclined. The same effects may be obtained



with other crystals, and each halo will be either double when the refraction is considerable, or modified by various colors, when the refraction is weak. The effects may be varied in a curious manner, by crystallizing on the same piece of glass, salts of a determinate color. By this means, halos white and colored succeed each other.—*Bulletin technologique Aout*,—1828.

63. *Corrosive Sublimate*.—At the common temperature, four parts of ether dissolve one part of corrosive sublimate; but by taking equal parts of camphor and sublimate, it requires but three parts of ether for solution. By increasing the proportion of the camphor, we have the following results: 4 parts of ether with 4 of camphor, dissolve 2 parts of sublimate.

4	"	"	"	8	"	"	4	"	"
4	"	"	"	16	"	"	8	"	"

3 parts alcohol, common temperature, dissolve 1 part of sublimate; in adding to the latter, only the half of its weight of camphor, one and a half part of alcohol is sufficient for the solution.—*Fev. Bul. Mars*. 1818.

\* \* \* \* \*

64. *On the Gossamer Spider*, by Mr. Bowman.—Several of these little insects were arrested in their flight, and placed upon the brass gnomon of a sun-dial: in a short time they prepared for their aërial voyage. Having crawled about to reconnoitre, they at last turned their abdomens from the current of air, and elevated them almost perpendicularly, supporting themselves solely on the claws of their fore legs; at the same instant shooting out four or five, often six or eight, extremely fine webs, *several yards long*, which waved in the breeze, diverging from each other like a pencil of rays, and strongly reflecting the sunbeams. After the insects had remained stationary in this apparently unnatural position for about half a minute, they sprung off from the stage with considerable agility, and launched themselves into the air. In a few seconds after, they were seen sailing majestically along, without any apparent effort; their legs contracted together, and lying perfectly quiet on their backs, suspended from their silken parachutes, and presenting to the lover of nature a far more interesting spectacle than the balloon of the philosopher. "One of these natural aëronauts I followed," says Mr. Bowman, "which, sailing in the sunbeams, had two

distinct and widely diverging fasciculi of webs ; and their position in the air was such, that a line uniting them would have been at right angles with the direction of the breeze. —*Magazine of Natural History.*

## 65. OBITUARY OF DR. JOHN GORHAM.

Continued life, and long life, are intensely desired by most men, although with the inevitable condition, that we must see our friends fall around us ; and if we attain to old age, only here and there one of our early associates will remain. Happy indeed are we, if, by the time when our shadows begins to lengthen towards the east, we do not find, that most of the friends of our youth have gone before us, and left us solitary mourners. These reflections, replete with interest, as to the present and the *future*, have been painfully forced upon the writer, by the death of an eminent early associate and friend, Dr. John Gorham, M. D. of Boston. Distinguished as a physician, as an author, and as a professor of science ;—as a man, lovely and beloved, even far beyond the limits of his own endeared family ; a graceful and polished ornament, of a community, conspicuous for intelligence and refinement ;—we are *grieved* that such an individual should be stricken from life, when, in distinguished usefulness and honor, he was but just passing its meridian ; and we can only *submit in silence*, where we cannot *understand*, and must not *repine*.—I may perhaps be permitted to add, that among the successive periods of my earlier years, few are remembered with so much satisfaction, as that passed at Edinburgh, in 1805 and 1806, in intimate *domestic* association with the lamented Gorham, and his respected survivor.\* The loss is severe to the community of which he was a member ; and to his family and friends, irreparable. We look, with much interest, for a printed notice of him, from the pen of the accomplished gentleman, who, on the funeral occasion, pronounced his merited eulogy.

---

\* The Rev. Dr. Codman, now of Dorchester ; Dr. Gorham, Dr. Codman, and the writer occupied the apartments of one house, and assembled at the same table, and that, (according to the custom of Edinburgh,) exclusively their own ; never were associates more harmonious.

## INDEX TO VOL. XVI.

### A

- Aerolite of Virginia, description of, 191  
 Affinity, influence of quantity of matter upon, 234  
 Albumen, precipitation of, by phosphoric acid, 396  
 Alcohol, 388  
 ——— action of sulphuric acid upon, 267  
 ——— colored flame of, 390  
 ——— from succulent and farinaceous plants, 173  
 Algebraic solution, 271  
 Allinson S. on the atomic weight of mercury, 183  
 Alum soda, of Milo, 203  
 Alumine, its use with pigments, 173  
 Ammonia, effect of, in cases of poison, 182  
 Analysis of chrysolite in the Virginia aerolite, 196  
 ——— of meteoric iron, 201  
 ——— “ “ of Louisiana, 217  
 Antiparos, description of, 336  
 Argillite embracing anthracite, 299  
 Artificial diamonds, 394  
 Atmosphere, carbonic acid of, 214  
 Aurora borealis, speculations upon, 290

### B

- Balsam copaiva, new preparation of, 40  
 Barium, deutoxide of, new mode of preparing, 395  
 Beck, L. C. Dr. on iron in salt springs, 187  
 Bell, B. strictures by, on Mr. Du Commun's hypothesis, 51  
 Bichromate of potash, 384  
 Birds of N. America, Audubon's work upon, 353  
 Blasting of rocks, improvement in, 372  
 Blood, rapid circulation of, 388  
 Botany, uniform nomenclature in, 376  
 Brandes, Dr. on shooting stars, 20  
 Bronzite, locality of, 185

### C

- Cabinet of William Phillips, 379  
 Calendar of vegetation, 48  
 Canada, natural history in, 378  
 ——— new maps of, 381  
 Carbonic acid of the atmosphere, 214  
 Carpenter, G. W. on balsam copaiva, 40  
 ——— “ chloride of lime, 177  
 ——— “ peruvian bark, 28  
 Chalcedony, 375  
 Charcoal, decoloring action of, 393  
 Chemical instruments, new ones, 293  
 ——— action, measurement of, 215  
 Chester county cabinet of Natural History, 374  
 Chloride of lime, 387  
 Chloride of lime, use of, 177  
 Chloride of lime in psora, 395  
 Chromate of potash, when pure, 392  
 Chrysolite in Virginia aerolite, 192  
 Church, Dr. on ammonia in cases of poison, 182  
 Citric acid in gooseberries, 385  
 Collections in natural history, 368

Columbite, discovery of, in Massachusetts, 220  
 Comets, observations of, 94  
 Common salt crystals of, 377  
 Commun, J. Du, on his hypothesis of volcanos, 51  
 Conchology of the United States, 378  
 Congress of Savans, 386  
 Cooper's rotative piston, 313  
 Corrosive sublimate, 399  
 Crystallized salts, how preserved, 391  
 Cyanic acid, 258  
 Cyanogen and sulphur, 385  
 ———— perchloride of, 257

## D

Dearborn, H. A. S. Gen. on the North American lakes, 78  
 Diamonds, artificial, 394

## E

Eaton, Prof. on the number five, 172  
 ———— on alcohol from farinaceous plants, 173  
 ———— on argillite, 299  
 Education, 209  
 Electricity of the tourmaline, 390  
 Expeditions, polar, history of, 124

## F

Fenn on the manufacture of glass, 112  
 Fibrous gypsum, 377  
 Field, M. Gen. meteorological remarks by, 288  
 Finch, J. on the boundaries of Empires, 99  
 Fish and Lizards in extraordinary circumstances, 41  
 Five, the favorite number in nature, 172  
 Fluxions, a discourse upon, 53  
 ———— solution of a problem in, 283  
 Fraunhofer, life of, 304  
 Fulminating powder, a new kind of, 397

## G

Gallic acid, new mode of obtaining, 395  
 Galvanic protection, by different metals, 263  
 ———— trough, new one, 215  
 Geography, physical, effects of, 99  
 Geology of the gold region in North Carolina, 1  
 Glass, ancient, from Milo, 331  
 ———— on the manufactory of, 112  
 Gold, medical uses of, 385  
 ———— mines of North Carolina, 360  
 Goodrich, J. letters from, 345  
 Gorham, J. Dr. obituary of, 400  
 Gossamer spider, 399  
 Gout, use of Iodine in, 176  
 Griscom, Prof. translations by, 257

## H

Hare, R. Prof. new chemical instruments by, 293  
 Hassler's thecolite, 252  
 ———— F. R. plan for a survey of the coast of the United States by, 225  
 Hayes, A. A. on alumine with pigments, 173  
 ———— on a scarlet pigment, 174  
 Hydriodic acid, mode of preparing, 383  
 High rock of Saratoga, 341  
 Hildreth, S. P. meteorological observations by, 44  
 Hitchcock, Prof., discovery of tin in Massachusetts by, 188

## I

- Ice, evaporation of, 390  
 Igneous action, effects of, 345  
 Ignis fatuus, remarks upon, 246  
 Iodine, action of on protochloride of mercury, 395  
 Iodine in ores of zinc, 389  
 ——— in Saratoga water, 216, 242  
 ——— use of in gout, 176  
 Iron furnaces in England, 395  
 Iron, meteoric, in Virginia aerolite, 200  
 ——— of Louisiana, 217  
 Iron in salt springs, 287

## K

- Keeney, J. C. on novaculite in Georgia, 185

## L

- Lakes, of North America, on the level of, 78  
 Leaves, autumnal coloration of, 215  
 Leeches, 394  
 Liquids, how saturated with gas, 387  
 Lyceum of Nat. History of New York, proceedings of, 205, 354

## M

- Maclure, W. Mr. letters from, 351,  
 Magnetic needle, variations of, 60  
 Magnetism, influence of, 262  
 Mammoth, remains of, 382  
 Manganese sulphate of, two kinds of, 383  
 Marine salt, 397  
 Materia medica, specimens in, 179  
 Medical compound, 389  
 Mercury, atomic weight of, 183  
 Meteoric iron, analysis of 217  
 Meteorological observations, 44  
 ——— report for 1828, 70  
 ——— tables, 288

- Mexico, facts concerning, 154  
 Minerals from the Sandwich Islands, 347  
 Mitchell, E. Prof. on affinity, 234  
 ——— Gold region of North Carolina, 1  
 Mitchell, J. Rev. on ignis fatuus, 246  
 Motion, the natural state of matter, 151  
 Muse, J. E. Dr. on resuscitation, 250  
 ——— on fish, &c. in extraordinary situations, 41

## N

- Natural history in Canada, 378  
 Naval Life, Sketches of, 320  
 Nickel a test for potash, 387  
 Nitric acid and phosphorus, explosion from, 366  
 Nitrous oxide, mode of obtaining, 295  
 North Carolina, gold region of, 1  
 Northern lights, remarks upon, 290  
 Novaculite in Georgia, 185

## O

- Obituary of Dr. N. Smith, 211 ——— of Dr. Gorham, 400  
 Ohio, facts concerning, 154 Oil stone from Ohio, 374  
 Oliver, B. L. Dr. on use of iodine in gout, 176  
 Olmsted, Prof. meteorological report by, for 1828, 70  
 Optical amusements, 398  
 Oxygen gas, used in a case of resuscitation from drowning, 250  
 ——— test of, 397

## P

- Peruvian bark, experiments upon, 28  
 Pettengill's stellarota, 363  
 Phillips, Wm. cabinet of, 379  
 Phosphoric acid, precipitation of albumen by, 396  
 Pigeons, mode of decoying, 373  
 Pigment for the pallet, 174  
 Platina, large masses of, 389  
 Pluranium, a new metal, 384  
 Polar expeditions, history of, 124  
 Potash, detected by nickel, 387  
 Proto-sulphuret of iron in Virginia aerolite, 207  
 Psora, use of chloride of lime in, 395  
 Pump by steam, 181

## Q

- Quantity of matter, effect of on affinity, 234

## R

- Renwick, Prof. translation from the Astronomical Journal of Hamburg, 225  
 Repeating theodolite, 252 Report upon Audubon's ornithology, 363  
 Resuscitation from drowning, 250  
 Revere, J. Dr. on sheathing for ships, 180  
 Review of Sketches of Naval Life, 320 Rock formations in America, 254  
 Rodriguez, P. J. on the observations of comets, 94  
 Rotative Piston, 313 Ruthenium, a new metal, 384

## S

- Saratoga powders, 369  
 ——— iodine in the mineral waters of, 242  
 Shepard, Charles U. Mr. analysis of meteoric iron, 217  
 ——— discovery of columbite in Massachusetts by, 220  
 ——— examination of Virginia aerolite, 191  
 ——— soda alum, 203  
 Ships, fastenings and sheathings for, 180  
 Shooting stars, 20 Silica and potash, new compounds of, 397  
 Sillimanite, zircon in, 207 Smith, Dr. obituary of, 211  
 Soda alum of Milo, 203 Sound, swiftness of, 390  
 Specific gravity, as used in mineralogy, 260 Spider, gossamer, 399  
 Stanniferous columbite in Massachusetts, 220 Steam pump, 181  
 Steel, J. H. Dr. on the Saratoga waters, 242  
 ——— on the High Rock Spring, 341  
 Strong, Theodore, Prof. solution of a problem in fluxions by, 283  
 Sulphuric acid, action of on alcohol, 267  
 Swainson's new zoological illustrations, 378

## T

- Telescopes, 301 Theodolite, Hassler's repeating, 252  
 Tin in Massachusetts, 188 Travels, new book of, 168  
 Trumbull, Col. on the national pictures, 163

## U

- United States, plan for the survey of its coast, 225.

## V

- Vanuxem, L. Prof. on American rock formations, 254  
 Variation of the magnetic needle, 60 Vegetable chemistry, 376  
 Virginia aerolite, examination of, 191

## W

- Water, maximum density of, 265 Wilder's algebraic solution, 271  
 Wollaston, Dr. obituary of, 216  
 ——— scale of chemical equivalents, 371  
 Wright, on the theory of fluxions, 53

## Z

- Zach, Baron de, 209 Zinc containing iodine, 389

## APPENDIX.

---

*Reclamation, certificates and correspondence respecting the invention of the temporary rudder, described in this Journal, Vol. XIII. p. 371.*

### REMARKS.

It will be perceived, by the dates of the subsequent letters, that this correspondence has been, some time, in my hands. I had hoped to bring about a friendly understanding between the parties, without calling the public attention to the controversy: or, at most, to have given only *the result* in the Journal. With this view, in my answer to Captain Rawson's first letter, I enclosed an open letter to Captain Marshall, requesting that the gentlemen would, in a friendly meeting, discuss and settle their respective claims, and communicate their decision for publication in the Journal. As they are both much abroad, and as their being in port, at the same time, is quite accidental; I have, in the hope of an accommodation between them, still delayed, (perhaps longer than strict duty would permit:) but my apology is founded, upon my great reluctance to admit personal controversy into a Journal of Science. Justice, however, seems to forbid further delay, and that the subscribers to the Journal may not have cause of complaint, I have caused the correspondence, (of which, and the certificates, it seemed scarcely possible to give a satisfactory abridgement,) to be printed separately, and appended to the Journal without forming a part of the volume.

B. S.

New Haven, June 18, 1829.

New York, October 14, 1828.

### TO THE EDITOR.

*Dear Sir*—In looking over your Journal for January 1828, I was not a little surprised at seeing a plan of a temporary rudder, communicated to you by Captain Marshall, of the ship *Britannia*, as one of his invention: as the plan was one of my own, and Captain Marshall made no mention in his communication of having borrowed it, you will oblige me by giving the following statement an insertion in your Journal.

On the 26th of September, 1826, on my passage from Liverpool to New-York, in Lat. 42 30, Long. 45 10, in the Ship *George Clinton*; in a violent gale I lost my rudder, and after having made one on the plan of Purnell, which did not answer in steering the ship, I then made one on the plan which Captain Marshall has communicated to you, which was the first of the kind, I believe, that was ever made. On my arrival in New York, Captain Marshall, with many gentlemen, examined it, and I explained to him particularly the plan of it. Twelve months after, when Captain Marshall arrived in New-York after his disaster, I called on board the *Britannia* to look at his rudder, and observed to him, that it was on the same plan as mine, which he acknowl-

edged. I had no further conversation with him on the subject, and, probably, should not have recurred to it again, but for his communication to you. Enclosed I send you the certificates of Captains Dickerson of the ship Roman, and Gardener of the ship Spartan, and the first and second officers of the George Clinton, which, I presume, will be sufficient to satisfy you of the correctness of my statement. My absence from New York, (having left the very day of the date of Captain Marshall's communication to you,) has prevented me from noticing it before this.

Yours respectfully,

EDWARD B. RAWSON.

## CERTIFICATES.

### NO I.

I hereby certify, that I have examined a plate in the American Journal of January, 1828, purporting to be the copy of a plan of a temporary Rudder fitted to the ship Britannia, and that it is a fac simile of a Rudder invented by Captain Edward B. Rawson, first fitted to the ship George Clinton, on a passage from Liverpool, in September, 1826, more than twelve months before the Britannia lost her rudder, and some months before the Britannia was built.

ALEXANDER RIDDELL,

*Acting first officer of the  
George Clinton, at the time the  
Rudder was first invented.*

September 20, 1828.

### NO. II.

I hereby certify that on the arrival of the Britannia in New York, in November, 1827, I examined a temporary Rudder, then fitted to said ship, and found it the same in every respect, with a temporary Rudder invented by Captain E. B. Rawson, and fitted to ship George Clinton, in September, 1826, in Long. 45, Lat. 42 30, and I also certify that I assisted in hanging the last mentioned Rudder to the George Clinton.

JAMES B. CORNWELL,

*Second officer,  
Ship George Clinton.*

New York, Oct. 2d, 1828.

### NO. III.

#### CAPTAIN RAWSON.

Sir—Having seen a publication in the American Journal of Science and Arts, of the plan and fixtures of a Rudder on board of the Ship Britannia, I find the plan the same as I saw on board of the Ship George Clinton, you commanded, twelve months before the one fitted to the Britannia, with the exception of an extra guy. There was no other difference in the construction of the two Rudders, as I examined them both, when they were fitted to both ships.

Yours very respectfully,

JEREMIAH J. DICKINSON,

*Master of Ship Roman.*

September 3d, 1828.



## NO IV.

This is to certify, that on the 26th of October, 1828, I examined a temporary Rudder made and fitted to the *George Clinton*, by Captain Rawson, on his return passage from Liverpool, that and the preceding month, and found it the same in every respect as the one which Captain Marshall claims as of his own invention, and which was made more than twelve months after the one made by Captain Rawson. I also examined the Rudder fitted to the *Britannia*, when she arrived in New York, in Nov. 1827, and the difference in construction was so little, that they appeared to have been made by one and the same person.

JOSEPH L. GARDNER,

*Master of the Ship Spartan.*

October 2d, 1828.

New York, December 14, 1828.

B. SILLIMAN, ESQ.

*Dear Sir*—Your letter respecting the temporary Rudder, of which by the request of yourself and Captain B. Hall, (R. N.,) I gave you some account last fall, has been received, and if I have committed myself in any way in so doing, it has been done without the slightest intention of arrogating to myself the least credit as regards its invention. I have a perfect recollection that the one in question varies very materially from the one I had a description of, fitted by Captain Rawson, and I am sure that I admitted to Captain Hall and others, and to Captain Rawson himself, who was at the time of my arrival on the spot, all that part resembling his. Captain Rawson is not here at present, and as I sail again in the course of a day or two, it is entirely uncertain when we may meet. I have no great disposition to contend with him on the subject; my only motive for giving a description of it, was purely to give publicity to what I consider the best thing ever adopted for the purpose, and that others, that might be placed in that unfortunate situation, may be benefited by it; and whether invented by me or him, or both, is to me of very little consequence, and not worth contending about. But why not come forward before? It is certainly due to me that he should furnish you with a drawing and model of the one he actually fitted, and then it may be seen wherein it varied. The Rudder in question also bore some, and perhaps equal, resemblance to one that I had had a description of, fitted by some person out of Boston, but I believe it was admitted at the time, by all who saw it, to vary very much from any one that was ever brought into notice before; however, I shall leave this subject to your own good judgment, to dispose of as you may think proper.

Respectfully and sincerely,

Your obedient servant,

CHA'S H. MARSHALL.

P. S. I presume, could I have a personal interview with Captain Rawson on the subject, it would be an advantageous one to both parties.

New York, February 23, 1829.

MR. BENJAMIN SILLIMAN.

*Dear Sir*—When your favor of November 9th reached New York, I was absent on a voyage to Europe, and a friend whom I had requested to attend to any communication from you, was soon after I left, also called away; your

letter would otherwise have been noticed before. The letter intended for Captain Marshall, was handed him on his arrival here, yet I have not received any communication from him on the subject to which it referred. He has now been absent some time, and from the nature of our profession, it is uncertain when we may meet, perhaps not for years. I can assure you, sir, that there has not been any mistake in this business—Captain M. has laid claim to that which belonged to another. I wish for no credit as the inventor of the Rudder in question, and I would wish you to say nothing more in your Journal than that Captain M. was not the inventor—my principal object at first in writing you, was to inform you of this, that you should see how grossly you had been deceived. I shall be happy to hear from you soon, as I shall leave this port by 4th March. Please direct, care Sam'l Hicks and Sons.

Yours respectfully,

E. B. RAWSON.

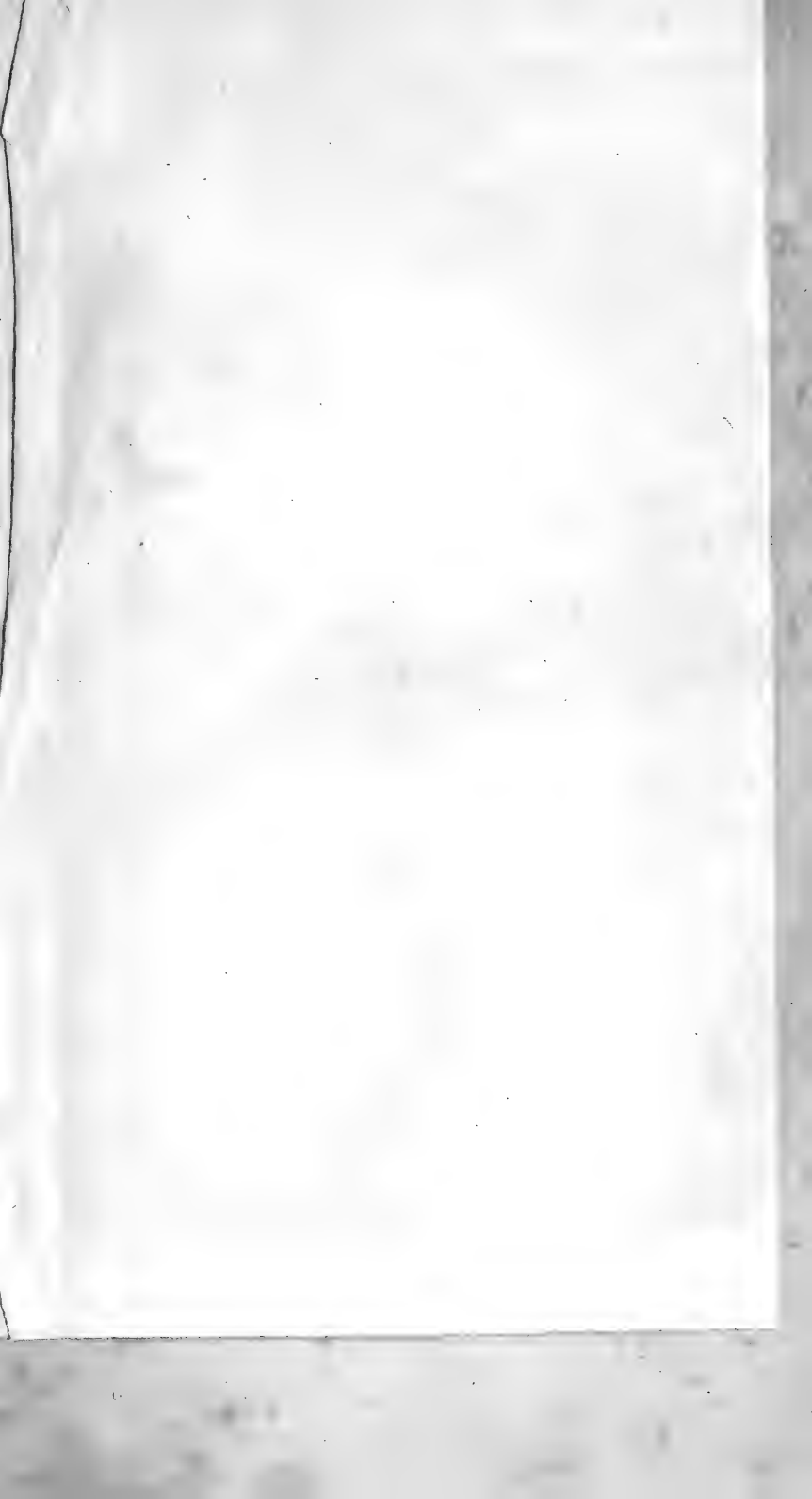



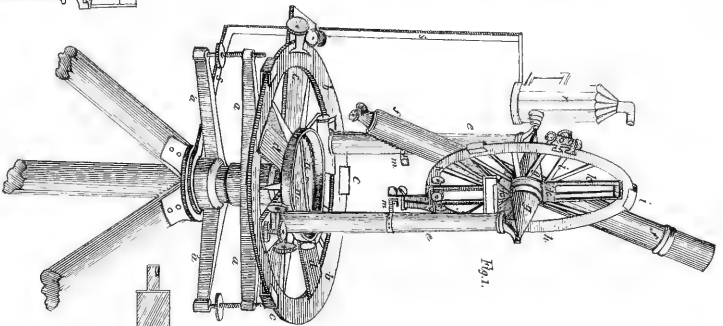

Fig. 1.

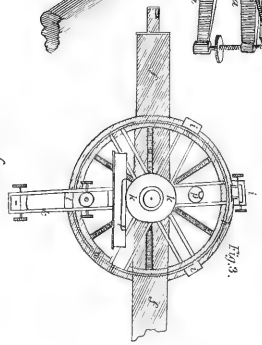

Fig. 3.

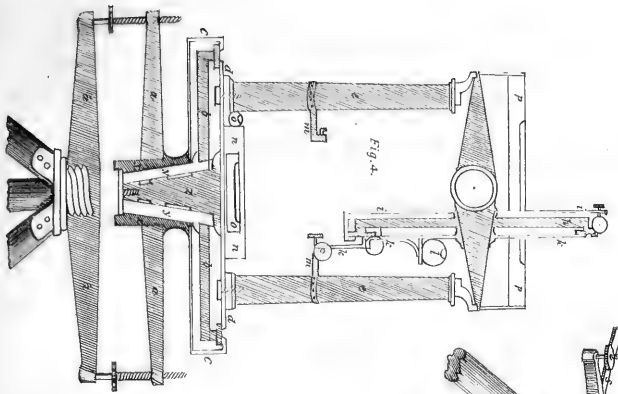

Fig. 4.

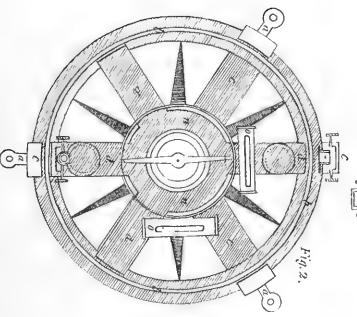
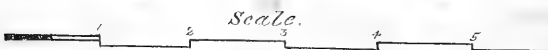
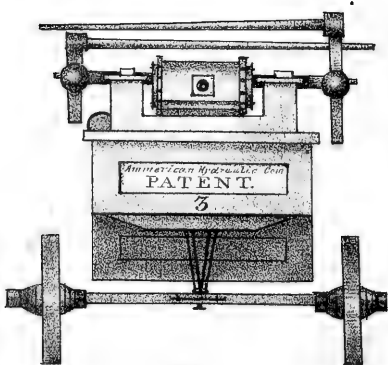
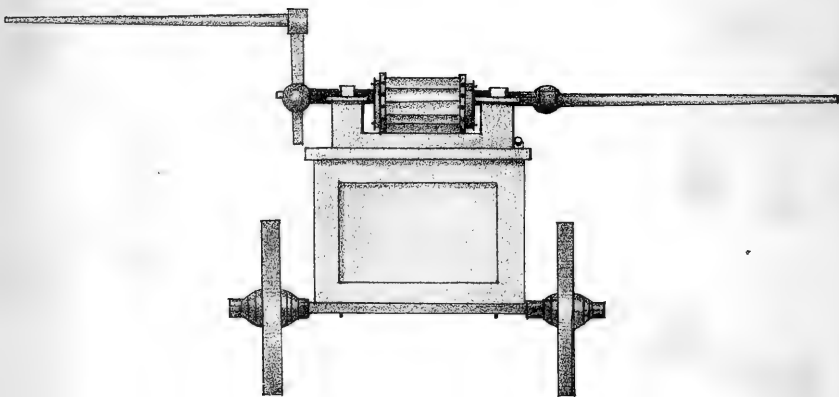
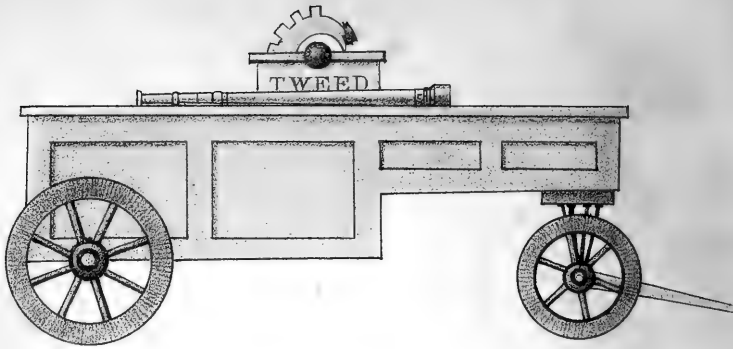

Fig. 2.









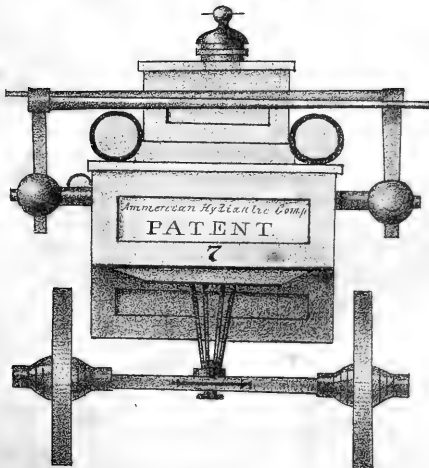
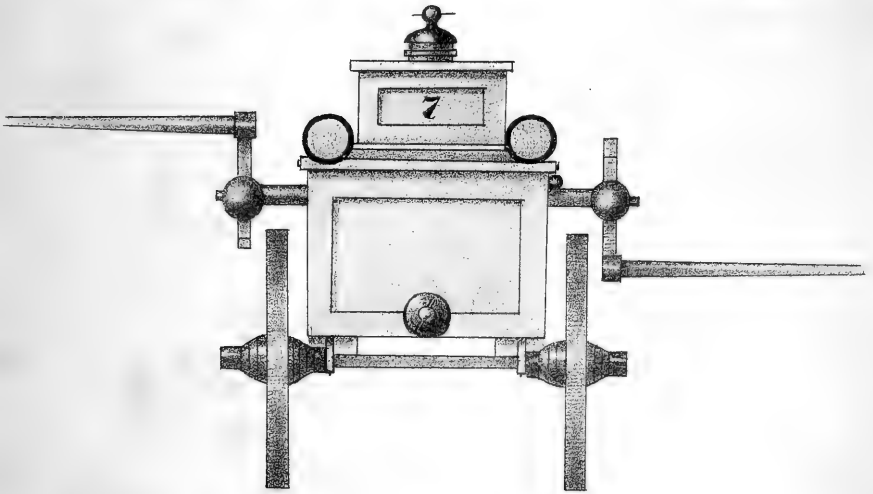
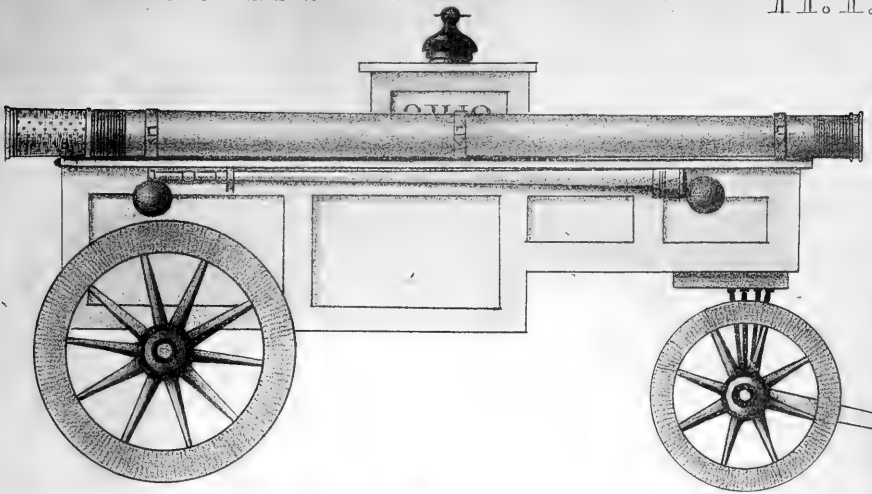







*John P. Cushman*  
*ON*  
*Troy*

THE  
**AMERICAN JOURNAL**  
OF  
**SCIENCE AND ARTS.**

---

CONDUCTED BY  
**BENJAMIN SILLIMAN, M. D. LL. D.**

Professor of Chemistry, Mineralogy, &c. in Yale College; Corresponding Member of the Society of Arts, Manufactures, and Commerce, and Foreign Member of the Geological Society, of London; Member of the Royal Mineralogical Society of Dresden; of the Imperial Agricultural Society of Moscow; Honorary Member of the Linnæan Society of Paris; of the Natural History Society of Belfast; and  
Member of various Literary and Scientific Societies in America.

---

VOL. XVI.—No. 1.—APRIL, 1829.  
FOR JANUARY, FEBRUARY, AND MARCH, 1829.

---

NEW HAVEN:

Published and Sold by HEZEKIAH HOWE and A. H. MALTBY.  
Philadelphia, E. LITTELL.—New York, G. & C. CARVILL.  
Boston, HILLIARD, GRAY, LITTLE & WILKINS.  
London, JOHN MILLER, 40 Pall Mall.

---

PRINTED BY HEZEKIAH HOWE.

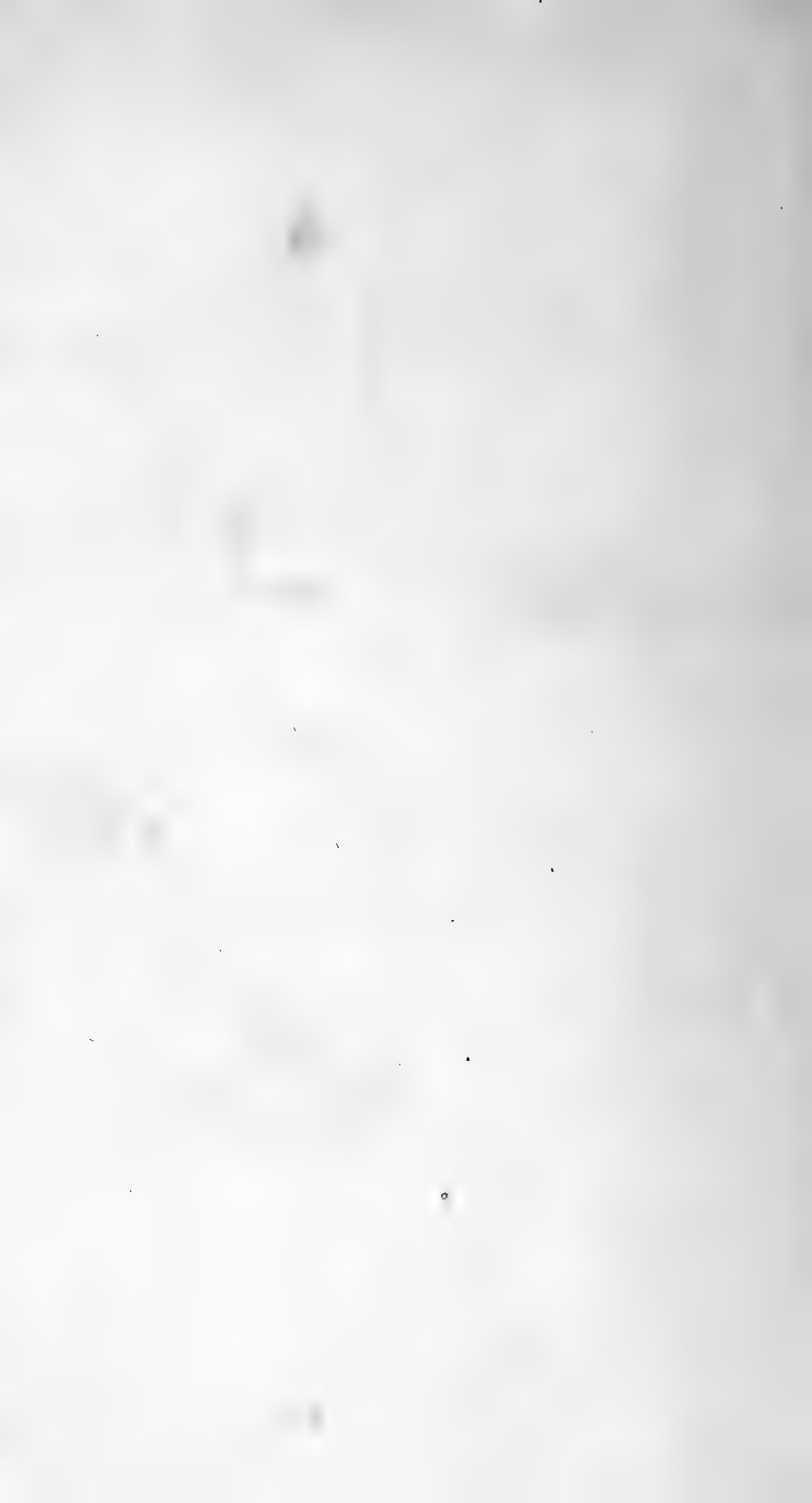

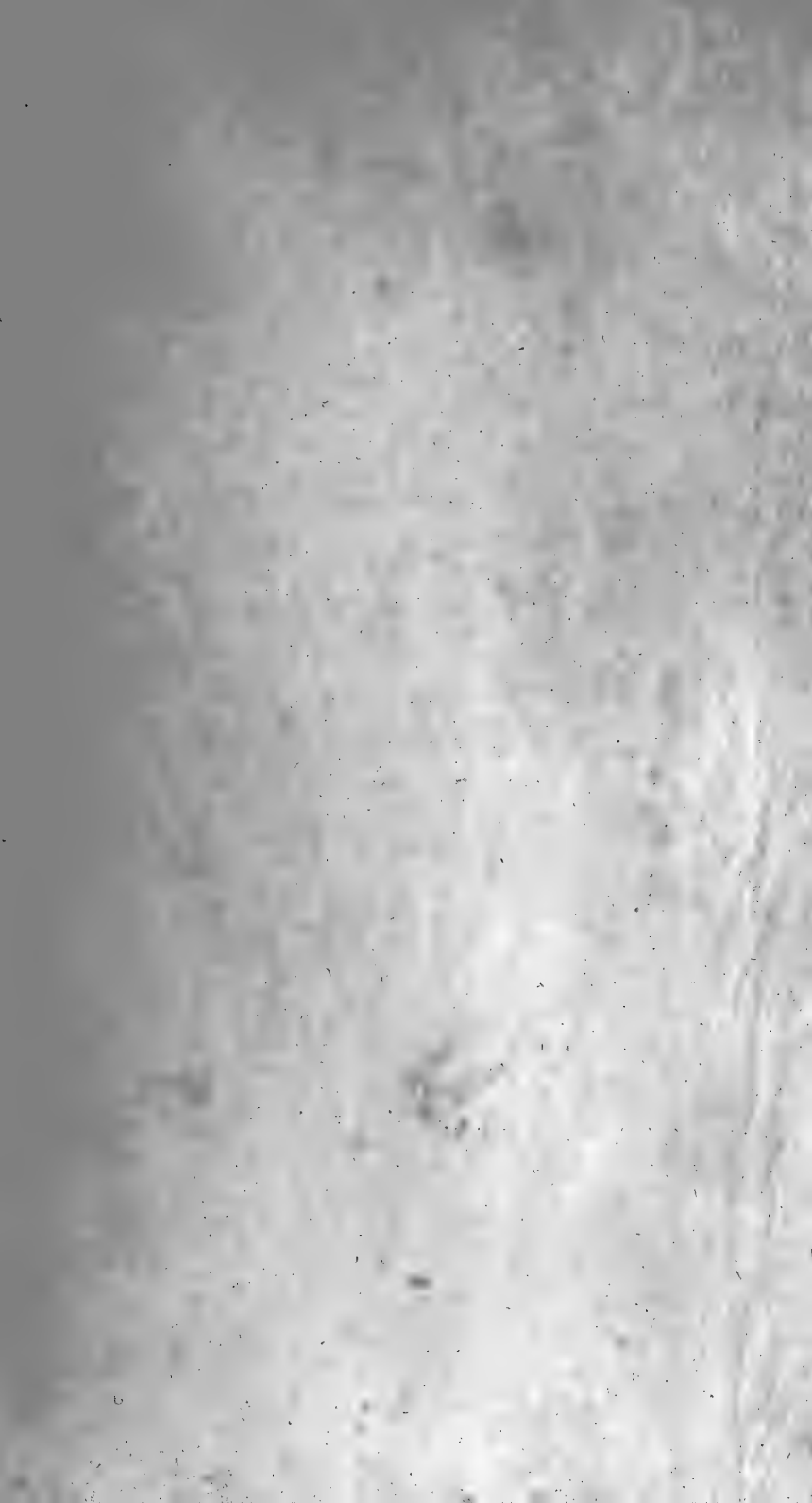





John P. Cushman Esq  
July

THE  
**AMERICAN JOURNAL**  
OF  
**SCIENCE AND ARTS.**

---

CONDUCTED BY

**BENJAMIN SILLIMAN, M. D. LL. D.**

Professor of Chemistry, Mineralogy, &c. in Yale College; Corresponding Member of the Society of Arts, Manufactures, and Commerce, and Foreign Member of the Geological Society, of London; Member of the Royal Mineralogical Society of Dresden; of the Imperial Agricultural Society of Moscow; Honorary Member of the Lunæan Society of Paris; of the Natural History Society of Belfast; and Member of various Literary and Scientific Societies in America.

---

VOL. XVI. No. 2.—JULY, 1829.

FOR APRIL, MAY, AND JUNE.

---

NEW HAVEN:

Published and Sold by HEZEKIAH HOWE and A. H. MALTBY.  
Philadelphia, E. LITTELL & BROTHER. — New York, G. & C. & H.  
CARVILL.—Boston, HILLIARD, GRAY, LITTLE & WILKINS.

---

PRINTED BY HEZEKIAH HOWE.

373







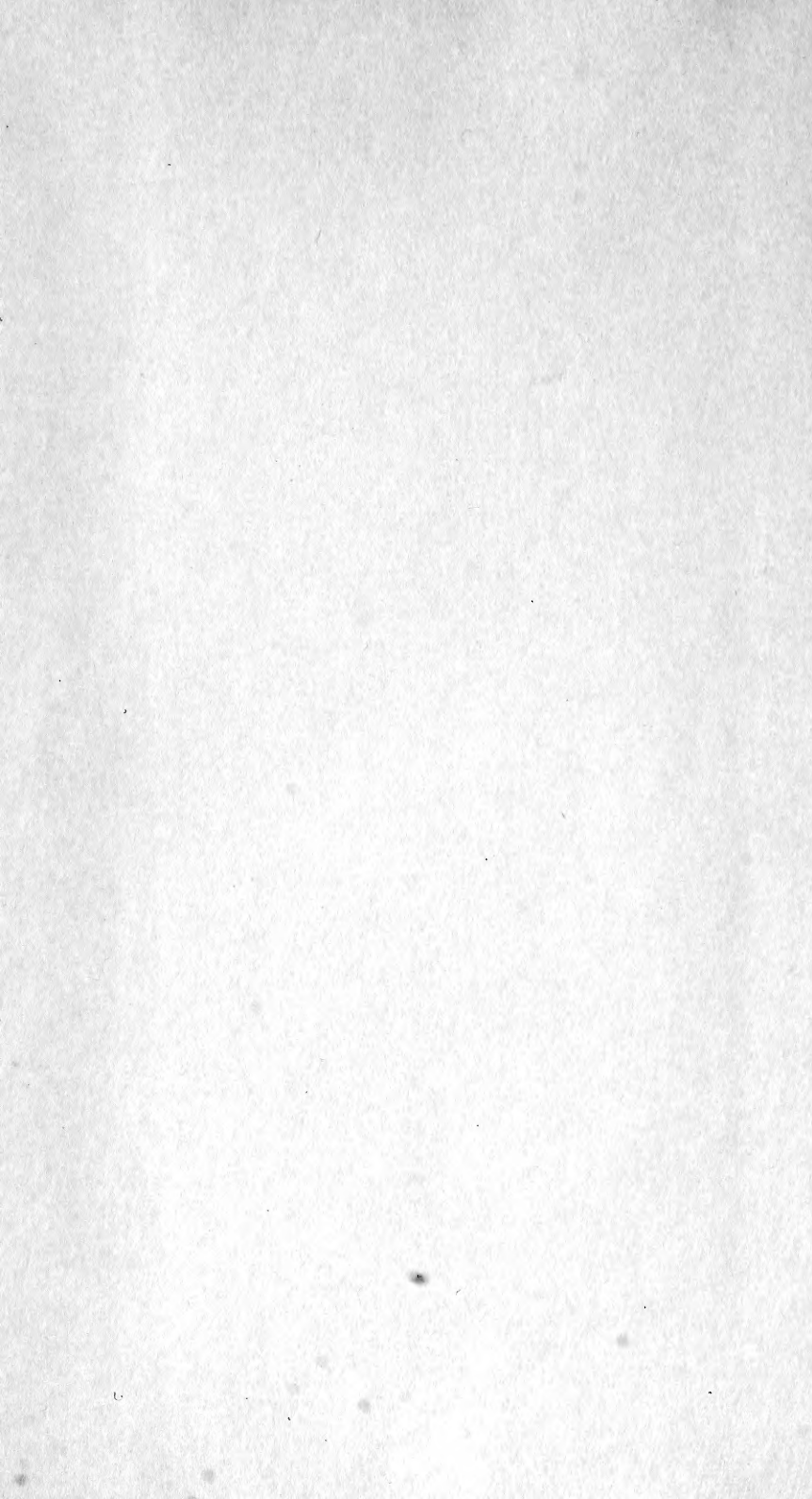



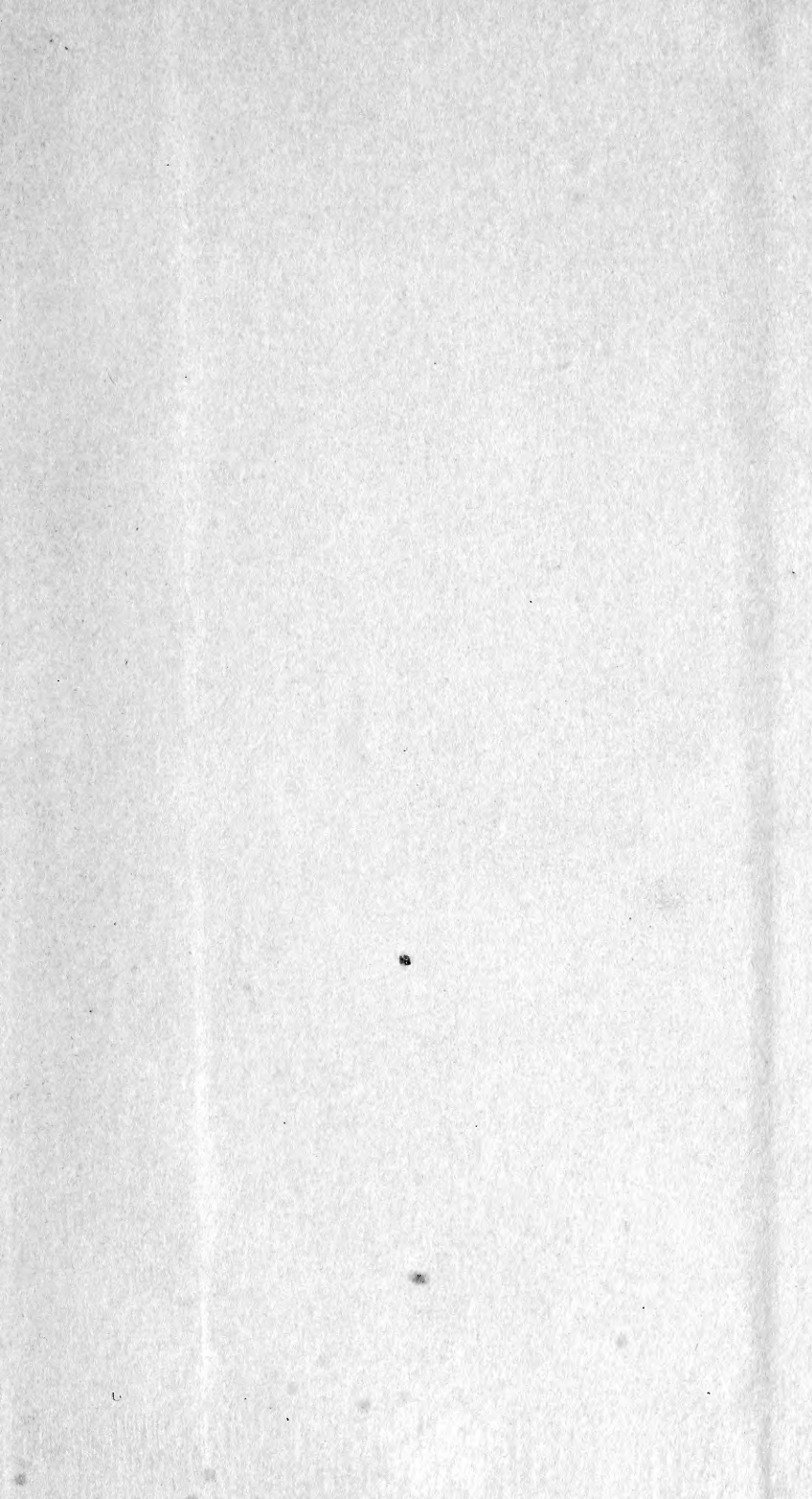

SMITHSONIAN INSTITUTION LIBRARIES



3 9088 01298 4142