

THE AMERICAN JOURNAL

OF

ANATOMY

EDITORIAL BOARD

CHARLES R. BARDEEN
University of Wisconsin

HENRY H. DONALDSON
The Wistar Institute

SIMON H. GAGE
Cornell University

G. CARL HUBER
University of Michigan

GEORGE S. HUNTINGTON
Columbia University

J. PLAYFAIR McMURRICH
University of Toronto

GEORGE A. PIERSOL
University of Pennsylvania

HENRY McE. KNOWER, SECRETARY
University of Cincinnati

VOLUME 27
MARCH—SEPTEMBER, 1920

THE WISTAR INSTITUTE OF ANATOMY AND BIOLOGY
PHILADELPHIA, PA.

CONTENTS

No. 1. MARCH

- H. E. JORDAN. Studies on striped muscle structure. VI. The comparative histology of the leg and wing muscle of the wasp, with special reference to the phenomenon of stripe reversal during contraction and to the genetic relation between contraction bands and intercalated discs. Forty-eight figures..... 1
- CHRISTIANNA SMITH. A study of the lipid content of the kidney tubule. Fourteen figures (two plates)..... 69

No. 2. MAY

- GEO. S. HUNTINGTON. A critique of the theories of pulmonary evolution in the mammalia. Fifteen figures..... 99
- E. A. BAUMGARTNER, M. T. NELSON, AND WM. DOCK. Development of the uterine glands in man. Seven figures..... 207
- ELIOT R. CLARK AND ELEANOR LINTON CLARK. Reactions of cells in the tail of Amphibian larvae to injected croton oil (aseptic inflammation). Fifteen figures..... 221

No. 3. JULY

- JAMES W. PAPEZ. Heart, musculature of the atria. Eight figures (four plates)..... 255
- H. E. JORDAN. Further studies on red bone-marrow. I. Experimental. II. Cytologic, with special reference to the data suggesting intracellular hemocytogenic activity on the part of the giant-cells, and to the significance of the so-called mitotic figures in these cells. One plate (twenty-seven figures)..... 287
- CHIKANOSUKE OGAWA. The finer ramifications of the human lung. Eight figures..... 315
- CHIKANOSUKE OGAWA. Contributions to the histology of the respiratory spaces of the vertebrate lungs. Thirty-eight figures..... 333

No. 4. SEPTEMBER

- ALEXANDER S. BEGG. Absence of the vena cava inferior in a 12-mm. pig embryo, associated with the drainage of the portal system into the cardinal system. Three figures..... 395
- HAYATO ARAI. On the postnatal development of the ovary (albino rat), with especial reference to the number of ova. Four charts..... 405
- LEON AUGUSTUS HAUSMAN. A micrological investigation of the hair structure of the Monotremata. Three text figures and four plates (ninety-eight figures)..... 463

العدد ١٥٤

Resumen por el autor, Harvey Ernest Jordan,
Escuela Médica de la Universidad de Virginia.

Estudios sobre la estructura del músculo estriado. VI. Histología comparada del músculo de la pata y ala de la avispa, con especial mención del fenómeno de reversión de las estriás durante la contracción y la relación genética entre las bandas de contracción y los discos intercalares.

El autor analiza las pruebas expuestas previamente en pro y en contra de la interpretación de una reversión de las estriás durante la contracción, presentando nuevas pruebas derivadas principalmente de un estudio del sarcostilo del músculo alar de la avispa, que demuestra la existencia de una reversión genuina de las estriás en relación con la presencia de un constituyente fuertemente tingible del sarcoplasma. Este constituyente cromático, segregado por el disco oscuro (Q) de la fibra en reposo, se mueve contra el telofragma durante la contracción y contribuye a la formación de la banda de contracción. Esta última puede finalmente modificarse en un disco intercalar. La substancia fuertemente tingible del disco oscuro y la banda de contracción no son idénticas a un constituyente anisotrópico específico del sarcoplasma. El carácter anisótropo claramente estratificado del sarcoplasma durante el reposo es una función de la orientación semejante de las partículas sarcoplásmicas a lo largo de líneas paralelas de resistencia, cuya condición se satisface aún mejor en los discos oscuros a causa de su consistencia fluida relativamente mas considerable.

Translation by José F. Nonidez
Carnegie Institution of Washington

STUDIES ON STRIPED MUSCLE STRUCTURE

VI. THE COMPARATIVE HISTOLOGY OF THE LEG AND WING MUSCLE OF THE WASP, WITH SPECIAL REFERENCE TO THE PHENOMENON OF STRIPE REVERSAL DURING CONTRACTION AND TO THE GENETIC RELATION BETWEEN CONTRACTION BANDS AND INTER- CALATED DISCS

H. E. JORDAN

*Department of Histology and Embryology, University of Virginia Medical
School*

FORTY-EIGHT FIGURES

CONTENTS

| | |
|---|----|
| Introduction..... | 1 |
| Material and methods..... | 5 |
| Nomenclature..... | 5 |
| Review of literature..... | 8 |
| Description..... | 28 |
| <i>a.</i> Leg muscle..... | 28 |
| <i>b.</i> Wing muscle..... | 30 |
| Discussion | |
| <i>a.</i> Telophragma and mesophragma..... | 41 |
| <i>b.</i> Sarcosomes..... | 44 |
| <i>c.</i> The accessory disc..... | 46 |
| <i>d.</i> The anisotropic substance..... | 47 |
| <i>e.</i> Contraction and the contraction band..... | 51 |
| <i>f.</i> Intercalated discs..... | 55 |
| Summary..... | 57 |

I. INTRODUCTION

This investigation centers on the wing muscle of the wasp. The reason for the selection of this particular material is the fact that it forms the basis of Schaefer's²⁸ description of the morphologic changes exhibited by striated muscle during contraction. Upon this description has been built a widely prevalent hypothesis of muscle contraction—the imbibition hypothesis.

This hypothesis takes two distinct forms. In one of these forms some relatively less fluid constituent is supposed to imbibe a relatively more fluid constituent of the intrasarcostylic sarcoplasm, causing in consequence a swelling and shortening of the sarcomeres. In the other form, the swelling and shortening of the sarcomeres are supposed to result from an imbibition of intersarcostylic fluid, much in the manner in which a hempen rope swells and shortens ('contracts') when suspended in water. In an intermediate form this hypothesis occurs in Englemann's conception of muscle contraction. Englemann⁴ explains contraction as the result of the absorption of the isotropic material of the sarcoplasm by the anisotropic constituent, the latter being segregated in the so-called 'dim' disc. But the successful operation of such a contraction mechanism requires suspension in a fluid whose temperature can be raised suddenly. A parallel of this muscle-contraction mechanism is believed to be given in a string of catgut suspended in water, the temperature of which can be raised suddenly by the passage of an electric current. This compromise theory of muscle contraction accordingly makes an intrasarcostylic imbibition process, on the part of the isotropic and anisotropic constituents, dependent upon an imbibition of fluid by the sarcostyle as a whole.

Schaefer^{27,28} discards this thermodynamic hypothesis of muscle contraction, and explains contraction as the result of the passage of the relatively more fluid 'hyaline substance' of the clear disc into 'pores' within the less fluid 'sarcous substance' of the dark disc, thus effecting a horizontal widening and a longitudinal shortening of the sarcomere. But, as will be shown below, reference to Schaefer's illustration of a so-called 'contracted' sarcostyle of the wasp's wing muscle, upon which he bases this explanation, makes it clear that this supposed intrasarcomeric imbibition of a fluid by a semisolid substance demands that the sarcostyle be bathed by a hypotonic solution (not an isotonic medium, as normally), and this fact removes Schaefer's hypothesis to the same category as that of Englemann.

The later chief exponents of a frank imbibition hypothesis of contraction are McDougall¹⁴ and Meigs.¹⁵ The latter claims to

be able to add support to McDougall's theory by his data from a detailed microscopic study of the sarcostyle of the wing muscle of the fly. These investigators advocate a close parallel between the phenomenon of muscle contraction and the swelling and consequent shortening resulting from endosmosis; and between relaxation and the reduction of swelling and the consequent lengthening resulting from exosmosis.

Englemann⁴ claims to be able to demonstrate by means of the micropolariscope that the anisotropic substance, which he regards as constituting the 'dim' band, does not change its location during contraction. Schaefer, by means of Rollet's gold-chlorid technic, claims to have proved the same fact. Schaefer, accordingly, identifies the substance which stains with gold chlorid with the anisotropic material of the sarcoplasm. The earlier investigations of Merkel,¹⁷ Rollet,²² and Tourneux,³⁰ on the contrary, seemed to demonstrate a reversal of striae during contraction. These investigators claim that the anisotropic substance of the 'dim' band of uncontracted muscle divides along the mesophragma and moves in opposite directions toward the terminal telophragmata of the sarcomere to form the anisotropic contraction bands of contracted muscle. Contraction is by them conceived to be the result, or at least an accompaniment, of the movement of anisotropic materials from mesophragma to telophragma, producing thus a reversal of striations. No attempt is made to explain the fundamental relation between this movement of the anisotropic constituent of the sarcoplasm and the coincident contraction of the sarcostyle. Rutherford²⁶ also concludes for a reversal of striation during contraction, and identifies the 'chromatic element' (dark disc) of the sarcoplasm with the anisotropic substance.

The phenomenon of contraction, as expressed primarily in the formation of a contraction band, has become intimately related to the question of the significance of the intercalated discs of cardiac muscle. It is now clear that none of the earlier hypotheses which interpreted these discs as intercellular cement lines, tendons, or developing sarcomeres are any longer tenable. In a series of papers I have developed the hypothesis that the inter-

calated discs, which I am now able to demonstrate also in human leg muscle,⁹ are essentially modified irreversible contraction bands. But Schaefer claims that a contraction band is an optical illusion. This claim is based chiefly upon his description of an alleged contracted sarcostyle of wasp's wing muscle treated with Rollet's gold-chlorid technic. It became necessary, therefore, in the interests of my interpretation of intercalated discs, to reinvestigate wasp's wing muscle. A comparative study of the sarcostyle of this muscle after treatment with Rollet's and other technics, has convinced me that what Schaefer describes as a functionally contracted sarcostyle is in fact one that has become swollen and in consequence shortened; that is, one artificially contracted, through the action chiefly of the acidulated hypotonic (formic-acid-water) solution employed in Rollet's technic. In a functionally contracted sarcostyle of this wing muscle, as in insect leg muscle and other striped muscle generally, there occurs a genuine reversal of striations during contraction as regards a darker colored and more deeply staining constituent of the 'dim' disc.

It may be stated at once that there is no absolutely definite correspondence between the distribution of the anisotropic constituents of the sarcoplasm and the limits of the deeply staining substance of the dark discs at the different functional phases. An unstained fiber appears striped, not because the anisotropic material is segregated into definite narrow strata (discs), but because of a chemically different, as demonstrated chiefly by a difference of staining reaction, and a darker sarcoplasmic constituent segregated in the darker 'bands.' This same substance, not a specific anisotropic substance, stains deeply in basic dyes and gives to microscopic preparations, as compared with living material, a similarly transversely banded appearance. In the following pages attention will be directed primarily to the behavior of this substance during contraction, and to its relation to the formation of intercalated discs.

II. MATERIAL AND METHODS

In addition to the wing and leg muscles of the wasp, I used for comparative study similar material from fly, bee, and eyed elater (*Alaus oculatus*). These materials are practically identical, except that the sarcostyle of the wasps' wing muscle has a slightly smaller diameter than that of the elater, and a slightly greater diameter than that of the fly. The several technics of investigation included examination of fresh material in Ringer's solution, in distilled water, and in a 2 per cent sodium-chlorid solution; examination in Toison's solution, which proved exceptionally satisfactory; examination of alcohol-fixed material in water, in glycerin, and in hypotonic salt solutions; Rollet's gold-chlorid technic; fixation in 90 per cent alcohol, in strong Flemming's fluid, and 10 per cent formalin, followed by iron-hematoxylin staining with and without eosin and Van Gieson's counterstain.

III. NOMENCLATURE

The present lack of uniformity in the terminology employed for the description of striped muscle structure is confusing and adds an extra element of difficulty to an inherently complex subject. The time seems ripe for insistence upon a uniform, meaningful, and precise terminology. In an effort to select from the profusion of proposed terms the most satisfactory designations, I shall be guided by two principles: 1) The omission of proper names; 2) preference for the term which expresses most regarding structure and essential relations. To these I shall add in brackets the more widely used synonyms, advocating their early discardure.

Sarcostyle would seem to be an acceptable designation for the unit of muscle structure, and, from the viewpoint of comparative histogenesis, preferable to its synonym *myofibril*. The protoplasmic substance of the sarcostyle may be designated *sarcoplasm*. Within the sarcostyle may under certain conditions be discerned constituent still smaller fibrils. Regardless of the question whether these subdivision are artificial separation products

or genuine elementary fibrils, they are conveniently designated *metafibrils*. However fitting the term *sarcolemma* would be for designating the membranous envelope of the sarcostyle, this word should probably be retained in the sense of referring to the cell membrane enveloping the smooth muscle cell, or the myoblast, or the definitive striped muscle fiber taken as a whole. For the envelope of the sarcostyle, I would suggest the term *sarcostylic membrane*. In macerating fluids and under mechanical stresses the sarcostyle becomes broken up at definite levels into regular segments, the *sarcomeres* (inokommata). These are bounded terminally by definite membranes, the *telophragmata* (Krause's ground membranes, Dobie's lines, intermediate membranes). The telophragmata are continued into the intersarcostylic fluid spaces and serve to bind together the adjacent fibrils of a muscle fiber. Each sarcomere contains a median darkly colored, more deeply staining, *dark disc* (dim disc, transverse disc of Brücke, sarcous element of Bowman). This dark disc is under certain conditions bisected by a light *median disc* (Hensen's disc), which is in turn bisected by a delicate membrane, the *mesophragma* (median membrane of Heidenhain).

Between the terminal telophragmata and the median dark disc lie the *light discs* (clear discs, intermediate discs of Krause, hyaline substance of Schaefer). In insect leg muscle the light discs are frequently bisected, or crossed close to the telophragmata, by a delicate, dark, granular disc, the *accessory disc* (disc of Merkel and Rollet). Under these circumstances, the portions of the light discs between the terminal telophragmata of the sarcomere and the accessory discs are designated the *end discs* (discs of Englemann).

This condition of stratification of chemically and physically different substances within the sarcostyles gives to the fiber, when viewed under low magnification, a striped or banded appearance, a light 'band' alternating regularly with a dark 'band.' It is obvious, however, that we are actually dealing with discs (and membranes), not with genuine 'bands' or 'stripes.' But the designation 'striped' or 'striated' may continue to be employed rather than the more precise term 'stratified' as applying

to the appearance, rather than the intimate structure, of the muscle fiber and the sarcostyle. In referring to a disc, the term *length* (thickness) may be used to indicate the longitudinal extent, the term *width* (breadth) when speaking of the extent transverse to the long axis of the fiber.

A system of indicating the several discs and membranes by letters has now been in general use since the time of Rollet's earlier papers on striped muscle structure ('85). These letters are the first of the respective German names designating the discs and membranes. If such a system is used at all, it seems better to retain that employed by Rollet. The only change that might possibly make any claim to effecting a gain would be the substitution of the letter 'T' to designate the telophragma, for the letter 'Z' (for *Zwischenscheibe*). 'M' could then continue to stand for mesophragma as well as for 'Mittelscheibe.' The terms telophragma and mesophragma (collectively inophragmata), proposed by Heidenhain, are so precise and convenient that their general adoption seems assured. The so-called 'contraction band,' fundamentally a composite structure, is actually a *contraction disc* completed axially in cardiac muscle by the telophragma; and the so-called intercalated 'disc' is generally more nearly a band; that is, a peripheral portion of an earlier contraction disc. The intercalated disc is a more or less deeply extended band; or it may encircle the entire fiber in the form of a ring or perforated disc. It seems strange that the actual discs are commonly referred to as bands, and that the only structure that is not really a disc nevertheless continues to be designated 'intercalated disc.' But long-continued, uniform usage has too firmly established these latter terms to warrant change at this time, especially in view of a prevailing sense of uncertainty regarding the complete history and intimate composition of these structures.

Summarizing the foregoing suggestions, the parallel designations of the principal discs and membranes, in terms of characters and abbreviations that best seem to commend themselves, are as follows (figs. 1, 2, and 10):

| | |
|-------------------------------|----------|
| Telophragma..... | T (or Z) |
| Light disc..... | J |
| Dark disc..... | Q |
| Median disc..... | H |
| Mesophragma..... | M |
| Accessory disc..... | N |
| End disc..... | E |
| Contraction disc (band)..... | C.B. |
| Intercalated band (disc)..... | I.D. |

IV. REVIEW OF LITERATURE

For the purpose of putting into sharper relief the central points at issue, it seems desirable here to review the literature and to appraise the illustrations bearing directly on the significance of the contraction band of functionally contracted muscle, and on the question of the similarity of this band to the simplest type of intercalated disc.

The most satisfactory figure illustrating the changes in striped muscle during contraction is that by Rollet²³ of a fixed and stained lateral contraction wave in the leg muscle of the chrysomelid beetle, *Cassida equestris* (fig. 1). At the right the fiber is said to be in extension; at the left, under Doyere's hillock, in the fully contracted condition. Contraction involves a movement of the separating halves of the dark discs in opposite directions and a fusion of the approaching halves of adjacent dark discs about the telophragma. This fusion involves also the intervening accessory discs. The result is a deeply staining contraction band, comprising one telophragma, two accessory discs, and two opposite halves of adjacent dark discs. There has occurred, accordingly, a reversal of striations during contraction as regards a deeply staining substance located in Q and N in the extended condition and transferred to the contraction band, originating about the telophragma, in the contracted condition.

Rollet^{22,24} agrees with the earlier conclusion of Merkel ('72) that the moving substance in contraction is the anisotropic constituent of the sarcostyle. Rollet's figures²³ of similar fibers, as viewed under crossed nicols, show all of the deeply

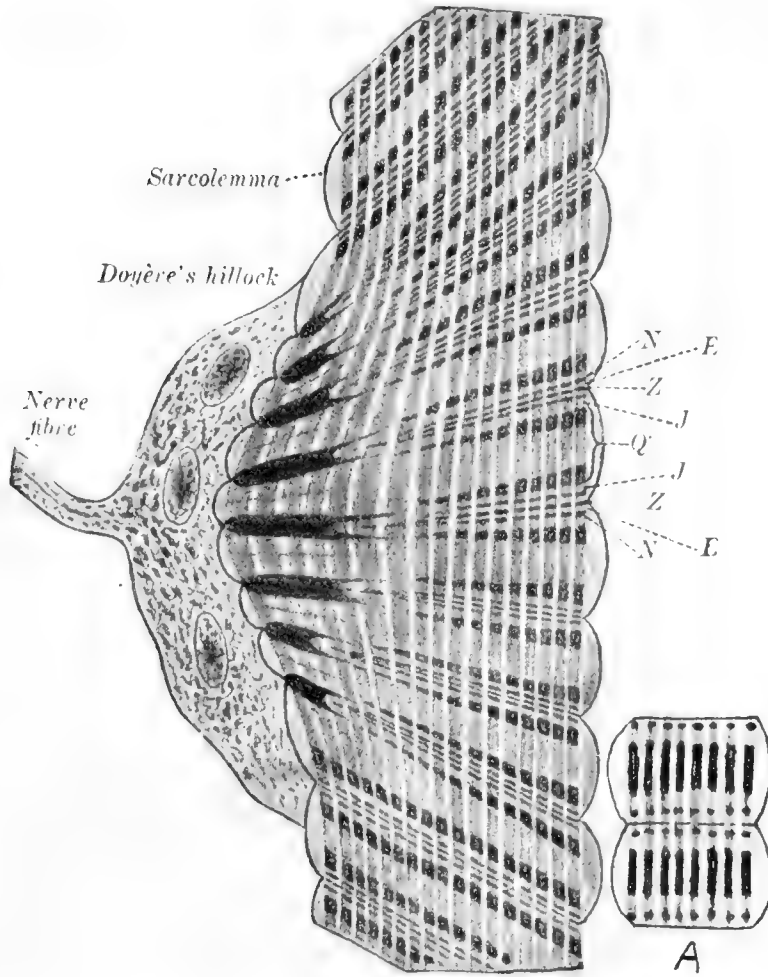

FIG. 1. Illustration of fixed and hematoxylin-stained specimen of muscle fiber of *Cassida equestris*, showing at the left a lateral 'contraction wave' including eight 'contraction bands' (according to Rollet). At the right, at A, the writer has added two sarcomeres to illustrate his conception of the condition in the relaxed muscle fiber. The right-hand border of Rollet's figure is, according to the writer's interpretation, at midphase of contraction. The contraction band includes opposite halves of two successive Q-discs, the intervening N-discs, and the bisecting telophragma. There occurs during contraction a true reversal of striation as regards a deeply staining substance of the Q-discs and the contraction bands. Illustrations of similar fibers viewed with the micropolariscope, show Q, N, and Z anisotropic in nature; hence we may infer that Rollet regarded also the contraction band as anisotropic and interpreted the reversal of striation as the result of a change of position of the anisotropic substance of the Q-discs of the relaxed fiber.

staining portions along the right border of the figure (N, Z, and the separated halves of Q) as anisotropic in physical constitution. Accordingly, he interprets the contraction band as composed of the anisotropic substance which was segregated within the Q disc in the relaxed fiber. The question of the distribution of the anisotropic substance at different functional phases will be fully discussed below. It will suffice here to point out that Rollet identifies the anisotropic with the deeply staining substances of the sarcoplasm. It may be stated now, in anticipation of the subsequent fuller discussion, that the anisotropic constituent of the sarcoplasm maintains no precise correspondence with the deeply staining portions of the sarcolemma.

Two other points pertaining to this illustration must be touched: the festooning of the sarcolemma and the absence of sarcomeres in which the Q disc is undivided. A festooned sarcolemma is not an invariable coincidence of contraction. It may be claimed that in general the festooned condition of the sarcolemma is a fixation artifact. As to the second point, the right-hand border of the fiber here illustrated is probably not in extension (nor in relaxation), as is assumed by Rollet. At A I have added a diagram of two sarcomeres to illustrate the condition of a fiber in repose. The dark disc is not divided by the presence of an H disc. Rollet's fiber is at a midphase of contraction at the right. The occurrence of an H disc is a coincidence, and an index, of contraction. The type of fiber shown at A is a very common one in microscopic preparations. If the fiber of Rollet's figure were actually extended at the right, then somewhere between the right and left (contracted) borders of the illustration we should expect to find a condition like that shown at A. As will be made clear below, the illustration, A, represents a sarcomere in repose. Such a fiber, in the extended condition, would simply have a longer (thicker) Q disc. I interpret Rollet's figure as illustrating a fiber at midphase of contraction at the right, in full contraction at the left.

In my study with Banks of intercalated discs in heart muscle,¹¹ I based my interpretation of the significance of these discs on

Rollet's description and illustration of the contraction band in contracted muscle. Such contraction band and the simplest 'band' type of intercalated discs are essentially identical, except that the latter generally only represents a portion of the former. We need only postulate that under certain conditions a contraction band becomes incapable of reversal (disappearance) in whole or in part to secure the beginnings of the several varieties of the simple band type of intercalated disc.

The contraction band is a composite structure, consisting of two (or four, where accessory discs occur) deeply staining portions of separate origin fused about a definitively bisecting telophragma. If the entire contraction band should fail to reverse, then there would result the variety of intercalated disc bisected by the telophragma. Subsequently this primary condition becomes modified by increase of tissue fluid within the disc, as indicated by its reaction to silver-nitrate treatment. This variety is ontogenetically and phylogenetically the primitive form of disc. It may represent the complete contraction band, in which case it becomes a genuine 'disc,' or more generally only a portion of the contraction band. 'Entire' as used above only refers to the longitudinal length, that is, to the double constitution of the disc, not to its radial extension. If only one of the halves of the contraction band fails to reverse, there results the variety of disc only bounded on one side by a telophragma. The variety of intercalated disc bounded on both sides by a telophragma may be conceived to arise by a subsequent modification, due mainly to the accumulation of tissue fluid, resulting essentially in a fusion, of two adjacent irreversible halves of successive contraction bands.

From these three varieties of the primitive band type, classified according to relation to telophragma, the several varieties of the more complex step-type are readily derived through the operation of secondary mechanical factors, inherent in the oblique stresses of the functioning heart due to the profusely branched condition of the definitive myocardial trabeculae. The still more complex serrated type, especially abundant in hypertrophying hearts, is the result of factors inherent in the

processes of a longitudinal splitting of sarcostyles and the irregular tensions prevailing in abnormal hearts. Still another but rare type of disc, in appearance little more than a thickened telophragma, may be explained as the telophragma constituent of a contraction band from which a remnant of the deeply staining substance failed of removal at relaxation, the whole subsequently becoming modified by the accumulation of tissue fluid. This last type will be further discussed below.

In order more firmly to establish my hypothesis that intercalated discs represent essentially modified irreversible contraction bands, as above briefly outlined, I undertook a thorough histologic study of the contraction phenomena in the leg-muscle of the sea-spider.⁷ I convinced myself, in the study of this material, of the essential accuracy of Rollet's description of the formation of the contraction band. Figure 2, taken from an earlier paper, is here reproduced to further emphasize my agreement with Rollet in regard to the formation of the contraction band, and to illustrate the details in our disagreement regarding the specific morphologic characteristics of the relaxed condition of the sarcomere. Portions of four fibers (A to D) are shown, arranged in horizontal series from left to right according to the degree of contraction. Fiber A is in a condition of repose. Arrows, Z, mark the limits of a single sarcomere. The dark disc (Q) stains very deeply throughout and exists as a compact undivided disc. The accessory disc (N) is faintly visible on either side of Z in the light disc (J). Fiber B is just passing into an early phase of contraction. The dark disc has become longer while the sarcomere as a whole has become shorter. Moreover, the dark disc is becoming lighter medially, the constituent myofibrils having become distinctly knobbed, and, if possible, still more deeply staining terminally. This condition clearly demonstrates a movement of the deeply staining substance toward Z. In fiber C contraction is approximately at midphase. The dark disc is now bisected by the secondarily formed median disc (H). The resulting halves of Q have fused in part with the accessory discs encountered in their passage toward Z. The dark disc, including H,

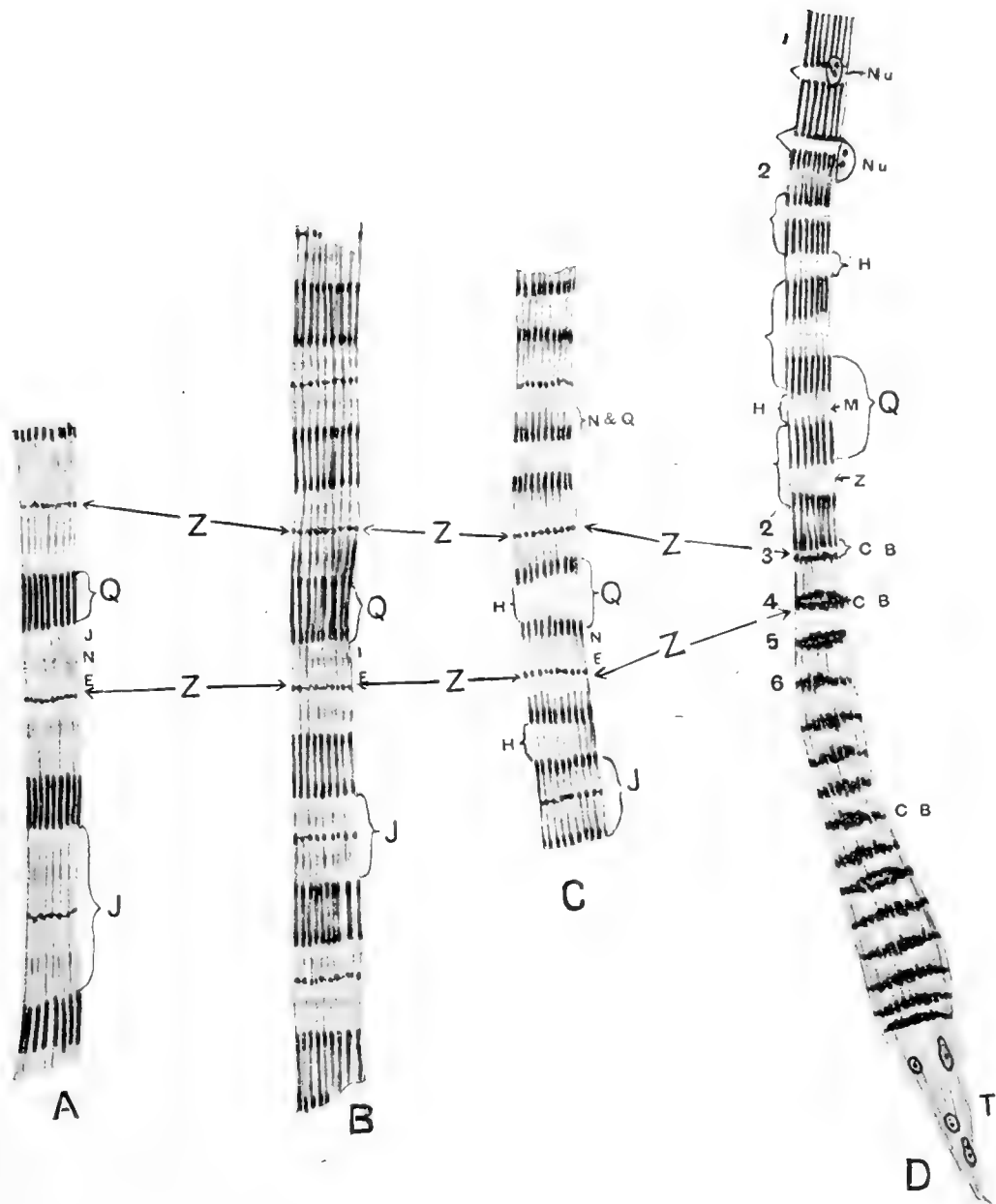

FIG. 2 (A, B, C, and D) Four successive functional stages of a leg-muscle fiber of the sea-spider, *Anoplodactylus lentus*. Fiber A is in the relaxed condition, fibers B, C, and D in successively later phases of contraction. Identical stages, in the same seriation, are met with when the four fibers are considered in a horizontal direction (between the telophragmata, Z), and when fiber D is considered in a vertical direction. This correspondence between the order of succession of the different levels of fiber D and the order of seriation of the four fibers would seem to prove this horizontal seriation correct. During contraction, therefore, the deeply staining substance of the Q-discs of the relaxed fiber (A) divides and flows in opposite directions from the midline (mesophragma) toward the adjacent telophragmata (B), meanwhile involving the N-discs (C) and uniting about the telophragmata (D) to form the contraction bands (Cb) of the contracted fiber. There occurs here a true reversal of striation as regards the deeply staining substance of Q during the formation of the contraction bands. The H-disc is a coincidence of contraction. Fiber D is stretched in its middle portion (according to Jordan: *Anat. Rec.*, vol. 10, p. 493, 1916).

is still longer than in fiber B, but the sarcomere as a whole is shorter. In fiber D appear successively later phases in the formation of the contraction band (levels 2', 3, 4, 5, and 6). The sarcomere has become reduced to less than half the length of that of the relaxed fiber. The contraction band consists of the fused opposite halves of successive Q discs, and the two involved accessory discs, the whole bisected by a telophragma. That the horizontal seriation as here given is correct is proved by the fact that the same phases follow in the same order in passing from top to bottom of fiber D, which is still relaxed above but fully contracted below.

Three additional important data are contributed by this illustration. The sarcolemma of the contracted fiber (D) is not normally festooned. The second datum relates to the modifications produced in the structure of a fiber by stretching. A fiber may be stretched at any phase of contraction. This simple fact is of prime importance; it may not safely be ignored in the interpretation of any particular fiber when judging of its functional condition on morphologic grounds. In fiber D, by reason of the condition of full contraction at the lower end, the middle portion, which is only at midphase of contraction, has become greatly stretched. The effect of this stretching influences chiefly the length of Q. Comparison of the length of the sarcomeres of this portion of the fiber with the length of the sarcomeres in an unstretched fiber in the relaxed condition, in disregard of the special condition obtaining in the case of the former fiber, would lead to the erroneous conclusion, widely held at the present time, that the presence of an H disc is an indication of stretching superimposed upon a sarcomere in repose. This matter will also be further discussed below. The portion of fiber D, here under consideration, discloses a third important fact, namely, that the apparent absence of a mesophragma may be an illusion, for the reason that its structure is too delicate to come within the limits of microscopic vision. The longitudinal tension imposed upon the middle portion of this fiber by the stretching relaxes the horizontal tension under which the mesophragma exists in the resting and especially in the contracted

condition of the fiber and so, by reason of an inherent elasticity, permits the mesophragma to contract and coarsen to the point of possible observation. Such observation is further aided by the special functional conditions obtaining in this portion of the fiber; the presence of the H disc at the midphase of contraction allows the darker mesophragma to stand forth more conspicuously within the clear (H) portion of the dark (Q) disc.

Figure 3, of a fixed and stained muscle fiber from the lobster's antenna, interpreted as relaxed above and contracted below, according to Dahlgren and Kepner,³ shows with exceptional clearness exactly the same conditions with respect of the undivided character of the dark disc of the sarcomere in repose, and the steps in the formation of the contraction band. However, this illustration presents one serious difficulty: while the sarcomere of the relaxed portion measures in the figure 11 mm. in length, that of the portion interpreted as in contraction measures only 3 mm. less. But the length of a contracted sarcomere as compared with its relaxed associate is approximately two-thirds less. Since the character of the 'striations' of this fiber indicates contraction at the lower end, the nearly equal length of the sarcomeres at the two ends must be explained on the basis, supplied by the data relating to the sea-spider leg muscle, of a superimposed tension at the lower end.

Figure 4, showing a wave of contraction passing over a living (unfixed and unstained) leg-muscle fiber of the beetle (*Dytiscus marginalis*), according to Schaefer,²⁸ demonstrates the same essential points regarding the formation of the contraction band, namely, an origin by fusion along the telophragma of the opposite halves of successive dark discs. It illustrates likewise a genuine reversal of striation, contrary to the opinion of Schaefer, who interprets the specimen as demonstrating that the apparent reversal is not real, but simply an optical illusion. Schaefer's explanation of the basis of this 'optical illusion,' however, harmonizes better with our description of what occurs during contraction than with his description of the essential phenomenon of contraction in wasp's wing muscle with which the *Dytiscus* leg-muscle is said to agree. He says, "The dark bands of the

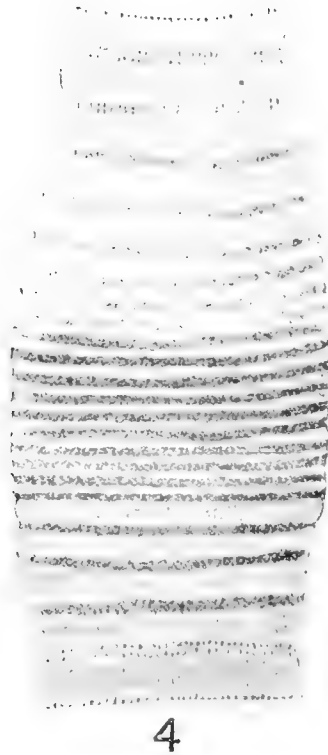
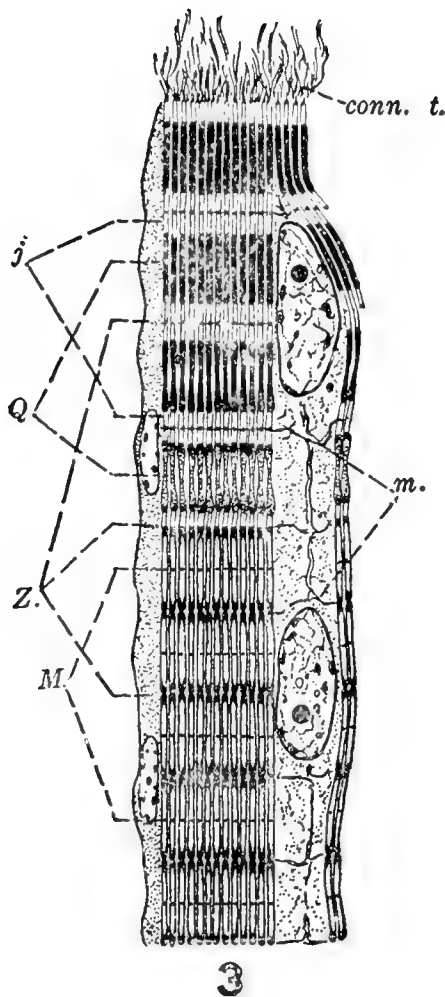

FIG 3 Illustration of a fixed and stained specimen of a contracting muscle fiber from the lobster's antenna, showing a reversal of striation as regards a deeply staining substance of the Q-disk of the relaxed portion (above) of the fiber (according to Dahlgren and Kepner). *J*, light disc; *Q*, dark disc; *Z*, telophragma; *M*, mesophragma; *m*, extensions of telophragmata into perinuclear sarcoplasm; *conn.t.*, tendon fibrils which attach the muscle to the hypodermis.

FIG. 4 Illustration of contraction wave on living leg-muscle fiber of *Dytiscus marginalis* (according to Schaefer). The 'apparent' reversal of striae in the formation of the contraction bands of the middle portion is explained by Schaefer as due to accumulations of sarcoplasm, appearing as dark lines, which obscure the continuity of the fibrils and by contrast cause the whole of the sarcomeres between them to appear light. The writer interprets this illustration as being in strict accord with the illustrations of fixed and stained fibers, figures 1, 2, and 3; therefore, as demonstrating a true reversal of striae, in the formation of the contraction band, as regards a deeper colored substance of the dark disc.

contraction wave are seen to be really due to accumulations of sarcoplasm. These accumulations appear as dark lines which obscure the continuity of the fibrils, and by contrast cause the whole of the sarcomeres between them to appear light'' (p. 137).²⁷ The 'accumulations of sarcoplasm' that Schaefer here postulates are inter-sarcostylic accumulations at the levels of the telophragmata. But this explanation assumes a beaded condition of the sarcostyle with constrictions at the telophragma levels. Beading, however, is not a normal accompaniment of contraction, but, as will be demonstrated below, a fixation or osmotic artifact. Moreover, it must be emphasized that the single sarcostyle of wing muscle likewise shows this phenomenon of stripe reversal during contraction. In fact, this phenomenon as exhibited by a complete fiber is simply the sum effect of the stripe reversals in the constituent myofibrils. The explanation of the phenomenon on the basis of an accumulation of inter-sarcostylic sarcoplasm must, accordingly, for a second reason be discarded as inadequate.

Still another explanation of this phenomenon of stripe reversal as an optical illusion might be based on Schaefer's diagram²⁷ of the intrasarcomeric changes during contraction (fig. 9). This diagram purports to explain contraction as the result of the absorption of the 'hyaline substance' of the light disc by the 'sarcous substance' of the dark disc. If this be accepted as representing actual conditions during contraction, then the apparent reversal of striation could very plausibly be explained as the result of a relative condensation of the area about the telophragma and a relative rarefaction of the area about the mesophragma, that is, in the original dark disc. But the direct evidence points unmistakably to a movement of fluid in exactly the opposite direction from the one here assumed, namely, from the mesophragma against the telophragma. We are accordingly unable, in view of the microscopic evidence, to escape from the conclusion that an actual reversal of striation, as regards the dark substance of the sarcoplasm, occurs during contraction.

Figure 5 shows a reproduction from Schaefer of Englemann's photomicrographs²⁷ of the same fixed fiber, said to be contracted

toward the middle, as it appears with uncrossed (B) and with crossed (A) nicols, respectively. But the illustration does not give convincing proof that the bulged middle portion is actually contracted. This area suggests rather a distortion. Skepticism regarding a genuine contraction is further aroused by the fact

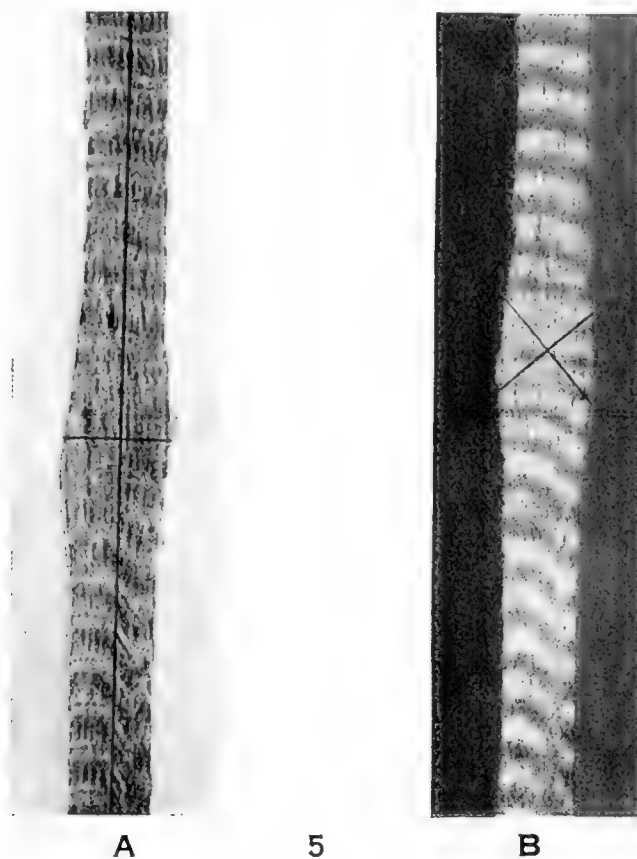

FIG. 5 Photomicrographs of portion of a leg-muscle fiber of *Chrysomela coerulea*, with 'fixed contraction wave,' as seen under the polarizing microscope. Fiber A was photographed with crossed nicols, fiber B with uncrossed nicols (from Schaefer, after Englemann). These photographs are interpreted by Schaefer as demonstrating that there is no change of position of the anisotropic substance of the Q-disc during contraction, hence no true reversal of striation. Schaefer claims that the same fact can be demonstrated in sarcostyles of wasp's wing muscle treated according to Rollet's technic (compare fig. 6). Schaefer accordingly makes the unwarranted assumption that the deeply staining substance of the dark disc is identical with specific anisotropic materials of the sarcoplasm.

that the anisotropic bands in the area interpreted as contracted are quite as sharp and distinct as those of the relaxed terminal regions, whereas most investigators agree that the anisotropy of a contracted fiber is relatively feeble. However, this illus-

tration emphasizes a cardinal point regarding striped muscle structure, namely, that, under certain conditions, optically different substances or portions of the sarcostyle are stratified so that an isotropic disc alternates regularly with an anisotropic



FIG. 6 Three sarcostyles from the wing muscle of the wasp prepared according to Rollet's method, and magnified about 2000 diameters (after Schaefer). Schaefer interprets A as a contracted fibril, B as a stretched fibril, and C as an uncontracted fibril. In C, above, are shown numerous circles which Schaefer regards as 'pores' through which the lightly staining hyaline substance of the J-disc is supposed to pass into the deeply staining 'sarcous' substance of the Q-disc during contraction. These illustrations are regarded as demonstrating the illusion of a reversal of striation during contraction. The writer interprets sarcostyle C as at the beginning of contraction (since the H-disc is beginning to make its appearance), and its 'pores' as fixation artifacts; sarcostyle B he regards as the stretched condition of C, not a stretched relaxed sarcostyle, and sarcostyle A as one which has become swollen and in consequence artificially but not functionally contracted (shortened) through the osmotic action of the hypotonic formic-acid-water solution employed in the Rollet's technic. Sarcostyle A accordingly can give no evidence regarding a reversal of striation during contraction, because it is in an artificially modified relaxed condition.

disc. This phenomenon of stratification may readily be demonstrated under favorable conditions in insect leg muscle. I have also convinced myself by micropolariscopic studies that the anisotropic stratum does not in general change its original more or less definite segregation approximately within the limits of the dark disc, at least in no regular and uniform manner, during contraction. But similar studies of contracted fibers show also that the anisotropy of the fiber and sarcostyle in this condition is relatively feeble.

Figure 6, taken from Schaefer,²⁸ is of prime importance because upon it are based diagrams (fig. 9) which are used in most of the current text-books of gross and microscopic anatomy to explain the mechanism of muscle contraction. This figure includes three sarcostyles of the wing muscle of the wasp, treated according to Rollet's gold-chlorid technic. Sarcostyle C is said to be uncontracted; B, stretched, and A, contracted. It becomes necessary to recall the steps in Rollet's technic. This technic involves fixation in 90 per cent alcohol for twenty-four hours, transference to strong glycerin for several hours, thorough washing in water, immersion in a 1 per cent gold-chlorid solution for from fifteen to thirty minutes, and final transference to a solution of one part of formic acid to three parts of water for twenty-four hours or longer. It is important to note that this technic involves the prolonged use of an acidulated hypotonic solution.

Anticipating in part what will be more fully developed below, the following statements seem desirable here regarding this figure: In fiber C Schaefer lays stress upon, and attaches great importance to, the small circles in the upper end of the fiber. These he interprets as openings into pores in the dark disc. He assumes that these 'pores' are open towards the 'hyaline substance,' closed within the dark 'sarcous element.' But such pores cannot be seen in fresh sarcostyles examined in Ringer's solution; nor are they discernible in sarcostyles treated according to many other histologic methods. They must accordingly be interpreted as artifacts resulting from the use of Rollet's technic. Moreover, granting that there actually occur capillary pores,

there is absolutely no evidence to indicate that they are only open at one end and closed at the end within the dark disc. Also, the presence of a bisecting narrow median disc in the dark disc shows that the sarcostyle is not actually uncontracted, but that it is in an early phase of contraction.

Sarcostyle B is said to be stretched. This much cannot be denied. But we are further led to infer that the occurrence of the bisecting median disc is a coincidence of stretching. It may be granted that extreme tension may cause a division of the dark disc as here illustrated, especially at the very beginning of contraction before the initial median disc is clearly discernible. But moderate tension effects no such result at this functional phase. Tension exerted upon the resting sarcostyle results simply in a lengthening of the dark disc. It seems more in accord with the histologic data to interpret sarcostyle B as one at an early phase of contraction, secondarily modified by stretching.

Sarcostyle C is described as in contraction. It is interpreted as demonstrating that no reversal of striation occurs during contraction. The deeply staining dark disc, which Schaefer identifies with the anisotropic substance, has not moved from its original position in the uncontracted sarcostyle on either side of the mesophragma. But this sarcostyle is not actually functionally contracted. It is simply swollen and in consequence shortened, that is, artificially contracted, through the endosmotic action of the hypotonic formic-acid-water solution. The functionally contracted sarcostyle has a totally different appearance; here a true reversal of striation occurs (figs. 8, 33, and 44). Moreover, the unmodified contracted sarcostyle is not beaded, but maintains a sharp lateral contour. Sarcostyle A is accordingly an artifact, and cannot properly serve as a basis for the construction of diagrams to illustrate the mechanism of muscle contraction. If such a sarcostyle is placed in a 2 per cent sodium-chlorid solution for several hours, it returns to a condition very much like that of sarcostyle C. In other words, sarcostyle A is simply sarcostyle C swollen through the action of a hypotonic solution. Sarcostyles like that illustrated in C are only found in

clumps. The close connection of adjacent sarcostyles by the telophragmata apparently secures protection to a considerable degree against the swelling action of the hypotonic solution. Sarcostyles like A are only found isolated, and are in addition usually somewhat flattened out under the cover-slip.

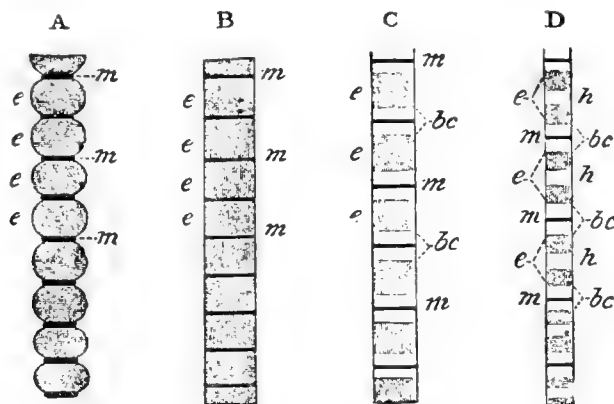

Fig. 7 (A, B, C, and D) Illustration of four sarcostyles of the wing muscle of *Hydrophilus piceus* (from Schaefer, after Ranvier). *m*, telophragma; *h*, median disc; *e*, dark disc ('sarcous substance'); *bc*, light disc ('hyaline substance'). Ranvier and Schaefer interpret A as 'most contracted,' and D as 'most extended.' The fibrils are comparable to the sarcostyles of the wing muscle of wasp, bee, elater, and fly. As such the writer interprets C as a sarcostyle in the relaxed condition; B as a sarcostyle in which the dark disc has become slightly swollen in consequence of the slight action of a hypotonic solution; A as a sarcostyle which has become swollen and beaded, and in consequence shortened (that is, artificially contracted) in consequence of the prolonged action of a hypotonic solution, and sarcostyle D as one in midphase of contraction upon which has perhaps been superposed a stretched condition.

Schaefer²⁷ cites also Ranvier's illustrations of the wing muscle sarcostyle of the water beetle, *Hydrophilus piceus* (fig. 7), in support of his interpretation of the wasp's wing-muscle sarcostyle. Ranvier likewise considers the shortened beaded fiber (A) as contracted. Reference to Ranvier's original article only gives the information that he studied these sarcostyles in the body fluid of the insect, in white of egg, in picrocarmine of ammonia and in a 2 per cent osmic-acid solution. He does not specify the particular fluid employed in the case of the muscle from which the illustration was drawn. At least two of these solutions are hypotonic to the living sarcoplasm. According to our inter-

pretation, sarcostyle C is in a condition of repose, sarcostyle D is stretched at an early phase of contraction, B is a relaxed sarcostyle slightly altered by endosmosis, sarcostyle A is swollen and beaded through the action of a hypotonic solution.

In support of his claim that the striae are not reversed during contraction, Schaefer cites also the experiments of Macallum,¹² designed to determine the distribution of the potassium salts in the sarcoplasm during the several functional stages. Schaefer selects certain of Macallum's figures of the wing-muscle sarcostyles of *Dytiscus*, and interprets these as demonstrating that also the potassium salts do not shift their position during contraction, from their location within the dark disc in the relaxed sarcostyle. Schaefer would thus seem to identify the dark disc not only with the anisotropic stratum of Englemann, but also with the potassium-containing stratum of Macallum. An examination of these selected figures from Macallum's paper (fig. 289 of Schaefer²⁷) reveals the fact, however, that the so-called contracted sarcostyles are actually only fibrils which have become artificially beaded through osmotic modification. These illustrations reveal only that the distribution of the potassium salts within the sarcoplasm is roughly coextensive with the dark disc, but give no information regarding this distribution during contraction. Reference to Macallum's original work (p. 118) reveals, moreover, that the distribution of potassium salts in uncontracted and contracted muscles is not a very precise matter. In the uncontracted muscle the potassium is said to be generally limited to the dim band, but also the potassium reaction is most marked in those zones of the dim bands immediately adjacent to the light bands. The latter condition, in my opinion, is comparable with an early stage of contraction. In the contracted sarcostyle Macallum found the most marked reaction for potassium in the central regions of the dark disc. However, when the penetration of the reagent (the hexanitrite of cobalt and sodium) was delayed, the staining reaction revealed the potassium sometimes in the light discs and sometimes along the level of separation between the light and dark discs.

Menten,¹⁶ in her extension of the experiments of Macallum, has shown that the chlorides, the phosphates, and the potassium salts have an 'analogous distribution.' And her beautiful colored illustrations show clearly that these salts change their position during contraction, and that this change of position corresponds closely with the transfer of the deeply staining substance from the dark disc of the relaxed fiber to the contraction band of the contracted fiber. Accordingly, there occurs during contraction a reversal of striae as regards these salts as well as regards a possibly specific substance of the dark disc. In full contraction these salts are segregated practically within the limits of the contraction band (Menten's figs. 17, 18, 22, 26, 31, 36, and 38). The conclusion is suggested that the deeper color and the deeper staining reaction of the Q disc and of the contraction band are actually due, at least in part, to the segregation of these salts within these levels at the functional stages of relaxation and contraction.

In figure 8 is reproduced a photomicrograph, from Meig's paper,¹⁵ of a living contracted sarcofile of the wing muscle of the fly, mounted in a medium of equal parts of white of egg and a 2 per cent sodium-chlorid solution. The contraction bands are conspicuous. The sarcomeres have lost approximately half of their length and attained approximately double their diameter, as compared with the relaxed fiber. At *a* the contraction bands appear single, at *b* double. Meigs interprets the double condition as an optical illusion due to the oblique orientation of the sarcofile at *b*. However, the contraction band is by virtue of its origin essentially a double structure, comprising principally two halves of adjacent dark discs. It seems to me more probable that these apparently double contraction bands in this illustration should be interpreted as incompletely fused contraction bands. In spite of the sharp lateral contour of this contracted sarcofile, clearly shown in the figure, Meigs nevertheless interprets such fibrils as slightly beaded, with constrictions at the levels of the telophragmata (contraction bands); an assumption required by the imbibition hypothesis of contraction, but in contravention of microscopic data.

Figure 9 (A and B) gives Schaefer's diagrams²⁷ designed to explain muscle contraction, based upon his interpretation of certain wing-muscle sarcostyles of the wasp. These diagrams persist in some of the leading text-books of anatomy and physiology. They are only applicable to a mechanical explanation of contraction; and even as such misinterpret the microscopic



Fig. 8 Photograph (by ultraviolet light) of a contracted sarcostyle from fly's wing muscle teased out fresh in a mixture of equal parts of white of egg and a 2 per cent sodium-chlorid solution, magnified 1300 diameters (according to Meigs). The diameter of this contracted sarcostyle is approximately three times that of the relaxed sarcostyle, and the length of the contracted sarcomeres is approximately one-fourth that of the relaxed sarcomeres. The dark (contraction) band at *b* appears double, at *a* single. Meigs interprets the double appearance of the bands (at *b*) as an optical effect due to the oblique position of the fiber. The writer inclines to interpret the double bands in terms of their double origin and an incomplete fusion of paired constituents.

data. Diagram A is supposed to represent two sarcomeres of a sarcostyle in condition of relaxation. The dark disc ('sarcous element') is conceived to be double, containing medially a bisecting median (H) disc, and is described as 'poriferous.' The 'pores' are said to be only open toward the light disc ('hyaline substance'). During contraction the alleged more fluid, 'hyaline,' substance of the light disc is assumed to flow into the 'pores' of

the dark disc, and in consequence cause it to decrease in length and increase in width (diameter), producing thus contraction of the fibers by reason of the beading and shortening of the component sarcostyles, represented in diagram B.

I have added diagram C to complete the series of changes in the sarcostyle during contraction, in accord with the data to be presented in the descriptive portion of this paper. In order to use diagrams A and B in this series we must disregard the exaggerated length of the sarcomere in A. My interpretation of these diagrams is then as follows: Sarcostyle B is in the relaxed condition; sarcostyle A in an early stage of contraction, as indicated by the presence of a median disc, and sarcostyle C is in the fully contracted condition. The contraction band (*C.B.*) of sarcostyle C includes fused opposite halves of adjacent Q discs, bisected by the telophragma.

The common assumption that the substance of the light disc is relatively more fluid than the substance of the dark disc is also directly contrary to what the microscopic data seem to indicate. The principal transfer of substances during contraction is not from the telophragma to the mesophragma, as is required in the above diagram according to Schaefer, but in the opposite direction. The distortion effects of mechanical and osmotic factors show their respective initial modifications first in the dark discs, as is to be expected if this portion is relatively more fluid than the light disc. A relaxed sarcostyle placed under tension responds first by a lengthening of the dark disc. Under the dehydrating effect of fixation with the higher grades of alcohol, the dark discs respond by a shortening (condensation) relatively far in excess of that effected in the light disc. Moreover, in stained preparations it can readily be seen that a dark-staining substance of the Q disc actually moves toward the telophragma during contraction, as indicated by a clearing of the median portion of Q and the knobbed character of the terminals of the Q portions of the sarcostyles.

The foregoing discussion should have made it clear that the prevailing ideas of the morphologic changes suffered by striped muscle during contraction, as based largely on the illustrations

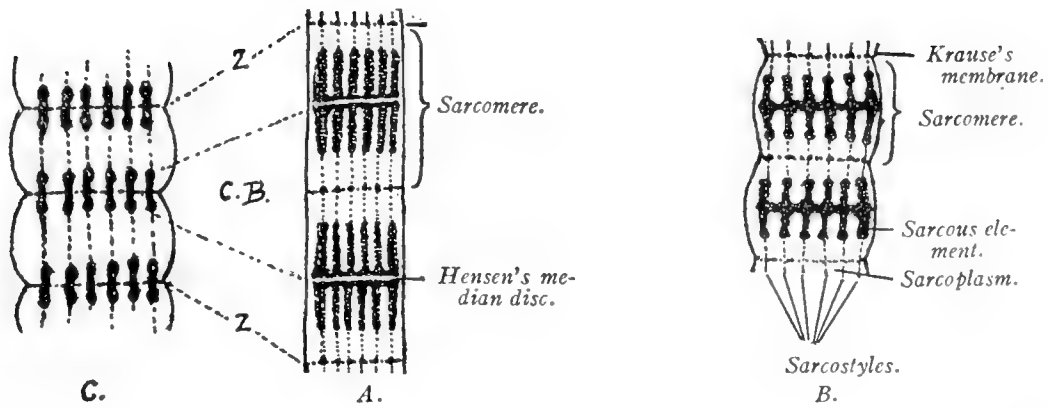

B,

Fig. 9 Diagrams to illustrate the phenomenon of contraction in voluntary striped muscle (A and B according to Schaefer; C has been added by the writer). According to Schaefer, diagram A illustrates two relaxed, 'moderately extended,' sarcomeres; B, two contracted sarcomeres. During contraction the isotropic substance of the light disc is supposed to become absorbed by the anisotropic substance of the dark disc, thus producing a shortening and thickening of the fiber. To bring these diagrams into agreement with Schaefer's illustrations of wasp's wing muscle (fig. 6), upon which they are based, A and B must be regarded as single sarcostyles (not six myofibrils) each with five 'pores' through which the 'hyaline' lightly staining substance passes into the deeply staining 'sarcous' material of the dark disc. The writer has added diagram C to illustrate his conception of the contracted fiber (with six myofibrils; or a sarcostyle with six metafibrillae). Disregarding the exaggerated length of the two sarcomeres in A, he would interpret the three diagrams as illustrating the relaxed condition of the fiber in B; the beginning of contraction (since the median disc has made its appearance), in A; and the condition of full contraction, with contraction band, C.B., in C. The terminal knobbed condition of the 'myofibrils' in B is regarded as showing the passage of the deeply staining constituents of the dark disc toward the telophragma, not the passage of a substance in the opposite direction, as Schaefer would have it. If the contraction band were really the result of a relative condensation and consequent darkening of the J-substance about Z, due to a flowing of lightly staining substance into Q (thus producing a relative rarefaction in Q), then the Q-disc should become lightly staining terminally before it clears up centrally, which is the exact reverse of actual conditions (A; and figs. 2 and 3).

and diagrams of Schaefer, are unsatisfactory. Before we can arrive at a correct conception of the intimate mechanism of muscle contraction, the detailed morphologic basis of this phenomenon must be definitely established. In the following pages it will be my chief aim to show that wasp's wing muscle passes through the same series of morphologic phases during

contraction as does insect leg muscle. Evidence will be presented for the conclusions that all varieties of striped muscle behave during contraction in an essentially identical manner; that the contraction band of a contracting fiber is a genuine structural entity, not an optical illusion, representing an actual reversal of striae with respect of the deeply staining constituent of the stratified sarcoplasm; and that this contraction band (disc) is the primordium of the several types of intercalated discs of cardiac and skeletal muscle. Incidentally must be considered also the nature and significance of the sarcomeres, of the ino-phragmata (telophragma and mesophragma), of the accessory disc (of Merkel and Rollet), and of the distribution of the alleged anisotropic materials.

V. DESCRIPTION

a. Leg muscle

The condition of the relaxed muscle fiber is illustrated in figure 14. This fiber was fixed in 95 per cent alcohol and stained with iron-hematoxylin. The unstained fiber has an essentially identical appearance. The deeply staining portions of the stained fiber simply appear more faint in unstained specimens. The fiber is slightly distorted below. The sarcolemma, on the left, is slightly festooned, due to the unequal contracting action of the fixing fluid upon the muscle fibrils and the sarcolemma. Since the fibrils shorten more than the sarcolemma under this influence, and since the sarcolemma is intimately connected with the telophragmata, the sarcolemma accommodates itself to the shortened condition of the fibrils by separating from the fiber in the form of arcades. Q and J are of about equal thickness. The telophragma appears relatively robust, somewhat granular and deeply staining. The granular appearance of the telophragma is due to swellings at the points where the myofibrils are attached to it. An accessory (N) disc is very conspicuous. It is formed by the horizontal alignment of modified minute areas of the myofibrils in the vicinity of the telophragmata. It has apparently much the same chemical constitution as the Q discs.

Figure 14 should be considered in connection with figure 18. The latter was fixed with Flemming's fluid and lightly stained with iron-hematoxylin. The myofibrils are discernible, but the cross striations do not appear. Only the telophragmata are conspicuous. However, the fixation preserved the sarcosomes and they are seen to occur both in the dark discs (as Q-granules) and in the light discs (as J-granules). In alcohol-fixed tissue the granules are dissolved and so do not appear in stained sections (fig. 16). Their solution in alcohol, together with certain micro-chemical reactions, indicate that their chemical constitution is at least largely lipoid. The spherical J-granules are smaller than the oval Q-granules. The difference in shape may be due to lateral pressure exerted by the myofibrils on the larger originally spherical Q-granules. The simplest interpretation of the genetic relation and the segregation of these two varieties of sarcosomes is that the larger develop from the smaller, the latter originating along the telophragmata, probably by reason of the fact that the telophragmata furnish efficient pathways for the transfer of nutritive materials from the inter-fiber tissue spaces into the fiber.

The location of the smaller J-granules close to the telophragmata accounts for the confusion of these granules with the constituent elements of the accessory discs, as well as with those of the contraction bands. Retzius²¹ claims that the accessory discs are actually aggregations of J-sarcosomes. Holmgren,⁶ Heidenhain,⁵ and others claim that the contraction bands of contracted muscle also are simply aggregations of sarcosomes. That neither of these interpretations, however, is tenable is proved by the fact that in alcohol-fixed tissue, in which the sarcosomes have disappeared through solution, both accessory discs and contraction bands still occur. Moreover, both of these structures occur also in fibers in which no sarcosomes can be demonstrated. Both accessory disc and contraction band are, largely at least, composed of intramyofibrillar elements. The sarcosomes are interfibrillar bodies.

The fiber illustrated in figure 15 is at an early phase of contraction. The Q disc has lengthened and its myofibrillar elements

are pale medially and darker staining and knobbed terminally. There is obviously going on a transfer of deeply staining substance from the middle of Q toward the middle of J. This process is carried still further in the fiber of figure 19, where relatively pale thick contraction bands have formed. This stage corresponds to the so-called homogeneous phase of contraction of certain writers. The thick, pale, early contraction bands condense into the typical definitive thin deeply staining contraction bands of the fully contracted fiber (fig. 20). These same steps are shown in longitudinal series within four sarcomeres in figure 10, drawn from a preparation of leg-muscle fiber of the grasshopper.

Figure 16 is given to illustrate the character and distribution of the nuclei. This fiber is in the relaxed condition and only lightly stained. The nuclei are centrally placed (fig. 17) and are larger and smaller spheroidal bodies, with a delicate reticulum and relatively large, irregular, very chromatic net-knots. The nuclei occur arranged in long axial columns; indeed, in certain fibers they seem to occupy the core of the entire fiber. Where they occur in shorter groups, the terminal nuclei appear to be smaller than those more medially placed. Occasionally a regular progressive decrease in size occurs in both directions from the middle to the terminals of the group (fig. 16). No mitotic figures were seen. Nuclear multiplication is here exclusively by the amitotic mode. Cross-sections (fig. 17) show that the fibers are of irregular cylindrical form, and that the myofibrils (sarcostyles) are of the lamellar type. These lamellar sarcostyles occasionally show a peripheral radial splitting, giving rise to Y-shaped sarcostyles as seen in transverse section.

b. Wing muscle

The wing muscle differs markedly from the leg muscle. It consists of robust fibers, of irregular polygonal form in transverse section (fig. 11). The fibers are enveloped by a delicate sarcolemma. An occasional nucleus is peripherally placed, the majority are scattered indiscriminately throughout the fiber. The nuclei are small oval bodies and are very chromatic; in

transversely cut and stained sections of fibers they are with difficulty distinguishable from the very abundant sarcosomes. In general they are slightly larger than the large sarcosomes. The fiber is composed of relatively very robust sarcostyles, among which the sarcosomes are scattered in great profusion. In the photograph the sarcostyles appear white, the sarcosomes and nuclei black (fig. 12). The sarcostyles are circular in outline in transverse section and vary slightly in diameter. The sarcosomes are irregularly stellate or fusiform bodies resembling somewhat tendon cells as seen in cross-section (figs. 45 and 48). Longitudinal sections (figs. 13 and 23) show that the sarcosomes are of irregular form, but frequently apparently oval, and that they are arranged in single and double columns between adjacent sarcostyles. Figure 21, a drawing of five adjacent sarcostyles in longitudinal section, shows a frequent arrangement of the sarcosomes, namely, in oval group.

Two other important facts are revealed in figure 21. First, the regular alignment of the telophragmata in adjacent sarcostyles indicates that they span also the intersarcostyle space. This is denied by Thulin,²⁹ who claims that a telophragma is lacking in the wing muscles of Coleoptera, Diptera, and Hymenoptera. But his illustrations show clearly that his conclusions are based upon secondarily modified fibers, that is, fibers that have suffered distortion and rupture. That the intersarcostyle representative of the telophragma is very delicate is demonstrated by the ease with which it ruptures in fixed and mechanically handled tissue. But that it is actually present is further proved by such examples as illustrated in figure 22 where a slight bending and distortion has simply drawn out, and in consequence emphasized, the intersarcostyle portion of the continuous telophragma. Where the sarcosomes are very abundant, however, as in figures 13 and 23, the telophragmata cannot be traced among the groups of sarcosomes. Here the telophragma must be either fenestrated or have become ruptured and probably completely destroyed. In such areas also the primarily regular (normal) transverse alignment of similar portions of adjacent sarcostyles has become vitiated.

Certain additional facts should here be recorded regarding the sarcosomes. When arranged in single series between adjacent sarcostyles, the long axis of these sarcosomes is generally at right angles to the long axis of the sarcostyles; when in double series, their long axis is in general parallel with the long axis of the sarcostyles. Certain irregular forms also occur, wedge-shaped (fig. 24), crescentic (possibly collapsed ovals), fusiform, and stellate forms (fig. 48). Transverse sections reveal the fact that all types, and taken as a whole the vast majority, of the sarcosomes have wing-like processes which almost completely ensheath the sarcostyles (figs. 45 and 48). In this material no very small spherical sarcosomes occurred. The sarcosomes of the wasp's wing muscle were preserved in all of the fixing fluids used (Flemming's fluid, 95 per cent alcohol and 10 per cent formalin). They must therefore contain in large measure something in addition to lipoids. Their irregular winged form appears due to secondary mechanical modifications resulting from the pressure exerted by adjacent sarcostyles. The evidence,

Fig. 10 Longitudinal section of portion of leg-muscle fiber of a grass hopper. The fiber passes abruptly from a condition of relaxation to one of contraction at point A, where a contraction band can be seen forming by process of fusion of opposite halves of two successive dark discs against the involved telophragma. The telophragma is no longer discernible at the phase of contraction shown at A, due probably to its having become stretched by the horizontal tension at this level to a degree of delicacy beyond the limits of microscopic vision. The formation of the contraction bands below A has effected a true reversal of striations as regards a deeply staining constituent of the dark disc. Flemming's fixation, iron-hematoxylin stain. $\times 900$.

Fig. 11 Transverse section of a wing-muscle fiber of the wasp. *Nu.*, peripheral nucleus; other nuclei are scattered throughout the diameter of the fiber; *S.*, sarcolemma. The light areas represent rows of adjacent sarcostyles; the dark areas, intervening sarcosomes. Flemming fixation, iron-hematoxylin stain. $\times 400$. (The photomicrographs for figs. 11, 12, and 13 were made by Mr. William S. Dunn, Cornell University Medical School, New York.)

Fig. 12 Small area from figure 11 more highly magnified. The circular outlines of the sarcostyles are clearly shown; also the enveloping wing-like processes of the intervening irregular sarcosomes. *Nu.*, nucleus. $\times 900$.

Fig. 13 Longitudinal section of portion of fiber of wasp's wing muscle showing the lightly staining sarcostyles and the intervening dark sarcosomes. The conspicuous transverse lines represent the telophragmata. *Z*, telophragma; *M*, mesophragma; *Sc*, sarcosome; *st*, sarcostyle. $\times 1300$.

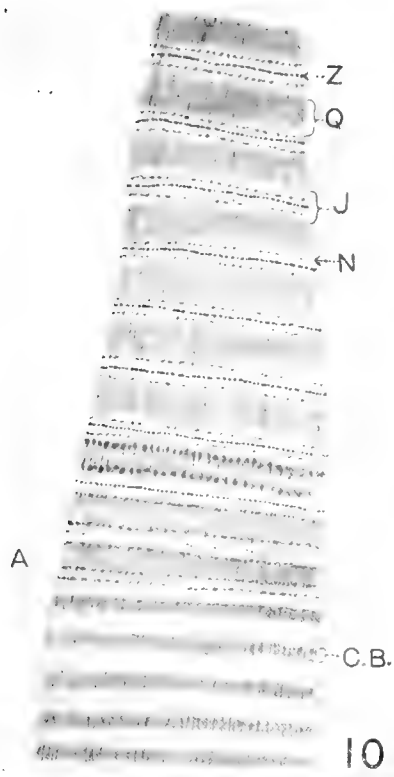

10



11

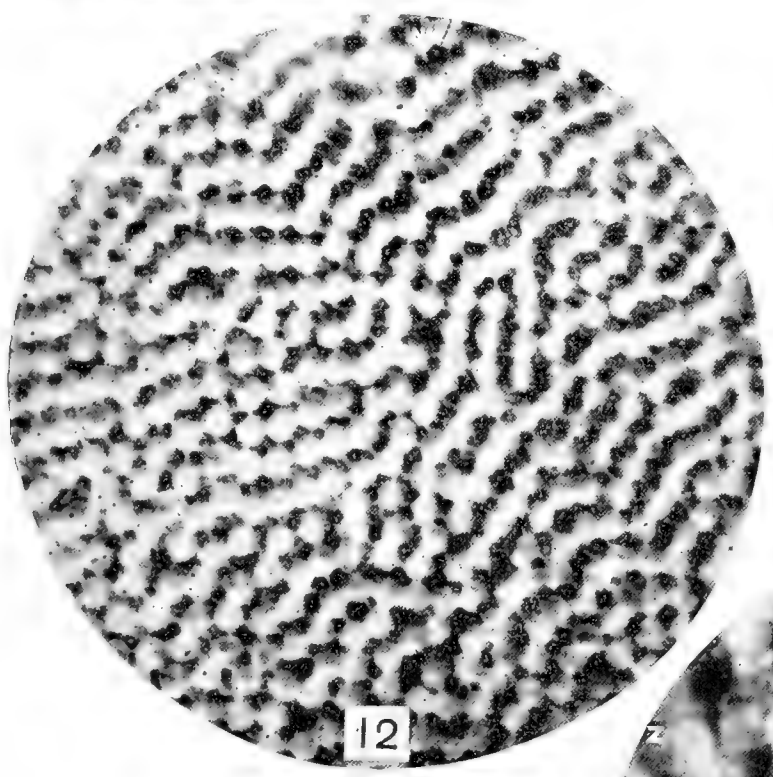

12

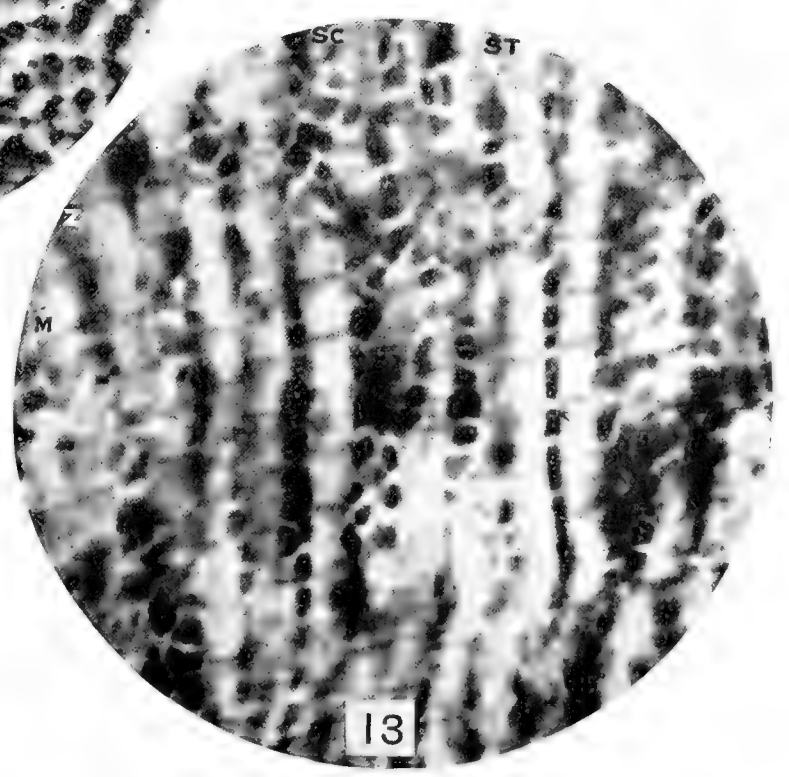

13

which will be further discussed below, seems to indicate that the sarcosomes are not transient nutritive reservoirs, but are formed during the early stages of muscle histogenesis, to remain throughout the life of the individual. Apparently only very few if any continue to be added, and few if any entirely disappear. As the sarcostyles increase in number and grow in girth, probably coincident with the growth of the sarcosomes, the sarcostyles crowd upon the sarcosomes and by pressure alter their original spheroidal shape into irregular winged forms.

We come now to the central point of this investigation, the presentation of the data which prove that the wing-muscle sarcostyle of the wasp passes through the same morphologic phases during contraction as the leg-muscle fibrils, that is, it undergoes a reversal of striation with the formation of a typical contraction band; and, incidentally, that Schaefer's diagrams of muscle contraction are based upon the erroneous interpretation of an artifact as a contracted sarcostyle.

Figure 25 shows the appearance of the wing-muscle sarcostyle observed in the fresh condition in Ringer's solution. The intra-sarcostylic telophragmata are very conspicuous as relatively coarse stripes, dark at the high level of focus, light at low level. The dark disc occupies almost the entire space between successive telophragmata, the light disc appears as a very narrow light area on either side of the telophragma. In tissue fixed in Flemming's fluid and stained lightly with iron-hematoxylin the appearance of the sarcostyle is practically identical (fig. 26). The light disc appears slightly thicker, the fiber as a whole seems to have a slightly greater diameter, probably the result of a slight swelling action of the Flemming's fluid; and there occurs a slight condensation of the deeply staining substance in the midregion, perhaps indicating the location of the mesophragma. Fixation with 95 per cent alcohol causes a shrinkage of the entire sarcostyle, and a distinct condensation, as the result of dehydration, of the deeply staining substance (fig. 27). In such a sarcostyle the light disc appears somewhat thicker than the dark disc. The dehydrating and shrinkage effect of the alcohol shows mainly in Q, demonstrating its relatively more fluid consistency. Fixa-

tion in 10 per cent formalin also produces a slight shrinkage, and in lightly stained sections reveals the mesophragma very clearly (fig. 28). The sarcofile bulges slightly at the levels of the telophragma, as if held open by a structure capable of resisting the shrinkage effected at the level of the mesophragma. The telophragma is evidently a relatively robust and relatively non-elastic structure.

Figure 29 illustrates a sarcofile after immersion for a brief period in distilled water. The sarcofile is distinctly swollen and beaded; the constrictions are at the levels of the telophragmata, indicating again the relative inextensibility of these membranes. The dark disc lies in the middle of the 'bead,' and appears shorter than in the sarcofile observed in Ringer's solution. This sarcofile has been altered through imbibition of water. The beading is the result of endosmosis. The thinning of the dark disc is compensatory to its increase in width following the lateral extension of the sarcomere. After some hours in distilled water the sarcofile swells to several times its normal size, the dark substance becomes diffused throughout the fibril, and finally the sarcomeres may rupture and the sarco-plasm escape.

Treatment according to Rollet's technic yields results similar to those with distilled water, except that the telophragma and the dark disc are stained purple with the gold chlorid. Figure 30 represents a separate sarcofile imperfectly stained in a preparation by Rollet's gold-chlorid method. Figure 31 represents a successfully stained sarcofile. The Q-disc was stained lightly purple. This illustration corresponds with Schaefer's sarcofile A, figure 6, which the latter interprets as a contracted fiber. But it corresponds also with figure 29, and in fact shows the result of the action of a hypotonic solution. It is not a contracted fiber, but a swollen relaxed fiber. Figure 32 illustrates a later stage in this same endosmotic process with Rollet's technic, and shows a greater degree of swelling with a diffusion of the deeper staining substance throughout the sarcofile.

To return to figure 31, it may first be noted that the beaded condition in this degree appears generally only in isolated sarco-

styles. Sarcostyles occurring in groups, held together by the telophragmata, are apparently fortified to some extent against the distorting effects of the hypotonic solution, and so maintain a relatively even contour. That our interpretation of the sarcostyles of figures 29 and 31 as swollen relaxed fibers is correct, may be proved by transferring such sarcostyles to a 2 per cent sodium chlorid (hypertonic) solution, where they return to a condition very similar to that seen in Ringer's solution.

Instead of having the special advantage claimed for it, Rollet's technic is, in fact, very unfavorable, since it leads to distortion and the resulting confusion in interpreting results. It reveals nothing that cannot be seen almost as well in unstained fresh material, nor anything that cannot be better seen in alcohol-fixed and iron-hematoxylin-stained preparations, and it is inferior to Toison's solution in which the fresh tissue is vitally stained in a non-distorting isotonic solution.

The functionally contracted fiber is shown in figure 33. This drawing was made from a fresh preparation in Ringer's solution. It corresponds with Meig's illustration of a contracted sarcostyle of the fly's wing muscle (fig. 8), and with fixed contracted fibers in stained section (fig. 44). Similar fibers may be seen in Toison's solution, and occasionally also in preparations after Rollet's technic. It should be noted that the sarcostyle in this condition of full contraction is not beaded, and that the contraction band in places appears clearly double. Sarcostyles in the contracted condition can be readily obtained in fresh and fixed preparations by drawing a sharp needle transversely across a group of living sarcostyles. The mechanical stimulus evidently is sufficient to induce full contraction.

Figures 34, 35, and 36 represent sarcostyles from the wing muscle of the elater beetle, *Alaus oculatus*. This muscle was fixed in 95 per cent alcohol and stained with iron-hematoxylin. The sarcostyles differ from the wasp's sarcostyles only in being slightly coarser. They illustrate two important points regarding this type of sarcostyle especially well. The sarcostyle of figure 34 is one of a small group, at an early stage of contraction, the median

(H) disc being conspicuous. The sarcofile is slightly constricted at the levels of the dark discs due to the dehydration effect of the alcoholic fixation. Beading is clearly a fixation artifact, not an index of contraction. This conclusion is further supported by the sarcofile of figure 35. This was an isolated sarcofile lying at the end of a clump, and it was in consequence modified to a greater degree. It was, moreover, in the relaxed condition. The sarcofile is sharply beaded, due to an excessive dehydration, and consequent condensation, of the dark disc. The osmotic effect of a dehydrating fluid, or of a hypertonic solution, shows itself first, and to greatest degree, in the dark disc. This indicates that the dark disc is more fluid than the light disc, which latter is in addition held open by the more resistant telophragma. If the location of the beads at the levels of the telophragmata were here exclusively the result of the relatively more resistant nature of the membrane holding the fiber open at this point, rather than the result of a relatively greater fluidity of the dark disc, the border of the bead would be expected to be wrinkled instead of having a sharp contour. It might be objected, especially in connection with figure 35, that the investigator might readily confuse telophragma and mesophragma, and so misconstrue the osmotic effects of the fixing fluids. Determination of telophragma levels, however, is in fact a relatively simple matter. The sarcofiles are extensively fractured, especially in the sectioned material. The levels of fracture in the sections, and in the gold-chlorid and fresh preparations, occur almost invariably along the telophragmata. The criterion of level of fracture, judiciously applied, in connection with the observation of the order of striation in distant parts of the sarcofile, furnishes a precise test for the identification of the telophragma in doubtful cases.

The sarcofile of figure 36 was fixed with Flemming's fluid and lightly stained with iron-hematoxylin. It appears to be at a midphase of contraction. It has special interest because it shows the presence of fine constituent sarcofiletic 'metafibrils.' These are especially prominent at the upper end where they stained deeply. After Rollet's method of preservation and

staining, a similar phenomenon occurs. Figure 46 illustrates an end view (optical transverse section) of a sarcomere from such a preparation. Here the constituent metafibrils are largely grouped in the manner of more or less sharply contoured circles. The latter suggested to Schaefer the idea of a poriferous condition of the dark disc. These 'pores' certainly are fixation artifacts. Whether the fibrils (metafibrils) should be similarly interpreted, or whether this technic simply rendered more conspicuous constituent metafibrils of the sarcostyle, cannot be finally decided. These sarcostyles, certainly under most conditions, both fresh and fixed, both in longitudinal and transverse section, appear homogeneous (figs. 23 and 48). This homogeneity may be simply due, however, to a closely similar refractive index on the part of these metafibrils and the intrasarcostylic sarcoplasm, so that the presence of the metafibrils cannot be discerned until rendered conspicuous by certain fixing and staining processes.

Figures 37 to 44 are twice the magnification of figures 25 to 36, namely, 2600 diameters. They are all of sarcostyles of the wing muscle of the wasp, from tissue fixed with 95 per cent alcohol and stained with iron-hematoxylin. Figures 37 and 38 are both of relaxed fibers, as indicated by the undivided condition of the dark disc. The question arises as to why the dark disc of figure 37 is more than twice the length of that of figure 38. It will be noted also the dark disc of figure 38 is more compact than that of figure 37, which latter is, moreover, slightly lighter in color and apparently longitudinally striped. The short length of the dark disc of figure 38, as compared with this disc of the relaxed fiber in fresh condition or after Flemming's fixation (compare with figs. 25 and 26), is the result of the dehydrating (condensation) effect of the alcoholic fixation. The greater length and somewhat different character of the dark disc in figure 37 is to be explained in terms of a secondary stretching of the fiber. These two sarcostyles illustrate the primary effects of exosmosis and mechanical tension upon the dark disc, results to be expected if the dark disc is relatively more fluid than the light disc.

Figures 39 and 40 illustrate the same point in connection with a sarcostyles at an early stage of contraction. However, it does not seem to me that the above interpretation is quite adequate to explain all the variations in length of the dark disc in different sarcostyles. It undoubtedly accounts for a considerable portion of this variation, but I feel constrained to conclude after careful and prolonged study of many relaxed sarcostyles, that the amount of deeply staining substance varies considerably in different fibers at the same functional stage in the same microscopic preparation. It seems to me fairly certain that the amount of dark and light substance varies within certain limits in different, apparently normal, sarcostyles at the same functional stages, and under the influence of apparently identical mechanical and osmotic conditions.

Figures 40 and 41, at approximately the same functional stage (midphase of contraction), should be considered together. One has a straight contour, the other is slightly beaded. Figures 42 and 43, at a later functional stage, illustrate the same point. The sarcostyle of figure 43 is at the same functional stage as the middle portion of figure 42; one sarcostyle is beaded, the other is not. These four figures (40 to 43) demonstrate again that beading is not an index of a distinct functional condition, that is, of degree of contraction; it is obviously a fixation artifact. This conclusion is rendered certain by the condition of the sarcostyle of figure 44. This sarcostyle is in full contraction and is characterized by conspicuous contraction bands, but it still maintains a straight lateral contour.

To return to figure 42, the lower portion of the sarcostyle is at the same functional phase as the sarcostyle of figure 41. In the upper and middle levels two contraction bands are beginning to form. The upper one is at a later phase than the next lower, which shows thicker deep-staining terminal portions. It is clearly seen here that the formation of the contraction band results from a movement of the deeply staining substance of the dividing Q-disc toward the telophragma. But this material does not here move en masse, but in such manner as to produce

transiently a thick, less deeply staining (diluted) contraction disc bisected by the telophragma. This disc (contraction band) then condenses about the telophragmata to form the deeply staining, relatively thin, contraction band of the fully contracted fiber (fig. 44). The 'diluted' condition of the contraction disc described above (figs. 42 and 43) represents the so-called 'homogeneous' phase of contraction. It is only rarely conspicuous in certain fibers, and seems to depend upon the rapidity of the contraction process. When the process is rapid, this very transient phase will generally escape detection, or may possibly be absent, and the halves of Q seem to have moved en masse against the telophragmata.

In the contracted sarcostyle of figure 44, an irregular cloudy line appears midway between successive contraction bands. This may represent a remnant of deeply staining material of the original Q-disc of the relaxed fiber, clinging to the mesophragma. It is noteworthy also that the telophragma is not discernible in this later contraction band (compare figs. 42 and 44). The masking of the bisecting telophragma may be due to its having become closely adherent to, and so hidden by, one of the halves of the deeply staining contraction band, or to the fact that it has been stretched in the shortened, widened, contracted sarcomere to a point where it is no longer conspicuous under the ordinary powers of the microscope. The paired constitution of the contraction bands is a fact of prime importance in connection with our interpretation of the several varieties of the simple type of intercalated disc as irreversible contraction bands.

These illustrations supply the answer to another important question regarding the structure of the sarcostyle, namely, whether it is naked or enveloped by a 'sarcolemma.' Meigs¹⁵ states that the sarcostyle of the fly's wing muscle is homogeneous in structure and is not surrounded by a membrane. The modifications produced by hypotonic solutions (figs. 29 to 32) and by alcoholic fixation (figs. 34, 35, 41, and 43) demonstrate the fact that the sarcostyle has a physically different peripheral layer which performs the function of an osmotic membrane.

And the beading of the sarcostyle in hypotonic solutions is dependent upon the presence of the telophragma and its attachment to a peripheral layer with the properties of a membrane. The same fact is illustrated in figures 46 and 47. Figure 47 shows in transverse sections three successive stages in the progressive destaining after application of the iron-hematoxylin stain. The late phase shows a central deeply straining granule (fibril?) and a delicate peripheral membrane.

VI. DISCUSSION

a. Telophragma and mesophragma

In the fundamental morphology of striped muscle there is perhaps no element more uniform and definite than the telophragma. Thulin²⁹ recently published a paper in which he claims that a telophragma does not occur in the wing muscles of Coleoptera, Diptera, and Hymenoptera. His illustrations make it clear that he is referring to the intersarcostylic portion of the telophragma, for the intrasarcostylic representative is plainly indicated. Thulin's sole evidence in support of his claim that these muscles lack a telophragma is his observations on sectioned material. His illustrations show that the material suffered considerable distortion and fragmentation by his technic, as indicated chiefly by the relatively wide spaces between adjacent sarcostyles. I have examined specimens of fresh and fixed wing muscle of representatives of each of these groups of insects. In fresh specimens teased in Ringer's solution groups of closely adherent sarcostyles occur in which the telophragmata lie at the same transverse levels over as many as from six to ten adjacent sarcostyles. The slight resistance offered against dividing a group of sarcostyles by teasing is additional evidence that a connecting telophragma exists.

From a study of well-fixed tissues similar evidence accrues. Examination of such areas as represented in figure 21 can leave no doubt that the telophragmata of the sarcostyles span also the extremely narrow intersarcostylic spaces and hold the several discs of the sarcostyles in uniform horizontal alignment. This

conclusion is rendered incontrovertible in the light of such evidence as is shown in figure 22, where the intersarcostylic portion of the telophragma can actually be distinctly seen because slightly drawn out of alignment by reason of a bending of the two involved sarcostyles.

Thulin²⁹ makes a similar claim of non-occurrence for the mesophragma. It is more difficult to prove the existence of an intersarcostylic portion of this membrane due to its extreme delicacy. It may be stated, however, that in the sections illustrated by Thulin we would not expect to see the intersarcostylic portion of the mesophragma. This membrane, even if present, would not be able to withstand the tension exerted by the widely separated sarcostyles; and even if sufficiently elastic to be able occasionally to maintain an intersarcostylic integrity, it would have become too delicate to allow detection by our present methods of microscopic examination. That the sarcostyles themselves contain mesophragmata as well as telophragmata cannot be doubted (figs. 13 and 23). That an intersarcostylic telophragma exists is also certain (fig. 22). This membrane is intimately attached to the peripheral sercolemma, causing a festooning of the latter under certain artificial conditions (fig. 16). Attachment to nuclear wall may be inferred from observations on the muscle of other forms,⁸ but I am unable to definitely demonstrate such connection in this muscle.

Contrary to conditions in the mantis wing muscle,¹⁰ for example, where the telophragmata form efficient barriers against the longitudinal movement of the sarcosomes, the telophragmata of the wasp's wing muscle must be either fenestrated or have become secondarily ruptured and destroyed in certain regions, in order to allow for the accumulation of large oval groups (fig. 21) and compact columns (fig. 23) of sarcosomes. The experimental evidence from treatment of the sarcostyles with hypotonic and dehydrating solutions indicates that the intrasarcostylic telophragma is a relatively rigid and but slightly extensible membrane. The rigidity of the membrane is indicated by figures 29, 30, 31, 32, 34, and 35; its slight extensibility by the sharp, unbeaded, lateral contour of functionally contracted sarcostyles,

figures 33 and 44. According to certain investigators (van Gehuchten,³¹ Heidenhain⁵), the telophragma is isotropic in nature; according to others (Brücke,¹ Rollet²³), it is anisotropic. The weakly anisotropic nature stressed by Rollet, Brücke, and Englemann may account for this discrepancy in opinion regarding its physical constitution.

The literature on the telophragma contains several statements to the effect that this membrane is occasionally double. Meigs,¹⁵ on pages 87 and 88 of his paper on cross-striated muscle, says that in the wing-muscle sarcostyle of the fly "Z itself sometimes appears double." One cannot categorically deny that Z is not actually a double membrane, for in muscle fragmented by macerating fluids or mechanically the sarcomeres seem to separate along the middle of Z; that is, the opposite ends of the separating sarcomeres are each bounded by a membrane, the result of a splitting of the apparently univalent telophragma. It is readily conceivable that under certain conditions such splitting of the telophragma has taken place without the complete separation of the involved sarcomeres. But in well-preserved fibers the telophragma is always apparently a univalent membrane. Occasional descriptions of a double nature of the Z-membrane may possibly be explained as being based on an optical effect due to an oblique position of the sarcostyle or, perhaps more frequently, to a slight flattening of the sarcostyle under the cover-glass, thus bringing both surfaces of the sarcostyle into the same focal level, which condition would give the appearance of a double telophragma. A certain number of such descriptions of a double Z-membrane may be due also to a confusion between the contraction band and the telophragma. The contraction band is essentially a double structure; occasionally both constituents are clearly discernible (figs. 8, 19, 33, and 44). When the contraction band has formed, the telophragma is usually not discernible; it may simply be masked by the band or stretched to a point where it is no longer visible under the microscope. Since the contraction band occupies the position of the telophragma, confusion between the two and misinterpretation of the double structure at this level during contraction may easily follow.

b. Sarcosomes

Sarcosomes occur both in the leg and the wing muscle of the wasp. In the mantis I could detect sarcosomes only in the wing muscle. In the leg muscle of the wasp (fig. 18), as in the wing muscle of the mantis, they occur as two distinct groups; a group of smaller spherical elements (J-granules) on either side of and close to the telophragma, and a group of larger oval elements (Q-granules) along the midline of the dark disc. Both in the leg muscle of the wasp and the wing muscle of the mantis these granules are dissolved by alcohol, but are preserved in tissue fixed with strong Flemming's fluid or a 10 per cent formalin solution. This microchemical reaction suggests an essentially lipid nature. The most plausible interpretation of these granules that all the available data support is that they are formed in close association with the telophragma, the latter furnishing the pathway by which their constituent elements are carried from the intersarcostylic tissue spaces, and that as they grow in size they become crowded toward the middle of the sarcomere (perhaps aided in this movement by muscle contraction), and here modified into oval structures through the mutual pressure of adjacent sarcostyles. Their function may be assumed to be nutritive. The above interpretation necessitates the further inference that the larger sarcosomes are continually used up through the functioning of the muscle fiber, and new ones continually formed in the vicinity of the telophragma.

The J-sarcosomes lie at the levels of the accessory disc (compare figs. 14 and 18). This spatial juxtaposition has led certain investigators (Retzius, '90²¹) to interpret the accessory disc as composed of J-sarcosomes; therefore, a structure composed of intersarcostylic elements. Again, the overlapping of the contraction bands in contracted fibers with the two series of J-granules has given a basis for the conclusion (Retzius,²¹ Holmgren,⁶ and Heidenhain⁵) that the contraction band (disc) is produced by the aggregation of J-granules. The error of such explanation of the accessory disc and the contraction band is proved by the presence of both of these structures in fibers in

which the sarcosomes have been dissolved by alcoholic fixation (figs. 14 and 19). Both accessory disc and contraction disc are primarily and essentially intrasarcostylic (fibrillar) elements.

The sarcosomes of the wing muscle of the wasp differ markedly in certain respects from those of the leg muscle. In the first place, there are no really smaller sarcosomes, such as correspond to the J-granules of the leg muscle. This would seem to indicate that a new formation of sarcosomes does not occur, or only occurs to a slight degree, perhaps only in certain young fibers. In the second place, the sarcosomes are not grouped at definite horizontal levels, but lie between adjacent sarcostyles in short oval groups (fig. 21) or long columns in single or double file (fig. 23).

The wing-muscle sarcosome is a primarily oval body, which becomes secondarily modified, through the operation of mechanical factors incident to the mutual pressure of adjacent sarcostyles, into very irregular forms. Transverse sections of these fibers show that the modified sarcosomes have long, lateral, wing-like processes (the result of pressure) which connect with similar processes from adjacent sarcosomes to form in some instances a complete sheath for the involved sarcostyles. Fragmented or unusually pale sarcosomes were not seen in this tissue. This suggests that the life of the sarcosomes is not here a transient one, but that once formed the sarcosomes persist probably throughout the life of the muscle fiber. Alcoholic fixation causes collapse of certain large sarcosomes, indicating the extraction of fluid by the alcohol. But the sarcosomes are in general almost as well preserved in alcohol, except for occasional wrinkling of contour, as in Flemming's fluid or 10 per cent formalin.

These reactions to fixing fluids indicate that the wing-muscle sarcosomes consist of some substance in addition to lipoids. The complete genetic history, chemical condition, and functional significance of the sarcosomes remain for the present unknown. We are probably quite safe, however, in assuming that the sarcosomes here described for the leg and the wing muscle of wasp are essentially the same thing, representing simply less

highly and more highly elaborated stages, respectively, in the same essentially lipoid granules, the complete series being represented by the J-granules of the leg muscle, the large oval Q-granules of the leg muscle and the wing muscle, and finally the winged sarcosomes of the wing muscle. The latter may possibly represent remnants in mechanically modified form of these probable reservoirs of reserve food material.

If one studied the leg muscle of the wasp only with alcoholic fixation, one would conclude that this muscle lacked sarcosomes. Reports of lack of sarcosomes in certain insect muscle may perhaps be explained on the basis of faulty preservation by the histologic technic employed. There may, moreover, most probably be wide variations in the abundance of these elements corresponding to phases of major metabolic cycles of an individual. The evidence to date suggests that all muscle contains the homologues of the sarcosomes of insect muscle in at least some slight degree of elaboration. That the sarcosomes of the wing muscle are not mitochondria, as has been suggested (Thulin,²⁹ Bullard²), is quite clear from their size, shape, and resistance to the usual mitochondrial solvents. It is difficult to see how Meigs¹⁵ was led to the erroneous conclusion that in the wing muscle of the fly the sarcosomes are "almost certainly granules of coagulated sarcoplasm; there is nothing similar to be seen in preparations of fresh muscle" (p. 89). Contrary to this statement, nothing could be simpler than the isolation of these granules by teasing fresh wing muscle of fly in Ringer's solution.

c. The accessory disc

This disc ('N-stripe') was first seen by Brücke¹ in 1858 in the leg muscle of *Hydrophilus piceus*. It has received careful study at the hands of Rollet,²³ who first disposed of Retzius'²¹ claim that it consisted of J-granules. Rollet interprets it as consisting of essentially the same substance as the dark disc; it is said to be anisotropic like the Q-disc and the telophragma, but more weakly anisotropic than Q.

The accessory disc is very conspicuous in the leg muscle of the wasp, the elater, and the grasshopper. It consists of modified

portions (spherical in shape) of the myofibrils, horizontally aligned close to the telophragma. It appears like a row of granules, very similar to the telophragma. It stains like the Q-disc and has apparently a similar chemical constitution. Its genetic history and its significance, however, remain unknown. It becomes involved with the dividing dark disc in the formation of the contraction band.

One of the most interesting and confusing facts regarding the accessory disc is its apparently transitory nature. By this I mean that it is not always present. It may be present in one fiber and absent in an otherwise similar adjacent fiber. Rollet²³ also noted its inconstant nature in arthropod muscle. This inconstancy may be genetically related with the formation, or degree of development, of the J-sarcosomes, but definite information on this point is entirely lacking.

d. The anisotropic substance

It was first pointed out by Brücke¹ ('58) that the intrafibrillar substance of muscle fibers occurs under certain conditions in alternating strata of isotropic and anisotropic materials. Merkel¹⁷ and Rollet²² identified this anisotropic substance with the material which gives the dark color to the 'dim' disc of striped muscle when viewed fresh with ordinary light. These investigators noted a reversal of striation during contraction resulting in the formation of contraction bands. They inferred that the contraction band was composed of the anisotropic substance of the dim disc of the relaxed fiber. Tourneux³⁰ and Rutherford²⁶ also accept this interpretation of the contraction bands. It is significant, however, that none of these investigators gives an illustration of the contraction bands as seen in polarized light under crossed nicols. It has apparently been impossible to demonstrate an actual reversal of striae as concerns the anisotropic materials. Englemann⁴ and van Gehuchten^{31, 32} actually show, as judged from their illustrations, that the anisotropic substance does not change its location during contraction. Schaefer²⁸ claims to have demonstrated the same fact

by use of Rollet's gold-chlorid technic. We have already shown, however, that Schaefer, as a matter of fact, confused an artificially swollen condition of the fiber, resulting from the action of the hypotonic formic-acid-water solution of this technic, with a condition of functional contraction. The assumption that the darker quality of the dim disc of striped fibers is wholly the results of the segregation of anisotropic materials within the general limits of this disc under certain conditions has led to much confusion, and has introduced an element of unnecessary difficulty in interpreting the morphologic changes suffered by a striped muscle fiber during contraction.

Moreover, undue emphasis upon the presence of anisotropic materials in this contractile tissue has influenced some of the leading theories of contraction culminating in Englemann's hypothesis⁴ that contraction is essentially a matter of the absorption of isotropic by the anisotropic material. However, the presence and segregation of specific anisotropic materials cannot be held responsible for the dark color of the 'dim' disc in unstained fibers; nor are such alleged anisotropic materials properly interpreted as the substance which takes the stain in the dark disc in stained preparations. The dark disc is the result of a substance apart from, and in addition to, the alleged anisotropic materials. The striping of the wing-muscle sarcostyles of the wasp and other insects is quite as definite, if not more so, both in the unstained and stained condition, as in the leg muscle; yet only in the latter material can the stratification of the anisotropic substance under certain conditions be clearly demonstrated with the micropolariscope, while in the former it is present in so small amount as to be practically impossible of demonstration in the single sarcostyle. The substance that moves during contraction in the formation of the contraction band is this additional deeply staining material. I have convinced myself by a study of the leg muscle of the wasp that the anisotropic material (condition) as segregated in the relaxed fiber is not shifted into the light (J) disc during contraction. It is also clear, however, that the anisotropy of the fiber is greatly lessened by contraction. This latter fact is emphasized also by Meigs.¹⁵

There is one illustration that calls for an explanation in this connection. It is figure 71 by van Gehuchten³¹ ('86) which shows a bisected anisotropic disc, corresponding to the midphase of contraction as represented in stained preparations. If the anisotropic substance does not divide and move toward the telophragma to help form the contraction bands, as van Gehuchten himself supposed, how, then, is this illustration to be interpreted? Two explanations suggest themselves, neither, however, wholly satisfactory: 1) it may represent a variation of the more regular stratification when present or, 2) it may be of a fiber stretched at an early stage of contraction in such manner that the anisotropic substance has actually become divided.

But quite aside from the erroneous assumption of a strict spatial correspondence between an anisotropic 'substance' and the Q-disc of the stained fiber, entirely too great relative importance has been ascribed to this anisotropic substance in relation to the phenomenon of contraction. In the first place, it may again be emphasized that many non-contractile substances, both inorganic and organic, are anisotropic. Contractility cannot be regarded as a function of anisotropy. Moreover, as Ranvier²⁰ long ago showed, anisotropy itself is a function of the uniform direction of stress. He showed that india rubber in the usual condition is isotropic, but when stretched it becomes anisotropic. He summarized the results of his studies on this subject as follows: "Monorefringent bodies become birefringent by virtue of a modification in their molecular state, without change of composition a body becomes birefringent when its molecules are oriented in one and the same axial direction muscle has the same structure in repose, extension and during return to repose only the length of the structures varies—inversion of striae does not exist."

There would seem to be a parallel between the different optical conditions of the india rubber in repose and extension and the contracted and relaxed (or extended) muscle fiber. A similar phenomenon of alteration in optical conduct of a homogeneous substance under stress is exhibited by glass when put

under pressure; normally glass is isotropic, but under pressure it develops temporary anisotropic striae. The notoriously feeble anisotropy of the contracted fiber may result from a disturbance during contraction of the more regularly oriented particles of the extended fiber. But the question still remains as to how the stratification of the isotropic and anisotropic substances of certain fibers is to be explained. In the first place, it should be noted that such stratification in otherwise apparently identical fibers may be present in one and absent in the other. It may be justly claimed that failure to see this stratification is due, in a certain number of instances, to unfavorable orientation of the fiber under examination. When the stage of the microscope is revolved under the crossed nicols, a certain number of these apparently inactive fibers give evidence at a certain portion of the field of clear stratification. But there still remain a certain number of fibers in the relaxed condition, which, when viewed under the very best conditions, still are apparently inactive. The most favorable condition for detecting the anisotropic striae are fixation in alcohol and mounting in glycerine. Regarding the apparently optically inactive residue of fibers it might be claimed that their inactive condition is due to oblique longitudinal strains or distortions, disturbing the original segregation. Such distortion is almost unavoidable with fresh teased material. Previous coagulation of the sarcoplasm with alcoholic fixation gives to the anisotropic material a more stable condition and a sharper definition. But it is also quite probable that fixation of itself brings about a sharper segregation than is characteristic of the normal living sarcoplasm. Granting, however, a more or less sharp segregation of the anisotropic condition, as we are in fact compelled to do for living fibers of insect leg muscle under certain normal conditions, the further question remains as to why those segregations correspond in general with the limits of the dark (Q) disc. The answer to this question follows from the fundamental physical condition of the Q-disc. It was shown above that the action of alcoholic fixation and the mechanical factors of tension both indicated the relatively more fluid nature of the substance of the dark disc. Dehydration was

relatively greater, producing a constriction, in the Q-disc, and tension resulted first in an elongation of the Q-disc. Since isotropy is the result of the orientation of the molecules of a substance in the same axial direction (Ranvier), we should expect this optical condition accentuated in that portion of the fiber, namely, the more fluid Q portion, where the molecules or particles were relatively more free to orient themselves (during relaxation) in the axis of stress, that is, parallel to the longitudinal axis. The corollaries to this explanation are: 1) that the disturbance of this identical orientation of the particles of the Q-disc during contraction results in a greatly lessened or a vitiated isotropy of the fiber and, 2) those relaxed fibers which are in an apparently inactive condition as regards especially stratification, may be such in which the particles of the Q-disc have not yet become reoriented in the longitudinal axis immediately after contraction.

The reversal of striae, however, as seen in unstained and especially in stained fibers is a function of a substance unrelated fundamentally to the anisotropic phenomenon, and is the result of the change in position during contraction of some other than a specifically anisotropic substance from the vicinity of the mesophragma to the vicinity of the telophragmata. Reversal of striation, as regards a deeply staining substance, and contraction are coincident phenomena. No doubt a causal connection exists, but a description of the fundamental nature of this connection awaits further study. The phenomenon of reversal of striae, and the chemical constitution of the deeply staining substance involved, are conditions obviously more closely related to contraction than the very widespread (organically and inorganically) condition of isotropy. Any final and adequate explanation of contraction must be able to embrace the fundamental morphologic datum of an intrasarcostylic reversal of striation as regards the deeply staining substance of the sarcoplasm during contraction.

e. Contraction and the contraction band

We are not here concerned with the formulation of a new theory of muscle contraction. Our primary purpose is to

establish the histologic basis upon which an adequate theory can be built. The evidence discussed above makes it clear that contraction is not a simple imbibition phenomenon. The fundamental physicochemical or electrical processes upon which contraction directly depends are restricted to the intrasarcostylic sarcoplasm. How the alterations in the striations are related to these processes and how both are fundamentally related to contraction can at present only be surmised. Prenant, Bouin, and Maillard¹⁹ conceive of contraction as an electrocapillary process. They describe the process as follows:

When the electrical potential of opposite surfaces of contact between the particles of the muscle fiber becomes modified in some way, as by a nervous stimulus or by energy liberated by a chemical reaction, the form of these surfaces tends to become modified, resulting in a contraction of the fiber. The striated fiber, where occur triple contacts between the dark disc, the clear disc and the sarcoplasm, is much more sensitive than the smooth fiber, and its division into aggregations of very small particles, in consequence of which it becomes very active from the point of view of capillary attraction, gives to the whole considerable energy. Since there is a reciprocity between the surface deformations and electrical variation, a simple shock (mechanical stimulus) produces a variation in potential, which, by propagation also determines contraction. Contraction appears to be accompanied by a slow usage of the albuminoid substances of muscle, with the formation of creatin bases, but the principal chemical change consists in the appearance of a large quantity of lactic acid, which either partially or totally becomes converted into carbonic anhydride and water. This lactic acid forms to the detriment of muscular glycogen and especially to the glucose continually supplied by the blood; the sugar of the blood is then the primary source of the energy, but during the work of muscle contraction, the reserve hydrocarbons of the muscle tissue play a secondary rôle (p. 414).

The outstanding morphologic mark of contraction is the contraction band. This structure is composed essentially of fused opposite halves of successive dark discs and a bisecting telophragma. The intermediate phases when the Q-disc is bisected by a widening H-disc has until now been most difficult to explain.

The usual interpretation of these latter phases, namely, as the result of a stretching of the sarcostyle, has led to much confusion. This interpretation has apparently adequate observational support, for sarcostyles with divided Q-discs, that is sarcostyles at

midphases of contraction, frequently show relatively elongated sarcomeres. It must again be emphasized that a condition of stretching may be superimposed on sarcostyles at any functional stage. This fact must be kept in mind in interpreting the structure and length of sarcomeres of any particular sarcostyle or fiber. The effect of stretching is first shown in an elongation of Q. If the sarcostyle is passing into contraction, that is to say, when it is in a condition where a median (H) disc is present, the stretching effect shows itself largely in a widening of the median disc, that is, causing a wide separation of the two portions of Q. This result has led to the general opinion that stretching causes a separation of Q along the mesophragma with the appearance of an H-disc. This is the basis also for the interpretation of a fiber with an H-disc bisecting the Q-disc as one in extension. However, the evidence is fairly complete that the relaxed condition of the fiber is characterized by an undivided Q-disc. Superposition of stretching upon a relaxed condition causes chiefly a lengthening of Q. The presence of an H-disc indicates not extension nor stretching primarily, but the intermediate contraction phases. Stretching of a sarcostyle in this condition produces chiefly a lengthening of the H-disc.

The unmodified fully contracted fiber has a sharp lateral contour (figs. 8, 33, and 44). Beading is not an index of contraction, as claimed by Ranvier,²⁰ Schaefer,²⁸ Meigs,¹⁵ McDougall,^{13, 14} and others. Contraction is accordingly not simply a matter of the imbibition of fluid by the sarcostyle. It is a matter associated with the division of the deeply colored substance of the dark disc and its subsequent movement against the telophragma, resulting in the production of contraction bands.

Meigs¹⁵ has made one of the most consistent attempts to support by morphologic data the imbibition hypothesis of muscle contraction essentially as proposed by McDougall. Meigs summarizes the results of his study of the muscle of the fly and of the frog by stating a series of objections against the opposing hypothesis, namely, that contraction results from fundamental intrasarcostylic reactions. Meigs says that "The latter hypoph-

esis disregards almost all the facts that are known concerning muscle." On the contrary, it may be claimed that the hypothesis included all the facts that are not artifacts! Meigs states that the latter hypothesis "leaves unexplained the division of the muscle substance into minute sarcofibrils, for it is impossible to see why larger bodies of 'contractile substance' should not perform their function as well as smaller ones." To this the reply may justly be made that a division of a fiber into fibrils each surrounded by semi-fluid extrafibrillar sarcoplasm provides a very much more efficient, perhaps indispensable, method of providing nutritive materials to a metabolically so active tissue. Meigs claims that the non-imbibition hypothesis also "leaves unexplained the division of the sarcofibrils into sarcomeres, and the presence of the Z- and M-membranes, and contradicts the well-known fact that the Z-membrane is more or less inextensible." But the presence of the Z- and M-membranes, whose presence imposes upon the sarcofibrils a division into sarcomeres, can be readily and reasonably explained as paths along which travel the materials (assimilative and disassimilative) of metabolism. Their intimate attachment to the sarcofibrils and the sarcolemma speaks strongly in favor of this interpretation. Meigs continues: "It leaves unexplained the differences in appearance between the relaxed and contracted sarcofibrils, and is forced to assume that the appearance of bulgings in the contracted sarcofibrils is a delusion, and that the appearance of the heavy lines between the bulged areas is the result of the production of a large amount of some new substance within the sarcofibrils." However, the hypothesis which Meigs criticises does not assume that the appearance of bulgings (beads) in contracted sarcofibrils is a delusion. It claims that they are artifacts. The illustration of a contracted fiber published by Meigs (fig. 8) does not actually show the bulgings which he attempts to impose upon it in his efforts to support McDougall's imbibition theory. The 'heavy lines' spoken of as between the 'bulged areas' of his figure are the contraction bands formed by the accumulation of the darker substance of the Q-disc of the relaxed condition, not the result of the production of 'some new

substance' within the sarcostyles. Finally, all of the definite morphologic data are in direct contradiction of the 'facts' upon which the imbibition hypothesis is based. In simplest terms, as adopted by McDougall and supported by Meigs, the hypothesis regards contraction and relaxation as phenomena directly comparable to the results of the action of hypotonic and hypertonic solutions, respectively. On the contrary, the evidence strongly indicates that contraction depends upon (or is at least associated with) essentially intrasarcostylic movements of the dark substances (consisting in part at least of chlorides, phosphates and potassium salts) from the middle to the ends of the sarcomeres, that is, from the mesophragma to the telophragmata. This movement is probably associated with surface-tension, or electrocapillary, reactions among the ultramicroscopic particles of the intrafibrillar sarcoplasm.

Most previous investigators have assumed that the substance of the light disc is relatively more fluid than that of the dark disc, and that the intrasarcostylic movement of fluids in contraction is from the light disc toward the dark disc, that is from Z to M. This is the view of Englemann and of Schaefer. But it was shown above that the results of the action of mechanical and osmotic factors demonstrate the relatively more fluid nature (fundamentally, that is, aside from the presence of granules in suspension) of the dark disc. And the histologic preparations actually demonstrate, as shown by the staining results, that a deeply staining substance passes from Q to J, from M to Z. Moreover, if a 'hyaline substance' passed in the opposite direction, as assumed by Schaefer, thus diluting the dark substance of the sarcous elements and so causing it to stain less deeply (thus giving the illusion of a reversal of striation), the loss of the deeply staining property should appear first along the terminal borders of the Q-disc rather than along the midline, as is actually the case.

f. Intercalated discs

The foregoing bears directly upon the question of the significance of the intercalated discs. In a number of earlier papers^{8, 9, 11}

on this subject I have presented evidence in support of my hypothesis that these discs are essentially modified irreversible contraction bands. The simplest type of intercalated disc is practically identical in structure and staining reaction with a contraction band. The essential double nature of the contraction band supplies the explanation of the several varieties of the simplest type of intercalated disc with respect of their relation to the telophragma. Since the two halves of a contraction band have a bisarcomeric origin, and in consequence a relatively independent relationship, it would seem to follow that one half might pass into relaxation while the other half remained incapable of leaving the telophragma, the latter half thus becoming an intercalated disc of the variety bounded only on one side by a telophragma. Where the entire contraction band failed to reverse, the variety of intercalated disc which is bisected by a telophragma would take origin. The variety of disc bounded on both sides by a telophragma could arise by the subsequent fusion of the opposite halves of two adjacent contraction bands. This process of 'fusion' may actually consist essentially of a secondary modification of those portions of the sarcostyles intervening between the opposite irreversible halves of adjacent contraction bands.

Besides the other more complex types of discs (step and serrated forms), still another type of intercalated disc must here be considered. This is a relatively rare type in cardiac muscle. It occurs somewhat more frequently in the specimen of human leg muscle,⁹ where it is scattered among the predominating simplest variety with bisecting telophragma. In a paper by Jordan and Banks¹¹ on the intercalated discs of the beef heart, this type was included among the illustrations (fig. 32), but its interpretation was at that time not clear, and no description was attempted. It may be described now as essentially a thickened telophragma, or portion of a thickened telophragma. It would seem that a contraction band may disappear or reverse, at the time the fiber passes into repose, either as a whole or only in half, or finally only in part. In the latter circumstance a mere remnant of the deeply staining substance of the composite con-

traction band might continue to adhere to a portion of a certain telophragma in an otherwise relaxed fiber, and so initiate this fourth distinct type of intercalated disc. Through subsequent modification by the penetration of tissue fluid via the telophragma, such a thickened portion of this membrane might be caused to persist as this type of disc.

VIII. SUMMARY

1. Contraction in striped muscle is associated with a genuine reversal of striations as regards a deeply staining substance of the dark disc of the sarcostyle. This reversal of striations results in the formation of contraction bands in the contracted fiber.

2. A contraction band is composed essentially of the fused opposite halves of two adjacent dark discs. In fibers containing accessory discs, the contraction bands involve also two of these discs, and in fibers where sarcosomes occur; some of these granules may also become included within the intersarcostylic spaces of the definitive contraction band and contribute to its deeper color and intenser staining reaction. The method of formation of the contraction band explains its bisection by the telophragma.

3. The striping of the striated muscle fiber results from the segregation of darker and lighter (chromatic and achromatic) substances in alternating dark and light discs. These discs are bisected by a mesophragma and a telophragma, respectively. The deeper staining disc is not coextensive with, nor the result of the presence and stratified distribution of, specific anisotropic materials. The darker appearance and deeper staining reaction of the dark disc and of the contraction band may be due, in part at least, to the segregation (demonstrated by Menten) of chlorides, phosphates, and potassium salts in the dark disc in the relaxed sarcomeres and in the contraction band in the contracted sarcomeres.

4. A beaded condition of the sarcostyle is not an index of a phase of contraction, nor is it the result of contraction. It is

an artifact, due either to the dehydrating action of certain fixing reagents like alcohol upon the relatively more fluid dark discs or to the endosmotic action of hypotonic solutions. In the former case the constriction separating successive 'beads' is at the level of the dark disc (mesophragma), in the latter at the level of the telophragma.

5. The condition of bisection of the dark disc by a median (H) disc is not an index of extension or of stretching, as claimed by Rollet and by Schaefer, but of intermediate phases of contraction. Error in the interpretation of this condition has resulted through disregard of the fact that a contracting fiber may be quite as readily stretched as a relaxed or a contracted one. Stretching produces its primary effect in the region of the dark disc causing a lengthening of this disc. At the beginning of contraction stretching seems to produce the median disc, while in reality it simply brings into clearer view, through extension, an extremely thin median disc already present as an accompaniment of the initial phase of contraction. These considerations explain the apparently paradoxical condition of occasional greater length of sarcomere in a contracting sarcofile as compared with the sarcomere of a relaxed sarcofile. Stretching of a fiber at the beginning of contraction produces the illusion of the production of an H-disc by tension.

6. The segregation of anisotropic materials (conditions) in strata alternating with isotropic levels, and corresponding more or less sharply, under certain conditions, with the dark disc, would seem to find its explanation in the relatively more fluid consistency of these dark discs. Interpreting the condition of isotropy in terms of similar orientation of the sarcoplasmic particles to lines of stress (following Ranvier's explanation), it becomes apparent why in a structure like that of a functioning sarcofile—where the particles suffer continual rearrangement during contraction and relaxation—an anisotropic arrangement could be more readily assumed in the relatively more fluid semi-solid dark disc. Along the same line follows the explanation for the more feebly anisotropic character of the contracted fiber, in which the original orientation of the particles of the relaxed

fiber has become greatly disturbed. Moreover, the optically inactive character of certain sarcostyles may be explained on the basis of an inability on the part of the sarcoplasmic particles to become similarly oriented in the dark discs immediately after return from contraction to relaxation.

7. That anisotropy and the deep-staining character of the dark disc are two essentially distinct phenomena seems proved by the fact that the sarcostyle of the wasp's wing muscle is only very feebly anisotropic, while the dark disc stains quite as intensively as that of the fibers, like those of insect leg muscle, where the anisotropy is relatively intense and most sharply segregated.

8. Reversal of striation concerns only the deeply staining substance of the dark disc, not at all the phenomenon of anisotropy. The contraction band is a genuine new structure, not an optical illusion. It is essentially the same in a single sarcostyle as in a fiber-complex of sarcostyles, where increase of intersarcostyle fluid at the levels of the telophragmata might be conceived to contribute to an optical effect (as claimed by Schaefer) giving the impression of the formation of a new structure. The contraction band, in wing, leg, and cardiac muscle, consists essentially of the dark staining (chromatic) substances originally segregated within the dark disc of the relaxed fiber.

9. The simplest type of intercalated disc is identical with a contraction band. Both structures consist of horizontally aligned modified portions of sarcostyles (myofibrils), the whole bisected by a telophragma. In view of the fact that the contraction band is actually composed of two relatively independent portions (that is, two halves of different Q-discs), it is easy to conceive of an independent reversal of these constituents in relaxation. Failure of reversal of one half of a contraction band would result in the variety of simple disc bounded on only one side by a telophragma. The more complex types are readily derived from this simplest type through the subsequent operation of principally mechanical factors. The new evidence here given furnishes further support to our hypothesis that the intercalated discs of striated muscle (cardiac and skeletal) are essentially modified irreversible contraction bands.

LITERATURE CITED

- 1 BRÜCKE, E. 1858 Untersuchungen über den Bau der Muskelfasern mit Hilfe der polarisierten Lichtes. Wiener Denkschr. mat.-nat. Klasse, Bd. 15, S. 69.
- 2 BULLARD, H. H. 1916 On the occurrence and physiological significance of fat in the normal myocardium and atrio-ventricular system (bundle of His), interstitial granules (mitochondria) and phospholipines in cardiac muscle. Am. Jour. Anat., vol. 19, p. 1.
- 3 DAHLGREN, U., AND KEPNER, W. A. 1903 Principles of animal histology, p. 85. Macmillan.
- 4 ENGLEMAN, T. W. 1893 Über den Ursprung der Muskelkraft. W. Englemann, Leipzig (cited from Heidenhain).
- 5 HEIDENHAIN, M. 1911 Plasma und Zelle. G. Fischer, Jena.
- 6 HOLMGREN, E. 1907 Ueber die Sarkoplasmakörner quergestreifter Muskelfasern. Anat. Anz., Bd. 31, S. 609.
- 7 JORDAN, H. E. 1916 The microscopic structure of the leg muscle of the sea-spider, *Anoplodactylus lentus*. Anat. Rec., vol. 10, p. 493.
- 8 1917 The microscopic structure of striped muscle in *Limulus*. Pub. 251, Carnegie Institution of Washington, pp. 273-290.
- 9 1919 Studies on striped muscle structure. IV. Intercalated discs in voluntary striped muscle. Anat. Rec., vol. 16, p. 203.
- 10 1919 Studies on striped muscle structure. V. The comparative histology of the leg and wing muscle of the mantis, with special reference to the N-disc and the sarcosomes. Am. Jour. Anat., vol. 16, p. 217.
- 11 JORDAN, H. E., AND BANKS, J. B. 1917 A study of the intercalated discs of the heart of the beef. Am. Jour. Anat., vol. 22, p. 285.
- 12 MACALLUM, A. B. 1905 On the distribution of potassium in animal and vegetable cells. Jour. Physiol., vol. 32, p. 95.
- 13 McDougall, W. 1897 On the structure of cross striated muscle and a suggestion as to the nature of its contraction. Jour. Anat. and Physiol., vol. 31, p. 410.
- 14 1898 A theory of muscular contraction. Am. Jour. Anat. and Physiol., vol. 32, p. 187.
- 15 MEIGS, E. B. 1908 The structure of the element of cross-striated muscle, and the changes of form which it undergoes during contraction. Zeitschrift für Allgemeine Physiologie, Bd. 8, S. 81.
- 16 MENTEN, MAUD L. 1908 The distribution of fat, chlorides, phosphates, potassium and iron in striated muscle. Trans. Canadian Institute, vol. 8, p. 403.
- 17 MERKEL, F. 1872 Der quergestreifte Muskel. I. Das primitive Muskelement der Arthropoden. Arch. f. mikr. Anat., Bd. 8, S. 244.
- 18 1873 Der quergestreifte Muskel. II. Der Contractions-vorgang im polarisierten Lichte. Schultze's Archiv, Bd. 9, S. 293.
- 19 PRENANT, A., BOUIN, P., ET MAILLARD, L. 1904 Traité d'Histologie, T. 1, p. 440.

- 20 RANVIER, L. 1880 *Leçons d'Anatomie Général sur le Système Musculaire.* Paris.
- 21 RETZIUS, G. 1890 *Muskelfibrillae und Sarkoplasma.* Biol. Unters. von Retzius.
- 22 ROLLET, A. 1885 *Untersuchungen über den Bau der quergestreiften Muskelfasern.* I und II. Wien.
- 23 1891 *Über die N-Streifen (Nebenscheiben) das Sarkoplasma und die Kontraktion der quergestreiften Muskelfasern.* Arch. f. mikr. Anat., Bd. 37, S. 654.
- 24 1891 *Untersuchungen über Kontraktion und Doppelbrechung der quergestreiften Muskelfasern.* Wien.
- 25 1892 *Ueber die Kontraktionswellen und ihre Beziehung zu der Entzuckung bei den quergestreiften Muskelfasern.* Pflüger's Arch., Bd. 54.
- 26 RUTHERFORD, W. 1897 *On the structure and contraction of striped muscular fiber.* Jour. Anat. and Physiol., vol. 31, p. 309.
- 27 SCHAEFER, E. A. 1910 *Essentials of histology.* Longmans, Green & Co.
- 28 1912 *Text-book of microscopic anatomy.* Longmans, Green & Co.
- 29 THULIN, I. 1915 *Ist die Grundmembran eine konstant vorkommende Bildung in den quergestreiften Muskelfasern?* Arch. f. mikr. Anat., Bd. 86, S. 318.
- 30 TOURNEUX, F. 1892 *Sur les modifications structurales que présentent les muscles jaunes du Dytique pendant la contraction.* Jour. Anat. et Physiol. norm. et path., Année, 28.
- 31 VAN GEHUCHTEN, A. 1886 *Étude sur la structure intime de la cellule musculaire striée.* La Cellule, T. 2, p. 293.
- 32 1888 *Étude sur la structure intime de la cellule musculaire striée chez les Vertébrés.* La Cellule, T. 4, p. 247.

PLATE 1

EXPLANATION OF FIGURES

Leg muscle of wasp

(Unless otherwise specified all subsequent drawings are from tissue fixed in 95 per cent alcohol, stained with iron-hematoxylin and magnified about 1300 diameters.)

14 Portion of longitudinal section of a fiber, in the relaxed condition, showing the Q- and J-discs, and on either side of the telophragma (Z) the N-discs.

15 Fiber in early stage of contraction, showing the terminal knobbed condition of the Q-segments of the myofibrils, indicating a passage of deeply staining substance toward the telophragmata and the appearance of the bisecting H-disc.

16 Fiber in the relaxed condition, only lightly stained, showing the axial arrangement of the long columns of relatively small nuclei.

17 Transverse section of fiber, showing a central nucleus, the lamellar character of the 'sarcostyles' and the enveloping sarcolemma.

18 Fiber fixed in Flemming's fluid and destained to a point where the Q-disc is no longer conspicuous, to show the smaller spherical J-sarcosomes on either side of the telophragma, and the large oval Q-sarcosomes.

19 Fiber at a late stage of contraction, in which opposite halves of successive Q-discs (as regards their deeply staining substance) have fused with each other, and with the intervening N-discs, against the telophragmata to form contraction bands.

20 Fully contracted fiber, showing seven contraction bands.

Wing muscle

21 Portion of longitudinal section of five adjacent sarcostyles with six groups of sarcosomes, and one nucleus (*nu*). The telophragmata of the several sarcostyles are at the same levels, indicating intersarcostyle continuity. Flemming fixation; lightly stained.

22 Two adjacent sarcostyles showing a continuity of the telophragmata, in the region near the middle where the fibrils have been only very slightly drawn apart. Flemming fixation.

23 Five adjacent sarcostyles with four extensive groups of intervening sarcosomes. On the sarcostyles are seen both the coarser, deeper staining telophragmata and the more delicate, fainter mesophragmata. The narrower intersarcostyle spaces contain single rows of sarcosomes; the wider, double rows. The long axis of the sarcosomes of these two groups are in general placed respectively at right angles and parallel to the long axis of the sarcostyles. Flemming fixation. $\times 2600$.

24 Three common forms of sarcosomes as seen in longitudinal sections of the wing muscle. $\times 2600$.

H. E. JORDAN

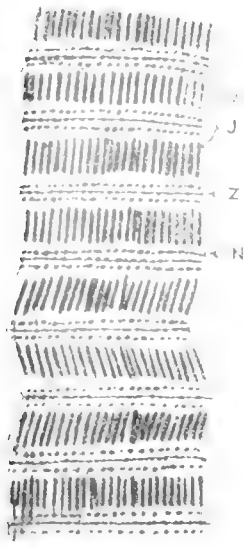

14

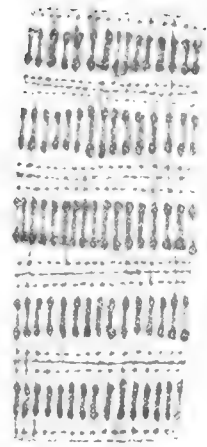

15



16

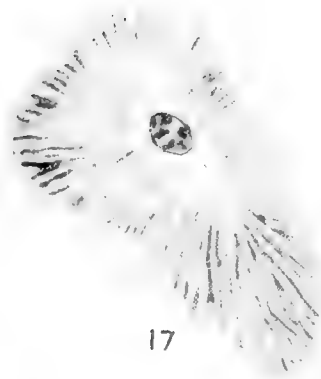

17



18



19

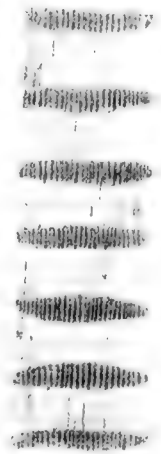

20

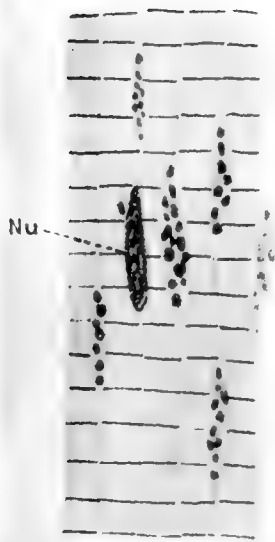

21



22



24

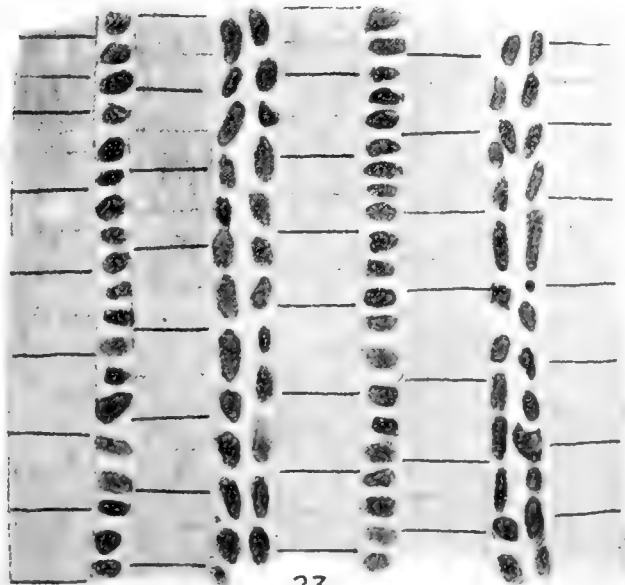

23

PLATE 2

EXPLANATION OF FIGURES

25 Fresh relaxed sarcostyle as seen in Ringer's or Toison's solutions. The telophragmata are conspicuous, the dark discs are thick, the light discs very thin.

26 Relaxed sarcostyle fixed in Flemming's fluid and lightly stained with iron-hematoxylin. This technic causes only very slight modification as compared with the fresh fibril in Ringer's solution.

27 Relaxed sarcostyle fixed in 95 per cent alcohol and stained with iron-hematoxylin. The fibril as a whole is shrunken; the dark disc also is greatly shrunken, due to dehydration, and stains deeply.

28 Relaxed sarcostyle fixed in a 10 per cent formalin solution and lightly stained with iron-hematoxylin. Both the telophragmata and the fainter mesophragmata are visible. The fibril appears swollen at the levels of the telophragmata. This apparent swelling is due to greater shrinkage in the regions of the mesophragmata and a relatively greater rigidity of the telophragmata.

29 Fresh relaxed sarcostyle as seen after brief treatment with distilled water. The fibril becomes beaded, and slightly shortened, due to the relative rigidity of the telophragmata and the endosmosis suffered by the sarcomeres. The Q-disc is relatively thin. After prolonged immersion in distilled water the Q-disc appears to fill the entire sarcomere due to its dilution, and the sarcomeres eventually rupture. These phenomena demonstrate the presence of a perisarcostylic membrane.

30 Sarcostyle imperfectly stained, from a preparation according to Rollet's method. This fibril has suffered the same modification as one placed in distilled water or other hypotonic solution, but in exaggerated degree due to the action of the formic acid.

31 Resting sarcostyle, properly stained, from the same preparation as figure 30. This fibril has, moreover, been slightly compressed under the cover-glass. It is similar to the fibrils, figures 29 and 30; also to Schaefer's fibril A, figure 6, and represents a sarcostyle artificially contracted, that is, swollen and consequently shortened, through the osmotic action (endosmosis) of the hypotonic aqueous formic-acid solution employed in Rollet's technic.

32 Sarcostyle at somewhat later stage of endosmosis than that of figure 31, in which the darker Q-substance has become diluted to an extent where it slightly discolors the entire beaded fibril. The last three figures demonstrate that the telophragma, while a relatively inextensible membrane, has a slight amount of elasticity. Comparison of figures 25 and 26 with figures 29 and 32 shows that the beaded condition of the sarcostyle represents an artifact.

33 Contracted sarcostyle from a fresh preparation in Ringer's solution (compare with figs. 8, 20, and 44). The contraction bands appear double. The telophragmata are not conspicuous, probably in consequence of their stretched condition in the contracted, that is radially widened, sarcostyle.

34 Sarcostyle of eyed elater (*Alaus oculatus*) at an early phase of contraction. The sarcomere is constricted in the region of the H-disc in consequence of the dehydrating action of the alcoholic fixation. Iron-hematoxylin stain.

35. Sarcostyle of elater, fixed in 95 per cent alcohol and stained with iron-hematoxylin, showing a greater degree of constriction and beading due to alcoholic dehydration. These fibrils almost invariably break at the level of the telophragmata. The constriction in the region of the Q-discs under these conditions would seem to indicate a greater degree of relative fluidity here than in the J-discs; and the bulging at the level of the telophragmata demonstrates a relatively great rigidity on the part of these membranes.

36 Sarcostyle of elater, at later phase of contraction, showing, especially well at the upper end, the ultimate fibrillar elements (metafibrillae) of which the sarcostyle is composed. Fixed in 95 per cent alcohol, stained with iron-hematoxylin. $\times 1300$.

37 Sarcostyle of wasp's wing muscle including three sarcomeres, in relaxed condition. The deeply staining Q-disc is unusually long for material fixed in alcohol, possibly due to a stretched condition of the fibril. 95 per cent alcohol fixation, iron-hematoxylin stain. $\times 2600$.

38 Sarcostyle of wasp's wing muscle including four sarcomeres, in the relaxed condition, with unusually short Q-discs. $\times 2600$.

39 Three sarcomeres at early stage in contraction. A very narrow H-disc bisects the unusually long Q-discs. $\times 2600$.

40 and 41 Successively later phases of contraction. $\times 2600$.

42 Still later phase of contraction. Two early contraction bands appear toward the upper end of the sarcostyle, each composed of opposite halves of successive Q-discs fused about the telophragma. $\times 2600$.

43 Late phase of contraction, showing a stage in the reversal of striations. The H-disc of the earlier phase of contraction now forms the light stripe of the fibril. $\times 2600$.

44 Sarcostyle in full contraction, showing five (double) contraction bands. These fibers always break along the middle of a contraction band, that is, at the level of the telophragma. The faint stripes bisecting the space between successive contraction bands may be the mesophragmata. $\times 2600$.

45 Small area of transversely cut wing muscle of wasp. The wing-like processes of the sarcosomes are seen to encircle the sarcostyles. Above is shown a nucleus. Flemming's fixation, iron-hematoxylin stain. $\times 1300$.

46 Sarcostyle viewed on end, from a preparation according to Rollet's method, showing 'pores.' These 'pores' are fixation artifacts. The dots among the pores represent the metafibrillae. $\times 1300$.

47 Transverse section of three sarcostyles of wasp, fixed in Flemming's solution and stained with iron-hematoxylin, showing results of progressive destaining with the iron-alum solution.

48 Seven sarcostyles and five sarcosomes from the wing muscle of the wasp, cut transversely. Flemming's fixation, iron-hematoxylin stain. $\times 2500$.

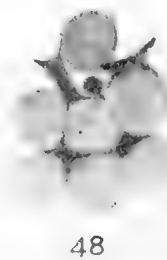
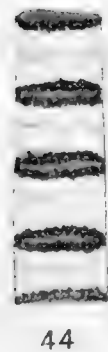
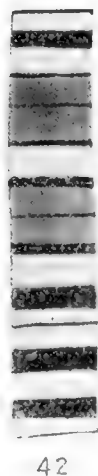
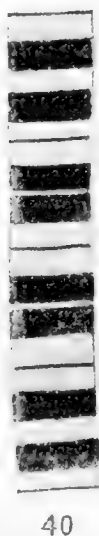
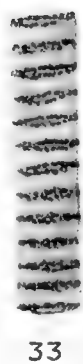

Resumen por la autora, Christianna Smith,
Universidad Cornell, Ithaca.

Estudio del lipoide contenido en el túbulo del riñón.

El presente estudio sobre el lipoide del riñón conduce a las siguientes conclusiones: 1. La presencia de lipoides enmascarados o libres es característica de las células normales del riñón, y pueden ponerse de manifiesto después de la fijación mediante el bicromato en caliente. 2. En ciertas especies (por ejemplo, el gato) diferentes porciones del túbulo presentan formaciones lipoides características que pueden indicar una diferencia funcional. 3. Los bastones mitocondriales de la rama ascendente del asa medular son intensamente lipoideos por naturaleza, resolviéndose en granos de lipoide bajo ciertas condiciones. 4. Las gotitas lipoideas que contienen un tanto por ciento elevado de oleína no se conservan con el método de Bell. 5. La presencia, distribución y, en algunos casos, la distribución característica de los lipoides en las células del riñón indican que pueden estar íntimamente relacionados con procesos metabólicos, además de la posible función que se les atribuye por algunos autores como agentes que influyen en el estado físico del protoplasma. La introducción del presente trabajo contiene una corta revisión del trabajo ya efectuado sobre el origen y presencia de lipoides en los tejidos, y especialmente en las células del riñón. Las propiedades histoquímicas de los lipoides se describen y también el material y métodos empleados en el presente trabajo. La mayor parte de las observaciones fueron hechas sobre las células renales del gato, pero las del perro, conejo y rata fueron también examinadas. El trabajo termina con una discusión general de la significación de la presencia de lipoides en los tejidos.

Translation by José F. Nonidez
Carnegie Institution of Washington

A STUDY OF THE LIPOID CONTENT OF THE KIDNEY TUBULE

CHRISTIANNA SMITH

Department of Histology and Embryology, Cornell University, Ithaca, New York

FOURTEEN FIGURES (TWO PLATES)

CONTENTS

| | |
|--|----|
| Introduction and history | 69 |
| Histochemical characteristics | 73 |
| Material and methods | 73 |
| Morphology of the urinary tubule | 75 |
| Observations | 77 |
| On the kidney of the cat | 77 |
| On the kidney of the dog | 84 |
| On the kidney of the rabbit | 86 |
| On the kidney of the rat | 88 |
| General discussion | 89 |
| Summary | 92 |

INTRODUCTION

The omnipresence of lipoids in the tissues has been pointed out by chemists and studied by many. Cowdry, in his excellent summary of the functional significance of mitochondria, which are related to the phospholipins, quotes Matthews ('15) apropos of this, who says that phospholipins are found in all cells, and that it is undoubtedly their function to produce, with cholesterol, the peculiar semifluid, semisolid state of protoplasm. However the presence of lipoids has been overlooked by histologists in general until quite recently, because they are dissolved in many fixers and require special technique to preserve them. That lipoids are present in kidney cells has been known, but almost always it has been connected with pathological changes. Believing that microscopically lipoids could be demonstrated in normal cells, this study of the lipoid content of renal epithelium

was undertaken at the suggestion of Dr. B. F. Kingsbury, whose kindly interest and generous help is gratefully acknowledged. The conclusions reached were that lipoids could be demonstrated in kidney cells by special technique, that the distribution and formations of the lipoids were more characteristic in some species than in others, and that some lipoids may be intracellular in origin.

Although it is agreed that lipoid is a poor term, chemically speaking (Leathes, '10), "it is useful in histology to include fats, fatty acids, phosphatids, cholesterol, etc., substances which have the same solvents and which are found associated in cytoplasm," (Kingsbury '15), and as such it will be employed in this paper.

If these lipoids are universally present in cells, as it is believed they are by chemists and histologists (Fischer and Hooker, '17; Kingsbury, '15), the question arises as to the forms in which they exist and their relation to the other cell contents in the cell. Fischer and Hooker believe that in normal cells and fluids, liquids (Fischer and Hooker use the term 'fat') are present in finely divided form, kept so by various hydrated proteins, and that the amount of lipoid varies greatly not only in a given cell or body fluid under different physiological and pathological circumstances, but also at all times, in different cells and fluids. It is because of these fine emulsions, they say, that large amounts of lipoids may be present in certain tissues and not betray themselves optically or by ordinary fat stains. According to this interpretation, fatty degeneration is merely a coarsening of the normally fine emulsions due to the separation of the lipoids because of an interference with the hydration of the proteins. This interference is, according to them, acid production, caused by substances such as phosphorus, phlorizin, alcohol, and conditions of anaemia or general circulatory disturbances.

That some of the lipoids in cells are present in intimate mixtures has already been pointed out (Kingsbury, '11), and that one of these mixtures is represented by mitochondria seems at present unquestioned. Cowdry ('16) in the paper to which reference has already been made, gives the following summary of the chemistry

of mitochondria. Mitochondria are soluble, wholly or partially in fat solvents, alcohol, ether, chloroform, and dilute acetic acid, and the part which is not soluble is a protein (albumin?). They are rendered insoluble by chromation. Mitochondria do not stain with sudan III or scarlet red and are blackened only at times with osmic acid. Because of their lipoid nature, some have sought to find in them the source of lipoids in the cell, while others believe they themselves arise from lipoids (Cowdry, '16).

The problem of the source of visible lipoids in tissues is one that has aroused much interest and has been very much involved in the questions of fatty infiltration and fatty degeneration. One explanation that visible 'fat' is due to the coarsening of a fine emulsion of lipoid has already been given. Others believe that fatty infiltration is an excessive deposition of fat and that fatty degeneration is a conversion of cell substance into fat. (Virchow from Fischer and Hooker). E. T. Bell ('14-'15) refers to two divergent opinions on this subject in his paper on "The Differential Staining of Fats." Rosenfeld ('04) and Kraus ('03) believe that kidney fat is derived mainly from the destruction of intracellular lipoids or from structural changes in the cytoplasm whereby finely divided fat becomes visible. Ribbert ('03) says that lipoids are mainly extracellular in origin and that the origin of intracellular lipoids is comparatively unimportant. Bell suggests that oleic fat is extracellular in origin and other lipoids are intracellular. From this brief account of the problem of lipoids in tissues, it can be readily seen that the question is one of importance, and the significance of the presence of lipoids will be taken up in the general discussion at the end of the paper.

Just as it has been brought out in the first part of the introduction that tissues possess lipoids, which are difficult in general to demonstrate microscopically, so is it true concerning the lipoid content of the kidney. Krauss, in 1904, makes the statement, "that tissues that are microscopically fat free, and look normal in general, for example, kidney cells, may contain 20 per cent of fat." As late as 1909-1910, Mayer and Rathery state that no fat disclosed by usual reactions is found in the kidney cells of mammals.

In his study of the lipid content of epithelium, cartilage, and muscle fibers of the ox, E. T. Bell ('09) makes some observations on the lipoids present in the kidney, and finds that the renal cells of some ox foetuses contained lipid droplets, and that the cortical renal cells of two large steers were loaded with lipoids.¹ Other observations, not his own, are recorded by Bell in this paper. Aschoff ('97) and Pfeiffer ('99) described lipoids in the kidney and other organs of new-born children; Hansemann ('97) found fat, 1) in the human kidney, an occurrence which he considered usually pathological, but which might be normal; 2) in swine, especially when fattened, which he thought abnormal and analogous to obesity in man; 3) in cats and dogs. In 1910, Bell examined the tissues of calves, cats, dogs, rats, and frogs, and found usually a large number of lipid droplets in the convoluted tubules, a fewer number in the collecting tubules, and in some tubules none. He observed also that the amount of lipid in the kidney varies greatly, the cat showing the greatest amount, and the ox least. In his work, "On the Differential Staining of Fats" ('14-'15), Bell used the kidney tissue of human and rat as one kind of material.

Policard mentions in most cases in his work on the histogenesis and histology of the renal epithelium only the presence of lipoids. In his paper on the "Functioning of the Kidney of Frog" ('10), he makes, however, the following summary of his observations in regard to the lipoids in the convoluted tubules. The formations of lipoids which reduce osmic acid, but which stain with copper hematoxylin, after the method of Weigert-Regaud, are of three kinds: First, there are flakes of material which stain gray that are enclosed in vacuoles. These are, by him, considered artifacts. Secondly, very fine granules are present which stain blue-black and which correspond to the innermost subcuticular vacuoles described by various observers, but whether it is the wall of the vacuole or the substance contained which stains he does not know. Thirdly, in the region of the nucleus,

¹ The term 'lipoid' has been substituted here wherever Bell has used the word 'fat,' although he uses 'fat' in the general sense to include true fats and other lipoids.

larger grains exist at the periphery of the section which he considers badly fixed mitochondria. These flakes and granules which Policard describes are quite clearly lipoids in combination that are stained by the mitochondrial technique which he used. Evidently Policard does not take into consideration the fact that in the preservation of lipoids the best fixation of a mass of tissue is at its periphery, while at the center of the mass the fixation may be incomplete. In discussing other portions of the tubule, Policard mentions that lipoids are rarely found in that portion which corresponds to the ascending limb of the medullary loop (loop of Henle).

MacNider ('16, '18), in his work on nephropathic dogs, refers to the presence of fat in the ascending limb of the medullary loop as of frequent occurrence.

In his investigation of the fat infiltration of the cat's kidney, Mottram ('16) observes that lipoids are present in the convoluted tubules and rarely in the straight tubules. He checks up in this paper, an observation made by Leathes, that the lipoid content of the cat's kidney, instead of being more unsaturated than that of the liver and 'lipoid tissue,' as it is in the kidneys of other animals, man, dog, goat, pig, is sometimes more saturated than 'lipoid tissue' and never as unsaturated as that of the liver.

HISTOCHEMICAL CHARACTERISTICS

The observations made by Bell in his several papers in regard to the histochemical properties of lipoids may be tabulated as shown on page 74. Most of these observations were made in the study of muscle, but they are applicable as well to lipoids in the kidney. Fats that are solid at ordinary room temperature do not form any part of the stainable substance, although such fats may be present in small quantity.

MATERIAL AND METHODS

The material used in this investigation was taken from cats, dogs, rabbits, and white rats that were killed by illuminating gas, and the tissue fixed immediately or at different intervals

| | I | II | III |
|--|---|--|---|
| Soluble in absolute alcohol or ether | | | |
| Refraction | Strongly refractive | Intermediately refractive | Faintly refractive |
| Effect of fixatives and postmortem changes | Little affected by fixatives (except formalin) or post-mortem changes | Gradually disappear under the influence of fixing agents, and post-mortem changes. Preserved by Bell's 10 per cent dichromate method | Disappear in most fixing agents, such as formalin and postmortem changes. Preserved by Bell's 10 per cent dichromate method |
| Staining and fixing reactions | | | |
| 1. Scarlet red, fresh material | Intensely stained | Less intensely stained | Faintly stained |
| 2. Sudan III after Bell | Annular form of droplet | | Solid red droplet |
| 3. Osmic acid | Stain black | Stain brown or not colored | Not stained |
| Chemical composition | Essentially olein | Olein mixed with some other fatty substance, e.g., cholesterol | Low melting fat (butyrin) |

after death. Bell ('11) and Bullard ('12) emphasized the necessity of using fresh material if all fat present was to be demonstrated, and Policard and Garnier ('05) found that renal cells underwent postmortem changes fifteen minutes after death.

In the study of the lipoids, three kinds of material are usually employed: fresh tissue; that which has been fixed in a dichromate solution where the reduction of the dichromate renders the fat insoluble and stainable with hematoxylin, and that which has been preserved in osmic acid, which certain lipoids will reduce with subsequent blackening of them. In order to get as complete an idea as possible of the lipoid content of cells, these three methods should be used, one as a check for the other. The

solutions employed which depended on the presence of the dichromate with further mordantage in a simple solution of it, for the preservation of lipoids, were Helly, Zenker, modifications of them, and Regaud's fluid. Bell's ('14, '15) acidified 10 per cent potassium dichromate was used and kept at a temperature of 51° for forty-eight hours. The fixers which contained osmic acid were Flemming's and Benda's fluids, and a solution of 10 per cent potassium dichromate and 2 per cent osmic acid.

In preparing material for fixation, it was found best to use both radial and tangential sections, cut from 1 to 2 mm. in thickness, in order that the preservation of the lipoids would be as complete as possible. Lipoids which reduced osmic acid were found to be kept best if the imbedding were done in parlodion according to Kingsbury ('11). More stainable lipoids with better preservation were found after fixation, in a solution of potassium dichromate and osmic acid. The results obtained were practically the same whether heat was employed or not, so that it seems clear that the results were due to the combination of the dichromate and osmic acid.

Free-hand sections of fresh material were stained in an alkaline alcoholic solution of scarlet red (Bullard, '12, '13), which both Bell and Bullard consider the most efficient stain for the demonstration of fat granules in fresh or frozen sections. One per cent osmic acid was also used. In the fixed material, absolute alcohol was avoided throughout the work. Sudan III and hematoxylin were used as stains after Bell's dichromate fixation, iron hematoxylin and copper hematoxylin after dichromate fixations such as Zenker and Helly, and anilin acid fuchsin and hematoxylin after osmic acid solutions.

MORPHOLOGY OF THE URINARY TUBULE

In the study of the lipoid content of the kidney, it was found that a knowledge of the parts of the renal tubule with their characteristic kinds of epithelium was necessary in order to rightly interpret the distribution of the lipoids and their relation to the tubule, and, further, to avoid any ambiguity. The terms

recommended by Huber ('09) have been used in this paper. The parts of the tubule and the kinds of epithelium are, briefly, as follows: First, comes the renal corpuscle with its double-walled capsule of flat epithelium. Continuous with the epithelium of the outer wall of the capsule is the short, often indistinct, neck which unites the capsule with the first portion of the tubule, the proximal convoluted tubule with the medullary segment. The epithelial linings of the proximal convoluted portion and the medullary segment are essentially the same throughout. The high cells, with striated free border, indistinct cell boundaries, and rodded protoplasm of the basal portions of the cell are all distinguishing features. The medullary segment of the proximal convoluted portion is followed by that part of the tubule known as the loop of Henle, but for which Huber suggests the name, medullary loop. The parts of this are the proximal or descending limb, the distal or ascending limb, and the crest. The epithelium of the descending limb is of a thin pavement type, with relatively large nuclei, which reach from the top to the bottom of the cell and may cause the cell to bulge into the lumen. The crest of the loop may be formed either by the thin descending limb, if the loop is long, or if it is short, by the thick ascending one. The ascending limb extends to the renal corpuscle of its own tubule, and is followed at that point by the distal convoluted portion, which extends to the collecting tubule. Policard ('12-'13) states that the type of epithelium characteristic of the ascending limb is continuous in the distal convoluted tubule, and Huber does not believe the variations which may be present in the different parts great enough to warrant the recognition of other types. Huber, however, considers the epithelium as low, columnar, with indistinct cell boundaries, granular protoplasm, indistinct basal striations, and as possessing no striated free border. In his work on Batrachian and mammalian specimens ('04, '10, '12), Policard points out that this segment possesses very thick rods or bâtonnets, which extend from the base of the cell to the edge bordering the lumen, a characteristic which has been found true in the forms studied during this work. A discussion of this type of epithelium will

be reserved until the treatment of the ascending limb of the cat's kidney, when its lipid content is taken up. The transition between the distal convoluted and collecting tubules is gradual, and the clear type of epithelium characteristic of this portion needs no additional comment.

OBSERVATIONS

In this study of the lipid content of the kidneys, cats were used more extensively, because the lipoids present were very easily demonstrated by fixers containing osmic acid. Definitely cut pieces of the kidneys from thirty-four cats were fixed in either Benda's or Flemming's fluids. All of these were found to contain lipoids that would reduce osmium tetroxid. Eleven of these cats were from 41 to 52 cm. in length measuring from occipital crest to base of tail, fourteen were 30 to 38 cm., nine 18 to 23 cm.—that is, grown cats, half-grown cats, and small kittens. Of these, one died, four were killed by ether, and the rest by illuminating gas. The older full-grown cats had kidneys which were light in color and possibly pathological. Of the half-grown cats and kittens, only one pair of kidneys were found to be pathological upon gross examination, the rest appearing normal. Except for two kittens which had sore eyes, the external and internal appearances differed only in general thinness or fatness. Taking into consideration the above observations, one could almost always foretell how the section of kidney would look after it had been placed in Benda's or Flemming's fluid. A kidney of a very thin kitten or half-grown cat would have a cortex with very characteristic black rays; a fat kitten would possess a kidney, the cortex of which would blacken as a whole, while an old cat, fat or thin, would have a kidney with an intensely black cortex (figs. 1 to 8). In this gross examination of the kidney, the transition between the blackened cortex and lighter medulla was very evident as a distinct and clear-cut line. That the cat possesses fat different in amount, distribution, and composition from other animals was evident in this very superficial examination, and may have some correlation with the obser-

vations of Mottram ('16) in regard to the saturation of the fats present in the cat's kidney.

As a typical example of a kidney whose cortex is characterized by blackened rays, one will be studied from a 22-cm. kitten which was quite thin. The kitten was killed by gas and its tissue fixed immediately. The kidney appeared normal and healthy. As the appearance of lipoids depends upon its preservation and staining, the lipid content will be examined in its relation to the methods used.

Ten per cent formalin and scarlet red. Free-hand sections were made from material that had been in 10 per cent formalin for about a week, and stained with an alkaline alcoholic solution of scarlet red (Bullard, '12-'13). Formalin material was used in this case because the lipoids of the kidney of cat are little affected by it. The rayed appearance of the cortex noted in the gross examination of tissue fixed in Benda's was apparent here, and the rays proved to be composed of tubules containing heavily stained lipid granules in the medullary rays. The tubules of the labyrinth and medulla also contained granules, but they were much finer than those in the rays.

Potassium bichromate and sudan III. This method was first used by Bell, who said it would stain all granules seen in a fresh specimen and would also differentiate those containing olein from other lipoids. The medullary rays which were stained with Benda's or scarlet red, thereby standing out prominently because of their intense staining, were here very light in color, and the tubules of the labyrinth were darker. This variation was due to the fact that those granules which were deeply stained by scarlet red or Benda's were stained only at the periphery or not at all with sudan III after chromation. These droplets, then, could be said to contain olein because they reduce osmic acid and because they were chromated on the surface or not at all by Bell's method, or are what he called annular droplets. The medulla was also divided into two regions, one, corresponding to the outer zone of Peter, which lies next to the cortex, contained more deeply staining tubules than the inner zone or papilla.

When the cortex was examined more closely, it was found that the cells of the proximal convoluted tubule which had stained deeply, contained a large number of lipid granules, some portions of the tubules more than others. As stated by Bell, when there was a small amount of lipid present, the granules were collected at the base of the cell, and when a large amount was present, the granules were scattered through the cell. Where the lipid was stained, the mitochondrial filaments stood out among them in contrast very clearly. Although there was a tendency for one tubule to have the same kind of droplets, it was very common to find in the same tubule both annular and solid forms. In some sections of annular droplets, a diffusion of the lipid into the surrounding cytoplasm could be seen quite plainly. It was also noted that many irregular-shaped granules seemed to be composed of two or more droplets.

The tubules containing the very large droplets which stained intensely with osmic acid and scarlet red, and not at all or very little with sudan III, were the medullary segments of the proximal convoluted tubule. Although Bell describes the type of droplets which contains olein as annular, from observations on both normal and pathological kidneys where droplets which stained intensely black were very abundant, it would be seen that the larger droplets were not preserved at all and represented vacuoles. That this condition was not due to sections where the fixation was incomplete was shown by the fact that neighboring proximal convoluted tubules possessed lipid which stained with sudan III (fig. 12).

The transition from the medullary segments of the proximal convoluted tubule to the descending limb was very sharp and the cause of the clear-cut line apparently between the cortex and the medulla which was noticed in the gross examination. The pavement epithelial cells of this part of the medullary loop or the loop of Henle possessed solid lipid granules, quite numerous and large in proportion to the amount of cytoplasm in the cells. The ascending limb of the loop had an appearance very different from the other portions of the renal tubule because of the presence of the rods which Policard describes ('05, '10, '12, '13). Although

these are called mitochondrial rods, and although Benda considers them mitochondria properly speaking, Policard does not agree for the following reasons: 1) Mitochondria are flexous filaments, and these rods are like sticks arranged in bundles, on cross-section appearing like cardiac muscle ('05); 2) these 'bâtonnets' are more easily preserved than mitochondria, although mitochondrial technique brings them out more clearly ('10); 3) mitochondrial filaments in the proximal convoluted segment vary in form, becoming at times granular normally and during autolysis, while the rods of the third segment (which corresponds to the ascending limb of the medullary loop) never becomes granular normally nor during autolysis ('10). As to their nature, Policard describes them as, "protoplasmic rods, the surface of which seems to be covered with a lipid substance" ('10).

That these rods are lipoids or fatty in nature is shown very clearly in these sections, and it is because sudan III is soluble in them that the region of the medulla next to the cortex is stained more deeply red. In thin sections where the rods were not so closely packed that their individuality was hard to determine, two types could be distinguished. One form corresponded to the homogeneous rods of Policard, and they appeared like annular droplets drawn out to form rods which varied in length and width, some being slightly irregular. It may be possible that the method of fixation with the heat may have affected some of the rods and that they were atypical. The other form was composed of small granules arranged in rows (fig. 9). This form of the rods is quite contradictory to Policard's description of them. Small annular droplets and solid granules were present which might be interpreted as sections or tips of rods or distinct in themselves.

The distal convoluted tubule had epithelium of the same heavily rodded character as that of the ascending limb of the medullary loop, and the cells of the collecting tubules contained a few solid fat granules. One portion of the renal tubule has not been discussed and that is Bowman's capsule. The flat epithelium of the capsule also possesses lipid granules, as do the other segments of the tubule.

Ten per cent potassium dichromate and osmic acid. Ten per cent potassium dichromate and 2 per cent osmic acid were used in the proportions of four to one and 35 cc. were acidified by three drops of glacial acetic acid. The tissue was subjected to a temperature of 51° for forty-eight hours. Material treated in this way showed the fat which reduces osmic acid more clearly and abundantly than tissue fixed in either Flemming's or Benda's fluid. In imbedding, both paraffin and parlodion were used, for, although more fat is preserved in parlodion sections, paraffin ones were found very useful in definitely locating the granules in the different regions of the tubule.

The rays which were described as staining black in pieces of tissues fixed in Benda's fluid stood out very clearly and intensely and the labyrinth was left unstained, except for some very fine granules (figs. 5 to 7). The same regions of the medulla were present as were described for material fixed in 10 per cent dichromate and stained with sudan III. Here the outer zone appeared gray-black and the inner zone was left unstained. The large black globules were present in the medullary segment of the proximal convoluted tubule and were the same as those which stained intensely red and not at all or only at the periphery with sudan III. Other parts of the proximal convoluted tubule had very small granules at the base of the cells which did not stain an intense black. In the convoluted tubules of the kidney of a 23-cm. kitten, there was the same linear arrangement of fine fat granules, though not so regularly placed, as may be found in the ascending limb of the medullary loop. These formations in the ascending limb will be described in the next paragraph. This linear arrangement of the lipoids in other portions of the urinary tubule besides the ascending limb may be due to the position of the lipoids in relation to mitochondria either passively or in consideration of a more intimate connection, or it may be an early stage of fat formation independent of mitochondria (fig. 14).

No lipid was visible in the descending limb of the medullary loop which stained black with osmic acid. In the ascending limbs, those rods which, at times appeared granular and at other

times homogeneous when fixed and stained by Bell's method, were here very definitely composed of granules which stained black (fig. 13). These granular filaments starting at the base of the cell extended to the edge bordering the lumen, and occupied the space between the nucleus and periphery of the cell. They ran parallel to each other and their beaded appearance was absolutely clear. In most tubules, these granular filaments so very distinct in the medulla were not preserved in the cortex. This was probably due to imperfect preservation, for in the dog's kidney, which will be described later, they were well preserved in the cortex. The conclusion seems justified, therefore, that these homogeneous rods which Policard describes as "protoplasmic rods with a lipid surface covering" never becoming granular, are lipoids and do become granular filaments which stain black with osmic acid when treated with certain fixers, as a mixture of potassium dichromate and osmic acid, with or without the application of heat.

The collecting tubules did not contain lipoids that reduced osmic acid.

Benda's fluid. Material fixed in Benda's fluid showed the same characteristics as that fixed in potassium dichromate and osmic acid. The preservation of the lipoids, as it has been stated before, was better in the bichromate solutions.

One per cent osmic acid. In a simple solution of osmic acid, the same details were evident that were present in the other osmic-acid fixers. The rods of the ascending limb of the medullary loop appear granular upon focusing, but homogeneous when in packets.

The discussion of the tissues fixed in Helly's fluid, Zenker, and Regaud will be omitted in this paper and taken up in another, when the effects of different fixers and the lipoids of the kidney will be studied in their relation to mitochondria.

As an example of a very fat kidney with a very black cortex, one will be taken from a cat which measured 46 cm. occipital crest to the base of the tail. This kidney possessed a very yellow cortex in the fresh condition and was probably pathological, as the liver appeared to be also.

Ten per cent formalin and scarlet red. Very large globules which were present in the cells stained with scarlet red in all of the tubules of the cortex.

Ten per cent dichromate and sudan III. Just as in the kitten, those granules which stained deeply with scarlet red and black with osmic acid were not preserved by this method, and the cortex appeared as if composed of vacuoles. The lipoids in the descending limbs of the medullary loop, in the ascending limb, and the collecting tubules did stain, however, and this showed that the non-preservation of the fat in proximal tubules was not due to poor preservation (fig. 10). The cells of the medullary segment of the proximal convoluted tubules were desquamating and stained diffusely with red, no lipid droplets being present. The appearance of the very fat kidney differed, then, from a kidney with the rayed appearance of the cortex in that all the tubules were very full of large lipid granules and the lower portion of the medullary rays did not contain lipid droplets.

Benda's fluid. In fluids containing osmic acid, the cortex was blackened intensely (fig. 8). All the tubules were affected except portions of the medullary rays. These tubules, the medullary segments of the proximal convoluted tubule, whose cells were desquamating, did not blacken, and the limbs of the medullary loop and collecting tubules contained very fine granules. A linear arrangement of these could often be seen. In a section fixed in Benda's fluid and stained in anilin acid fuchsin, the granular appearance of the mitochondria, and rods of the ascending limb of the medullary loop stood out very clearly.

The cortex of the kidney of a very fat 18½-cm. kitten looked more like the cortex of the kidney of a fat cat. The proximal convoluted tubules in the labyrinth contained fine and moderately coarse granules, while the medullary rays and medulla were unstained (figs. 3 and 4).

A free-hand section of the kidney of a foetal cat which had been preserved in formalin several months was stained with a fresh solution of sudan III and found to be abundantly supplied with lipid granules.

From these observations of the lipoid content of the kidney of the cat, it can be seen that there is a characteristic distribution of the lipoid granules which varies under different conditions, the normal and pathological not appearing the same. Because of the abundant supply of lipoids, their characteristic formations, such as the granular forms of the rods of the ascending limbs, and distribution in the cat's kidney, it should be a favorable place in which to study the relation of lipoids to mitochondria.

The lipoid content of the cat's kidney may be summarized as on page 85.

The results obtained from the study of the kidneys of other animals are added here with the realization of their incompleteness and the need of further study. E. T. Bell summarizes the factors which have caused confusion in the study of fat in muscle fibers ('12). They might well be repeated here in regard to the lipoid content of the kidney. They are the following: 1) the character of the fat stain employed; 2) the species of animal; 3) the character of the animal's food; 4) the general nutritive condition of the animal; 5) the effect of fixatives; 6) the effect of postmortem changes. That the character of the fat stain and fixatives employed and conditions of the animal are very important is easily seen from the study of the lipoid content of the cat's kidney. That the species of the animal and effect of postmortem changes must also be considered is evident from the following observations on the dog, rat, and rabbit.

Dog

Although it might be expected that the dog and cat would have kidneys very similar in their lipoid content, the reverse was found to be true. Of the six dogs examined, none presented the rayed appearance of the cortex so characteristic of the kittens and half-grown cats, but looked more nearly like the very fat kitten (fig. 3). Two of these six dogs were five-day-old puppies, one a puppy not yet weaned, but whose exact age was not known, two were two weeks and five days old, and one a half-grown dog with the mange. On the kidney of the puppy of unknown age the following observations were made.

| | BOWMAN'S CAP- SULE | PROXIMAL CONVOLUTED TUBULE | MEDULLARY SEGMENT OF PROXIMAL CONVO- LUTED | DESCENDING LIMB OF MEDULLARY LOOP | ASCENDING LIMB AND DISTAL CONVOLUTED | COLLECTING TUBULE |
|--|------------------------|--|--|---|--|-------------------------------------|
| Fresh tissue or formalin fixed stained in scar- let red | Not exam- ined | Stains red, - fine granules | Stains deeply, red coarse granules | Fine red gran- ules | Fine red granules | Fine red gran- ules |
| Potassium dichro- mate fixation stained in sudan III | Fine red gran- ules | Fine granules, solid red and annular | Coarse granules really vacuoles smaller take peripheral stain annular drop- lets | Fine red gran- ules | Rods and gran- ules stain red | Red granules |
| Fixation in osmic acid solutions | No stain | Few granules in thin kittens, abundant in fat kittens and old cats | Coarse granules stain intensely black in kittens and half-grown cats, not pres- ent in old cats | No stain ex- cept in old cats | Stain gray-black in 1 per cent osmic deeply black and gran- ular with di- chromate and osmic | No stain ex- cept in old cats |

Ten per cent formalin and scarlet red. No granules were preserved in the proximal convoluted tubules in most regions. Some red-staining droplets were found in the tubules bordering the medullary ray and in the medullary loop and collecting tubule.

Ten per cent potassium dichromate and sudan III. The cytoplasm of the cells of the proximal convoluted tubule stained diffusely with red and contained irregular masses which might be called sudanophile precipitate by Bell ('14-'15) or perhaps, lipoids which have become dissolved in the cells during the fixation with application of heat. The lipoid granules in the ascending and descending limbs of the medullary loop and in the collecting tubules showed clearly.

Ten per cent potassium dichromate and osmic acid. The lipoids which blackened with osmic acid were present as fine granules in the ascending limbs of the medullary loop, and the lower portions of tubules which were interpreted as the medullary segments of the proximal convoluted tubules and were found in the labyrinth bordering the medullary ray. In the ascending limbs of the medullary loop in the cortex, the granular rods which were so clear in the medulla of the cat, were present, though not preserved in the medulla (fig. 11). In 1 per cent osmic acid, the rods in the ascending limb appeared homogeneous.

Rabbit

As the kidney of the dog differed from that of the cat in its lipid content, so also is the kidney of the rabbit different from both of them. Kidneys of eleven rabbits were examined which had been fixed in Benda's fluid, and no lipoids which would reduce osmic acid were observed. Four of these rabbits were from seven days to seven and one-half weeks old, and observations made on the kidney of the seven and one-half weeks old rabbit will be given. The older rabbits whose ages were unknown were affected with coccidiosis, but the young rabbits were normal and healthy.

Fresh tissue. The cells of the tubules contained fine red granules when stained with scarlet red and some tubules con-

tained cells with granules which stained brown with 1 per cent osmic acid.

Ten per cent potassium dichromate and sudan III. Unlike the kidney of the cat, the cortex did not possess any differentiation into rays, but, like it, possessed the two regions of the medulla, the outer zone staining more deeply. Granules were present in the cells of the proximal convoluted tubules which Bell called sudanophile precipitate, and for which he did not consider the evidence sufficient to consider as diffuse lipoids. According to Bell, sudanophile precipitate was not found in cells containing lipoid granules. As droplets were found in the tubules of the cortex which stained with scarlet red and browned with osmic acid, the conclusion was reached that the granules here were lipoids and not precipitates. The fatty nature of the rods in the ascending limbs of the medullary loops was evident although they stained very lightly.

Benda's fluid. Material, autolyzed or not, showed no fat which would reduce osmic acid when Benda's fluid was used without the application of heat. Also, tissue which had not undergone autolysis, but was preserved in Benda's fluid kept at a temperature of 51°, exhibited no blackened granules. Sections which had autolyzed and were fixed in the way just mentioned presented a quite different appearance. Many black granules, short granular filaments, and rods were present in the cells of the cortical tubules and in the interstitial tissue of the cortex and medulla. Therefore, from these observations it would seem that lipoids which reduce osmic acid are found in the kidney cells of the rabbit only after autolysis and fixation with heat. Ziegler, in his discussion of fatty degeneration (p. 199), says that "a process similar to that taking place within the body occurs during autolysis of tissue preserved aseptically in the incubator, fat droplets becoming visible in such tissues (Hensen, Wentcher, Kraus, Müller, and others)."

To summarize, fat is present in the kidney of the rabbit in the fresh condition which stains with sudan III after fixation with dichromate. After autolysis and fixation in an incubator, if osmic acid is present, there are some lipoids which will stain black.

The rods of the ascending limb of Henle's loop again show their fatty nature, both in dichromate fixation and 1 per cent osmic acid.

Rat

The kidneys of rats were also examined and the results in general were like those obtained after the study of the renal cells of the rabbit. The kidneys of nineteen rats were cut and fixed. All of these rats were infected with lice, but the internal organs appeared normal except for one case of a cystic liver and one kidney that proved to be pathological when examined microscopically. Kidneys of rats which had been fed on fat diets were studied, and both these and controls were subjects to autolysis with fixation accompanied by heat. The results in brief were as follows: The rats possessed interstitial lipid granules, which were especially abundant in the papilla. The presence of these granules made it difficult in the case of osmic-acid fixations to distinguish always between intracellular and interstitial lipid granules. In the fresh tissue and that preserved in formalin, the interstitial were the only lipoids that seemed to be present. Tissue fixed in 10 per cent dichromate with heat and stained with sudan III possessed granules which Bell would clearly call sudanophile precipitate, for they were not observed in the fresh condition. However, if lipoids which stain with osmic acid can be liberated after autolysis and fixation in an incubator, then it does not seem unreasonable to believe that some lipoids in combination in the cell might be sensitive to heat and liberated by it, chromated, and stainable with sudan III. Bell admits that more fat is demonstrable when higher temperatures are used, but does not yet interpret the sudanophile precipitate as diffuse fat. The granules were found in all the cells and the cytoplasm was unstained. The results with Benda's were the same as those observed in the rabbit.

Experiments to show the effect of fat diets were also carried out. This feeding was mostly on fat meat and bread soaked in fat, one rat was fed olive oil twice on the day it was killed. There was no infiltration of annular droplets as described by Bell,

although with sudan III the granules appeared more numerous and somewhat more intensely stained, and a few faintly stained lipid droplets were present in tissues fixed in an osmic-acid solution. These results did not check Bell's work. This may be because the feeding was not forced.

GENERAL DISCUSSION

As it was stated in the introduction, the conclusions reached in this study of the lipid content of the kidneys were that lipoids could be demonstrated in kidney cells by special technique, that the distribution and formations of lipoids were more characteristic in some species than in others, and that some lipoids appeared to be intracellular in origin. The very definite distribution of the lipoids in the kidney of the cat has been shown, a distribution not so marked in the dog, and still less so in the rabbit and rat. However, in one segment there were lipid formations peculiar to them all. These were the rods in the ascending limb of the medullary loop. As it was pointed out in reference to the cat and dog, these rods are lipid in nature and are resolved into filaments composed of lipid droplets under certain conditions. As these rods were considered by Benda mitochondria, properly speaking, and were called mitochondrial rods by Policard, although he denied their identity with them, the suggestion that there is a close relation between these rods and the formation of lipid droplets in the cell ought not to be overlooked. In the granular forms which were seen after a fixation in 10 per cent dichromate and sudan III, a shadow of a rod could be seen between the granules. After a fixation in potassium dichromate and osmic acid, the droplets stood out clearly and separately in a definite linear arrangement. The presence of lipid droplets in a linear arrangement in cells of other parts of the renal tubule is also very suggestive, although the evidence of their origin is not clear. Scott ('16), in his work on the effect of phosphorus poisoning on mitochondria in pancreatic cells, says that after the mitochondria lose their filamentous form that they agglutinate and fuse to form droplets possessing the characteristic properties of lipoids. Mitochondria

as a source of lipoids in the cells is discussed by Cowdry ('16), who thinks that it would require no great stretch of imagination to believe that this transformation could take place. The intracellular origin of lipoids does not, however, exclude an extracellular origin also, as shown by Bell in his experiments with rats (Bell, '14-'15).

Furthermore, the presence of lipoids in renal cells, either masked or free, the presence of large amounts of lipoids in cells of the proximal convoluted tubule where it is generally conceded either secretion or absorption takes place, the characteristic occurrence of typical lipoid formations (large droplets in the medullary limb of the proximal convoluted tubule in cat, and the rods in the ascending limb of the medullary loop), do not indicate that lipoids in kidney cells are merely passive structures, nor simply droplets formed by the coalescence of finer granules in an emulsion, but that they may be a direct expression of activity in the cell economy. Bullard ('12, '16) and Bell ('11) have concluded that lipoids in normal muscle cells are a reserve food supply. In discussing the rôle of fats (lipoids) in vital phenomena, Leathes ('10) says that they are most conspicuous as a reserve fund of fuel for growing and working cells, but that in virtue of their general chemical inertness are capable of being put to many uses in the organization of plants and animals, for instance, being essential to the cohesion and physical constitution of the protoplasm. In connection with the use of fat as fuel for working and growing cells, Hatai ('15) finds that a lipoid-free ration diminishes the normal rate of growth of the body in albino rats. Leathes also says that the unsaturated fats found in the cells of the body are broken down by successive oxidations until they are completely burnt to oxygen and water. Imrie, in his discussion of the fatty changes in the liver, heart, and kidney, says that the lipoids are oxidized in them to supply energy. In other words, the lipoids are reducing, and their probable relation to the reducing power of cytoplasm is discussed by Kingsbury ('12) in his paper on cytoplasmic fixation. In this paper it is pointed out that as early as 1885 Ehrlich called attention to the

need for oxygen and reducing power of the cells and tissues. In 1911, Unna showed that the cytopoasm is strongly reducing, while the nucleus is oxidative. Kingsbury then says that

if a close connection exists between reduction processes and cytoplasmic (protoplasmic) activity, and if there is a parallel between protoplasmic activity and the demand for and consumption of oxygen in respiration, and the mitochondria are structural expressions thereof, the question will at once be raised as to the nature of the reducing substances, and it will be pointed out that the reducing substances that are present in cell respiration may far exceed in power the lipid combinations that are believed to be present in the mitochondria. To this two comments may be offered: *a*) that, whereas, lipid substances seem to be back of the mitochondrial reaction in some cases, it by no means follows that the reaction is due in every case to such substances, nor does it follow that structures demonstrated as mitochondria are in all instances closely connected with cytoplasmic respiration; *b*) that since in regions of the body where the reducing power is markedly developed, such as the medulla of the suprarenal gland, the myelinic nerve fiber, and the red blood corpuscle, there is an association with lipoids, it may well be that such substances are more intimately and universally connected with the reduction processes of the body than would at first appear.

From the pathological side, other evidence may be offered in favor of the theory that the lipoids in the cell are related to the oxidative process. In the first place, there is an increase in lipid content in the kidney in diseases such as tuberculosis and pneumonia where there is a decrease in the amount of oxygen supplied, and also in anaemic infarcts (Ziegler-Imrie, '15). This would suggest that where the oxidation was decreased the lipoids were not removed, but stored. Bell ('12) produced this condition experimentally in muscle of frog's leg by ligaturing the leg and allowing only a small amount of blood to reach the muscle tissue. Others would explain this increase in fat as due to the acid production in the cell due to the lessened amount of oxygen (Fischer and Hooker, '17). The experimental physiological increase (Bell, '14-'15) might also be explained from the point of view that lipoids are reducing agents in cytoplasm, in that more lipoids were brought to the cells than were needed by the normal processes, and were consequently stored. This would be in accord with the idea that they are a reserve fund of fuel.

From this brief summary of the significance of lipoids in the cells, the evidence seems very strong that besides producing the peculiar semifluid, semisolid state of protoplasm, that the lipoids are in some way intimately connected with the metabolic processes.

SUMMARY

1. Lipoids are characteristically present in normal kidney cells either masked or free and are shown after a dichromate fixation with the application of heat.

2. In certain species (example, cat) different portions of the tubule have characteristic lipid formations which may indicate a difference in function.

3. The mitochondrial rods of the ascending limb of the medullary loop are by nature strongly lipid and are resolved into lipid granules under certain conditions.

4. Lipoid droplets containing a large percentage of olein are not preserved by Bell's method.

5. The presence, distribution, and in some cases, characteristic distribution of lipoids in kidney cells suggest that they may be intimately connected with metabolic processes besides the possible function attributed to them by some of influencing the physical state of the protoplasm.

BIBLIOGRAPHY

- BELL, E. T. 1909 On the occurrence of fat in the epithelium cartilage, and muscle fibers of the ox. *Am. Jour. Anat.*, vol. 9, pp. 401-412.
 1910 The staining of fats in epithelium and muscle fibers. *Anat. Rec.*, vol. 4, pp. 199-212.
 1911 Interstitial granules of striated muscle. *Internationale Monatschrift für Anatomie u. Physiologie*, Bd. 28, S. 297-347.
 1912 The interstitial granules (liposomes) in fatty metamorphoses of striated muscle. *Journal of Path. and Bact.*, vol. 17, pp. 147-159.
 1914 On the differential staining of fats. *Journal of Pathology and Bacteriology*, vol. 19, pp. 105-113.
- BULLARD, H. H. 1912 On the interstitial granules and fat droplets of striated muscle. *Am. Journ. Anat.*, vol. 14, pp. 1-46.
 1916 Fat and mitochondria in cardiac muscle. *Am. Jour. Anat.*, vol. 19, pp. 1-32.

- COWDRY, E. V. 1916 The general functional significance of mitochondria. *Am. Jour. Anat.*, vol. 19, pp. 423-446.
- FISCHER, M. H., AND HOOKER, M. O. 1917 Fats and fatty degeneration, pp. 57-85.
- HATAI, S. 1915 The growth of the body and organs in albino rats fed with a lipoid-free ration. *Anat. Rec.*, vol. 9, pp. 1-20.
- HUBER, G. C. 1909 The morphology and structure of the mammalian renal tubule. *Harvey lectures, 1909-1910*, pp. 100-149.
- IMRIE, C. G. 1914 On fatty changes in the liver, heart and kidney. *Journal of Pathology and Bacteriology*, vol. 19, pp. 245-257.
- KINGSBURY, B. F. 1911 The histological demonstration of lipoids. *Anat. Rec.*, vol. 5, pp. 313-318.
1912 Cytoplasmic fixation, *Anat. Rec.*, vol. 6, pp. 39-52.
1915 Histological technique, p. 7.
- KRAUS UND ROSENFELD 1904 Fett degeneration u. Fett infiltration. *Verh. d. D. path. Ges.*, VI, Jena.
- LEATHES, J. B. 1910 The fats, p. 1, pp. 117-124.
- MACNIDER, W. D. 1916 Pathological study of naturally acquired nephropathy of the dog. *Jour. of Med. Research*, vol. 29.
1918 The stability of the acid-base equilibrium of the blood in naturally nephropathic animals, and the effect on renal function of changes in the equilibrium.
- MAYER, A., ET RATHERY, FR. 1909 Recherches sur l'histo-physiologie de la sécrétion urinaire chez les Mammifères. *Archives d'Anatomie Microscopique*, T. 11, pp. 134-166.
- MOTTRAM, V. H. 1916 Fat infiltration of the cat's kidney. *Jour. of Biol. Chem.*, vol. 24. *Proceedings of the American Society of Biological Chemists*, p. XI-XII.
- POLICARD, M. A., ET GARNIER, M. 1905 Altérations cadavériques des épithéliums rénaux. *Comptes Rendus Soc. Biol.*, T. 572, pp. 678-680.
- POLICARD, M. A. 1905 Sur les formations, mitochondriales du rein des vertébrés. *Comptes Rendus Soc. Biol.*, T. 572, pp. 380-382.
1910 Contribution à l'étude du mécanisme de la sécrétion urinaire. Le fonctionnement du rein de la Grenouille. *Archives d'Anatomie microscopique*, T. 12, pp. 177-287.
1912 Recherchés histophysiologiques sur les premiers stades de la sécrétion urinaire. *Archives d'Anat. micro.*, T. 14, pp. 1-40.
1912 La cytogenèse du tube urinaire chez l'Homme. *Archives d'Anat. micro.*, T. 14, pp. 429-468.
- SCOTT, W. J. M. 1916 Experimental mitochondrial changes in the pancreas in phosphorus poisoning. *Am. Jour. Anat.*, vol. 20, pp. 237-251.
- ZIEGLER, C. 1908 General pathology. Translation by H. S. Warthin. P. 199-200, 11th edition.

PLATE 1

EXPLANATION OF FIGURES

1 Kidney of kitten, 22 cm. in length, with little abdominal or subcutaneous fat. Radial section of tissue fixed in Benda's fluid shows lipoids blackened by osmic acid in medullary segments of proximal convoluted tubule. Photograph, $\times 24$.

3 Kidney of kitten, 19 cm. in length, very fat, not yet weaned. Radial section of tissue fixed in Benda's fluid shows lipoids blackened by osmic acin in labyrinth. Photograph, $\times 44$.

4 Kidney of kitten, same as figure 3. Tangential section shows labyrinth blackened, rays unstained. Photograph, $\times 44$.

5 Kidney of kitten, 23 cm. in length, fair amount of abdominal and subcutaneous fat. Radial section of tissue fixed in 10 per cent dichromate and osmic acid without heat shows blackened medullary segments in rays in cortex and ascending limbs of medullary loop in outer zone of medulla. Photograph, $\times 16$.

6 Kidney of kitten, same as figure 5. Radial section, same as figure 5. Photograph, $\times 44$.

7 Kidney of kitten, same as figure 5. Tangential section shows medullary segments of proximal convoluted tubule in cross-section. Photograph, $\times 44$.

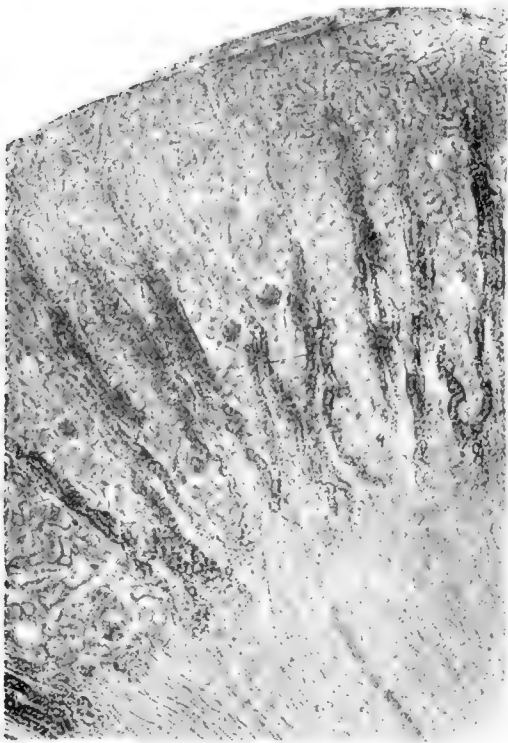

1

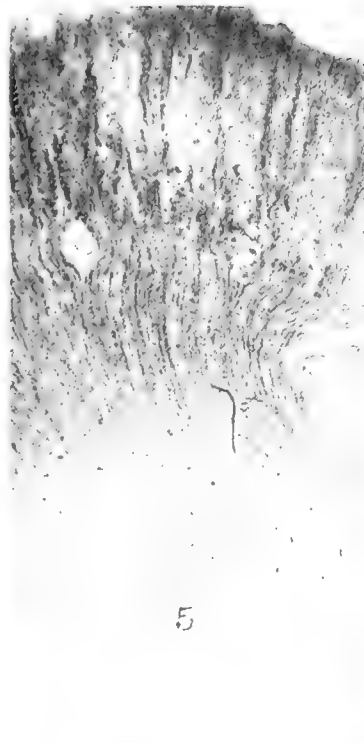

5

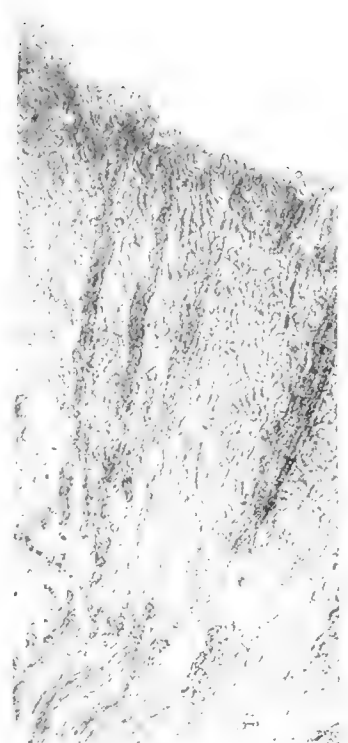

6

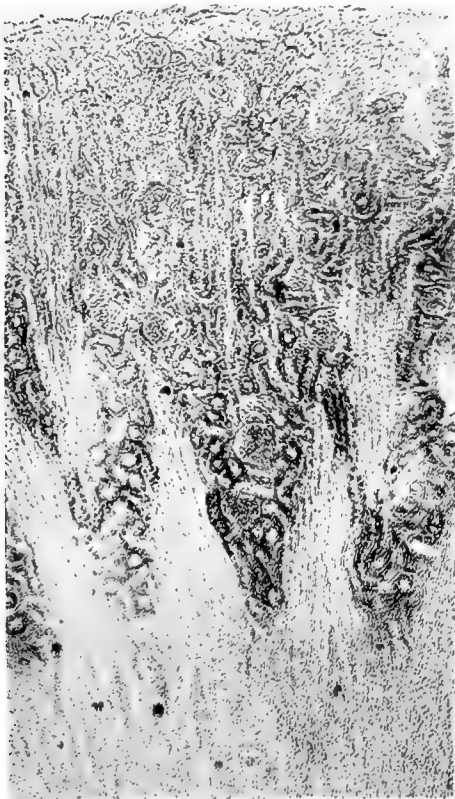

3

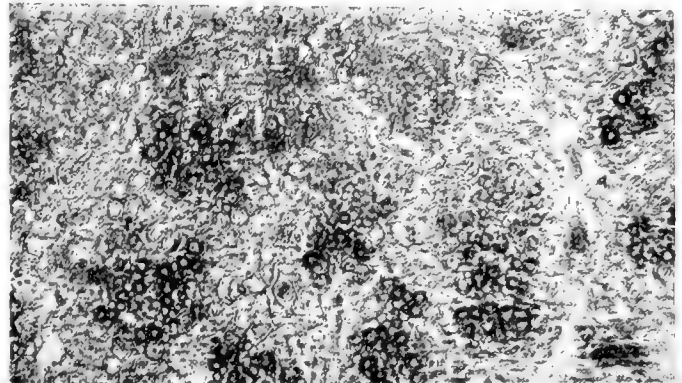

7

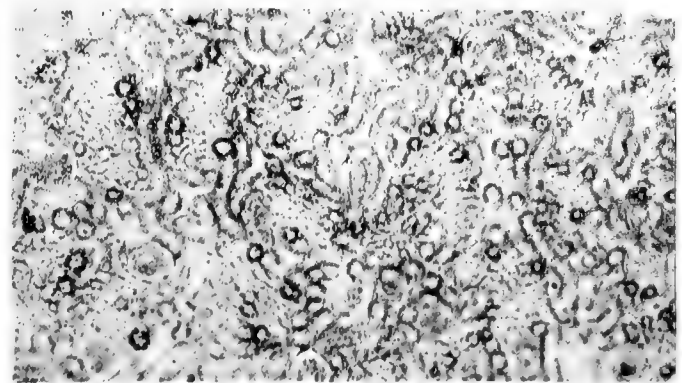

4

PLATE 2

EXPLANATION OF FIGURES

2 Kidney of kitten, same as figure 1. Tangential section shows cross-section of medullary segments of proximal convoluted tubule rays. Photograph, $\times 44$.

8 Kidney of cat, 48.5 cm. in length, very fat kidney. Radial section of tissue fixed in Flemming's fluid shows labyrinth intensely black, medullary rays unstained. Photograph, $\times 16$.

9 From kidney of kitten, same as figure 1. Transection of tubules from tissue fixed in 10 per cent dichromate and stained in sudan III shows granular and homogeneous rods of ascending limbs, stained mostly at periphery, few solid granules, granules in descending limb and collecting tubule. Projection drawing, $\times 800$.

10 Kidney of cat, 46 cm. in length, little abdominal or subcutaneous fat, liver pathological. Kidney light in color. Transection of tissue fixed in 10 per cent dichromate, stained in sudan III. Shows vacuoles in proximal convoluted tubules, rods, and granules stained in ascending limb of medullary loop. Projection drawing, $\times 800$.

11 Transection of tubule of ascending limb of medullary loop of kidney of puppy, 23 cm. long. Tissue fixed in 10 per cent dichromate and osmic acid, and shows granular rods staining black. Projection drawing, $\times 800$.

12 Same as figure 10. Transection of proximal convoluted tubule and medullary segment to show vacuoles and granules staining with sudan III. Projection drawing, $\times 800$.

13 Transection of medullary segment of proximal convoluted tubule and ascending limb of Henle's loop. Compare figure 1. Tissue fixed in 10 per cent dichromate and osmic acid with heat. There are here shown granular rods staining black in the ascending limb. Projection drawing, $\times 1200$.

14 Transection of tubule of kidney. The same as figure 5. It shows linear arrangement of lipid granules in the proximal convoluted tubule. Projection drawing, $\times 1200$.

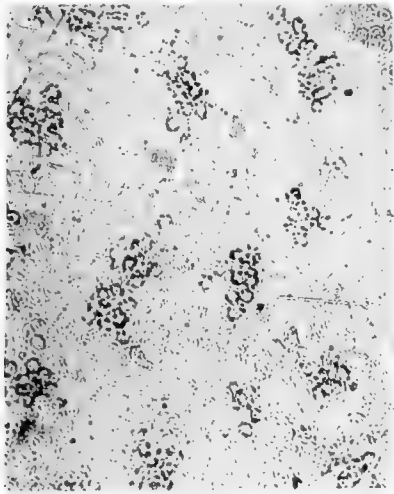

2



12



8

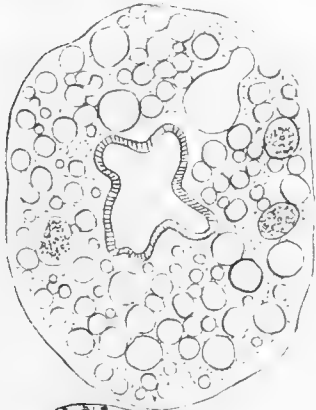

10

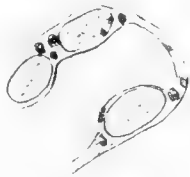

9

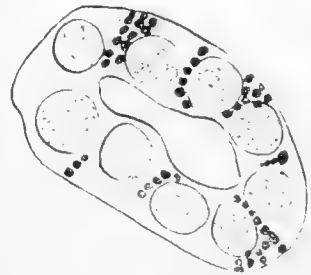

11



13

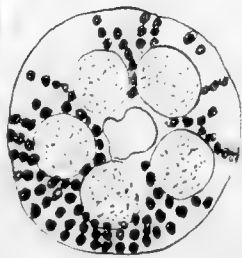

97

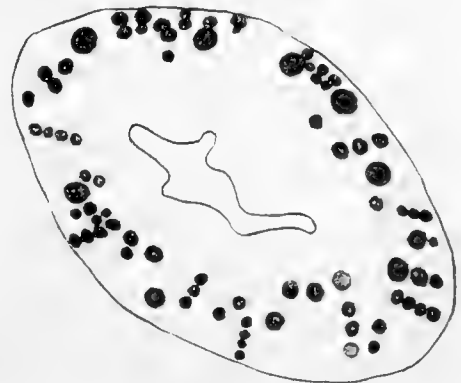

14

THE AMERICAN JOURNAL OF ANATOMY, VOL. 27, NO. 2
MAY, 1920

Resumen por el autor, George S. Huntington.
Universidad Columbia, New York.

Una crítica de las teorías de la evolución pulmonar de los
mamíferos.

El autor presenta algunas consideraciones sobre la filogenia de pulmón de los mamíferos, con especial mención del desarrollo de los tipos arquitectónicos existentes en los bronquios y su significación evolutiva. Las conclusiones conducen a una revisión de las opiniones actuales sobre la organización intrapulmonar. En el presente trabajo se discuten: 1. La teoría reduccional de Aeby (1880) y D'Hardiviller (1897) en la cual comienza el problema moderno de la interpretación de los bronquios. 2. La teoría de la emigración de los componentes bronquiales, propuesta por Willach (1888) y Narath (1892, 1896 y 1901). 3. El resumen de los resultados obtenidos por el autor, que constituyen lo que brevemente pudiera definirse como la teoría selectiva de la especialización pulmonar de los mamíferos.

Translation by José F. Nonidez
Carnegie Institution of Washington

A CRITIQUE OF THE THEORIES OF PULMONARY EVOLUTION IN THE MAMMALIA¹

GEO. S. HUNTINGTON

Columbia University

FIFTEEN FIGURES

The publication of Aeby's (2) fundamental work on the Mammalian Bronchial Tree in 1880 laid the ground work for the phyletic interpretation of pulmonary organization. During the four decades which have elapsed since its appearance the problem has attracted the attention of many investigators. The reason for this interest rests on the fact that the morphological conditions are complex and difficult to analyze from the standpoint of their evolutionary significance.

The determination of the five types of the mammalian bronchial tree by Aeby very soon drew attention to the following cognate topics:

1. The genesis of the divergent forms and their mutual interrelation.

2. Their possible derivation from a common ancestral bronchial tree by various modifications of the same during the phylogeny and possibly during the mammalian ontogeny.

3. The significance of the numerical preponderance of pulmonary asymmetry among mammalia, with the right lung the dominant and more highly developed organ.

4. The homologization of the individual components of the bronchial tree on the two sides in asymmetrical lungs.

5. The phylogenetic relation of the mammalian lung to the avian and reptilian respiratory organs.

¹ Abstract read at the 26th session of the Association of American Anatomists, Pittsburgh, Penn., April 19, 1919.

These questions materially influenced in varying degrees the course of subsequent investigation.

A critical analysis of the work in this field during the forty years following Aeby's publication is, therefore, perhaps best undertaken by presenting, in place of a strictly chronological sequence, a grouping of the chief results obtained under provisional headings suggested by the main lines of thought concerning the phylogenetic history of the mammalian lung which determined the trend of the investigations. It then appears that the five fundamental questions listed above elicited four main hypothetical considerations of the problem. The evidence, on which these theories were based, is common ground, but the conclusions reached are divergent. On the assumption of a common ancestral bronchial pattern of the mammalian lung, from which all extant types are descended by evolutionary modifications, the question arose which of the existing types conformed most closely to this promammalian bronchial tree, and hence represented the nearest approach to the hypothetical primitive mammalian lung. It appeared probable, on general genetic grounds, that the ancestral lung of the mammalia possessed more or less complete bilateral symmetry, and that hence the choice lay between the bilaterally symmetrical eparterial type (found in some pinnipede carnivores and cetaceans, the Cebidae among primates, certain rodents and perissodactyls, elephants, hyrax, etc.), and the bilateral symmetrical hyparterial bronchial tree of some Hystricomorphs and of Taxidea. These considerations gave rise to three interpretations.

I. REDUCTION THEORY

Aeby (1878, 1880, 1882)

D'Hardiviller (1896, 1897)

Bremer (1904)

Aeby assumed (2) that at one period in the evolutionary history of the mammalian lung the organ possessed a bilaterally symmetrical bronchial ground-plan, comprising within its scope all the components found among the extant mammalian types. He held that this archeal ground-plan was preserved unchanged

in the relatively small number of living forms with bilateral eparterial bronchial trees. From it Aeby derived all the remaining types by reduction and final suppression of the eparterial component on the left side in the vast majority of the living mammalia, or on both sides in the only instance of a bilateral hyperarterial tree then known to exist, *Hystrix cristata*. Aeby hence regarded the mammalian lung as having undergone, in its modern prevalent type, a process of devolution or regression, to a greater or lesser degree, and his hypothesis can hence be briefly defined as the 'Reduction Theory.'

At the time of Aeby's publication the embryology of the mammalia and of the vertebrates generally was imperfectly known, and he confidently looked forward to the support of his hypothesis through future ontogenetic investigations. He was disappointed in the first of these when His (24) in 1887, seven years after the appearance of Aeby's work, published his account of the development of the human lung. But Aeby's view received apparently absolute confirmation in the embryological evidence adduced by d'Hardiviller (13, 14, 18) in 1897. This observer, who published, between December, 1896, and December, 1897, no less than eight papers (11, 12, 13, 14, 15, 16, 17, 18) on the development of the mammalian bronchial tree and the homologies of its derivatives in sheep, rabbit and man, describes his findings in rabbit embryos of 13 days and 6 hours as follows:

The right lung shows three main bronchial buds:

1. The eparterial bronchial bud for the upper lobe, carrying a secondary lateral derivative.
2. The bud for the middle lobe.
3. The continuation of the primitive stembronchus into the lower lobe, with a lateral and medial secondary bud, the latter the anlage of the infracardiac bronchus.

On the left side he finds:

1. The bud for the upper lobe.
2. The bud for the lower lobe, formed by the continuation of the main stembronchus, with a lateral derivative.
3. A 'hollow epithelial vesicle' arising from the left stembronchus, cranial to the bud for the upper lobe and directed cranio-dorsad.

This vesicle is surrounded by condensed mesenchyme and represents, in d'Hardiviller's opinion, the anlage of a separate lobe of the left lung. The pulmonary arteries descend symmetrically on each side, ventral to both the right eparterial bud and the proximal bud from the left stembronchus, and then turn dorsad to follow the dorso-lateral surface of the stembronchi. Both the right and left cranial buds turn dorsad after arising from their respective bronchi. Possessing identical origin, direction, and relation to the pulmonary artery they appear as absolute morphological homologues. D'Hardiviller hence concludes that the lungs of the rabbit begin their development as bilaterally symmetrical organs, the bronchial tree conforming to the bilaterally symmetrical eparterial form (Aeby's type I^A). The asymmetry is acquired during subsequent development. The right eparterial anlage continues to extend, but the left eparterial vesicle becomes gradually reduced and finally disappears altogether. In an embryo of 13 days 8 hours he continues to find a vesicle attached to the cranial part of the left stembronchus, but its walls have become greatly thickened. At 13 days 15 hours the connection with the left stembronchus, hollow in the preceding stage, has been reduced to a solid pedicle, and at 14 days there is left only a slight mesodermal condensation at the site formerly occupied by this ephemeral left eparterial bud.

D'Hardiviller bases the following conclusions on the above alleged observations:

1. In the rabbit each lung at first carries an eparterial branch of the stembronchus. The left eparterial bud follows for a short period the same course as the homologous bud of the right side. It then atrophies, disappearing entirely, and the two lungs, which were originally symmetrical, become secondarily asymmetrical.

2. The three characteristic bronchial types established by Aeby in the mammalia have only a 'secondary value' (Sic!). The important factor lies in the existence of an eparterial element on each side. This may persist in development, or atrophy on the left side only, or on both sides, thus giving rise to the three principal mammalian types, viz.:

- I. Bilateral eparterial type.
- II. Right eparterial, left hyparterial type.
- III. Bilateral hyparterial type.

3. The left eparterial anlage is not a side branch of the first ventral (hyparterial) bronchus. (Narath.)

4. The bilateral embryonic eparterial anlagen explain the human bronchial variations

It is curious, and somewhat amusing, to find D'Hardiviller so carried away by the importance of his own discovery that he assigns only a 'secondary value' to Aeby's bronchial types, from which his own work derives its chief significance as confirming the prediction made by Aeby seventeen years before. But aside from this rather interesting exhibition of scientific temperament, the embryological evidence presented by d'Hardiviller would have afforded absolute and convincing proof of the correctness of Aeby's thesis, if substantiated by other observers. It is a matter of regret that the astonishing revelations of d'Hardiviller, differing from the findings of nearly all other investigators who have studied the problem of mammalian pulmonary development, have not, in the twenty-three years which have elapsed since their publication, received the attention which they would abundantly merit if confirmed. Narath (33) and Flint (21) are the only investigators who have seriously considered d'Hardiviller's claims. The reason for this is to be found in the fact that when Narath, in his large monograph, published in 1901, appeared as the chief supporter of Willach's (37) Migratory Theory, subsequently to be considered in detail (p. 133), he found himself confronted by d'Hardiviller's observations, which, if valid, demolished at one stroke the main contention of the theory he supported, and definitely proved Aeby's hypothesis. Narath's chief publication, embodying the results of careful work extending over a number of years (1892-1901), followed so closely upon the announcement of d'Hardiviller's findings, that he could not, or at any rate did not, subject them to an independent revision. He hence naturally accepted them at their face value, and so found himself taken at an unfair advantage in meeting them. He based his chief argument against the conclusions

drawn by the French observer on the cases of human bronchial variations reported by Chiari (6, 7, 8, 9) and Dalla Rosa (10) with double right eparterial bronchi, in which the additional bronchus arose either from the stembronchus or trachea. Narath suggested that analogous variants, if they developed on the left side, would sufficiently account for d'Hardiviller's 'left eparterial vesicles.' He further cited two instances in the adult rabbit in which the upper lobe of the left lung, normally supplied by the ascending branch of the first ventral hyparterial bronchus, received an additional branch arising from the stembronchus nearer to the tracheal bifurcation and dorsal to the pulmonary artery, thus repeating in atypical adults the temporary conditions described by d'Hardiviller for the normal embryo.

In a series of 70 adult rabbit lungs, which I examined by corrosion for the occurrence of bronchial and arterial variants, I found in one individual the cranial pole of the left lung supplied by an atypical first branch of the left stembronchus arising dorsal to the pulmonary artery, and corresponding in position to the larger eparterial bronchus of the right lung. I have examined with the utmost care all the series of rabbit embryos of the critical stages, between 12 and 15 days, and from 8 to 11 mm. in length, which were available to me. These include the series of the Columbia collection and a number of preparations lent by my colleagues in other institutions. Not in a single instance has it been possible to detect even an approach to the conditions described by d'Hardiviller. A very large and closely graded series of cat embryos in the Columbia University Collection, with numerous individuals of the same stage, and a similar, though less extensive series of embryos of the albino rat, which I owe to the liberality of The Wistar Institute, have given the same negative results. I do not believe it possible that these preparations can fail in representing correctly the true morphological conditions obtaining in the critical stages of these mammalian embryos, and I hence do not hesitate to pronounce d'Hardiviller's conclusions erroneous and his generalization unwarranted on the evidence. D'Hardiviller does not mention the number of embryos in which he found his evanescent vesicle. The context

of his publication implies, however, that he regards it as of constant occurrence. Blisnianskaja (3), who accepts d'Hardiviller's observations without questioning their validity, states (p. 11) that the French author claims to have seen the evanescent left eparterial bud and its subsequent atrophy uniformly in all his embryos of the critical stages. In a careful perusal of d'Hardiviller's paper I have been unable to find an explicit statement to this effect. I may have overlooked the passage referred to, but not quoted, by Blisnianskaja.

To summarize this critique of d'Hardiviller's contribution I would repeat that, in my opinion, his conclusions cannot be utilized in support of the Reduction Theory as whose main prop they imposed at the time of their appearance. The most plausible interpretation, which I can give of this extraordinary publication, is that the French investigator, by some marvelous chance, or owing to the perpetuation of a restricted racial character in his material, encountered a group of variant rabbit embryos, which, if development had proceeded, would have yielded atypical adult individuals possessing the left eparterial bronchial variant described above. No warrant is hereby given for the assumption that such embryonic variants possess the phylogenetic significance attributed to them by the author, or that they play the part he assigns to them in the normal ontogeny of the mammalian lung.

Bremer (5) published a paper on the lung of the opossum in 1904 in which he described his findings in younger and older stages of pouch-embryos of *Didelphis marsupialis*, L. (*virginiana*, Shaw) and in the adult of the same form. His material consisted of six new-born opossums, taken from the same pouch, ranging in size from 10.5 to 12.5 mm., two older pouch-young, of about 14 cm. in length, and three adult animals.

In five out of six of the embryos in the youngest litter Bremer made Born reconstructions of the lung, the sixth proving not suitable for this method. He describes the presence of both a right and left eparterial bronchus in all of these models. Regarding the left eparterial component he says (p. 71):

That on the left side is always smaller and slightly lower placed, and the air-chambers supplied by it do not form the apex of the lung, still in spite of its small size and relatively low position, it is distinctly above the first ventral bronchus and behind the artery and so corresponds to the eparterial bronchus of the right lung, and may be considered as making the two lungs symmetrical and reptilian in type, as no placental lungs are.

In the older pouch-stages (14 cm.) and in the adult animals the opossum-lung is described (p. 72) as changing "from the reptilian to the mammalian also in the loss of the left eparterial bronchus." Bremer is unable to state how this loss is brought about, owing to the lack of the requisite intervening stages in his material. These observations range themselves therefore in support of d'Hardiviller's claim discussed above that in the mammal (*Lepus*) the left stembronchus carries at one stage of its development an ephemeral eparterial bronchial anlage which during the period of its temporary existence renders the right and left lungs symmetrical equivalents. They therefore call for careful consideration here, since they constitute the only evidence confirmatory of d'Hardiviller's observations which has been offered in the entire literature. They hence fall within the scope of this paper in a discussion of the Reduction Theory.

In his admirable account of the development of the lungs in the pig published in 1906, Flint (21) considers Bremer's findings from two important standpoints:

He calls attention (p. 22) to Bremer's statement that no placental lungs are symmetrical in the possession of a bilateral eparterial development and quotes in refutation the long list of mammalian forms (since materially increased) published by Aeby (2), Narath (33) and myself (25) in which the bilateral eparterial bronchus is normally found.

Flint also questions the accuracy of Bremer's assumption that the bilateral eparterial development is a reptilian character and cites a personal communication from Hesser (22) who was unable to detect any eparterial bronchial development in his reptilian material. Flint concludes his consideration of the question with the following statement (p. 116):

It is thus hardly possible in these observations of d'Hardiviller and Bremer that we are dealing with a true regressive process. In fact, it is more probable that in both cases we are either dealing with a variation or a dorsal bronchus which is placed higher up than usual upon the stembronchus. This assumption is made quite probable by Bremer's statement that his eparterial bronchus did not supply the apex of the lung.

I can endorse this conclusion absolutely. Through the courtesy of Professor McClure I have had the opportunity of studying and reconstructing the lungs in two uterine embryos of *Didelphis* and in one uterine embryo of *Dasyurus*, contained in the embryological collection of Princeton University. No trace of a left eparterial bronchus was found in any of these. While these embryos and their reconstructions will be described and figured fully in a more extensive forthcoming publication dealing with the morphological details of the marsupial lung, I append here two views of the model of the bronchial tree and pulmonary artery in the 10 mm. uterine embryo of *Didelphis marsupialis*. The architectural pattern of the lung conforms entirely to the dominant placental type, with the anlage of the eparterial bronchus restricted to the right side. The left stembronchus does not carry a corresponding component, but is entirely hyparterial in its distribution. After giving off its cranial eparterial derivative (*Ep.*) in the typical situation the right stembronchus carries three well developed ventro-lateral hyparterial bronchi and the less far advanced anlage of the fourth (V^1-V^4). The cardiac bronchus, with three laterals and the expanded end bud, is derived from the ventro-medial aspect of the right stembronchus at the level of the caudal margin of V^1 . The left stembronchus gives origin to four ventro-laterally directed hyparterial bronchi (V^1-V^4), slightly less far advanced than the corresponding buds of the right side. The Ascending Branch (*A*) of left V^1 extends cranial to the level reached by the eparterial component of the right side. Each supplies the homologous apical portion of its lung. There is no indication of a left eparterial bud.

The series of the dorsal bronchi contains four distinct components on each side (D^1-D^4).

Right lung: D^1 arises from the caudal border of the eparterial bronchus. It carries three main buds, directed mesad, dorsad and laterad, each studded with several smaller evaginations.

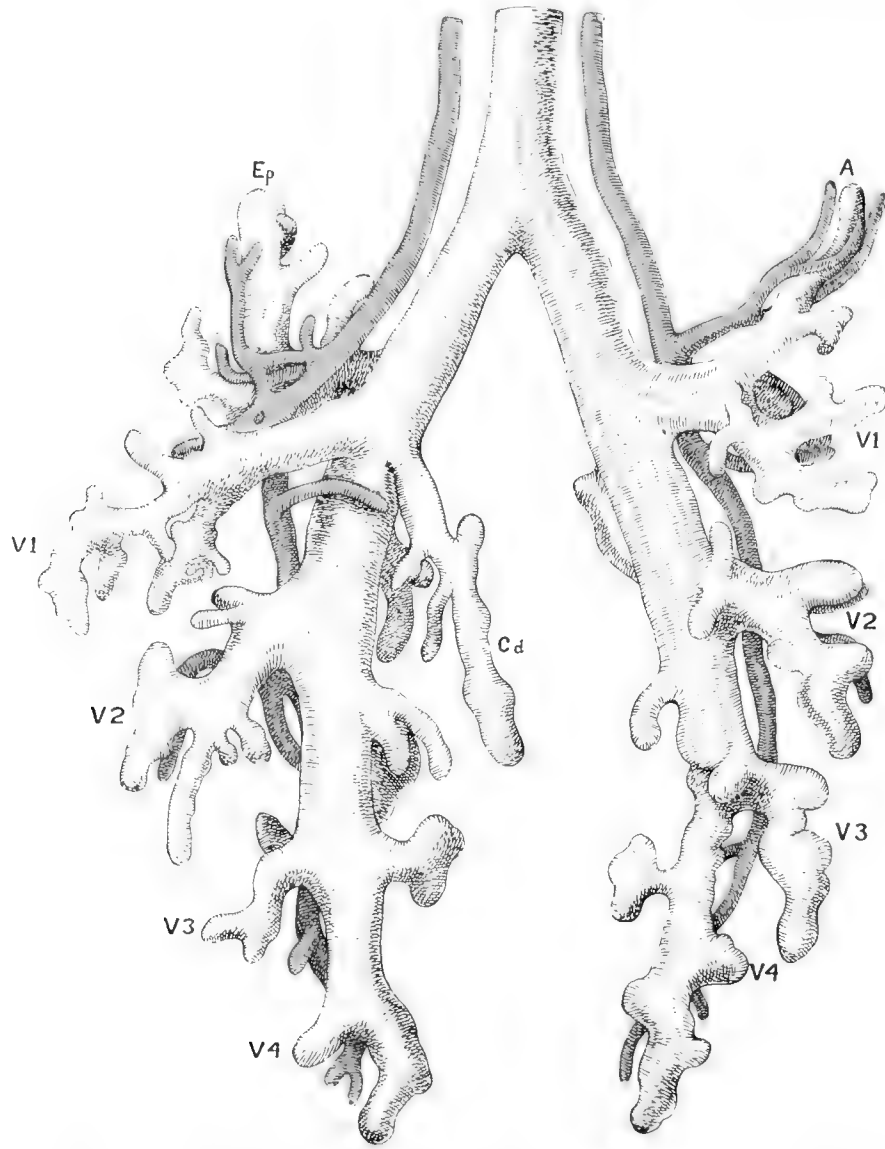

Fig. 1 Uterine embryo of *Didelphis marsupialis*, L. 10 mm. Princeton University Embryological Collection. Reconstruction of lung and pulmonary artery. $\times 150$. Ventral view. *Ep.*, eparterial bronchus; *A.*, ascending branch of first left ventral hyperarterial bronchus; V^1 - V^4 , ventral hyperarterial bronchi; *Cd.*, right cardiac bronchus.

D^2 is the largest member of the dorsal series and presents the same tripartid unfolding.

D^3 , smaller, shows a reduced trefoil pattern. D^4 is a single dorsally directed bud.

Left lung: D^1 arises from the dorso-lateral circumference of the stembronchus at the level of the caudal border of V^1 , the pulmonary artery descending between them. D^2 – D^4 are some-

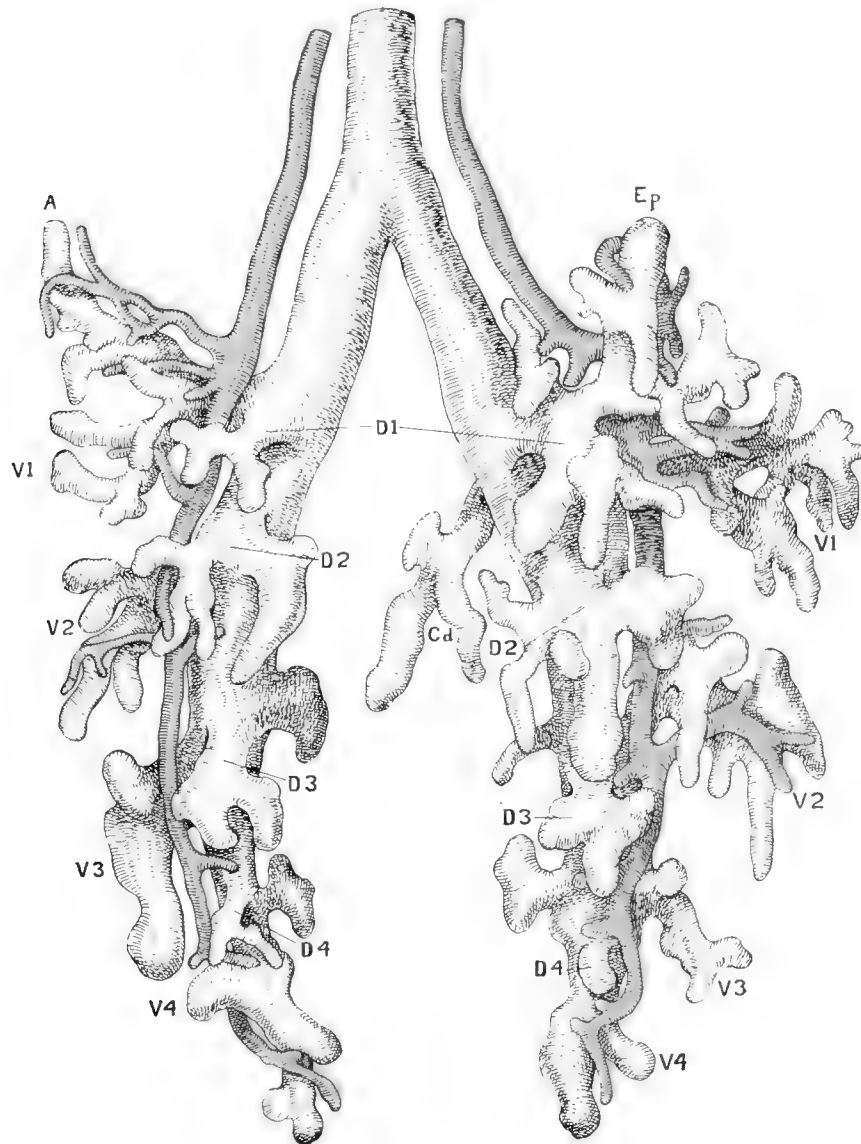

Fig. 2 Dorsal view of model shown in figure 1. *Ep.*, eparterial bronchus; *A.*, ascending branch of first left ventral hyperarterial bronchus; V^1 – V^4 , ventral hyperarterial bronchi; *Cd.*, right cardiac bronchus; D^1 – D^4 , dorsal bronchi.

what smaller than the same derivatives of the right stembronchus, but otherwise correspond to them in level and proliferation.

The pulmonary reconstruction of the 8 mm. embryo of *Dasyurus viverrinus*, which is slightly less advanced than the

Didelphis specimen, follows the same plan of bronchial organization, with the eparterial but limited to the right lung.

In comparing these reconstructions with Bremer's account (p. 71) and with the diagram of his 12.5 mm. opossum lung (p. 72, fig. 10) I am obliged to conclude that the 'left eparterial bronchus' described and figured by him is the cranial terminal of the first left dorsal bronchus, and that the lungs of *Didelphis*, as well as those of all other marsupials whose architecture has been determined, do not depart either in their ontogeny or in their adult organization from the pattern found in the dominant placental type. Otherwise it would be necessary to adopt the untenable view that the uterine embryo of *Didelphis* develops the asymmetrical bronchial anlage, with only right-sided eparterial bronchus, and that in young pouch-embryos between 10.5 and 12.5 mm. a left eparterial component appears, only to be lost in older pouch-young and the adult, thus again restoring the primitive asymmetry. This is farther afield than I am willing to follow the supporters of the Reduction Theory on the evidence thus far adduced. However, this as well as many other questions of intense morphologic interest still await the opportunity of studying large and closely graded series of well-fixed uterine embryos and early pouch-stages of the opossum. I am still in hopes that the rich embryonic material of *Didelphis* secured several years ago for The Wistar Institute through the energy and skill of Drs. Hartman and Heuser may eventually become accessible to qualified American investigators for the purpose of definitely answering the important morphological problems, the solution of which is locked up in the marsupial ontogeny.

It is of course conceivable, as in the case of d'Hardiviller's publication, that all the individuals composing the youngest litter of *Didelphis* embryos studied by Dr. Bremer possessed an aberrant bronchial organization. Against this assumption is the fact that cardinal bronchial variants of the adult are excessively rare throughout the entire marsupial suborder, as compared with the placentalia. Narath (33, p. 326) found no instance of the left eparterial (apical) bronchus in 16 representatives of 9

marsupial genera. I obtained corresponding results, not encountering a single left eparterial bronchus in my entire series of marsupial lungs, the details of which are included in a forthcoming publication. My material comprised 89 examples of 18 marsupial genera, distributed among 46 species and including 29 individuals of *Didelphis* assigned to 8 species, with 17 specimens of *D. marsupialis (virginiana)*. I therefore believe that Bremer's interpretation of his 12.5 mm. opossum embryo is at fault in disregarding the fact that in its typical course the left pulmonary artery of this form extends caudad in the interval between the rows of primary ventral and dorsal derivatives from the stembronchus in all embryonic stages, so that a dorsal bronchus is always placed behind, a ventral always in front of the artery at any given level of the lungstem.

In the passage quoted above Bremer lays stress on the observation that the left bronchial element interpreted by him in the 12.5 mm. *Didelphis* embryo as an eparterial anlage arose distinctly cranial to the derivation of the first ventral bronchus, as well as behind the artery. This high origin of a left first dorsal bronchus is very unusual. In all of my reconstructions of younger pouch embryos (3) and in the corrosions of older stages the bronchus has invariably arisen distinctly caudal to the level of V^1 . Its more cranial origin described by Bremer must, I believe, be considered a variant, as already suggested by Flint (21), which may have wrongly simulated a left eparterial anlage.

As the concluding lines of the passage quoted above indicate, Bremer regards the reptilian lung as possessing a bilateral eparterial system and differentiating in this regard from the mammalian types. Both of these assumptions are incorrect. Many mammalian genera and species are now known to have typically a bilaterally symmetrical eparterial bronchial organization. Others show in individuals in addition to the normal right eparterial bronchus a corresponding derivative from the left stembronchus as a variant acquisition. In both groups the eparterial components are distinct mammalian neomorph developments and not reappearances of an archeal reptilian character. The assumption that the modern reptiles possess a

symmetrical eparterial unfolding in both lungs is based on the very few prophetic remarks with which Aeby (2) concludes his main work on the mammalian bronchial tree. He there (p. 96) merely expresses the expectation that the contrast between the eparterial and hyparterial bronchial derivatives determined by

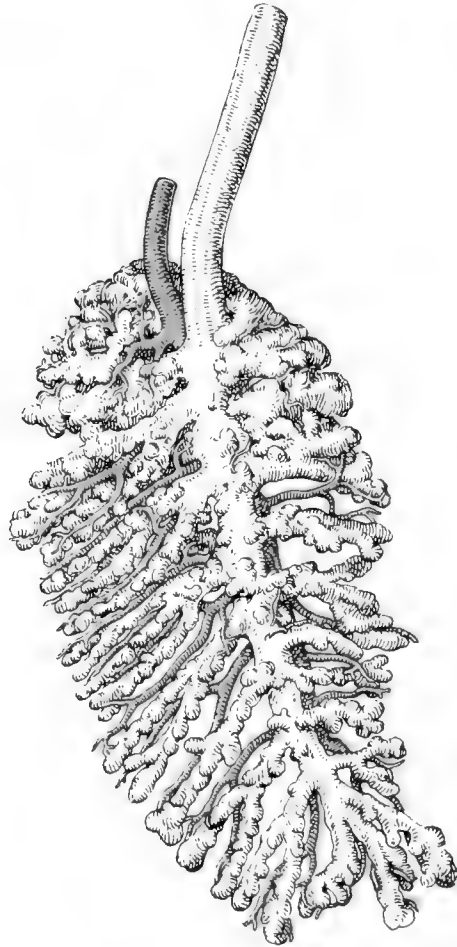

Fig. 3 *Aspidonectes spinifer*, Le Sueur. Corrosion of right lung and pulmonary artery. Ventral view. Columbia Morph. Mus., no. 1931.

him for the mammalia would be found in the reptilia represented by a transition into parallel longitudinal rows of bronchi, placed on the medial and lateral side of the pulmonary artery. Further suggestions along this line he considers unwarranted in view of his lack of material.

Zumstein, one of the earliest investigators to analyze Aeby's view critically, reported (39) on several reptilian lung corro-

sions. In one marine chelonian of undetermined genus he describes the pulmonary artery as crossing the stembronchus high up, before any lateral bronchi arise, and continuing caudad on its dorso-lateral aspect, giving branches from each side to the bronchial derivatives. The distribution of the tree is therefore entirely hyparterial. Hesser (22), as quoted from a personal communication by Flint (21, p. 22), was unable to find an eparterial bronchus or a bronchus which corresponded to it in his extensive work on the reptilian lung.

My own material convinces me that in the reptile the archeal hyparterial type of bronchial organization prevails uniformly as soon as the phyletic stages are reached in which the definition is at all applicable. The simpler lacertilian forms show the beginning of a more complex organization in the cranial segment of the lung. This increases in the higher types, reaching its greatest development in the marine chelonia and in the crocodilia.

Figure 3 shows a corrosion preparation of the right lung of *Aspidonectes spinifer* (Columbia University Morph. Mus. no. 1931) from the ventral aspect. In the cranial segment the stembronchus is encrusted with a rich efflorescence of secondary and tertiary bronchial buds. In the rest of its extent the stembronchus gives origin to a series of regularly disposed lateral and medial primary derivatives with secondary budding. The pulmonary artery enters the cranial lung-pole close to the stembronchus and on its dorso-lateral aspect. The bronchial distribution is altogether hyparterial down to the minute details. There is nowhere any indication of eparterial bronchial budding in the mammalian meaning of the term. This is typical of the more highly developed reptilian lungs, as far as my material and observation extend. I cannot therefore regard the possession of a bilateral eparterial pulmonary organization by a mammal as in any way referable phyletically to its reptilian ancestry. On the contrary, I look upon it as a distinctly new mammalian acquisition (cf. infra, p. 175).

The lung of the Aplacentalia places itself on the basis of the early ontogeny and of the immediately succeeding stages in direct line with the ancestral reptilian type (cf. p. 192), but this evi-

dent relation rests upon the common morphogenetic and functional factors which link the reptilian respiratory tract to the early phases of its adaptation to mammalian requirements. This does not involve a hypothetical reptilian eparterial bronchial system which does not exist. When it appears in the mammalian line it does so as a new acquisition in response to very definite environmental and functional factors

With d'Hardiviller's and Bremer's position in the matter defined, it is possible to return to the critical consideration of Aeby's Reduction Theory on its own merits

This theory involves the acceptance of the following dogmata:

1. The primitive ancestral mammalian lung was, in its bronchial architecture, a bilaterally symmetrical organ, with the eparterial bronchus developed in both lungs and arising from the stem (Aeby's type I^A).

2. The reduction has chiefly affected the cranial portion of the left lung, entailing the phylogenetic suppression of the left eparterial bronchus, and resulting in the establishment of the dominant mammalian type with the eparterial bronchus limited to the right lung (Aeby's type II^A).

3. Only relatively few forms have retained the original bilateral eparterial organization (Aeby's type I^A).

4. A still more limited number of living mammalia have undergone reduction also of the right lung, thus establishing the bilateral hyperarterial distribution of Aeby's type III.

An analysis of these theses provokes the following critical considerations:

1. The assumption of a bilaterally symmetrical bronchial tree in the most primitive mammalia or promammalia rests on pure hypothesis and is incapable of direct proof. With the elimination of the evidence offered by d'Hardiviller and Bremer, the ontogeny of the mammalian lung does not throw the light on the problem which was confidently anticipated by the author of the theory. The type of bronchial architecture characteristic of any given mammalian species manifests itself unmistakably in the earliest pulmonary anlage of its embryos as soon as the differentiation of individual bronchial components appears.

2. Assuming that the dominant type of the lung in modern mammalia, with elimination of its left eparterial component, received no compensation for this loss by augmentation in other directions, the primitive lung, in respect to expanse of respiratory area and functional efficiency, attained a higher degree of development than is exhibited by the vast majority of extant types.

3. As far as actual evidence is concerned this deduction from the tenets of the Reduction Theory is opposed both by palaeontological and comparative anatomical evidence. The line separating the general reptilian and mammalian organizations of to-day is nowhere more sharply drawn than in the distinction between poikilo- and homoeothermal vertebrates, which rests in the last analysis upon the different ratio of tissue-combustion in the two groups. This in turn is determined by the difference in the rate of the respiratory metabolism and is dependent upon the degree of structural development attained by the respiratory organs. It is scarcely conceivable that the descendants of a reptilian ancestry, with relatively low pulmonary organization, should enter the path of mammalian evolution with such a superabundant respiratory endowment as to necessitate its reduction in the course of their further advance. On the other hand the weight of the comparative anatomical data leads to the conclusion that the bilateral eparterial bronchial development is favored, if not genetically contingent upon, certain environmental and functional factors, such as aquatic habitat and resultant periods of very active respiration alternating with suspension of the function during submersion, great bulk of the musculature, rapid or long continued locomotion, etc. All these may have played an important part in association with a higher pulmonary organization, evidenced by the more extensive eparterial development of the cetaceans, pinnipede carnivores and ungulates. Were these or similar environmental influences decisive in the evolution of the ancestral mammalia, and accountable for their high degree of pulmonary expansion? The Reduction Theory would demand that the early mammalia were bulky, aquatic forms with a pulmonary unfolding so far in excess of the

requirements of their modern descendants, that in the majority of these a very considerable reduction of the respiratory area was made possible and actually effected in the course of evolution, leaving the relatively small number of extant bilaterally eparterial forms as representatives of a preceding archeal phyletic stage. The palaeontological evidence bearing on the origin of the mammalia declares the contrary to have been the case and characterizes the earliest mammalian or promammalian types as exceedingly small animals, about the size of a shrew, with terrestrial, probably arboreal, habitat. Mandibular remnants and teeth form practically the only evidence of their presence during the entire geological period of enormous length extending from the mesozoic to the upper cretaceous.

Palaeozoologists ascribe this long continued suppression of the mammalian stem to unfavorable environment, chiefly due to the domination of the mesozoic reptiles. In the upper limits of the cretaceous period many of the large reptilian phyla appear to have been suddenly destroyed, and in consequence the mammalia began a very rapid course of evolutionary development and advancement. The earliest well known faunae of placental mammalia date from the beginning of the Tertiary period (basal and lower eocene). In the insectivora, primates, carnivora, condylarthra, amblypoda, edentata, the most primitive forms, least specialized in dentition and limbs, are always small animals of terrestrial habitat. The most primitive insectivores were even minute and shrew-like in form, the most primitive carnivores and archaic ungulates about as big as a large opossum. Gregory and Mathew hold that the immediately ancestors of the early Eocene faunae were arboreal types more or less resembling the modern opossum in appearance and habits.

The palaeontological evidence as to the origin of the Marsupalia is slender, but supports the opinions of Huxley, Dallo, and Bensley, that both the Polyprodont and Diprodont types have been derived from small arboreal forms resembling the *Didelphyidae* in most characters. The marsupalia as a group appear to represent endforms of a mesozoic pre-placental stock of low brain structure and more or less arboreal habitat.

In the advance of the mammalian evolution beyond the early tertiary types, the general size of the body appears to increase, sometimes markedly, in the more highly specialized forms. In the middle eocene the marine adaptations appear, developing into the cetacea and sirenia. The pinnipede carnivora represent a later branching, which never played an important part in mammalian evolution. The view that all aquatic vertebrates, except the fishes, have been derived from terrestrial ancestors, rests upon cumulative evidence. Fully aquatic mamma's, apart from their high specialization, are always degenerate in some respects. Gregory, in a personal communication, sums up the known facts of placental ancestry as follows:

In brief there is much evidence for the view that the remote ancestors of all the modern placental orders were small animals, perhaps of the size of a large opossum, with very low brains, small brain-case, stout jaws, high sagittal crest, heavy molars, dentition $\frac{3-1-4-3}{3-1-4-3}$, muzzle and olfactory parts large, limbs short, stout, heavily muscled, hands and feet short, pentdactyl and of more or less grasping type; diet perhaps insects, small birds and reptiles, and vegetation; habitat more or less arboreal.

Palaeontological evidence, therefore, as far as it indirectly becomes tangent to the mammalian pulmonary problem, weighs strongly against the Reduction Theory. If we group the living mamalian types with highly developed or bilateral eparterial bronchial districts together, we obtain the following general results:

Terrestrial forms:

- Perissodactyla, with the exception of *Tapirus*.
- Artiodactyla.
- Elephas.
- Hyrax.
- Some Platyrrhine Primates (Cebidae).

Aquatic forms:

- Most Cetacea.
- Sirenia.
- Pinnipede Carnivora.
- Certain aquatic Rodentia.
- Hippopotamus.

These are mostly characterized either by great bodily bulk, heavy musculature, rapid or long-continued locomotion, or by aquatic life, with its resulting effect on respiratory organization.

The earliest mammalian or promammalian types, as stated, were exceedingly small, lacking bulk and muscular development of the modern ungulate. They were land forms, the marine adaptations of the cetacea and sirenia were acquired in later geological periods. The pinnipede carnivora represent a still later and very limited adaptation to aquatic life.

3. Among extant mammalia the ontogeny of the monotreme and marsupial lung (5, 22, 30, 32, 35) furnishes exceedingly important and definite evidence of the phylogenetic descent of the primitive mammalian respiratory tract from a reptilian ancestry. Comparison of early embryos in the egg or the uterine stages with the later pulmonary anlagen after hatching or during the pouch period, clearly bridges the gap between adult reptilian and mammalian organization (cf. p. 192) but fails to show any eventual departure from the typical mammalian plan in the ontogeny of the bronchial tree in these forms.

The monotremes in particular stand morphologically in closer relation to the promammalian reptilian ancestry than any other extant mammalian type. If the earliest mammalia already possessed the bilateral eparterial expansion of the bronchial tree, it is reasonable to expect its retention, if anywhere, in these most primitive members of the class. On the contrary the cranial segments of the monotreme lung are strikingly underdeveloped. Both *Echidna* and *Platypus* possess the dominant mammalian asymmetrical type of bronchial distribution. The very small eparterial bronchus is confined, except in variants, to the right side, supplying a small apical process of the right lung, which appears to be scarcely more than a rudimentary appendage to the lung-stem. The monotreme lung, instead of supporting the Reduction Theory, suggests rather the first unfolding of the cranial lung poles leading eventually to the extension of the neomorph eparterial districts.

4. In completing this review of the Reduction Theory it is finally of interest to consider the grounds on which Aeby selected

the bilateral eparterial bronchial tree as representing the primitive mammalian condition from which he derived the remaining extant types by reduction. The reasons for adopting this view appear inadequate and not in accordance with the facts. It is, however, only just to remember that Aeby's principal effort was directed toward the construction of the firm morphological basis upon which further investigators would be able to build up the details of the pulmonary problem. He clearly recognized the value of his discoveries to phylogenetic interpretation, but not only refrains himself from drawing premature detailed inferences, but distinctly cautions against such an attempt.

In discussing the distribution of his three bronchial types and their two subdivisions among the mammalian orders, he says (2, pp. 9-11):

Von besonderem Interesse sind diejenigen Ordnungen, deren Glieder verschiedenen Lagern angehören. Hier ist wohl auch für weitere Forschungen in erster Linie der Hebel anzusetzen, um zu erfahren, in welcher Vertheilung und mit welchen Abänderungen der Anschluss an die eine oder andere Seite erfolgt. So lange dies nicht geschehen, erscheint es verfrüht, in allfällige phylogenetische Erwägungen einzutreten, und muss es bei der einfachen Thatsache sein Bewenden haben, dass Pferd und Tapir unter den Perissodactylen nicht einig gehen und dass das Lama gegenüber den andern Artiodactylen, das Stachelschwein gegenüber den Nagern, das Faulthier gegenüber seinen zahnlosen Genossen eine Sonderstellung einnimmt. Leider ist es mir trotz vielfacher Bemühungen nicht gelungen, nach dieser Seite hin mein Untersuchungsmaterial zu erweitern.

Occupying this conservative standpoint Aeby appears to have linked up his five bronchial types almost at random. His choice of the bilateral eparterial tree as the primitive form, which led to the establishment of the Reduction Theory, was perhaps determined by the fact that the converse symmetrical bilateral hyperarterial type was known to him in only one species of the Hystricomorphs, *Hystrix cristata*.

He says (l.c., p. 12):

Auf dem jetzigen Standpunkte der Morphologie erscheint es wohl kaum als zweifelhaft, dass die verschiedenen Formen des Bronchialbaums zu einander in genetischer Beziehung stehen. Welche von

ihnen ist die primäre? Nach allem, was die Entwicklungsgeschichte der Organe bisher zu Tage gefördert, sicher eine der symmetrischen. Zwischen den beiden, die zur Verfügung stehen, wird die Wahl dadurch wesentlich erleichtert, dass in der einzigen Lunge, welche der eparteriellen Stockwerke entbehrt, auch die hyperteriellen eine hochgradige Verkümmernng erlitten haben. Dadurch gewinnt die ganze Bildung den Charakter eine Reduktionsform, deren Ausgangspunkt auf breiterer Grundlage gesucht werden muss. Eine solche ist der Bronchialbaum mit eparteriellen Bronchen in beiden Lungen. Auffällig bleibt dabei immerhin, dass gerade diejenigen Säugethiere, bei denen man am ehesten geneigt sein möchte, den Besitz einer Grundform vorauszusetzen, nämlich die Monotremen und Beutler, sie nicht besitzen. Sollte da nicht von der Ontogenie Aufschluss zu erwarten sein?

It is difficult to find an adequate reason for Aeby's assumption of a 'hochgradige Verkümmernng' of the bilateral hyperterial bronchial tree in *Hystrix cristata*. It may have been due, as his figure suggests, to the fact that he examined this lung by dissection and did not have the control afforded by a good corrosion preparation. The lung of *Hystrix* is unique among mammals in its type of lobation. The entire organ is split up into numerous small polygonal lobules and is likely to give the impression of a somewhat abortive structure when handled. It possesses the delicacy and friability characteristic of many rodent tissues, and is very liable to injury during manipulation, preventing its complete distension. The suggestion of deficiency which Aeby received is also fostered by the minute size of many of its lobular subdivisions, the organ resembling in the plan of its organization, e.g., the sea-weed like liver of *Capromys pilorides*, and by the fact that the proximal segments of the stem-bronchi are included, at least in many individuals of *H. cristata*, within a widely expanded tracheal bulla, in place of the typical bifurcation.

That the reduction of the lung assumed by Aeby does not actually obtain in the bilateral hyperterial type, is abundantly proved by the rich unfolding of the bronchial tree shown in good corrosion preparations. The foregoing review shows that Palaeontology, Palaeozoology, Ontogeny and Comparative Morphology are at one, as far as the available evidence goes, in refuting the claim to primitive archeal character made in behalf

of the mammalian eparterial system by the tenets of the Reduction Theory of pulmonary evolution in the mammalia. I consider that the same should be definitely abandoned in the present stage of the problem.

II. EXTENSION AND MIGRATION THEORIES

Willach (1888), Young and Robinson ('89).
Ewart (1889), Zumstein ('89), Robinson ('89).
Narath (1892), Huntington ('98).
Narath (1901), Blisnianskaja ('04).

The inconsistencies in Aeby's Reduction Theory discussed in the preceding section soon led observers to follow two lines of thought which were necessarily at that period linked more or less closely together. One of these, which can be defined as the Extension Theory, sought to approach the problem on its more purely phyletic side, while the second, as the Migration Theory, dealt with the morphogenetic factors supposed to be operative in the development of the different architectural types of the bronchial tree encountered in the mammalia.

A. EXTENSION THEORY

On the basis of the phylo- and ontogenetic facts above considered, and supported by additional observations, I advocated, in a paper published in 1898, (25) a reversal of Aeby's Reduction Theory and regarded the bilateral hyperarterial bronchial tree as the starting point instead of the decadent termination of a phyletic series in which the bilateral eparterial type represented the full development of an evolutionary unfolding of the mammalian lung in response to varying degrees of functional demand placed upon the respiratory tract.

If either of the two bilaterally symmetrical bronchial trees is still to be considered the primitive mammalian form with which the others stand in direct genetic relation, there are weighty reasons for regarding the bilateral hyperarterial type as the most archeal bronchial organization among extant mammalia and as approaching nearer both to modern reptilian structure and to the hypothetical ancestral pattern of the promammalian lung.

This view is supported by the following considerations:

1. In the first place it does away with the untenable assumption of the Reduction Theory that the promammalia had acquired a higher and more efficient pulmonary organization than the one exhibited at the present day by the vast majority of their descendants, in whom pulmonary reduction on the left side, and in a few forms on both sides, is supposed to have established the hyparterial condition secondarily.

2. It is very clear that the mammalian lung is structurally on the ascent, rather than on the decline. It can in no sense be grouped with the decadent structures of vertebrate organization. Morphologically it does not represent the direct continuation of an old respiratory organization, but a new structure replacing the archeal branchial apparatus, which in its turn was the termination of the long evolutionary path traversed by the vertebrate respiratory tract in its many antecedent phyletic stages (cf. 29, p. 179). It is contrary to all genetic principles underlying evolution to consider a neomorph of this character capable of entering the organic complex in a state of such advanced development as to call for subsequent reduction of the number and extent of its components. The assumption of mutation is clearly not applicable under the premises, for a mutant requires a pre-existing structure in which the change becomes manifest.

3. The functional interpretation of the comparative anatomical evidence bearing on the question speaks for the progressive unfolding of the mammalian respiratory area, especially in its cranial sectors, in direct ratio to increased functional demand resulting from specific environmental adaptations leading to the establishment of the eparterial district in the more highly organized lungs.

The ungulates in general are represented by animals of massive bulk and heavily muscled. Many are endowed with the capacity for rapid and long continued motion, calling for increased tissue combustion and a rapid respiratory exchange. The members of the group have acquired a marked expansion in their pulmonary development.

In view of the recent palaeontological evidence of the separate phylogenetic derivation of the Perissodactyl and Artiodactyl types, it is significant to note that the pulmonary extension, presumably correlated with the same causative factors of body weight, muscular bulk and active locomotion, has been accomplished in the two groups by different modifications of the respiratory pattern. The artiodactyl lung is characterized by the relatively enormous development of the cranial lobe of the right side, with the supplying right eparterial bronchus arising from the trachea above the bifurcation. In many forms this exaggerated development of the right cranial lobe amounts functionally to the introduction of a third lung, extending from the right side of the thorax across the median line and capping the apex of the left lung. As a matter of record the lung of the cetacean *Pontoporia blainvillei* has been described by Max Weber (36) as possessing a bronchial tree with triple division of the trachea into three main bronchi of unequal caliber.

Among the artiodactyl ungulates the Camelidae (*Camelus*, *Auchenia*) and Giraffes are characterized by the unfolding of the typical artiodactyl right eparterial bronchus, arising from the trachea above the bifurcation, and in addition by the development of a left eparterial component from the stembronchus of the left lung.

In the perissodactyls (with the exception of the Tapir), on the other hand, the demand for extension of the respiratory area is met by the bilateral development of the eparterial bronchus derived from the stembronchus of each lung.

Among the aquatic mammalian forms the development of the lung in most cetaceans follows the artiodactyl type, while the pinnipede carnivores have developed the perissodactyl plan of pulmonary extension. It is noteworthy that the sole aquatic artiodactyl, *Hippopotamus*, agrees with the aquatic Carnivores, in the bilaterally symmetrical development of the eparterial component.

The aquatic carnivore adaptations generally possess the power of rapid and active motion through the water, executed mainly by the highly developed axial and caudal trunk musculature.

They further suspend respiration for longer or shorter periods during submersion. In almost all forms special provision is made for the collection of the venous blood in large reservoirs during the respiratory intermissions, such as the huge hepatic caval sinus of the seals, and the enormous retiform plexus of the abdominal visceral and genito-urinary veins of *Macrorhinus*. When the animal emerges for breath the large amount of accumulated venous blood calling for oxygenation requires a rapid and complete exchange. In conformity with this demand the pulmonary architecture of these forms presents the most brilliant examples of the full bilateral and symmetrical development of the eparterial system of both lungs. In attempting to evaluate the significance of these facts they lead to the following conclusions:

A. Especially exacting functional demands are accompanied by modifications of the mammalian pulmonary organization through more extensive development of the eparterial bronchial districts. This extension of the ultimate respiratory area may occur only on the more favorably disposed right side (cf. p. 185), by utilizing a more cranial point of derivation of the right eparterial bronchus, directly from the trachea cranial to the bifurcation of the main tube (artiodactyls, sirenia, many cetaceans), or on both sides by the additional development of the left eparterial trunk (perissodactyls, pinnipede carnivores, aquatic rodents, arboreal primates, Hippopotamus).

B. Environmental factors have so changed the constitution of the germplasm as to transmit the resulting alteration in pulmonary type. It is probable that the influence of environment upon the developing germ cells, and through them on the progress of evolution, has been underestimated in the past (Weismann). Variation of lung structure, especially the occurrence of mutations (28), may have been the sole, or at least the principal, phylogenetic factor which led forms possessing these modifications, and by virtue of them capable of greater pulmonary unfolding, to follow lines of environmental adaptation ending in the evolution of the marine, ungulate and aquatic types characterized in their extant descendants by the high development of the eparterial system.

In their application to the problem here under consideration these conclusions weigh heavily in favor of regarding eparterial pulmonary development not as the primitive generalized mammalian type, destined to undergo reduction in the majority of the forms during further evolution, but as a condition secondarily acquired under the stimulus of increased functional demand, or through the opportunity offered by mutant variation to limited mammalian groups.

4. The bilateral hyperarterial bronchial type appears normally in very few living mammalia.

The scattered and more or less incomplete records and observations published on the lungs of the cetacea led Weber (36) to ascribe, at least tentatively, to *Balaena mysticetus* and *B. antipodum* (possibly also to *Orcella fluminalis*) the possession of the hyperarterial bronchial organization. It is, however, extremely improbable that this assumption would be sustained if the actual facts were thoroughly understood and correctly interpreted. There remains little doubt that all cetacea have a bilateral bronchial tree either with the right eparterial bronchus tracheal, the left bronchial in derivation, as in the Camelidae and Giraffa, or, conforming to the prevalent artiodactyl type, with the highly developed eparterial element present only in the right lung and derived from the trachea.

Among the terrestrial mammalia the bilateral hyperarterial bronchial tree is normally encountered in a number of species belonging to the rodent group of the Hystricomorphs and in the mustelid carnivore *Taxidea americana*.

Both forms find within their respective orders fairly close taxonomic relatives carrying the dominant mammalian asymmetrical bronchial type with right sided eparterial development. Both agree with their nearest zoological relatives in respect to body-build, weight, habitat, mode and speed of locomotion, hibernation, etc., all extrinsic factors which may exercise an influence on the range of pulmonary development. Likewise in food habits, dentition and structure of the alimentary canal they conform to the rodent and mustelid carnivore type. The only morphological character which differentiates them sharply

from the remaining members of their respective groups is found in their intrapulmonary organization. This raises the important question, what is the evolutionary significance of cardinal divergence in the bronchial architecture and what its value as a genetic character in determining phyletic kinship?

To take the example of *Taxidea* as a concrete case in point. The zoological group of the *mustelidae*, in which *Taxidea* is included, is derived by Prof. Gregory from the lower oligocene *Plesictis*. Considering the facts obtaining in the modern descendants of this common ancestral form the Reduction Theory would hold that the *Plesictis*-lung has already developed the dominant mammalian type with the retention of the dextral eparterial bronchus, and the same had been transmitted unchanged to all of the modern descendants, with the single exception, as far as known, of *Taxidea*. In this form further pulmonary reduction occurred, resulting in the phylogenetic loss of the right eparterial lung-segment and the acquisition of the tracheal bulla. It is difficult to conceive of environmental changes, capable of inducing this reduction, and confined in their operation to *Taxidea*, to the exclusion of the other *mustelidae*. The supposition assumes the existence of morphogenetic factors which we find nowhere in the mammalian series. I do not know of a single instance of even a probable reduction of a formerly developed pulmonary segment in a mammalian lung. The phylogenetically acquired metameric reduction of the trunk cavity in mammalia, with its incidental effect on the pleural space, would in itself negative this assumption. The inclusion of the right cardiac lobe in the phrenicomedial angle of the right lower lobe in man and some other mammalia, is merely the result of the closure of the pericardiophrenic space following pericardiac fixation to the diaphragm. The morphological status of the lobe is maintained by the cardiac branch of the right stembronchus.

If d'Hardviller's alleged discovery of an ephemeral left eparterial bronchial vesicle in the embryo of the rabbit had been confirmed, it would point far more directly to an attempt on part of the left lung to acquire additional respiratory territory than to the evanescent appearance during ontogeny of a pul-

monary element lost in the phylogenetic evolution of the mammalian lung. This is confirmed by the occurrence of the adult bronchial variations of *Lepus* cited above (p. 104) in this connection. I feel that we are justified, on the basis of all of the actual evidence, in concluding that any mammalian lung which has once acquired a focal point of entodermal bronchial proliferation, retains the same in its structural organization, even against apparently unfavorable local and topographical conditions, as, e.g., in limitations of the available thoracic space.

On the other hand, accepting *Plesictis* as the common ancestor of the modern mustelidae, it is possible to assume that the *Plesictis*-lung was organized on the bilateral symmetrical hyparterial type, retained in only one of the extant descendants of to-day, *Taxidea*, while in all the other recent mustelidae, as far as determined, environmental changes have so affected the constitution of the germ-plasm as to produce the more advanced pulmonary type with the development of the right eparterial bronchus. All of our available evidence proves the mammalian lung to be extremely sensitive in its structural response to environmental changes affecting respiration. Any environment capable of producing chromomeric alteration in the developing germcells of *Plesictis* must have affected equally and uniformly all the descendants derived from the same ancestor.

The lung of *Taxidea* is physiologically as efficient in supplying the respiratory requirements of the organism it serves as are the lungs of the other mustelidae. Otherwise *Taxidea* would either have become extinct, or its lung would have adapted itself structurally to the conditions which induced the pulmonary differentiation in all the other mustelidae. The hypothesis here under discussion would therefore become untenable under its own terms, were it not permissible to analyze the evolutionary factor, which we described as environmental adaptation, more closely into its component parts.

The specific, generic and ordinal differentiations of the extant mammalia appear clearly as the outcome of adaptations to a physical environment differing widely in the various forms of mammalian organization in respect to habitat, character of food,

locomotion, etc. The great number of the divergent type owe their production to differences in the form of the alimentation adopted by each. In the final analysis the modifications of the skeletal and muscular systems arose in response to the primary necessity of obtaining food, and the manifold morphological differentiations of the intestinal tract are the structural expressions of the variety encountered in the types of alimentation. The one relation of the organism to the exterior which remains fundamentally unaltered under all conditions of mammalian evolution is the respiratory function. The air breathed by the mammal, save for slight variation dependent upon altitude, temperature, aqueous vapor, and other extraneous admixtures, remains physically and chemically the same for all forms, no matter how widely their relations to the milieu may differ in other respects.

The primitive intestinal canal of the mammal differentiates hence phylogenetically along two distinct lines, leading to results which differ correspondingly in their morphological detail and physiological significance.

The strictly alimentary portion of the tube reflects in its structure the enormous diversity of the physiological work assigned to it in the various types in strict conformity with the correlated diversity in the character of their food. This produces the various types of glandular derivatives, the structural modifications in length and caliber, the division into differentiated segments and compartments, the provision of the valvular apparatus and sphincters, the variation in the supplementary structures of the oral cavity, tongue, lips, salivary glands and teeth, the prehensile modifications of the extremities and other parts of the body, etc. The mammalian organization compasses the entire range of the digestible material included within the environmental limits to which its members have become adapted, but all mammals breathe the same air. Consequently the respiratory entodermal derivatives, in contrast to the alimentary modifications, present a simple and uniform structure. The mammalian lung conforms to but a single basic morphological type, no matter to what animal it belongs. The variations encoun-

tered depend upon differences in the number, mode of assembly and distribution of like fundamental structural units, adapted to the quantitative factor of a uniform and stable respiratory function, not upon the development of units specially modified to meet a wide range of physiological demands, varying qualitatively in the different types. The respiratory epithelium is the same wherever encountered, just as the air, with which it comes into contact in the exercise of its specific function, is a practically uniform admixture of the same chemical elements. The differences in the morphological organization of the lung in different mammalian types depend solely upon two factors:

1. The extent of the respiratory epithelial surface required to meet the physiological demands of the individual types.

2. The mode of organizing the system of conducting tubes through which the air is supplied to the respiratory area, and which of course is largely dependent in turn on the surface extent presented by the same. The question is never *what kind* of air, but *how much* air does any given mammalian organization require to run its own specific and individual machine, and how can that air be delivered most promptly and efficiently to the same.

Consequently, given the same ratio of respiratory exchange for any number of mammalia, with a diversified environment determining their evolution in various directions, they will develop into correspondingly varied groups, leaving the pulmonary structure untouched during these adaptations, provided these demand no change in the respiratory requirements of the organism. But as soon as environmental or functional conditions arise which alter the equilibrium of the preexisting balance between respiration on the one hand and all the remaining activities of the organism on the other, or which specifically change the functional aspects of respiration, they are registered in the resulting architectural changes of pulmonary structure. As above outlined the full development of the eparterial component in mammals coincides with great development of the skeletal and muscular systems and specific forms of locomotion, or with the mammalian adaptations to aquatic life. In over 90 per cent

of the extant mammalian forms, the lungs are asymmetrical organs, built on Aeby's type II, with the eparterial development confined to the right lung. This enormous preponderance of the dominant mammalian type can only signify that this degree of pulmonary extension meets the respiratory demands of all the varied specific forms which operate under it, despite their manifold diversity in other structural directions, and is amply sufficient to carry them along their specialized developmental paths.

The exceptions above mentioned stand out clearly from among the great mass of the average forms. They are all associated with an increased respiratory demand to which the resulting pulmonary extension appears as the structural response.

In contrast with these organizations typifying advance over average mammalian conditions, the small groups constituting Aeby's fifth type of bilaterally symmetrical hyparterial distribution, can only be interpreted as the remnant of an archeal mammalian organization which has been in course of evolution replaced by higher types of pulmonary development in the vast majority of living forms, but still persists in a few isolated instances and groups, as in *Taxidea* among the carnivores, and in some of the Hystricomorphs among the rodents.

I believe that the contradictory discrepancy introduced into the problem of genetic kinship by the atypical pulmonary organization of *Taxidea* as compared with all other mustelidae, of the Hystricomorphs in contrast to the remaining members of the entire rodent order, and perhaps in the cetacean exceptions mentioned, finds its ultimate solution in the fact that the effects of environmental influence upon the vertebrate organization as a whole, must be judged separately by the results shown in the individual components of the same. In other words 'Environment' is a composite concept, comprising a large number of physical factors, some of which are frequently antithetical to others in their influence on organic evolution. The vertebrate body is likewise a composite of a number of specific structures which, while they act as a unit in performing the offices of the organization as a whole, respond to their environment as individual parts

of this whole. Confronted by a variety of mutually incompatible opportunities, each pointing a divergent evolutionary path, the choice of one of these, with the necessary exclusion of the remainder, will determine the resulting structural type. Thus the components of the organism which come into direct relation with a diversified environment will adapt themselves only to certain factors of the same, with the resulting production of varied and divergent forms, while the lung, which encounters the uniform and practically unvarying influence of its specific factor, the air, will correspondingly appear as a uniform structure in all the different types.

The following conclusions can be based on these considerations in the special problem here discussed:

While the mustelidae as a group, including *Taxidea*, adapt themselves to their special environment in regard to all parts of the organism in direct relation to the same, the resulting adaptations and differentiations did not alter the status of the lung, because the environmental factors did not include the special conditions determining specific changes in the pulmonary architecture. They thus become welded into the homogeneous taxonomic group of the modern mustelidae in all the external characters of body-structure, alimentation, habitat, locomotion, etc., but the intrinsic pulmonary organization was left untouched by any environmental influence directed specifically toward structural changes in the architecture of the lung, beyond that common to the mammalian type in general. It is conceivable that the direct forebear of *Taxidea* had retained a more primitive type of bronchial organization than the remaining contemporary forms which had already advanced to the acquisition of the right eparterial bronchus.

In the course of further evolution no additional factor was introduced to alter the initial discrepancy between the two pulmonary types, which has thus become perpetuated in their present representatives.

This appears to be the most available interpretation accounting for the existence of the closely knit zoological group of the modern Mustelidae, consisting of forms which agree in the de-

tails of their general organization, but include one member, *Taxidea*, differing from the remainder in the structure of its bronchial tree.

These considerations led me to regard the bilateral hyperarterial bronchial tree as the archeal type, forming the basis of the Extension Theory, upon which the remaining mammalian bronchial organizations are built, rather than to begin at the top, and by successive detachment of branches, arrive at the bottom, as postulated by the Reduction Theory.

I am more than ever convinced by the additional phylogenetic evidence which the intervening years have brought to the study of the problem that the basic concept outlined above contains the seed of the correct interpretation of the evolutionary process responsible for the extant types of the mammalian lung structure, but I have abandoned my original views regarding the genetic stages involved. In the earlier period of this study the idea of the migration of pulmonary components was beginning to make headway and appealed to me as affording the most available explanation of the steps in pulmonary evolution upon which to base the Extension Theory. Subsequent to the publication of the same, continued further comparative anatomical and ontogenetic study of the problem led to a radical revision of my conception as to the morphogenesis involved, and I abandoned the Migratory Theory for the view which impressed me as the only logical deduction warranted by all the facts, and which, for want of a better term, can be briefly designated as the evolution of bronchial types by selection or adaptation. This Selective Theory is fully expounded in the final section of this paper. Before proceeding to its consideration it is proper, at this level of the historical review, to present the second thought linked to the theory of pulmonary evolution, viz.:

B. MIGRATION THEORY

The concept of the morphological equivalency of the right and left lungs, masked in the numerically preponderant asymmetrical types by differences in the topographical relations of the bronchial components, led early to attempts at bronchial homologization, and formed the basis of the Theory of bronchial Migration.

This Theory assumes an archeal common mammalian ground-plan of bilaterally symmetrical bronchial organization with a fixed number of main derivatives from the stembronchus, whose side branches, under the stimulus of progressive evolution, are endowed with the capacity of moving or migrating as a whole from their primitive site to new points of origin from the stembronchus, thus acquiring a greater degree of independence and altering the type of the entire bronchial tree. If the shifts occur in the same direction and to the same extent on both sides, the resulting bronchial tree remains in the bilaterally symmetrical group. If migration is confined to one lung, or carried further on one than on the opposite side, the resulting bronchial tree becomes asymmetrical as in the dominating mammalian type with eparterial bronchial development limited to the right lung. By carrying this process of 'Migration' to a varying level on the stembronchus of one or both sides, or extending it to the right side of the trachea, the different types of bronchial distribution encountered in extant mammalia are produced.

Aeby in 1880 already entertained the general concept of a phylogenetic shift or migration of bronchial components as the evolutionary factor responsible for the production of the five types of the mammalian bronchial tree determined by him. He does not elaborate this idea in any detail, but it was evidently clearly in his mind when he ascribed to his eparterial bronchus a very pronounced degree of 'Wanderungsfähigkeit.' The thought is further expressed in several passages of his work (2, pp. 6,7).

Willach (37), in 1888, formulated the hypothesis more completely, and to him must be assigned historical priority as the founder of the formal Migration Theory. He included in his

presentation the homologization of the right eparterial bronchus with the ascending branch from the first left ventral hyparterial bronchus to the cranial pole of the left upper lobe.

Finally Narath (31, 33) in a preliminary paper, published in 1892, and in his large monograph ('01) became the chief and very enthusiastic exponent of the theory, offering in support of the same many additional comparative anatomical and ontogenetic observations, and an invaluable record and classification of bronchial variants. If in the following pages I appear as an antagonist to Narath, it is solely because many years of careful study given to the problem have convinced me that the deductions which he has drawn from his material, and the theoretical conclusions based thereon, are erroneous. These I feel obliged to oppose. But I do this with a full realization and appreciation of the permanent value of Narath's contribution. His monograph is a veritable storehouse of new morphological observations and records, splendidly arranged, clearly expressed and beautifully illustrated. It will remain for all time as one of the classical records marking the progress of anatomical science.

As elaborated by Narath, the migrating theory of bronchial evolution, if followed to its logical conclusion, assumes a simple hypothetical phyletic ground-plan of bronchial organization. The stembronchus gives origin solely to a single ventro-laterally directed series of primary bronchial derivatives. Lateral branches of these alter their primitive position in the bronchial system in the course of evolution by becoming 'split off' from their original parent stems, and transfer themselves through a process of 'wandering' or 'migration' to the stembronchus, obtaining thus new and independent points of origin directly from the same. In the words of the theory, as stated by Narath, the original ventro-lateral branch of the stembronchus has 'ceded' ('abgegeben') one of its lateral derivatives to the same.

The evolutionary record of the dominant mammalian type (Aeby's type II^A) would read as follows:

The bronchus destined eventually to supply the upper lobe of a fully developed right lung makes its first appearance as a

side-branch of the first ventral derivative of the right stem-bronchus (Aeby's first right ventral hyparterial bronchus). It then detaches itself from the parent stem and shifts or 'migrates' dorsad onto the right main stembronchus and joins a group of similar branches derived in the same way from the primary ventral bronchi arising further down in the row from the stembronchus. It constitutes thus the most cranially located member (D^1) in the series of Aeby's dorsal bronchi. As such D^1 comes to extend into the dorso-cranial lung segments, supplying its cranial pole, as Narath's 'apical' bronchus. It possesses the faculty of continuing to wander further craniad along the stembronchus. When this migration has carried it above the level of the intersection of stembronchus and pulmonary artery it becomes, still as 'apical' bronchus, the equivalent of Aeby's eparterial bronchus. It is able to extend its forward march, leaving the domain of the right stembronchus and gaining an origin from the right side of the tracheal bifurcation or from the lateral wall of the trachea above this level, as in the artiodactyl lung (Aeby's type II^B). In the left lung the same component ('apical' bronchus) retains the primitive origin from the first ventral hyparterial bronchus, appearing as its ascending branch, does not emigrate and supplies the dorso-cranial segment of the left upper lobe.

If it follows the course taken by its homologue of the right side and wanders craniad onto the left stembronchus, Aeby's bilateral eparterial type I^A develops. If no shift occurs on either side the bilateral hyparterial tree is produced (Aeby's type III).

Other lateral derivatives of the primitive ventral branches, usually small and of minor importance, wander from their parent stem to the stembronchus and then appear as secondary branches of the same (accessory bronchi, Aeby's 'Nebenbronchien'), arising from the main canal in the intervals between the rows of principal ventral and dorsal bronchi.

Ordinarily only one of these, derived originally from the first or second ventral bronchus, migrates to the stembronchus and attains a greater degree of development, supplying, as right cardiac (infracardiac) bronchus, the azygos or cardiac lobe of the

right lung. A similar accessory bronchus may develop on the left side as the left cardiac bronchus to a left azygos lobe, or to the corresponding portion of the left lung stem.

The thought underlying this concept of mammalian bronchial evolution is best expressed in Narath's own words: "Es herrscht ja überall im Bronchialbaum das Gesetz der Abspaltung."

This condensed account embodies the chief dogmata of the Migration Theory. It is psychologically of interest to consider briefly the reasons for the ready acceptance of this idea and its almost universal adoption in scientific and educational circles to-day.

In the first place the enormous numerical preponderance of the dominant type II^A among living mammalia imparts to the four remaining architectonic types the character of aberrations. By reason of their bilateral symmetry they give the impression of being either earlier, more primitive forms, or they suggest a relation to type I^A, as representing deductions from the same or additions to type III. No observer who has studied large series of pulmonary corrosion preparations can fail to recognize the close architectural gradations of the bronchial tree in different forms. Without considering the variations within a single species, which are often numerous and highly suggestive, when many individuals are compared, it is easy to form long series whose links pass into each other by almost insensible degrees, and thus join the extreme examples of a type at either end of the line. It is natural to regard these transitions as pointing the way to the phylogenetic derivation of a given type from a preceding stage by a shift or migration of some of its bronchial components. Narath furnishes an excellent illustration of this mental process. In support of his contention that the dorsal derivatives of the stembronchus were originally side branches of the ventral bronchi which have migrated onto the stembronchus itself, he says (33, p. 311):

Man kann sich bei manchen schön gelungenen Injectionspräparaten kaum des Gedankens erwehren dass der dorsale Bronchus ein Artgenosse der externen Seitenäste der Ventralbronchien ist und dass er gewissermassen als Vorposten vorgeschoben wurde auf den Stammbronchus.

Especially in comparing the right and left lung of type II^A does the physiological and topographical correspondence between the right eparterial trunk and the ascending branch of the first left ventral hyparterial bronchus impress itself in the above sense on the observer. The two bronchi supply equivalent districts of their respective lung and agree in many forms so closely in the details of their secondary derivatives, that the impulse, as Narath puts it, is almost irresistible to regard the right eparterial trunk as having, in some way, become separated from its original parent stem, the right first ventral hyparterial bronchus, and moved dorso-cranial upon the stembronchus to a varying distance ahead of the main pulmonary artery, while its homologue of the left lung retains its archeal origin from the first left ventral hyparterial bronchus, appearing as its ascending branch.

As soon as this idea has acquired concrete form and expression in the terms 'splitting off' (Abspaltung, Ablösung) and 'migration' (Emigration, Ueberwanderung, Abgebung) of bronchial elements, it at once dominates the entire concept of bronchial architecture and its mode of evolution. Not only do all the main types find their ready interpretation as various phases of the process of 'migration,' if the same is once accepted, but all variants within a type, the occurrence of accessory bronchi, in fact any and all departures from the usual pattern, are only so many additional proofs in substantiation of this hypothetical method of bronchial evolution. A term conveying easily visualized mechanical changes has here been made to take the place of critical analysis of the actual morphogenetic processes involved. When we turn to the two sources alone directly available, comparative anatomy and ontogeny, for corroborative evidence in support of this theory of bronchial migration, it is either altogether wanting, or it flatly contradicts the theory. The crux of the entire question is not so much the exact point occupied in a given type by a given bronchus, but how did it attain that location in the course of phyletic or ontogenetic development. Let us examine some of the details of the problem more closely.

At the outset it will become apparent that the theory, if carried back to its logical starting point, will bring us to a novel con-

cept of the early phylogenetic type of bronchial unfolding. If the right eparterial and cardiac bronchi of the prevalent type were primarily derivatives of the first ventral bronchus, the former a dorsal, the latter a ventro-medial branch, and if in the rest of the series all dorsal, dorso-medial, and ventro-medial components of the stembronchus were originally derivatives from the primary ventro-lateral bronchus of their respective levels, then these premises would define the most primitive mammalian or promammalian stem-bronchus as giving origin solely to monopodic ventro-lateral derivatives, whose secondary branching

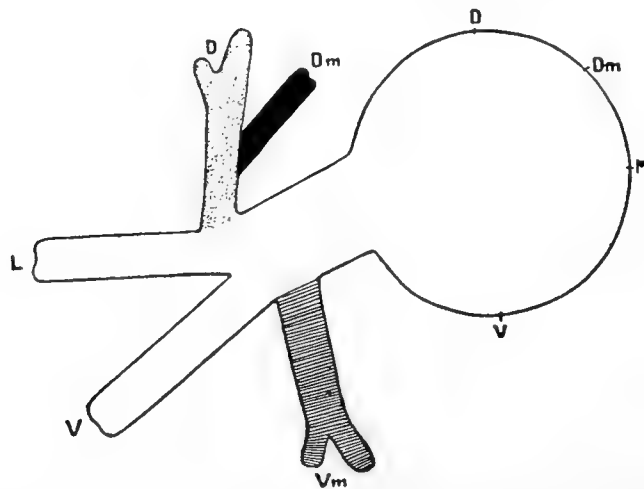

Fig. 4^A Hypothetical plan of the primitive derivatives of the stem-bronchus, as stipulated by the Migration Theory.

carries their distribution into the remaining dorsal, dorso-medial and ventro-medial districts. The schematic cross section of a hypothetical reconstruction of this bronchial type would appear as in figure 4^A. Migration then becomes responsible for the redistribution of the components shown in figure 4^B.

The pulmonary organization represented in figure 4^A is not found in the phyletic series.

If this is accepted as indicating the earliest phylogenetic mammalian type of bronchial organization, one of two conclusions would be inevitable:

a. Either the mammalian lung represents the persistence of a more primitive pulmonary type than that found in the embryo or adult of any of the extant lower vertebrates, or

b. The mammalian lung is a cenogenetic structure and does not represent the end-link in a continuous evolutionary process. There is no phyletic relation between it and the lungs of the lower vertebrates.

Neither of these hypotheses is tenable. On general phylogenetic grounds the migratory theory not only receives no support, but is positively contradicted.

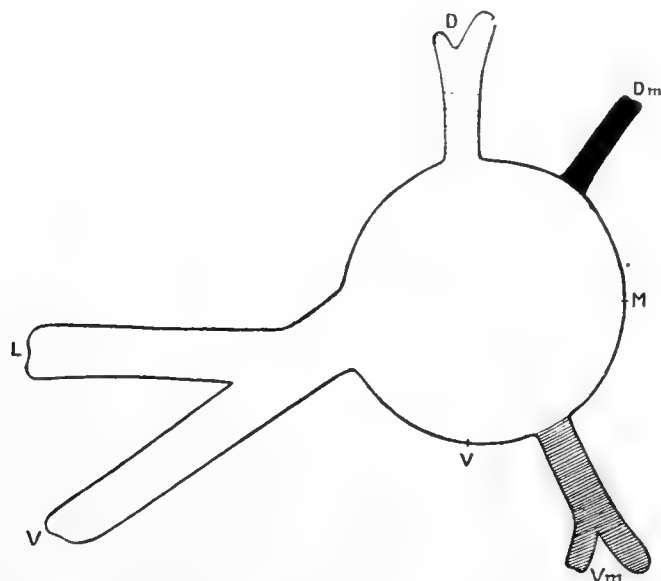

Fig. 4^B Their subsequent redistribution through migration. V., ventral; V-L., ventro-lateral; D., dorsal; Dm., dorso-medial; M., medial; Vm., ventro-medial.

Hesser, in his important and thoroughly scientific paper on the development of the reptilian lung (22) voices this fundamental objection to the migratory theory admirably. In discussing the much-mooted question of monopody versus dichotomy in the development of the bronchial system he says (p. 301):

Stellt man das, was Narath an verschiedenen Stellen geäußert hat über den phylo- und ontogenetischen Ursprung der vom Stammbronchus ausgehenden Äste, zusammen, so kommt man zu einem Resultat, welches schon an und für sich unwahrscheinlich erscheinen muss, und welches im Lichte des Baues der niederen Lungenformen als falsch bezeichnet werden muss. Er sagt nämlich, dass nicht nur die dorsalen Seitenbronchien in ihrer ersten Entstehung mit den ventralen zusammengelenkt sind, sondern dass auch die sogen. ventralen Nebenbronchien ursprünglich auf diesen angelegt werden, wie auch die sogen.

dorsalen Nebenbronchien primär Äste der dorsalen Seitenbronchien sind. Sekundär während des Entwicklungsganges kommen diese drei verschiedenen Arten Äste ihren Platz auf dem Stammbronchus zu erhalten. Aber, sagt er weiter, wenn ein Ast auf diese Weise an einen andern soll abgegeben werden können, so muss ersterer sehr früh angelegt werden, zu einer Zeit, wo der Mutterast sich nur in seiner ersten Anlage befindet und sich an der Wurzel noch nicht zusammengezogen hat.

Also würde nach Narath eine ventrale Knospe, wenn sie noch keine höhere Entwicklung erreicht hat, als dass sie die Form eines niedrigen, abgerundeten Kegels mit breiter Basis hat, Anlagen zu vier verschiedenen Ästen (einem ventralen und einem dorsalen Seitenbronchus wie einem ventralen und einem dorsalen Nebenbronchus) in sich schließen, von denen die drei letzteren sekundär den ersteren verlassen und, auch untereinander isoliert, ihren bestimmten Platz auf dem Stammbronchus einnehmen.

Ausser, das sogar Narath selbst, der doch diesem Kapitel seine besondere Aufmerksamkeit gewidmet hat, in den ventralen Knospen niemals diese vier Anlagen differenziert und dennoch im Zusammenhang untereinander hat finden können, liegt wohl a priori für jedermann etwas Unnatürliches und Unwahrscheinliches in dieser Auffassung. Verfolgt man Narath's Gedankengang noch etwas weiter, so kommt man zu dem von Narath selbst nicht ausgesprochenen und von ihm vielleicht übersehenen Schluss, dass in der Phylogenese der Lunge ein Stadium existieren sollte, wo vom Stammbronchus nur eine einzige Reihe Seitenäste ausgeht, welche während der fortschreitenden phylogenetischen Entwicklung einen Teil ihrer Nebenäste an den Stammbronchus abgegeben haben, wodurch dieser bei den höchsten Lungenformen in die Lage kommt, in mehr als einer Reihe Äste auszusenden. Noch sollten doch auch bei den Säugetieren diese letzteren Zweige auf den anfangs allein vorhandenen ventralen Seitenbronchien angelegt werden und dadurch ihre ursprüngliche Herkunft dokumentieren.

In the amphibian and reptilian lung the dorsal evaginations appear not only as separate derivatives from the central pulmonary space, but in some reptilian (lacertilian) types, they form ontogenetically as the earliest indications of the increasing complexity of the organ, whereas the larger ventral compartments develop as buds from the pulmonary circumference separately and at a later stage.

Hesser describes (l. c., p. 235) and figures (Taf. 19, Fig. 11) the pulmonary reconstruction of an 8.5 mm. *Tarentola*-embryo, in which this condition is shown admirably in the dorsal view of the left lung. In turtles he finds (l. c., p. 300) the majority of

the primary bronchial derivatives from the moment of their first appearance laid down in a ventral and a dorsal (respectively lateral and medial) row (cf. l. c., Taf. 27, Figs. 23 and 24). He adds that the dorsal as well as the ventral branches arise quite unmistakably as separate primary outgrowths from the stem. He concludes with the statement "Ich glaube nicht, dass die komparative Lungenanatomie für die von Narath ausgesprochene Ansicht eine Stütze bietet."

It is clear that the details of the comparative and ontogenetic evidence call for critical analysis on the basis of the two main assumptions associated in the migratory theory:

1. that the dorsal bronchi are primarily derived from the ventral series;

2. that the eparterial bronchus, when it appears as such, is the most cranial member of the dorsal series, hence, like the rest, primarily a derivative of its corresponding ventral associate.

These two basic propositions suggest the following considerations:

1. By reason of their importance to the migratory theory Narath paid special attention to the main and accessory dorsal bronchi. A summary of the morphological characters which they may present can be schematized in figure 5, in which the dorsal bronchus belonging to a given segment of the stembronchus is indicated as D^X , and the ventral bronchus to which it is genetically related according to the migratory theory as V^Z , while V^Y represents the next cranial ventral bronchus.

1. D^X may arise from the stembronchus opposite to V^Z on the same level with it.

2. D^X may arise at a higher level than its ventral associate V^Z , at any point of the stembronchus in the segment V^Z-V^Y .

3. D^X may ascend to the level of the ventral bronchus next above, V^Y .

4. D^X may advance craniad above this level.

5. The origin of D^X may be depressed further caudad, below the level of V^Z .

6. D^X may arise from the lateral surface of the stembronchus, close to V^Z .

7. D^X may arise from the angle formed by the stembronchus with the origin of V^Z .

8. D^X and V^Z may arise by a short common segment from the stembronchus.

9. D^X may default entirely.

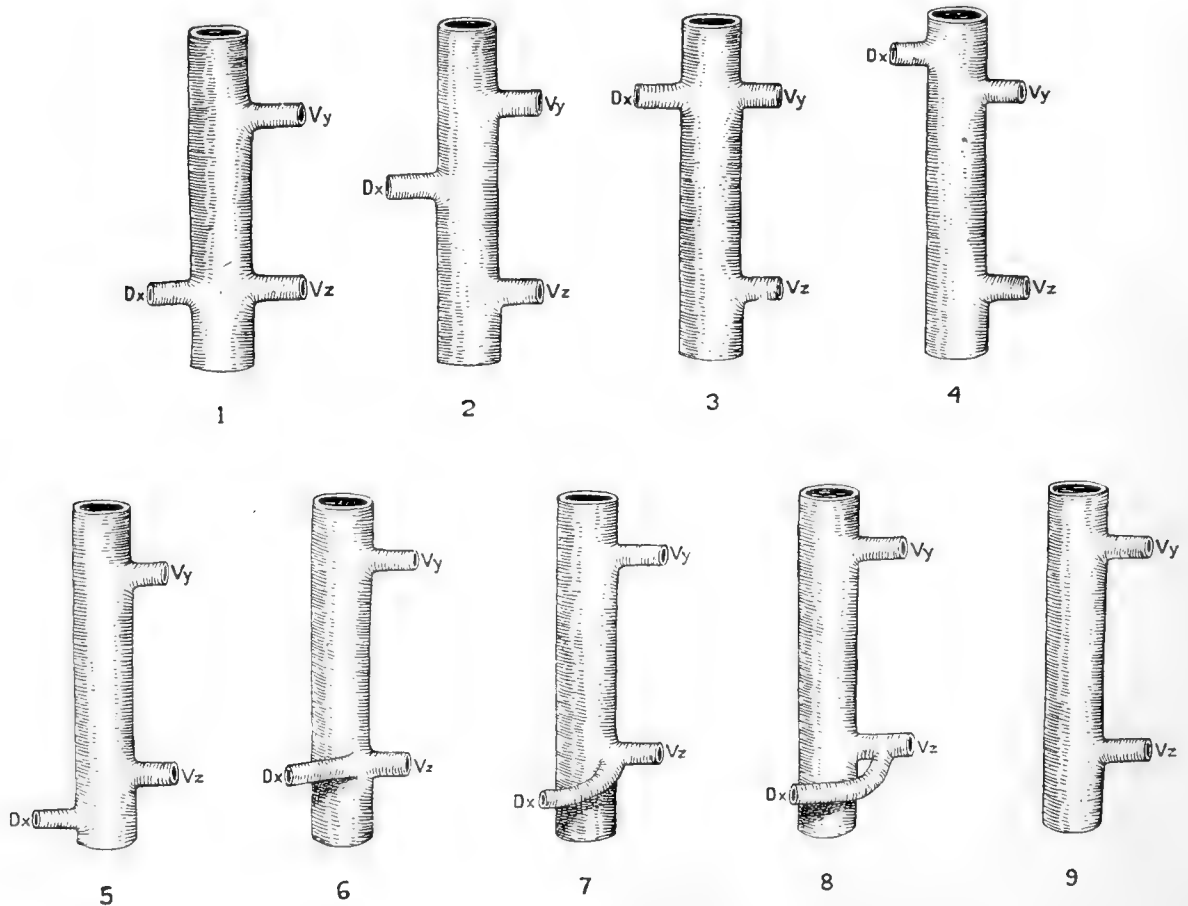

Fig. 5 Schema of variation in origin of the dorsal bronchi in relation to the stem and the ventro-lateral primary branches. $Vy.$, proximal ventro-lateral bronchus; $Vz.$, distal ventro-lateral bronchus; $Dx.$, corresponding dorsal bronchus.

This comprises the substance of Narath's comparative anatomical evidence for regarding the dorsal bronchi as derived phylogenetically from the corresponding ventral bronchi. He lays stress on the fact that they show a general resemblance to certain of the side branches of the ventral bronchi, that they often arrange themselves in series with them, corresponding in size, manner of division and direction, and that they appear so to speak to be "in a way related to them" (33, p. 341).

Cases in which the dorsal bronchus of a district defaults (fig. 5, 9), or arises very near the ventral associate (fig. 5, 7), or where the dorsal and ventral bronchi of a given level have a common origin from the stembronchus (fig. 5, 8), or are joined in the corrosion cast by a sort of ridge, appeal to Narath as very convincing evidence for his theory.

Frankly I fail to see in what respect these facts support his contention. If we regard the conditions shown schematically in figure 5 without prejudice or preconceived theory, they simply demonstrate the fact that the dorsal bronchi are primarily characterized by the extreme variability in their origin and in relation to adjacent elements of the bronchial tree.

In discussing Narath's assumed migration of buds from the ventralanlagen to the stembronchus, to constitute the dorsal series, Hesser (l. c., p. 303) makes the following suggestion:

Vielleicht ist die in Rede stehende Erscheinung nur als eine von der gewöhnlichen Entstehungsweise abweichende Variation aufzufassen. Es erscheint mir nämlich, als ob die dorsalen Bronchien bei den Säugtieren verschiedene Variationen hinsichtlich des Ortes ihrer ersten Entstehung darbieten sollten. In der Regel werden sie auf dem Stammbronchus angelegt, sie können aber auch auf der Grenze zwischen diesem und den ventralen Seitenknospen oder in Ausnahmefällen sogar ganz und gar auf den letzteren erscheinen. Auch in diesem letzten Fall kommen sie doch sekundär auf dem Stammbronchus zu sitzen, vielleicht weil die den beiden Knospen anfangs gemeinsame Mündung in den Stammbronchus hineingezogen wird, wenn dieser während der Entwicklung an Umfang zunimmt.

Hesser concludes this consideration of Narath's development of the migratory theory with the statement (22, p. 305) of his conviction "dass die dorsalen Seitenbronchien ihren Ursprung direkt vom Stammbronchus nehmen."

Flint (21, pp. 119, 120) makes the following comment:

In looking upon the dorsal group as derivatives of the lateral bronchi, Narath has the support of Blisnianskaja, who argues if the 'eparterial' is a dorsolateral bronchus, it is reasonable to suppose the remainder of the series are similarly derived. Neither of these authors, however, have followed the wandering step-by-step either of the eparterial or the dorsal branches on to the stem bronchus. They are, on the contrary, independent derivatives of the stem and, like the lateral series, are to be considered as a group of principal bronchi.

He further states (21, pp. 112, 113):

All of the arguments of Narath and Blisnianskaja concerning the derivation of the ventral, dorsal, and medial series either primarily or secondarily from the lateral bronchi are quite unconvincing, for like the support, which Narath brings from the comparative anatomy, the facts are capable of a simpler explanation, i.e., a wide variation in the position of the buds and the power of one bronchus substituting for another.

The comparative anatomical facts adduced by Narath further demonstrate that the dorsal pulmonary areas may receive their conducting tubes from *any accessible point of the adjacent bronchial tree within their range*. This is the important conclusion, whose significance will be discussed presently. The Migratory Theory suffers from a grave constitutional defect. It has become so imbued with the mechanical aspects of its problem that the naked corrosion cast of the bronchial tree assumes the proportions of a morphological unit, complete in itself and to be judged as such. It is a tree stripped of its finer twigs and leaves, the unfolding of which is the primary physiological purpose of the entire structure. A lung corrosion in which the injection has been carried into the respiratory bronchioles and alveolar spaces corresponds to the tree in full leaf. In both the same degree of unfolding of an equal respiratory surface can be accomplished by grouping the elements of the conducting and supporting skeleton in a variety of mechanical patterns. The tree has the larger range of variability in the number and disposition of the individual leaf buds, but the bronchial system, though reduced in potential excursion by the physical environment, follows absolutely the same morphogenetic plan.

It is at times difficult, especially in the caudal pulmonary areas, to select from among the irregularly disposed dorsal bronchi the proper individual element supposed to belong genetically to a given ventral bronchus. Narath himself recognizes this when he says (33, p. 306), "Die Orientirung wird dann ungemein erschwert und manchesmal ist überhaupt eine sichere Bestimmung des Bronchus unmöglich."

2. In support of the second hypothesis of the Migration Theory, that the eparterial bronchus is really the first dorsal bronchus displaced craniad upon the stembronchus, Narath cites an incomplete corrosion preparation of the right lung of *Echidna hystrix* in which the eparterial trunk arranges itself with the following more caudally placed dorsal branches in a 'handsome row' and resembles them in shape, size and relation to the pulmonary artery, the vessel descending on the lateral surface of the stembronchus between the dorsal and ventral series of bronchi, thus bringing the eparterial or apical bronchus, as D^1 , into the same relation as D^2 , D^3 , D^4 . In evaluating this argument it must be remembered in the first place that the eparterial district of the Monotremes is exceedingly restricted, almost rudimentary. The right upper lobe is hardly more than a short projection craniad from the dorsal pulmonary border, and hence a resemblance between the eparterial and the succeeding dorsal bronchus is of itself suggested by their nearly uniform size and by the restricted area supplied by each. Beyond this resemblance there is absolutely nothing to prove that the element described as the eparterial or apical bronchus is really the transplanted first dorsal. Once granted that pulmonary evolution is not limited to a fixed and immutable number of bronchial units, rearranged in the special types by 'migration,' the bronchus in question is far more likely to be a neomorph, developing in accordance with the beginning cranial extension of the Monotreme lung, and thus acceding to the dorsal series at this stage of its evolutionary unfolding. There is not an atom of morphological evidence in support of the assumed 'migration' of a preexisting element (D^1) to the site now occupied by the new eparterial bronchus. D^1 remains as before, and *Ep.* develops in advance of it.

Echidna is not a good form for the the comparison of the typical mammalian eparterial bronchus with the other components of the bronchial tree, because of the limitations of the cranial pulmonary districts. It can serve as showing the rudimentary character of cranial extension of the lung in the most primitive mammal, but it cannot be used to demonstrate the origin of the bronchus supplying this extension.

Narath (33, p. 333), sums up the morphological characters which the eparterial and dorsal bronchi have in common as follows:

1. Both exhibit a great variety in their point of origin from the stembronchus, and a marked capacity for 'wandering' ('Wanderungsfähigkeit').
2. Both arise at a higher level from the stembronchus than the corresponding ventral bronchi.
3. Both have the faculty of defaulting altogether in certain cases.
4. Both can arrange themselves in a well ordered serial row.
5. Both agree in their relation to the pulmonary artery.
6. Both supply only dorsal pulmonary segments.
7. They may be double or multiple.
8. Accessory bronchi may develop alongside of them from the stembronchus.
9. Occasionally they agree in their form and type of branching.
10. They have the same arterial supply.
11. In the Monotremes their veins are correspondingly arranged.

On the basis of these eleven common characters Narath declares unequivocally that Aeby's eparterial and his apical bronchus is nothing else than the first dorsal derivative of the stembronchus shifted by 'migration' to a new site. The fallacy of this contention is evident. The characters 1, 3, 4, 7, 8, 9 listed above again only speak for variability in origin and accentuate that fact that the dorsal lung segments can receive their bronchial supply from any accessible point on the stembronchus. Whatever regularity of origin exists for the dorsal bronchi in certain corrosion preparations, depends, upon the limitations of this accessible range. No. 2 does not hold good in all cases for the dorsal bronchi below the eparterial even if the designation D^2 is substituted for Aeby's D^1 . No. 6 is disproved for the eparterial bronchial distribution by innumerable instances. No. 10 only pertains in the sense that all portions of the lung receive branches from the pulmonary artery.

Of all the characters cited by Narath the only ones that hold good are No. 5, the pulmonary artery relation, and No. 11, the relation of the monotreme pulmonary veins. Yet Narath himself is most emphatic in denying to the vascular supply of the lung any morphological significance in the interpretation of the bronchial tree. He quite correctly sees in the arrangement of both pulmonary arteries and veins nothing but a close adaptation to the intrapulmonary architecture, the vessels fitting themselves into the interbronchial spaces between the developing buds.

Comparative anatomical evidence in support of the Migration Theory goes by the board altogether.

Let us examine the ontogenetic evidence, with which the last word must rest in any case.

For this Narath turns to one source where definite determination is either extremely difficult or not at all obtainable, viz., the embryo of a mammalian form in which in the adult the right eparterial and first ventral hyparterial bronchi arise in close proximity to each other from the right stembronchus. In many forms included in this type the open interval between these two primary bronchi barely suffices in the adult for the passage of the main trunk of the right pulmonary artery in its ventro-dorsal course across the lateral surface of the stem-bronchus. In these types (and Narath's chief examples, *Echidna* and *Lepus*, belong to this group) the earliest anlagen of the primary bronchi of the right lung appear in the form of slight swellings of the primitive lung-tube, grouped closely together and gradually shading into the adjacent entoderm of the future stembronchus. At this stage there exists as yet no clear differentiation between the stembronchus and its primary derivatives. It is not possible to delimitate accurately the central tube against the faint swellings denoting the first buds of the future bronchi in question and of these anlagen against each other. The attempt to do so results merely in an expression of the observers personal judgment and affords no proof either for or against their confluent or discrete origin, because the bed from which they arise, the future stembronchus, has not yet declared its definite limits. It is held by

Narath that in these forms the right eparterial anlage arises from the cranial slope of the first ventral hyparterial bud and is hence to be regarded ontogenetically as a branch of the same. Even Narath finds himself in difficulties in attempting to substantiate his claim on material of his own selection. His best illustrations fail to convince, because the condition they attempt to portray, viz., the definition of the bronchial anlagen against each other and the future stembronchus, does not as yet obtain.

In the following developmental stages the anlagen are said to 'move apart.' As a matter of fact the stembronchus declares itself and then the individual bronchial buds appear as separate derivatives from the same. This 'moving apart,' or, to speak more correctly, this clearer definition of their relations, cannot in my judgment be utilized as evidence that the right eparterial bud has 'migrated' from the first ventral hyparterial anlage to a new and separate point of origin on the stembronchus. It is on the contrary a demonstration of two separate and individual focal points of entodermal budding which become appreciable only when the epithelial model of the future bronchial system has become sufficiently defined to make the accurate location of the components in their relations to each other and to the stembronchus visually possible. Nor do I believe that we are justified, on the evidence furnished by the early epithelial anlagen of this type of lung, in deciding that two adjacent and apparently in part confluent buds, which later, with the clear definition of the stembronchus, appear as two separate branches of the same, have rehearsed a greatly foreshortened chapter in their phylogeny, in which one of them has 'migrated' or 'shifted' bodily to a new site. All that the very earliest stages show in embryos of this mammalian type is a common extremely plastic entodermal tube in the process of peripheral budding. This budding follows a genetic type which is still seen in the embryos of some extant reptiles (lacertilia, chelonia). The individual circumferentially disposed evaginations tend to arrange themselves into metameric series.

Hesser (22, p. 236), after describing the pouch-like evagination of the cranial pole of the primitive lung-sac in the 8.5 mm.

embryo of *Tarentola*, gives the following account of the development in the remainder of the lung:

Die übrigen kleineren Blasen, welche die ganze übrige Fläche des primitiven Lungensackes bekleiden, sind auch nicht regellos umhergestreut. Sie sitzen nämlich in transversalen Reihen, welche rings um den Lungensack laufen, und machen so den Eindruck von einer Art Segmentierung desselben (Figg. 10 und 11, v. tr.). Die Segmentierung ist in der mittleren Partie der Lunge am deutlichsten ausgeprägt. Die transversalen Reihen alternieren im grossen und ganzen mit den grossen dorsalen Blasen, so dass eine solche Reihe dem Zwischenraum zwischen zwei Blasen entspricht. Indes ist diese Alternation nicht besonders deutlich. Viele der Blasen zeigen eine Tendenz zur Teilung in zwei kleinere, gleich oder ungleich grosse Tochterblasen.

In the attainment of the mammalian type the number of these successive rows is greatly reduced, and the interval between adjacent rows correspondingly increased, in conformity with the laws governing peripheral alveolar expansion. At the same time the number of the individual buds composing a row becomes likewise greatly diminished. This is especially evident in the cranial lung segments as compared with those occupying a more caudal level. Primary as well as accessory buds of any row, which later become defined as the ventral, dorsal, and accessory bronchi of their pulmonary segment, cannot be definitely analyzed in their relation to the stembronchus until the latter has itself become clearly defined. The central common lung-tube or pulmonary cavum cannot be considered as the strict equivalent of the formed stembronchus until the primary buds have clearly differentiated themselves and declared their value and their relations to each other and to the line of the stembronchus. The firstanlagen of the stembronchus and of its primordial derivatives are parts of a continuous and uniform whole, as the entire anure lung is in its adult form. When they can once be accurately delimited they do not further change their mutual relations by 'migration.'

Narath (33, p. 281) sums up his conclusions regarding the development of dorsal bronchi in rabbit embryos as follows:

Ich widmete also der Bildung der dorsalen Bronchien ganz besondere Aufmerksamkeit. Leider stösst die Untersuchung auf grosse Schwier-

igkeiten. Wenn die Knospen sehr deutlich sichtbar sind, dann haben sie in der grossen Mehrzahl der Fälle keinen Zusammenhang mit der beim Kaninchen tiefer sitzenden zugehörigen Ventralbronchusanlage. Nur manchmal kann man unter der Lupe oder dem Mikroskope durch Drehungen der Schraube einen deutlichen Zusammenhang der Contourlinien erkennen. Man muss auf noch jüngere Stadien zurückgehen, wo die allererste, ganz minimalste Vorwölbung der Epithelwandung zu constatiren ist und darin liegt die Schwierigkeit der ganzen Untersuchung. Ganz ergebnislos war jedoch die Arbeit nicht. Bei aufgehellten Lungen konnte ich einige Male die allererste Andeutung der Dorsalknospenbildung erkennen. . . . Die Anlage der Dorsalknospe sitzt zu einem guten Theile auf der hinteren und oberen Abdachung der Ventralknospenerhebung.

Hesser (22, p. 301) comments on this passage in these words:

Indes ist zu bemerken, dass eine derartige Erscheinung äusserst selten zu sein scheint. In den meisten Fällen sieht man keinen Zusammenhang zwischen der Dorsalknospe und der entsprechenden ventralen Bronchusanlage, eine Thatsache, wovon Narath durch die Erklärung abzukommen sucht, dass die untersuchten Stadien nicht früh genug gewesen sind. Übrigens scheint Narath selbst seiner Sache nicht so gewiss zu sein, denn er sagt an einer Stelle, "dass er sich viele Mühe gegeben" den Ursprung der dorsalen Bronchien zu entdecken, "ohne einheitliche Befunde zu erreichen."

Mammalian pulmonary development consists in progressive centrifugal epithelial sprouting from a series of definite focal points of the primitive lung sac. An epithelial bud, once formed, continues to extend peripherally. It gives rise to lateral daughter-buds, which carry on the same type of development, but never leave the parent stem, never divide by 'splitting off' and never shift to a new location.

Neither phylogeny nor ontogeny sustain the dogma of the Migration Theory. They fail to prove that the dorsal bronchi are primarily branches of the corresponding ventral bronchi which subsequently abandon their early origin and become transplanted on the stembronchus. They fail especially in proving that the right eparterial bronchus is the cranial member of the dorsal series and that as such it is originally a branch of the first ventral hyparterial bronchus. Narath himself unconsciously expresses this when he writes (33, p. 313) as follows, in connection with the supposed derivation of the cardiac from the first ventral hyparterial bronchus:

Die Untersuchung der allerersten Anlage vom infracardialen Bronchus ist äusserst schwierig, es handelt sich ja wie bei allen Bronchusanlagen um ganz minimale Vorbauchungen, die mit unseren Hilfsmitteln schwer oder gar nicht zu erkennen sind. Was wir sehen, ist bereits ein älteres Stadium, man müsste noch weiter zurückgehen in der Entwicklung und würde dann auf einen bestimmten Zellkomplex kommen, aus dem der Bronchus hervorgeht. Der Zellgruppe können wir es jedoch nicht ansehen, dass sie den Bronchuskeim in sich trägt. Ich dachte eine Zeitlang, dass man vielleicht durch eine stärkere Anhäufung von Kerntheilungsfiguren einen Anhaltspunkt dafür gewinnen könne, um zu entscheiden, von wo eigentlich die Knospenbildung ausgeht. Die Untersuchungen liessen jedoch vollständig im Stich.

The above passage, which on account of its significance I have quoted in full, really tells the entire story and emphasizes the way in which a preconceived idea, tenaciously retained, can produce, even in an able observer, a mental attitude approaching mysticism. For if a morphogenetic theory depends altogether on basic differentiations assumed to occur in such early ontogenetic stages that they cannot be seen or recorded, the deductions must rest entirely on faith and not on scientific evidence. This is carrying theoretical promorphology beyond its justifiable limits.

Narath's monograph contains a mine of invaluable comparative anatomical observations, with beautiful illustrations, based on preparations showing the utmost technical skill, and the statistical information is prepared and compiled most carefully. From a scientific standpoint the work suffers from only two drawbacks: the author's desire to demolish Aeby's results, even in the minor details which have no real bearing on the problem, and his equally strong desire to establish his view of the 'apical' bronchi and the principle of 'migration' in the architecture of the mammalian bronchial tree. One would like to believe that the gross mechanical concepts underlying this theory were employed solely as figures of speech, for the purpose of visualizing comparative relations, were they not unmistakably intended to be taken literally, elaborated with infinite and repeated precision of detail in nearly every part of the work, and were it not for the attempt to prove their actuality by ontogenetic evidence.

The fallacy of these arguments is, however, demonstrated absolutely as soon as the inquiry is transferred to more conclusive mammalian forms than those selected by Narath. If, in place of the prevalent mammalian tree, with close approximation of the right eparterial and first ventral hyparterial buds, we examine the same bronchial districts in embryos of a type in which the right eparterial component is a derivative from the trachea, all possible doubts as to the correct genetic interpretation of the facts disappear at once. Here the eparterial and the first ventral hyparterial bronchi are separate and distinct anlagen from the very first appearance of the epithelial swellings foreshadowing their development, the former budding from the right side of the trachea, the latter from the right stembronchus.

There can never be, at any stage, any question whatsoever of a 'splitting off' of the eparterial element from the first ventral anlage, or of its 'wandering' cranially onto the trachea. The facts render such a supposition nothing less than absurd and speak clearly for the correct interpretation. Narath himself recognizes the deplorable weakness of his position in face of the actual embryological findings. He devotes in his work of 380 pages only 15 lines to this aspect of the subject. He says (p. 333): "Einige Schwierigkeiten verursacht die Erklärung des Entstehens der trachealen Bronchien. Die Entwicklungsgeschichte lehrt, dass beim Schaf die Knospenvorwölbung sehr frühzeitig an der rechten Seite der Trachea selber entsteht. Man konnte *bis jetzt*² ein Uebergehen der Knospe vom Lungensäckchen auf die Trachea nicht constatiren." This statement is absolutely true, but the author might with equal assurance have added that such a phenomenon never will be observed. He goes on to say: "Es verliert dieser eigenthümliche Entwicklungsgang jedoch seine Sonderstellung, wenn man daran festhält, dass Trachea und Lunge einheitliche Bildungen sind, die ursprünglich ohne Grenzen in einander übergehen." Narath, perhaps unconsciously, expresses here a far reaching truth, but evidently without grasping its real significance for the interpretation of bronchial evolution in the mammalia, for he proceeds immediately to qualify

² Italics mine.

the statement in accordance with the migratory theory as follows: "Die Keimzellengruppe der Apicalknospe kann bei frühzeitigem Wachsthum ins Gebiet der Trachea gedrängt werden zu einer Zeit, wo sich die Lungenanlage schärfer abgesondert hat von der Trachealanlage." These words convey no morphogenetically conceivable idea. There exists no developmental agency capable of 'pushing' a group of proliferating cells out of contact with the epithelial layer, as a part of which they develop, and transferring them from a point on the future stembronchus to a point on the future trachea, where they are to be invaginated between the already existing cells of that locality to function as the anlage of the tracheal eparterial bronchus. This is a migratory *reductio ad absurdum*. After all a developing bronchial bud is not to be regarded in the same light as a metastatic deposit from a neoplasm. To read Narath further, "Wenn uns auch die Ontogenese keine Aufschlüsse gibt für das 'Hinaufwandern' des apicalen Bronchus, so muss dieselbe doch nach den zahlreichen vergleichend anatomischen Thatsachen unzweifelhaft in der Phylognese stattgefunden haben."

We have above carefully considered the 'numerous comparative anatomical facts' (p. 141). Comparative anatomy if correctly interpreted absolutely negatives the migratory theory and teaches that a branch budding from any point of the bronchial tree develops at the site of its first inception.

Narath concludes his brief ontogenetic consideration of this vital question with the rather naive statement: "Es scheinen mir Thiere mit hoch auf der Trachea sitzenden apicalen Bronchien wie Schaf, Rind, Schwein für das Studium nicht recht geeignet zu sein." They certainly are not 'suitable for this study' if it is intended to use them in support of the vagaries of the migratory theory.

The cranial lobe of the typical right artiodactyl lung far exceeds the corresponding element of the opposite organ, extending across the median line and actually in many species fitting over the apex of the left lung. The peripheral respiratory area resulting from the unfolding of a terminal bronchiole is practically a constant value in each mammalian form. Increase in the

respiratory surface spells a corresponding increase in the number of the terminal bronchioles. It is a simple mathematical proposition to prove that the number of the ultimate bronchioles and the consequent area of the respiratory surface will depend, with the same type and ratio of division of the bronchial tree, upon their caliber and upon the distances separating the origins of the primary conducting tubes from the stembronchus.

Thus in the case of the right eparterial bronchus (A) the extent of its respiratory area is in direct ratio to the distance X-Y separating it from the next adjacent derivative (B) of the stembron-

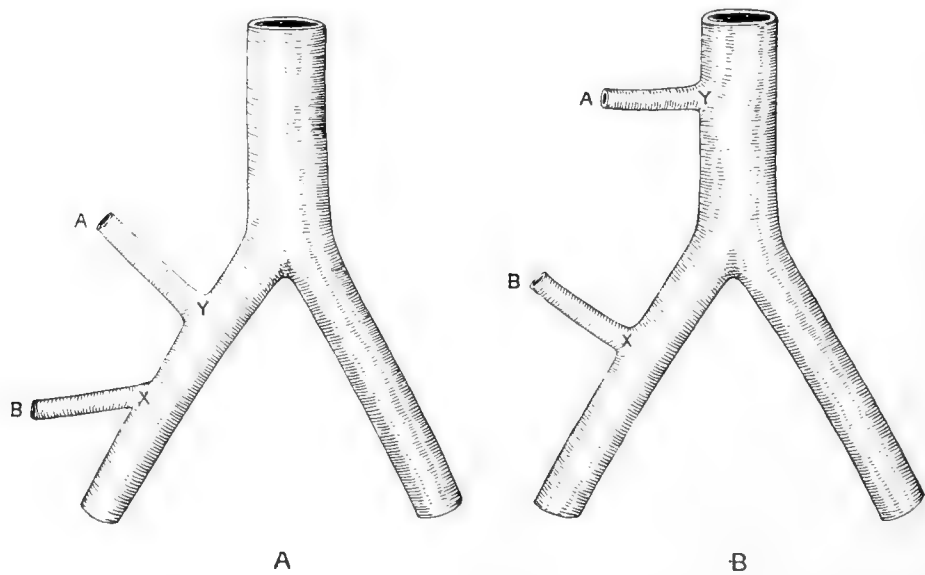

Fig. 6 Schema of bronchial and tracheal derivation of right eparterial bronchus. A., eparterial bronchus; B., first ventral hyparterial bronchus.

chus, the first ventral hyparterial branch. In comparing the dominant type (fig. 6^A) with that obtaining in the artiodactyls (fig. 6^B), the enlarged respiratory capacity of the latter is measured by the greater length of the line X-Y.

The phyletic as well as the ontogenetic interpretation of the migratory theory would hold that the tracheal eparterial bronchus in the ancestors of the modern artiodactyls was a branch of the first ventral bronchus, which in the course of evolution 'emigrated' from this primitive site craniad, first onto the stembronchus, and then still further in the same direction beyond the bifurcation a variable distance up along the right side of the trachea.

In all these wanderings the bronchus retained its own individual character, always representing the same Odysseus-like phyletic element of the ancestral bronchial tree. No matter into what foreign territory the voyage leads, the germinal cellgroup always carries with it the invisible mystic impulse to develop into a specific bronchus. On the other hand it is evident that the actual facts are adequately and completely met by simply recognizing that space disposition within the thorax permitted and increased respiratory requirements demanded, in the evolution of the Prongulate type, the *selection* of a more cranially located point on the primitive entodermal pulmonary tube for the origin of the respiratory bud corresponding to the bronchial eparterial area of the dominant mammalian type, even if this origin is thus made to fall within the tracheal segment. Embryonal mutations probably played a deciding rôle in the evolutionary process involved.

I believe there can be no question as to which of these two hypotheses is the more tenable and conforms more clearly to the facts.

Flint (21, p. 35) who has furnished us with a most careful and detailed developmental history of the lung in a form (pig) with right eparterial tracheal bronchus (his *L. 1*) says:

If we turn for a moment to the consideration of the origin of *L. 1*, we find the bronchus is a trifle more precocious, but practically simultaneous with the second lateral branch (our V^1) in its origin. It is separated from Lateral 2 by a considerable distance. If the views of Willach and Narath were correct, this branch should not appear until later, and should be traceable, step by step, from the bud forming right Lateral 2 to its final position on the trachea. Its direction is practically lateralwards with a scarcely visible tendency to point ventralwards. It would not then, from the topography of its origin, bear any analogy to a dorsal bronchus. From this distinctly lateral position of its origin, I have classed it among the lateral group of bronchi, although, in its subsequent growth, one of its branches extends down into the dorsal region giving the bronchus a certain superficial resemblance to that series. On the other hand, the lower lateral elements grow ventralwards in the later embryonic stages and thus also lose their early strictly lateral character. This much is certain; if *L. 1* arises phylogenetically from the dorsal group, a view for which there is no convincing proof, absolutely all trace of the migration is lost in

the pig. It originates like one of the lateral bronchi and subsequently develops its superficial resemblance to the dorsal elements. Whatever support for the relationship of the bronchus to the dorsal series, can be drawn from this fact, is multiplied by the behavior of a lateral branch of left *L. 2*, which does exactly the same thing in an adaptative process on the part of the bronchus to a relatively unobstructed environment.

With the artiodactyls and the kindred bronchial types the Migration Theory definitely collapses and the field is cleared phylogenetically and ontogenetically of the speculations which might be founded on a misinterpretation of less clear-cut conditions presented by other mammalian types.

III. SELECTION THEORY

The concluding section of this paper presents the viewpoint which has impressed itself upon me during these studies. If I dignify these deductions by the formal designation of a theory this is done solely with the purpose of establishing more sharply the contrast between them and the views considered in the preceding pages. Actually they do not constitute a theory so much as an attempt to collect, coordinate and interpret as far as possible all the facts accessible to me bearing upon the problem of the phyletic history of the Mammalian Lung. At the outset we are confronted by two questions, upon the answer to which depends the entire interpretation of the mammalian bronchial system and of the correlated organization of the lung.

Does a careful consideration of all the established facts now in our possession warrant us in continuing to maintain the hypothesis of a single monophyletic primitive ground plan of mammalian bronchial architecture and to derive all extant types from the same by successive modifications? Or are we on the contrary dealing with the results of adaptation of the primitive vertebrate lung to conditions which have varied widely in different mammalian prototypes according to thoracic structure and space disposition in the cranial portion of the body cavity, activity of respiratory exchange, mode of locomotion, general environment, and many other determining factors which have resulted in the

transmission by inheritance of the varying extant bronchial patterns? I believe that at the close of our consideration of this problem we will stand squarely on the basis of the last named hypothesis.

In compiling and interpreting the facts which have determined this conclusion it is necessary to preface the same with an outline of the phylogenetic and ontogenetic evolution of the mammalian lung. The respiratory apparatus of all pulmonate vertebrates consists essentially of a longer or shorter air-conducting tube derived from the ventral wall of the foregut and constituting the primitive pulmonary anlage. Its internal surface is lined throughout by an epithelium continuous with the entoderm of the intestinal canal from which it is derived. Its ectal surface is surrounded by the splanchnopleural mesoderm of the pulmonary blastema, carrying the vessels of the organ. The distal end of this tube, differentiating in its ontogeny from the fore-gut in a caudo-cranial direction, divides into bilateral canals, the primitive lung-tubes of the right and left sides, upon whose surface the afferent and efferent pulmonary vessels ramify in a sub-epithelial capillary network, while the cranial portion of the canal remains undivided and forms the trachea, retaining a point of primitive connection with the foregut, the laryngeo-pharyngeal orifice. The primitive lung-tube, extending caudad on each side from the tracheal bifurcation, subsequently differentiates into two components, the *lung-sac proper* and the *extrapulmonary bronchus* (fig. 7^A). The former expands and becomes demarked from the bronchus by its increased lumen. The ental surface is covered by respiratory epithelium. The bronchus retains its uniform caliber and, both in the character of its lining epithelium and in the accessory differentiations of its enveloping mesoderm, conforms to the structure of the trachea. The smooth walled primitive lung proper forms the direct caudal continuation of the extrapulmonary bronchus, as seen in the Urodele lung (*Necturus*), and in the early ontogenetic stages of the mammalian organ. The hilus affording entrance to the bronchus, accompanied by the pulmonary vessels, occupies its cranial pole. The entire pulmonary apparatus thus divides into a *conductory* and a *respiratory* component.

In the subsequent stages increase in the extent of the respiratory epithelial area is obtained by: A. Structural modifications

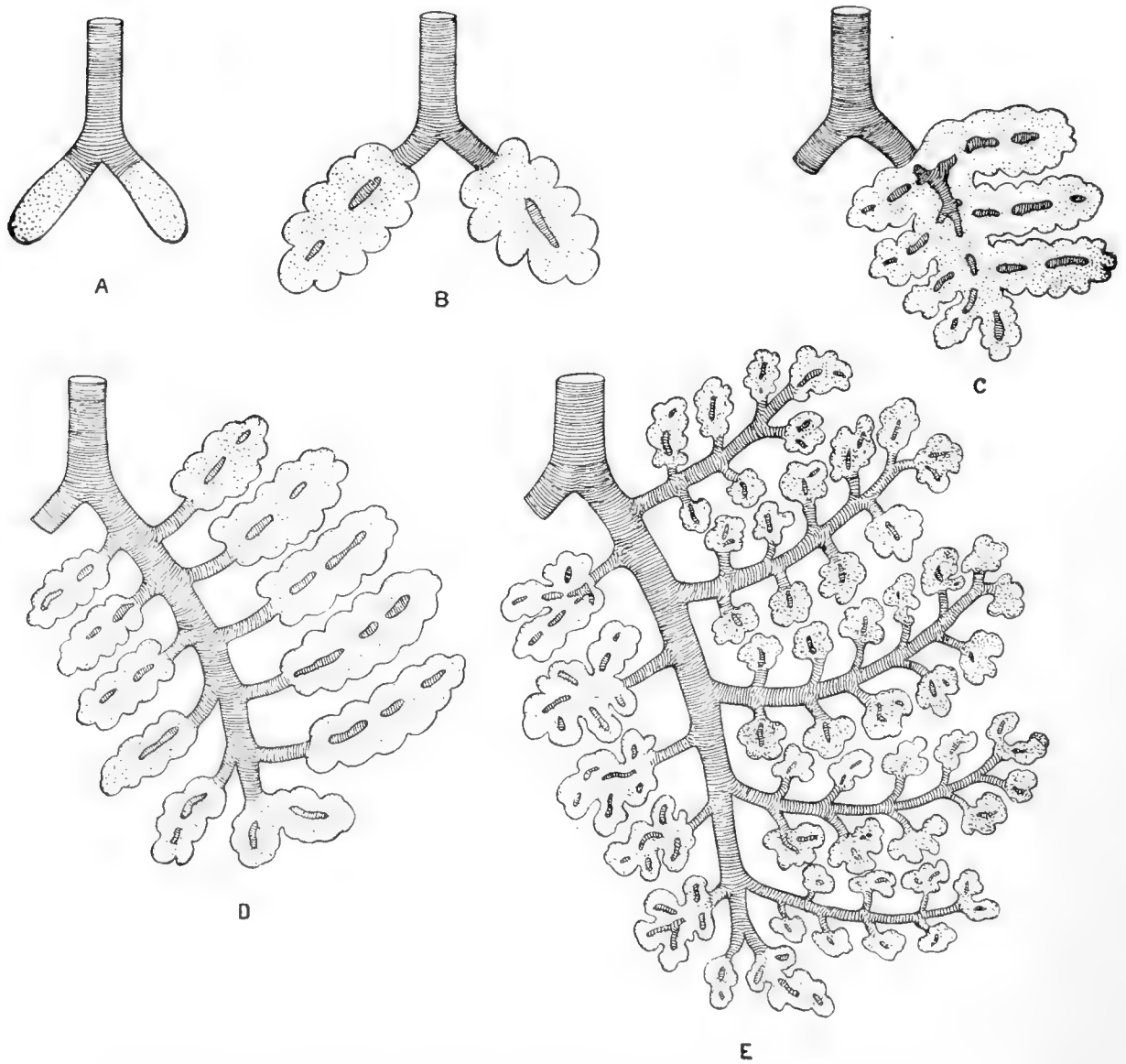

Fig. 7 Schema of phyletic evolution of the vertebrate lung. Conductory paths cross-hatched; respiratory areas stippled.

of the primitive lung-sacs. B. Structural modifications of the primitive extrapulmonary conducting canals of the trachea and bronchi.

A. Structural modifications of the primitive lung-sacs

The further development of the primitive smooth walled lung-tube depends upon two subsequent changes:

I. With the extension of the lung-sac its circumference develops points of increased epithelial proliferation. These areas of heightened mitotic activity protrude as hollow epithelial buds, whose lumina are in open communication with the central cavity of the lung-sac. The latter thus becomes studded with closely aggregated pulmonary vesicles or crypts (fig. 7^B).

The lung of the Anure amphibian (*Rana*) furnishes a good example of this phyletic stage.

As the surface area of the lung-sac increases the previous uniform budding of the pulmonary vesicles is replaced by a smaller number of localized areas of more intensive proliferation, which develop into sac-like protrusions. By continued centrifugal budding from their walls these repeat in every detail the structure of the primitive vesiculated lung-sac, and initiate the subdivision of the original wide pulmonary cavum into a number of chambers (fig. 7^C). The walls of the adjacent compartments come into contact by their mesodermal investment and fuse. The lung now is seen on section to be divided into a series of pockets by septa, apparently arising from the surface and directed toward the center of the original pulmonary cavum, into whose axial remnant the individual pockets open by wide mouths. The fused walls of the original centrifugally developed outgrowths from the primitive lung-sac carry the mesodermal blood vessels in the resulting septa. The multiple components of this advancing lung have, like the antecedent primitive lung-sac from which they arose, the capacity to initiate from their entodermal lining epithelial buds, each one of which is equivalent to one of the original points of proliferation from the primary lung-sac responsible for the production of the entire generation of the secondary sacs. The lung now contains a central tubular space, the reduced pulmonary cavum of the primitive lung-sac, which leads by a number of passages ventrad and dorsad into a corresponding number of secondary chambers, each a replica of the entire prim-

itive lung of the earlier stage. The entoderm is still throughout respiratory in character (fig. 7^C).

Any of the more simply constructed lungs of the Lacertilia and paludal Chelonia illustrates this phylogenetic stage in the evolution of the mammalian lung. The same stage is represented in the ontogeny of the mammal, due allowance being made for the smaller number of the secondary chambers and the increased intervals between their points of connection with the axial lumen, characters which foreshadow the future architectural plan of the mammalian lung.

Continued extension of this evolutionary process leads in the well known way to the gradual production of a racemose organ, in which each ultimate component is the morphological equivalent of the single ancestral primitive lung-sac. Types are furnished to the phyletic series by the lungs of the soft-shelled chelonians (*Aspidonectes*, *Eretmochelys*, *Sphargis*).

II. With this increase in the complexity of the lung the next phyletic advance is marked by a structural modification along definite lines both of the intrapulmonary epithelium and the related mesoderm, repeating at a number of points the earlier differentiations of these tissues through which the primitive entodermal lung-tube became divided into the extra-pulmonary bronchus and the primary lung-sac. First along the axial line of the central pulmonary cavum (fig. 7^B), subsequently in the same way along the axial lines of the series of separate chambers opening into it (fig. 7^C), the respiratory epithelium assumes the character of a conducting epithelium while the subjacent mesoderm differentiates into the supporting structures of a bronchus. These histogenetic changes begin at a number of separate points. The individual anlagen then becomes joined to form a tubular conducting system which connects with the extra-pulmonary bronchus. The lung has thus become invaded by an intrapulmonary system of bronchial tubes, opening into an axial canal, the *stembronchus*, which in turn is now continuous with the extra-pulmonary bronchus and meets the corresponding structure of the opposite site at the bifurcation of the trachea (figs. 7^D, 7^E). The lungs of certain marine turtles (*Chelonia*

mydas) illustrate the initial stage, those of *Thalassochelys* and *Dermochelys* the completion of the evolutionary process in the invasion of the lung by the stembronchus.

A lung which has attained this stage of advancement represents in its entirety that portion of the more highly developed mammalian organ which we can regard as the archeal fundament of the whole, the 'lung-stem' of Aeby, commonly defined as the 'lower lobe,' supplied through the primitive stembronchus with main ventral and dorsal derivatives. All further additions to the primitive lung-stem are acquired secondarily, as the structural expressions of heightened respiratory demands in the more complex mammalian types.

Before taking up this second chapter in mammalian pulmonary differentiation and extension it is desirable to clear the ground for the same by considering some of the details of the intrinsic structure of the lung-stem and their bearing on further evolutionary progress. For the purposes of the present inquiry we need only dwell on certain main ontogenetic and phylogenetic facts.

1. The distinction between the conducting and the respiratory components of the lung, marked as this becomes in the proximal segments of the higher lung, is not definite and absolute in the peripheral portions. Their meeting point in the adult lung lies within the intermediate area of the respiratory bronchus, effecting a gradual transition between the conducting tube and the alveolus. Ontogenetically the identical derivation of both structures from a common primitive anlage enables them to become mutually interchangeable up to a certain stage of differentiation, as shown by the genetic intrapulmonary cycle of the Monotremes and Marsupials (cf. p. 192). Phylogenetically the same initial indefinite demarcation of the two components is encountered, as in the tracheal lung of the colubrine Amblycephalidae, in the eparterial bronchi of the cetacean and artiodactyl lung derived from the trachea, and in many bronchial variants.

2. This interchangeability of conducting and respiratory components is based upon the primary fundamental inherent capacity of the entire entodermal respiratory tract to inaugurate bronchial

buds from any point of its surface and to develop its intrinsic pulmonary organization in accordance therewith. The resulting extensions of the primitive respiratory area are reflected in the corresponding modeling of the conducting system and give rise to the specific form of the bronchial tree pertaining to the type. Including thus within the limits of its anlage the common basic materials for the differentiation of both of its structural components, the lung is in a position to meet all the evolutionary demands put upon it by the environment and the purpose it serves in the organism.

3. Compared with the early phylogenetic stages of the vertebrate organ (fig. 7^A), in which the entire available surface of the primitive lung-sac is respiratory and supplied by the extrapulmonary bronchus, the evolution of the mammalian lung demands, in accordance with its ultimate design, extent and structure, the *selection* of a limited number of points of intensive epithelial budding in place of the preceding general use of the entire potential surface. This selection is directed and regulated by the extent and location of the total peripheral respiratory area which will ultimately represent the culmination of the development derived from each of these points. This in turn is governed directly by the amount and location of the intracoelomic space available for pulmonary extension and its topographical relations.

The grouping of these *selected* areas of epithelial proliferation, and the *pattern* which they produce in their relation to each other and to the stembronchus, will determine the *type* of the bronchial tree characteristic for each form. Within this form the bronchial type is transmitted by heredity.

After the primitive lung-sac has been invaded by the conductory system, and the resulting intrapulmonary bronchus has replaced the antecedent central cavum pulmonale, the active epithelial budding is transferred to the lining of the secondary lung-sacs each of which is now connected by its own short afferent canal with the axial stembronchus (fig. 7^D). The latter is thus provided with the anlages of its main derivatives, the ventral and dorsal primary bronchi. These act in turn as stembronchi for the individual secondary lung-sacs, repeating there the gen-

etic process which originally led to the establishment of the main primary intrapulmonary stembronchus (fig. 7^E). Like the latter they develop the series of secondary lateral derivatives, each terminating in a tertiary lung-sac, which is the exact morphological replica of the primary lung-sac on a smaller scale, and forms the anlage for the continuation of the process of pulmonary unfolding, on the original developmental plan.

The primitive framework of the future bronchial tree has now been laid down. The actual details of its organization in any form will depend upon the number and position of the secondary lung-sacs budding from the primitive cavum pulmonale and of the primary bronchi based on them. The further the development of each of these is carried toward the periphery, and the smaller the number of the resulting ultimate respiratory areas becomes, the longer will be the unoccupied intervals of the stembronchus between the origins of the primary bronchi and the greater their initial caliber.

In two lungs of equal volume and efficiency the stembronchus of one may carry a smaller number of larger derivatives, while the other will show a larger number of primary side branches, each supplying a smaller peripheral respiratory area. Thus the two lungs shown in schemata (fig. 8, A and B) belong to the same bronchial type, (A) having six ventral and eight dorsal side branches, reduced in (B) to three and four respectively.

This numerical range of the bronchial organization prevails in the mammalian lung stem proper (lower lobe), which in general is characterized by the marked similarity in the arrangement of its lateral derivatives from the stembronchus, although their number varies considerably in the different genera and orders (from three to eight or even nine of the ventral branches).

Typical examples of (A) are seen in the bronchial trees of the lungstem in the Bradipodidae [*Choloepus*] and in *Hyrax*, of (B) in that of the carnivores and lower primates.

Based on the preceding conditions the following facts may be emphasized:

1. The entoderm of the intrapulmonary bronchus retains the inherent potency, derived from its phylogenetic and ontogenetic

predecessor, the primitive entodermal lung-tube, of developing lateral buds from any point of its circumference.

2. In the mammal these points of epithelial sprouting tend to arrange themselves mainly in a ventro-lateral and a dorsal

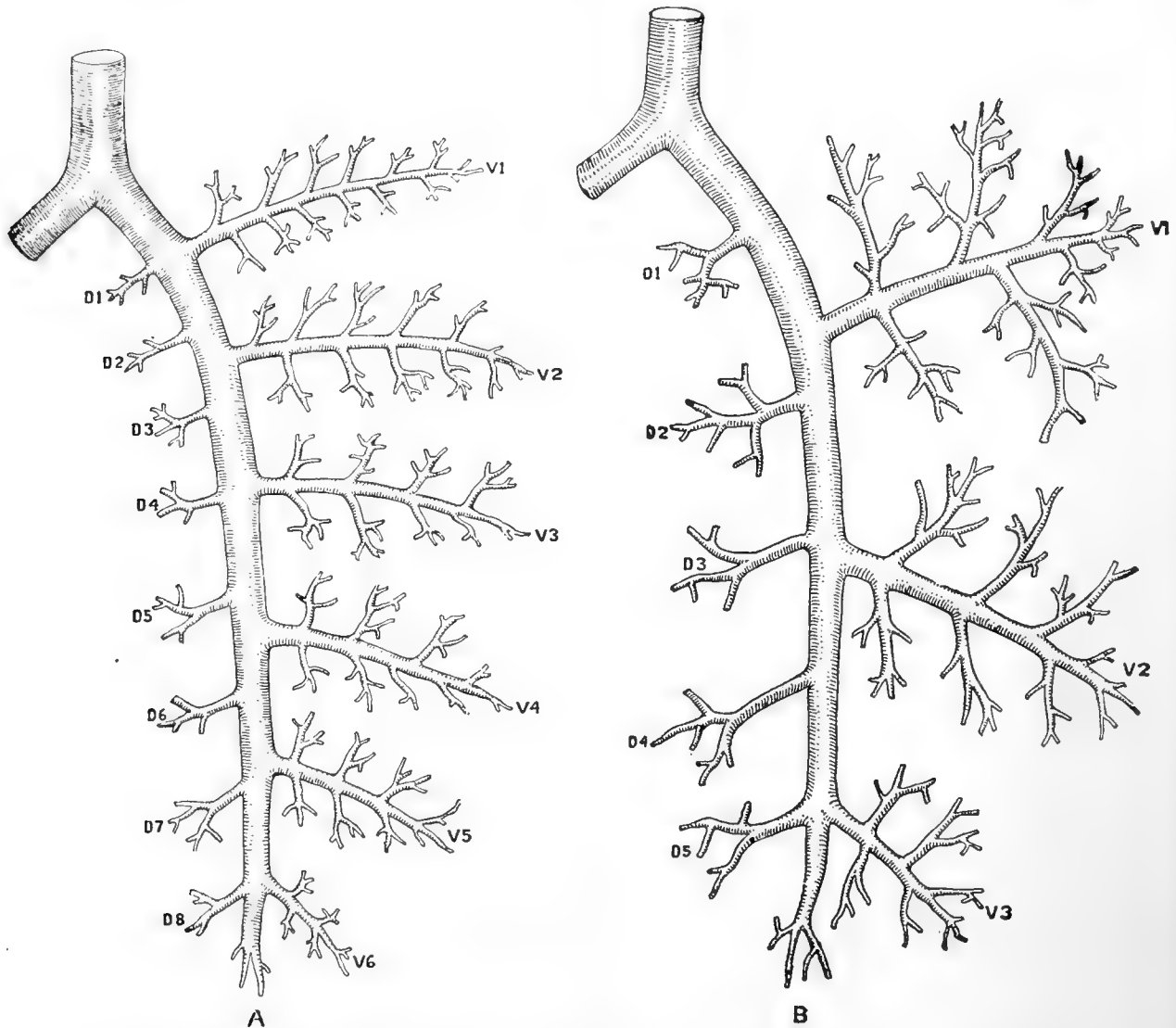

Fig. 8 Schema showing numerical variation in the primary derivatives of the stembronchus and its results in the resulting peripheral areas of distribution.

longitudinal row. The former are the larger and expand further toward the periphery, the latter are smaller and less extensively developed. They constitute the ventral and dorsal primary branches of the stembronchus, and form with it the foundation of the bronchial tree. Hence the stembronchus acquires a dorso-

medial excentric position in reference to the axis of the entire organ.

3. They differ in number and in the details of their peripheral extension in the lungs of different mammalian groups, but are of fairly constant arrangement in individuals belonging to the same species.

4. By virtue of its universal capacity for the development of bronchial buds the stembronchus may produce smaller and less regular proliferations in addition to the two principal rows of the primary dorsal and ventro-lateral bronchi, in the intervals between them.

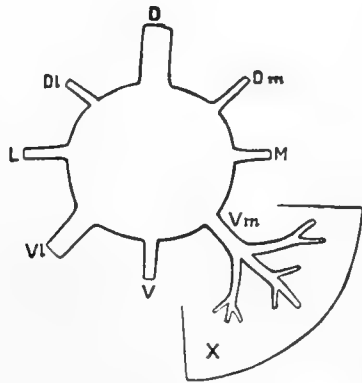

Fig. 9 Schema of derivatives from mammalian stembronchus. *V.*, ventral bronchi; *Vl.*, ventro-lateral bronchi; *L.*, lateral bronchi; *Dl.*, dorso-lateral bronchi; *D.*, dorsal; *Dm.*, dorso-medial; *M.*, medial; *Vm.*, ventro-medial.

For descriptive purposes the derivatives from the axial canal may therefore be designated as, *Dorsal*, dorso-medial, medial, ventro-medial, ventral, *Ventro-lateral*, lateral, dorso-lateral. Of these the representatives of the dorsal and ventro-lateral groups are selected for the development of the primary principal branches of the bronchial tree. To respect Aeby's priority and for the sake of brevity we use the term 'ventral' to designate the members of the ventro-lateral group (fig. 9).

The circumference of the stembronchus thus becomes divided into two unequal sectors, a shorter lateral and longer medial, between the rows of the main dorsal and ventro-lateral derivatives. The former contains two secondary points for bronchial proliferation, the lateral and dorso-lateral, while on the longer

medial stretch there are four of these points, viz., the ventral, ventro-medial, medial and dorso-medial.

One or more of these secondary points may give origin to *secondary* or *accessory bronchi* or they may default.

In the first case, depending upon the number and location of the points utilized, the stembronchus will be studded more or less profusely in the intervals between the lines of its principal ventro-lateral and dorsal bronchi with smaller secondary *accessory bronchi*. In the second case these portions of the stembronchus are naked. Conditions in this respect vary at different horizontal levels. In general accessory bronchi become more numerous in proceeding cranio-caudad along the stembronchus. This accords with the more archeal type of bronchial distribution in the caudal reaches of the lungstem. They preponderate numerically in the medial as compared with the lateral sector of the circumference of the stembronchus, the former presenting a greater arc, and hence more points for their development than the latter, in the proportion of 4:2. The development of lateral and dorso-lateral accessory bronchi is further restricted by the course of the main pulmonary artery which for the greater part of its extent lies typically against the dorso-lateral surface of the stembronchus, between the rows of the main ventro-lateral and the dorsal primary bronchi. The budding of the epithelium leading to the development of the accessory bronchi is not limited to the mathematical point of the compass indicated by their designation. Thus a member of the dorso-medial group may develop anywhere between the lines D and M, a ventro-medial accessory bronchus anywhere between M and V, etc. If it occupies the latter point it may form either one of the rarer accessory bronchi passing directly ventrad, or a ventrally located bud more commonly swings mesad in attaining its distribution and supplies a typical ventro-medial pulmonary district. Still further the main primary dorsal and ventral bronchi represent, as above stated, the stembronchi for the secondary lung-sacs, forming their axial conducting structure. Like their prototype, the main stembronchus, they retain the same potency for proliferation from any point of their circumference. Thus a given ventro-medial

district may derive its bronchial supply from the following sources:

1. Typical ventro-medial accessory bronchus.
2. Accessory bronchus arising further ventrad or dorsad.
3. Ventral accessory bronchus.
4. Accessory bronchus arising from the angle between the stembronchus and one of its primary ventro-lateral branches.
5. From the proximal portion of the latter itself.

This does not imply that the accessory bronchus has 'migrated' or 'wandered' from the point of its inception, the ventro-lateral primary bronchus, first to the angle between it and the stembronchus and then to the stembronchus itself, but that the ventro-medial pulmonary area in question can be supplied by an accessory bronchus derived from any one of several adjacent points on either the stembronchus or on its main ventro-lateral branch. This is the very simple explanation of all the observed facts upon which the entire theory of migration of bronchial components has been erected.

If three corrosion preparations of the adult lung illustrating three types of bronchial supply for a given ventro-medial pulmonary district (e.g., the cardiac lobe) are compared (fig. 10¹, ², ³), they might suggest that the ventro-medial accessory bronchus supplying the identical peripheral area (*X*) in all three lungs had 'migrated' from the initial position it occupied in figure 10¹ on the ventral bronchus to the angle between it and the stembronchus (fig. 10²), and had reached by continued 'shifting' or 'wandering' the ventro-medial surface of the stembronchus itself (fig. 10³).

Conditions identical in significance with those above outlined lie at the base of all other cases of supposed 'migration' of whatever kind or extent. In our present instance the sound interpretation recognizes, that the three bronchi, *A*, *B*, and *C*, supplying the same peripheral area, *X*, in their terminal distribution, are functional equivalents.

In respect to *derivation* they are not, however, the identical morphological element shifted by migration from 1 to 2 or 3, but the result of epithelial proliferation from *three* separate and

distinct points on the respiratory area of the stembronchus, or of its ventro-lateral derivative, or of both, and the selection of one of the three available points for the development of each of the three types (fig. 11¹ *A*, *B*, *C*). These three points are fixed and do not change their position during the individual ontogeny.

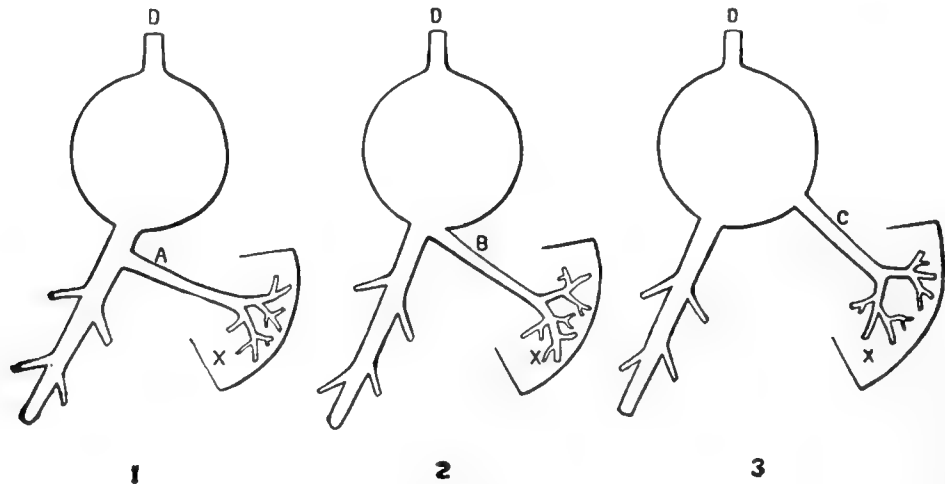

Figure 10

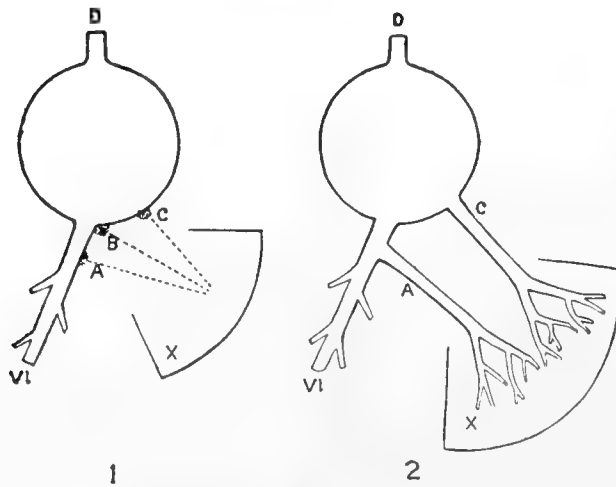

Figure 11

Figs. 10 and 11 Variation in origin of a ventro-medial bronchus.

When epithelial budding has started at any one of them it will continue, and accordingly lead to the corresponding adult condition of either *A*, *B*, or *C*.

It happens occasionally that a peripheral lung segment receives its bronchial supply from two sources. The terminal alveoli of each contributing bronchus are closed off within the segment of the district which it supplies and do not communicate with those of its colleague. Together the two components

make up a topographical pulmonary district ordinarily served by a single bronchus. This might be indicated in the present example by the simultaneous development of both *A* and *C* (fig. 11²).

Phylogenetic Migration

To hold to the example of the right cardiac lobe suggested by the above schematic illustration, we will suppose that we are dealing with three individuals of the same mammalian species, and that the further examination of a large number of additional individuals of this species showed that the types 1, 2 and 3 (fig. 10) occurred in approximately equal proportions, i.e., that a third of the total number examined carried, type 1, a third type 2, and a third type 3. We could then conclude that no one of the three types held a distinct advantage over either of the others, and that all three have been transmitted by inheritance in equal proportions. If, on the other hand, we examined the same number of individuals of a species allied to the preceding, and found type 1 in 90 per cent, type 2 in 18 per cent, and type 3 in only 2 per cent, we would be entitled to the conclusion that the relations of the peripheral area *X* to the lung as a whole had in the second species undergone some change, as compared with the first, through environmental, topographical or other developmental factors, which rendered a bronchus of the type *A* of distinct advantage to the individual possessing it, without barring altogether the occasional development of the bronchi *B* and *C*. For the second species type 1 has become dominant.

Let us assume further that we are dealing with a larger mammalian group of ordinal or subordinal rank, and that the individual genera composing the same not only possess so many distinctive morphological characters in common as to warrant the assumption of their genetic kinship, but that these common characters group themselves into an evident line of phyletic successions, placing the older and more primitive types at the beginning, the more recent forms at the end of this evolutionary line.

If such material were available, and if we had the opportunity of carefully analyzing the details of the pulmonary organization

in a sufficient number of individuals of each type in the series, we might conceivably arrive at the following results:

1. In the more primitive types the peripheral pulmonary area *X* is supplied in a large portion of the individuals by bronchus *A*, in a much smaller number by bronchus *B*.

2. The intermediate group of genera shows a decided numerical preponderance of bronchus *B*. A few individuals still carry bronchus *A*, and a still smaller number have developed bronchus *C*, either alone or in combination with *B*.

3. Finally in a third group, comprising the most recent and advanced forms, bronchus *C* has become dominant. There are relatively few *B* bronchi, and an *A* bronchus is only occasionally found.

Then, and only then, could we speak of a *phylogenetic migration* which has carried bronchus *A* from its original point of origin on the ventro-lateral primary bronchus through the angle-site *B* to its final position *C* on the stembronchus.

In the first of the above hypothetical groups, with bronchus *A* dominant, bronchus *B* appears as a progressive phyletic variant. In group 2, with *B* the prevalent bronchus, *A* is an archeal rever-sional, *C* a progressive phylogenetic variant. In group 3, both *A* and *B* are reversions, the former of the progonal, the latter of the ataval type. Even then the term 'migration' is to be interpreted only figuratively.

It is true that for the purpose of rapid examination of a series of bronchial trees, the concept and the term expressing the same are convenient and compact, and that they readily indicate the cardinal differences observed in the comparison of divergent types. Further, used in the sense above stated, they convey concisely certain broad evolutionary facts. Speaking phylogenetically it might be not altogether objectionable to refer to a bronchus as 'migrating' or 'wandering' from its original location to a new site in comparing a more archeal type of bronchial tree with one further advanced in progressive evolution. I have so used the term in my earlier publication. But it should be employed, if at all, with a clear definition of its meaning, not, as Narath has done, as designating an actual shift occurring during the ontogeny of the individual form.

Phylogenetic migration does not imply the bodily transplantation of a bronchial anlage. It means the establishment of a new focal point of bronchial epithelial proliferation whose product is a neomorph *replacing* the archeal bronchus, and, from the vantage-point of its new relation to the bronchial tree, enlarging the former's area of respiratory distribution and thus enhancing its physiological value to the organism. The older bronchus thus replaced loses its earlier significance, becomes reduced, and either disappears or is continued as a subordinated side-branch.

A bronchus per se does not travel. The phyletic impulse to inaugurate a new and more advantageously located bronchial derivative in its place from whatever point of the universally available entoderm is best adapted to the purpose, does travel. This sums up the essential difference between the 'migratory' and 'selective' theory of bronchial evolution.

The theoretical example above adduced could of course not be visualized in the long line of a single phyletic series with types transmitted by direct inheritance. The evolutionary periods required for the accomplishment of such changes exceed by far the utmost limit of preservation of non-fossilized organic tissue. An archeal type has perished ages before we recognize the result of its evolution in the modern inheritors. But while the unbroken phyletic chain of mammalian pulmonary evolution in the line of direct descent is not actually available, its reconstruction is made possible to a large extent by the comparative analysis of extant types and by ontogenetic data. Thus, for example, the pulmonary problem receives much elucidation from the detailed study of the lung in groups like the following:

Perissodactyls in comparison with Tapirus.

Hyrax and the Proboscideae.

Ungulates, Sirenia, some Cetaceans.

Relation of Catarrhine and Platyrrhine Primates.

Terrestrial and Aquatic Rodents.

Hystricomorphs.

Mustelidae and Taxidea.

Giraffa and the Camelidae.

Hippopotamus in comparison with the remaining Artiodactyls.

*B. Structural modifications of the primitive extrapulmonary
conductory channels of the trachea and bronchi, in
their reaction on the lung-stem*

We have in the preceding pages followed the main evolutionary lines leading up to the development of the most primitive type of the mammalian lung, consisting of the archeal lung-stem and its bronchial distribution (fig. 12). Additional extension of the respiratory area of the lung-stem is, as suggested above, possible to a limited extent by the increased development of its ventro-medial accessory bronchi leading to the production of one or more cardiac lobes. If the respiratory demand is further heightened the cranial portions of the lung-stem are the first to be called upon, because pulmonary extension is only possible, for topographical reasons, in the cranio-ventral direction.

The first ventral bronchus is mobilized in the service of this new acquisition of respiratory territory. It enlarges and its first cranial side-branch assumes proportions which may bring it finally to equal or even to exceed the rest of the parent stem V^1 . As the *Ascending Branch (A)* of the first ventral bronchus it now controls an additional pulmonary district developed from the lung-stem by a modification of the primitive intrapulmonary bronchial plan (fig. 13). As this new area enlarges and extends cranial and ventrad it may acquire a greater independence by the development of a cleft in the mesoderm enveloping the lung, which then, as the anlage of the main interlobular incisure, divides the entire organ into a cranial and a caudal segment (fig. 14). The former is the primitive upper lobe (fig. 14, *U*), built upon the first ventral bronchus (V^1) and its ascending branch (*A*). The latter is formed by the balance of the original lung-stem, supplied by the stembronchus and its remaining primary ventral derivatives caudal to V^1 (V^2-V^4), all the dorsal bronchi (D^1-D^4), and the cardiac bronchus (*C*) (fig. 14, *Lst*). The result is a mammalian lung whose bronchial tree is constructed in conformity with Aeby's bilateral hyparterial organization (type III).

Let us follow this first definite and typical mammalian bronchial tree in its further evolutionary progress toward the development of a still greater peripheral respiratory extension.

For reasons to be considered subsequently the right lung is ordinarily, compared with the left, more favorably situated for further pulmonary extension in both the cranial and ventral areas of the newly acquired district of the 'upper lobe.' The points of origin of V^1 , supplying the ventral portion, and of its ascending branch, A , distributed to the cranial segment of the

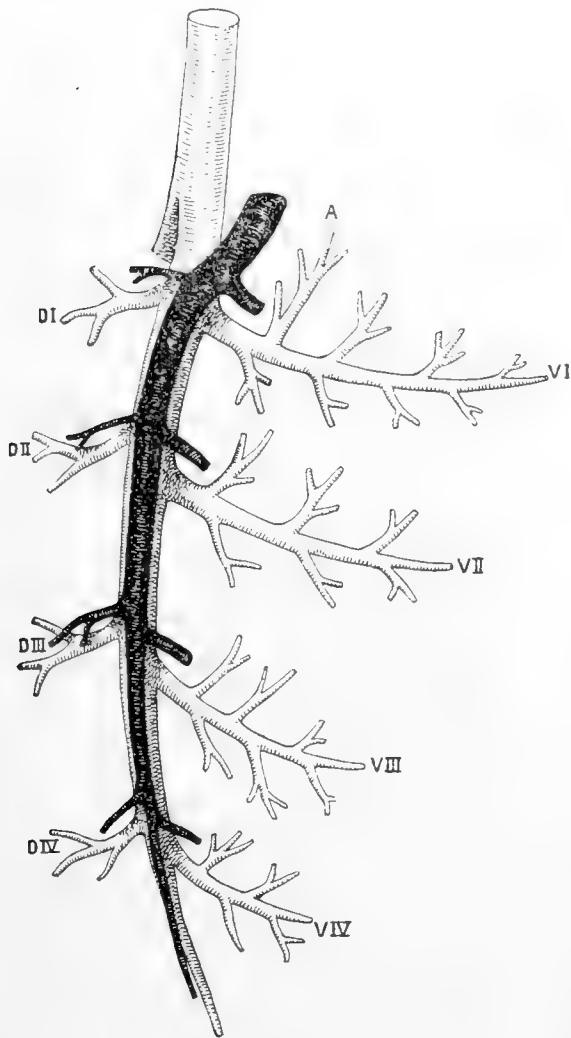

Figure 12

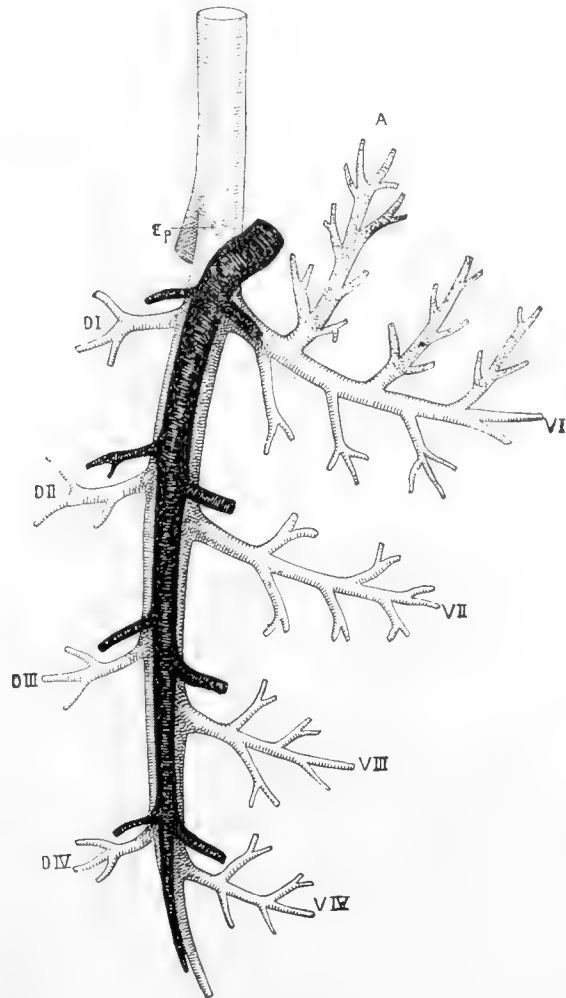

Figure 13

Figs. 12 to 15 Diagrams illustrating the evolution of the eparterial bronchus in the mammalia. V^1 - V^{IV} , ventro-lateral bronchi; A ., ascending bronchus; D^1 - D^{IV} , dorsal bronchi; $Ep.$, eparterial bronchus; $U.$, upper lobe; $M.$, middle lobe; $Lst.$, lungstem. V^1 - V^4 , D^1 - D^4 , V^1 - V^7 , D^1 - D^7 , Numerical order of ventro-lateral and dorsal bronchi after the eparterial bronchus has become established and functions as stembronchus for the newly acquired cranial pulmonary extension. *Cross-shaded*: Archeal bronchial tree. *Stippled*: Components adapted to pulmonary extension craniad and neomorph eparterial bronchi with their anlagen. *Black*: Pulmonary artery.

upper lobe, are too closely approximated on the bronchial tree to admit of much additional peripheral unfolding of their terminal branches.

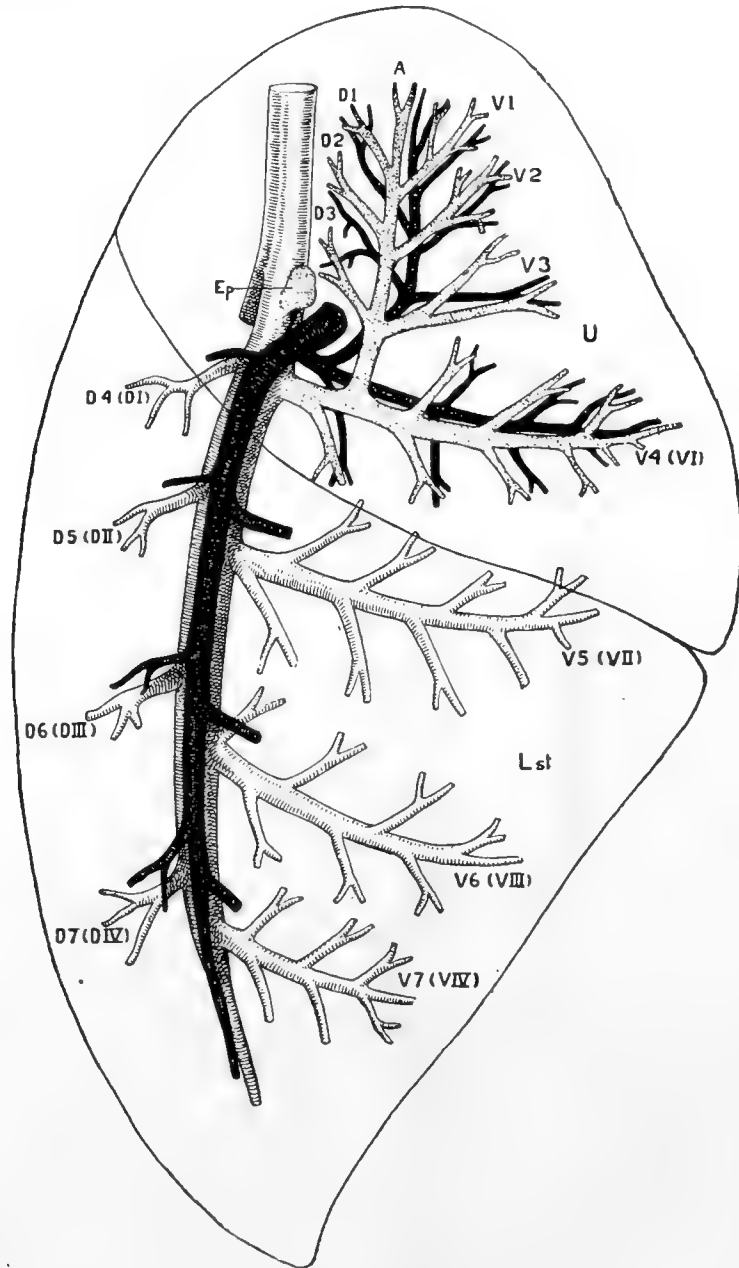

Figure 14

The right stembronchus has never lost its archeal inherent potency of inaugurating bronchial proliferation from any part of its circumference. Its dorso-lateral surface in the stretch between the origin of V^1 and the tracheal bifurcation is an especially

favorable site for the exercise of this power, owing to local conditions described in detail below (cf. infra, p. 186). A new bronchial bud (fig. 14, *Ep*) pushes out into the interval developed

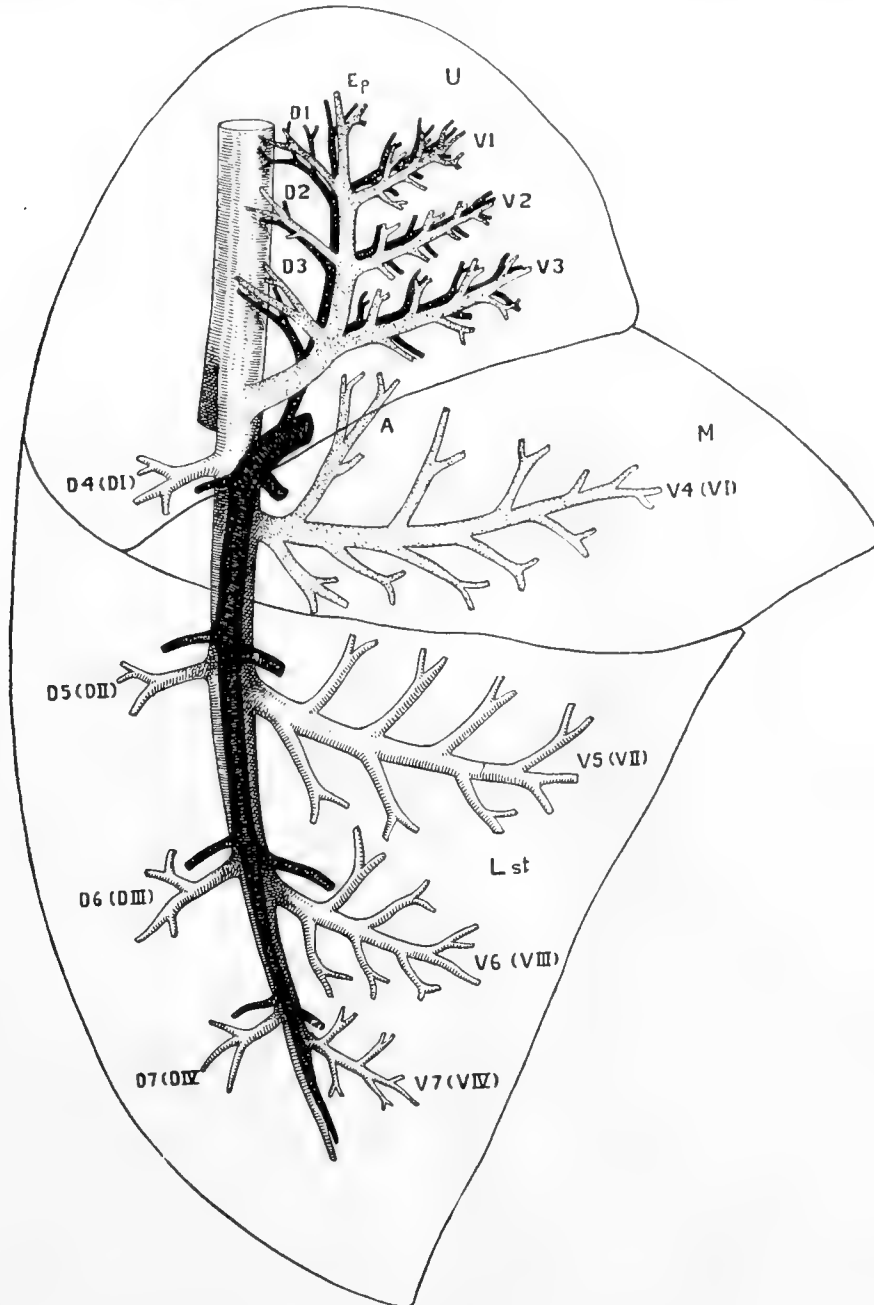

Figure 15

by rotation of heart and oesophagus between the foregut, supporting the right vagus nerve, and the right pulmonary artery, and develops into a bronchus which eventually supplies the cranial area of the upper lobe and enables it to expand further. This

new element thus added to the bronchial tree of the right lung, is the Eparterial Bronchus (fig. 15, *Ep.*). It arises from the dorso-lateral aspect of the stembronchus cranial to the origin of V^1 and nearer to the tracheal bifurcation. It lies *behind* rather than *above* the main right pulmonary artery, which vessel descends caudo-laterad over its ventral surface to dip dorsad between it and V^1 and then continue its descent dorsal to the remaining ventro-lateral primary branches of the stembronchus. It might hence be defined more correctly as the Katarterial Bronchus, but all arterial relations are of very secondary morphological significance in the analysis of bronchial organization. Aeby named it the Eparterial Bronchus, and this designation should stand for all time on the basis of historical priority, no matter if in individual mammalian forms the bronchus starts behind, above, or to the inner side of the artery. These are secondary and unimportant details. The cardinal fact remains that Aeby was the first to *recognize the existence* of the bronchus and its morphological significance in the intrapulmonary architecture. That fact out-balances any baptismal slips its godfather may have committed. Besides there are numerous mammalian types in which the designation is quite pertinent. It is concise, thoroughly incorporated in the anatomical literature, and no observer would be misled for a moment by its use in correctly diagnosing any given bronchial tree. Surface indications pointing to a newly acquired independence and greater freedom of the cranial segment of the preceding primitive 'upper lobe' are not wanting in many forms. The district of the new eparterial bronchus becomes separated from that of the first ventral hyparterial bronchus by a correlated new fissure, the secondary interlobar incisure. The former now constitutes the definitive 'upper lobe' proper, the latter forms the 'middle lobe,' confined to the ventral pulmonary region (fig. 15, *M*). Both are separated from the remainder of the archeal lung-stem, the 'lower lobe,' by the older main interlobar incisure.

On the left side conditions remain much as they were before the inauguration of the right eparterial development (fig. 13). There is ordinarily no left eparterial neomorph bronchus. The

relations of the left stembronchus cranial to the origin of V^1 to the foregut, vagus nerve and pulmonary artery are less favorable for this type of bronchial development than on the right side, for the reasons referred to below (cf. infra, p. 186). In place of this the ascending branch (A) of V^1 has unfolded more fully, until in many cases it nearly or entirely equals in size and extent *Ep.* of the right side. Like the latter it supplies the cranial lung area of its side. The ventro-lateral extension of V^1 is often considerably reduced as compared with the homologous bronchus of the right lung. This is largely due to the projection of the heart into the left thoracic cavity, necessitating a diminution in the volume of the ventro-caudal portion of the left upper lobe. This is also indicated by the frequent cardiac recession of the left ventral pulmonary margin. As the result of these conditions the districts of the left lung supplied by A and V^1 respectively are in many forms not separated by a secondary interlobar incisure, such as divides on the right side the 'upper' from the 'middle' lobe. Both remain included within the limits of the primitive left 'upper' lobe. That this can, however, undergo the same lobar subdivision as in the right lung, is shown by numerous mammalian specific types.

With the full development of the conditions just described the mammalian lung has reached the evolutionary stage attained by over 90 per cent of the living forms. It enters the dominant group, forming Aeby's type II^A, with the eparterial bronchus derived only from the right stembronchus. Extension of the same evolutionary process to the left lung produces Aeby's type I, the symmetrical bilateral eparterial tree of bronchial derivation. If a point on the tracheal epithelium is selected for proliferation of the right eparterial component the typical artiodactyl and cetacean lung results (Aeby's type II^B), and if in addition the left stembronchus cranial to V^1 develops an eparterial bronchus, the lung of Camelidae and of Giraffa is formed (Aeby's type I^B).

The origin of the eparterial bronchus may be so low that barely enough space is left between it and V^1 for the passage of the pulmonary artery. On the other hand it may arise from the most

proximal portion of the stembronchus cranial to the angle of the tracheal bifurcation, or even in part from the right lateral wall of the trachea. Every position between these two extremes is encountered in the mammalian series. These differences depend upon the point selected for the development of the eparterial bud in the different mammalian forms possessing the prevalent type of bronchial organization. Individual differences in the level of origin of the eparterial bronchus are also found within a single species.

However placed in this respect, the right eparterial bronchus and its functional equivalent of the left lung, the ascending branch (*A*) of the first left ventral hyparterial bronchus, both possess fundamental morphological characters of the highest importance. Each serves for the neomorph cranial pulmonary district in the same capacity as does the main stembronchus for the lung-stem, constituting its excentric axial structure. Ontogenetically this is the result of the identical processes which we noted above as responsible for the intrapulmonary organization of the primitive lung-sac (cf. p. 160).

The eparterial bud of the later phyletic stages of evolution is the exact homologue of a secondary lung-sac of the early embryonal period, and develops its conductory system on exactly the same morphogenetic lines. We speak, for the sake of brevity, of the anlage of the 'eparterial bronchus.' In the strict sense it is not the 'bronchus' which buds, but the respiratory entodermal outgrowth which will later be represented in the bronchial tree by the eparterial bronchus (figs. 13 and 14, *Ep*). This secondary cranial stembronchus for the upper lobe develops along the same path as its ancestral prototype, the primary stembronchus of the lung-stem, and like it acquires ventral and dorsal branches, and, sparingly, accessory bronchi. Its terminal distribution supplies the apex of the lung, just as the main stembronchus breaks up into a leash of small branches for the caudo-dorsal lung-pole. In this evaluation of *Ep* and *A*, as the stembronchi for the cranial extension from the lung-stem of their respective sides, their dorsal and ventral derivatives are seen to fall into serial line with the corresponding branches of the main stembronchus in the

lung-stem (figs. 14 and 15, V^1-V^7 , D^1-D^7). The total number of the ventral and dorsal bronchi for the lung as a whole is thus increased through the supplemental elements contributed to the series by *Ep* and *A*. The secondary acquisition of the cranio-ventral pulmonary segments and their implantation upon the primitive lung-stem forms the key to the phyletic interpretation of the mammalian bronchial tree and of the pulmonary evolution based thereon. These gradually acquired important modifications of the primitive architectural type, and additions to it, and the resulting reorganizations are indicated schematically in the diagrams 12 to 15, showing a lateral profile view of a right lung.

Figure 12 represents the archeal condition. The stembronchus gives off four larger ventro-lateral primary bronchi (V^I-V^{IV}) and an equal number of shorter dorsal branches (D^I-D^{IV}). The pulmonary artery enters the cranial base of the lung-stem lateral to the extrapulmonary bronchus and turns dorso-caudad over V^I to descend on the dorso-lateral aspect of the stembronchus between the ventral and dorsal primary bronchi supplying a branch to each.

Figure 13: The cranially directed derivatives of V^1 (stippled in diagram) enlarge, especially the first (*A*), foreshadowing the eventual cranio-ventral extension of the lung and the involvement of V^1 in the same.

The dotted area (*Ep*) on the lateral surface of the extrapulmonary stembronchus, above and behind the artery, indicates the point of selection for the future development of the bronchial bud which will eventually lead to the establishment of the eparterial bronchus.

Figure 14: The cranial and ventral pulmonary segments have extended greatly. The former is built upon the first cranial derivative of V^1 , which, as its Ascending Branch (*A*), now passes well above the pulmonary hilus along the trachea, giving off ventral and dorsal side-bronchi and terminating in the distribution to the apex of the lung.

After supplying its ascending branch (*A*) to the cranial development, V^1 continues its original course ventrad, the first

ventral branch of the pulmonary artery keeping pace. V^I and A together now supply the new cranio-ventral pulmonary territory, which tends to separate by fissuration as the primary 'upper lobe' from the remainder of the archeal lung-stem. The stem-bronchus, having yielded its first ventral primary bronchus V^I to the newly acquired more mobile district, supplies with its remaining ventral ($V^{II}-V^{IV}$) and with all its dorsal branches (D^I-D^{IV}) the definitive lung-stem, constituting the 'lower lobe' of the more highly developed mammalian lung. The left lung of the dominant mammalian type does not pass beyond this evolutionary stage and hence retains a more archeal character than the organ of the right side in the great majority of the mammalia. In the special groups with bilateral eparterial organization (pinnipedia, cetaceans, camelidae), the left lung follows more or less closely in the wake of the right pulmonary extension.

In figure 14, the anlage of *Ep.* destined to supplant A in the progress of further evolutionary advance, is shown schematically as an epithelial bud supplied by a special branch of the pulmonary artery.

The ascending branch A of V^I varies in relative size as compared with the parent stem in different mammalian types, as the natural result of its phyletic development.

1. It may be of smaller caliber than V^I , appearing then merely as a slightly enlarged side-branch. In this case the new pulmonary territory is located chiefly in the ventral area, the cranial extension remaining small.

2. The first ventral bronchus may divide into two equal branches, A and V^I . The primary upper lobe then extends equally craniad and ventrad.

3. The first ventral bronchus arches almost directly from its origin craniad, (A) representing the main channel, while the continuation of V^I appears as its most caudal ventral derivative. Pulmonary extension is then chiefly craniad.

The three conditions illustrate successive stages in the evolution of the cranial lung segment. Diagram 14 is based on the second.

When fully developed the component (A) functions as a stembronchus for the cranial lobe. Its ventral and dorsal branches fall into serial line with the corresponding derivatives of the main stembronchus within the lung-stem, increasing the total number of these elements for the entire lung.

Diagram 14 indicates three additional ventral bronchi and the same number of dorsal derivatives in the zone for which (A) plays the part of the stembronchus (V^{1-3} , D^{1-3})

Regarding the organization of the lung in its new form the archeal V^1 becomes V^4 , D^1 is rated as D^4 , and so on down the line until the total number in each of the rows is raised from four to seven. In this and the succeeding diagram 15, the archeal designation of each primary bronchus is indicated by the Roman numerals, its more recently acquired value in the series by the Arabic figures.

Figure 15. In this stage the eparterial bud of figure 14 has expanded into the fully developed bronchus of that designation, supplying the 'upper lobe' in its later restricted sense. Its ventral and dorsal branches (V^{1-3} , D^{1-3}) are further extended and more directly aligned with those of the main stembronchus, and the eparterial arteries are correspondingly developed. Branch A of V^4 (formerly V^1) has receded to the position of the normal first cranial side-branch from its parent stem.

The district supplied by Ep may be peripherally demarked, by the development of the secondary interlobar incisure, as the 'upper lobe.' In this case V^4 (V^1) supplies the separate ventrally placed 'middle lobe.' In the other cases Ep and V^4 (V^1) are still enclosed within the limits of a single primary 'upper lobe.' The individual areas supplied by single side-branches of Ep , as, e.g., V^1 , D^1 , may be outlined superficially by secondary fissures or grooves, forming apical clefts or incisures.

Summary of eparterial development in the mammalia

The phyletically evolved division of the archeal single lung into two distinct segments affects the intrapulmonary architectonics radically. The lung-stem remains supplied by the stem-

bronchus and its derivatives, with the exception of the first ventral hyparterial bronchus ceded to the new cranio-ventral districts. It shows a remarkable regularity in the uniform type of its conductory system, and in the bilateral homology of its individual components. The more recently acquired secondary cranio-ventral neomorph requires for its organization the development of a new axial conductory canal, occupying within the additional territory, however restricted or extended this may be, a position strictly analogous to that of the stembronchus of the older caudal pulmonary component. Like this it develops its ventral and dorsal side branches and its terminal distribution. It varies in the extent and arrangement of these elements with the varying range and disposition of the pulmonary area under its control. It likewise varies in its point of derivation from the archeal intrapulmonary bronchial system of its predecessor, the primitive lung-stem. The available range of its origin extends craniad from the latter's base. In the initial and lower phases of its development it appears as an exaggerated branch of the first ventral hyparterial bronchus. As it unfolds and aims at the control of a more extended territory this original point of its origin proves inadequate, in accordance with the law governing the relation between the peripheral expansion of a bronchus and the distance separating its origin from the adjacent branches of equal rank. The neighborhood has become too crowded, so it moves. But it does not carry its old house with it. It selects a site in territory less thickly settled and begins to build a new one. It does not 'migrate,' it 'emigrates.' It selects a point on the still unoccupied stretch of the stembronchus. If the long established path of the main pulmonary artery supplying the archeal system lies in the way, it surmounts it and fixes on a spot beyond, confident in the knowledge that the old stream can be tapped to furnish the necessary supply for the new habitation. In doing this the bronchus has not only abandoned its ancestral birthplace, it also has changed its citizenship. It leaves the archeal hyparterial community of its fellows and appears as the pioneer founder of the new eparterial colony. The only path for still further advance lies open craniad. Depending upon the

demands for increased pulmonary area the new arrival appropriates a still more proximal portion of the stembronchus. The tracheal bifurcation, the trachea itself to a varying height, furnish the epithelial fundament for increased respiratory extension in new points of eparterial bronchial derivation from the original stem-line.

In all cases the available intrathoracic range of eparterial extension is more or less restricted, so that the opportunity or necessity for the development of more than a single eparterial bronchus does not arise. The anlage for it has only to bud far enough away from its nearest hyperarterial neighbor to obtain all the space requisite or available for its development. Still the possibility for the unfolding of more than one eparterial bud is inherent in the organization, as shown by instances of double eparterial bronchi in a few forms (Giraffa, Camelus, Auchenia, Delphinus, Myrmecophaga), in which a large tracheal eparterial bronchus is accompanied by a smaller eparterial contribution. This is usually derived from the right stem bronchus, but in Giraffa arises from the trachea caudal to the main eparterial trunk.

Factors responsible for the prevalent asymmetry of the mammalian lung

In the dominant type of mammalian intrapulmonary architecture eparterial development is confined to the right lung, with the eparterial bronchus derived from the right stembronchus. The resulting pulmonary asymmetry is encountered in at least 95 per cent of the mammalian genera and species whose bronchial trees are recorded, and hence calls for detailed consideration in any critical analysis of mammalian pulmonary evolution. The question has long attracted attention and the etiological factors held responsible for the prevalent condition have been discussed in a general way.

The encroachment of the heart on the left half of the thoracic space is evidently the cause of the relative reduction and loss of volume of the left as compared with the right lung. This is

borne out by the fact that in the aquatic mammals (pinnipedia, cetacea, sirenia) with bilateral pulmonary symmetry, the heart occupies frequently a striking median position, extending nearly equally into both sides of the thorax. It is of course impossible to decide whether this is the original condition favoring symmetrical pulmonary development, or whether the initial deviation of the heart to the left has been corrected secondarily by an increase in the volume of the left lung and possibly by the operation of hydrostatic factors.

Flint (21) regards the unpaired right eparterial bronchus "as the normal condition of mammalia, due to a phylogenetic provision for the descent of the heart and great vessels through the suppression of the element of the left side."

Flint explains the mechanical factor which he considers operative in preventing the development of a left eparterial bronchus as follows (l. c., p. 129):

In the descent of the aortic arch and the Ductus arteriosus during embryonic life from a point above the origin of Lateral 1 to a point below, we have an explanation for the suppression of this element on the left side, for if this bronchus were formed, both aorta and the Botallian duct would be caught upon it and their descent prevented. Likewise the Vena pulmonalis appears in the midline and is carried to the left until it finally rests on the portion of the stem where a left Ventral 2 should develop. The usual suppression of these two elements, therefore, must be looked upon as a phylogenetic provision to allow for the descent of the great vessels on the one hand and the shifting of the Vena pulmonalis on the other. It is noteworthy that in those animals where these bronchi are formed on both sides, they are so situated as to offer no resistance to either of these features of the development of the great vessels.

It is difficult to see just what Flint means in assuming architectonic differences in the developmental groundplan of mammalia possessing bilateral eparterial bronchi which favor symmetrical bronchial unfolding in them, whereas it is prevented on the left side in the dominant mammalian type. It is also difficult to bring his explanation of pulmonary asymmetry into line with the human instances of dextro-thoracic aortae without situs inversus, in which the aorta uses the right fourth arch and

the order of the primary branches is left innominate, right carotid and right subclavian, while the right lung continues the normal development of its eparterial element. Further the numerous instances encountered in the mammalian series and briefly referred to below (cf. p. 193), in which a left eparterial element develops as a variant in addition to the normal right branch of the same denomination, speak against Flint's hypothesis.

The concept of a left sided aorta and Botallian duct being 'caught upon' a bronchus of this type and being prevented from descending thereby does not appear to me well based. The cardiac descent does not carry the aortic arches into a secondary relation with an already formed bronchial tree. When bronchial budding begins the arches are already in their future and definite position in relation to the developing lung. Any subsequent topographical changes heart and lung undergo together, during the progress of their concurrent development.

On the other hand a careful examination reveals intrinsic factors favoring the development of the dominant mammalian type of pulmonary asymmetry with hyperplasy of the right organ. These are based on the thoracic visceral and vascular relations of the lung and its adaptations to the same.

A detailed study (27) of the topographical relations of the developing mammalian lung and of the pulmonary artery in the critical stages accounts very definitely for the prevalent right-sided eparterial development, and at the same time shows the possibility of the occasional derivation of a homologous eparterial bud from the left stembronchus. The topographical conditions, while favoring the development of the eparterial component in the right bronchial tree, are all against a corresponding eparterial derivative from the left stembronchus. Nevertheless the condition occasionally occurs as an individual variant in the embryo and adult of mammalian forms which possess normally the dominant asymmetrical bronchial type, as shown by the instances cited above (*Homo*, *Echidna*, *Lepus*, *Tragulus*, *Erethizon*, *Sphingurus*, *Erinaceus*).

The evolutionary opportunity for the normal development of the bilateral eparterial type in certain limited mammalian groups

also exists (pinnipedia, perissodactyls, camelidae, aquatic rodents, arboreal primates, Hippopotamus). The early ontogenetic stages must therefore offer opportunities which correspond to the above findings in the adult. The ventral wall of the foregut with the vagi forms in rabbit embryos of 10 mm. to 11 mm. the background supporting the tracheal bifurcation and the stembronchi with their primary buds. The pulmonary arteries accede to the ventral-lateral circumference of the trachea along which they at first descend in a fairly symmetrical course. In approaching the tracheal bifurcation the right artery gradually inclines ventrad, while the corresponding vessel of the left side turns dorso-caudad. This is the result of the rotation of the heart and its arterial pedicle to the left. At the same time the foregut carrying the two vagus trunks undergoes the axial rotation to the right through which the left side of the gastric enlargement attains its direction ventrad.

As the result of these rotations of heart and foregut in opposite directions the topographical conditions are changed on the two sides. The left vagus and left pulmonary artery gradually approach each other and are, at the level of the tracheal bifurcation and origin of the stembronchi, in close contact. The reverse obtains on the right side. The right pulmonary artery turns more and more ventrad in descending, while the right vagus, following the rotation of the foregut, moves dorsad. An arterio-neural interval is thus opened up on the right side toward which the latero-dorsal circumference of the right stembronchus faces directly and into which it sends the right eparterial bronchial bud. The latter thus comes to lie in front of the right vagus and right side of the oesophagus, and behind the right pulmonary artery. On the left side this arterio-neural portal for eparterial development has been blocked by the approximation of left vagus and left pulmonary artery, or reduced to such an extent that it no longer affords a favorable path for the protrusion of an eparterial bud from the left stembronchus. The first primary derivative of the latter is hence forced to pass ventral to the artery and thus becomes the first ventral hyparterial bronchus of the left side. This supplies through its large, ascending

branch the cranial pole of the left lung, corresponding to the area which on the right side receives the eparterial bronchus.

The narrow interval between left vagus and left pulmonary artery may at times suffice for the passage of a bud derived in this situation from the left stembronchus. In such individuals the variants mentioned below (cf. p. 193) would occur. The normal ascending branch from the first left ventral hyparterial bronchus, usually supplying this segment, would then be correspondingly reduced or default altogether.

It is significant to note in this connection that in the rabbit, in which form both the adult variations above mentioned and their embryonic anlagen have been recorded (cf. p. 104), the cranio-ventral pulmonary extension, forming the upper pole of the left lung, is very much reduced compared with the right side. This is especially marked in some wild species, as in *Lepus campestris*. The impulse to send an eparterial bud from the left stembronchus through the narrow vago-arterial interval, in spite of the reduced space available, would be fostered under such conditions by the smaller pulmonary area which it would be called upon to serve.

I believe that the conditions just outlined furnish the adequate ontogenetic explanation of the prevalent asymmetry of the mammalian bronchial tree, and that this is based primarily on the difference in the opportunity for cranio-ventral pulmonary extension afforded normally to the right and left lung respectively, in consequence of the cardiac and oesophageal rotation in opposite directions. The sinistral turn of the heart, and its effect on the initial direction imparted to the pulmonary arteries, depends upon the typical development of the left-sided mammalian aorta and the retention of the dorsal segment of the left sixth aortic arch as the Ductus Botalli. This structure fixes the cardiac twist and turns the left pulmonary artery dorsad, while in contrast the right pulmonary artery, freed by the obliteration of the right sixth aortic arch in its dorsal portion, turns ventrad in response to the rotation. The enormous mechanical force exerted by the Botallian Duct on the position of the heart and on the adult arterial pattern is strikingly illustrated by compar-

ing the frequently observed cardinal variation of a left subclavian artery arising from the normal thoracic aorta, with the rare case in which the same variation of the primary arterial branches is combined with a *right*-sided thoracic aorta and the retention of a *left* Botallian Duct.

The facts observed during the ontogeny of the dominant pulmonary type in the mammalia account for the conditions found in the adult. Any extensive series of typical mammalian pulmonary dissections will show that in the great majority the cardiac rotation has carried the origin of the main pulmonary trunk so far ventrad and to the left that the primary division of the vessel takes place to the left of the trachea or of its bifurcation. The longer right pulmonary artery hence crosses the ventral surface of the lower end of the trachea or its bifurcation from left to right. In descending to the point of its intersection with the dorso-lateral surface of the stembronchus in the angle formed by the first ventral bronchus with the latter, the artery lies chiefly ventral to the proximal portion of the right stembronchus, between the origin of its first ventral branch and the tracheal bifurcation. The cranio-lateral surface of the stembronchus thus left free is occupied by the origin of the right eparterial bronchus. The shorter left pulmonary trunk turns almost sagittally dorso-caudad, covering directly the cranio-lateral circumference of the left stembronchus in the interval between the tracheal bifurcation and the origin of the first ventral hyparterial bronchus. The artery thus occupies the larger part of the segment which would be otherwise available for left eparterial development.

If the general premises of the selection theory are well taken and if hence the eparterial components of the bronchial tree are secondarily engrafted during evolution on the archeal lung-stem, the mutual relations of the latter were already established at a time when additional cranio-ventral extension of the lung was inaugurated. The eparterial acquisition must fit into and become adapted to already existing conditions, which are more favorable on the right as compared with the left side.

I consider these facts as chiefly responsible for the preponderant development of the eparterial bronchus only on the right side,

and as further confirmatory evidence in favor of regarding the mammalian eparterial unfolding as a relatively late and secondary occurrence. If it has been included in the primary ancestral plan of pulmonary organization (Reduction Theory) the arterial relations of the entire organ would have conformed to the same. On the other hand, after the archeal bronchial plan and the conforming arterial supply became established, the later modifications of both were adapted to the primitive conditions. Left-sided eparterial development is not altogether excluded, as shown by the extant normal groups of this type and by individual variants. Its accomplishment is only rendered more difficult than on the right side, and hence occurs less frequently.

The unoccupied proximal segment of the left stembronchus is moreover additionally handicapped in its potential range of secondary bronchial proliferation by the indirect relation to the left-sided aortic arch. The smaller and far less resistant azygos arch surmounting the root of the right lung offers in comparison only insignificant opposition to pulmonary extension in this region, as shown by the instances in which the azygos is lodged in a split of the right upper lobe.

Lastly, in judging all the factors possibly or probably active in the relative development of the two lungs, and responsible for the prevailing asymmetry, the persistence of the patent left ductus arteriosus of the mammal, and its relation to the intrapulmonary circulation during the placental period, deserves consideration. I have already in a previous publication (25) touched on its possible hydrostatic significance in this connection.

It will thus appear that both the developmental, structural and functional conditions of the lung and the intrathoracic relations differ sufficiently on the two sides to account for the greater volume attained by the right lung in comparison with the left. All these conditions are, however, based on the fundamental organization of the archeal lung-stem and its adaptation to the secondary cranio-ventral segments acquired during the course of evolution.

*Selection theory**Summary*

The theory of selection is based on the morphological and physiological conditions which have combined in the evolution of the mammalian pulmonary organization.

I. Morphogenetic principles. The phyletic interpretations of the extant types of bronchial architecture in the mammalia, and the homologization of the right and left bronchial components in the asymmetrical forms, does not depend upon the rearrangement of a fixed number of primary bronchi derived from a hypothetical archeal bronchial tree and shifted within this frame in the various types, much as chessmen are moved around on the board. It rests on the fact that the entire entodermal respiratory anlage of the mammal has evolved on the basic pulmonary organization transmitted from its batrachio-reptilian ancestry, sharing in all the developmental potencies of the latter. It is not only unnecessary to suppose that extant reptilian types, if determined adequately, would yield an unbroken and closely graded series leading directly to the mammalian pulmonary organization, but all the available phylogenetic, ontogenetic, and comparative evidence negatives such an assumption.

It is probable, as outlined above, that the promammalia emerged from a reptilian stem with lungs corresponding approximately to the organs of the simpler modern lacertilia, or at most advanced to the stage of pulmonary evolution occupied to-day by the more primitive paludal and littoral chelonia. Such a lung presented the pulmonary cavum still continuously lined by respiratory entoderm. The more complex and highly organized lungs of the marine chelonia and of the crocodilia developed the differentiation of the intrapulmonary bronchial system, secondarily engrafted on the primitive structure (cf. p. 160), and represent specialized adaptations continuing the line of reptilian development beyond the point at which the mammalian derivation left the common ancestral stock. In this they follow the same underlying genetic laws which determine the further course of the mammalian evolution, but they lead to higher stages of

pulmonary development distinctly reptilian in the character of its details and divergent from those attained by the mammalia.

The archeal promammalian lung-tube possessed, like its lacerilian prototype, the potency of differentiating conductory lines and peripheral respiratory areas by a selective development of bronchial buds from any point on the entodermal surface, following the morphogenetic lines detailed above for the reptile. The number of these primary foci of heightened mitotic activity leading to epithelial proliferation, and their position relative to each other and to the axial pulmonary canal, determined the *bronchial type* of distribution. They must have from their inception represented the sum of the reactions of the milieu on a pulmonary organization which, at its emergence from the reptilian stem, was in a highly plastic condition and responsive to new environmental and metabolic factors. It is hence quite possible that the various types of the modern mammalian lung owe their diversity in part to polyphyletic derivation. The bronchial organization best adapted to respiratory conditions obtaining at any one evolutionary phase for each mammalian form became fixed for that form by heredity as long as the respiratory factor of the environment remained unchanged. The extant ordinal, generic and specific types are the result of the transmission of selective patterns to the descendants.

All the available evidence goes to show that in certain mammalian groups the more primitive bronchial types have, during the progress of this evolution, undergone modifications, sometimes of wide import, in response to altered environmental and functional demands. The opportunity for the continued development of such secondarily acquired adaptations rests in the persistent morphogenetic plasticity of the bronchial system and the retention by it of the potency, derived from the primitive ancestral entodermal lung-tube, of inaugurating additional or atypical points of epithelial activity under the appropriate stimuli, leading to the production of neomorph bronchial components.

I base these premises on three sets of facts:

I. The above outlined phyletic development of the bronchial system in the vertebrate series.

II. The mutually interchangeable character of conductory and respiratory anlagen in the most primitive mammalia.

III. Variant fluctuations and mutations of the mammalian bronchial system.

I. Cf. *supra*, p. 157.

II. The lungs of Aplacentalia develop on lines identical with those determining the placental pulmonary unfolding until the main features of the future bronchial pattern characteristic of the adult are clearly mapped out in the disposition of the pulmonary entoderm (5, 32, 35). At 'birth,' under the stress of altered physiological conditions, they revert for a period to an earlier phylogenetic phase. The bronchial pattern is wiped out by the sudden distension of the lung and the entire future conductory apparatus is employed for respiratory exchange. We are probably not far from right if we picture the early promammalian lung as presenting about the conditions seen in the third ontogenetic stage of the monotreme and marsupial organ, in which the immature embryonic lung at the moment of the 'birth' is 'blown up' by the first intake of air and reverts temporarily to its reptilian prototype. The aplacentalian lung of this stage suggests events which might have occurred if a reptilian lung began to experiment with adaptations to mammalian organization, and the experiment was interrupted. The gradual return of the aplacentalian lung, during the fourth developmental period, to the temporarily abandoned type of placental bronchial organization points the evolutionary path along which the reptilian lung attained the mammalian form. The aplacentalian ontogenetic pulmonary cycle demonstrates the developmental potentiality of the primitive mammalian pulmonary anlage. It proves that the early stembronchus and its primary derivatives, even after they are grouped into the main lines of the future bronchial pattern, are not yet bronchial structures in the sense in which we employ the term in adult anatomy, although they outline clearly the path along which the subsequent differentiation of the conductory passages and the respiratory alveoli occurs. The early bronchial system of the placental embryo still retains the archeal character of a potential respiratory

structure which can manifest itself under suitable conditions by the proliferation of respiratory buds from any part of its extent. This plastic period, constituting a distinct phase of aplacental development, and rehearsed briefly in the early ontogenetic stages of the higher groups, forms the phylogenetic basis for the gradual evolution of the divergent types of the mammalian bronchial tree.

III. The occurrence of individual bronchial variants within a species, both secondary and cardinal in character, further conclusively demonstrates the existence of a period in the individual development during which the inherited ancestral bronchial pattern is capable of alteration, producing variations of greater or lesser extent.

Man is, in his pulmonary organization as in the other details of his structure, the best known mammal by reason of the relatively enormous number of individuals examined anatomically and the accumulation of the records pertaining to them. The human bronchial tree is of the dominant mammalian asymmetrical type with the eparterial distribution developed only on the right side. Yet a number of instances of both the bilateral hyparterial and the bilateral eparterial type are recorded in man.

Similar or greater variability is found among the lower mammalia. It is usually less striking only on account of the smaller number of individuals of each species examined. Some forms are, however, exceptionally prone to bronchial variability.

The Hystricomorph rodents constitute an important group in which it is clear that pulmonary evolution is actively progressing at the present time, with the bronchial organization in a state of unstable morphological equilibrium and presenting frequent mutant variations (28).

A series of ten individuals of *Erethizon dorsatus* contains representatives of both the bilateral eparterial and hyparterial symmetrical bronchial types, of the dominant mammalian asymmetrical right eparterial form, and of a transitional variant which appears as the normal fixed type in *Sphingurus prehensilis*, another member of the Hystricomorph group.

In a series of 29 examples of *Erinaceus europaeus* recorded by Narath (l.c., p. 131) 20 specimens carried only the usual right-sided eparterial bronchus, but in 9 individuals there was a bilateral eparterial development.

These are examples of exceedingly variable species, with unstable bronchial organization, but the same conditions obtain to a greater or lesser degree throughout the mammalian class. They are instances of the selection by the primitive entodermal anlage of developmental lines of bronchial budding which are atypical for the species concerned, although typical for some other forms. Their appearance as mutations is rendered possible through the universal plasticity of the embryonal anlage. Thus the primitive lung-tube, with the typical plan of its unfolding determined by heredity for each species, yet retains the archeal potency of developing bronchial anlagen from any point of its entodermal lining, and is hence able to produce in the individual both minor departures from the regular type, and cardinal variants which alter the morphological character of the bronchial tree, as in the instances cited.

II. Physiological factors operative in pulmonary evolution. The outstanding fact in all vertebrate pulmonary evolution is the increase in structural complexity and the resultant heightened functional activity of the cranio-ventral as compared with the more archeal caudal lung segments. This distinction begins to appear far back in the reptilian stem. It is well defined in the higher lacertilian lung, becomes dominant in the paludal and marine chelonia and reaches its highest development in the crocodilia. It is a pronounced factor in the organization of the avian lung, modified by the peculiar morphogenesis of the organ in this class, and forms the guiding line, as above detailed, in the interpretation of the mammalian pulmonary evolution.

Selection bases the morphogenesis of the organ on the universal adaptability of the primitive promammalian entodermal lung-sac to respond to the functional demands made on it. This inherent potency derived from the mammalian ancestry to develop bronchial buds from any points of its epithelial surface, and to assemble them into a pattern adapted to the respiratory

requirements of the organism, lies at the root of the bronchial architecture of the extant mammalia. In place of mechanical modification of a preformed structure we see everywhere in the mammalian bronchial tree the selection of developmental paths from a field only limited by the extent of the pulmonary entoderm itself. Selection of the number, location and direction of the points at which epithelial proliferation is focused in bronchial development furnishes the archeal types from which the extant patterns have passed to the modern descendants. For any given mammalian group the force of inheritance will ordinarily assemble the entodermal buds progressively as they develop in the embryo according to a pattern, which outlines the type of bronchial tree characteristic for the form in question in the normal adult individual.

Comparative anatomy indicates clearly that the forces which determined the selection of this pattern in the ancestor were environmental and metabolic in character. A primeval ancestral bronchial type transmitted to the descendants can be altered and modified by the same morphogenetic processes determining the selection of new bronchial lines, as soon as the descendants themselves, or a large proportion of them, have begun, under changed conditions of environment and adaptation, to constitute new mammalian types requiring such respiratory modifications. An example of this is furnished in the rodent subfamily of the Hydromyinae: *Xeromys*, a purely terrestrial form, exhibits the dominant asymmetrical bronchial type, common to most members of the order, with the eparterial development confined to the right side. Its close relative, *Hydromys*, is strictly aquatic in habit, and develops a bilateral symmetrical eparterial district. The same condition is encountered in *Myopotamus*, in which a very extensive left eparterial bronchus appears in association with the equally well developed left cardiac bronchus.

These instances of left eparterial bronchial extension in some of the aquatic rodents place themselves in line with the corresponding pulmonary organization found in its full development in the pinnipedia and some cetaceans. Like these they are examples of pulmonary adaptations to specific environmental and functional conditions.

Perhaps the most significant example of the response of pulmonary architectural organization to aquatic adaptation is afforded by the lung of *Hippopotamus liberiensis* which, in contrast to all the other typical artiodactyls with right eparterial bronchus derived from the trachea, possesses a bilaterally symmetrical tree, each stembronchus furnishing an eparterial component.

We have previously referred (p. 128) to lungs in which in the phylogenetic evolution this selective modification of bronchial structure has not been active, because the descendants of a more primitive lung-type, in their adaptation to an altered environment, change only those parts of their organization which are directly affected by the new environmental conditions. If the lung is not one of the parts thus acted upon, the respiratory apparatus is not called upon to modify its structure. The pulmonary organization, both in the archeal evolutionary stage and in the later adaptations to new conditions, was, and remains, adequate for the required respiratory exchange. We found (p. 130) in this balance between lung-structure and specific environmental factors the explanation of the apparent discrepancy of the bronchial tree of *Taxidea* compared with that of the remaining Mustelidae, of the Hystricomorphs as against the rest of the rodent order, and of the atypical forms among the cetacea, if such really exist.

The factors which, on the physiological interpretation of the comparative anatomical evidence, may be regarded as determining specifically pulmonary evolution, range themselves under the following headings:

1. In its broadest lines the vertebrate lung emphasizes in its structure the effects of the enormous metabolic change which the increase of oxygenation has entailed in passing from the poikilothermal amphibians and reptiles to the homoeothermal birds and mammals. This finds its morphological expression in the neomorph development of the cranio-ventral pulmonary districts of the two higher classes, particularly in the acquisition of the eparterial system. On the other hand the higher lung-type of the more advanced reptilian forms depends largely upon the increased

elaboration of the archeal lung-stem, retaining the primitive general plan of the early pulmonary organization. The differences in the biochemical energies of the two great groups are commensurate to the changes in their respiratory tracts which are the morphological expression of these functional activities. Interpreted from the standpoint of their response to the physiological demand, the structural gap between the lungs of the two higher warm-blooded classes and those of the cold-blooded Amphibians and Reptiles is not more abrupt or pronounced than is warranted by the difference in the coefficient of their performances.

2. In estimating the influence of the environmental and functional factors which have led to pulmonary extension, especially of the cranio-ventral area, in the mammalia, a heightened ratio of respiratory metabolism forms the key-note.

In general terms the degree of bodily temperature depends upon the process of oxygenation of tissue during periods of functional activity. The large glands and the muscles are the chief sites of this catabolic combustion. The lung represents, so to speak, the chimney or flue through which the gaseous products of this combustion are removed and the gaseous elements for a renewal of metabolism are introduced. Greatly increased weight and volume of the entire body, coupled with rapid or long continued locomotion implies the use of a bulky musculature and stipulates an active and abundant respiratory exchange. The morphological response of the lung to this factor will depend on the mode, force, and rapidity of the locomotion, and especially on the duration of the required muscular effort during a given period. The homely expression 'loss of wind' signifies morphologically and functionally a pulmonary equipment which finds itself unable to take care of the accumulating waste products of long continued muscular exercise. A man is really not 'winded' but 'lunged' under these circumstances.

The influence of this functional aspect of respiration on pulmonary organization is seen in the mammalian ungulate lung, with extensive eparterial unfolding of the cranio-ventral segments. It also plays a part in the production of the pulmonary extension of the large cetacean and sirenian forms, although

here a second factor presently to be considered is chiefly responsible.

The greatly increased eparterial development of the typical avian lung depends on the high rate of tissue-combustion, as evidenced by the high bodily temperature, and on the enormous relative development of the specialized pectoral musculature with its great and long continued activity during flight. In spite of the fact that the weight and bulk of the whole body has been reduced as far as possible by special adaptations to this purpose, centred chiefly in the appendages of the respiratory tract, the remaining factor is correlated with a great cephalo-ventral extension of the lung and the establishment of the type of pulmonary organization characteristic for the class.

3. Changes in the general environment, which are associated with changes in the structure of the lung, may lead to the replacement of a slow regular respiratory rhythm by a type in which periods of exceedingly active respiration alternate with more or less prolonged intermissions during which respiratory exchange is at a stand still. This condition is the result of the adaptation of the mammalian organism in a greater or lesser degree to the aquatic habitat. Shorter or longer periods of submergence, during which respiration is suspended, are succeeded by intervals of active surface breathing. The reaction of this environmental factor on intrapulmonary organization is seen in the high degree of bilateral eparterial development in the pinnipede carnivores, sirenia and typical cetacea.

The question of the total expenditure of respiratory energy within a given period of time becomes important in its effects on pulmonary structural modifications of evolutionary character.

In the mammal the interdependence of the biochemical factors of respiration and lung-structure require analysis primarily in respect to the *rapidity* with which the gas-exchange is effected. The more extensively organized mammalian lungs indicate either a high degree of tissue-combustion at a fairly *constant rate* (Ungulate type), or a very rapid *intermittent* metabolism called for at definite periods with intervals during which respiration is suspended (aquatic adaptations).

In the latter type all the accessory modifications are in the direction of storing CO₂ until the same can be exchanged in large quantities and rapidly during the resumption of respiration (Caval sinuses of *Phoca* and *Manatus*, abdominal venous plexuses of *Macrorhinus*). The lung therefore must be so organized as to meet this intermittent demand for high efficiency, although not called upon in the intervals of respiratory suspension. The lung acquires the morphological complexity corresponding to the highest degree of efficiency which can be demanded in any given form under the normal environmental conditions.

CONCLUSION

The search for the elusive hypothetical promammalian ground-plan of bronchial architecture has terminated somewhat like the hunt for the Philosopher's Stone.

The mechanistic concept of a definite and crystallized archeal bronchial tree, from which all extant mammalian types are derived by modifications of the pattern through migration, does not exist in the commonly predicated form of a concrete and fixed morphological entity. It had no reality in any definite ancestral structure, save in the sense that the primitive reptilian lung and its phyletic derivative, the mammalian entodermal pulmonary anlage, both retain the potency of development by selection into the type demanded by the environment. In place of the mythical common ancestral bronchial tree appears a living plastic organization, responsive to the changing demands of biological evolution and replete with answers to the modern problems of morphogenetic inquiry.

BIBLIOGRAPHY

- 1 AEBY, CHR. 1878 Die Gestalt des Bronchialbaumes und die Homologie der Lungenlappen beim Menschen. *Centralbl. d. med. Wissensch.*, Nr. 16.
- 2 1880 Der Bronchialbaum der Säugethiere und des Menschen nebst Bemerkungen über den Bronchialbaum der Vögel und Reptilien. Leipzig.
- 3 BLISNIANSKAJA, GRUNIA 1904 Zur Entwicklungsgeschichte der menschlichen Lungen: Bronchialbaum, Lungenform. Diss. Zurich.
- 4 BOECKH, RUDOLF 1914 Die Entwicklung der Säugerlunge. In A. Fleischmann, *Morphogenetische Studien. I. Mammalia. Gegenbaur's Morph. Jahrb.*, 48. Bd.
- 5 BREMER, JOHN L. 1904 On the lung of the opossum. *Am. Jour. Anat.*, vol. iii, pp. 67-73.
- 6 CHIARI, H. 1889 Ueber einen neuen Typus von Missbildung an der Trachea des Menschen. *Ziegler's Beiträge z. path. Anat. u. allgem. Pathol.* 5. Bd.
- 7 1890 Ueber ein congenitales Divertikel des rechten Stammbronchus. *Prager med. Wochenschr.*, Nr. 46.
- 8 1890 Ueber das Vorkommen eines doppelten Seitenbronchus an dem rechten Stammbronchus des Menschen. *Zeitschr. f. Heilkunde*, Bd. 10, s. 470-478.
- 9 1891 Ueber eine neue Form von 'Dreitheilung der Trachea' bei einem 16 Tagen alten Knaben mit sonstigen Bildungs-Anomalien, darunter auch Mangel der Milz und Verlagerung des Ligamentum hepato-duodenale. *Prager med. Wochenschr.*, Nr. 8.
- 10 DALLA ROSA 1889 Beiträge zur Kasuistik und Morphologie der Varietäten des menschlichen Bronchialbaumes. *Wiener klin. Wochenschr.*, Jahrg. 2, Nrs. 22, 23, 24.
- 11 D'HARDIVILLER La ramification bronchique chez le lapin. *Bibliogr. Anat.* Sept.-Octobr. 1896, Janv.-Févr. 1897.
- 12 1896 Développement de la ramification bronchique et bronches épartérielles chez les Mammifères. *Soc. d. la Biologie*, 19 Décembre.
- 13 1897 Homologation des bronches chez le lapin. *Bibliogr. Anat.*, Janv.-Févr.
- 14 1897 Les bronches épartérielles chez les Mammifères et spécialement chez l'homme. *Extr. d. Comptes rendus d. l'Acad. des Sc.*, 2 Août.
- 15 1897 Origine des bronches lobaires du mouton. *Extr. d. Comptes rend. d. séances de la Soc.*, 20 Nov.
- 16 1897 Développement des bronches principales chez le mouton. *Extr. d. Comptes rendus d. séances de la Soc. d. Biol.*, 4 Décembre.
- 17 1897 Développement des bronches chez le mouton. *Extr. d. Comptes rendus des séances d. la Soc. de Biologie*, 11 Décembre.
- 18 1897 Développement et homologation des bronches principales chez les Mammifères (Lapin). Thèse, Nancy.

- 19 EWART, WILLIAM 1889 The bronchi and pulmonary bloodvessels, their anatomy and nomenclature. With a criticism of Prof. Aeby's views on the bronchial tree of mammalia and man. London.
- 20 FLEISCHMANN, A. 1914 Die Lungen der Wirbeltiere. Morphogenetische Studien. Gegenbaur's Morph. Jahrb., 48. Bd.
- 21 FLINT, J. M. 1906 The development of the lungs. Am. Journ. Anat., vol. vi.
- 22 HESSER, CARL 1905 Über die Entwicklung der Reptilienlungen. Anat. Hefte, Bd. 29, Heft 88.
- 23 HIS, W. 1880 Anatomie menschlicher Embryonen.
- 24 1887 Zur Bildungsgeschichte der Lungen beim menschlichen Embryo. Arch. f. Anat. und Phys., Anat. Abth., II. Heft.
- 25 HUNTINGTON, GEO. S. 1898 The eparterial bronchial system of the mammalia. Ann. N. Y. Acad. Sci., XI, no. 8.
- 26 1916 The significance of different and distinctive types of bronchial architecture within the same order of mammals. Anat. Rec., vol. 10, no. 3.
- 27 1917 The morphological basis for the dominant pulmonary asymmetry in the mammalia. Anat. Rec., vol. 11, no. 6.
- 28 1918 Mutation in mammalian evolution. Anat. Rec., vol. 14, no. 1.
- 29 1919 The morphology of the pulmonary artery in the mammalia. Anat. Rec., vol. 17, no. 4, December.
- 30 MOSER, FANNY 1902 Beiträge zur vergleichenden Entwicklungsgeschichte der Wirbeltierlunge. (Amphibien, Reptilien, Vögel, Säuger.) Arch. mikr. Anat. u. Entwicklungesch., 60. Band.
- 31 NARATH, ALBERT 1892 Vergleichende Anatomie des Bronchialbaumes. Anat. Anz. Ergänzungsheft. VII. Jahrg.
- 32 1896 Die Entwicklung der Lunge von *Echidna aculeata*. Semon, Zoolog. Forschungsreisen in Australien und dem Malayischen Archipel. Jena.
- 33 1901 Der Bronchialbaum der Säugethiere und des Menschen. Bibliotheca Medica, Abth. A., Heft 3. Stuttgart.
- 34 ROBINSON, ARTHUR 1889 Observations on the earlier stages in the development of the lungs of rats and mice. Jour. Anat. and Phys., vol. xxiii.
- 35 SELENKA, E. 1887 Studien über die Entwicklungsgeschichte der Thiere. Heft 1, Das Opossum. Wiesbaden.
- 36 WEBER, MAX 1886 Studien über Säugethiere. Ein Beitrag zur Frage nach dem Ursprung der Cetaceen. Jena.
- 37 WILLACH, P. 1888 Beiträge zur Entwicklung der Lunge bei Säugethieren. Osterwieck, Harz.
- 38 YOUNG, ALFRED H., AND ROBINSON, ARTHUR 1889 On the anatomy of *Hyaena striata*. Jour. Anat. and Phys., vol. xxiii.
- 39 ZUMSTEIN, J. 1889 Ueber den Bronchialbaum des Menschen und einiger Säugethiere. Sitzungsber. d. Gesellsch. z. Beförd. d. gesamt. Naturwissensch. zu Marburg, Nr. 3.

Resumen por los autores, E. A. Baumgartner, M. F. Nelsen y W.
Dock

Hospital Halstead, Halstead, Kansas, y Saint Louis, Missouri,

El desarrollo de las glándulas uterinas en la especie humana.

En el feto humano de seis a siete meses de edad la cavidad uterina presenta bordes irregularmente aserrados a expensas de los cuales se desarrollan las glándulas uterinas. Además existen proyecciones transversas de forma semilunar en las superficies anterior y posterior del útero, estando formadas estas proyecciones por divertículos de la cavidad uterina. Estas proyecciones de la cavidad uterina llevan también glándulas. Las glándulas más tempranas aparecen en forma de crecimientos redondeados, que existen ya en este periodo. Todos los ejemplares de edad más avanzada examinados por los autores presentaban glándulas más o menos desarrolladas. Las glándulas son primeramente redondeadas, dividiéndose después en ramas que pueden extenderse paralelamente a la superficie en cierto trayecto para dividirse nuevamente al mismo tiempo que se hunden en la pared uterina, estando frecuentemente colocadas estas nuevas ramas en un plano perpendicular al plano de las divisiones precedentes. Tales subdivisiones pueden tener lugar varias veces hasta que se forma una glándula completamente ramificada. En los adultos los extremos distales de las glándulas se extienden paralelamente a la superficie del epitelio, proyectándose generalmente dichas glándulas en la misma dirección. Son frecuentes las anastomosis entre diferentes glándulas.

Translation by José F. Nonidez
Carnegie Institution of Washington

DEVELOPMENT OF THE UTERINE GLANDS IN MAN

E. A. BAUMGARTNER, M. T. NELSON, AND WM. DOCK

Halstead, Kansas, and St. Louis, Missouri

SEVEN FIGURES

In his book, *A Laboratory Textbook of Embryology* ('10) Minot, in speaking of a model of the human uterine glands, said: "The model . . . demonstrates that the conception of the character of the uterine glands, which has hitherto prevailed, is very inadequate." Descriptions of the morphology of the uterine glands in the various histological textbooks vary slightly. Piersol ('10) describes them as tubular or slightly bifurcated, wavy invaginations with tortuous blind ends, distributed at fairly regular intervals. Lewis' description, based on Hedblom's model, states that they are branched tortuous glands which occasionally anastomose, and which have in their deeper portions long horizontal branches at right angles to the main tube.

In the older texts (Stricker, '73) the glands are described as simple, although occasionally they give off branched tubes from the center or just below the center. They are twisted or corkscrew-like, and in the fundus may run horizontally to the surface.

The only models of these glands, in any stage, known to us are those of Heblom's, one of which is figured in Minot's *Laboratory Textbook of Embryology*. The model figured is much more complex than the descriptions of the text-books would indicate. From sections Hitschman and Adler ('08) have described the character of the glands during the various stages of the menstrual cycle, but they give very little information other than is found in the usual texts and no additional information in regard to the glands during the interval stages. Wax models of the glands in the various stages of the cycle should

show some very interesting results, and the plan was to incorporate these results in this paper. However, lack of material prevented this at this time.

There is an even greater lack of description of the characteristics of the glands during development. Lewis states that the glands develop at the bases of folds. In Keibel and Mall's *Embryology* ('12) very little attention is given to their development and only one investigator (Wyder, '78) is quoted. This investigator states that the glands develop independently of the age of the individual.

It seems, therefore, from this brief review of the literature that very little is known of the development of the uterine glands or of their ultimate form. For that reason, the senior author suggested that this problem should yield results worthy of publication. The models were all constructed by the junior investigators.

DEVELOPMENT OF THE GLANDS

The material upon which this study is based consists of serial sections of portions of the corpora of uteri of fetuses and of adults. The youngest uterus studied was of a six- to seven-month fetus, the oldest a uterus of a twenty-five-year-old virgin. The entire fundus of the six- to seven-month fetus was sectioned and a model made of the lumen of the organ, including the epithelial lining and any outpouchings or glands. This model is shown in figure 1. An interesting particular of this stage is the peculiar S-shaped lumen with irregular sides. There are folds of the uterine mucosa from which small outpouchings protrude.

The irregular folds of the epithelium on the sides of the lumen give the effect of a scalloped edge. Rudiments of glands are present. The most prominent epithelial folds are found on the anterior and posterior surfaces and are directed toward the cervix. Only two are shown in the model. These two run almost transversely across the surface of the lumen and have the appearance of crescent-shaped, hood-like evaginations

toward the muscular coat. These folds are quite deep and are apparently constant, as they have been observed by other investigators and we have found them in older uteri. On the outer rim of these crescentic folds there are small outgrowths, which, we conclude from a study of later stages, are the rudiments of glands. The outgrowths have enlarged ends and short, constricted necks. Occasionally these structures are found also at the edge of the uterine lumen, but are found nowhere except in these two places.

In a one-day-old child, the glands, developing from the folds of the mucosa, sometimes form a row (fig. 2). The stalks of the glands are constricted with closely crowded, enlarged, flattened end pieces.

There is only slight modification of this shape in a seven-month-old child uterus (fig. 3). The side of the uterine lumen was chosen for reconstruction. This specimen showed, as did several others, a lumen which in transverse section was boot-shaped. Glands grow from the ends of the heel and toe parts, as well as from lesser folds. Some of the glands have developed into a T-shape with the original short constricted neck, but with an enlarged tubular end extending at right angles to the stalk. In some only one arm has developed, forming an inverted L-shape. In both the T and L glands, the end piece sometimes has longitudinal furrows, showing partial separation of the end piece into two parallel tubular branches.

A model of a four-year-old specimen shows several of the features mentioned above. The crescentic folds of epithelium described in a six-month fetus are present here (fig. 4). At their outer rims are folds of well-developed glands. The T-shaped glands prevail and occasionally the tubular end pieces have divided, forming parallel tubular branches. Some glands, however, are very simple, being small evaginations with occasionally constricted necks.

Several changes have taken place in the uterine glands of a fourteen-year-old child before puberty. These are evidenced by the further division of the T- and L-shaped glands. Some glands are still simple, showing short narrow stalks and two

tubular end pieces extending obliquely into the mucosa (fig. 5). One gland shows the two tubular branches running parallel to the surface of the lumen, as described above, with one end piece turning toward the muscular layer almost at right angles, and sending out two branches, one from each side, then dividing into two parallel tubular end pieces.

Another gland is very much more complex. After the formation of the T-shape, one of the arms of the T turns sharply and divides, forming a Y-shape. One of the arms of the Y divides again, whereas the other arm, which is larger, gives off three pairs of branches and terminates in a cluster of five branches. The branching is decussate. Of the terminal cluster one short central terminus appears to be the continuation of the main stalk. The terminations usually point toward the muscle layer and show enlargements.

Owing to a lack of material, we have been unable to model or describe the stages between a fourteen-year-old before puberty and the twenty-five-year-old nullipara of the interval stage. Of the latter, an area of attachment of about twenty-five glands, about 1 mm. by 1.5 mm., was modeled, which area includes one hundred and fifty sections $10\ \mu$ in thickness. Some of the glands are grouped, four glands coming from one slight furrow in the mucosa (fig. 7). The others are all more or less isolated, but in quite definite rows. In studying the portions of the glands which lie next to the musculature, one is impressed with the fact that the glands give the appearance of running parallel to the surface of the lumen, and all in the same direction, and that the great preponderance of glandular tissue is in the outer third or half of the endometrium. The constricted necks of the glands are short, the stalks gradually enlarging as they extend obliquely toward the musculature. Some glands show constricted areas at intervals, others present a slightly spiral appearance, but only few show any branches until they are deep into the mucosa, when they all turn, more or less gradually into a direction at right angles to the one which they have just been following—a course nearly parallel with the surface of the lumen.

The mode of termination varies a great deal. One gland forms the familiar T-shape, the cross-bar being tubular and short. Another sends off a lateral branch which immediately divides dichotomously, each branch again dividing, one of the latter branches extending back two-thirds of the distance toward the epithelial surface, terminating in an enlarged end. A third gland, after turning at right angles to the surface, breaks up into two parallel tubes, one subdividing, the other anastomosing with a parallel end piece of another gland.

Some are even more complex in their branchings and divisions (fig. 7) approaching the complex type described for the fourteen-year-old, except that the branches are found more deeply embedded in the mucosa and in general run parallel to the surface at their terminations. Only one single tubular gland is present and it runs parallel to the surface at its distal end.

The models show that anastomosing between glands and between branches of glands is not uncommon. Two simple glands anastomose then divide into several branches (fig. 6). Again, two rather widely separated glands anastomose, then divide into a complex set of branches which extend for some distance along the muscle layer.

DISCUSSION

Guyon ('58) and de Sinéty ('79) found no glands, properly speaking, in the corpus of the fetal uterus, although they found well-developed ones in the cervix. De Sinéty states that glands are not developed until the sixth or seventh year. Wyder ('78), who is quoted in Keibel and Mall's Embryology, found no glands in the uteri of ten-year-old girls, and contends that the stages of development bear no relation to age. Tourneux and Legay ('84) found glands in the cervix of a late fetus, but none in the corpus, even at birth. Möricki ('82) described glands in the cervix of fetal uteri. In a premature of nine months, he found well-developed glands, with branches, in the corpus and in a new-born he found many glands in the fundus. The glands varied in form, but were usually tubular with relative

large lumina. In adults the glands forked near their ends. Nagel ('91) found that the glands of the corpus developed much later than those of the cervix, although he figured glands in the corpus of a 17-cm. fetus. Wyder appears to have been about the only one who did not find glands in the corpus at birth and is the only one who has stated that the development of the glands is entirely independent of age.

The peculiarly shaped lumen of the uterus of the fetuses and young adults has been noted by other investigators and is apparently constantly present. No explanation of this peculiarity has been offered. The theory that it may be due to the union of the early Müllerian ducts is worthy of consideration.

In all of the specimens upon which this study is based, glands or rudiments of glands are found, from the six-month fetus onward. In the six-month fetus they are present as small outpouchings from the folds of epithelium. Contrary to the findings of Möricke, our specimen of new-born shows glands, often closely crowded, without branches and not as yet tubular, but rather having the appearance of simple outgrowths with enlarged flattened end pieces and slightly constricted stalks. This shape is typical of early stages of uterine glands as well as of the early stages in the development of many other glands. The tubular shape and T-shaped branches appear in the first year, however.

The glands increase in length and in number of branches during the early years of life, although the growth is not extreme, and the stages from one to seven years show no marked differentiation. The T-shaped branches and the growth from the ends of the folds of the mucosa are constant characteristics.

Just before puberty, glandular growth seems markedly hastened, although the mucosa may not be much thicker. Of the glands modeled many have T-shaped branchings. Further branchings and subdivisions, beyond the T-shape, are first observed at this time. Some of the glands are closely crowded as in younger stages. The tubular shape is constant, although enlarged ends and irregular enlargements of the stalk are found. The short, constricted necks are here present.

In adults, glands with many branches near their ends, as described by Möricki, have been noted. The narrow, short necks are prominent. The branching gives the effect of a network of tubular glands running parallel to the surface just inside the muscle layer. Anastomoses between different glands are found. Both isolated and grouped glands are common.

The particular feature of the adult glands which has emphasized itself in our minds is that the majority of the glands run parallel to the surface near the muscle layer, and run also in one direction. We do not believe, but cannot deny, that the latter is due to the contraction of the muscular layer. We have not determined what may be the meaning of this running in one direction, nor, unfortunately, can we tell whether this direction is toward the fundus or toward the os uteri.

It has been suggested that the branches which we describe as returning toward the epithelial surface are individual glands which have lost their connection with the surface following menstruation. Hedblom's model of an eighteen-year-old stage shows these structures. However, ours have enlarged ends and have the appearance of terminations similar to glands of whose terminations, deep in the stroma, there is no question.

The tendency for several glands to open side by side in a common furrow or depression of the uterine epithelium has been mentioned.

It will be seen, from the foregoing, that the adult glands are not simple straight tubular glands as the text-books imply, but are branched tubular glands with frequent anastomoses. Our conception of the adult glands forces us to agree with Minot's statement, above quoted, and in general with that of Hedblom as illustrated in his models.

The senior author recently had the opportunity of seeing the series of models made by C. A. Hedblom¹ at the Harvard Medical School. One of these is figured in Minot's text and is described by Lewis in the last edition of his *Histology*. The series consists

¹We are under obligations to Drs. J. L. Brewer and C. A. Hedblom for permission to make comparisons between our models and those of the latter, now in the department of Anatomy at the Harvard Medical School.

of an eight-month child, a ten-year child, an eighteen-year nullipara, and of an eighty-two-year-old multiparous woman. The youngest shows irregular folds with small outpocketings. The folds, we believe are mucosal folds such as we have found in our specimens. The glandular rudiments are very small in comparison with those of our specimen of a day old, and really appear in shape much more like the glands of our six-month fetus. The ten-year-old specimen shows small, irregular, short tubular outgrowths with some anastomoses and irregular folds. Here the type does not correspond at all to any of our specimens. The branchings are few and dissimilar to those found by us. The short slender tubular glands here also appear more like small outgrowths found in our six-month fetus.

The eighteen-year-old specimen fits well into our series between the fourteen- and the twenty-five-year-old stages. The short narrow stalk and T-like divisions which we describe are not found, but instead a Y-like branching from a longer stalk. One arm of the Y has one or two Y-like subdivisions, whereas the other arm sends off many irregular single branches which further subdivide. Several branches extend for some distance toward the muscular coat, and one gives off a branch which returns one-third of the distance to the uterine lumen, then turns sharply and returns in its original direction. Many terminal branches have enlarged ends similar to those we have found. Anastomoses with other glands are present.

The eighty-two-year-old specimen is a quite remarkable one. Many cystic tubules are found at the ends of short, narrow tubules. Anastomoses between these cysts by means of small tubules are found. The cystic enlargements are elongated oval structures and are found closely crowded and near the surface epithelium. As is well known, the mucosa is thin and the entire depth of the gland is only about one-third that of our adult specimen and even less than that of the eighteen-year-old model of Hedblom.

The work of Scammon reported at the meeting of the American Association of Anatomists ('19) shows that some interesting phases may have been overlooked. It is extremely important

and would be valuable to have models of the various stages from birth to three months of age, instead of only at birth. Then, corresponding to the periods of growth, as indicated by lengths of the uterus, models of the sixth year and again about the eleventh would be desirable. The models of seven months and of four years as indicated are quite similar. A specimen from a seven-year-old child shows rather poorly developed glands—certainly not much beyond the four-year stage—while a model of a twenty-one-month child is very similar to the one of seven months.

It cannot be denied, therefore, that it would be interesting to reconstruct more of the stages of the glands between four and fourteen years as well as during the menstrual period, the menopause, and of a parous woman, and that these stages should be included in this paper. Unfortunately, we have not found the material available.

CONCLUSIONS

1. Glands are found in the corpus of the uterus in a six- to seven-month fetus and in all material studied beyond this age.

2. The earliest glands are small irregular outpouchings from semilunar mucosal folds, later developing constricted necks and enlarged end pieces similar to many other gland rudiments.

3. The necks persist even to the adult stage, the enlarged ends becoming tubular and dividing T-like with sometimes a second longitudinal division of the end branches.

4. The stalks follow an oblique course in the adult, sometimes almost a spiral one.

5. Near the muscle layer the branches run parallel to the surface and all in one direction, sometimes forming a network by anastomoses of different branches.

6. The greater part of the glandular tissue lies in the lower one-third or fourth of the endometrium.

7. Adult uterine glands are compound, anastomosing, tubular glands.

LITERATURE CITED

- CADIAT, O. 1884 Mémoire sur l'uterus et les trompes. Jour. de l'Anat. et de la Phys., T. 37.
- GUYON, H. 1858 Étude sur les cavités de l'uterus à l'état de vacuité. Paris (Quoted from Tourneux et Legay).
- HITSCHMAN, F., UND ADLER, L. 1907 Die Lehre von der Endometritis. Zeitsch. f. Geburtsh. u. Gyn., Bd. 60.
- LEWIS, F. T., AND STÖHR, PH. 1914 A textbook of histology. Blakiston, Phila.
- MINOT, C. S. 1910 A laboratory textbook of embryology. P. Blackston's Son Co., Phila.
- MÖRICKI, R. 1882 Die Uterusschleimhaut in den verschiedenen Altersperioden und zur Zeit der Menstruation. Arch. f. Geburtsh. und. Gyn.
- NAGEL, W. 1891 Ueber die Entwicklung des Uterus und der Vagina beim Menschen. Arch. f. mikr. Anat., Bd. 37.
- SCAMMON, R. E. 1919 Studies in the growth of the uterus. Anat. Rec.
- DE SINÉTY 1879 Traité de gynécologie.
- TOURNEUX, F., ET LEGAY, CH. 1884 Mémoire sur le developpement de l'uterus et du vagin. Jour. l'Anat. et de la Phys., T. 37.
- WYDER, A. T. 1878 Beiträge zur normalen und pathologischen Histologie der menschlichen Uterusschleimhaut. Arch. f. Gynäk., Bd. 13.

PLATES

PLATE 1

DESCRIPTION OF FIGURES

Fig. 1 Reconstruction of a part of the uterine lumen and epithelium of a six to seven-month-old fetus.

Fig. 2 Model of a portion of the lateral wall of the uterine epithelium and glands of a day-old child.

Fig. 3 Model of the glands near the lateral edge of the uterus of a twenty-one-month-old child.

Fig. 4 Wax reconstruction of an epithelial outpouching with its glands from near the lateral edge of the uterus of a four-year-old child.

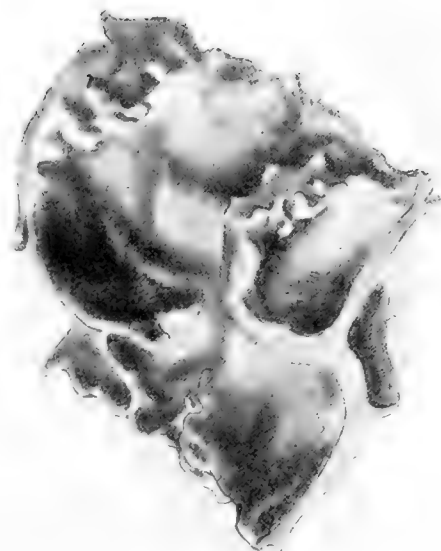

1

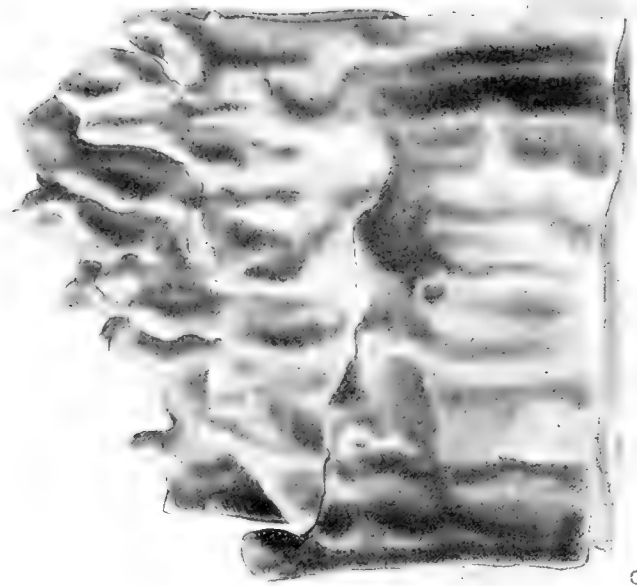

2



4



3

PLATE 2

DESCRIPTION OF FIGURES

Fig. 5 Model showing types of glands found in a fourteen-year-old child uterus.

Fig. 6 Model of two uterine glands of a twenty-five-year-old nulliparous woman during the interval period, showing anastomoses of the glands and characteristic terminations.

DEVELOPMENT OF UTERINE GLANDS
E. A. BAUMGARTNER, M. T. NELSON, AND WM. DOCK

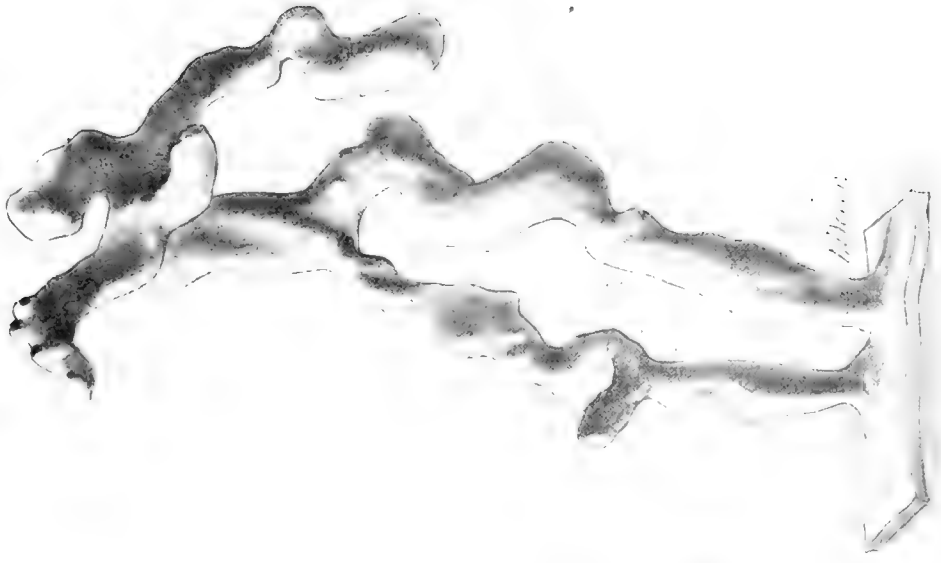

6

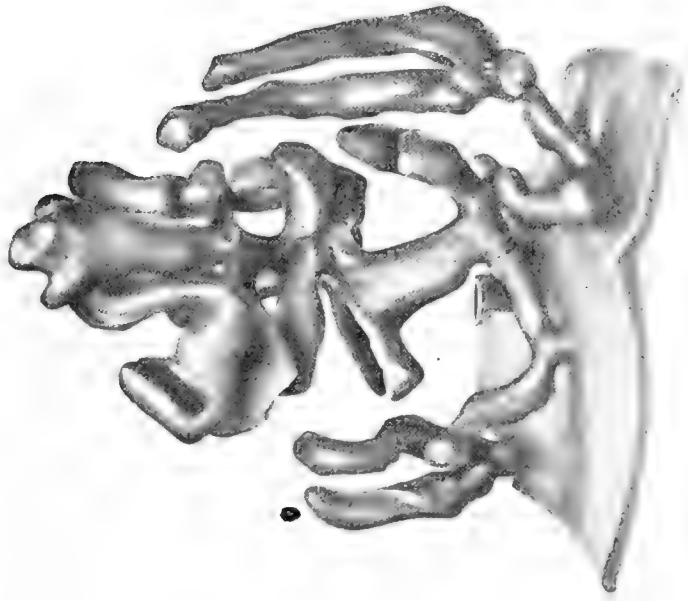

5

PLATE 3

DESCRIPTION OF FIGURES

Fig. 7. Model of several glands of a twenty-five-year-old nulliparous woman during the interval period of the menstrual cycle. The light colored part is all one gland which anastomoses with another back of the dark colored stalks.

DEVELOPMENT OF UTERINE GLANDS
E. A. BAUMGARTNER, M. T. NELSON, AND WM. DOCK

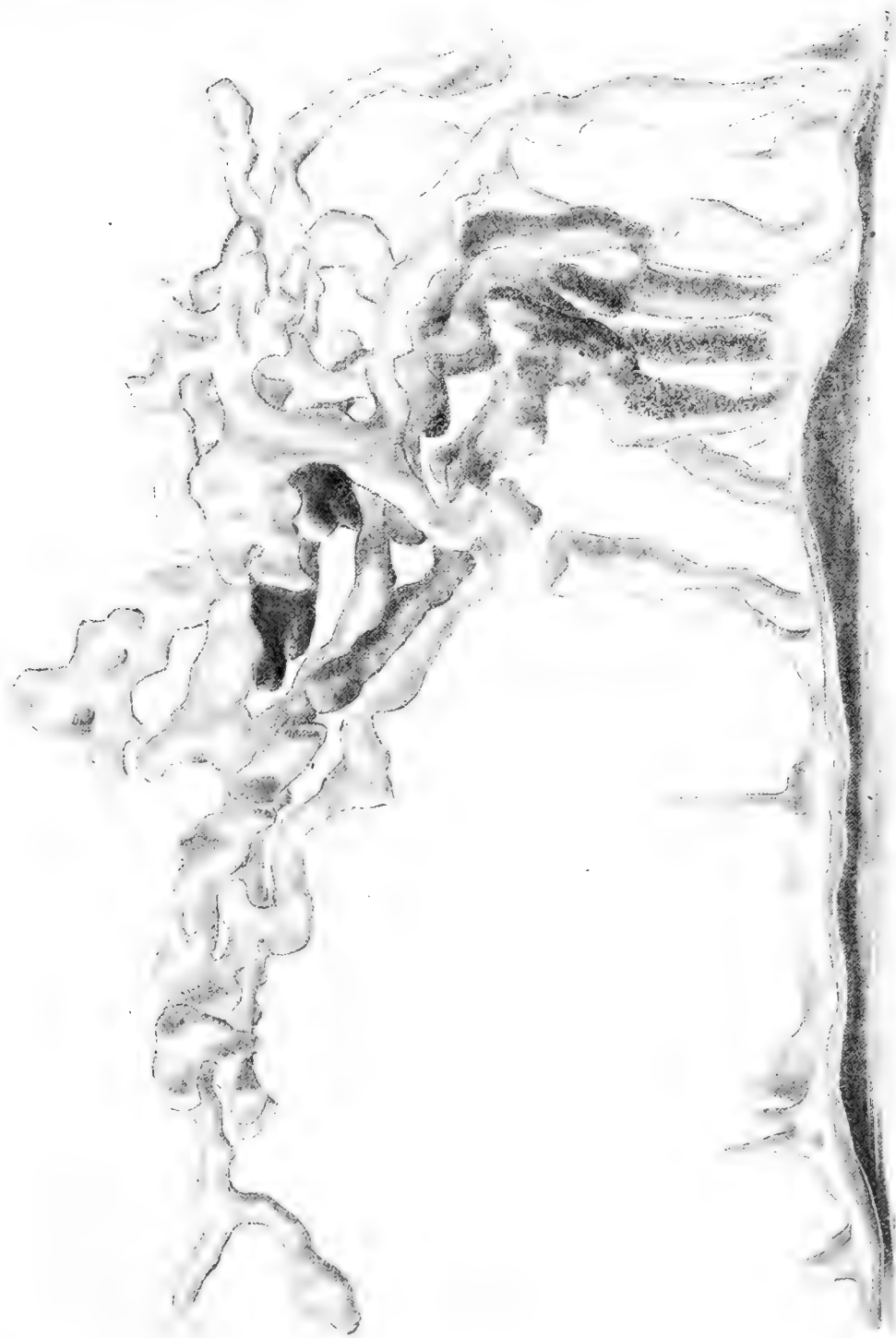

7

Resumen por los autores, Eliot R. Clark y Eleanor Linton Clark.

La reacción de las células de la cola del renacuajo hacia la inyección de aceite de croton, en el animal vivo.

Los autores han inyectado glóbulos microscópicos de aceite de croton diluido en aceite de parafina, en la expansión caudal de larvas de *Hyla*, observando en el animal vivo la "inflamación aséptica" resultante. El punto estudiado especialmente es la cuestión de sí, durante la inflamación, las células de tipo definido permanecen como elementos específicos o si se transforman en otros tipos celulares. Primeramente se obtuvo una idea general de los procesos que tienen lugar, estudiándose después cuidadosamente los diferentes tipos de células. Se ha observado que los leucocitos y células emigrantes del tejido caminan hacia el aceite de croton, pero no llegan a ponerse en contacto con él, permaneciendo a una corta distancia y haciéndose estacionarios al mismo tiempo que producen en su superficie apéndices puntiagudos que les asemejan a las células pequeñas del tejido conjuntivo. Sin embargo, no se transforman en células conjuntivas. Por el contrario, mas tarde se hacen esféricos y después de varias horas o aun días, vuelven a presentar su actividad amiboide y emigran, habiendo sido eliminado el aceite durante este tiempo. Las células conjuntivas cercanas a las gotas de aceite se transforman en elementos granulares, se hinchan y llenan de vacuolas y algunas de ellas mueren. La mayor parte de ellas sanan después de la eliminación del aceite y vuelven a adquirir la facultad de moverse. Los capilares sanguíneos presentan vacuolización endotelial y retracción, a las que sigue nuevo crecimiento. El endotelio linfático se comporta de un modo semejante. Todos los tipos celulares permanecen específicos. Las células emigrantes no se forman a expensas del endotelio o de las células conjuntivas, ni tampoco originan ninguno de estos tejidos. Las células conjuntivas y los endotelios sanguíneo y linfático también se conservan específicos, y ni se convierten en otros tipos celulares ni se derivan de ellos.

Translation by José F. Nonidez
Carnegie Institution of Washington

REACTIONS OF CELLS IN THE TAIL OF AMPHIBIAN
LARVAE TO INJECTED CROTON OIL
(ASEPTIC INFLAMMATION)

ELIOT R. CLARK AND ELEANOR LINTON CLARK

Department of Anatomy, University of Missouri

FIFTEEN FIGURES

INTRODUCTION

For a number of years the authors have been engaged in a study of the growth and reactive power of connective-tissue cells, wandering cells, and of blood-vessels and lymphatic endothelium. These cells and tissues are conceded by most investigators to have a common origin ultimately in a primitive mesenchyme cell, but there is no such unanimity of opinion as to the manner in which they differentiate, and there has been a great deal of controversy in regard to the degree to which they become specific in the adult organism. In former studies of the normal growth of these cells and tissues and of their reaction to injected substances, such as paraffin oil, carbon granules, olive oil, yolk of egg, etc., in the transparent tails of living Amphibian larvae, we found that the individual cells and tissues remained specific in their growth and in their response toward outside stimuli (E. R. Clark, '09, '12, '16; E. R. and E. L. Clark, '17). The question of the specificity of tissues has been raised most frequently, with respect to this very group of cells and especially during the process of inflammation in which they play such a prominent rôle. We therefore decided to produce a micro-inflammation in the transparent fin of an Amphibian larva and to study the reaction of these different cells and tissues toward an injurious agent by continuous observation of the living.

Hyla larvae were used almost exclusively in these studies. These diminutive tadpoles have very few pigment cells and their

connective-tissue cells are fewer in number than in the larvae of frogs and toads. They are therefore wonderfully transparent and the individual cells may be followed readily. As was previously mentioned (E. R. Clark, '12), this form is much easier to anaesthetize than the larger larvae of the Anura, it responds more quickly to chloretone and remains motionless for longer periods without deleterious effects on the circulation.

The irritating substance selected for these experiments was croton oil. The undiluted oil was injected in a few larvae, but, in the majority of cases, 10 per cent croton oil (made of one part croton oil to nine parts paraffin oil) was employed. The mixture was sterilized before injection.

The tadpoles were anaesthetized in chloretone 1 to 3000, made up in pond water. Under the binocular microscope, small globules of croton oil were injected into the fin by means of small glass cannulae. The larvae were then transferred immediately to the observation chamber, previously described (E. R. Clark, '12) and examined under the compound microscope in 1 to 4000 chloretone. With the microscope tube horizontal and a drawing-board placed beneath, at an angle of 45 degrees, and the use of a Leitz drawing eye-piece (no. 112), it was possible to make consecutive sketches of individual cells and to record the changes which occurred. In some cases, the region was watched and frequent records made over periods of six to twelve hours, after which the larvae were returned to fresh water overnight, and the region again observed on the following day. In other cases, especially where it was desirable to follow individual rapidly moving and changing cells, the region was kept under continuous observation for twenty-four hours or more.

The cells and tissues present in the transparent fin, before the production of an injury, are the following:

1. Stellate connective-tissue cells.
2. Wandering cells: *a*) pigmented; *b*) non-pigmented.
3. Blood capillaries lined with a single layer of endothelium.
4. Lymphatic capillaries, also lined with endothelium.
5. Blood-cells—red blood-cells and leucocytes inside the vessels.

6. Stationary pigment cells.
7. Nerve cells.
8. Epidermal cells, covering the surface of the fin.

Of these cells, the connective-tissue cells, the wandering cells (including migrated leucocytes), and the endothelial cells lining the blood-vessels and lymphatics were the ones observed particularly. These are the cells which had formerly been studied in the normal larvae and in the experiments in which various foreign substances had been injected into the fin. The character, behavior, and growth of the blood-vessels and lymphatics in the normal tail have been described in detail in earlier papers. The normal growth of connective-tissue cells has also been studied intensively (E. R. Clark, '12). During the course of the present study records were also made of the wandering cells of the tissues in normal uninjured larvae. Consecutive records of these cells showed that they are constantly moving through the tissues, wandering around between the connective-tissue cells and coming back again to their starting-point. Each cell seems to have a more or less definite route of its own.

The blood-cells of Amphibia have been described by Maximow ('10) and by Friedsohn ('10). The latter divides the leucocytes into the following classes:

- a. Leucocytes without granules.
 1. Small leucocytes.
 2. Large leucocytes.
 3. Polymorphonuclear leucocytes.
 4. Small oval cells with oval nuclei.
(spindle cells).
- b. Leucocytes with granules.
 1. Eosinophile leucocytes.
 2. Mast leucocytes (basophile).
 3. Pigment leucocytes (not present in mammals).

GENERAL PICTURE OF THE REACTION TO CROTON OIL

Immediately after the injection of a small globule of croton oil, a decided change was noticeable in the fin near the site of injury. The whole region became more opaque than other portions of the tail. This opacity is due to a granular appearance of the epidermal cells and connective-tissue cells of the neighborhood. Higher magnification shows that their 'granular' appearance is caused by the formation of vacuoles in the cells. An opaque 'granular' zone extends for a distance around the globule. This zone is wider proximally, toward the muscle, than it is in the region distally between the globule and the fin margin, evidently corresponding to the direction of flow of the currents of fluid in the tissue spaces. The processes of the connective-tissue cells in this zone are drawn in, the cell bodies become swollen and vacuolated, and the nuclei become visible. The endothelial cells of the lymphatic capillaries within this zone also become swollen and vacuolated and their nuclei show up plainly.

Fifteen or twenty minutes after the injection a distortion of the fin at the injured region may be observed. Most frequently this takes the form of a bend or fold in the fin. At other times, particularly with the stronger concentrations of croton oil, a blister forms around the globule, which usually disappears within a few hours.

In the main longitudinal blood-vessels of the tail and in the larger vessels situated near the muscle edge, the circulatory changes, described by early observers of inflammation, can be followed—the increased blood flow, followed after a half hour or more by a slowing of the current and a tendency of the leucocytes to stick to the vessel wall. In the capillary loops of the fin these changes are not so evident, owing to the narrowness of the vessels which permits the passage of only one corpuscle at a time. In such a capillary within the 'granular area,' the circulation usually ceases within an hour or two after the injection of croton oil. Wandering cells in the neighborhood are attracted toward the injected substance.

An hour after the injection, the diapedesis of leucocytes has commenced and continues for as long a time as the croton oil remains in the fin. The leucocytes come through the walls of blood-vessels situated outside the granular area. They make their way rapidly through the tissue spaces toward the croton oil, moving past many of the vacuolated mesenchyme cells. However, these leucocytes do not reach the globule, but instead they become stationary at a short distance from the croton oil. Here they send out numerous fine processes until they appear to be covered with spicules and resemble sea-urchins. New leucocytes approach, and they, too, become stationary and send out processes until a thicket of such cells is formed (figs. 1 and 2). The fine processes change shape rapidly at first, but after an hour or two they become more stable, larger, and fewer in number, and the migrated leucocytes then resemble small connective-tissue cells (fig. 6).

Outside this newly formed wall of sessile leucocytes, the connective-tissue cells and endothelial cells, which had possessed the opaque granular appearance characteristic of injury, become clear again and regain their normal contours and refractivity. From now on the new leucocytes which approach the area of inflammation move in nearer to the globule before becoming stationary.

In the meantime, numbers of the large leucocytes containing brown pigment have arrived on the scene, and these cells, apparently a more resistant type than the ordinary clear leucocytes, move in very close to the oil globule, even flattening out on its surface.

The epidermal cells, directly over the globule, become heaped up. This apparent increase in the epidermal cells is due to the drawing together of cells of the vicinity rather than to a proliferation.

The clear leucocytes continue to migrate into the region, to become stationary, and to send out processes. By this means, the area involved in the inflammation becomes more and more circumscribed. The globule finally shifts its position toward the surface of the fin, probably owing to the accumulation of

fluid, and is finally excluded. The heap of epidermal cells covering the globule is apparently thrown off at the same time.

As soon as the globule is extruded, the connective-tissue cells recover their normal shape and the circulation in the blood-vessels of the injured region is restored. The stationary leu-



Figs. 1 to 5 A series of sketches showing the general pictures of an inflammation produced by injecting a drop of croton oil (10 per cent in paraffin oil) into the dorsal fin of a *Hyla* larva. The connective-tissue cells are shown in solid black, the pigmented leucocytes are dotted, and wandering cells in outline. \times 133.

Fig. 1 Sketch started May 30th at 10:50 A.M., immediately after the injection of croton oil. The broken line indicates the extent of the injured area as evidenced by the granulation of the connective-tissue cells. The paths of some of the migrating leucocytes are indicated by dotted lines and arrows. X marks the location of a sessile leucocyte at 12:15 P.M. *Lym.*, lymphatic capillary; *B.V.*, blood-vessel; *O.G.*, oil globule.

cocytes, which had assumed the form of small connective-tissue cells, now draw in their processes and resume their normal amoeboid shape. However, within an hour or two, all of the leucocytes of the region have become motionless again, but with a spherical form (fig. 3).

Within a few hours after the extrusion of the globule of croton oil, the opaque area which had occupied the region of the croton oil begins to clear up. The pigmented leucocytes, which had crowded in close to the croton oil, now scatter in all directions and wander wildly and rapidly through the tissue spaces away from the region. After this scattering of the pigmented leucocytes, the area once occupied by the croton oil, is very thin,

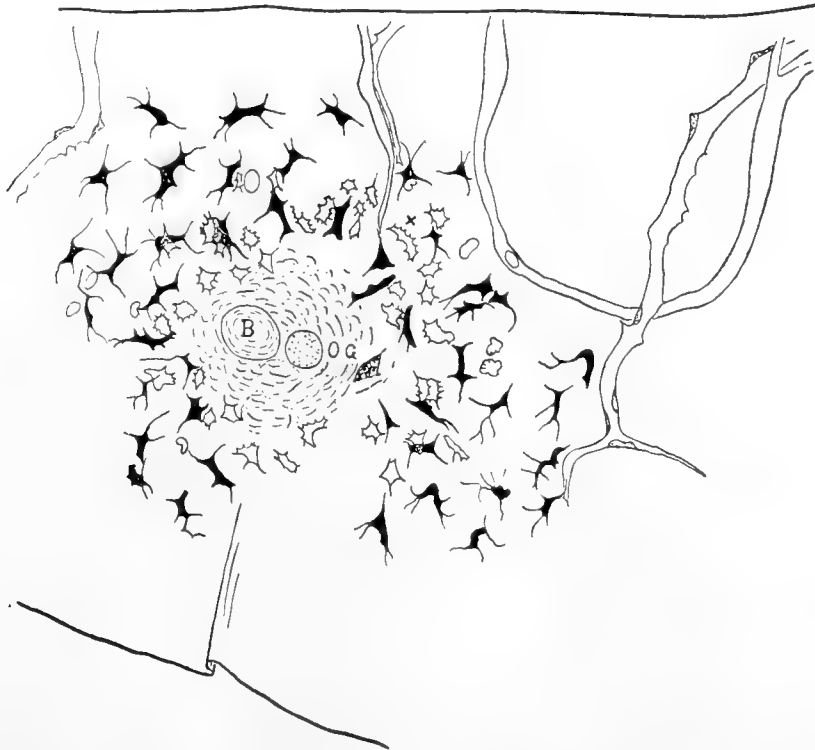

Fig. 2 Sketch of the same region as in figure 1, begun at 12:30 P.M., May 30th, showing the wall of leucocytes, with processes, which has formed at a short distance from the oil globule.

and there may even be a hole through the tail at this point. However, a small opaque clump, consisting of cell debris surrounded by pigmented leucocytes, remains in the fin and is not disposed of for several days.

During the first twelve hours or more after the extrusion of the croton oil the clear leucocytes in this part of the fin remain motionless and spherical. During this period new leucocytes were seen to come out from the blood-vessels and to approach the site of injury. However, when they reached the region

occupied by the other leucocytes, they too became round and motionless like the others.

Soon after the extrusion of the oil globule, the connective-tissue cells on the border of this torn area have all recovered their normal stellate form and refractile appearance. They begin to change shape and to wander in toward the injured area. During this stage the processes of all the mesenchyme cells of

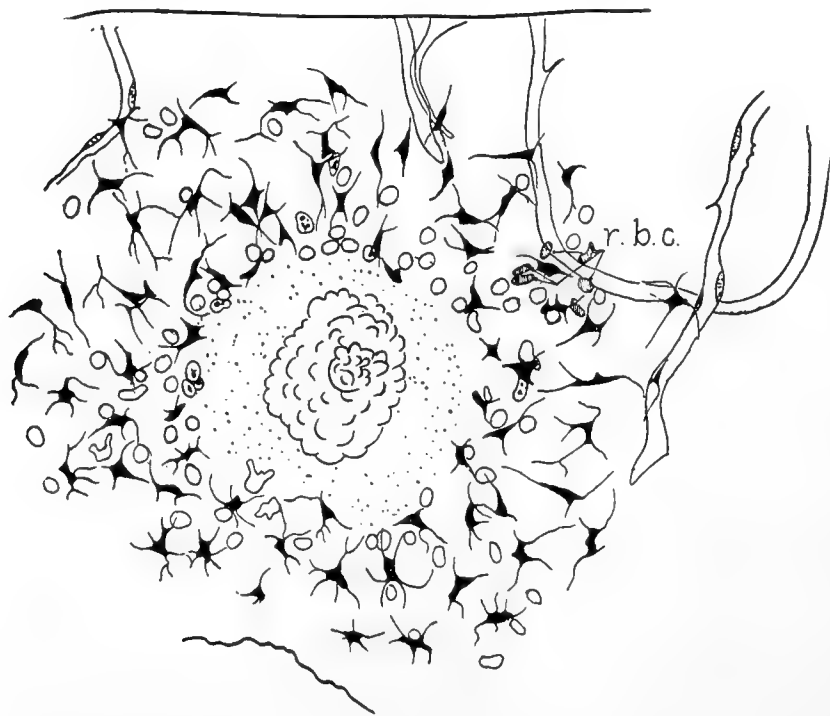

Fig. 3 Sketch of the same region at 6:30 P.M., May 30th. The oil globule was extruded at 3:20 P. M. A mass of opaque material is present at the site of injection. The leucocytes have all withdrawn their processes and become spherical. Several red blood-cells (*r.b.c.*) have escaped from the blood-vessel at the right of the field.

the vicinity radiate toward the site of injury. During the succeeding day the connective-tissue cells continue to move in and fill up the gap in the tissue left by the extrusion of the croton oil.

The final repair of the injury and return of the fin to normal consumes several days. Figures 4 and 5 show successive stages in this process. With the exception of one or two connective-tissue cells, which showed an extreme degree of injury and which

finally perished, and also of the epidermal cells which were lost at the time when the globule was extruded, there was no disintegration of cells in the inflamed area. The mesenchyme cells recovered completely. The leucocytes, after remaining for twelve hours or more in the motionless and rounded condition, gradually migrated away from the region. Some of them

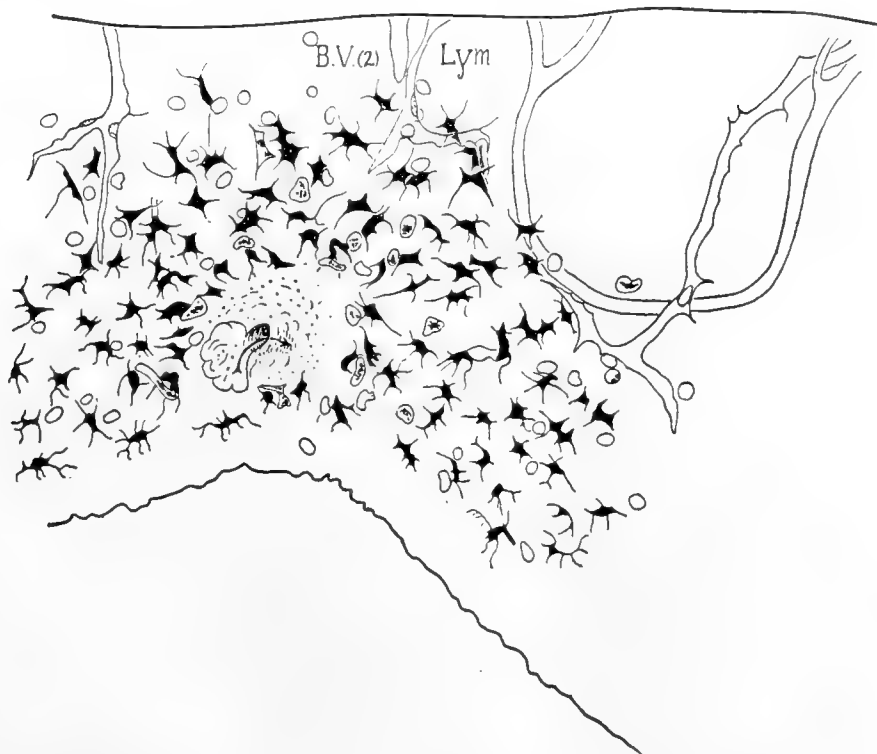

Fig. 4 Sketch of the same region made June 1st, two days after the injection of croton oil. The opaque mass is much smaller and has shifted nearer to the fin margin. A number of clear leucocytes are scattered through this region. Several pigmented leucocytes are present, most of which have wandered out from the opaque mass at the site of injury.

wandered off through the tissues, others entered blood-vessels or lymphatics. Two days after the injury, a number of these rounded leucocytes were still present in the region, and even after five days their number still exceeded that of the wandering cells present in adjoining regions.

The small mass of debris remaining after the extrusion of the globule gradually diminishes in size and, at the same time, it is forced nearer and nearer the fin margin. During this process it is surrounded by some pigmented leucocytes, which appear to

ingest it. A week after the production of such an injury, the only signs of reaction remaining are a slight irregularity in the edge of the fin, the radiation of the processes of near-by connective-tissue cells toward this defect, and the presence of more than the usual number of pigmented leucocytes (fig. 5).



Fig. 5 Same region one week after the injection of croton oil. The injury is almost repaired, only a slight irregularity in the edge of the fin is noticeable, toward which the processes of the connective-tissue cells radiate. A slightly greater number of wandering cells than in adjoining regions is still present.

The general picture of a micro-inflammation, illustrated in figures 1 to 5, was obtained by watching the same field without interruption for twenty-four hours or more after the injection of a globule of croton oil. During the succeeding days, the region was observed once or twice daily and a record made. In other specimens, a certain type of cell or tissue was selected and watched intensively during the course of the inflammation. These will be described separately.

LEUCOCYTES

1. *Clear leucocytes*

This is a large group of cells, which includes wandering cells of the tissues and the leucocytes which migrate from the blood-vessels and lymphatics, without regard to their staining reactions. Such cells were included in one group in the present study for the reason that, in the living animal, their morphological characteristics are the same, as is also their behavior toward the croton oil.

All wandering cells in the vicinity of the injected globule make their way toward the croton oil soon after the injection. At the end of an hour, the leucocytes in the blood-vessels just outside the 'granular zone' become adherent to the walls of the vessels and move directly toward the site of injury. This movement and the change in shape of these migrating leucocytes take place so rapidly that it is necessary to follow individual cells continuously. In some cases, leucocytes which had already migrated from blood-vessels were observed to crawl from the tissue into a lymphatic capillary and then to proceed rapidly down toward the tip by amoeboid movement. On reaching the tip of the lymphatic capillary, the leucocytes were seen to crawl out through the wall again. This observation was repeated several times in different larvae and in some cases several leucocytes in succession were observed to follow each other into a lymphatic, down to the tip and out again. By this means, the leucocytes reached the site of injury by a much more direct and speedy route, since they were not forced to make their way in and out among the fine processes of the connective tissue cells (fig. 14).

Figures 1 and 2 give the general picture of the migration of the leucocytes and the formation of a ring of sessile leucocytes with processes at a short distance from the globule. In some specimens individual cells were watched consecutively for a number of hours. The series of sketches in figure 6 shows the changes which occur in a leucocyte which has migrated from a blood-vessel and has become stationary after approaching within

a short distance of the croton oil. The first processes sent out are fine and hair-like. These streamers are withdrawn and sent out again, thus changing the contour of the cell frequently. After a few hours these processes become reduced in number,

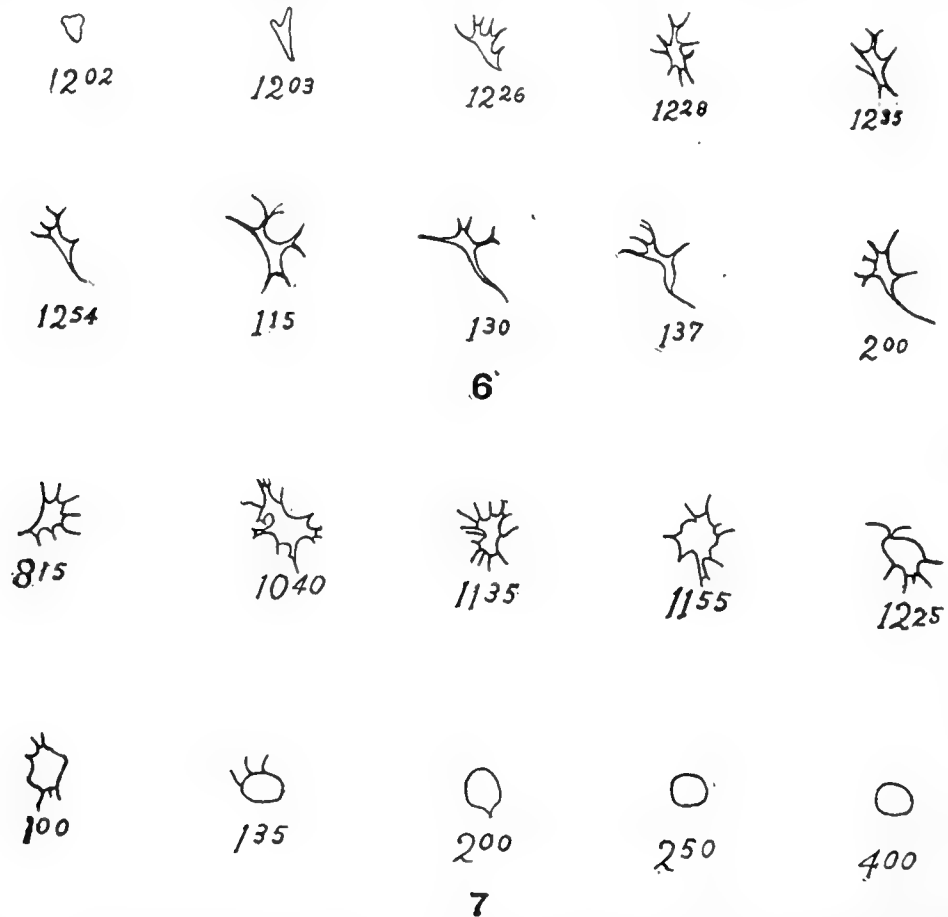

Fig. 6 Series showing changes in a single leucocyte which has emigrated from a blood-vessel and become stationary near the site of injection. 21×3 .

Fig. 7 Series showing the changes undergone by a sessile leucocyte, situated near the injected site, for a time before and after the extrusion of the croton oil. At 11:45 the oil globule was very superficial and the connective-tissue cells of the region had begun to show signs of recovery. At 1:25 many of the nearby leucocytes were amoeboid. At 2:30 all the clear leucocytes had rounded up. The pigmented leucocytes were wandering around actively. The connective-tissue cells were changing and moving toward the site of injury. At 4:00 the clear leucocytes of the region were still motionless and spherical. $\times 133$.

larger, and more stable, and the cell then resembles a small immature connective-tissue cell.

Metchnikoff ('93), in his account of inflammation in the tadpole's tail following a burn with silver nitrate, described the

transformation of polymorphonuclear leucocytes into connective-tissue cells. His description of this process and his illustrations show clearly that he was dealing with the same phenomenon described here, although croton oil is apparently a much more powerful irritant than silver nitrate, since the leucocytes migrated in much greater numbers in our experiments. In our first observations of the reaction to croton oil, we studied the region intensively for six or eight hours after injection of the irritant, returning the specimen to fresh water overnight. And, in this case, we followed many individual leucocytes from the blood-vessels during their wanderings through the tissue and through the stages illustrated in figure 6, and we were practically convinced that leucocytes may become transformed into connective-tissue cells. However, in subsequent studies in which certain of these cells were followed without interruption for twenty-four to thirty hours, we found that, at the time of the extrusion of the croton oil, these same stationary cells all withdraw their processes and resume their normal amoeboid form (fig. 7).

An hour or two later, the same cells again become stationary, but this time they have a perfectly spherical form and remain in this rounded condition for several hours—some of them for several days, in spite of the fact that the pigmented leucocytes and even the stellate connective-tissue cells of the same region are moving and changing their shape constantly. This rounding up of the leucocytes takes place regardless of whether the tail is edematous or not (determined by measurement with the fine-adjustment screw). Moreover, simultaneous observations and records showed that, at the very moment when all of these leucocytes near the injured area were motionless and rounded, the wandering cells of the uninjured region were moving around through the tissue in a normal manner. Figure 7 shows in detail the changes which an individual leucocyte underwent shortly before and for some time after the extrusion of a globule of croton oil.

The wandering cells present in the tissue before the injection reacted in exactly the same manner as the leucocytes from the

blood-vessels. In cases in which wandering cells were situated very near the point of injection, they stopped their amoeboid movement immediately after the injection and sent out fine processes.

Several specimens were fixed in Bouin's fluid and stained with Ehrlich's haematoxylin and counterstained with eosin, orange G, and aurantia, and the whole tail mounted in balsam (fig. 13). These specimens showed leucocytes in stages of migration or in the stage in which they were covered with fine processes. In these specimens the polymorphonuclear leucocytes predominated, but mononuclear cells, with an oval nucleus eccentrically placed, and a few cells resembling lymphocytes were also present. The behavior of all the non-pigmented leucocytes was the same regardless of the kind of nuclei they possessed.

The reaction of leucocytes and wandering cells toward this injurious substance differs from their behavior toward the materials injected in former experiments. With sterile paraffin oil there was very little migration of leucocytes. Wandering cells of the tissue moved toward the globule, sometimes flattening out on its surface and then moving away again. The paraffin oil remained in the tissue without occasioning any disturbance, and after the first day or two no cells reacted toward it in any observable way. When carbon and carmine granules, previously sterilized, were injected into the fin, they were phagocytized by wandering cells which migrated toward them. In the case of injected fat (in the form of olive oil, oleic acid, cream, and yolk of egg) leucocytes migrated from the blood-vessels, going directly toward the injected substances and actively engulfing small globules of fat. In this case only part of the wandering cells were attracted toward the injected substances.

Any explanation of the exact nature of the reaction of these leucocytes and wandering cells toward an injurious agent such as croton oil would be mere speculation. However, the observations yielded abundant evidence that the formation of this barrier of stationary leucocytes with processes has a neutralizing effect on the oil and forms an efficient method of localizing the injury. It was noted in every case that connective-tissue cells,

which had previously shown all the signs of injury, cleared up and regained their normal appearance as soon as a ring of these sessile leucocytes with processes had formed between them and the globule of croton oil. Moreover, in contrast with the appearance just described, we observed one case of inflammation in a very young tadpole in which only a few wandering cells were present in the tissue spaces and only an occasional white blood-cell in the blood-vessel. In this case the granular area was very extensive. Connective-tissue cells and endothelial cells became swollen and vacuolated and the circulation in the blood capillaries stopped in a region three or four times as large as the one involved in the case of a similar injury in an older tadpole in which the migration of leucocytes had been abundant.

In the later stages, after the extrusion of the globule, these clear leucocytes were seen to act as phagocytes, picking up extruded red blood-cells.

2. Pigmented leucocytes

These cells are normally present in the tissue spaces of the fin of Amphibian larvae, and they are also found occasionally inside blood-vessels and lymphatics. They are relatively large cells and contain brown and black pigment granules of varying sizes. Their origin and their relation, if any, to the large branching chromatophores of tadpoles have not been studied. In stained specimens they may be seen to possess a single nucleus, usually round or oval in shape. Maximow and Friedsohn consider the pigmented leucocytes to be a special class of cells without any homologue among mammalian blood-cells.

The pigmented leucocytes are strongly attracted toward the croton oil, and those located near the site of injury wander toward it soon after injection. These cells are remarkably resistant to injury. They wander in through the 'granular area,' past the line at which all the non-pigmented leucocytes have stopped, and make their way directly into the opaque region immediately surrounding the croton oil, and even flatten out directly against the oil globule. In some cases pigmented

leucocytes were found containing small refractile globules of oil and, in one instance, such a pigmented cell was followed as it approached a minute droplet of oil and proceeded to ingest it.

These cells continue to surround the globule of croton oil during its sojourn in the fin, and they occupy the site of injection until after the globule has been extruded. Two or three hours after the extrusion, they begin to scatter in all directions and to wander away from the scene of the injury. The clearing up of the opaque area which occurs at this time is chiefly due to the dispersal of these pigmented leucocytes. Most of them wander away through the tissues, while some of them were observed to crawl through the walls of the neighboring lymphatic vessels. A number of pigmented leucocytes remain at the site of injury during the succeeding days and appear to be instrumental in the disposal of the small mass of debris which remains in the tail after the extrusion of the globule. This opaque material gradually diminishes in amount during the next few days and, at the end of a week, the place of injury is marked only by one or two of these pigmented leucocytes.

Like other leucocytes, these pigmented cells were also seen to act as phagocytes of extravasated red blood-cells.

3. The connective-tissue cells

The general picture of the reaction of these cells toward the croton oil has already been given. In one specimen this class of cells was followed with particular care. In this case, a record was made, before injection, of a selected portion of the tail and every mesenchyme cell in the region was drawn. By using two pigment cells as markers, it was possible to insert the globule of croton oil in the exact position desired. On examining this region immediately afterward in the observation chamber it was found that the globule had been inserted without disturbing any of the cells of the tail. The connective-tissue cells were numbered and observed continuously for twelve hours. On account of the mildness of the inflammation produced in this specimen, it was possible to follow individual cells throughout the process.

Different types or degrees of reaction of connective-tissue cells toward the croton oil were noted. These depended on the location of the cells with relation to the globule and on the time elapsing after the injection. The first type—mild injury—appeared immediately after the injection in cells surrounding the globule. Later, this type persisted in the cells situated between the globule and the margin of the fin, in the cells of the middle layer located on the outskirts of the 'granular zone.' In the mild type of injury the processes of the cells become shorter, thicker, and more highly refractile and stand out straight and stiff (fig. 8 and fig. 10, B). In the case of the cells distal to the croton-oil globule, connections between neighboring cells are maintained and the shortening and stiffening of the connecting processes may be instrumental in causing the puckering of the tail which occurs in this region soon after injection (fig. 8).

A more severe type of injury begins to appear about twenty minutes after the injection in the connective-tissue cells of the middle layer situated nearest the globule, and later spreads to other more distant cells. It is this type of reaction which gives the characteristic granular appearance to the area around the globule and especially centrally to it. This type of injury is illustrated in figure 9, C, and figure 10, C. The cell processes are greatly shortened, the cell body becomes thicker and vacuolated, and the nucleus shows plainly. The vacuoles give the cell a honeycombed appearance, and they may be so large and numerous as to indent the nucleus. Many of the vacuoles contain specks in Brownian movement. This rounding up and vacuolization of the connective-tissue cells spreads to the cells farther away from and more proximal to the globule, and also to the superficial layer of connective-tissue cells in the vicinity of the globule.

The third type of injury may be observed two or three hours after the injection in those connective-tissue cells located in close proximity to the croton oil. In these cells, one of which is shown in figure 10, D, the processes are shortened until the cell, in some cases, resembles a round ball. The cell proptolasm is practically filled with vacuoles and the outlines are hazy.

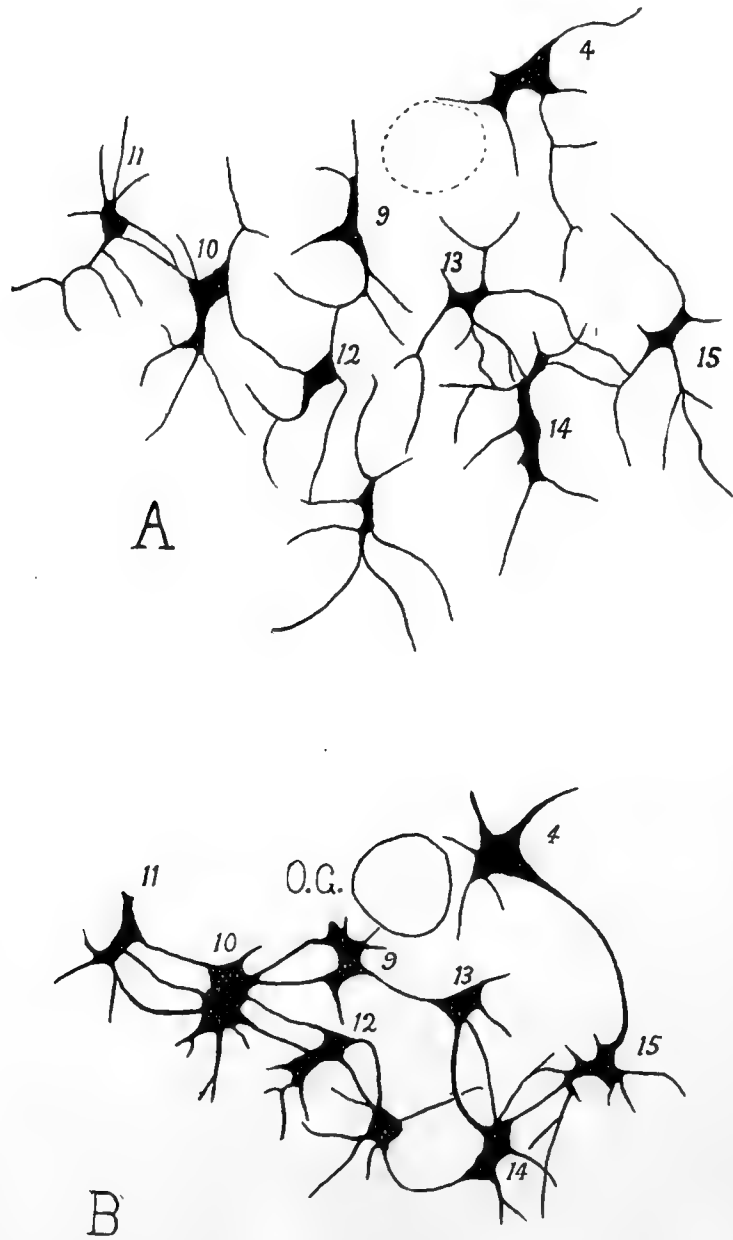

Fig. 8 Shows a group of connective-tissue cells before (A) and immediately after (B) the injection of croton oil. The globule (*O. G.*) was inserted proximally to these cells. The position later occupied by the oil globule is dotted in the first sketch. The same cells are shown in both drawings (see numbers). The cell processes become shorter and thicker and the whole region shrinks. The increase in anastomoses between the processes of the different cells shown in the sketch made after the injection is apparent rather than real, since in the normal tadpole many of the branches of the processes are too fine to distinguish without the oil immersion. $\times 400$.



9



10

Fig. 9 Series illustrating the changes in a single connective-tissue cell situated near the globule of croton oil. Illustrates serious injury and complete recovery. A. Sketch made June 4th, 1 P.M., just before injection. B. Sketch made June 4th, 2:45 P.M., one-half hour after injection of croton oil. Processes shortened, nucleus visible, vacuoles present. C. Sketch made June 4th at 4 P.M., processes mostly withdrawn, more vacuoles present. D. Sketch made June 6th, 2:30 P.M. about twenty-five hours after the extrusion of the oil globule. Cell has recovered—processes radiate toward the site of injury. E. Sketch made June 7th, 4 P.M., three days after the injection of croton oil and two days after the extrusion of the globule. Cell has completely regained its normal appearance. A, $\times 200$ —B-E, $\times 300$.

Fig. 10 Series of sketches of another connective-tissue cell situated very near to the site of injection. Illustrates extreme grade of injury. This is one of the few examples observed in which the cell did not recover. A. Sketch made June 4th, 1 P.M., before injection of croton oil. B. June 4th, 2:30 P.M., fifteen minutes after the injection. Processes shorter and thicker. Nucleus visible. C. Sketch made June 4th, 4:30 P.M. Processes withdrawn, vacuolization. D. Sketch made June 5th, 9:40 P.M. About ten hours after extrusion of the oil globule. Practically all the other connective-tissue cells of the region have recovered. This cell is a thin-walled sac containing vacuoles or granules. Nucleus does not show. On the following day (June 6) this cell was still present as a shadowy outline containing a few granules in Brownian movement. On June 7th no trace of it could be found. A, $\times 200$; B, C, D, $\times 300$.

The vacuolization of the last two types has been described recently by Lewis ('19) in studies of the "degeneration granules and vacuoles" of cells in tissue cultures. In our studies it is noteworthy that cells showing such marked 'degenerative' changes could recover so rapidly and completely. As soon as the ring of sessile leucocytes had formed, the vacuolated connective-tissue cells, outside of this barrier, became clear and refractile, the cell bodies became slender and were occupied solely by the nucleus, and the long branching processes again extended to their normal length. After the extrusion of the croton oil, practically all of the connective-tissue cells returned to normal and their recovery was amazingly rapid. Only one or two cells were lost and these were always cells which had previously shown the most extreme type of injury. One of these cells, watched continuously, became paler and paler and finally remained as an outer rim with a few granules inside before disappearing entirely (fig. 10, D). On the other hand, a number of cells which had shown the most extreme type of reaction toward the irritant were followed throughout the inflammation and were seen to recover completely soon after the extrusion of the oil (fig. 9).

This vacuolization and rounding up of the connective-tissue cells, in contrast to the behavior of the leucocytes, is a purely passive reaction. However, in the later stages of the process, after the extrusion of the croton oil, these cells play a very active part. They wander actively toward the gap in the tissue left by the extrusion of the oil, and some of them disappear from view temporarily, in the opaque regions at the site of the injury. During this period of migration, the processes of the connective-tissue cells radiate towards the injured region. The ends toward the gap are brush-like in appearance, while the opposite ends are rounded (fig. 11). One of the authors (E. R. Clark, '12) had previously studied the connective-tissue cells in the normal tadpole, and found, by observing the same cells for several weeks, that they are not fixed, but constantly change their position, in most cases gradually wandering in the direction of the fin margin. However, after the extrusion of the oil the con-

nective-tissue cells move much more rapidly, changing their shape and position to such an extent that continuous observation is necessary in order to follow individual cells. Thus, in figure 12, a cell is shown which moved in three hours as great a distance as a connective-tissue cell would wander in as many days in normal growth. (Compare with fig. B, in article in *Journal of Anatomy*, 1912, vol. 13, p. 368.)



Fig. 11 Drawing to illustrate radial arrangement of connective-tissue cells and their movement toward the croton oil, after the croton oil has been moved toward the surface of the fin and its irritating action decreased. Croton oil injected twenty-one hours before the drawing was made. The broken lines and arrows indicate the direction and approximate distance of movement of the connective-tissue cells during eleven hours. No leucocytes shown. Cells *a*, *b*, *g* and most others near the globule show the absence of long processes characteristic of the more rapidly moving cell. Compare with the normal cells *x* and *y* and others at the right of the drawing. *C*, *d*, and *e* are cells injured by the croton oil. Cells *d* are vacuolated; in cells *c* and *e* the walls of the vacuoles have broken down, leaving granules suspended in fluid. Cell *C* is one of the stages of the cell shown in figure 10. Cells *g* and *h* are the same cells as are shown in figure 12. *ch*, two fixed chromatophores; *b. v.*, blood-vessel; *lym*, lymphatics. $\times 200$.

THE BLOOD-VESSELS

The blood-vessels situated in the area in which the connective-tissue cells became vacuolated showed definite signs of injury. The endothelial cells became vacuolated and the nuclei became more prominent within a few minutes after the injection. The vessels became constricted and the circulation ceased about a half-hour later. At some points these vessels constricted until they consisted of a solid hyalin thread. At other points they still

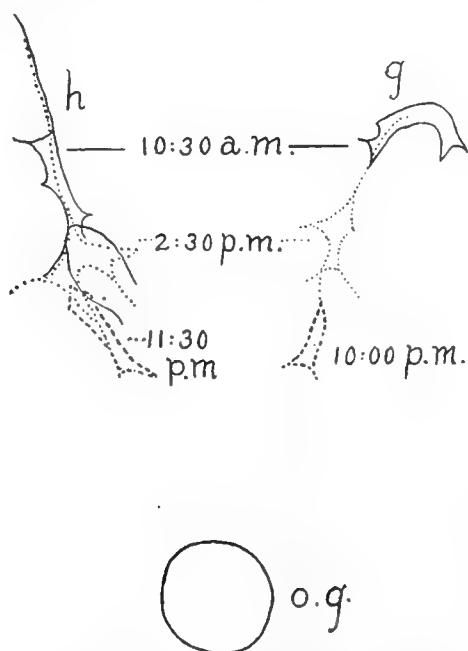

Fig. 12 Drawings showing three successive stages in the movement of the two cells *g* and *h*, which are shown in the first stage (10:30 A.M.) in figure 11. The marked reduction in length of processes during this (relatively) rapid movement is particularly noticeable in the last stage (11:30 P.M. and 10 P.M., respectively). *O. G.*, oil globule. $\times 320$.

contained red blood-cells and leucocytes. There was no migration of white blood-cells from the vessels within the 'granular' area. Outside this region, the blood-vessels showed the typical changes of inflammation, acceleration in the flow followed after about an hour by a slowing of the current and diapedesis of leucocytes. Inside the 'granular' area the frequent occurrence of hemorrhage gave further evidence of injury to the vessel wall. And twenty-four hours or more after the injury, a retraction of one or more of these blood-vessel sprouts or loops located within

this 'granular area' was always observed. On the contrary, the vessels just outside this zone usually showed a tendency to send out new sprouts during this period. A day or two after the extrusion of the globule during the stage of repair, the vessels of the injured area began to send out new sprouts and formed new loops once more.

The reaction of the blood-vessel endothelium toward the croton oil appeared to be entirely passive. In a number of larvae records were kept of the nuclei of the blood-vessels both inside and outside the injured area, but no unusual changes were noted. There was no sign of any proliferation of endothelial nuclei to form wandering cells or endothelial leucocytes. Occasionally leucocytes were observed to flatten out on the interior of the wall of a blood capillary and to pass through the wall sideways. During this process there were moments at which such a leucocyte greatly resembled a nucleus protruding into the lumen of the vessel, and a little later it appeared very much like a nucleus detaching itself from the wall. However, in the consecutive observations of living specimens it was always possible to follow the individual endothelial nuclei and to observe that the phenomenon consisted of the emigration of a leucocyte through the wall, rather than the formation of a leucocyte from an endothelial cell.

THE LYMPHATICS

The lymphatic endothelium plays both an active and a passive part in the inflammation set up by the presence of a drop of croton oil. The lymph capillaries within the 'granular area' show the changes characteristic of injury displayed by the connective tissue and epithelial cells. The areas surrounding the nuclei of the lymphatic became swollen, opaque, and vacuolated, particularly toward the tip. Such vessels usually retracted at about the time of the extrusion of the oil. A day or two later they sent out new sprouts into the regeneration area. The vessels outside the 'granular area' showed the fine processes characteristic of functional activity (E. R. Clark, '09) and even continued to increase in length during the period of active inflam-

mation. Such growth on the part of blood-vessels and lymphatics, however, did not appear to be in excess of the normal rate of growth.

The manner in which lymphatic capillaries served as paths by which the migrating leucocytes were enabled to reach the

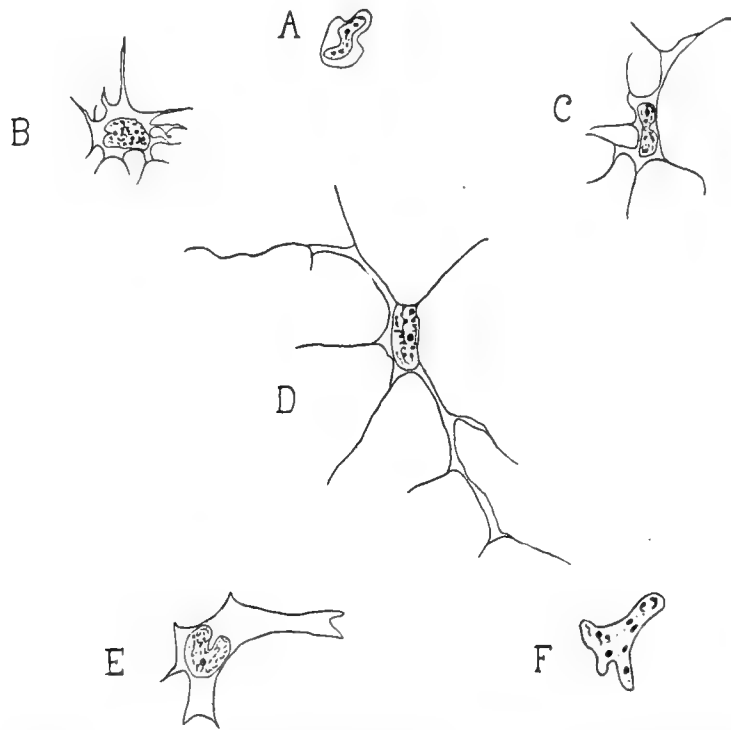

Fig. 13 Sketches of cells from a fixed specimen. Five hours after the injection of croton oil, this larva was examined and found to be in the stage in which a ring of sessile leucocytes was in process of formation. The tadpole was fixed in Bouin's fluid, the whole tail was stained in alum haematoxylin, counterstained in eosin, orange G, and aurantia, dehydrated, cleared in xylol, mounted in damar. The sketches were made with the oil-immersion lens. A. Amoeboid leucocyte. B and C. Sessile leucocytes with processes. D. Normal connective-tissue cell outside injured area. E. Connective-tissue cell near the croton-oil globule. F. Connective-tissue cell in close proximity to the croton oil, showing extreme type of injury (chromatin scattered through the cell). $\times 600$.

scene of action more quickly has already been described. There are steps in the migration of such a leucocyte through the wall of a lymph-vessel in which it is easy to be deceived into the belief that the proliferation of an endothelial leucocyte is taking place, for the leucocyte often comes out of the vessel near the point where a nucleus is located. But continuous observation

of a lymphatic capillary near the site of injury shows that such leucocytes from the tissue wander through the wall into the lymphatic, move down the vessel, and crawl out again at the tip, nearer the globule of croton oil (fig. 14).

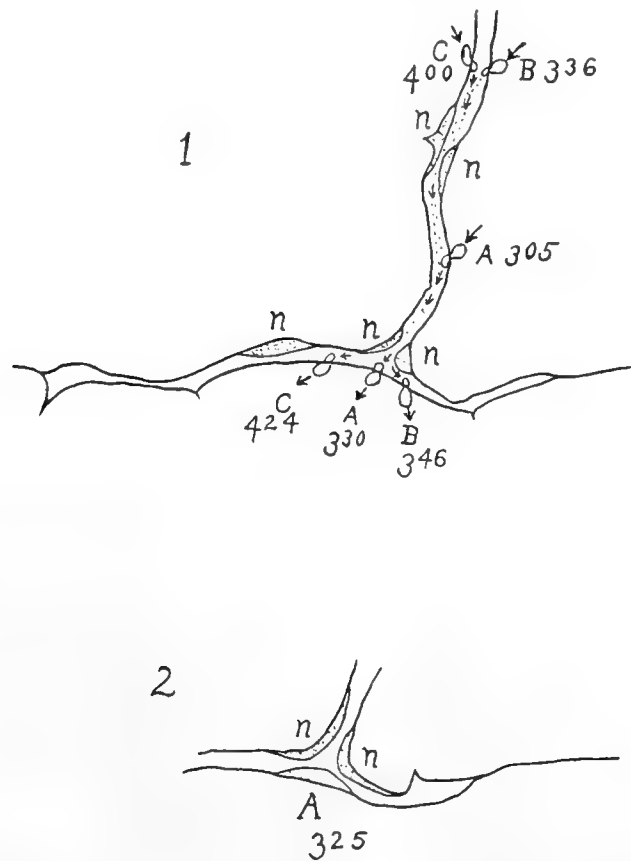

Fig. 14 1) Illustrates the migration of a leucocyte from the tissue into a lymphatic capillary, down toward the tip nearer the site of injection, and out again. Lymphatic sketched at 2:30 P.M. A, B, and C are three different leucocytes. The arrows and dotted lines show the respective paths which they followed. $\times 213$. 2) shows the appearance of a part of the lymphatic near the tip at 3:25 P.M., at the moment when a leucocyte (A) is in the act of emerging and illustrates the deceptive appearance of endothelial proliferation which accompanies the phenomenon. As seen in sketch (1), leucocyte A entered the lymphatic higher up at 3:05, and at 3:30 it was again outside the vessel. $\times 213$.

As in the case of the blood-vessels, we kept records of the lymph-vessels and of their endothelial nuclei, both inside and outside the 'granular area,' in several different larvae. The lymphatic sprouts within the 'granular' zone, which had become vacuolated while the croton oil was present, often retracted,

while those outside the area continued to send out fine processes and to grow in a normal manner, but in no case do we find any evidence of endothelial proliferation to form wandering cells.

In a number of cases, hemorrhages occurred from blood capillaries located near the croton oil. The extravasated red blood corpuscles were taken up by the lymphatic vessels, as well as by leucocytes of both the pigmented and clear varieties. The method by which the occasional extruded red blood-cell found in the normal tail is taken up has been described by one of the authors (E. R. Clark, '09). In this case the process was the same, but on a much larger scale. Instead of one sprout growing toward a single blood-cell, a number of processes appeared on both sides of the lymphatic and, by means of these, several red blood corpuscles were picked up and simultaneously taken into the lumen of the vessel, where they were seen to move along the lymph capillary to the main longitudinal lymphatic. After two or three days, such an area would be almost clear of blood-cells, and the majority of these would have been salvaged by the activity of the lymphatics.

In a number of larvae an edema developed in the injured region. This usually occurred soon after the extrusion of the globule, although it was sometimes noted on the following day. The edema may be demonstrated by measuring the thickness of the tail by means of the fine-adjustment screw. The appearance of the tail is altered in such areas; the region becomes clearer, the connective-tissue cells more widely separated, and all the leucocytes, including the pigmented ones, round up into spheres. The lymphatic sprouts of the area become markedly distended at the tip. This enlargement is evidently due to an increase in the fluid content of the vessel, for the endothelium is represented merely by a thin line. This differs from the enlargement of the lymphatic tips which occurs soon after the introduction of the croton oil and which is due to a swelling of the endothelial cells proper. Figure 15 shows successive records of a lymphatic sprout in an inflammation area which has become edematous after the extrusion of the globule of croton oil. Comparison of the different drawings with the measurements of this

region of the tail recorded at intervals shows that the lymphatic capillaries expand with an increase in the thickness of the tail and contract again when the tail resumes its normal dimensions. Absorption through the lymphatic is evidently active during inflammation and appears to increase with an increase in the amount of fluid present in the tissue outside.

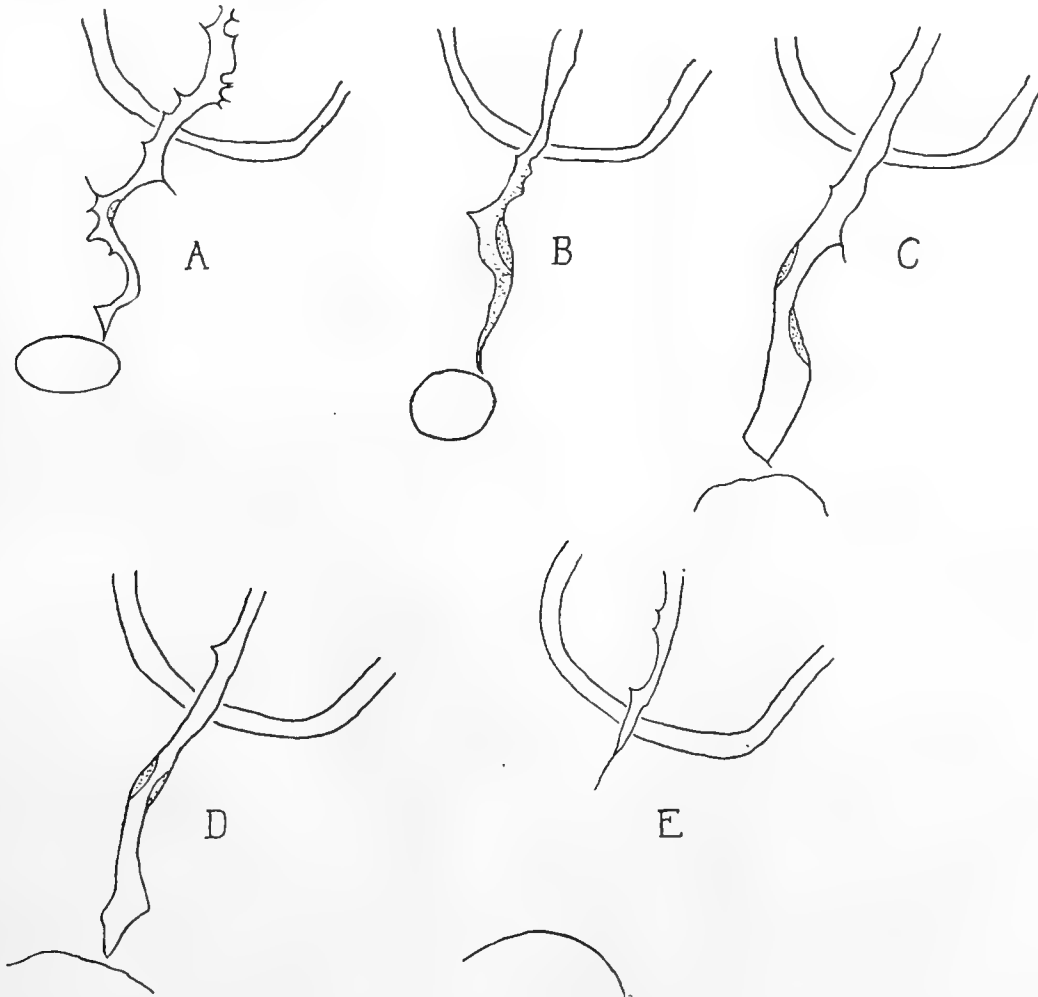

Fig. 15 Sketches showing the reactions of a lymphatic sprout within the area affected by the injected croton oil. In this specimen an edema developed after the extrusion of the globule. Records of the thickness of the tail at the point under observation were made by means of the fine-adjustment screw. A. Sketch made May 29th, 12:15 P.M., immediately after the injection. Thickness of the tail, 55μ . B. 3 P.M. Wall of the lymphatic swollen and granular at the tip. Thickness of the tail, 66μ . C. Lymphatic at 5:15 P.M. (globule extruded at 3:45 P.M.). Endothelial wall of lymphatic smooth and thin, lumen enlarged. Thickness of tail, 100μ . D. 6 P.M. Lymphatic not so wide, but still enlarged at the tip. Thickness of tail, 74μ . E. May 30th, 10 A.M. Lymphatic capillary is normal in size and contour, and has retracted. Thickness of tail 57μ . $\times 178$.

DISCUSSION

The subject of inflammation has been studied so extensively and the literature is so voluminous that it has seemed inadvisable to attempt an extensive review in this paper, and we shall merely indicate briefly some of the divergent views. Many of the early studies of Cohnhein, Metchnikoff, and Arnold were made on living material, and the general features of inflammation and many of the specific details, as discovered by them, are accepted by most pathologists. With regard, however, to the derivation and possible transformation of the cells taking part in inflammation, the widest difference of opinion may be found—among both pathologists and anatomists. The question as to the specificity of this group of cells, in normal growth, has not yet been settled by anatomists. On the side of non-specificity are found Maximow, Danchakoff, Weidenreich, and particularly Mollier ('11), who, although their studies have been confined mainly to early stages of embryonic development, believe, to a greater or less extent, in the interchangeability of endothelial cells, leucocytes, mesenchyme, and reticulum. Schulte ('14) has gathered together data and opinions which apparently support this view and presented them in the form of a plausible though not entirely convincing argument. The specificity of the cells of the group has been advocated particularly by Minot, Marchand, MacCallum, and Mall and his coworkers—Sabin, Evans, E. R. Clark—although Mall apparently recognizes an exception in the 'reticulo-endothelial' cells of the spleen, liver and endocardium, and Evans ('14) in the formation of free phagocytic cells from the Küpffer cells of the liver, following injections of tubercle bacilli.

In studies made on inflammation, the various views as to the possible transformation of one type of cell into another have been supported by the following: *a*) connective-tissue cells may be derived from leucocytes: Ribbert ('90), Metchnikoff ('93), Maximow ('02-03); *b*) endothelial cells from leucocytes: Ribbert ('90); *c*) connective-tissue cells from endothelium: Ribbert ('90), Maximow ('05), in intense inflammation; *d*) endothelial cells

from connective-tissue cells: Minervini ('11); *e*) leucocytes from endothelial cells: Cornil and Ranvier ('80) from lymphatic endothelium, Beattie ('02), Evans ('14), from Küpffer cells in the liver, Marchand ('13) and MacCallum ('16), possibly in special organs, Mallory ('14); *f*) leucocytes from connective tissue or reticulum: Herbert ('01), Downey ('12) in lymph glands. It is to be noted that the most of these studies have been made upon preserved material, in which deductions as to cell transformations are notoriously unreliable.

In our investigation the cells were watched in the living animal, in a region in which it is possible to follow the changes of individual cells throughout the process of the tissue reaction to an injurious chemical agent. We were unable to find the slightest evidence for the transformation of a cell of one type into a cell of another type. Blood-vessel and lymphatic endothelial cells maintained their identity and did not give rise to wandering cells, nor was new endothelium formed by any other way than by the sprouting of preexisting endothelium. Leucocytes were not formed from connective tissue nor endothelium nor were they transformed into connective-tissue cells or endothelial cells. Connective-tissue cells maintained their identity completely throughout the entire process. *This entire group of cells, then, remained specific, in an aseptic inflammation, in the transparent fin expansion of the tadpole's tail, produced by the injection of croton oil.*

There were a number of appearances produced in the reaction of the various tissues which were so suggestive of possible transformations from one type to another that we were forced to make long continuous observations before arriving at definite conclusions. During the first season in which we studied this problem, we were nearly convinced that the leucocytes, after becoming sessile and sending out their processes, were actually transformed into connective-tissue cells. It was exactly this picture which led Metchnikoff to conclude that such a transformation takes place. However, since we had been unable to follow the same cells through the entire period, we postponed publication of our results, until we might have another tadpole

season, in order, chiefly, to follow the same leucocytes throughout the process. This we succeeded in doing, and found in every instance that the leucocytes revert, after the extrusion of the oil, to typical rounded or amoeboid leucocytes. We feel morally certain that had we seen these leucocytes in sections, we should have labelled them connective-tissue cells.

Again, when leucocytes were first seen emerging from lymphatic capillaries, they often gave the appearance of pulling away from the endothelial cells—an interpretation which might very readily be made from sections. However, continuous observation of lymphatic capillaries showed that the leucocytes always entered the lymphatic vessel, from the outside, that they moved a variable distance along the lumen and then passed out through the endothelial wall. In their movements among the connective-tissue cells, again, leucocytes frequently pass over them so closely that only continuous observation shows that they are not being formed in some way by the connective-tissue cells.

While we hesitate to generalize from a set of observations restricted to a single species of a lower vertebrate, still our results are so definite and so positive that it seems fair, at least, to advance the hypothesis that similar tissues in other animals react similarly. Certainly, one must be very skeptical toward conclusions as to cell transformations which are based on studies of fixed material, especially when such studies yield such a variety of conflicting views.

One matter remains to be cleared up by further studies, namely, the possibility of the transformations of one type of leucocyte into another. Owing to the great difficulty in seeing the outlines of the nuclei in the cells studied, we did not attempt to distinguish, in the living, between the different types of amoeboid cells, except for the pigment cells, and our studies of total mounts of fixed specimens are still incomplete. Some investigators hold that polymorphonuclear leucocytes may be transformed into mononuclear cells (Janowski, Metchnikoff). A suspicious fact in this connection is the oft-repeated observation that, early in inflammation, polymorphonuclears predom-

inate, while mononuclears are much more numerous later. This is explained by many as due to the destruction of polymorphonuclears. In our study we saw very little, if any, destruction of leucocytes. Moreover, the rounding up of all non-pigmented leucocytes after the extrusion of croton oil and retention of this shape for several days has led us to wonder whether in this phase the nuclei also round up. This point we hope to take up in future studies.

SUMMARY

The reactions and changes undergone by the cells in the tail of Amphibian larvae in response to injections of minute globules of croton oil are as follows:

1. Connective-tissue cells manifest all grades of injury, depending upon their nearness to the oil. In the nearest cells the branched processes are withdrawn, the body of the cell becomes much swollen and vacuolated, and the nucleus becomes easily visible. Later, the vacuoles run together and the cell becomes a delicately walled sac, containing a few granules suspended in fluid. Later, the outlines of the cell are lost completely. Complete destruction, however, is limited to a very few cells. A little further away, cells become swollen and vacuolated, processes become much shorter, but are not retracted entirely, and the nucleus becomes visible, and may be indented by vacuoles. Such cells may recover completely—the vacuoles disappear, the cell becomes smaller, the nucleus less distinct, new processes are sent out and movement of the cell resumed. Still further away, the cells may show merely slight swelling with granulation. The cells on the border zone of the area affected react by moving toward the oil—at a rate much faster than the normal rate of movement of these cells. In this movement, the number and length of their processes are much reduced, until they resemble the typical filoblast.

2. *a*) Non-pigmented leucocytes (including the wandering cells outside the blood-vessels) respond immediately by moving toward the globule of croton oil. When about half-way between the outer limits of the affected connective-tissue cells and the oil,

they become stationary and send out many fine processes. These processes are withdrawn and renewed continuously, though tending to become more and more stable. At this stage they resemble very closely small connective-tissue cells. They are not transformed into connective-tissue cells, however, for eventually—probably corresponding to a diminution in the intensity of the croton-oil action—the processes are retracted and the leucocytes resume amoeboid powers. After the oil has been extruded, the leucocytes remain stationary for several days in a spherical condition, after which they scatter through the tissues. Wandering cells free in the tissue spaces and leucocytes which emigrate from the blood-vessels do not differ in their reaction. Leucocytes may enter lymphatic vessels and emerge again, but we saw no evidence whatever of the origin of leucocytes from lymphatic or from blood-vascular endothelium.

b) Pigmented leucocytes move toward the croton-oil globule and are more resistant to its action than the other leucocytes, for they may even come in contact with the oil globule without showing any diminution in their motility.

3. Blood capillaries near the globule show thickening and vacuolization of the endothelium, and, later, narrowing of the lumen, with, in many cases, retraction of endothelium. Extravasation may occur through the injured part of the wall.

4. Lymphatic capillaries near the globule also show vacuolization of the endothelium, and their lumen may become much distended, particularly in case an edema develops. The injured capillary may be retracted, but may grow out again later after the oil globule has been extruded.

5. Throughout the inflammatory reaction, each type of cell—leucocyte, connective-tissue cell, blood-vessel endothelium, and lymphatic endothelium—maintains its specificity, and there is no evidence for the transformation of one type of cell into another.

BIBLIOGRAPHY

- ARNOLD, J. 1893 Altes und neues über Wanderzellen insbesondere deren Herkunft und Umwandlungen. *Virch. Arch.*, Bd. 132, S. 502.
- BARDENHEUER, F. 1891 Über die histologischen Vorgänge bei der durch Terpentin hervorgerufenen Entzündung im Unterhautzellgewebe. *Ziegler's Beiträge*, Bd. 10, S. 394.
- BEATTIE, J. M. 1902 The cells of inflammatory exudations, etc. *Journal of Path. and Bact.*, vol. 7, p. 129.
- CLARK, E. R. 1909 Observations on living growing lymphatics in the tail of the frog larva. *Anat. Rec.*, vol. 3, no. 4, p. 183.
1912 Further observations on living growing lymphatics: their relation to the mesenchyme cells. *Am. Jour. Anat.*, vol. 13, p. 351.
1916 A study of the reaction of the mesenchyme cells in the tadpole's tail toward injected oil globules. *Anat. Rec.* vol. 11, p. 1.
- CLARK, E. R., AND CLARK, E. L. 1917 A study of the reaction of lymphatic endothelium and of leucocytes, in the tadpole's tail, toward injected fat. *Amer. Jour. Anat.*, vol. 21, p. 421.
- CORNIL AND RANVIER 1880 *Pathological histology* (transl. by Shakespeare and Simes), chap. 3.
- DOWNNEY, H. AND WEIDENREICH, F. 1912 Über die Bildung der Lymphocyten in Lymphdrüsen und Milz. *Archiv. für mikr. Anat.*, Bd. 80, S. 306.
- EVANS, H. M., BOWMAN, F. B., AND WINTERNITZ, M. C. 1914 An experimental study of the histogenesis of the miliary tubercle in vitally stained rabbits. *Jour. of Experim. Med.*, vol. 19, p. 283.
- EVANS, H. M. 1912 The development of the vascular system. *Human Embryology*, ed. by Keibel and Mall, vol. 2, p. 570.
- FRIEDSOHN, A. 1910 Zur Morphologie des Amphibien Blutes, etc., *Arch. f. mikr. Anat.*, Bd. 75, S. 435.
- HERBERT 1901 The young plasma cell or lymphocyte in chronic inflammation. *Jour. of Path. and Bact.* vol. 7, p. 90.
- JANOWSKI, W. 1895 Zur Morphologie des Eiters verschiedenen Ursprungs. *Archiv. f. experim. Path. u. Pharm.*, Bd. 36, S. 8 (reviewed by Marchand).
- LEWIS, W. H. 1919 Degeneration granules and vacuoles in the fibroblasts of chick embryos cultivated in vitro. *Bull. of the Johns Hopkins Hospital*, vol. 30, p. 81.
- MACCALLUM, W. G. 1903 Relations between lymphatics and connective tissue. *Johns Hopkins Hosp. Bull.*, 1903, vol. 14, p. 142.
1916 *A textbook of pathology*. W. B. Saunders Co., chap. 9.
- MALL, F. P. 1912 On the development of the human heart. *Am. Jour. Anat.*, vol. 13, p. 249.
- MALLORY, F. B. 1914 *The principles of pathological histology*. Philadelphia, W. B. Saunders Co.
- MARCHAND, F. 1913 Über die Herkunft der Leukocyten und ihre Schicksale bei der Entzündung. *Verhandl. d. deutsch. Pathol. Gesellsch.*
- MAXIMOW, A. 1902 Experimentelle Untersuchungen über die entzündliche Neubildung von Bindegewebe. *Ziegler's Beiträge. Supplement*, Bd. 5.

- MAXIMOW, A. 1903 Entstellung, Struktur, und Veränderung des Narbengewebes. Ziegler's Beiträge, Bd. 34, 1903.
1905 Beiträge zur Histologie der eiterigen Entzündung. Ziegler's Beiträge, Bd. 38, S. 301.
1910 Ueber embryonale Entwicklung der Blutzellen bei Selachiern und Amphibien. Verhandl. der Anat. Gesellschaft. Fischer, Jena.
- METCHNIKOFF, E. 1893 Leçons sur la pathologie comparée de l'inflammation. Paris, 7th Leçon, p. 111.
- MINERVINI, R. 1911 Über die Neubildung von Blutgefässen. Virch. Arch., Bd. 204, S. 75.
- MINOT, C. S. 1912 The development of the blood. In Human Embryology, ed. by Keibel and Mall, vol. 2, p. 498.
- MOLLIER, S. 1911 Über den Bau der capillaren Milzvenen (Milzsinus). Archiv. für mikrosk. Anat. und Entw., Bd. 76, S. 608.
- RIBBERT 1890 Über die Betheilung der Leukocyten an der Neubildung des Bindegewebes. Centrabl. f. allgem. Path. u. path. Anat., Bd. 1, S. 667.
- SABIN, F. R. 1913 The origin and development of the lymphatic system. Johns Hopkins Hospital Reports, Monogr. new series, no. 5.
- SCHULTE, H. VON W. 1914 Early stages of vasculogenesis in the cat. Memoirs of The Wistar Institute of Anatomy and Biology, no. 3.
- ZIEGLER, E. 1905 Lehrbuch der allgemeinen Pathologie und der pathol. Anat., 11th ed., G. Fischer, Jena, S. 368.

Resumen por el autor, James W. Pepez.

Musculatura de los atrios del corazón.

El objeto del presente trabajo es la demostración de los fascículos musculares de los atrios (aurículas de la terminología antigua, N. del T.). La mayor parte de ellos se originan en el tabique interatrial. La banda interatrial y los fascículos externos del atrio derecho se originan en el nodo sino-auricular. **Atrio derecho:** La banda interatrial arranca del nodo y se extiende hasta el apéndice izquierdo. Los fascículos externos también arrancan del nodo extendiéndose sobre el atrio. La cresta anterior derecha se origina en el tabique y dá origen a los músculos pectinados anteriores. La cresta posterior derecha arranca del tabique dando origen a los músculos pectinados posteriores. **Seno venoso:** El fascículo intercaval se origina en el tabique, extendiéndose sobre el atrio derecho. Los fascículos de la vena cava superior se originan en el nodo y tabique, y rodean a la vena cava. La hoja derecha del tabique secundario se origina en el tabique y se extiende sobre la vena cava inferior. La hoja derecha del tabique primario arranca del tabique, pasando a las válvulas de la vena cava inferior. **Atrio izquierdo:** La cresta anterior izquierda procede del tabique y banda interatrial. La creta posterior del mismo lado procede también de la banda y tabique. El fascículo septopulmonar se origina en el tabique y cubre el techo del atrio. La hoja izquierda del tabique secundario se origina en el tabique, extendiéndose sobre la superficie posterior del atrio. El fascículo septoatrial arranca del septo extendiéndose sobre el techo del atrio. La hoja izquierda de tabique primario nace también del septo, pasando alrededor de la base del atrio.

HEART MUSCULATURE OF THE ATRIA

JAMES W. PAPEZ

Department of Anatomy, Emory University Medical School, Atlanta, Georgia

EIGHT FIGURES (FOUR PLATES)

CONTENTS

| | |
|---|-----|
| Purpose..... | 255 |
| Material and methods..... | 256 |
| Sino-auricular node and septal raphe..... | 256 |
| Musculature of the right atrium..... | 260 |
| 1. Interatrial band..... | 260 |
| 2. External bundles of the right atrium..... | 261 |
| 3. Right anterior crest and anterior pectinate muscles..... | 263 |
| 4. Right posterior crest and posterior pectinate muscles..... | 264 |
| Musculature of the sinus venosus..... | 266 |
| 5. Intercaval bundle..... | 266 |
| 6. Superior vena caval bundles..... | 267 |
| 7. Right leaf of septum secundum..... | 269 |
| 8. Right leaf of septum primum..... | 270 |
| 9. Musculature of the coronary sinus..... | 271 |
| Musculature of the left atrium..... | 271 |
| 10. Left anterior crest and anterior pectinate muscles..... | 271 |
| 11. Left posterior crest and posterior pectinate muscles..... | 272 |
| 12. Septopulmonary bundles..... | 273 |
| 13. Left leaf of the septum secundum..... | 274 |
| 14. Left septoatrial bundle..... | 274 |
| 15. Left leaf of septum primum..... | 275 |
| Note on nerve supply of the atria..... | 276 |

PURPOSE

The purpose of this work is to establish more fully the arrangement of the muscle bundles of the atria of mammalian hearts.

The origin of the excitatory process in the sino-auricular node of Keith and Flack has been the object of much experimental work. Wybauw ('10), by means of the electrocardiograph, and T. Lewis, Meakins, and White ('10 to '14) have produced evidence to show that the excitation process which induces atrial systole

commences in this node. They have also suggested that the excitation process spreads from the node through both right and left atria along several muscular paths. The right posterior crest (*taenia terminalis*) has been considered the principal primary pathway for the excitation process in the right atrium. The interatrial band has been considered the primary pathway for the excitation to the left atrium (G. Bachmann, '16). It is the purpose of this paper to show the gross arrangement of the muscular bundles of the atria and to indicate how this arrangement may serve to spread the excitation process through them.

MATERIAL AND METHOD

For this work the method of cleaning and stripping the musculature has been found most useful. Human, beef, and dog hearts in abundance were used.

The cardiac orifices were tied and the hearts were distended with a 10 per cent solution of formalin under a pressure of about 30 cm. of the fluid. The fluid was allowed to act for a day or two, depending upon the size of the heart. The hearts were then washed in running water for a day and transferred to alcohol. To preserve the distended shape and facilitate external dissections, the atria were then stuffed with absorbent cotton. To display the bundles the epicardium and endocardium were removed.

SINO-AURICULAR NODE AND SEPTAL RAPHE

From the preparations at hand it is clear that all of the principal muscular bundles of the atria radiate from one central area which surrounds the orifice of the superior vena cava. This area is for the most part buried in the anterior part of the atrial septum, but in front and to the right of the orifice of the vena cava it comes to the external surface. The portion that appears in the groove between the vena cava and the right atrium has been designated the sino-auricular node by Keith and Flack ('07); it is the seat of impulse formation for the atria in the normally beating heart. The portion that is buried in the atrial

septum will be here called the septal raphe; it provides an apparent mechanical support for many of the larger muscular bundles of both atria. My preparations show that some of the external bundles commence in the sino-auricular node and that other deeper bundles commence in the septal raphe.

The sino-auricular node was first described by Keith and Flack ('07). They state that it consists of delicate, pale and pale-staining, primitive, undifferentiated, striated muscle fibers, plexiform in arrangement with well-marked, elongated nuclei. The fibers resemble those of the atrio-ventricular node of Tawara. They are embedded in densely packed connective tissue. The fibers lead somewhat abruptly into the surrounding atrial musculature that forms the external strata. They mention nerve terminals in this node. The sino-auricular node is recognizable as a thin stratum of fine pale musculature beneath the epicardium in the sulcus between the superior vena cava and right atrium.

I have not been able to find macroscopically any nerve filament passing to the sino-auricular node. In contrast to this the abundance of nerve filaments on the septal (left) side of the orifice of the superior vena cava sinking into the region of the septal raphe is significant. Here, those authors have described tissue of the same character as forms the sino-auricular node. Moreover, they believe that the tissue of the atrio-ventricular node of Tawara represents a part of the same ring of undifferentiated muscle tissue that surrounds the sino-auricular junction.

Experimental work has confirmed the view that the sino-auricular node is the seat of impulse formation in the normally beating heart. That the excitation process for at least the superficial bundles of the right atrium and for the interatrial band commences in the head of this node has been amply demonstrated by Wybauw ('10), T. Lewis and his associates ('10-'14) and has been confirmed by Eyster and Meek ('13-'14).

Several external bundles commence in the sino-auricular node region: the external bundles that cover the upper and lateral surface of the right atrium (fig. 3, 2), the circular bundles of the superior vena cava (figs. 3 and 5, 6a), and the interatrial band (fig. 5, 1). The delicate fibers of the node cannot be regarded as giving these bundles mechanical support.

The septal raphe (figs. 1 and 2, *R*) is the portion of the atrial septum in front of the oval fossa in which most of the large muscle bundles of both of the atria commence. I have designated it the septal raphe because the term suggests that this is the seam along which the atria are knitted together. It is best seen on the internal surface of the atria when the endocardium has been removed, but its anterior margin appears in a vertical groove on the anterior surface of the atria below the interatrial band as shown in figure 5.

The septal raphe, as shown in figures 1 and 2, *R*, forms an irregular line in the septum that extends from the front of the atrioventricular node of Tawara to the front of the superior vena cava where it turns to the right to join the head of the sinoauricular node. This continuity is along the external or anterior surface of the right posterior crest (4). On the right surface of the septum (fig. 1) the principal portion of the raphe is about 1.5 cm. above and in front of the atrioventricular node region and is covered by superficial strata of right posterior crest (4) and right leaf of the septum secundum (7), which have a lower and variable origin. These strata have a variable origin in different hearts and obscure the raphe. From the right side of the raphe arise the right anterior crest (3), right posterior crest (4), right leaf of the septum secundum (7), right leaf of the septum primum (8), septocoronary bundle, intercaval bundle (5), and the left radiate bundles of the superior vena cava (6*b*). On the left surface of the septum (fig. 2) the raphe, as seen from the inner surface, extends along a long s-shaped line. The upper end of it is situated just behind the interatrial band, which is on the anterior surface of the atrial junction. This portion of the raphe gives origin to the septopulmonary bundles (12) and the upper portion of the intercaval bundle (5) and the left leaf of the septum secundum (13). The middle portion of it is situated in front of the oval fossa adjacent to the principal portion on the right side and gives origin to the large left septoatrial bundle (14). The lower portion of it is situated below the oval fossa opposite the region of the atrioventricular node close to the junction of the atrial and ventricular septa and gives origin to the large left leaf of the septum primum (15).

It is interesting to note that a large terminal of the right vagosympathetic nerve ends in the upper portion of the septum behind the interatrial band by dividing into numerous filaments that sink into the raphe and terminate in the various bundles. That is, the nerve enters the triangular interval, bounded in front by the interatrial band, to the right by the vena cava and to the left by the upper right pulmonary vein. A small filament passes behind the orifice of the superior vena cava in the intercaval bundle. The others sink into bundles that radiate from the septal raphe. In the beef heart a fine terminal is traceable to the base of the right appendage, where it terminates just below the head of the sino-auricular node. No terminal filaments were traceable into the sino-auricular node.

Extension of nodal tissue into the region of the septal raphe has not been demonstrated. One of the figures of Keith and Flack ('07) shows a portion of the sino-auricular node in the left side of the orifice of the superior vena cava above the region of the septum. They suggested that a ring of such tissue may extend into the septum and include the atrioventricular node. Histological studies of Keith and Flack ('07), T. Lewis ('10-'14), and others have served to define the head and tail of the node in the groove between the superior vena cava and the right atrium.

Extension of the pace-making function into the region of the septal raphe has not been demonstrated. Since the septal raphe is buried behind the interatrial band to the left of the superior vena cava it is not approachable externally for electrocardiographic work. It is approached with difficulty from the inner endocardial surface. Here the raphe is covered by muscular bands, and is, therefore, not immediately subendocardial. Ganter and Zahn ('12-'13) cooled the septum from the right side and found that atrial rhythm is influenced only by cooling of the region of the atrioventricular node. Primary negativity also appears only in this region of the septum. It is a generally accepted view that the atrioventricular node is the principal seat of impulse formation in the atrial septum and normally conducts the excitation process into the ventricles. Only when

the sino-auricular node is abolished is the seat of impulse formation for the atria transferred to the atrioventricular node.

By the methods employed I have not been able to determine what connections exist between the septal raphe and the sino-auricular and atrioventricular nodes. It is conceivable that remnants of sino-auricular tissue exist in the raphe or that the bundles that arise from the raphe are directly connected with both of the nodes by means of similar tissue. It is clear that the septal raphe contains fibrous tissue which serves as a point of attachment for the muscle bundles that arise in the septum.

The question is raised whether or not the pacemaking function for the bundles of the left atrium and the deep bundles of the right atrium exists in the septal raphe. If not, what is the relation of these bundles to the head of the sino-auricular node or how is the excitation process conducted to them? If this function does exist in the septal raphe, what is the relation of the raphe to the atrioventricular node of Tawara?

MUSCULATURE OF THE RIGHT ATRIUM

1. *The interatrial band*

The interatrial (interaauricular) band, as shown in figure 5, 1, is a strong external muscular bundle on the anterior surface of the atria. It extends from the sino-auricular region to the left appendage. It is represented in Toldt's Atlas, figure 958. Keith and Flack ('07) designated it a "constant band passing from the sinus musculature to the vestibule of the left auricle." T. Lewis ('14) and others have adopted this name for it. Lewis found, in tracing the excitation from the sino-auricular node, that the rate of propagation was greater along the band than elsewhere in the atrium. G. Bachmann ('16) showed that, although, perhaps not the only, it is the primary or more direct path for the conduction of the excitatory process from the right to the left auricle.

This band (fig. 5, 1) lies on the external and anterior surface of the atria in front of the left septopulmonary bundle (12), which forms the deeper and more extensive stratum in this region.

It arises by its deep surface from the head of the sino-auricular node in front of the orifice of the superior vena cava. This origin extends along a diagonal line, the left end of which terminates in the atrial septum. The bulk of the fibers arises near the septum below the band. Some of the bundles arise above the head of the node on the front of the vena cava and are distinctly traceable into the fiber bundles of the node. These upper fiber bundles, from the upper part of the band, extend to the left atrium and form a small part of the left posterior crest (fig. 4, 11) encircling the base of the left atrial appendage. Behind them is the large left septopulmonary bundle (fig. 5, 12). The larger portion of the fiber bundles that arise from the head of the sino-auricular node along the diagonal line extends to the front of the left atrial appendage and divides to encircle the appendage midway between the tip and the base. Here it produces a sharp constriction, causing the left atrial appendage to be bent upward. The right end of the band extends into the front of the right atrial appendage and divides to encircle it near its base in a manner similar to that on the left side, but the constriction is slight and may be wanting. In the left atrium it gives origin to the middle or apical group of pectinate muscles. Both ends of the band give origin to a thin superficial stratum of fiber bundles that encircle the atrial appendages. On the right side this stratum is well defined, on the left side it is sparse and often absent so that the deeper pectinate stratum is distinctly seen on the surface. This is the case in the dog heart on both sides so that the deeper pectinate stratum is distinctly superficial. The encircling fibers which arise in the 'concentration area' (fig. 3, 2) of T. Lewis in the dog heart must not be confused with superficial circular stratum found in the human and bovine hearts. The superficial fibers are seen well in beef hearts.

2. The external bundles of the right atrium

The external bundles (figs. 3, 2, and 5, 3) that encircle the right atrium are derived from the septal raphe, head and tail of the node, and from the intercaval bundle. In the human heart they

form a thin, more or less uniform stratum over the surface of the right atrial appendage and right surface of the base of the atrium. In the bovine heart they are strongly developed. In the dog and cat hearts they form a thin stratum more difficult to differentiate. Owing to their diffuse origin and termination, they cannot be accurately described. The following description is, therefore, an approximate one from which there are variations.

a. The origin of those from the septal raphe is below the right limb of the interatrial band. It is covered by the origin of the band as seen on the external surface in figure 5, 3. They pass forward toward the atrioventricular ring and are nothing more than the superficial stratum of the right anterior crest. They are spread out and inserted into the atrioventricular ring to the right of the aortic orifice.

b. The origin of those from the head of the node is hidden by the right limb of the interatrial band (fig. 5, 3). They pass forward and encircle the base of the right atrial appendage. On the lateral side of the atrium they divide into two limbs. One of these encircles the base and forms a thin stratum over the lower and right side of the atrium. The other sweeps upward around the base of the atrial appendage covering the middle cluster of the anterior pectinate muscles, and forms a distinct constriction in the lower lateral part of the base of the atrial appendage which is seen especially well in dog hearts, as shown in figure 3.

c. Those that arise from the tail of the node form a forward and a lateral radiation and a posterior radiation (fig. 3, 2). The forward radiation is distinct only in the dog heart. T. Lewis has called it the 'concentration area.' It arises from the front of the tail of the node and passes along the upper margin of the right atrial appendage. Together with the right limb of the interatrial band, it gives rise to the external circular bundles of the right atrial appendage. It covers the interlacement of the apical pectinate muscles, divides, and is diffused over the lateral surface of the right atrial appendage. In the human heart this radiation is generally not recognizable, but in some instances a small distinct superficial bundle about 1 cm. in length occurs in

this region. The posterior radiation from the tail spreads over the lateral surface of the lower portion of the atrium, a part above and a part below the intercaval bundle, from which it is often indistinguishable. In the beef heart it is quite distinct and has a more anterior position.

d. The intercaval bundle (figs. 3, 5, and 6, 5) spreads over the lower portion of the external surface of the right atrium. It will be described later, (page 266).

The spread of the excitation process through the foregoing external bundles has been determined experimentally by T. Lewis and his associates ('14). They applied their electrodes to the epicardium covering the surface of the node and external surface of the right atrium. They have shown that the excitation process first appears at the node and spreads along these external bundles at a more or less uniform rate. Moreover, they have shown the histological connection of these bundles with the node in the dog heart. It appears that a similar arrangement of bundles is present in the human heart. It should be borne in mind that these superficial bundles overlie the right anterior and posterior crests which have a deep internal position and a more distant septal origin. The excitation process in the crests is, therefore, not readily detected by the electrocardiographic method, when the electrodes are applied to the epicardium. The pectinate muscles which arise chiefly from the crests (fig. 7,) have also a deeper position, but in the walls of the atrium their branches become exposed on the surface where they interlace with the superficial bundles. This is especially true in dog hearts.

3. The right anterior crest

The right anterior crest (figs. 7, 3, and 5, 3) is a flattened muscular band forming the anterior wall of the right atrium, above and to the right of the atrioventricular ring. It is best seen on the internal surface, although it also appears on the external surface (fig. 5, 3). It arises in front of the origin of the right posterior crest from the septum and the head of the sino-auricular node. It curves forward and to the right above the atrioventric-

ular ring, giving rise to the right anterior pectinate muscles. Its anterior or lower margin is attached to the thin fibrous atrioventricular ring. Between the origins of the right anterior and posterior crests there is formed a thin spot. The right anterior crest encircles the base of the right atrium and near the mouth of the coronary sinus interlaces with the terminal pectinate columns of the right posterior crest. From here they are continued as a thin stratum to the atrioventricular node. The right anterior pectinate muscles (fig. 7) number nine to fourteen. The ones in the apex of the right atrial appendage are large. The others are smaller. They arise from the anterior crest singly or in three radiating clusters. The trunks of the pectinate muscles branch out and the branches interlace with those of the posterior pectinate columns. The upper pectinate cluster arises as a strong column from the anterior portion of the atrial septum in front of the origin of the posterior crest. Its pectinate muscles extend toward the apex of the atrial appendage. The middle cluster is usually definite. It forms an external constriction below the base of the atrial appendage. Keith and Flack ('07) designated the anterior crest as the 'annular fibers of the auricle' and McMurrich in Piersol's Anatomy speaks of them as ansiform fasciculi.

From the experiments of T. Lewis, Meakins, and White, it would appear that the excitation process is conducted by the external bundles of the atrium from the sino-auricular node into the anterior pectinate muscles and thence into the anterior crest. However, the fat and vessels in the coronary sulcus raise the epicardium from the anterior crest to such an extent that direct application of electrodes cannot be made.

4. The right posterior crest

The right posterior crest (figs. 7, 4, and 1, 4) is a strong muscular column, called by His the terminal crest, because it forms the boundary between the sinus venosus and the right atrium. It is seen on the internal surface of the atrium and gives rise to the posterior set of right pectinate muscles. External bundles

derived directly from the sino-auricular node enter into its composition. The internal bundles, however, form a large part of the crest. They arise (fig. 1, *R*, 4) in the anterior part of the atrial septum from the septal raphe. They curve upward and to the right in front of the orifice of the superior vena cava and then downward on the right of both venae cavae. They are overlaid by the sino-auricular node. Along its course the crest gives rise to about ten posterior pectinate muscles (fig. 7), and as these are given off the crest diminishes in size. One or two upper pectinate muscles are large and extend into the atrial appendage. The succeeding ones are progressively smaller. In the wall of the atrium the pectinate muscles divide into numerous branches that interlace with those of the anterior pectinate muscles. The lower pectinate muscles are small and extend to the lower right part of the right atrioventricular ring. The lowermost one encircles the orifice of the coronary sinus and is joined by the right leaf of the septum primum (fig. 7, 8) which extends through the (right) valve of the inferior vena cava.

The external bundles have already been described under the external bundles of the right atrium. The uppermost ones run parallel to the sino-auricular node and commence in it as attenuated fibers. They spread out with the pectinate muscles which they cover externally. Below, they are reinforced by the intercaval bundle which spreads downward to the lower part of the right atrioventricular ring.

Keith and Flack ('06-'07) considered that the right posterior crest "probably belongs to the sinus venosus, since it extends beneath the endocardium of the atrium from the position of one venous valve to the other." In the same article, however, they state "that the auricles (atria) are outgrowths from the dorsal wall of the auricular (atrial) canal." The latter seems to be the best view. Hence, the anterior and posterior crests may be regarded as derived from the annular musculature of the atrial canal. As the crests become separated the intervening musculature becomes arranged in the form of an anterior and posterior set of pectinate muscles.

The electrocardiographic results of T. Lewis, Meakins, and White ('14) show that the excitation process spreads from the sino-auricular node to the right atrium along the superficial muscle bundles and along the posterior crest. The mass contraction of the atrium is evidently due to the contraction of the pectinate muscles and their connections with the septal raphe through the anterior and posterior crests.

MUSCULATURE OF THE SINUS VENOSUS

5. The intercaval bundle

The intercaval bundle (figs. 3 and 6, 5) is a large flat one that passes obliquely in the posterior fibrous wall of the sinus venosus. It arises (fig. 7, 5) in the front and left side of the orifice of the superior vena cava from the head of the sino-auricular node and from the uppermost limit of the septal raphe and in many cases a large slip arises in front of the orifice of the right upper pulmonary vein, as shown by Keith and Flack ('07, fig. 5, *f*). The upper margin of the intercaval bundle is in series with the bundles that encircle the orifice of the superior vena cava, the lower margin is in series with the right leaf of the septum secundum (fig. 1, 5). It curves obliquely backward and downward and to the right in the fibrous posterior wall of the sinus venosus. It forms an oblique constriction between the orifices of the venae cavae in the region of tubercle of Lower. Crossing the sino-auricular junction and right posterior crest, it spreads out as a fibrous expansion over the external surface of the lower portion of the right atrium where it forms a superficial stratum. A portion of it covers the posterior and right side of the orifice of the inferior vena cava, as shown in figure 6, 5. Where it crosses the tail of the node it may receive accessions from the node. Its intimate attachment to the posterior crest and the node render its relation to these difficult to determine. Some of its bundles overlap the right surface of the orifice of the inferior vena cava and are inserted into an external fibrous sheath. The more proximal of these pass around the orifice to the region of the coronary sinus. The extent to which this musculature

extends onto the inferior vena cava varies in different hearts, most often it is absent. The entire intercaval bundle is often absent or so feebly developed that it cannot be defined with certainty.

In reference to cardiographic results on this region, T. Lewis says: "These leads cover the root of the cava and overlie strong bands of septal musculature which pass across the line of the lead. It is a region of the dog's heart from which we almost invariably obtain prominent extrinsic effects, and we attribute them to the radiation of currents from muscle lying deeply beneath the contact area."

Keith and Flack ('07, fig. 5, *f*) have clearly illustrated this bundle in the human heart. It is to be noted that the apparent origin of the upper portion of this bundle in front of the orifice of the upper right pulmonary vein seems anomalous. However, a T-stem connects this bundle with the septum; and it seems likely that this portion of the bundle is a deploying in both directions of its narrow septal stem.

6. *The superior vena cava bundles*

The superior vena cava bundles (figs. 3, 5, and 6, *6a*, *6b*) surround the orifice of the vena cava for a distance of 2 cm. or more. They are variably developed in different hearts. All musculature above the sino-auricular node is considered as belonging to the superior vena cava. These bundles consist of a circular and a radial set.

The circular bundles (*6a*) are superficial to the radial ones and in the human and dog hearts they predominate. On the right and chiefly on the front of the orifice they arise from the node in an oblique manner and spread out over the front of the vena cava which they tend to encircle spirally. Others arise from the head of the node and beneath the origin of the interatrial band and from the uppermost limits of the septal raphe in the left wall of the superior vena cava. These spread out over the left and posterior surface of the vena caval orifice where they are in series with the intercaval bundle. In the dog heart, as is shown in

figure 3, *6a*, there is sometimes a distinct bundle that arises obliquely from the node and, sweeping upward over the right surface of the vena cava, divides to encircle the vessel. In the dog heart the musculature of the superior vena cava is quite extensive and surrounds also the orifice of the azygos vein. Eyster and Meek ('13) believe they have shown that the "excitation usually reaches the intercaval region and the superior vena cava before any other regions." The electrocardiographic results of T. Lewis, Meakins, and White ('14) indicate that there is no material difference of the rate of conduction from the sino-auricular node to the vena cava. They have shown that the excitation process in the dog's heart extends radially upward. The variable rate which they obtained is due, as they suggest, probably to the obliquity and spiral arrangement of the vena caval musculature.

The radial bundles (*6b*) appear particularly in the left side, and in some hearts also in the posterior side, of the superior vena cava. They are covered by the circular set. The left ones arise from the uppermost limit of the septal raphe (fig. 5, *6b*) and at the orifice of the vena cava and radiate in an upward and posterior direction. In the wall of the human and dog hearts they form an exceedingly thin stratum. The posterior radial set of muscle bundles is commonly absent in the human heart. When present, they are feeble. They arise from the tail of the sino-auricular node and sweep diagonally upward and to the left over the posterior surface of the vena cava which they tend to surround in a circular direction (fig. 3). They are situated just above the intercaval bundle, from which they are difficult to distinguish. The posterior surface of the superior vena cava is more extensive than the anterior on account of the obliquity with which it joins the sinus venosus. Excepting the circular bundles and, in some instances, the posterior radial bundles, it is fibrous between the vena caval musculature and the oblique intercaval bundle.

The bundles around the inferior vena cava. The inferior vena caval bundles (figs. 4, 6, and 7) are derived from the septum primum (8) and from the intercaval bundle. They extend

downward over the vena cava, but do not form circular bundles around it. The right side of the orifice is limited by the right posterior crest. The lower portion of the intercaval bundle (5) spreads downward over the posterior and right surface of the inferior vena cava and terminates in a fibrous expansion. The upper portion of the right leaf of the septum primum (fig. 7, 8) spreads over the left and posterior sides of the inferior vena cava and terminates in a fibrous expansion. The posterior surface of the inferior vena cava between the right leaf of the septum primum and the intercaval bundle is usually fibrous. The lower portion of the right leaf of the septum primum forms a strong band in front of the orifice of the inferior vena cava along the base of the (right) valve of the inferior vena cava. This frequently forms a sharp fold between the orifice of the inferior vena cava and that of the coronary sinus.

Keith and Flack ('07, fig. 3) have illustrated the bundles on the dorsal surface of the inferior vena cava.

7. The right leaf of the septum secundum

The septum secundum (figs. 1, 7, 2, 13, and 7, 7) or limbus of the oval fossa is a strong muscular bundle which arises in the septal raphe (fig. 2, *R*), chiefly on the right side, and arches backward over the oval fossa. It is divisible into a right and a left leaf, but the separation of the leaves is to some extent an arbitrary matter.

The right leaf of the septum secundum (figs. 1, 7, and 7, 7) belongs to the sinus venosus. It arches over the left side of the orifice of the inferior vena cava, above and posterior to the orifice of the coronary sinus. There it is inserted into a fibrous expansion over the inferior vena cava. Above, it is in series with the intercaval bundle, but it is situated deeply in the atrial junction. A portion of this bundle turns to the left onto the orifice of the coronary sinus.

8. *The right leaf of the septum primum*

The septum primum (figs. 2, 8, and 7, 8) is a large bundle of muscle tissue that forms the lower boundary of the oval fossa. It is joined by fibrous tissue to the ventricular septum. It is divisible into two distinct portions, the right leaf for the sinus venosus and the large left leaf for the base of the left atrium. The two leaves have independent origins and are almost entirely separate. Since the left leaf belongs to the left atrium, only the right leaf will be described here.

The right leaf of the septum primum (fig. 7, 8) arises from the septal raphe on the right side in front of the oval fossa, and passes downward and to the right in the (right) valve of the inferior vena cava, that extends along the front of the orifice of the vessel, and intermingles with the terminal expansions of the right crests and intercaval bundle. This leaf passes, therefore, between the orifices of the inferior vena cava and coronary sinus, to both of which it contributes musculature. Some of its bundles sweep upward and form the posterior border of the oval fossa.

The lower portion of this bundle, that may be called the septocoronary bundle, arises from the lowermost portion of the septal raphe and spreads out in a fan-shaped manner in front of the coronary sinus covering the right side of the atrioventricular node (fig. 1, *A.V.N.*). The bundles that form its right surface appear to be attached to the fibrous upper extent of the inter-ventricular septum, but its deeper bundles stand in intimate relation to the atrioventricular node. T. Lewis has shown that muscular contraction in this region appears early, as is indicated by an early extrinsic deflection on the cardiogram. Eyster and Meek have shown that this region receives the excitation process early before it has spread fully into the right atrium.

Keith and Flack ('07) have shown that the musculature of the venous valve, which is here called the right leaf of the septum primum, is formed by an infolding of the atrial wall at the sino-auricular junction. To the right this musculature spreads out and joins freely with that of the right atrium.

9. Musculature of the coronary sinus

The musculature of the coronary sinus (figs. 4 and 6, *C. S.*) is for the most part circular. At the orifice, the right leaf of the septum primum (fig. 1) and of the septum secundum and the septo-coronary bundle extend into the coronary sinus. A pectinate ring of musculature derived from the right posterior crest surrounds the orifice. As the sinus is applied close to the posterior wall of the left atrium, it is partly buried in its musculature and receives longitudinal accessions from the left leaf of the septum primum and septum secundum. In the bovine heart the sinus is a continuation of the left common cardinal system and is surrounded by musculature for a distance of several inches.

Keith and Flack ('07, fig. 3) have shown that the bundles of the coronary sinus are continuous with those of the sinus venosus and the left atrium.

MUSCULATURE OF THE LEFT ATRIUM

10. The left anterior crest

The left anterior crest (figs. 5, and 8, *10*) is a large bundle that is formed in large part as a continuation of the lower portion of the left extremity of the interatrial band. It is seen on the outer surface of the atrium. The inner bundles commence in the septal raphe in front of the left septoatrial bundle. It extends to the left along the upper extent of the atrioventricular ring to which its thin lower margin is attached. Its upper margin is thick and gives origin to a feeble group of anterior pectinate muscles. On the left side of the atrium it interdigitates with the bundles of the posterior crest. Here its outer fibers pass backward around the base of the left atrium, intermingling with those of the left leaf of the septum primum. The anterior pectinate muscles that arise from the left anterior crest, extend upward as several short trunks that branch out along the left margin of the left atrial appendage and interlace with the intermediate pectinate muscles from the interatrial band.

Since the left anterior crest is in large part a continuation of the interatrial band, it is clear, from the experiments of Bachmann ('16) that the excitation process reaches this region of the left atrium chiefly along the band.

11. The left posterior crest

The left posterior crest (figs. 5 and 8, *11a*, *11b*) is a broad bundle, the superficial portion of which (fig. 5, *11a*) is a continuation of the upper part of the interatrial band, and the deep portion of which (fig. 8, *11*) arises from the septum in series with the septoatrial bundle. It passes to the left around the base of the left atrial appendage in front of the orifices of the left pulmonary veins. It gives origin to the small posterior set of pectinate muscles. Posteriorly it interdigitates with the left anterior crest, forming the triangular area which is attached to the inferior margin of the left atrioventricular ring. It lies in front of the septopulmonary (fig. 8, *12*) and septoatrial (fig. 8, *14*) bundles and forms a distinct constriction around the base of the left atrial appendage. The left posterior pectinate muscles are several in number. Their branches interlace with those of the anterior set. The left atrial appendage is a narrow forward prolongation of the left atrium. The left extremity of the interatrial band extends along the anterior margin, and midway between the base and apex it divides and embraces the appendage. This gives rise to an immediate set of pectinate muscles that occupy a superior position. In the human heart the posterior set of pectinate muscles is above the anterior set, but in the beef and dog hearts they are posterior. For morphological reasons this designation has been retained for the human heart.

Bachmann ('16) has indicated that the spread of the excitation process to the left atrial appendage is along the interatrial band. This forms the superficial stratum of the left posterior crest. The deeper stratum, however, arises from the septal raphe.

12. Septopulmonary bundles

Septopulmonary bundles (figs. 4, 6, and 8) are the large flat external bundles that cover the upper and posterior surface of the left atrium between the pulmonary veins and encircle the orifices of the veins. They arise deeply from the left surface of the septal raphe (fig. 2, *12*) behind the interatrial band and curve upward and to the left, chiefly in front of the orifice of the upper right pulmonary vein, and above the interatrial band, where they come to the external surface. They spread out as six bands, over the upper and posterior surface of the left atrium.

The anterior septopulmonary bundle (*12a*) arches above the interatrial band, extends to the left in front of the left superior pulmonary vein as the superficial stratum covering the left posterior crest. Below the orifice of the vein it curves backward and superficially over the back of the atrium between the left inferior pulmonary vein and the coronary sinus. It covers the left leaf of the septum primum.

The left intervenous septopulmonary bundle (*12b*) extends upward as a deep stratum of the foregoing and to the left between the left pulmonary veins and joins the anterior septopulmonary bundle.

The left posterior septopulmonary bundle (*12c*) arises with the foregoing and spreads backward and to the left over the left atrium between the left and right pulmonary veins. Behind the left lower pulmonary vein it spreads out into the anterior septopulmonary bundle and curves to the left below the lower left pulmonary vein. Some of the fibers of the foregoing bundles extend onto the left pulmonary veins and give origin to the fiber bundles that encircle the veins in a radiate and somewhat circular manner.

The right posterior septopulmonary bundle (*12d*), like the other, extends backward over the upper surface of the left atrium. Spreading out over the posterior surface of the atrium, it curves to the right below the right lower pulmonary vein. It overlies the left leaf of the septum secundum and septum primum. A portion of it extends to the back of the inferior vena cava bridging over the atrial junction, interlacing with the septal bundles.

The right intervenous septopulmonary bundle (12e) arches over the orifice of the right upper pulmonary vein. Between the veins it turns downward, toward the atrial junction it spreads over the left leaf of the septum secundum. This and the foregoing bundle give rise to bundles that encircle the orifice of the lower right pulmonary vein.

The right septopulmonary bundle (fig. 1, 12f) arises in the septal portion of the node and extends upward on the right wall of the upper right pulmonary vein and curves downward along its right wall. It gives rise to circular fiber bundles that surround the orifice of the upper right pulmonary vein. It may be regarded as the uppermost portion of the left leaf of the septum secundum. With the right intervenous bundle it gives origin to an oblique band that extends to the right onto the posterior surface of the inferior vena cava bridging over the atrial junction. This muscular bridge (fig. 6, 12e) is not always present and may be fibrous.

Keith and Flack ('07) have figured these bundles. They consider them a part of the interatrial band. The origin of these bundles from the septal region behind the band, however, is clear (fig. 2, 12). It is also apparent that they belong to the same superficial stratum as the band (fig. 5, 12).

13. *The left leaf of the septum secundum*

The left leaf of the septum secundum (figs. 2 and 6) commences in septal raphe (fig. 2, 13) and, extending backward, forms the right or septal wall of the left atrium in front and below the orifices of the right pulmonary veins. Below the lower vein it turns to the left, superficially to the left leaf of the septum primum (fig. 2, 15) with which it intermingles and becomes spread over the posterior surface of the left atrium (figs. 4 and 6, 13).

14. *The left septoatrial bundle*

The left septoatrial bundle (figs. 2 and 8, 14) is a large flat bundle on the inner surface of the left atrium. It rises in the septal raphe in front of the oval fossa and below the origin of

the left leaf of the septum secundum, as shown in the figures. It sweeps upward and to the left into the anterior wall of the atrium and backward into the superior and posterior walls between the right and left pulmonary veins. Some of its bundles pass around the base of the atrial appendage with the left posterior crest (fig. 8) and in front of the orifices of the left pulmonary veins for which they provide an inner circular stratum. Posteriorly, the septoatrial bundle spreads out and intermingles with the left leaf of the septum primum. So complete is the fusion of these bundles that it is difficult to determine that the latter is not a continuation of the septoatrial bundle.

Externally the left septoatrial bundle is covered by the anterior and posterior crests and by the septopulmonary bundles. On the posterior surface, however, it appears as a triangular area between the diverging limbs of the left posterior septopulmonary bundles (fig. 6, 14).

The bundles that surround the orifices of the pulmonary veins are derived from the external septopulmonary stratum of bundles (fig. 6, 12, *b, c, d, e*), and from the internal or septoatrial stratum of bundles (fig. 8, 14). Those for the right veins are chiefly from the former, those of the left veins are largely from both strata. The bundles encircle the orifices, although sparse radiate bundles may occur. On the inner surface below the lower right pulmonary veins and behind the oval foramen the left leaf of the septum primum gives off a concentration area which gives rise to fiber bundles that encircle the lower right pulmonary vein on its inner surface (fig. 2, 13).

15. The left leaf of the septum primum

The left leaf of the septum primum (figs. 2 and 8, 15) is a large flat bundle most distinctly seen on the interior of the left atrium. It arises from the lowermost portion of the septal raphe on the left side of the atrioventricular node region below the oval fossa (fig. 2, 15). It sweeps to the left along the posterior portion of the left atrioventricular ring as far as the base of the left appendage where it meets and intermingles with the left

crests. Its lower margin is attached to the atrioventricular ring, where it appears on the external surface and gives off some longitudinal bundles to the coronary sinus (fig. 4, 15). The septopulmonary bundles overlie and intermingle with its upper margin. The left septoatrial bundle (fig. 6, 14) joins the deep portion of its upper margin with which it appears to be continuous.

Keith and Flack ('07) have figured this bundle on the posterior surface. They consider it as a portion of the annular bundles of the atrial canal.

Experiments to determine primary negativity over this region and over the posterior and superior wall of the left atrium have been negative (Eyster and Meek). It is clear that there is no impulse forming tissue in this region.

A NOTE ON THE NERVE SUPPLY OF THE ATRIA

The atria are supplied by both the right and left vagosympathetic nerves. *a.* On the right side usually three nerves reach the heart. These pass down in front of the right pulmonary artery. The lower two unite above the right pulmonary veins and terminate in a gangliform enlargement in the septum on the left side of the orifice of the superior vena cava. From this terminus, branches supply the interatrial band, intercaval bundle, and other bundles that radiate from the septal raphe. One or two slender filaments pass to the left anterior crest along the left limb of the interatrial band.

b. The left vagosympathetic cardiac nerves terminate similarly in the left atrium above the base of the left atrial appendage and the upper pulmonary vein. Filaments from this terminus supply the left anterior and the left posterior crests, septopulmonary, and left septoatrial bundles. A small filament may pass to the right in the interatrial band as far as the septum.

Much of the literature that deals with the subject is concerned with experimental work. The figures of Quain, Porier and Sharpey, Toldt, Keith and Flack, and Spalteholtz show external views of the atrial musculature.

BIBLIOGRAPHY

- BACHMANN 1916 *Am. Journ. of Physiol.*, vol. 41, p. 309.
EYSTER AND MEEK 1914 *Heart*, vol. 5, p. 119.
GANter AND ZAHN 1912 *Archiv f. d. Ges. Physiol.*, Bd. 141, S. 335.
KEITH AND FLACK 1907 *Journ. of Anat. and Physiol.*, vol. 41, p. 172.
LEWIS 1910-11 *Heart*, vol. 2, p. 23.
LEWIS, MEAKINS AND WHITE *Philos. Transact. of R. S. of London, ser. B*, vol. 205, p. 375.
LEWIS AND OPPENHEIMER 1910 *Heart*, vol. 2, p. 147.
MEEK AND EYSTER 1914 *Heart*, vol. 5, p. 227; *Am. Journ. of Physiol.*, vol. 34, p. 368.
SCHLOMOVITZ, EYSTER AND MEEK 1915 *Am. Journ. of Physiol.*, vol. 37, p. 177.
SPALTEHOLZ *Hand Atlas*, vol. 2, figs. 413, 414.
TOLDT *Atlas*, figs. 958, 959.
WYBAUW 1910 *Arch. Internat. d. Physiol.*, T. 10, p. 78.

PLATE 1

EXPLANATION OF FIGURES

1 Bundles that radiate from the septal raphe in the right surface of the atrial septum of a human heart. The endocardium has been removed.

2 Bundles that radiate from the septal raphe in the left surface of the atrial septum of a human heart. The endocardium has been removed.

| | |
|--------------------------------------|---------------------------------------|
| 1, interatrial band | <i>A.V.N.</i> , atrioventricular node |
| 2, external bundles of right atrium | <i>A.V.R.</i> , atrioventricular ring |
| 3, right anterior crest | <i>C.S.</i> , coronary sinus |
| 4, right posterior crest | <i>I.V.C.</i> , inferior vena cava |
| 5, intercaval bundle | <i>M.O.</i> , mitral orifice |
| 6, superior vena caval bundles | <i>O.F.</i> , oval fossa |
| 7, right leaf of septum secundum | <i>P.A.</i> , pulmonary artery |
| 8, right leaf of septum primum | <i>P.M.</i> , pectinate muscles |
| 9, musculature of the coronary sinus | <i>P.V.</i> , pulmonary vein |
| 10, left anterior crest | <i>R.</i> , raphe |
| 11, left posterior crest | <i>R.A.</i> , right atrium |
| 12, septopulmonary bundle | <i>S.A.N.</i> , sino-auricular node |
| 13, left leaf of septum secundum | <i>S.V.C.</i> , superior vena cava |
| 14, left septoatrial bundle | <i>T.O.</i> , tricuspid orifice |
| 15, left leaf of septum primum | <i>Vent.</i> , ventricle |

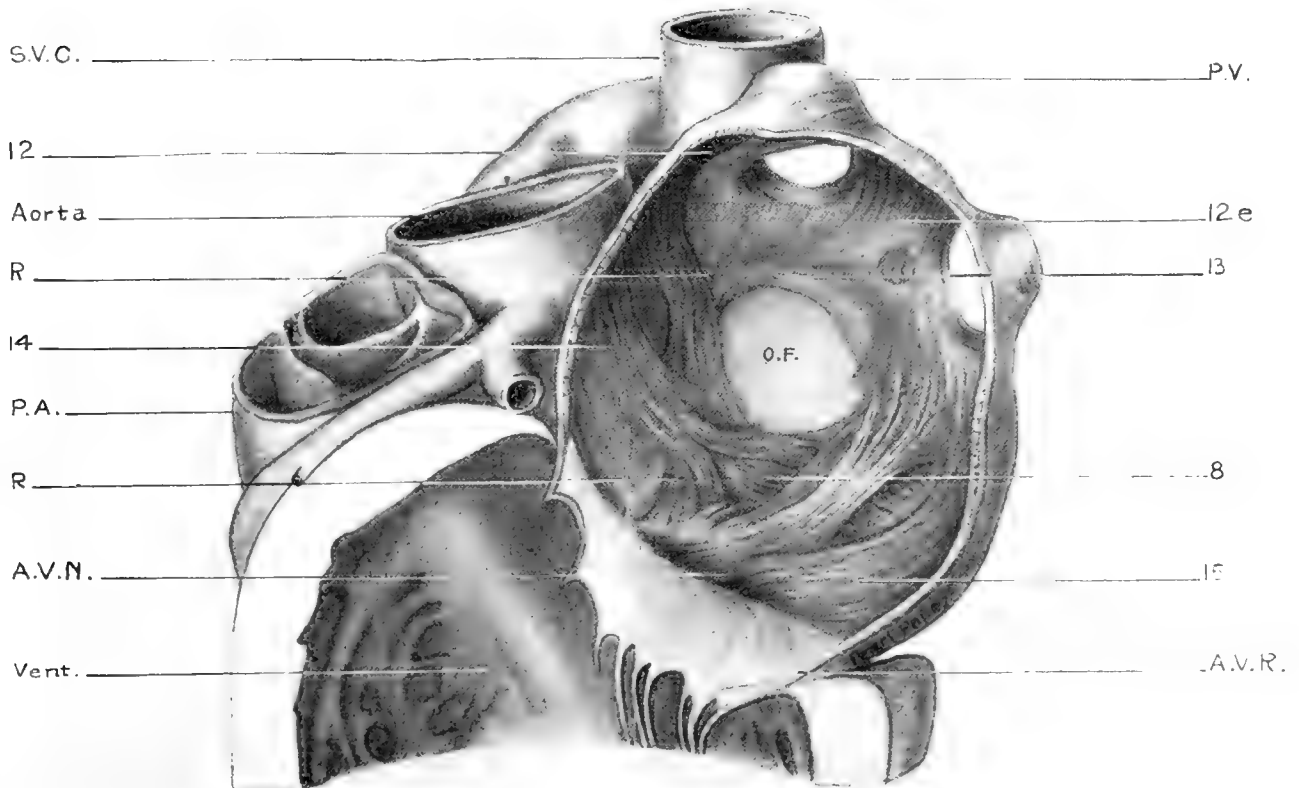
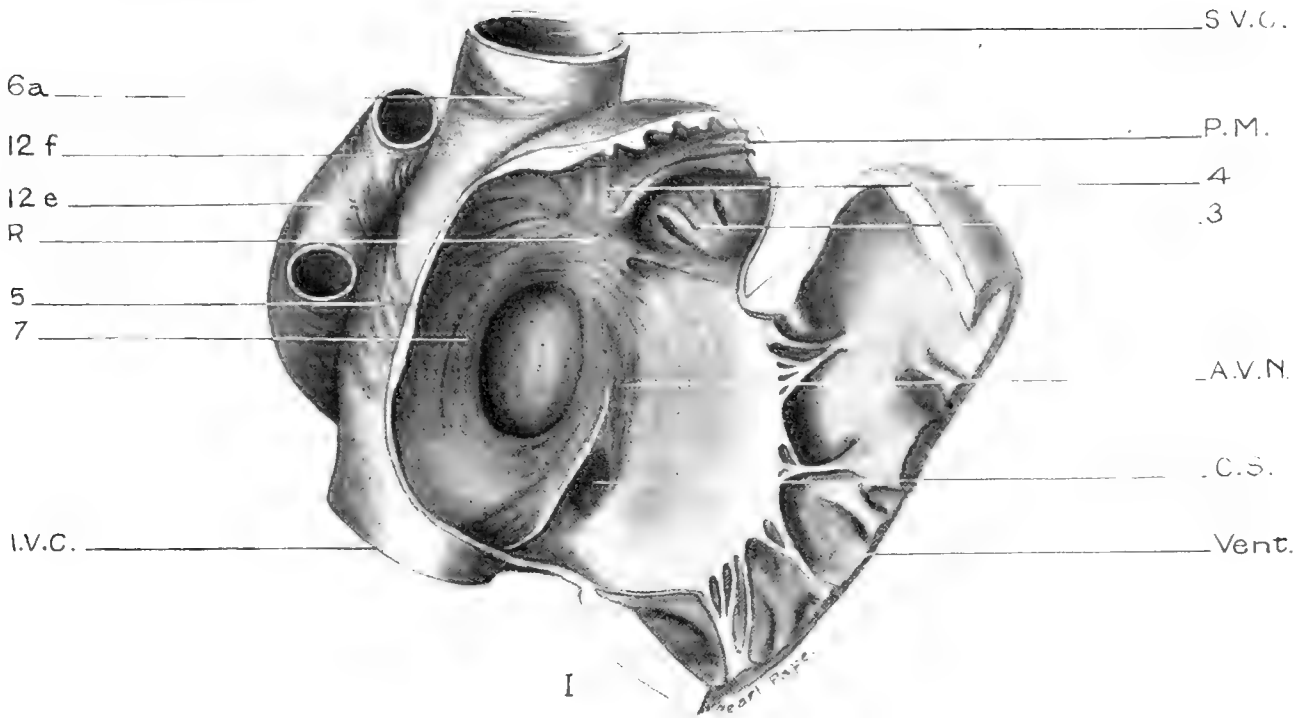

PLATE 2

EXPLANATION OF FIGURES

3 External bundles of the right atrium of the dog heart, viewed from the right side. In this heart the 'concentration area' of T. Lewis was strikingly developed. An unusual bundle extends onto the right surface of the superior vena cava.

4 External bundles of the left atrium of a human heart, viewed from the left side. The visceral pericardium and the coronary vessels have been removed. The left atrial appendage is opened along its margin to show the intermediate group of pectinate muscles.

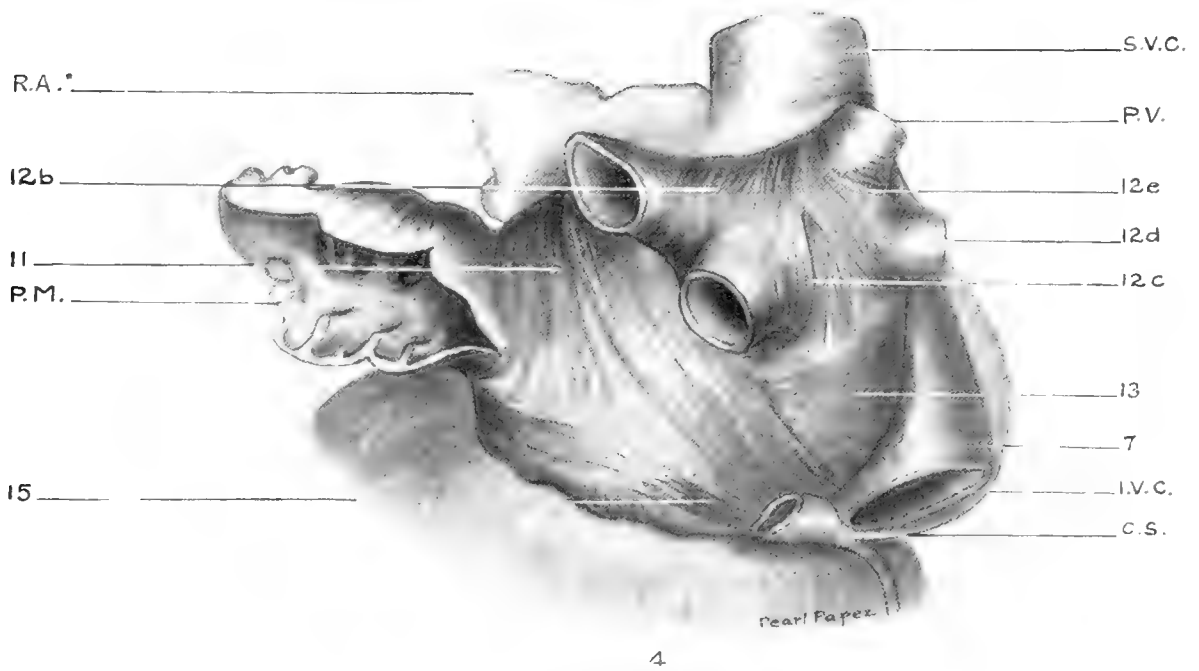
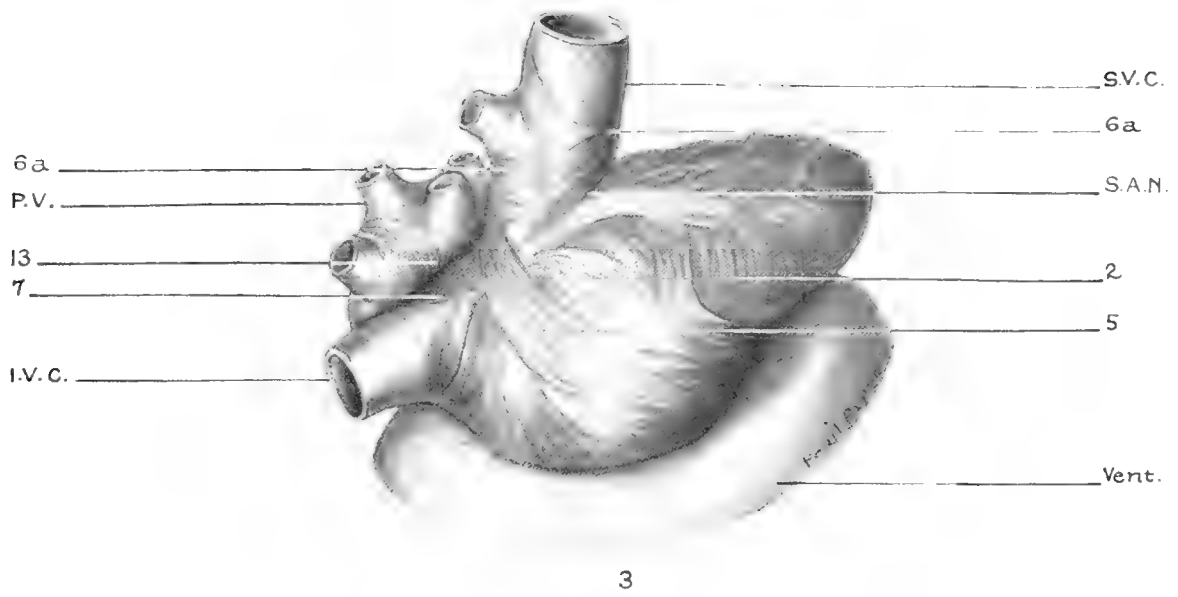

PLATE 3

EXPLANATION OF FIGURES

5 External bundles seen on the anterior surface of the human heart. The visceral pericardium and coronary vessels have been removed. The atria are in a distended or diastolic condition.

6 External bundles seen on the posterior surface of the human heart. The visceral pericardium and coronary vessels have been removed. The atria are in a distended or diastolic condition.

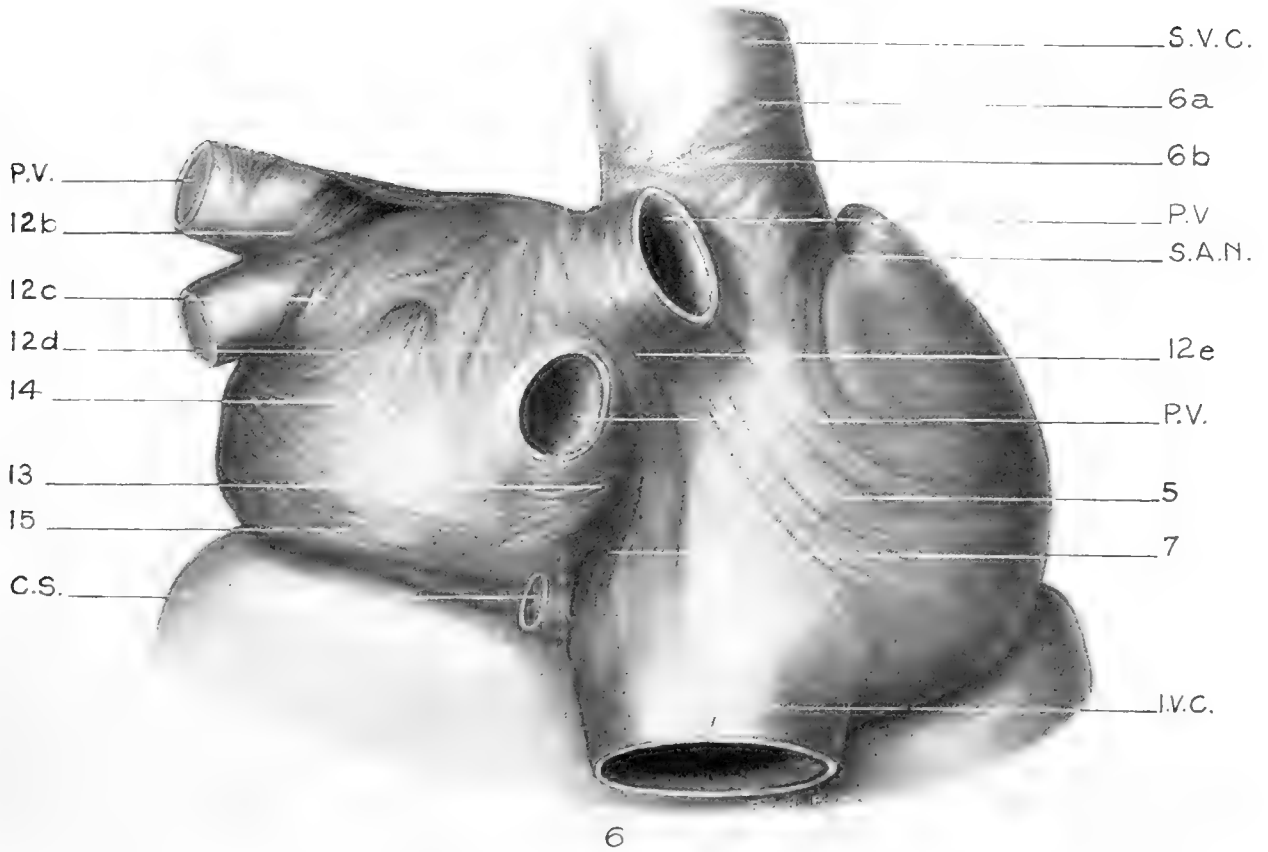
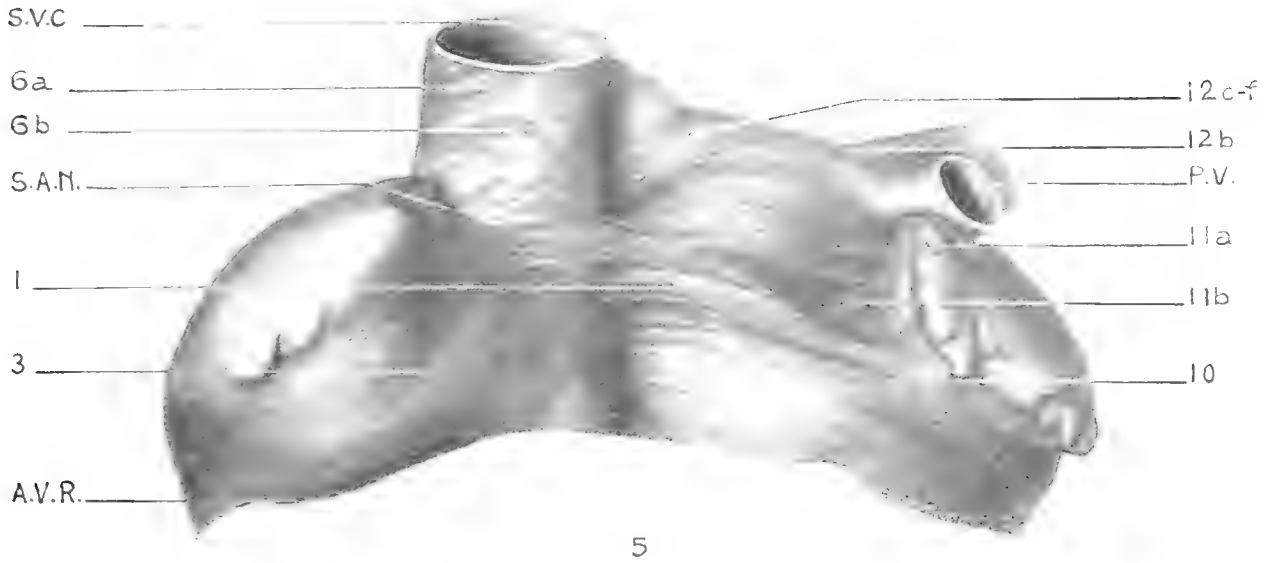
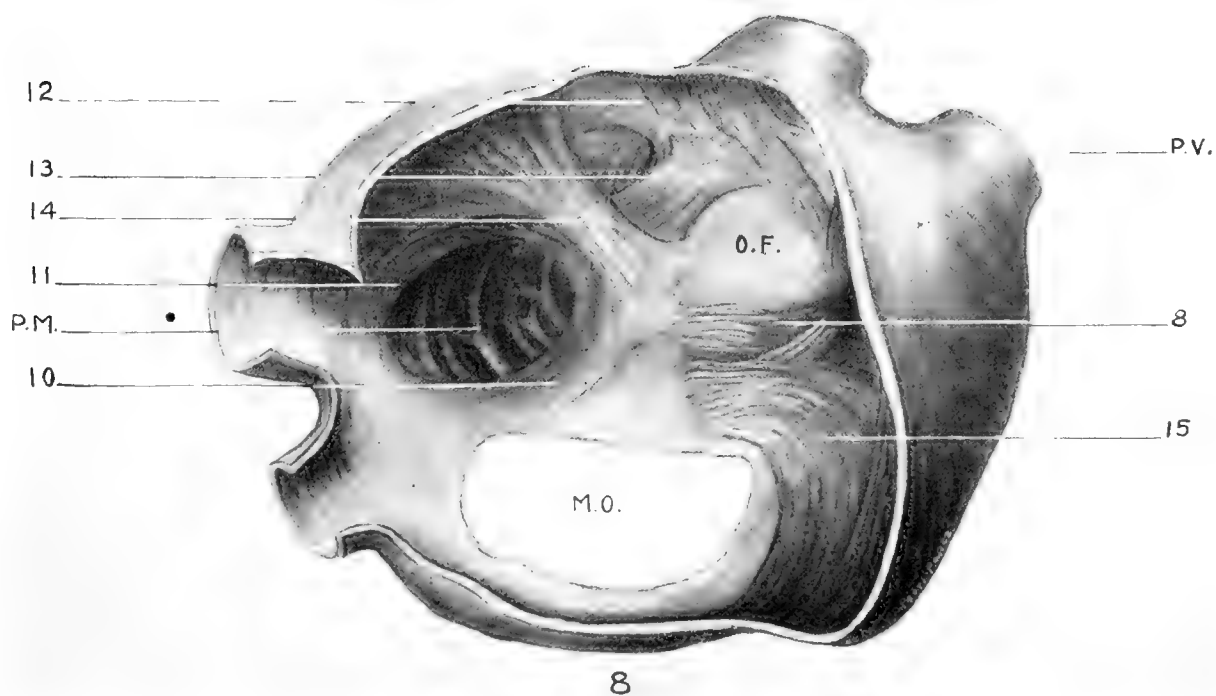
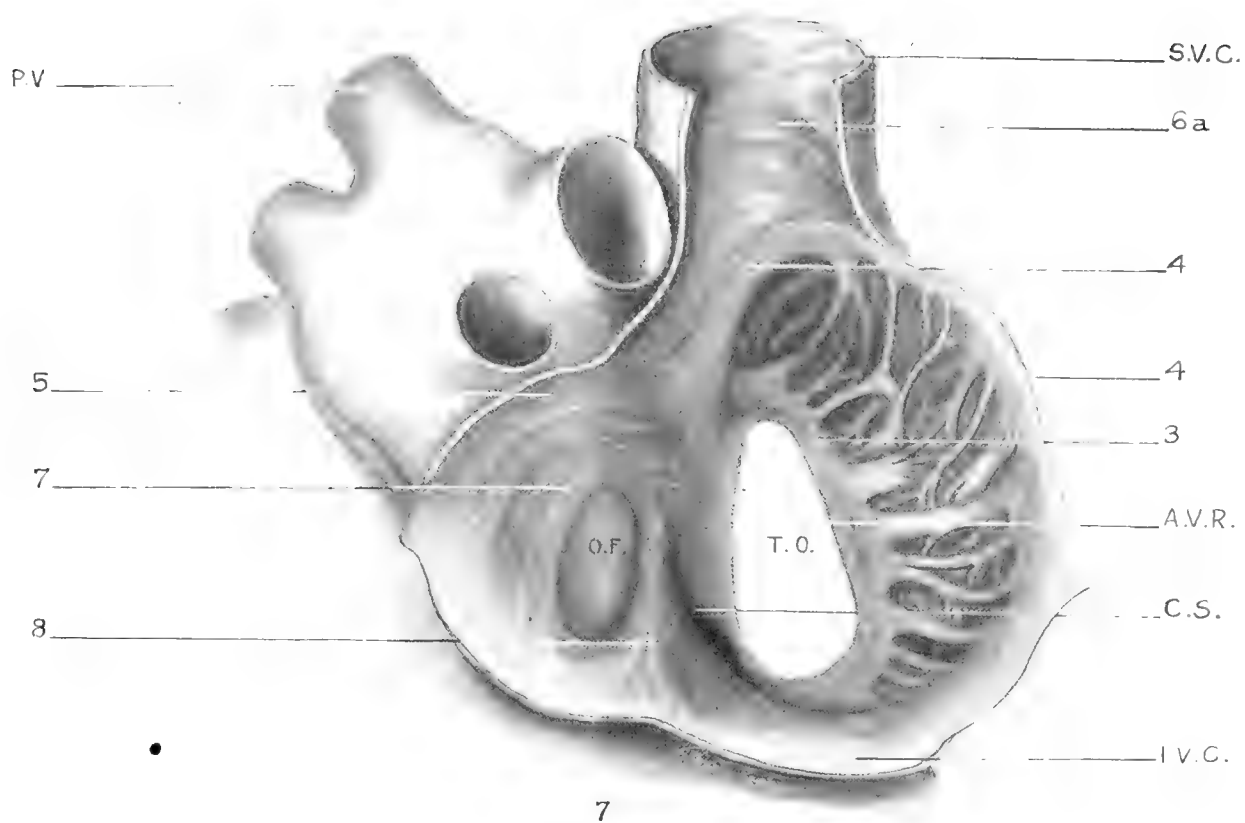

PLATE 4

EXPLANATION OF FIGURES

7 Internal bundles of the right atrium of the human heart, posterior view. The vena cavae have been opened through their posterior walls. The inferior vena cava is spread widely open. The endocardium has been removed.

8 Internal bundles of left atrium of the human heart, posterior view. The posterior wall of the atrium has been cut and widely opened. The endocardium has been removed.



Resumen por el autor, Harvey Ernest Jordan,
Universidad de Virginia.

Nuevos estudios sobre la médula ósea roja.

I. Experimentos. II. Citología, con especial mención de los datos que indican la existencia de una actividad intracelular hemocitogénica en las células gigantes y la significación de las llamadas figuras mitóticas en estas células.

La médula ósea roja del conejo contiene tres variedades principales de células gigantes: megacariocitos, formas mononucleadas derivadas a consecuencia del crecimiento excesivo del hemoblasto; polimorfocariocitos, formas con núcleo polimorfo o lobulado derivadas del megacariocito por división directa incompleta del núcleo; y policariocitos, formas multinucleadas derivadas de formas con núcleo lobulado a consecuencia de la división completa de dicho núcleo, que da lugar a la formación de núcleos de menor tamaño. Variedades celulares comparables a las mencionadas existen también en el saco vitelino del embrión de cerdo. Algunas células gigantes de la variedad multinucleada retienen en pequeño grado la capacidad del hemoblasto ancestral originario para transformarse en eritrocitos intracelulares. Las células gigantes de la médula normal y saco vitelino carecen de función fagocítica. Los granulocitos polimorfonucleados de tipo eosinófilo especial que aparecen con mayor o menor abundancia dentro del protoplasma no deben considerarse como una diferenciación intracelular o una ingestión fagocítica, sino que deben interpretarse como invasiones pasivas secundarias debidas al carácter relativamente menos resistente del citoplasma de la célula gigante, cuando se compara con el del parenquima general de la médula, contra la presión ejercida por un foco de leucocitos en vías de activa proliferación, o como invasiones activas por parte de fagocitos polimorfos, de un citoplasma en vías de desintegración. Estas células gigantes no se dividen por mitosis. Los grupos de partículas cromáticas que se encuentran algunas veces simulando placas de cromosomas en husos multiplares, son simplemente agregaciones casuales de cromatina, características de procesos degenerativos. Las agregaciones no van acompañadas de fibras arcoplásmicas. Estas figuras son simplemente simulacros de procesos mitóticos que representan estados finales de la desintegración de las células gigantes.

FURTHER STUDIES ON RED BONE-MARROW

I. EXPERIMENTAL

II. CYTOLOGIC, WITH SPECIAL REFERENCE TO THE DATA SUGGESTING INTRACELLULAR HEMOCYTOGENIC ACTIVITY ON THE PART OF THE GIANT-CELLS, AND TO THE SIGNIFICANCE OF THE SO-CALLED MITOTIC FIGURES IN THESE CELLS

H. E. JORDAN

Department of Histology and Embryology, University of Virginia Medical School

ONE PLATE (TWENTY-SEVEN FIGURES)

CONTENTS

| | |
|--|-----|
| I. Experimental..... | 287 |
| Introduction..... | 287 |
| Description..... | 288 |
| II. Cytologic..... | 290 |
| Intracellular erythrocytogenesis..... | 290 |
| a. Review of literature..... | 290 |
| b. Description..... | 292 |
| c. Discussion..... | 294 |
| The significance of the so-called mitotic figures..... | 298 |
| a. Review of literature..... | 298 |
| b. Description..... | 301 |
| c. Discussion..... | 302 |
| Summary..... | 308 |
| Bibliography..... | 310 |

I. EXPERIMENTAL

INTRODUCTION

In a recent paper on the giant-cells of the yolk-sac and the red bone-marrow (12), in which evidence was presented from a study of a specimen of pathologic (typhoid) marrow indicating that under certain abnormal conditions occasional giant-cells may assume an erythrocytogenic function, it was stated that

work was under way designed to test the hypothesis that the giant-cells of normal red bone-marrow represent potential multiple hemoblasts like those of the yolk-sac, by a study of the marrow and the spleen during the regenerative stages following experimental hemorrhage. This work has now progressed to a point where a report of results seems warranted. The results do not disprove the essential accuracy of this hypothesis, but neither do they give to it any support. The sections of this posthemorrhagic marrow were subsequently employed, together with the control material, for a study of the significance of the alleged mitotic figures in the giant-cells.

DESCRIPTION

Two rabbits were used in this study. They were deprived of an amount of blood, drawn from the femoral vein, equal to 2 per cent of their weight.¹ Five days later they were killed, and specimens of spleen and of marrow from the femur were fixed severally in a mixture of 10 parts of formalin to 100 parts of a saturated normal-salt solution of corrosive sublimate and in Helly's fluid. The stained sections of marrow showed extensive hemopoietic activity, but the giant-cells were not appreciably different from, nor more numerous than, those of normal controls, the marrow from which was similarly fixed and stained. The spleen also showed no increase in the number nor any change in the character of the very few relatively small giant-cells.

More favorable results were to be expected from the marrow of the guinea-pig, for here larger numbers of the giant-cells are of the multinucleated type. It was assumed that these more extensively lobulated and multinucleated giant-cells were at least one step nearer the stage where under appropriate hemogenic stimuli intracellular erythrocytes could differentiate, and that in consequence the relatively intensified posthemorrhagic hemopoiesis would involve these potential multiple hemoblasts.

¹ In these experiments I received valuable aid from Prof. J. H. Neff and Dr. D. C. Smith, of the University of Virginia Hospital staff.

But the giant-cells of the red marrow of the femur of a guinea-pig of 400 grams' weight, from which 10 cc. of blood had been taken directly from the heart, were after five days of regenerative activity on the part of this marrow not essentially different from those of normal marrow.

I then resolved to try the effect of a twice-repeated bleeding. From a guinea-pig weighing 420 grams, 10 cc. of blood was taken directly from the heart on December 23rd. On January 8th another 10 cc. was removed. Before killing this animal four days later 12 cc. of blood was removed, in order to free the marrow as far as possible from circulating blood. Hemopoietic activity was intense in the femur, but the giant-cells again gave no evidence of active participation in the erythrocytogenic process.

It was then decided to experiment with pigeons. The special point of value of this material seemed to be the absence of giant-cells in the red marrow. It seemed reasonable to suppose that possibly the increased posthemorrhagic hemogenic demands might stimulate the potential giant-cell progenitors to develop into genuine megakaryocytes, with erythrocytogenic capacity. Two pigeons of 300 grams' weight were aspirated; from one 5 cc. of blood was removed, from the other 8 cc. The first was killed four and one-half days later, the second five days later. The marrow from these femurs showed intense hemopoietic activity, but no giant-cells were discernible.

From the results of these experiments I draw the conclusion that sublethal experimental hemorrhage is not an adequate condition to stimulate intracellular erythrocytogenesis in giant-cells of the red bone-marrow of the guinea-pig and the rabbit, nor to induce giant-cell formation in marrow normally lacking such elements, as in the pigeon. Apparently the intense hemopoietic activity obtaining normally in the yolk-sac is not the specific factor which induces the slight erythrocytogenic activity of the giant-cells of this hemopoietic organ. The fact that a similar activity on the part of these cells occurs in certain pathologic marrows, for example typhoid marrow, suggests that the causative factor may be the presence of a toxic agent following

regressive and disintegrative changes in the atrophying yolk-sac and the morbid marrow, respectively. The experimental evidence suggests that the intracellular erythrocytogenic activity of the 'hemogenic giant cells' is of negligible physiologic significance.

The various microscopic preparations of the red bone marrow of the rabbit and the guinea-pig offered a favorable material for the study of the enigmatic and disputed significance of the so-called mitotic figures, variously atypical and apparently multipolar, of the giant-cells, and of the data suggesting an intracellular erythrocytogenic function of these cells. It will conduce to a simplification of the analysis of the complete problem to consider the latter matter first.

II. CYTOLOGIC

INTRACELLULAR ERYTHROCYTOGENESIS

Review of literature

This phase of the subject involves the question of the origin of the multiple nuclei of the polykaryocytes and the significance of the occurrence of granulocytes and erythrocytes in the giant-cell cytoplasm. Arnold (1, 2) describes a mode of nuclear division in the rabbit's marrow which he terms 'indirect fragmentation.' This he claims is followed by a division of the cytoplasm, which produces separate mononucleated and polymorphonucleated leucocytes. According to Arnold, therefore, these cells divide by a method essentially amitotic, an intermediate phase of which process is represented by a multinucleated giant-cell. Heidenhain (8) recognizes amitotic nuclear multiplication, but regards multipolar mitosis, unaccompanied by cytoplasmic division, as the more important and the preponderant mode of nuclear proliferation. He interprets the presence of granulocytes as the result of an invasion, not phagocytosis. Pugliese (15) interprets the presence of erythrocytes and leucocytes in the giant-cell cytoplasm as the expression of an endogenous hemocytogenic capacity. Foà (7) also describes an intra-

cellular origin of erythrocytes from giant-cells. Van der Stricht (17) ascribes to the giant-cells of marrow the function of ingesting the nuclei of enucleating erythrocytes.

According to Dickson (5), the giant-cell with polymorphous nucleus becomes multinucleated by an exceedingly complicated series of nuclear alterations which he describes as 'incomplete division by mitosis.' He interprets the phenomena described by Arnold as 'indirect fragmentation,' as the pyknotic changes characteristic of degenerating giant-cells. He regards all cellular inclusions as the result of phagocytosis, and denies any hemopoietic function on the part of the medullary giant cells.

Van Bambeke and Van der Stricht² describe the origin of the polymorphous nucleus of the so-called 'megakaryocytes' of red bone-marrow as the result of fusion of a large number of small daughter-nuclei derived from repeated multipolar mitoses. Such polymorphokaryocytes may later, according to their view, divide into similar daughter-cells by a long-retarded cytoplasmic division. The polykaryocytes would therefore represent a transient phase immediately following a multipolar mitosis.

Denys (4) claims that the giant-cells divide both by mitosis and by amitosis. The latter method is involved in the hemocytogenic activity of these cells, by which both leucocytes and erythrocytes are said to be produced. From the viewpoint of our present interest, the article by Denys is the most important of the afore-mentioned group and calls for detailed consideration. Denys derives the polymorphokaryocyte (figs. 3, 7, and 8)³ from the megakaryocyte (figs. 1 and 2); the former becomes a polykaryocyte (figs. 4, 16, and 17) by completion of the constrictions in the lobulated nucleus to form discrete smaller nuclei. About these separated nuclear 'buds' the cytoplasm is said to differentiate in a manner to produce intracellular blood-cells, both leucocytes and erythrocytes (figs. 8 and 9). Of the several hundred

² The original paper was not accessible to me. I quote here from a reference to this work in a paper by Van der Stricht and Todd. (The Johns Hopkins Hospital Reports, vol. 19, p. 34.)

³ Unless otherwise specified, all references to figures are to those accompanying this article. These figures include types of all varieties of giant-cells illustrated in the articles cited in the text.

endogenous blood-cells illustrated in Denys' figures, however, only two or three have the nuclear characteristics of an erythrocyte. The practically exclusive type of endogenous cell is the polymorphonucleated granular leucocyte, presumably the special granulocyte with fine eosinophilic granules. These cells fill the giant-cell cytoplasm, meanwhile compressing, consuming, and eventually destroying the giant-cell nucleus, until the original cell becomes a mere cyst filled with the endogenous leucocytes. Eventually the cyst is said to rupture and to free the new-formed eosinophilic granulocytes. In a section of one such cyst eighty cells can be counted; the complete cyst may well have included several hundred leucocytes. Denys concludes that this series of events signifies a normal hemogenic function on the part of these giant-cells, involving a genuine amitotic division. Heidenhain would interpret these phenomena as the result of the invasion of the giant-cell cytoplasm by phagocytic leucocytes; Dickson as signifying phagocytosis of polymorphs on the part of the giant cells. Denys' conclusion will be further discussed below.

Description

This chapter will only include a description of those cells in my preparations which relate to the process which Denys describes as division by 'stenose,' a process interpreted as leading to the formation of intracellular leucocytes. In figure 1 is illustrated a cell which represents the beginning of the giant-cell series. It is essentially an enlarged hemoblast. It traces back to the typical hemoblast of hemopoietic tissues; and forward, by small gradations, to a cell like that illustrated in figure 2. The latter cell is much larger and contains a reniform or more deeply crescentic, frequently intensely staining nucleus. These two cells are genuine megakaryocytes. The nucleus of cell figure 2 is simply a modification of the spheroidal nucleus of cell figure 1. It seems desirable to emphasize the point that these cells were studied in serial sections. It is obvious that similar appearances would result from possible sections through very different and much larger nuclei, as, for example, sections of cells figures 3

and 4. But these two cells (figs. 1 and 2) and many others have approximately as simple a nucleus as represented in these illustrations. The cell of figure 2 can be traced through small gradations to one like that of figure 3, a polymorphokaryocyte. The nucleus has become more complex and lobulated. A central cytoplasmic area ('endoplasm' of Heidenhain) contains a conspicuous group of centrosomes. There is, however, no indication of archoplasmic fibers.

By constrictions at the levels between adjacent lobules, the nucleus of the polymorphokaryocyte becomes divided into smaller nuclei, producing thus a polykaryocyte (fig. 4). This cell also contains a conspicuous pluricorpuscular centrosome in the 'endoplasm.' Appearances of discrete nuclei, like that of figure 4, could conceivably result from tangential sections through polymorph nuclei like that of figure 3, but in this particular case again, and in many others, it could be proved by study of serial sections that the giant-cell actually contains in certain instances several or many discrete nuclei.

In figure 9 is illustrated a giant-cell in which three nuclear buds have separated from the main polymorphous nuclear mass. Two of the nuclear buds (*a* and *c*) have the features of nuclei of the marrow erythroblasts; and about nuclear mass *c* a layer of cytoplasm has separated from the giant-cell 'exoplasm,' thus giving origin to an erythroblast which now appears to lie in a vacuole. Figure 8 illustrates in simplest condition the amitotic mode of intracellular hemocytogenesis described by Denys, as above outlined. This cell contains a polymorphous nucleus with scattered centrosomes in the 'endoplasm.' At the right periphery lies a polymorphonucleated eosinophilic granulocyte. In my preparations any of the cells illustrated in figures 3, 4, 7, 8, 9, 10, 11, 16, and 20 may contain one or several eosinophilic granulocytes. But only multinucleated cells like those of figures 4 and 9 contain erythroblasts.

Discussion

The above-sketches genetic series of events for these giant-cells agrees with that previously outlined for these same cells both in the yolk-sac of the pig embryo (10) and in the red bone-marrow of the rabbit (12). This developmental history is in substantial agreement also with that given by Denys for the rabbit's marrow, and with Heidenhain's statement that the giant-cells of the rabbit's bone-marrow arise from leucocytes by 'intercurrent' mitoses which never lead to division, but result in nuclear refusions following the 'mother star figure' (9).

I have shown in a previous paper that in the yolk-sac of the 10-mm. pig embryo certain hemoblasts enlarge and become bi-, polymorpho-, or multinucleated (12). In the binucleated condition, which is comparable to a polykaryocyte, these smaller giant-cells extensively differentiate endogenous erythrocytes, frequently one, occasionally two. These erythrocytes subsequently break through the peripheral shell of the original giant-cell cytoplasm. Occasionally also in the quadrinucleated condition endogenous erythrocyte-formation occurs. There is some slight evidence that quadrinucleated (the usual multinucleated condition in the yolk-sac) giant-cells occasionally divide into bi- or mononucleated forms before erythrocyte differentiation occurs. These giant-cells of the yolk-sac are multiple hemoblasts or small blood-islands (figs. 1, 7, 9, 10, 11, 24, 25, 26, and 35 of my article on the yolk-sac of the pig embryo (10) and figs 1 to 24 of my article on giant-cells (12)). A similar occasional endogenous origin of erythrocytes was described also for pathologic (typhoid) human bone-marrow (12). Figure 9, above described, also admits of no other obvious explanation than that of endogenous erythrocytogenesis. Since these giant-cells are enlarged and modified hemoblasts, it seems plausible that they should maintain to some degree their original capacity for erythrocyte differentiation under certain conditions. However, this phenomenon of intracellular erythrocytogenesis in giant-cells occurs in so slight degree that it does not seem reasonable to ascribe to it any essential or even important rôle. It seems more nearly

correct to interpret its occurrence under certain conditions as atypical or as a chance variation.

But Dickson's conclusion that the presence of erythrocytes (and leucocytes) in hemogenic giant-cells signifies a phagocytic activity on the part of the giant-cells cannot be substantiated. In the first place, the vast majority of the hemogenic giant-cells, whether in yolk-sac, normal marrow, or pathologic marrow, contain no cell inclusions. It is only very rarely that an erythroplastid is included. Erythroblasts are more common. If these cells were phagocytosed it would seem that the relatively more senile cells should preponderate, rather than the younger types. Nor does it seem likely that these erythroblasts invaded the giant-cell cytoplasm. They undoubtedly possess some ameboid capacity, but if they had any predilection for the sites of giant-cell cytoplasm, they would be expected to be more abundantly found.

There is, however, one other contingency that must be reckoned with, not heretofore suggested to my knowledge. It must be remembered that the cellular elements of active red bone-marrow are very closely packed; also, cells of certain types occupy distinct areas where they proliferate extensively. In other words, one does not find all types of cells scattered promiscuously throughout the entire red marrow, but one finds nests of erythroblasts distinct from nests of eosinophilic granulocytes. It appears as if an erythrocyte progenitor proliferates greatly in one area, and a granulocyte progenitor in another area. If such a locus of erythroblast proliferation abutted on a giant-cell, as frequently happens, it is conceivable that one or several of the more peripheral cells could become forced into the less resistant peripheral cytoplasm of the giant-cell. But when all these contingencies are fully recognized and given due weight with regard to a certain number of included erythrocytes, there persists a considerable residuum of consistent cytologic evidence in yolk-sac, normal marrow, and pathologic marrow to warrant the ascription of at least a slight erythrocytogenic function to these enlarged hemoblasts, the several varieties of hemogenic giant-cells.

However, when we consider the granulocyte inclusions, the case seems quite different. In the first place, such cells do not occur in the yolk-sac giant-cells. Here the cells are quite widely scattered in the blood spaces, and not closely crowded as in the bone-marrow. Furthermore, these granulocytes may occur in practically any type of older giant-cell in red bone-marrow, but most abundantly in those cells whose nuclear condition indicates degenerative changes in these cells; witness the figures of Denys. If the presence of the eosinophilic polymorphs signified giant-cell phagocytic activity, then one would expect all types of marrow cells to be ingested in approximately equal numbers. But the polymorphs with fine eosinophilic granules very greatly preponderate. When one considers the fact that the polymorphs of the rabbit with fine eosinophilic granules (special granulocytes) are the representatives of the neutrophilic polymorphs of most mammals and that the latter are the predominant phagocytes, Heidenhain's suggestion that these granulocytes have invaded the giant-cell appears very plausible. This conclusion is in agreement with the fact of their greater abundance in obviously degenerating and disintegrating cells.

The observations of Denys as illustrated in his figures 16 to 23 are absolutely unique. No one else, as far as I have been able to learn, has described anything closely comparable in degree with conditions he describes for his sections of rabbit's red bone-marrow. He does say that great variations occur in regard to these conditions in different individuals, but he does not specify any peculiar circumstance about the individual from which this specimen of marrow was derived. In my study of preparations of at least a score of different individuals of rabbit and guinea-pig I have never seen anything like the condition illustrated by Denys in, for example, his figures 22 and 23. Dickson would explain these conditions as phagocytosis; Heidenhain as the result of invasion. However correctly interpreted, the condition of this degree must be extremely rare. Besides the arguments above given against an interpretation in terms of phagocytosis on the part of the giant-cells, may be mentioned this additional and apparently conclusive contravening fact as applied to the

illustrations of Denys: It is inconceivable, and quite without parallel, how a cell could continue to function phagocytically and continue to load itself with ingested cells to the point of rupture, long after its nucleus had practically disappeared through pressure exerted by the extraneous ingested cells. On the other hand, Denys' evidence is far from conclusive that the contained leucocytes are actually differentiation products of the nucleated areas of the polykaryocyte cytoplasm. The crucial link in the evidence for such conclusion is lacking: he can give no satisfactory transition stage between the polymorphokaryocyte and the giant-cell 'cysts.' We desire a cell showing at least a score of isolated nuclei as a transition to the cysts containing at least a hundred leucocytes, interpreted as derived from nuclear buds. This transition stage is lacking in Denys' series of figures. At most he can only show a cell with two isolated buds. Moreover, the intracellular leucocytes themselves appear at approximately definitive stages of differentiation, not at widely different stages of differentiation as would be expected if they actually developed intracellularly.

When one considers Denys' figures 17 to 23, one gets the impression of a mass invasion of granular polymorphs into these giant-cells. The nucleus is pushed to one side; it is greatly compressed and finally broken up and destroyed. The suggestion presents itself very persistently that these mass inclusions of polymorphonucleated granulocytes signify an invasion of these cells, due to the close juxtaposition of areas of intensely proliferating granulocytes and less resistant areas of closely packed adjacent giant-cells. There remains no acceptable evidence that the hemogenic giant-cells of red bone-marrow of the rabbit possess any intracellular leucocytopoietic function. There is, however, a residuum of rigidly tested evidence which suggests a slight erythrocytopoietic capacity on the part of these cells, both in the yolk-sac (10) and in the red bone-marrow (12).

THE SIGNIFICANCE OF THE SO-CALLED MITOTIC FIGURES

Review of literature

Under this head also the investigation of Denys is in this connection by far the most important. Denys (4) alone gives a detailed account, with adequate illustrations, of what he believed to be mitotic division of the hemogenic giant-cells of red bone-marrow. Arnold's (1, 2) account obviously relates to degenerative changes, as already suggested by Dickson. Dickson (5) desires his own account of mitosis in these cells to be accepted only as a 'preliminary sketch.' Bunting (3) merely refers to the mitotic division of these cells, without giving any detailed description or illustrations. Heidenhain gives us only meager details of what he regards as multipolar ('multiple') mitoses of these giant cells (pp. 622-625 (8)). The statement by Van Bambeke and Van der Stricht (16) that the lobulated nucleus of the megakaryocyte is formed by fusion of a large number of small daughter-nuclei during the telophase of many repeated multipolar mitoses, is hardly more than a suggestion. Nevertheless, these less complete accounts of an alleged mitotic process will be briefly considered after a detailed analysis of Denys' evidence for mitosis.

Mitosis is said by Denys to be initiated by the rearrangement of the chromatin into a densely wound thread, like the close spireme of binary mitotic division (figs. 23, 24, 18, and 12). Subsequently this spireme segments into short rods (chromosomes?) which arrange themselves first into a spherical mass (fig. 14), and later into what is described as a 'basket structure with polygonal meshes.' Figure 15 illustrates well the several varieties of this latter stage as figured by Denys. This stage is said to represent that of the equatorial plate of binary mitosis, just preceding the longitudinal division of the chromosomes. Denys describes the shape of the alleged chromosomes at this stage as having the form of a U with the bend of the U directed toward the center of the nucleus. Presently they are believed to suffer a longitudinal splitting, after which the daughter groups of chromosomes separate and take positions as the polar groups of multipolar mitoses (fig. 5). These groups are then said to re-

constitute themselves into nuclei, while the cytoplasm divides. This process he considers comparable to the multiple mitoses of pathologic tissues. The cytoplasm of these 'dividing' cells frequently contains an enormous vacuole. Denys was unable to detect either centrosomes or archoplasmic spindles in these so-called dividing cells. It may be said at once that Denys' illustrations do not support his description of the alleged chromosomes as U-shaped nor do his figures show any evidence of a longitudinal splitting of the chromatic rods nor does he give any figures showing a transition between the stage illustrated in figure 5 ('anaphase') and the alleged later one when the nuclei have been reconstituted (figs. 16 and 17); nor does he illustrate the alleged later cytoplasmic division in the rabbit's marrow. Another significant fact to which allusion will be made later concerns the uniformly much smaller size of the cells which are said to be in mitosis. This is well illustrated in our figures 5, 6, 12, 14, and 15.

In the alleged mode of division described by Arnold (2) as 'indirect fragmentation' four main steps are recognized. In the first stage the nucleus becomes diffusely chromatic (fig. 8); in the second it stains more intensely and the interlobular constrictions enter more deeply into the nuclear substance, and the form of the nucleus as a whole becomes more complex (fig. 20); this stage is followed by one where the chromatin becomes segregated into unequal masses, constituting new young nuclei; and in the fourth or final stage the cytoplasm divides into portions equal in number to that of the daughter-nuclei. The process above outlined seems clearly to signify only regressive degenerative changes in polymorphokaryocytes. The alleged intracellularly derived leucocytes of his figure 10 should be interpreted as invading cells.

Heidenhain (9) describes a process of incomplete division of these cells by mitosis, in which process the centrosomes (200 to 300) are said to take an important part. Multipolar mitotic figures are said to form without leading to a final division either of nucleus or cytoplasm, but effecting a refusion of groups of chromosomes into a new polymorphous nucleus. No details

are given regarding the specific rôle of the centrosomes in this process, nor does he give any figures showing astral rays or spindle fibers accompanying the 'multiple mitoses.'

Bunting describes 'peculiar complex mitotic figures' in 'dividing megalokaryocytes' of the regenerating red bone-marrow of the rabbit, after experimental intoxication with saponin, ricin, or turpentine. He finds no evidence, however, of a division either of the chromatin masses or of the giant-cell cytoplasm. No mention is made of either centrosomes or spindle fiber; it may therefore be inferred that such were not seen in connection with these 'mitoses.' He suggests that these apparently incomplete, and multipolar, mitoses lead merely to an increase in the complexity of the polymorphous nucleus—an idea very like that expressed by Van Bambeke and Van der Stricht.

The seriation described by Dickson seems on its face quite improbable. The relatively small size of his cell at 'prophase,' figure 2 (fig. 17), and of the cells at 'anaphase' (figs. 14 and 15) is noteworthy. Dickson also makes no mention of centrosomes or spindle fibers in these assumed mitotic phases. It should be stated also that two of the figures in this series (figs. 10 and 17) occur only very infrequently in my material. Dickson's figure corresponding to my figure 10 contains a 'spireme' of considerably lesser girth. Dickson tentatively describes mitosis in these giant-cells as follows:

The first stage in this complicated division seems to be an aggregation of the basket-like nucleus (fig. 3)⁴ of the giant-cell already described, into a more compact, solid mass, such as is shown in the Cell 1 of the figure (fig. 16). This process of condensation may continue until the whole nucleus becomes much reduced in total bulk, and during which process the staining reaction of the chromatin becomes more intense. (Note.—It is possible the stage figured in Cell 2 (fig. 17) may be a somewhat later one in the process, and may represent the phase which follows division and rearrangement of the chromosomes.) The nucleus now proceeds to arrange itself into one long, continuous, convoluted, thread-like structure which gradually becomes thinner and more condensed, and which shows the chromatin becoming aggregated into little rounded masses dotted at regular intervals along its

⁴ The references to figures, given in brackets, in this quotation are inserted by me, and designate figures illustrating this article.

entire length, the red nucleolar staining having now disappeared (spireme or prophase) (fig. 10). This thread or spireme, when the condensation of the chromatin is complete (fig. 12), breaks up (metaphase) into short segments resembling chromosomes (fig. 14), which become rearranged into a dense rounded globe in the center of the cell (anaphase) (fig. 15), after which it is probable that the resulting basket nucleus is rebuilt upon a more complex plan, by a process resembling that by which the original underwent the transformation into chromosomes, i.e., by stages similar to those just described, but occurring in the reverse order. . . . This intricate process of nuclear *rearrangement* rather than *division* is not accompanied or followed by corresponding division of the cell-body or telophase, the protoplasm simply increasing in bulk as the nucleus becomes larger and more complicated.

Description

The earlier steps (figs. 2, 3, and 4) in the development of the several varieties of the giant-cells from the enlarged hemoblast (megakaryocyte, fig. 1) have already been considered above. Polykaryocytes arise from polymorphokaryocytes through the division of the lobulated nucleus of the latter. Certain of the isolated nuclei of the polykaryocyte may function as centers of intracellular differentiation of erythrocytes (fig. 9). Polykaryocytes, moreover, suffer degenerative changes characterized by the aggregation of the chromatin of the separate nuclei into peripheral masses simulating equatorial plates of chromosomes (fig. 5). The originally distinct groups subsequently become mingled, a process seen at the beginning at the left of figure 5, and finally become scattered throughout the cell (fig. 6). The latter may occasionally show an arrangement of the chromatin segments (chromosomes?) like that of figure 15, simulating a multipolar mitotic figure like that of certain neoplastic cells; but neither centrosomes nor spindle fibers are here discernible. The chromatic rods of figure 6 subsequently become pale and granular and appear to dissolve within the disintegrating cytoplasm.

The giant-cell with basket nucleus (polymorphokaryocyte) also passes through early stages of degeneration by gradual steps as illustrated in figures 7, 8, 9, and 11. The nucleus in the last of these stages becomes compacted into a spheroidal mass

with very irregular and chromatic contour. The chromatin has collected into spheroidal and bacillary droplets of greatly varying size. Subsequently the nuclear wall disappears and the chromatic material collects into a complicated meshwork simulating somewhat the loose and segmenting spiremes of normal mitosis (fig. 12). The latter stage passes into one characterized by partially isolated masses of chromatin simulating the segmented spireme, which may pass before dissolution through a stage characterized by the aggregation of still finer chromatic granules into groups showing four or more condensed linear areas, thus giving the impression of a multipolar mitotic figure, but without indication of spindle fibers. Cells like that of figure 15 disappear through solution of the chromatic bodies within the disintegrating cytoplasm.

The giant-cells may disintegrate by still another degenerative route. Repeated amitotic nuclear division of a polykaryocyte may lead through stages represented by figures 4, 16, and 17. The relatively small nuclei of cells like that of figure 17 may then suffer a peripheral condensation of their chromatin, followed by fusion (left of fig. 18), which steps lead to a condition like that shown in figure 19; after this stage the now naked nucleus loses its staining capacity and fragments. Finally, the polymorphous nucleus of certain giant-cells may begin to stain very deeply, giving to the whole a homogeneous appearance (fig. 20). Such a cell has entered upon a stage of active cytoplasmic disintegration. The latter progresses, forcing a condensation upon the nucleus (fig. 21). The nucleus persists for a while longer as a compact naked body (fig. 22), but eventually disappears by fragmentation. Figures 23 and 24 illustrate two additional variations of nuclear changes during degeneration of the type of cell represented in figure 18.

Discussion

The foregoing description shows that the several later stages in the alleged mitotic division of the medullary giant-cells represent in fact the terminal stages in at least four different modes

of degeneration of these giant cells. These several modes are illustrated by the series of figures 1 to 6; 1, 2, 3, 8, 10, 11, 12, 14, and 15; 1, 2, 3, 4, 16, 17 (23), 18 (24) and 19, and 1, 2, 3, 20, 21, and 22. The first two series lead to terminal conditions where chromatin masses resembling chromosomes dissolve within disintegrating remnants of cytoplasm. The last two lead to naked nuclei, which ultimately disintegrate. The fate of the giant-cell seems to be to suffer a gradual diminution of its cytoplasm, which progressive condition imposes degenerative changes upon its nucleus. The function of the giant-cell seems, paradoxically, to be to disintegrate. This cell represents essentially an overgrown hemoblast. It may become multinucleated by direct division of its secondarily lobulated nucleus. In this phase it may occasionally differentiate erythroblasts intracellularly. There is no satisfactory evidence in the data pertaining to the red marrow that either the polymorphokaryocyte or the polykaryocyte can divide either mitotically or amitotically. New giant-cells arise only by differentiation from hemoblasts, not by proliferation of preëxisting giant-cells.

Before proceeding to an analysis and interpretation of the various stages described by previous investigators as steps in mitotic division, it may be stated again that there is no difficulty in finding examples of all the various stages figured by these workers, notably Denys, Heidenhain, Arnold, and Dickson. The point at issue is not regarding the occurrence of these particular cells, but regarding their correct interpretation. Stages like those illustrated in figures 5, 10, 11, and 17 occur relatively less frequently than the other stages illustrated. In the illustrations I have attempted to give types of cells. Every cell shown in the works of the above-mentioned investigators can be referred to some one of my figures as a type, of which these cells may be interpreted as variations. Thus Denys' figures 25 to 29 are variations of my figures 12, 18, 23, and 24; his figures 44 to 51 of my figure 5; his figures 34 to 45 of my figure 15, etc.

Previous workers have been impressed with such conspicuous structures like those of figures 5, 12, 14, and 15, simulating pro-

phase and metaphase groups of chromosomes of multipolar spindles. They have assumed a correspondence with the typical multipolar mitoses of neoplastic tissues. But no one, with the exception of Denys, has actually claimed a consummated mitotic division. The other investigators have only ventured to interpret these mitotic simulacra as a method by which the polymorphonucleated nucleus of the giant-cell becomes still more complex. No one has claimed the presence of spindles in connection with these figures. Nor has any one apparently seen the significance of the reduced amount of cytoplasm of the cells containing these alleged mitotic figures; nor taken account of the obviously degenerating naked nuclei in their serialations of stages in the life-history of these cells. The absence of spindles alone, however, marks these figures at once as something different from the multipolar mitoses of neoplasms, and of morbid and experimentally modified tissues.

Since Wright (18) published his more complete paper, with convincing colored illustrations ('10), on the origin of blood-platelets from the cytoplasm of the medullary giant-cells, we have been furnished a new basis for the interpretation of these various nuclear modifications. Wright's conclusion regarding the genesis of blood-platelets has now had confirmation at the hands of at least three subsequent independent investigators; Bunting, (3) Downey, (6) and Jordan (11, 14). Blood-platelets arise by a process of pseudopod constrictions, and by cytoplasmic fragmentation, from hemogenic giant-cells. The former method of origin is generally restricted to the cells with the more vesicular nuclei (figs. 1 to 4); the latter method to those cells having deeper staining, more complex and less regular nuclei (figs. 8 to 11 and 20 to 21). It was shown in previous studies that blood-platelets arise by a similar method from similar cells, and even from the parent hemoblasts, in the yolk-sac of the 10-mm. pig embryo (14); and that leucocytes generally, both lymphocytes and granulocytes, in the red bone-marrow of the frog possess the capacity of constricting off platelet-like bodies (13). The conclusion was there stated that platelet formation is a by-product of the normal activity of leucocytes and of the disintegration of degenerating leucocytes.

Another fact must be taken into consideration in this connection, namely, the division of the centrosome into a pluricorpuscular body, and next the scattering and finally the disappearance of these elements concomitantly with successively later steps in the degeneration process as judged by the condition of the nucleus. When one keeps in mind the fact that the giant-cell suffers a continual diminution of its cytoplasm through the formation of blood-platelets, the invariably smaller size (see also Denys' figures) of the cells with the later nuclear degenerative changes simulating groups of chromosomes becomes intelligible.

The question arises as to whether the nucleus undergoes degenerative changes because the cytoplasm is gradually being eliminated in the formation of platelets or whether cytoplasm is being discarded and platelets incidentally formed because the nucleus suffers degeneration, or whether both events are the combined effects of the same fundamental cause. The most plausible interpretation, in view of all the facts, including the data previously derived from a study of giant-cells of the yolk-sac and of frog's marrow, is as follows: As the result of the operation of some unknown factor, certain hemoblasts enlarge to form the simplest type of giant-cells. This enlargement disturbs the optimum nucleocytoplasmic relation. In an attempt to recover this original optimum relation, pseudopods are projected; these constrict and break up into platelets and the cytoplasmic volume relative to the nucleus is thus reduced. The same end may be served by the nucleus, through increase of its bulk and its surface area, by enlargement, lobulation and finally direct division. The disturbance of optimum nutritive conditions operating meanwhile works an untoward effect upon the centrosome which in consequence fragments into a pluricorpuscular centrosome. Failure to cope with the factors effecting interference with the optimum nucleocytoplasmic relation initiate gross degenerative changes expressed on the part of the cytoplasm by mass fragmentation, and on the part of the nucleus (as in fig. 4) by an aggregation of the chromatin in peripheral droplets (fig. 5). Subsequently the nuclear membrane disap-

pears, the chromosome-like masses become mingled (fig. 6), and ultimately the entire cell disintegrates. All the conspicuous signs of degeneration, as they relate to nucleus, centrosome, and cytoplasm are apparently the common effect of the same underlying cause, of which platelet formation is a mere by-product. The nuclear alteration may be of various sorts, as illustrated in figure 11 to 15, 17 to 19, and 20 to 22. These degeneration phenomena produce appearances simulating multipolar spindles, both in the yolk-sac (fig. 13) and in the marrow (figs. 12, 14, and 15). As the cytoplasm becomes reduced in amount the nucleus in consequence becomes more and more compressed (figs. 23, 24, 18, and 19, and figs. 20 to 22), and ultimately only naked, compact nuclei remain. The latter are now of such reduced size as to be no longer mechanically barred from the initial medullary blood-vessels, and in consequence may find their way into the peripheral blood stream and become lodged in the capillaries of the lung before final dissolution.

There is, in short, no adequate evidence indicative of genuine multipolar mitoses in these giant-cells; the mitotic simulacra can all be reasonably interpreted in terms of nuclear disintegration. Thus is explained one of the most puzzling phenomena relating to these cells. These cells would seem to be of the nature of atypical cell 'giants,' without function other than the one of producing blood-platelets incidentally to their disintegration. If a liberal interpretation of the nature of a chromosome, as simply a mass of chromatin without specific constitution or function, may seem to permit the classification of the chromatic bodies formed by peripheral nuclear condensations of the chromatin of the giant-cells in the category of chromosomes, it remains true, nevertheless, that the 'mitotic' arrangement of these masses, unassociated with spindles, only represents an abortive attempt at division.

The above interpretation of the significance of the alleged mitotic figures of the giant-cells is further supported by events in the giant-cells of the enamel pulp (figs. 25 to 27). The three cells here illustrated are from the jaw of the new-born cat. They represent three successive stages in the disintegrative proc-

ess. There can be no question here of mitotic proliferation, since at least the apical half of the enamel organ, from which the cells are taken, is atrophic and clearly in process of degenerative transformation into the so-called Nasmyth's membrane of the soon-to-be erupted tooth. These multinucleated giant-cells are of ectodermal origin; they are formed by the fusion of cells of the enamel pulp into large irregular syncytia. These syncytia are comparable to the osteolytic giant-cells (osteoclasts) of the marrow of developing bones, and in general to foreign-body giant-cells of pathologic foci. They contain globules of resorbed enamel. The definitive enamel of the preerupted tooth is apparently reshaped to some extent prior to eruption, and the superfluous decalcified enamel is ingested by these amelolytic giant-cells. These cells supply seemingly unequivocal evidence regarding the origin and significance of the chromatic rodlets and masses which superficially suggest so strongly the chromosome configurations of multipolar mitoses.

In cell figure 25 the relatively small spheroidal nuclei have assumed a diffusely chromatic appearance, with only relatively very few karyosomes, and the nuclear reticulum is barely discernible. The chromatin material has diffused throughout the nuclei and given to them a cloudy, more deeply staining, appearance. At a later stage (fig. 26) the chromatin has become aggregated into one or several larger or smaller peripheral, frequently crescentic, masses. Occasionally one or several larger or smaller, irregularly spheroidal or bacillary, chromatic masses occur within the now very pale, and only vaguely outlined, nuclei. This condition is clearly indicative of degeneration. Already at these stages certain of the chromatin aggregations have passed into the cytoplasm, with the disappearance of the nuclear membranes. These chromatin masses thus formed are clearly not genuine chromosomes in the usual sense, and of normal constitution, though they closely simulate chromosomes, and may possibly have even an identical chemical nature. They are formed, like chromosomes, from the nuclear chromatin, but in an entirely different manner, and without the intervention or assistance of centrosomes or spindles.

In figure 27 we meet with a still later stage in this same degenerative process. The cytoplasm at certain points on the periphery appears to be disintegrating. Meanwhile the chromatin masses have become scattered throughout the cytoplasm. Near the center may be seen what appears to be the origin of paired chromatic rods by outflow of chromatin from a nuclear vesicle. These chromosome-simulacra may by chance become arranged in certain portions into configurations suggesting multipolar spindles of cancer cells. In certain portions they become more closely massed into a fine-meshed chromatic network. Certain of the chromatic rodlets fragment, and certain masses lose their deep-staining capacity. Eventually all of this chromatin dissolves within the disintegrating giant-cell cytoplasm. The close correspondence between the phagocytic syncytia of the enamel pulp and the multinucleated giant-cells of red bone-marrow is striking. These two types of giant cells have, however, an entirely different origin and function, but in their later disintegrative stages they present comparable aggregations of chromosome-simulacra, derived in very similar manner in both instances, and clearly in both cases indicative of degeneration.

SUMMARY

1. The red bone-marrow of the rabbit and the guinea-pig contains three chief varieties of giant-cells: megakaryocytes, the mononucleated forms derived by excessive growth from the hemoblast; polymorphokaryocytes, the forms with polymorphous or lobulated nucleus derived from the megakaryocyte by incomplete direct division of the nucleus, and polykaryocytes, the multinucleated forms derived from forms with lobulated nuclei by completion of the constrictions in the complex nucleus to produce separate smaller and spheroidal nuclei. Comparable varieties with similar genetic history occur also in the yolk-sac of the pig embryo.

2. Certain giant-cells of the multinucleated variety, chiefly bi- or quadrinucleated, retain to a small degree the capacity of their original hemoblast ancestor of producing intracellular erythrocytes. In these giant-cells erythrocytes may differentiate intracellularly about isolated nuclei.

3. The giant-cells in normal marrow and in the yolk-sac are devoid of phagocytic function. The presence of polymorphonucleated granulocytes of the special eosinophilic variety in greater or less abundance within the cytoplasm do not signify intracellular differentiation nor phagocytic ingestion, but are to be interpreted as secondary passive invasions due to the relatively less resistant character of the giant-cell cytoplasm as compared with the general marrow parenchyma against the pressure exerted by an area of actively proliferating leucocytes, or as active invasions by special polymorphonucleated phagocytes of a disintegrating cytoplasm.

4. The giant cells do not undergo mitosis, either complete cytoplasmic or incomplete nuclear. The groups of chromatic particles simulating plates of chromosomes of multipolar spindles of pathologic tissues are simply chance aggregations of chromatin during the degenerative process. These aggregations are not accompanied by archoplasmic fibers. They represent terminal stages in the several modes of degeneration of the polymorphonucleated and multinucleated varieties of giant-cells.

5. The lobulation and direct division of the giant-cell nucleus; the accompanying partition of the centrosome into a pluricorpuscular element; the later dissolution of the nuclei and the formation of chromatin masses and groups of such masses; and the coincident production of blood-platelets from the cytoplasm, first by segmentation of pseudopods and later by mass fragmentation of larger cytoplasmic areas, are all to be interpreted in terms of the action of some common unknown factor working toward the eventual disintegration of these cells.

6. There is no adequate evidence to support the claim that the hemogenic giant-cells of red bone-marrow have a phagocytic function, or that a genuine mitotic mechanism underlies the increase in complexity or the segmentation of the polymorphous nucleus. Once having passed beyond the stage with features characteristic of the hemoblast, their further history only leads through progressive steps toward disintegration, involving terminally in some cases nuclear appearances simulating multipolar mitotic figures.

BIBLIOGRAPHY

- 1 ARNOLD, J. 1883 Beobachtungen ueber Kerne und Kerntheilungen in den Zellen des Knochenmarkes. *Virch. Arch.*, Bd. 93, S. 1.
- 2 1884 Weitere Beobachtungen ueber die Theilungsforgänge an den Knochenmarkzellen und weissen Blutkörpern. *Virch. Arch.*, Bd. 97, S. 107.
- 3 BUNTING, C. H. 1909 Blood platelet and megakaryocyte reactions in the rabbit. *Jour. Exp. Med.*, vol. 11, p. 541.
- 4 DENYS, J. 1886 La cytodierese des cellules geantes et des petites cellules incoleres de la moelle des os. *La Cellule*, T. 2, p. 245.
- 5 DICKSON, W. E. C. 1908 The bone-marrow. Thesis; Longmans, Green & Co., London. II. Giant cells, pp. 64-72.
- 6 DOWNEY, H. 1913 The origin of blood platelets. *Folia Haematologica*, Bd. 15, S. 25.
- 7 FOÀ, P. 1899 Ziegler's Beiträge zur Path. Anat., Bd. 25, S. 376.
- 8 HEIDENHAIN, M. 1894 Neue Untersuchungen ueber die Centrankörper und ihre Beziehungen zum Kern- und Zellenprotoplasma. *Arch. f. micr. Anat.*, Bd. 43, S. 423.
- 9 1907 Plasma und Zelle. Fischer, Jena; pp. 265-274.
- 10 JORDAN, H. E. 1916 The microscopic structure of the yolk-sac of the pig embryo, with special reference to the origin of the erythrocytes. *Am. Jour. Anat.*, vol. 19, p. 277.
- 11 1918 The histology of lymph, with special reference to platelets. *Anat. Rec.*, vol. 15, p. 37.
- 12 1918 A contribution to the problems concerning the origin, structure, genetic relationship and function of the giant cells of hemopoietic and osteolytic foci. *Am. Jour. Anat.*, vol. 24, p. 225.
- 13 1919 The histology of the blood and the red bone-marrow of the leopard frog, *Rana pipiens*. *Am. Jour. Anat.*, vol. 25, p. 437.
- 14 1919 The histogenesis of blood-platelets in the yolk-sac of the pig embryo. *Anat. Rec.*, vol. 15, p. 391.
- 15 PUGLIESE, A. 1897 Ueber die physiologische Rolle der Riesenzellen. *Fortsehr. der Med.*, Bd. 15, S. 729.
- 16 VAN BAMBEKE, C., et VAN DER STRICHT, O. 1891 Caryomitose et division directe des cellules à l'état physiologique. *Vehr. d. anat. Ges.*, in München, S. 169-173 (cited from Van der Stricht and T. Wingate Todd; *The Johns Hopkins Hospital Reports*, vol. 19, p. 34).
- 17 VAN DER STRICHT, O. 1892 Nouvelle recherches sur la genèse des globules rouges et des globules blanc du sang. *Arch. Biol.*, T. 12, p. 199.
- 18 WRIGHT, J. H. 1910 The histogenesis of the blood-platelets. *Jour. Morph.*, vol. 21, p. 263.

PLATE 1

EXPLANATION OF FIGURES

All the figures, with the exception of 13, 25, 26, and 27, were drawn from sections of the femoral red bone-marrow of the rabbit; fixed with Helly's fluid, cut at $5\ \mu$ and stained with iron-hematoxylin. The original magnification was 1600 diameters; this was reduced $\frac{1}{3}$ in reproduction.

1 Young megakaryocyte. It has the nuclear and cytoplasmic characteristics of a large hemoblast.

2 Older and larger megakaryocyte, with more deeply staining crescentic nucleus. It corresponds to a simpler variety of polymorphokaryocyte.

3 Later polymorphokaryocyte with lobulated 'basket' nucleus. In the cytoplasm included within the annular nucleus (as it appears in section) lies a group of centrosomes.

4 Polykaryocyte. The cytoplasmic area bounded by the ring of discrete nuclei contains a collection of centrosomes (pluricorpuscular centrosome).

5 Beginning of disintegration of a polykaryocyte. The chromatin of each of the five nuclei has gathered into peripheral droplets, simulating chromosomes arranged in equatorial plates. At the left two groups are mingling. Neither centrosomes nor spindle fibers are discernible.

6 Later stage in disintegration. The chromatin masses, still simulating chromosomes, are indiscriminately mingled.

7 Polymorphokaryocyte, similar to that of figure 2. This corresponds to stage 3 of the mitotic division of these giant-cells as interpreted by Dickson.

8 A variety of polymorphokaryocyte. The area inclosed by the nucleus contains scattered centrosomes. This corresponds to stage 4 of mitosis, according to Dickson. At the right the cytoplasm has been invaded by an eosinophilic granulocyte.

9 Polymorphokaryocyte in process of becoming a polykaryocyte. Three smaller spherical nuclei have already separated from the main nuclear mass. Two of the separated nuclei (*a* and *c*) have the characteristics of nuclei of erythroblasts. Nucleus *c* is actually enveloped by a distinct shell of cytoplasm which has separated from the cytoplasm of the giant-cell; and the resulting cell constitutes an erythroblast differentiated intracellularly from the giant-cell.

10 A variety of polymorphokaryocyte. This is very similar to stage 5 in mitosis, according to Dickson.

11 Early stage in the disintegration of the foregoing variety of polymorphokaryocyte. The lobulated nucleus appears to have drawn in its longer extensions and become massed into a simpler, more compact, structure with extremely irregular and chromatic contour. The chromatin has collected in droplets, rods, and strands simulating a segmenting spireme.

12 Later stage in the process of this mode of disintegration. The nuclear chromatin has become arranged into a structure simulating a prophase spireme. This condition may follow that of figure 10 without the intervening stage of figure 11.

13 Similar cell at a comparable stage, from the angioblast layer of the yolk-sac of a 10-mm. pig embryo. Zenker fixation; hematoxylin and eosin stains.

14 and 15 Successively later stages in the process of disintegration initiated in figures 11 and 12. In the seriation of mitotic stages described for these cells by Denys, figure 15 represents an intermediate stage ('metaphase') between figure 6 ('prophase') and figure 5 ('telophase'). Neither centrosomes nor spindle fibers are discernible.

16 A variety of polykaryocyte in which many of the nuclei are relatively small. This cell corresponds with stage 1 in mitosis as described by Dickson.

17 Very rare variety of polykaryocyte, in which all of the nuclei are of approximately uniform size and relatively very small. This type of cell corresponds with stage 2 of Dickson's seriation of steps in mitosis.

18 Later stage in the disintegrative process as shown beginning in figure 17. A row of small nuclei is still discernible at the right. At the left the chromatin of the nuclei has coalesced to form a very coarse and irregular chromatic network or 'spireme.' This type of nucleus is almost bare of cytoplasm.

19 Still later stage in the process of disintegration of this giant-cell. This type of nucleus is quite naked. The cytoplasm has become used up in the production of blood-platelets.

20 A variety of polymorphokaryocyte in which the lobulated nucleus appears homogeneous for the most part and stains very intensely. This type of nucleus signifies beginning disintegration. Such a cell produces platelets by fragmentation of large areas of its cytoplasm. This type of cell corresponds with a distinct phase of the division of these giant-cells as described by Arnold as 'indirect fragmentation.'

21 and 22 Successively later stages in the process of disintegration of this variety of cell, leading to a naked and ultimately fragmenting nucleus. The nucleus in figure 21 is enveloped by only a narrow layer of cytoplasm, fragmenting peripherally.

23 and 24 Successively later stages in the process of disintegration of originally polymorphous nuclei, compacted and modified through loss of cytoplasm in the formation of platelets. Figure 23 is comparable to 18, and may be derived from cells like those of figures 16 and 17. Figure 24 is also comparable to figure 18, and represents a variety of this type of nucleus.

25 Multinucleated giant-cell from the enamel pulp of a new-born cat. These cells are formed by the fusion of originally discrete, mononucleated cells of the enamel organ. They may contain globules of resorbed enamel. The cytoplasm is acidophilic in staining reaction. Zenker fixation; hematoxylin and eosin stains.

26 Early stage in the disintegration of these enamel giant-cells. The chromatin of the nuclei collects in several peripheral crescentic masses and occasional spherical or elongated droplets. The nuclei become pale, their membrane eventually ruptures, and the chromatic masses are cast out into the cytoplasm of the disintegrating cells where they simulate prophase chromosomes.

27 Late stage in the disintegration process. The chromatic masses (chromosome simulacra) eventually dissolve within the fragmenting cytoplasm.

H. E. JORDAN

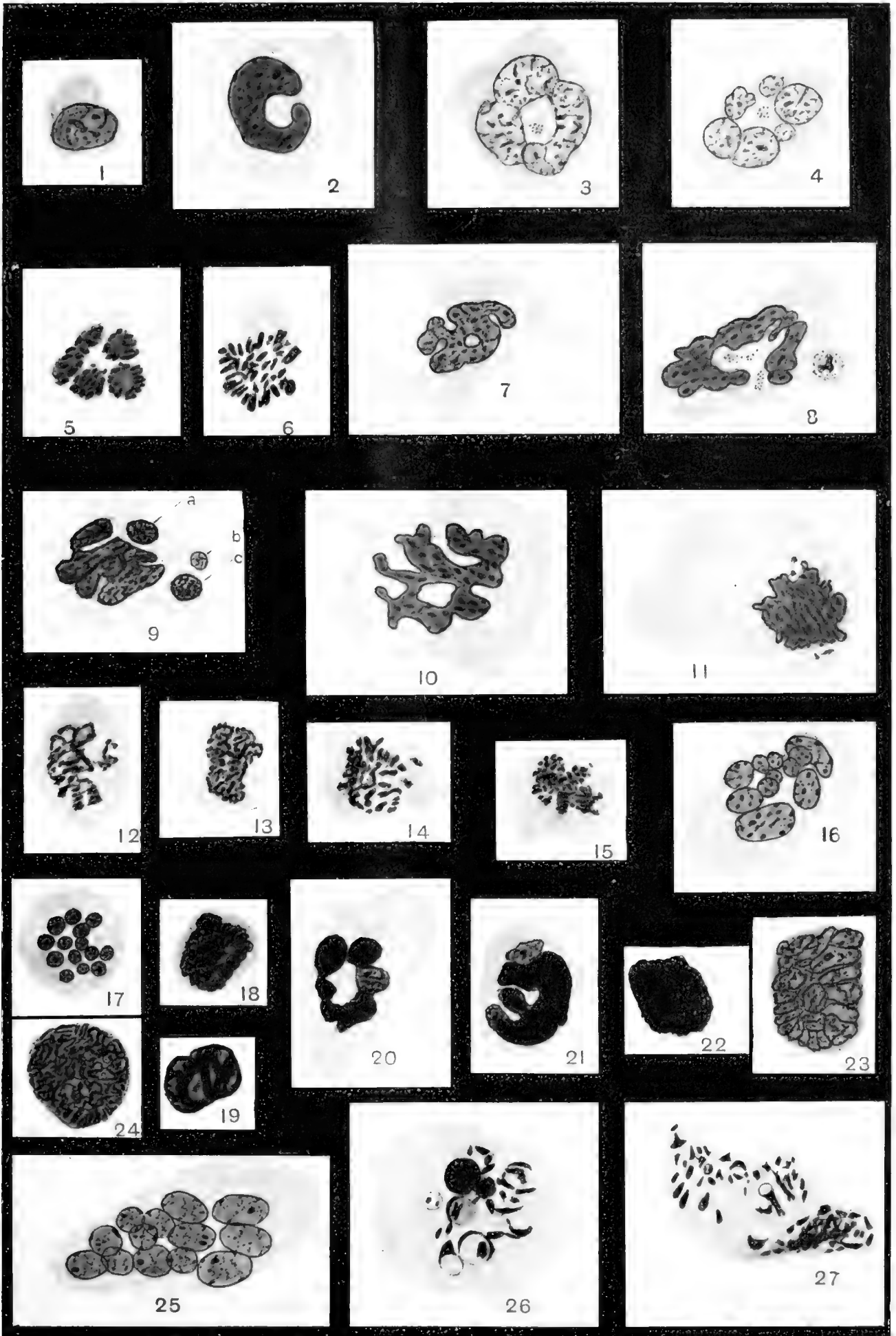

Resumen por el autor, Chikanosuke Ogawa.

Las finas ramificaciones del pulmón humano.

Los conductos alveolares del pulmón adulto del hombre fueron estudiados por el autor por medio de reconstrucciones. Los conductos alveolares se dividen dos a nueve veces antes de alcanzar los sacos aéreos. Como tipo de ramificación se encuentran la monopodia y la dicotomía. Los planos divergentes de los conductos frecuentemente se cruzan entre sí. Se ramifican en sucesión frecuente, y la disminución de su diámetro no se acusa. La regla de Justesen no puede aplicarse al caso del pulmón humano adulto. El número de alveolos contenidos en un saco aéreo varía entre cinco y veinte. El atrio de Miller es un término innecesario, por lo menos en el caso del pulmón humano. Las paredes alveolares (distintas de las de la base) están generalmente formadas por la pared saliente de los conductos alveolares y los tabiques alveolares.

Translation by José F. Nonidez
Cornell University Medical College, N. Y.

THE FINER RAMIFICATIONS OF THE HUMAN LUNG

CHIKANOSUKE OGAWA

Department of Anatomy, Kyoto University, Japan

EIGHT FIGURES

Anatomical knowledge of the mammalian lung, especially of the human type, has recently much improved. Yet there appear many problems which ought to be solved in the future. Here I will describe the results of my study of the finer ramifications of the human lung.

I am greatly indebted to Prof. B. Suzuki for the use of many microscopical preparations and wish also to express my appreciation of his many helpful suggestions.

MATERIAL AND METHODS

The following four methods have been used in the investigation of the finer ramifications of the human lung: 1) Drying method; 2) corrosion method; 3) graphic method; 4) reconstruction method.

1. The drying method is simple to carry out, but it is insufficient for the investigation of finer morphological conditions.

2. The corrosion method is also widely used in this sort of study. Toldt, Müller, Sussdorf, and others consider it adequate, nevertheless Justesen holds an entirely opposite idea. I inspected several corrosive preparations and found much inconvenience with them. The alveolar ducts in corrosion preparations inevitably become misshapen by the weight of the injected metal and by the air or mucus which may be left in the air passages. Hence such a method is inadequate for detailed study.

3. The graphic method has been described and recommended by Justesen, but Hammar opposes him. This method has also disadvantages for fine study.

4. Reconstruction (wax-plate modeling).

To my knowledge, only Miller, Laguesse, and Keil have studied the lung by this method. Justesen shows this method to be based on four manipulations and he believes that during the excision and fastening of the wax plates serious mistakes are necessarily made in the reconstruction of alveolar ducts; but I am of the opposite opinion.

In the reconstruction of wax models it is most important to decide whether the models will be made in positive or negative cast. (I mean by the word 'positive' a cast which presents the lumina of the alveolar ducts hollow, such as one finds them in the actual shape of the structure.) After careful consideration, I endeavored to construct both positive and negative models. I will give a brief description of these. My materials consisted of two different lungs: one (cadaver no. 1399) was taken from a thirty-one-year-old executed man and was fixed by formol-alcohol; this was injected into the trachea; the other (cadaver no. 2854) was taken from a fifty-five-year-old man whose whole body was fixed by formol-alcohol injected into the femoral artery. In this case the lung was fixed in normal position within the thorax. I stained the tissue in toto by Weigert's iron-haematoxylin and embedded it in paraffin. I used material no. 1399 for the positive model and cut it perpendicular to the lung surface 20 μ thick. For the negative model no. 2854 was used and cut 15 μ thick, parallel to the lung surface. For the positive model I made plates from refined beeswax in which the paraffin was mixed one part to four of wax. Turpentine oil was also added in small quantity. Such plates are solid, not brittle and not crumbly. Orientation plane was not used for the model. Thus I got a model magnified 80 times and measuring 11.3 cm. in height, 24 cm. in length, and 20 cm. in breadth. I cut the model in four pieces parallel to the lung surface by means of a wire saw. I made use of unrefined beeswax in the construction of the negative model, magnifying it a hundred times so that it measured 8 cm. in height, 12 cm. in length, and 8 cm. in breadth and it contained two air-sacs (figs. 1, 2, and 3).

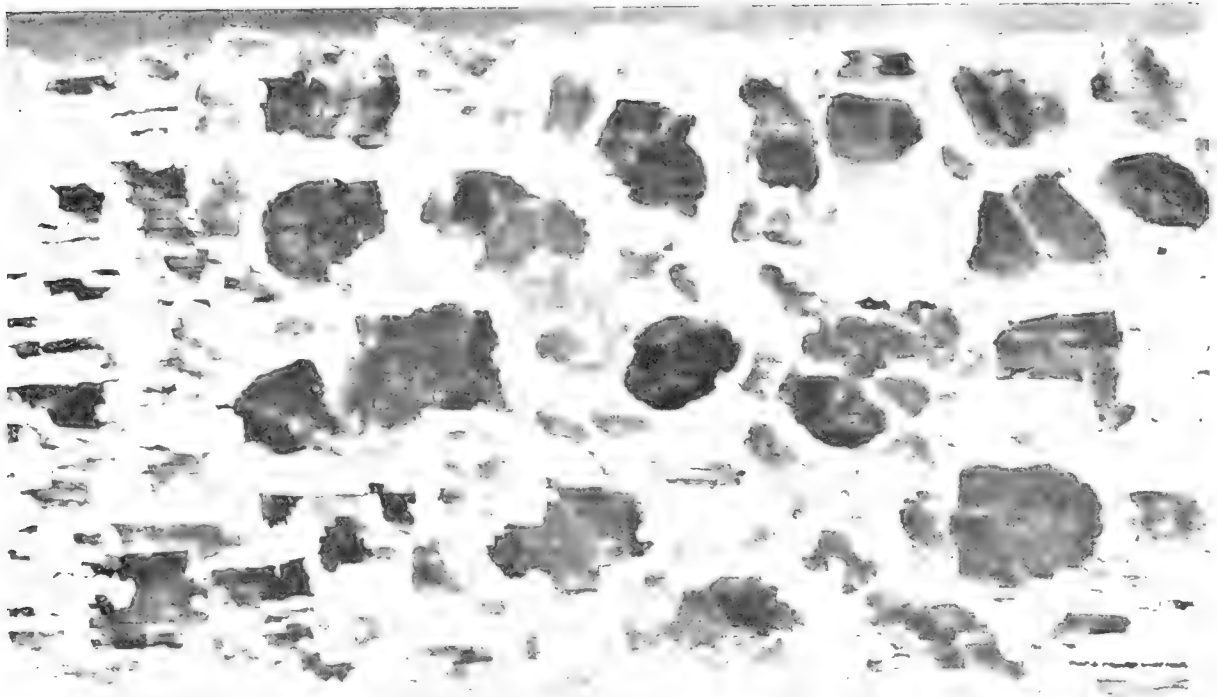

1



2

Fig. 1 Cut plane of positive wax-plate model. Original model $80\times$ enlarged. Figure reduced to $50\times$. Cut parallel to the pleura, 3 cm. apart from it. Pleural side. The larger cavities shown in the figure are air-sacs. The smaller recesses in their walls are alveoli.

Fig. 2 Cut plane of the positive wax-plate model. Magnification same as figure 1. 3 cm. apart from the former cut plane. Pleural side. The larger cavities are alveolar ducts and air-sacs.

DIVISION OF THE FINER RESPIRATORY TUBULES

According to B. N. A. there are two divisions of the finer respiratory passages, namely, bronchiolus respiratorius and ductulus alveolaris. The space from which the end branches divide themselves is designated by Miller the atrium. This name is adopted in several text-books. Several names are proposed for the end branches of the alveolar ducts—sacculus alveolaris,

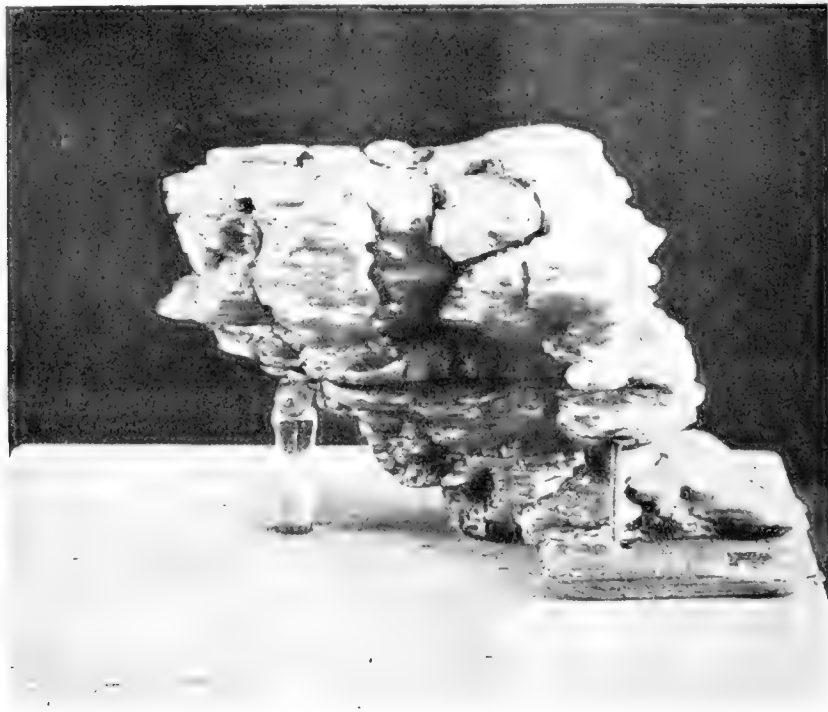

Fig. 3 Negative model including two air-sacs adjacent to pleura. Original model 100 \times enlarged. Figure reduced to 50 \times .

infundibulum, end-sac, air-sac, and so on. Some authors (Cruveillier and Brass) use the word 'infundibulum' loosely for ductulus alveolaris. Furthermore, Nicolas and Testut rather unnecessarily give the name vestibule to the space between the bronchiolus respiratorius and the ductulus alveolaris.

Now I will come to the detailed description of the alveolar ducts,

ORDER, ANGLE, AND TYPE OF RAMIFICATION

Alveolar ducts are closely beset by alveoli. Therefore the designation 'wall of the alveolar ducts' means only the small spaces between each alveolar mouth.

The alveolar ducts divide themselves several times to reach the air-sacs. According to Laguesse, there are six or seven ramifications before the air-sacs are reached. In my model there are four groups of alveolar ducts. I counted the orders into which the alveolar ducts divide before reaching the air-sacs as follows (I term the ramification of the alveolar duct from the respiratory bronchiole the first order): 4, 5, 3, 7, 6, 5, 5, 4, 5, 8, 9, 8, 7, 2. Thus in my model there are two to nine ramifications. Some air-sacs may very probably branch off directly from the respiratory bronchiole and others may pass through nine orders of ramification, although no such cases can be found in my model (figs. 4, 5, and 6).

Now the angle of ramification of alveolar ducts is given from an acute angle to an angle of 180° , usually from 30° to 50° by Schulze and about a right angle by Toldt. In my model the angles of ramification are many, ranging from wide angles to acute.

Monopody, dichotomy, and sympody are terms generally used to designate the type of ramification of the bronchial tree. Much attention has hitherto been given to the type of ramification of the embryonic and adult bronchial tree. In consequence, an extensive literature has accumulated; but leaving recapitulation to Miller, I will here only refer to some accounts concerning the ultimate ending of the bronchial tree of the adult lung. Merkel seems to recognize both monopody and dichotomy in the ultimate ramification. Müller is of the opinion that the mode of division of the terminal air spaces presents no definite rule, though dichotomy is very generally present and one may observe not infrequent occurrences of unequal branches. According to Miller, two processes seem to prevail in the lung of the cat.

Because the alveolar ducts often ramify successively and the walls are irregularly shaped, it is difficult to ascertain the type of ramification. But after careful examination I recognize the presence of both dichotomy and monopody types predominating

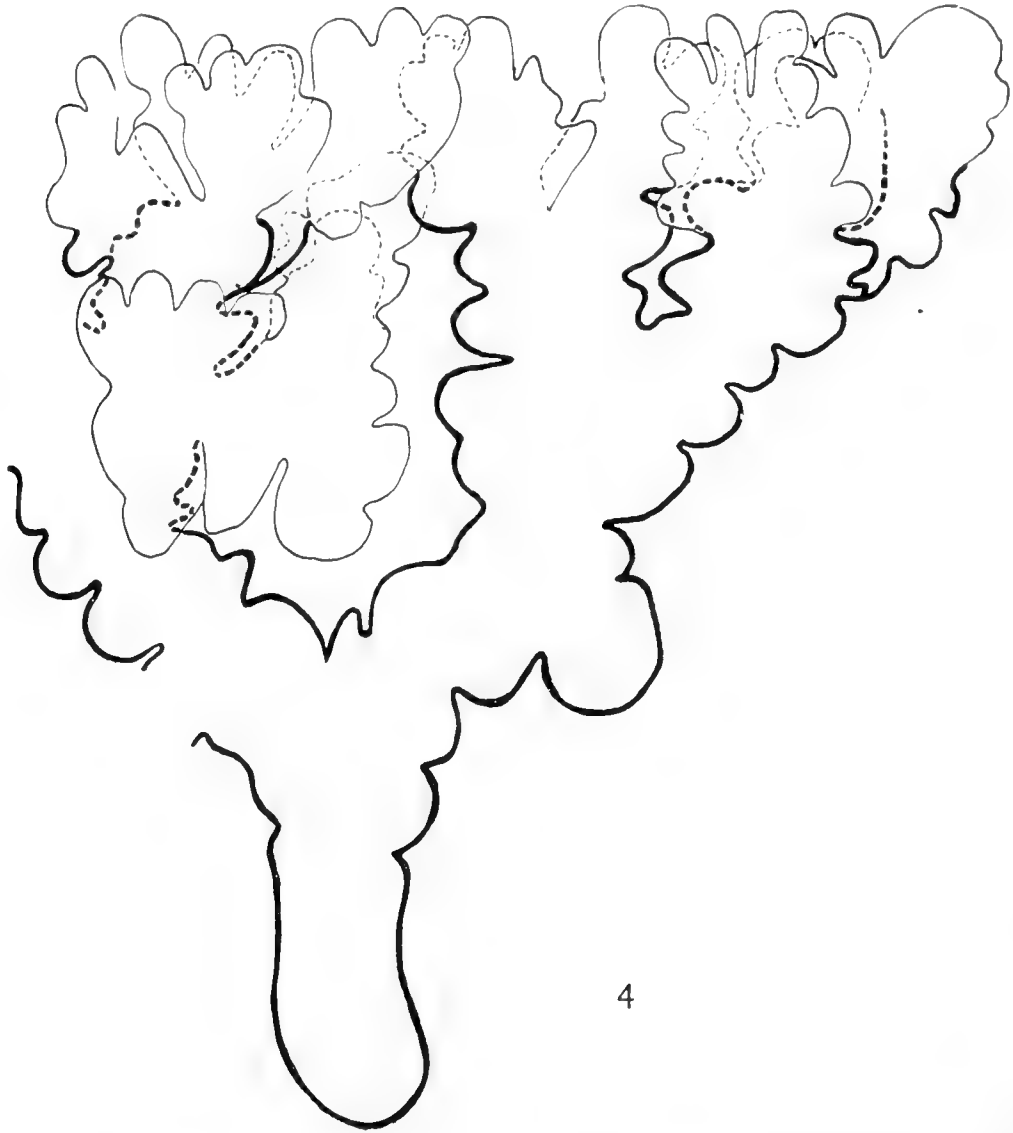

4

Figs. 4 and 5 Diagrams of projection of the alveolar ducts in the positive model. Magnification same as above figures. Thin lines denoting air-sacs. Dotted lines denoting covered parts.

in alveolar ducts. The accompanying diagram (fig. 6) shows the type of ramification in my model. Dotted lines represent the parts where the reconstruction is not complete. In my diagram the angle and length of the branches are not considered with care.

A diverging plane of certain branches of the alveolar ducts is in definite relation to the next in series. According to Waters, in the event of a branch of the bronchial tube dividing twice in succession, the diverging plane of the first is perpendicular



to that of the second. Justesen studied this relation and called attention to the fact that the planes sometimes cut each other under an angle of 120° . This statement appears to refer to the bronchial system and not to alveolar ducts. Now in my model the diverging planes of alveolar ducts frequently cross each other, but they occasionally lie in the same plane.

DIAMETER AND LENGTH OF ALVEOLAR DUCTS

I mean by the term diameter the distance between the edges of two opposite alveolar septa, and by the term length, the length of each branch of the alveolar ducts. By thus measuring both I intend to show how frequently the bifurcations in alveolar ducts take place.

TABLE 1

| LENGTH | | DIAMETER | |
|-------------|-----------------|--------------|------------------|
| Millimeters | Number of times | Millimeters. | Number of times. |
| 0.08 | 1 | 0.11 | 1 |
| 0.16 | 1 | 0.12 | 1 |
| 0.17 | 3 | 0.16 | 1 |
| 0.18 | 1 | 0.17 | 2 |
| 0.20 | 2 | 0.19 | 1 |
| 0.24 | 1 | 0.20 | 2 |
| 0.25 | 3 | 0.21 | 1 |
| 0.26 | 1 | 0.23 | 1 |
| 0.30 | 4 | 0.24 | 1 |
| 0.31 | 4 | 0.25 | 17 |
| 0.32 | 1 | 0.26 | 2 |
| 0.35 | 4 | 0.27 | 1 |
| 0.36 | 1 | 0.28 | 1 |
| 0.37 | 2 | 0.30 | 7 |
| 0.38 | 1 | | |
| 0.40 | 2 | Ave. 0.24 | Total 39 |
| 0.42 | 1 | | |
| 0.44 | 1 | | |
| 0.45 | 3 | | |
| 0.50 | 2 | | |
| Ave. 0.32 | Total 40 | | |

A branch of alveolar ducts is not always thicker than the branches of the next order. In other words, on division the decrease in the diameter of the alveolar ducts is not marked. Schulze puts the diameter of alveolar ducts from 0.4 mm. to 0.2 mm., Kölliker gives the average of 0.27 mm.

MOUTH OF AN ALVEOLAR DUCT

I mean by the above expression the mouth of each alveolar duct (that is, each branch of alveolar-duct system). Inasmuch as the wall of alveolar ducts is not smooth, the mouths of alveolar ducts hold no regular shape. Yet on the whole they may be considered round. The diameter may be the same or somewhat less than that of its respective alveolar duct. In the latter case the ducts seem to be narrowed. This fact is in accordance with Schulze's statement that narrowness of mouth is observed, but not as a rule. Mouths of alveolar ducts are generally well indicated, although they are sometimes outlined indistinctly, and usually enclosed by alveolar septa. These therefore border on one hand mouths of alveolar ducts and on the other the alveoli. In this case there may be alveoli both proximally and distally or on one side of the mouths of alveolar ducts. It occasionally happens that the circumference of the mouths consist entirely of alveolar septa. Usually the mouths partially lack the alveolar septum and are enclosed by the wall of the alveolar duct itself. This is especially true in a wall common to the dividing alveolar ducts.

THE COMMON WALL OF THE DIVIDING ALVEOLAR DUCTS

Upon the division of alveolar ducts into branches they have a common wall for some distance. In most cases this wall continues as far as the next division, although the course is not long. Accordingly, the branches of alveolar ducts are inclined to form groups with closely related branches. If occasionally another branch comes in between two branches of alveolar ducts, the common wall then continues only a short distance. Upon the division into an obtuse angle, or the T form, no common wall is formed. Here there exists only the alveolar septum (fig. 7).

The common wall has at times a different appearance from other walls. In the division of the first parts of the alveolar ducts, sometimes several shallow scaphoidal cavities exist in the common wall along the circumference of the duct. These may be considered shallow alveoli. Sometimes the common

wall is concaved on one side and protrudes correspondingly on the other side, or it may be totally flat on both sides. This flat portion is naturally not beset with alveoli.

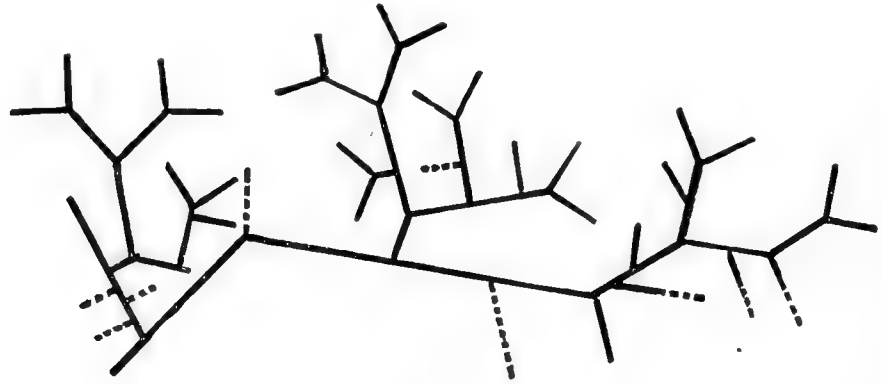

b



7



A

B

a

b

c

8

Fig. 6 Diagram of ramification of the alveolar ducts.
 Fig. 7 Diagram of common wall of the alveolar ducts.
 Fig. 8 Diagram of section of alveoli.

JUSTESEN'S RULE

In the embryonic and adult ox, Justesen found the following rule concerning the number of bronchial tubes: the number of side branches in each case corresponds to those of the continuation of the trunk and its branches. For instance, take a bronchiolus whose first branch bears eight air-sacs. Then the total number of air-sacs attached to the continuation of the bronchiolus are also eight. He gives a skillful explanation of this fact. Now I have applied Justesen's rule to my model and find that it does not hold for the alveolar ducts of the human lung.

THE AIR-SAC

Since (according to Oppel) Rossignol made use of the term *infundibulum* for the last divisions of the respiratory air tubes, the shape of this part has attracted the attention of many authors.

According to Justesen, the air-sac generally arises from the atrium with a relatively narrow opening and then it expands remarkably. Oppel agrees that the air-sac takes an *infundibular* form. On the contrary, Henle, Stieda, and Ebner do not acknowledge this. Laguesse and d'Hardiviller point out that the region of the air-sac is often narrowed. I notice at times a certain degree of extension in the air-sacs, but I do not think this extension is enough to warrant the name *infundibulum*.

Miller, Justesen, and Schulze have shown that the alveolar septa are elongated to a certain extent in the region of the air-sac and divide it into two or three parts. In case the region of the air-sacs is separated in these parts, the elongated septa stand parallel or perpendicular to each other. On the other hand, when there is a partition into four, they cross each other. The alveoli may or may not be included in these parts. In the latter case the parts represent nothing more than deep alveoli.

Now I will show the relation of the air-sacs to the alveolar ducts. If in my model I follow the alveolar ducts forward, they usually seem to divide themselves into two air-sacs, and sometimes into three. But when the air-sacs are sent off as side

branches there may remain but one. Referring to figure 6, one may gain a clear conception of this matter. According to Miller, two to five air-sacs are sent off from the atrium. Justesen states that in the 80-cm. ox embryo four air-sacs and in the adult three air-sacs are sent off from the atrium. The number of alveoli contained in one air-sac is estimated to be from 10 to 20 by Rossignol. My calculation is as follows:

$$\frac{\text{The number of alveoli } 5, 8, 9, 10, 11, 13, 16, 19, 20,}{\text{The number of times } 5, 1, 3, 1, 1, 2, 2, 2, 1,} = 11, \text{ average.}$$

ATRIUM

Since Miller proposed the name atrium, in nomenclature, for the new aspect he found in the respiratory tubes of the dog lung by means of wax-plate reconstruction, many authors have been discussing it without coming to a common understanding.

I will first briefly quote Miller's statements:

Between each air-sac and terminal bronchus there is a cavity, constant in all portions of the lung, which I shall term, atrium. The terminal bronchus is made up of smooth muscle fibers, lined with cylindrical epithelial cells, from the tip of the terminal bronchus three to six vestibules arise. (Vestibules can be used interchangeably with atrium because he withdrew the term vestibule in a later publication.) The diameter of the atrium is slightly more than half that of the air-sac and unlike it each atrium has three or more openings. These openings communicate on the one hand with the air-sacs and on the other with the terminal bronchus.

Since Miller's so-called terminal bronchus is lined by cylindrical epithelial cells, it ought to be the part of the bronchial tube above the bronchiolus respiratorius, but according to his later publications it is said to be equivalent to the alveolar ducts. The fact that authors understand the term atrium in different ways may be due to this inaccurate description. Now Böhm-Davidoff, Spalteholz, Jordan-Ferguson, Morris, Piersol, Schäfer, and others adopt this term in their text-books, and Gray considers it the same as an alveolar duct. V. Ebner in a way opposes this, as the term atrium has no histological significance and arouses only confusion in terminology. Oppel opposing

v. Ebner supports Miller's statement, saying that the atrium is a regional division and needs special designation. Justesen, because of his examination of the ox lung, agrees with Miller. Later on Miller again published a refutation of the disagreement of several investigators. Schulze opposed Miller.

In the irregular bifurcating branches of a tree no one characterizes the points, where a branch divides in two or more end branches, as special spots with proper name. In the same way it would also seem fitting to give no special designation to such points in the respiratory duct system of the lung. Miller's atrium is merely the last end of an alveolar duct before it enters the terminal sacs.

This contention is reasonable. Müller could prove that although an alveolar duct sometimes shows a sinuous expansion here and there before it breaks into the air-sacs, this does not take place constantly. Moreover, many lateral air-sacs are attached directly to alveolar ducts without the interposition of a cavity. According to Sussdorf, when such dilatations chance to appear, the atria are nothing more than the expansion in the dividing part of the air tubes. These expansions serve for the insertions of many branches. Keil could not find any atrium in the lung of sheep. While on the other hand he acknowledges the presence of atria in the dog lung. Miller in his later publication of 1913 still maintains that there are atria in the cat lung. According to him, failure to recognize atria is due to three causes: that the study has been of but one section, that corrosion preparations have been used, or that the specimen has been over-dilated. He says the mere removal of the lungs from the thorax and filling them with fixing fluids may so stretch and distort the atria that they may be mistaken for ductuli alveolares.

The specimen used in the construction of my positive model was injected with fixing fluid after its removal from the thorax. They display no sign of over distention at all; moreover, I cannot see how the whole lung could lose its characteristics by such manipulation.

Upon the examination of my model I notice that there are spaces where air-sacs are sent off, but upon closer study these so-called atria seem little more than short branches of alveolar

ducts or the dividing parts of such ducts. Since the alveolar ducts divide frequently along their periphery, the lengths of branches are accordingly short. These do not take the tubular form. In other words, the formation of these non-tubular spaces is the inevitable result of frequent ramification. I further see in my model that some air-sacs arise directly from alveolar ducts, and that, on the other hand, there are non-tubular air spaces in the more central part of the alveolar ducts.

Thus I think the term atrium lacks enough significance to justify its use, at least for the human lung.

ALVEOLI

a. Structure. The shape of alveoli has been called polygonal, half spherical, or irregular. Alveoli are always polygonal in lungs which have been adequately injected with fixing fluid by way of the trachea or injected through the artery while the lungs are still in position within the unopened thorax. Because of the irregular shape of alveoli, it is often difficult to determine how many surfaces they have. Schulze calls attention to the fact that in several mammals the surfaces rarely number over twelve, and vary in general from five to twelve. My models show that the human lung has alveoli with five surfaces in most and in a comparatively few cases there are six. Although the shape of alveoli is irregular, the formation of alveolar walls seem to conform to fixed types. I shall classify alveoli in three types. Figure 8 represents diagrams of sectioned alveoli. Thin lines denote alveolar septa and the thick ones the alveolar walls beside the septa.

Type A. This kind of alveolus is formed by the projection of the walls of alveolar ducts and it lacks special septa.

Type B. This kind of alveolus is enclosed by alveolar septa alone, except at the base.

Type C. This type is an intermediate form between the other two and presents variations. *a)* One side may consist of the concave wall of the alveolar duct and the other of the alveolar septum. *b)* One side may consist of the concave wall and the

alveolar septum, while the other side may have only the alveolar septum. *c*) The alveolus may be entirely closed by both the alveolar septum and the concave wall of the alveolar duct. (Such an expression as "the concave wall of the alveolar duct" may not be adequate, but one can easily understand what I mean.) Type A and type B are in fact rarely seen, the greater numbers are of the C type. Schulze considers that the mouth is smaller than the lumen, but I notice that the mouth is sometimes larger and at other times smaller.

TABLE 2

| DEPTH | NUMBER OF TIMES | BREADTH | NUMBER OF TIMES |
|------------|-----------------|------------|-----------------|
| <i>mm.</i> | | <i>mm.</i> | |
| 0.04 | 6 | 0.05 | 2 |
| 0.05 | 2 | 0.06 | 2 |
| 0.06 | 7 | 0.07 | 9 |
| 0.07 | 4 | 0.09 | 3 |
| 0.08 | 2 | 0.10 | 16 |
| 0.09 | 4 | 0.11 | 6 |
| 0.10 | 12 | 0.12 | 15 |
| 0.11 | 3 | 0.13 | 2 |
| 0.12 | 8 | 0.15 | 4 |
| 0.13 | 2 | 0.17 | 1 |
| 0.14 | 2 | 0.19 | 1 |
| 0.15 | 4 | | |
| 0.16 | 1 | Ave. 0.10 | Total 61 |
| 0.19 | 3 | | |
| 0.21 | 1 | | |
| Ave. 0.10 | Total 61 | | |

TABLE 3

| DEPTH | BREADTH |
|------------|------------|
| <i>mm.</i> | <i>mm.</i> |
| 0.20 | 0.24 |
| 0.13 | 0.25 |
| | 0.18 |
| | 0.19 |
| 0.10 | 0.15 |
| | 0.21 |
| 0.10 | 0.15 |
| | 0.30 |
| 0.19 | 0.19 |
| 0.17 | 0.17 |
| | 0.12 |
| 0.16 | 0.13 |
| Ave. 0.15 | 0.19 |

b. The size of alveoli. According to Kölliker, the alveoli collapsed after death are one-sixth, one-tenth, and one-eighteenth the size of the normal. Schulze calls attention to the fact that alveoli are of different sizes in the various parts of the lung, namely, alveoli located near the surface of the lung, especially in the apex and edge are larger than those of the inner part. Schulze and Rossignol say that the size of these alveoli increases with age. Rossignol gives the measurements of alveoli according to ages as follows: 0.2 mm. for the ages between eighteen and twenty, 0.22 to 0.25 for twenty-five years, 0.25

for thirty-five to forty, 0.33 to 0.55 mm. for seventy to eighty. In Schulze's account he gives 0.08 to 0.1 mm. for the new-born, 0.15 for middle age, and those 0.25 to 0.4 mm. in breadth and 0.1 to 0.2 mm. in depth for old age.

I measured in my positive model from the thirty-one-year-old man the alveoli in several parts and found the results as given in table 2.

Thus the alveoli in my model on the average measure 0.1 mm. in both breadth and depth.

The results obtained from the measurement of the alveoli of my negative model from the fifty-six-year-old man are as shown in table 3.

The alveoli here measure 0.15 mm. in depth and 0.19 mm. in breadth. Accordingly, these are larger than those of the positive model. But I cannot tell if this difference comes from age, the part of the lung studied and the degree of expansion of the alveoli. According to Rossignol and Miller, the alveoli in the bases of air-sacs are larger than the others. I have also noticed this fact in my model, but this is not the invariable case.

SUMMARY

1. The alveolar ducts divide two or nine times to reach the air-sacs.

2. The angles of ramification of the alveolar ducts are of various grades ranging from wide angle to acute. As type of ramification both monopody and dichotomy are present in an alveolar-duct system.

3. Diverging planes of alveolar ducts frequently cross each other.

4. The alveolar ducts branch in frequent succession, the decrease in the diameter is not marked.

5. The mouths of the alveolar ducts consist of alveolar septa, but usually the mouths are enclosed partially by the wall of the alveolar ducts itself.

6. Justesen's rule that the number of side branches corresponds to those of the continuation of the trunk and its branch, is not true for the alveolar ducts of the adult man.

7. The number of alveoli contained in one air-sac is estimated to be from five to twenty, eleven in average.

8. Miller's atrium is an unnecessary term, at least for the human lung.

9. The alveolar walls (other than the base) are formed usually by both the protruding wall of the alveolar ducts and the alveolar septa.

BIBLIOGRAPHY

- AEBY 1880 Der Bronchialbaum der Säugetiere und des Menschen.
- V. EBNER 1901 Kölliker's Handbuch der Gewebelehre des Menschen. 6 aufl., Bd. 3.
- HAMMAR 1902 Studien über die Entwicklung des Vorderdarmes und einiger angrenzender Organe. Arch. f. mikr. Anat. u. Entwickl.-gesch., Bd. 59.
- D'HARDIVILLER 1897 Développement et homologation des bronches principales chez les mammifères (lapin). Thèse med. de Lille. (Oppel: Vergl. mikr. Anatomie, Bd. 4.)
- HIS 1887 Zur Bildungsgeschichte der Lunge beim menschlichen Embryo. Arch. f. Anat. u. Physiologie, Anat. Abth.
- HENLE 1873 Handbuch der Anatomie des Menschen, Bd. 2.
- JORDAN AND FERGUSON 1916 Textbook of Histology.
- JUSTESEN 1900 Zur Entwicklung und Verzweigung des Bronchialbaumes der Säugerlunge. Arch. f. mikr. Anatomie, Bd. 56.
- KEIL 1910 Beiträge zur Anatomie der Lunge des Schafes. Zeitschr. Tiermed., Bd. 14.
- KÖLLIKER 1881 Zur Kenntnis des Baues der Lunge des Menschen. Verhandl. der physik-mediein. Gesellschaft in Würzburg, N. F. Bd. 16.
- KÜTTNER 1876 Studien über das Lungenepithel. Virchow's Arch., Bd. 66.
- LAGUESSE ET D'HARDIVILLER 1898 Sur la topographie du lobule pulmonaire de l'homme. Bibliogr. anat.
- 1899 Bronchioles respiratoires et canaux alvéolaires. Compt. rend. de l'association des anatomistes. 1. session.
- 1899 Présentation d'un acinus pulmonaire de l'homme. Compt. rend. du 5, congrès français de méd. Lille.
- LAGUESSE 1901 Trois leçons sur la structure du poumon. Echo médical du Nord.
- 1910 L'acinus pulmonaire chez l'homme adulte. Trav. et mem. de univers. Lille (Titres et Travaux du Dr. G.-E. Laguesse).
- LINSER 1900 Ueber den Bau und die Entwicklung des elastischen Gewebes in der Lunge. Anat. Hefte, Bd. 13.
- MILLER 1892 The lobule of the lung and its blood-vessels. Anat. Anz., Bd. 7.
- 1900 Das Lungenläppchen, seine Blut- und Lymphgefäße. Arch. f. Anat. u. Physiologie, Anat. Abth.
- 1913 The air spaces in the lung of the cat. Jour. Morph., vol. 24.
- MOSER 1902 Beiträge zur vergl. Entwicklungsgeschichte der Wirbeltierlunge. Arch. f. mikr. Anat. u. Entw.-geschichte, Bd. 60.

- MÜLLER 1907 Zur vergleichenden Histologie der Lungen unserer Haustiere. Arch f. mikr. Anatomie u. Entw.-geschichte, Bd. 69.
- MERKEL 1907 Ergebnisse der Anatomie u. Entwicklungsgeschichte, Bd. 69.
1902 Athmungsorgane (Bardeleben's Handbuch der Anatomie des Menschen).
- OPPEL 1901 Ergebnisse der Anatomie u. Entw.-geschichte, Bd. 10.
1905 Lehrbuch der vergleichenden mikrosk. Anatomie, Bd. 6.
- PIERSOL Human Anatomy, 5th Edition.
- ROSSIGNOL 1847 Reserches sur la structure intime du poumon de l'homme et des principaux mammifères (Oppel: Lehrbuch der vergl. mikrosk. Anatomie, Bd. 6).
- SCHULZE 1871 Die Lungen (Stricker's Lehre von den Geweben).
- SCHÄFER Textbook of microscopic anatomy, Quain's Elements of Anatomy, vol. 2, p. 1.
- SCHULZE 1906 Beiträge zur Anatomie der Säugetierlungen. Sitzungsbericht kgl. preuss. Akademie d. Wiss.
- STIEDA 1878 Einiges über den Bau und Entwicklung der Säugetierlunge. Zeitschr. f. wiss. Zoologie, Bd. 30, Supplement.
- SUSSDORF 1911 Der Respirationsapparat (Ellenberger's Handbuch der vergleichenden mikrosk. Anatomie der Haustiere, Bd. 3).
- TOLDT 1888 Lehrbuch der Gewebelehre.
- WATERS 1860 The anatomy of the human lung (Justesen and Oppel).

Resumen por el autor, Chikanosuke Ogawa.

Contribuciones a la histología de los espacios respiratorios de los pulmones de los vertebrados.

En el presente trabajo se describe el epitelio respiratorio, fibras musculares, fibras elásticas, y fibras reticulares de los pulmones de los anfibios (*Diemyctylus*, rana, salamandra gigante), reptiles (tortuga, gecko, culebra), aves (paloma, gallina salvaje, pato gorrión), mamíferos (topo, murciélago, rata, conejillo de indias, cabra, conejo, gato, perro y hombre), así como la membrana propia y los poros alveolares de los pulmones de los mamíferos. El epitelio respiratorio de los reptiles ocupa una posición intermedia entre el de los anfibios y mamíferos. En las aves, topo y murciélago el epitelio respiratorio parece faltar. En el embrión de conejo está formado aún antes del nacimiento por dos clases de células. La desaparición de los núcleos de las células planas tiene lugar gradualmente en el estado final del desarrollo. La reparación de las células respiratorias planas parece tener lugar por la extensión de pequeñas células y desaparición de los núcleos. Las fibras musculares faltan en absoluto en todas las partes de los conductos alveolares del pulmón del murciélago. En otros mamíferos existe mucha diferencia en lo referente a su presencia. Las fibras elásticas y reticulares también presentan diferente disposición según los animales. Los poros alveolares existen normalmente en muchos mamíferos.

Translation by José F. Nonidez
Cornell University Medical College, N. Y.

CONTRIBUTIONS TO THE HISTOLOGY OF THE RESPIRATORY SPACES OF THE VERTEBRATE LUNGS

CHIKANOSUKE OGAWA

Department of Anatomy, Kyoto University, Japan

THIRTY-EIGHT FIGURES

CONTENTS

| | |
|---|-----|
| Material and methods..... | 334 |
| Respiratory epithelium..... | 334 |
| 1. Respiratory epithelium in Amphibia..... | 334 |
| 2. Respiratory epithelium in Reptilia..... | 338 |
| 3. Comparison of respiratory epithelium in Amphibia and Reptilia..... | 345 |
| 4. Respiratory epithelium in Aves..... | 347 |
| 5. Respiratory epithelium in Mammalia..... | 349 |
| A. Respiratory epithelium in Talpa and Vesperugo..... | 349 |
| B. Respiratory epithelium in adult mammals..... | 350 |
| C. Criticism of the opinions that the respiratory epithelium is made up of one kind of cell..... | 355 |
| D. Respiratory epithelium in embryonic and new-born mammals... | 356 |
| E. Reparation of respiratory epithelium..... | 362 |
| Muscle fibers..... | 364 |
| 1. Muscle fibers in Amphibia..... | 364 |
| 2. Muscle fibers in Reptilia..... | 366 |
| 3. Muscle fibers in Aves..... | 368 |
| 4. Muscle fibers in Mammalia..... | 368 |
| Elastic fibers..... | 370 |
| 1. Elastic fibers in Amphibia..... | 372 |
| 2. Elastic fibers in Reptilia and Aves..... | 373 |
| 3. Elastic fibers in Mammalia..... | 373 |
| A. Elastic fibers in adult mammals..... | 374 |
| B. Elastic fibers in embryonic and new-born mammals..... | 376 |
| Reticular fibers..... | 377 |
| 1. Reticular fibers in Amphibia, Reptilia and Aves..... | 378 |
| 2. Reticular fibers in Mammalia..... | 379 |
| A. Reticular fibers in adult mammals..... | 379 |
| B. Reticular fibers in embryonic mammals..... | 384 |
| C. Relation between reticular fibers, muscle fibers, and elastic fibers in regard to position..... | 384 |
| Membrana propria and alveolar pores..... | 387 |
| Summary..... | 389 |

Previous histological researches, concerning the respiratory spaces of the lung, have been confined to a limited number of animals, without much consideration of the whole vertebrate system. In this paper I have endeavored to shed further light on these problems and to add to the information we already have.

I wish to extend my heartiest thanks to Prof. B. Suzuki for much valuable advice. I am also deeply indebted to Prof. R. R. Bensley and Dr. G. L. Streeter for their courtesy in placing at my disposal the facilities of their departments while translating this paper.

MATERIAL AND METHODS

The materials used for the present study are as follows:

Amphibia: *Diemyctylus pyrrhogaster*, *Rana nigromaculata*, *Megalobatrachus japonicus*

Reptilia: *Clemmys japonicus*, *Gecko japonicus*, *Elaphe quadri-virgata*.

Aves: *Columba livia*, *Gallus domestica*, *Anas*, *Passer*.

Mammalia: *Talpa*, *Vesperugo*, *Epimys*, *Cavia cobaya*, *Lepus cumiculus*, *Capra*, *Felis domestica*, *Canis familiaris*, *Homo*.

In this investigation the following were used for fixation purposes:

Ten per cent formol, formol alcohol, potassium bichromate, sublimate, Müller-formol, and Flemming's solution. Silver nitrate was used to impregnate the intercellular substance. A description of the technique is omitted here as it is given under each chapter.

RESPIRATORY EPITHELIUM

1. *Respiratory epithelium in Amphibia*

For the study of the respiratory epithelium of Amphibia, the lungs were first injected with a 0.25 per cent solution of silver nitrate and then cut open and spread out. When the cement substance had become dark the pieces were mounted. In the case of *Rana* and *Megalobatrachus*, the tissue which had been impregnated in this way was also imbedded in celloidin

and cut into thin sections. In general the respiratory epithelium of the amphibian lung is more easily impregnated than that of Reptilia and Mammalia. Besides these preparations, controls were made by staining sections and also some of the uncut tissue with ordinary dyes, such as hematoxylin and eosin.

Diemyctylus pyrrhogaster. According to Elenz, the respiratory epithelium of Triton (a genus closely related to *Diemyctylus*), consists of large, flat cells, whose nuclei are also large and are always located in the intercapillary spaces, joining each other on the capillaries. I was able to recognize a similar condition in *Diemyctylus* (fig. 1).

The blood-capillaries of the lung of this animal are only wide enough to admit of the passage of one blood-corpuscle at a time. In some other animals, which will be mentioned later, the capillaries are so wide that two or three blood-corpuscles can pass along side by side. The intercapillary spaces are of varying widths, but they are usually of a somewhat larger caliber than the capillaries.

For convenience in the description we may distinguish two parts in the respiratory epithelial cell, one of which is located in the intercapillary spaces and holds the round nucleus, while the other spreads out flat over the capillaries. These will be called, respectively, the 'nucleated' and 'flat' portions.

In surface view the epithelial cell presents a pentagonal or hexagonal form. The flat portion is extremely thin and can not be seen in transverse sections of the fixed material, while the nucleated portion, which has the same width as the capillary, reaching inward to the stroma, generally has a cuboidal form, though its thickness differs in different parts of the lung, sometimes becoming almost flat.

As a rule, the flat portion appears more extensive in surface view than the nucleated portion, but in exceptional cases the former covers the capillaries only partially and is consequently smaller than the latter. Occasionally the flat portion stretches out over the capillaries and reaches the neighboring intercapillary space. In rare cases a small intercapillary space may have no nucleated portion and is covered only by the flat portion. When

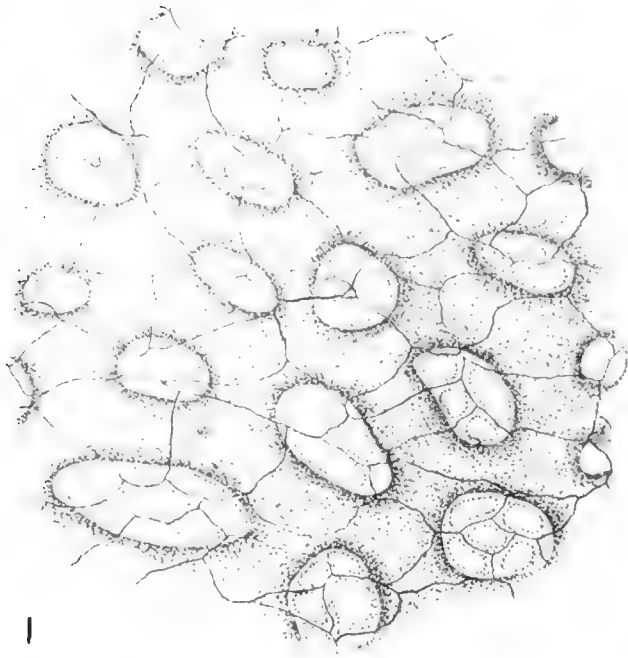

1

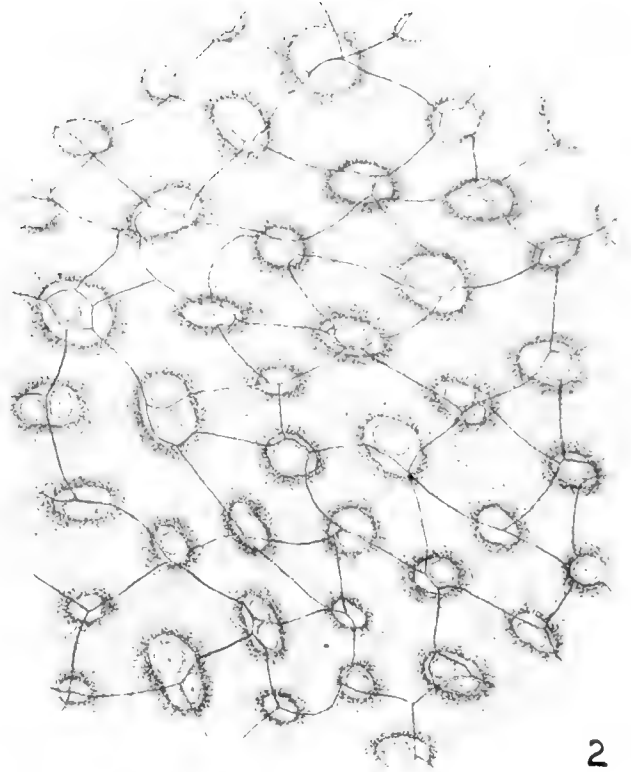

2

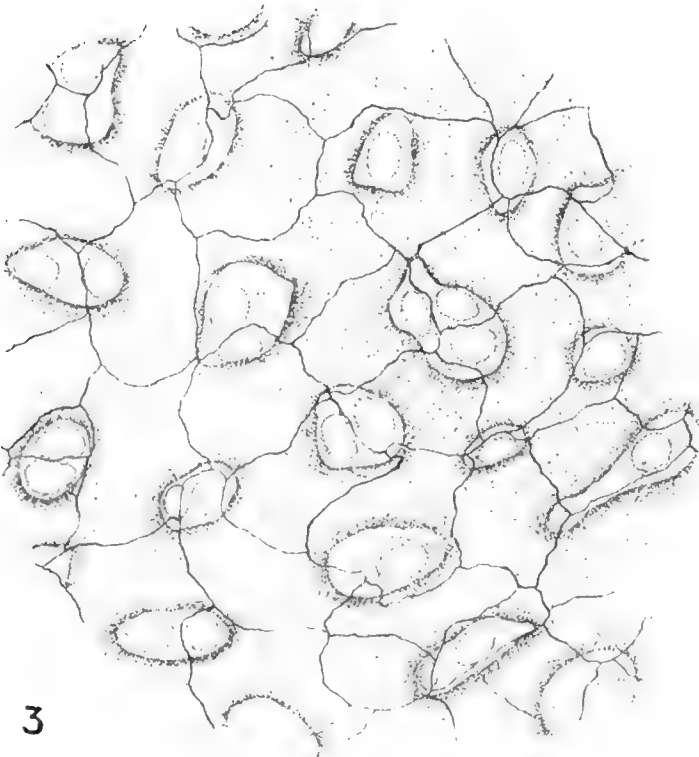

3

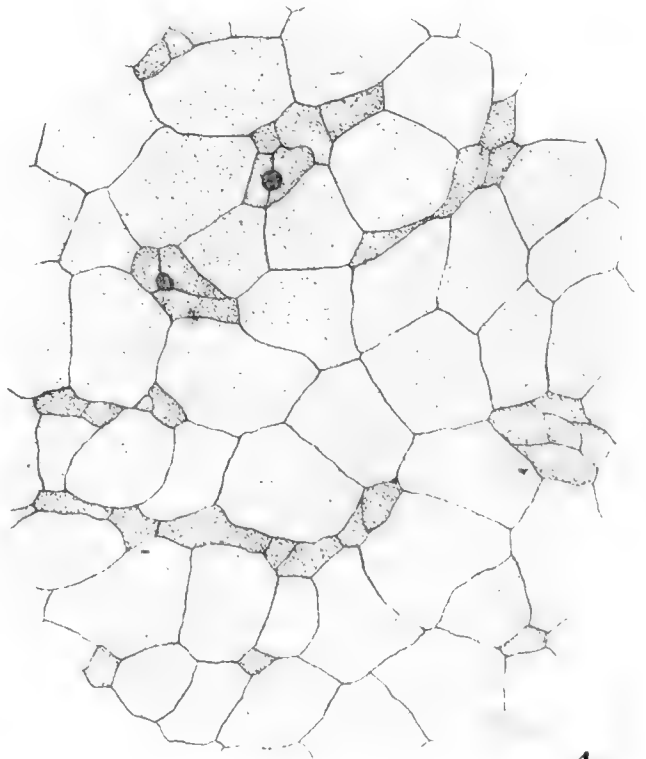

4

Fig. 1 Respiratory epithelium. *Diemyctylus japonicus*. Silver impregnation. Surface view. $\times 350$.

Fig. 2 Respiratory epithelium. *Rana nigromaculata*. Silver impregnation. Surface view. $\times 350$.

Fig. 3 Respiratory epithelium. *Megalobatrachus japonicus*. Silver impregnation. Surface view. $\times 350$.

Fig. 4 Respiratory epithelium. *Clemmys japonicus*. Silver impregnation. Surface view. $\times 350$.

a large number of epithelial cells lie together in an intercapillary space, the cells in the center may not come in contact with the capillaries, so that they have no flattened surfaces and are perfectly cuboidal. Among these cuboidal cells exceedingly small ones are sometimes seen.

Although the blood-capillaries are of almost the same caliber throughout the lung, they may be twice or three times as thick as usual where they branch from arteries or veins. Over these thick blood-capillaries the flat portions of the cells may become greatly extended or the capillaries may be covered by epithelial cells which are totally flattened. The latter, not being in connection with the intercapillary spaces, show no differentiation into two portions, but have the appearance of endothelium.

Rana nigromaculata. The respiratory epithelium of *Rana* differs only slightly from that of *Diemyctylus* (fig. 2).

My results agree on the whole with Elenz's description of the respiratory epithelium of the frog. There are only a few statements to be added.

While in *Diemyctylus* the flat portion of the respiratory epithelium only occasionally spreads from one intercapillary space to a neighboring one, in *Rana* this is almost always the case. The epithelial cells, which are located in an intercapillary space, number from one to four or still more, but usually there is only one. The respiratory epithelium shows no morphological difference in relation to its location in the lung, the cells at the base of the alveoli being like those of the septum. This is also the case in other amphibians and reptiles.

Megalobatrachus japonicus (*giant salamander*). The respiratory epithelium of *Megalobatrachus* is also essentially like that of *Diemyctylus* (fig. 3). The capillaries and intercapillary spaces are somewhat wider than those of *Diemyctylus*. Sometimes very small intercapillary spaces lack nucleated portions of cells entirely. Such pictures are not as rare as in *Diemyctylus*. The thicker blood capillaries are here also covered by wide flat portions of the respiratory epithelium, but I did not find any case in which totally flattened epithelial cells covered such blood-capillaries.

2. *Respiratory epithelium in Reptilia*

The method used for the impregnation of reptilian epithelium was identical with that for amphibian material. The results, however, were somewhat inconsistent.

According to Elenz, the respiratory epithelium of the tortoise and snake consists of two kinds of epithelial cells, namely, small, nucleated cells and flat ones, in which he was unable to demonstrate any nuclei. If this is the case, the respiratory epithelium of Reptilia must be quite different from that of Amphibia. On the other hand, such authorities as Schulze and Osawa seem to believe that the respiratory epithelium of the two phyla has the same construction.

Comparing the two views, it is seen that, according to Elenz, the respiratory epithelium of Reptilia is not essentially different from that of Mammalia, since the respiratory epithelium of the latter, which will be described later, is also composed of two kinds of cells, one of which is non-nucleated. According to other authorities, the respiratory epithelium of Reptilia and Mammalia must be different. Some light is thrown on this question in the following account.

Clemmys japonicus (tortoise). As is well known, the respiratory epithelium of this animal consists of small cells and large flat ones (fig. 4). The small ones, which are usually deeply stained by the silver solution, take a rhomboidal form and contain nuclei. They may appear isolated or in groups of two or five cells and they are in close connection with the intercapillary spaces. The cell borders which are adjacent to the large, flat cells, often curve inward slightly. The intercapillary spaces are said by Elenz to be very narrow generally and entirely filled up by small cells in groups, which sometimes extend over more than the intercapillary spaces. I also found that the intercapillary spaces are in general exceedingly narrow; but sometimes wide spaces, such as are seen in amphibia, may appear here and there. The intercapillary spaces have a round or an elliptic form, being sometimes reduced to a mere slit; in rare cases the slit becomes so much elongated that the length amounts to more

than ten times the diameter of the blood-capillaries. The intercapillary spaces are not grouped in the lung according to their shape and size, but, on the contrary, they may present various appearances even in the same alveolus.

When the intercapillary spaces are narrow, they are, as already mentioned by Elenz, filled up entirely by small cells, while the slit-like spaces are lined only partly by small cells and for the most part by flat ones; occasionally the small cells do not lie entirely in the intercapillary spaces, but are somewhat removed from them. Moreover, the intercapillary spaces are sometimes not filled by small cells, but by large, flat cells alone.

In surface view the large, flat cells show a square to hexagonal form and their diameters are from four to five times as large as those of the small cells. Altogether in Amphibia both the cement lines and the nuclei of the respiratory epithelium turn black by impregnation, in the tortoise only the cement lines are impregnated. As previously mentioned, Elenz was not able to demonstrate nuclei in the flat cells. In order to clear this question, I stained silver preparations with nuclear dyes and studied them in surface view, but since the nuclei of subepithelial cells were stained at the same time, it was difficult to judge, even with the greatest care, whether or not the flat cells contained nuclei. Subsequently numerous celloidin sections were made from such preparations and the point at which the epithelial cells were cut off tangentially from the underlying tissue was carefully examined. Here, where the epithelial cells were free, their nuclei could be seen lying within blackened cement lines, either round or elliptic, and located sometimes in the centre, sometimes eccentrically (fig. 5). These observations show that Elenz's negative results were due to inadequate technique. As a large, flat cell often covers a number of intercapillary spaces at the same time, spaces containing no nucleus are not as rare as in *Diemyctylus*.

Elaphe quadrivirgata (snake). As far as I know, Elenz is the only one who has given a detailed statement of the respiratory epithelium of the snake, which may be quoted as follows:

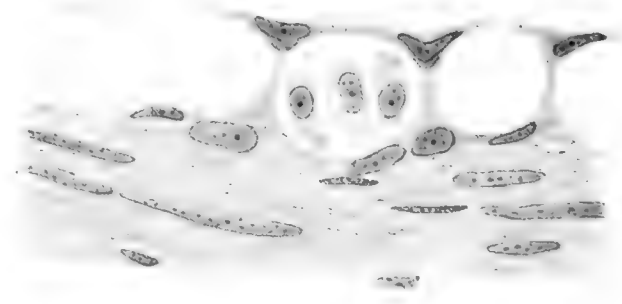
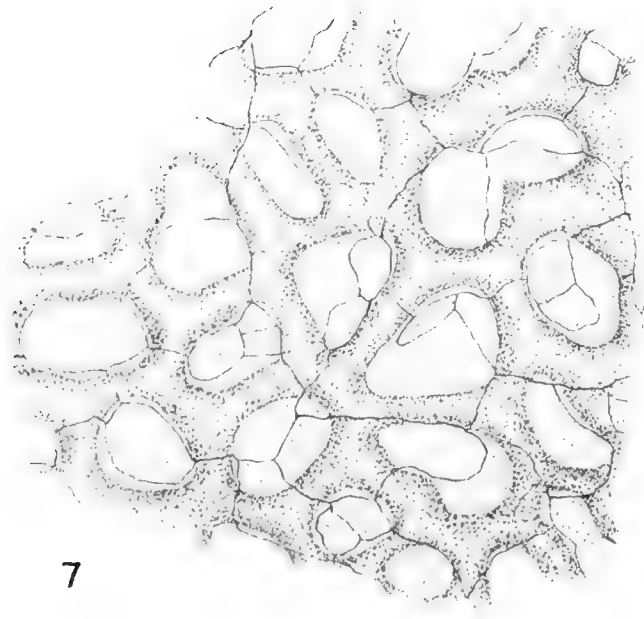
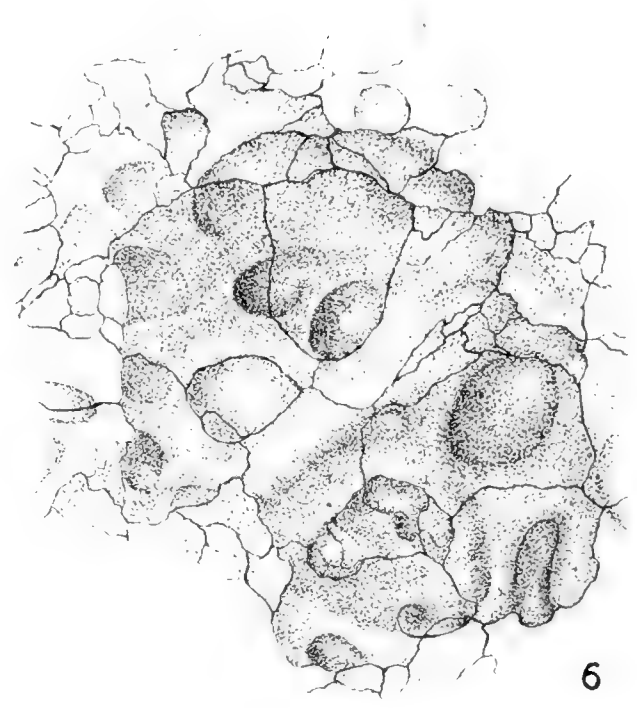
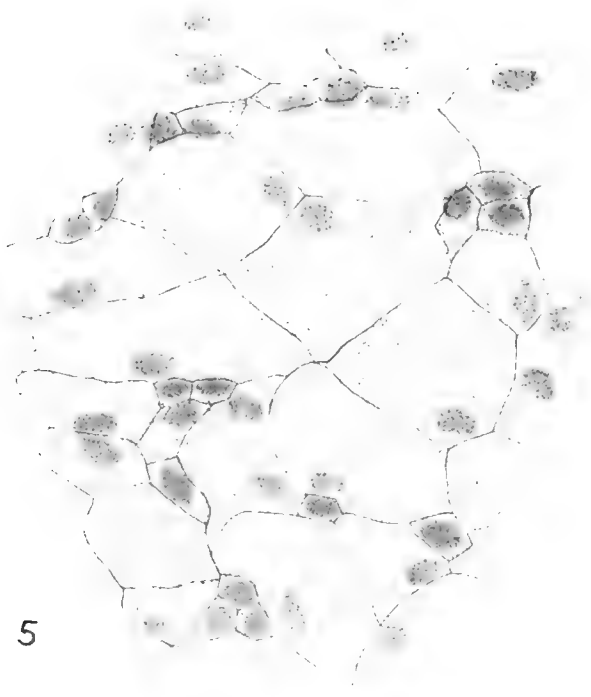

The respiratory epithelium of *Tropidonotus natrix* consists of two kinds of cells, namely, small, nucleated ones, which are always grouped in the intercapillary spaces, and large, flattened ones, which contain no nuclei and connect the islands of small cells. These groups or islands of small cells almost never fill up the whole of an intercapillary space, so that large cells come to lie totally or partly in them also. Here and there one perceives an intercapillary space filled up with two groups of small cells divided by flattened cells. It is rarer to find spaces which contain only large cells. The groups of small cells in the spaces often form quite peculiar, irregular figures with very acute angles. In rare cases one finds the groups of two neighboring spaces connected by small cells, which run over the intervening capillaries. The number of cells, of which a group consists, varies between two and thirty.

Elenz's pictures show that the intercapillary spaces are filled up principally with numerous, small cells. Before giving my opinion concerning the arrangement of the epithelial cells, which differs from that of Elenz, I will describe the general construction of the *Elaphe* lung. The septa of the lung are fairly prominent, the highest ones, having the same length as the diameter of the central canal, becoming gradually lower toward the dorsal aspect of the lung and decreasing very much in height near the sac-like, caudal part, having here an appearance similar to that of the lung of the tortoise. Although the intercapillary spaces do not have uniform width throughout, they are in general wider than the diameter of the capillaries and also by far wider than those of the tortoise. As one would naturally expect, the capillary network included in one septum is divided into two layers, one for each alveolus. The difference between *Clemmys* and *Elaphe*

Fig. 5 Respiratory epithelium. *Clemmys japonicus*. Silver impregnation (nuclei stained). $\times 350$.

Fig. 6 Respiratory epithelium. *Elaphe quadrivirgata*. Silver impregnation. Surface view. Darkly dotted round areas show intercapillary spaces. $\times 350$.

Fig. 7 Respiratory epithelium. *Gecko japonicus*. Silver impregnation. Surface view. Capillaries are dotted darkly. $\times 350$.

Fig. 8 Lung section. *Clemmys japonicus*. $\times 1000$.

Fig. 9 Respiratory epithelium (diagram). Amphibia. In cuboidal part of the cell body a nucleus is contained.

Fig. 10 Respiratory epithelium (diagram). Reptilia. The cell body becomes flat, the nucleus still exists.

Fig. 11 Respiratory epithelium (diagram). Mammalia. The cell body entirely flat, nucleus lost.

with respect to the capillary networks is that the two layers of the capillary networks of *Elaphe* communicate with each other; hence, if capillaries are traced in surface view, they sink to a lower level and can be followed through to the capillary layer of other side (fig. 6).

Now we can distinguish also in this animal two kinds of epithelial cells, namely, small, nucleated cells and large, flat ones.

The small, nucleated cell is not rhomboidal as in the tortoise, but more or less irregular in its shape, though it may be in some instances designated as pentagonal or hexagonal; in general it belongs to the cuboidal category and is situated mostly in the intercapillary spaces.

The large, flat cell is considerably larger than the small cell in surface view—more than ten times as large in diameter. Although the border lines of the cell are not always rectilinear, as is the case in *Clemmys*, it may be described as approximately square or pentagonal. As in *Clemmys* the nucleus cannot be demonstrated by the silver method. Since in *Clemmys*, relatively thick blood capillaries lie beneath the flat cells, it happens that in sectioning the epithelial cells are separated at certain points from the subjacent tissue and consequently the presence of the nuclei, which belong to the epithelial cells, can be confirmed by staining, but it is not so in *Elaphe*, because here the flat cells are considerably large and cover both the blood-capillaries and intercapillary spaces at the same time and sometimes sink more or less into the spaces which are fairly wide; hence it is difficult to cut off the epithelial cells from the subjacent tissue and to decide by nuclear tinction whether or not the stained nuclei belong to the epithelium. However, in specimens which have been impregnated with silver and mounted, without clearing, in such a substance as Japanese millet jelly or glycerin, whose refraction coefficient is far less than that of Canada balsam, a diffuse precipitation of silver is sometimes formed on the surface of the epithelial cells or in the cell bodies. In each cell, however, a clear spherical space, untouched by the precipitate, is present, in which a flat nucleus can be observed, when the light is cut down.

It is to be concluded from the conditions resulting from silver impregnation that these nuclei belong to the epithelial cells and not to the subjacent tissue.

The large, flat cells cover either the intercapillary spaces alone or both the capillaries and the intercapillary spaces; sometimes a cell lies over several intercapillary spaces at the same time.

The arrangement of the respiratory epithelium is not uniform in the different parts of the lung. The intercapillary spaces near the caudal sac-like portion and of the parts on both sides of the median line of the dorsal aspect are lined by groups of numerous small cells. It is only in these regions that I can confirm Elenz's statement. Most of the epithelial tissue is different, in that for the most part the small cells are isolated, and when they do form groups, these consist of only a few cells, rarely of a large number. The flat cells therefore occupy the greater part of the field and often cover the intercapillary spaces also. It is possible that the difference between Elenz's observations and mine can be accounted for by the fact that he studied the structure of only a part of the lung and believed it to be representative of the whole.

Gecko japonicus. Up to this time, no account seems to have been given of the respiratory epithelium of Gecko.

Just as in the tortoise, the tissue consists of two kinds of epithelial cells (fig. 7). The intercapillary spaces are of the same width as those of the tortoise and two or three times as wide as the diameter of the capillaries. The two layers of the capillary network of each septum do not directly communicate with each other.

The small cells are of various shapes, sometimes more or less flattened, sometimes irregularly rounded, elliptical, elongated, square, or pentagonal, and approximately twice as large as those of Clemmys and Elaphe. The cell borders are not straight, but curve inward more or less; even if one border is relatively straight, others are generally curved. The angles of the cell borders are often obtuse. The small cells are found either isolated or in groups. When they are found singly, each one covers either a small intercapillary space completely or a wider

one partially. Occasionally a part of the cell extends over the capillary and sometimes the whole cell rests upon it. In cases where a small cell covers a part of an intercapillary space, it is located not in the middle of the space, but eccentrically against the capillaries, and is generally elongated in its shape, the border, which is in contact with the capillary, being naturally outwardly convex, and the opposite border, curving inwardly, so that the cell is somewhat crescent-shaped and is always slightly narrow at the ends (right, above fig. 7). When two small cells are together, their relation to the capillary is the same as that of a single cell. The boundary line between these two cells is nearly straight. When they entirely fill an intercapillary space, the shape of the two cells is adapted to the space, being more or less round, in case they occupy only a part of the space their short edges are in contact with each other and corresponding the curvature of the capillary, they are horseshoe-shaped, or, if somewhat narrowed at the boundary line, they have the form of an hour-glass. Groups of three cells present, as a whole, a round, elongated, or horseshoe-like form.

The small cells which fill up an intercapillary space vary usually from one to three, in rare cases they amount to more than ten.

The large cells are also flat, their borders not being straight, like those of *Clemmys*, are more or less curved, and though the form of the cell is irregular, it might be described at times as pentagonal or hexagonal. As the diameter of the large cells are four or five times as long as those of the small ones, the difference in their sizes is considerably less than is the case in *Elaphe*. The large cell, unlike the small cell, never presents an elongated form and invests either a whole intercapillary space or both the space and the capillary, in which case the cell extends over the capillary to the edge of a neighboring intercapillary space and there meets the cell of that space; that is to say, the cell is bounded by the contour of the capillary; but in some instances the cell extends over into an adjacent space.

In *Clemmys* and *Elaphe*, the nuclei of the flat cells, as above mentioned, could not be demonstrated by means of the usual impregnation with silver, but those of the small cells were easily

perceived, as the whole cell body was deeply impregnated. On the other hand, nuclei cannot be seen in either kind of cell in the lung of the Gecko in this way, but by using the method described above in connection with *Elaphe*, I was able to prove the existence of a nucleus in both kinds of cells. The nuclei of the two kinds of cells are of the same magnitude in surface view and round or elliptical in shape, the nuclei of the large cells are usually located near the capillaries, in the middle or near the border of the cells themselves.

To sum up the relation of the epithelium to the intercapillary space, it may be said that an intercapillary space is covered either by the small cells or the large ones or by both kinds of cells.

3. Comparison of the respiratory epithelium in Amphibia and Reptilia

I have become convinced that the respiratory epithelium of Amphibia consists of a single kind of cell, while that of Reptilia is made up of two kinds. Some authorities, such as Schulze and Osawa, however, regard the epithelium of the two forms as similar, so that perhaps a thorough examination of the differences between the two will not be out of place.

The large flat cells of Reptilia correspond to the cells which have a flat as well as a nucleated portion in Amphibia, while the small cells of Reptilia might possibly be compared to the small cells of Amphibia which have no flat portions. These cells, however, are so few in number that they can hardly be considered as a regular form, and it is safer to say that there are no cells which exactly correspond to the small cells of Reptilia.

The large flat cells of Reptilia appear at first sight like the epithelial cells of Amphibia. On closer inspection they are found to have differences. In a cross-section of an alveolus of the amphibian lung, the nucleated portion of the respiratory epithelium, lying in the intercapillary space, has the same height as that of the capillary, and the shape, though varying in different parts and at different stages of expansion, may be described as cuboidal, while the nucleus presents a spherical form. In Reptilia the case is different. In the tortoise, for example, the

nuclei in the cells of the intercapillary space lie superficially and are not spherical. As already noted, they are round or elliptical in surface view, but in side view appear somewhat flat, the lower parts of the nuclei following the contour of the capillaries on both sides and sinking only slightly into the intercapillary spaces (fig. 8). Thus it is obvious that the nuclei are situated superficially. In attempting to find out whether or not the cell bodies themselves are also superficial, I found that the hematoxylin-eosin method was useless, as eosin does not differentiate the cell body from the surrounding tissue. Then, for the purpose of differentiating underlying tissue from the epithelium, I used Mallory's, van Gieson's, and Bielschowsky's methods. They also proved unsatisfactory. However, with Heidenhain's iron-hematoxylin the preparations were obtained, which showed distinct differentiation and proved that the cell body dips only slightly into the intercapillary space, not reaching as far as the lower level of the capillaries (fig. 8). It is therefore evident that the large cells of the tortoise are quite flat, while the respiratory epithelium of Amphibia, including nucleated as well as flat portions, is not quite flat. This difference is more significant than may appear at first, as will be shown below. The difference becomes more obvious when we consider the snake and gecko, for here the intercapillary spaces are very wide and the large cells so flat, even in the spaces, that they can hardly be recognized in cross-sections. At times they are confined entirely to the intercapillary spaces; consequently it is here impossible to distinguish two portions, though it is possible in Amphibia. The respiratory epithelium of Mammalia consists of small, nucleated, and large non-nucleated cells and differs from Reptilia in that the flat cell of the latter has no nucleus. The phylogenetic development of respiratory epithelium may thus be summarized as follows: The respiratory epithelium, which consists of only one kind of cell in Amphibia, is divided into two kinds of cells in Reptilia, namely, nucleated, large, flat cell and cuboidal cell, the former being very flat compared with the cells of Amphibia. In Mammalia the epithelium consists of two kinds of cells, while the nucleus is lost in the flat cell. The development of the large, flat cell will be clear from figures 9, 10, and 11.

4. *Respiratory epithelium in Aves*

In the respiratory apparatus of birds, the bronchi, which are always located near the surface of the lung, give rise to the parabronchi which branch sideways into the interior of the lung. The parabronchi divide into the lung-flutes, whose walls are filled with small cavities. These cavities have hitherto been called bronchioli, but it seems to me more fitting to call them flute-holes. From the bottom of each flute-hole extend several small canals which are true respiratory spaces and were erroneously called alveoli by some authorities. I will designate the canals as respiratory canaliculi.

While the flute-holes are lined by continuous pavement epithelium, the wall of the respiratory canaliculi consists of close blood-capillaries, whose spaces have no coating and admit free passage of inspired air, resulting in the communication of all the respiratory canaliculi with each other. Between two neighboring respiratory canaliculi there are usually capillary networks of several layers, so that the spaces are highly complicated and difficult to study microscopically. The intercapillary spaces have about the same diameter as the blood-capillaries.

The respiratory epithelium of birds has been studied by various investigators. Baer studied the lung of the pigeon and came to the conclusion that the intercapillary spaces are coated by delicate, flat 'Belag,' while the capillaries themselves are naked in every case. According to Eberth, the blood-capillaries of the finest air-passages (respiratory canaliculi) are especially uncovered, with flat cells attached here and there. I think that these conclusions are doubtful, for the methods used were inefficient. Most authors, as Elenz, Oppel, Schulze, are of the opinion that the respiratory epithelium of birds, though not actually demonstrated, must be present.

If the respiratory spaces of birds were bare, it would be the only case in higher animals in which either an external or an internal surface of the body has no coating of epithelium.

In studying this question several methods were used. Injection of the lungs of the duck, pigeon, and sparrow with 0.25

to 1 per cent silver nitrate was unsuccessful. Such reagents as ammonia silver, protein silver, protargol, gelatin silver, and osmium silver were used. Only the osmium silver showed some intercellular cement lines along the blood-capillaries of respiratory canaliculi. I found that solutions of silver nitrate above 3 per cent also gave results of this kind. If the respiratory epithelium were impregnated by this, the cement lines, which are seen on the capillaries, must be continuous with those of the epithelial cells of the flute-holes; but, on the contrary, I found that the cement lines do not pass over to the epithelium of the flute-holes, but to the endothelium of the capillaries beneath the epithelium of the flute-holes. Thus it was brought out that even by injection of silver solution into the trachea itself the endothelium of the capillaries are impregnated. In order to make my results more certain, I injected the silver solution in the blood-vessel system and found that images obtained were just like those resulting from injection into the trachea.

Only the embryological evidence remains to be discussed in relation to this problem. Juillet claims to have succeeded in impregnating the respiratory epithelium of advanced chick embryos with silver solutions. Hence I also studied the embryos of the chicken, duck, and goose at several stages of incubation by means of silver impregnation as well as ordinary staining, and was convinced that, though the flute-holes are lined by one layer of cuboidal or flat cells, no epithelium is visible in the respiratory canaliculi themselves; at least, impregnation of the respiratory epithelium never takes place. I am inclined to think that Juillet mistook the epithelium of flute-holes for respiratory epithelium.

With this, the presence of respiratory epithelium in birds became exceedingly doubtful. The fact that no analogous case has been found in which the epithelial coating of a free surface is lacking has led Oppel and other authorities to conclude that the lung of the bird must have respiratory epithelium in spite of the absence of actual confirmation. If it were only the usual silver method which failed here, such an inference might be warranted, but it is difficult to comprehend why no respiratory

epithelium can be seen with those methods by which even the endothelium of the capillaries themselves were impregnated by injection through the trachea. *Therefore, from histological evidence it seems reasonable to conclude that no respiratory epithelium is present in the respiratory spaces of birds.*

As described later, the reticular fibers pursue their course along the blood-capillaries of the respiratory spaces of birds; therefore, there must be a thin membrane, which involves the fibers in the circumference of the blood-capillaries, although no epithelial covering is found here. I treated preparations, which were fixed in Flemming's fluid, with Heidenhain's iron-hematoxylin and looked for such thin membranes, but, as was to be expected, direct demonstration was impossible.

5. Respiratory epithelium in Mammalia

The animals used for this study were the mole, bat, rat, guinea-pig, rabbit, cat, and dog, among which the first two mentioned show considerable differences in the structure of respiratory spaces, so that I will describe them separately.

A. Respiratory epithelium of mole and bat. The respiratory epithelium of these animals has not been described before.

The branching of the air passages of these animals is almost the same as that of other mammals, that is, into bronchioli and alveolar ducts. But the finer structure of respiratory spaces themselves are comparable with those of the bird in several respects. For the intercapillary spaces have no substance at all, the neighboring alveoli communicate with each other freely. The diameter of the intercapillary spaces in the mole is in general two or three times as large as that of the blood-capillaries there, but as each alveolus has its capillary network, the latter appears in surface view to be the one over the other, and accordingly the space seems narrower. The capillary networks of adjoining alveoli communicate with each other.

In the bat there is only one layer of common capillary network between two alveoli, the spaces being of the same diameter as the blood-capillaries there.

In the lungs of these two mammals, just as in birds, no impregnation of cement line occurs with the ordinary silver method, but it can be brought about by using concentrated solutions, or osmium-silver. I examined these cement lines in various ways and it became clear that the lines belong to the endothelium of the blood-capillaries for the following reasons:

1. Following the blood-capillaries to the blood-vessels, I was able to show that the cement lines on the blood-capillaries are sometimes continuous with those of the blood-vessels.

2. As already mentioned, the intercapillary spaces are pores, but in the places where they come into contact with other tissue, such as pleura, they cannot form any pores. If the cement lines, which appear on the blood-capillaries by the silver method, belong to the respiratory epithelium, they ought to continue to the spaces at this place. In order to decide this question I cut the silver preparations tangentially to the surface of the pleura and found that under the microscope some of the intercapillary spaces in the bases of the alveoli, which adjoined the pleura, contained one or two round, nucleated cells, while in other similar spaces there was no coating of cells at all. This can also be seen in stained section. Even with the most careful examination I could not follow the cement lines of the blood-capillaries to the spaces.

From this it must be concluded that by injection of the air passages with silver solution, capillary endothelial cells are the only ones which are impregnated, except for the cells at the bases of the alveoli adjacent to pleura, which are also impregnated.

The embryos collected for the study of development of respiratory epithelium in the mole were of too earlier stages, but in the young mole I perceived frequently round nucleated cells in the intercapillary spaces, but no trace of epithelial cells on the blood-capillaries.

From these studies it seems most probable to conclude that in the mole and bat, as in the bird, there is no coating of respiratory epithelium.

B. Respiratory epithelium in adult mammals. It is generally believed at present that the respiratory epithelium of adult

mammals consists of flat, non-nucleated cells and small nucleated cells. As the respiratory epithelium is essentially the same in the mammals which have been studied, the following description will apply to them all (fig. 12).

The small, nucleated cells present in surface view a round or elongated form, from $2\ \mu$ to $15\ \mu$ in breadth and averaging $5\ \mu$ in height. It has been described sometimes as flat, sometimes as cuboidal. As a matter of fact, it is intermediate between the two types and might properly be called either flat or cuboidal, but in order to avoid confusing it with the non-nucleated plate, it will be convenient to designate the nucleated type as cuboidal. These cells are distributed not always uniformly and the size of the alveoli is also variable, so that the number of nucleated cells in different alveoli differs very much, amounting from one to ten or more. It is obvious that in the guinea-pig, rat, and others, which have small alveoli, the nucleated cells in an alveolus are fewer. Though these cells usually appear scattered, they sometimes form groups of two or five cells. Although they border the non-nucleated cells, sometimes each cell appears singly in the midst of the non-nucleated cells.

The large, flat, non-nucleated cells are approximately pentagonal or hexagonal in shape, though their outlines are not straight. Their diameters are usually at least ten times as long as those of the small cells. Cells of intermediate size between the two are almost never seen. The non-nucleated cells in one alveolus number from three to ten or more. As there is no considerable difference in the size of the epithelial cells of different animals, they are fewer in the animals with smaller alveoli.

According to Kölliker, the edge of the alveolus is almost entirely covered with the non-nucleated and only seldom with the nucleated cells. I agree with this statement. The non-nucleated cells are bent over the edges of the alveolar septa, so that they cover two sides of the wall at the same time.

For studying the relation between the capillaries of the lung and the respiratory epithelium, it is best to select either the preparations in which the capillaries as well as the epithelium are impregnated or the ones which are mounted in glycerin.

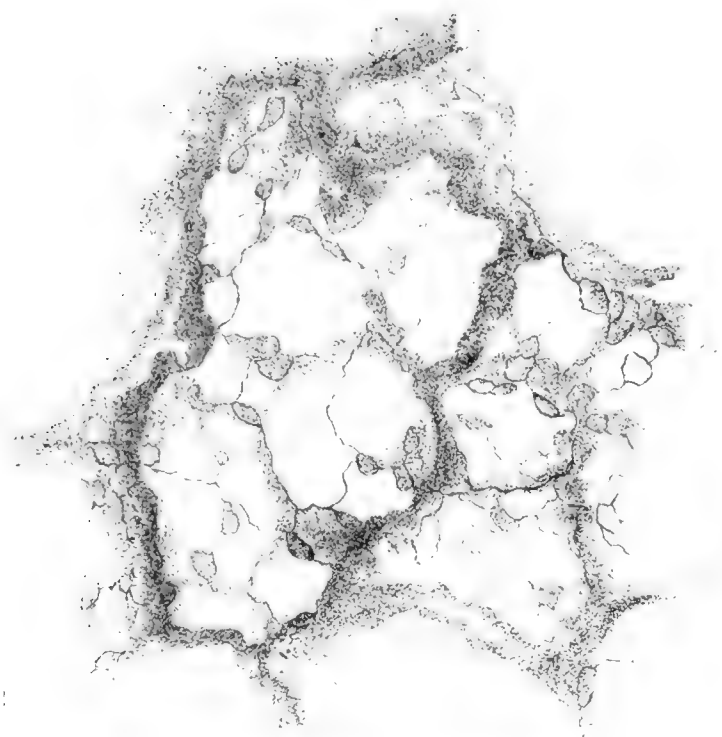

12

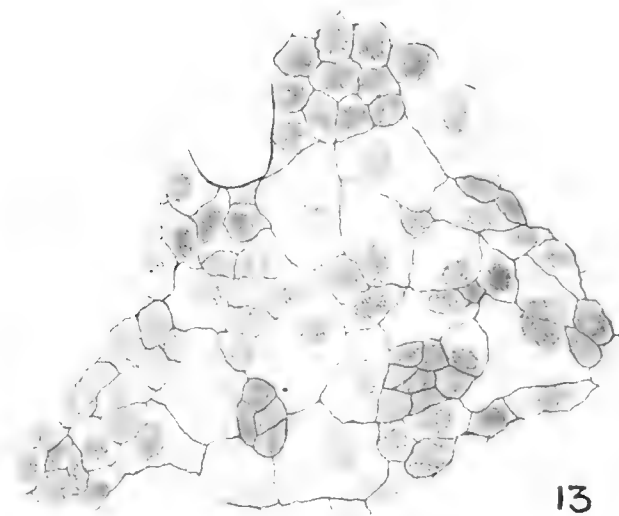

13

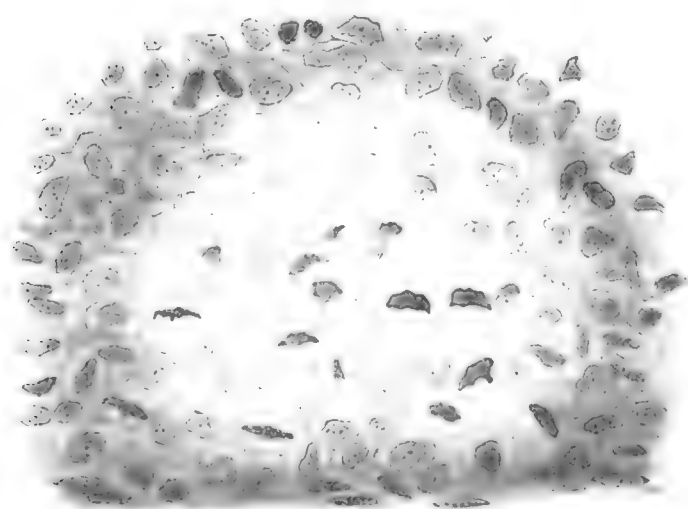

14

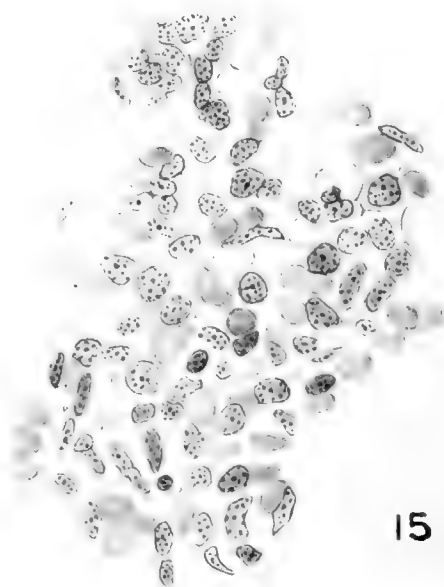

15

Fig. 12 Respiratory epithelium. Cat. Silver impregnation. $\times 350$.

Fig. 13 Respiratory epithelium. Rabbit embryo (11 cm.). Silver impregnation, with nuclear staining. $\times 350$.

Fig. 14 Respiratory epithelium. Rabbit embryo (11 cm.). Hematoxylin-eosin. $\times 600$ (not from the injected material, but from the material soaked in fixing solution).

Fig. 15 Respiratory epithelium. Rabbit embryo of full term. Hematoxylin-eosin. $\times 1700$.

It is very difficult to combine injection in the capillaries with silver impregnation. As already shown, the small nucleated cells are located in the intercapillary spaces and the non-nucleated cells in the intercapillary spaces and on the capillaries, which are common to two adjacent alveoli.

An intercapillary space is generally coated on one side of the alveolus by a nucleated cell and on the other side by a non-nucleated cell; it seldom happens that an intercapillary space has nucleated cells on both sides of the alveolar wall. According to Kölliker, the small nucleated cells may be sometimes absent from the intercapillary spaces; but in my opinion this is a frequent occurrence, and such spaces are naturally lined by the non-nucleated cells. On the contrary, the small, nucleated cells are apparently only seldom situated on the blood-capillaries.

It was first affirmed by Kölliker that the large cells had no nuclei. But in his investigation he used only the silver method, and in his conclusion he is less emphatic, saying only that they appear to have no nuclei. Since then his statement has been accepted without sufficient examination and it has been assumed that because the silver method did not reveal nuclei in the large cells, while it did in the small, the former contained no nuclei. But, as previously described, the presence of the nuclei in large, flat cells of such reptiles as the tortoise and snake is never demonstrated by silver impregnation alone and can only be confirmed by the aid of other methods, so that the absence of nuclei in mammalian material had not been proved. With this in mind, I attempted by various methods to settle the question. There seem to be only three methods which are applicable to this purpose—the first, maceration of non-nucleated cells; the second, staining of nuclei by dye-stuffs in impregnated preparation, and the third, examination of silver impregnated material in a less refractive medium. The first method consists in injecting a macerating solution into the air passages in order to strip the epithelium from the subjacent layer and determining whether or not the isolated cells have nuclei, but the large, flat cells are easily damaged by macerating solution, as they are very delicate, so that this method is always a failure. The second method at

first also appeared unsatisfactory, because the large, flat cells are exceedingly thin and it is impossible to decide whether the nuclei, which are stained, belong to the subepithelial cells or to the epithelial cells themselves. But after further attempts I happened to obtain a preparation which showed a large, flat cell containing no nucleus within its limiting cement lines owing to lack of subepithelial cells here. This image proves that the large, flat cell has no nucleus. I applied the third method at the mouth of the alveolar ducts. Here the several kinds of fiber bundles run circular and accordingly the subepithelial nuclei are poor, so that I affirmed several times the fact that the epithelial cells are here non-nucleated.

Lange has investigated the respiratory epithelial cells in an experimental way, but it seems to me that his work is open to criticism from several points of view. He bled rabbits, extracted the lungs, injected them with isotonic salt solution, and collected the liquid running off from the tracheal stump and that obtained by slitting the surface of the lung. He then centrifuged the liquid and studied the residue microscopically. The following are my arguments against his work:

1. In the rinsed liquid he found alveolar (respiratory) epithelial cells, endothelial cells from blood-vessels, polymorphonuclear leucocytes and red blood-corpuscles. I should think that epithelial cells of the bronchioles and mononuclear leucocytes ought to have been present also. When these cells are in normal position, they may be easily distinguished, but when isolated, it is impossible to judge from what part of the lung some of them came. I have injected the trachea with several maceration liquids, cut the surface of the lung after some hours, and examined the escaping fluid, but I could see only one kind of round nucleated cells. Naturally it is impossible to distinguish them, though there must be different kinds.

2. The alveolar epithelial cells, which were described and figured by Lange, are all nucleated. He did not seem to recognize the fact that there are two kinds of respiratory epithelial cells. It therefore seems that Lange started his work with some fundamental mistake, which renders his further experiments unreliable.

It will perhaps not be out of place here to discuss the methods used by pathologists in studying respiratory epithelium, though they have already been considered by Müller. The pathological changes in respiratory epithelium have been determined by the study of thin sections of the lung, stained in the ordinary way, and this method is exceedingly inadequate because it does not reveal the non-nucleated cells, which make up the greater part of the coating of the respiratory spaces. The small nucleated cells may at first seem easy to recognize in these preparations, but in fact this is not the case, because, owing to the thinness of non-nucleated cells, it is necessary to make a careful examination before deciding whether a nucleus, which appears within the alveolar wall, belongs to the small, non-nucleated cells or to the subepithelial cells.

C. Criticism of the opinion that the respiratory epithelium is made up of one kind of cell. According to Oppel, the large non-nucleated cells of the respiratory epithelium are not separate cells, but parts of small nucleated cells, the impregnated cement lines being the borders between these portions and the blood-capillaries. Scymonowicz and Osawa agree with this statement. My reasons for objecting to this opinion are as follows:

1. If the non-nucleated cell is considered as a part of a nucleated cell, then in what way can the border lines, which appear with impregnation, be explained? In Amphibia the border between the flat portion and the nucleated portion undoubtedly follows the contour of blood-capillaries; but this is not the case in mammals, because it can be easily shown in silver preparations, which are mounted in something like glycerin, that the cement lines of the epithelial cells do not correspond to the edges of the blood-capillaries. Oppel believes that the presence of border lines between the two parts of the cells may also be explained in some other way, but he does not himself explain it.

2. The large, non-nucleated cells are usually adjacent to the small, nucleated cells, but sometimes the former do not touch the latter and are enclosed entirely by non-nucleated cells. (For example, non-nucleated cells in the middle of figure 16.) In such cases the non-nucleated cells can hardly be considered as parts of nucleated cells.

3. According to my observation in regard to the formation of the respiratory epithelium, non-nucleated cells arise from nucleated cells by the loss of their nuclei, the details of which process will follow in the next section (D).

In short, from the above argument, it seems that the non-nucleated cells cannot be considered as parts of the nucleated cells.

D. Respiratory epithelium in embryonic and new-born mammals. No agreement has hitherto been reached in the discussion as to the form of this tissue in foetal life and its change at birth. Küttner makes seemingly contrary statements in his work, on the one hand describing the respiratory epithelium of the embryo as gradually flattening out up to the time of birth, and on the other hand speaking of the cuboidal cells of the embryonic alveolus as changing to the flat cells with the first respiration. Stöhr seems to be of this same opinion concerning the sudden change of the flat cell at the first breath. Stieda showed that in the lung of a 250-mm. sheep embryo and of a large ox embryo the alveolar ducts are coated with a simple flat epithelium. Kölliker also finds a homogeneous lining of flat epithelium in the alveoli of mature embryos, and according to him the respiratory epithelium is formed in such a way that the epithelial cells which cover the blood-capillaries are subject to great pressure by the mechanical expansion of the alveolus at the first breath and consequently are stretched considerably. Schulze describes the alveolar epithelium of fully developed embryos as flat, and he claims that the formation of non-nucleated cells is due to the expansion of the blood-capillaries of the alveolus and that the fusion of adjacent cells also participates in this formation. Ebner believes that the large, flat cells arise from the fusion of embryonic flat cells. According to Croix, the alveolar epithelium of the human embryo before respiration has taken place is all flat and two kinds of epithelium are formed in the same way that Schulze describes, only without the process of cell-fusion. Moreover, Croix asserts the loss of the nucleus from the large cells is ascribed to their flattening. All above-mentioned authors consider that the respiratory epithelium

originates from one kind of cells and develops into two kinds with the beginning of respiration, but Minot and Müller have quite an opposite idea. Müller studied the still-born embryos of horses as well as oxen and a 230-day ox embryo. He did not find an unbroken coating of epithelium on the walls of the alveoli, but observed gaps between the nucleated cells, which seemed to signify the presence of the non-nucleated cells. He believed it impossible to explain the formation of non-nucleated cells by the act of respiration only, but supposed that the cells are formed in the later embryonic stages. Müller only used ordinary stained preparations which are unsuitable for the study of respiratory epithelium, and he did not use the silver method, so that his results cannot be regarded as conclusive. From this diversity of opinion it is evident that the question of embryonic respiratory epithelium and its formation is still under controversy and that an answer has not yet been given as to when and how the large, flat cells lose their nuclei.

For my investigations I used rabbits for the most part, also guinea-pigs, rats, and mice.

No impregnation occurs in embryonic tissue if freshly cut pieces are soaked in the solution of silver nitrate under pressure, so that for impregnation the solution was injected through the trachea, resulting in the expansion of alveoli. In general, impregnation of the embryonic respiratory epithelium cannot be easily accomplished.

I impregnated 11-cm. rabbit embryos and noticed that the respiratory epithelium was differentiated into two kinds, small cells and large, flat cells, but this difference seems to be the result of the expansion of the alveolar walls by the silver injection. The small cells have nuclei and significantly the large, flat cells also contain nuclei. The nucleus takes up a greater part of the cell body in the small cell, while it is located either in the middle or eccentrically (fig. 13). The lungs of the animals of the same litter were used as controls, some being merely soaked in the fixing solution, while others were injected with the fixing solution into the trachea. In such preparations it can be seen in surface view that some of the alveoli are lined by a uniform cuboidal epi-

thelium and others are coated by epithelium which is differentiated into cells of two different shapes (fig. 14). Also in surface view the nuclei of the epithelial cells are seen separated from each other and between them the red blood-corpuscles are often apparent, implying the presence of blood-vessels in these spaces. When looking at the sectioned surface of the alveolar wall, it is often impossible to distinguish any epithelial cells on the blood-capillaries, which shows that very thin portions of epithelium exist here.

I also removed the embryos from the mother animals just before birth and treated the lungs in the same way. I found here also that the epithelial cells were differentiated into two kinds. The flat cells are partly non-nucleated and partly nucleated. Whether or not a cell contains a nucleus requires very careful consideration, though it is less difficult here, because the alveolar walls of embryonic lungs are somewhat thicker than those of the adult animals. Cells in which no nuclei could be impregnated by silver and also distinguished by examining in a less refractive medium like glycerin under regulation of light were considered to have no nuclei. When a nucleus was not impregnated, but appeared within the border line of a cell by light adjustment, it was decided by careful focusing whether it belonged to an epithelial or subepithelial cell. But even then it was sometimes impossible to decide. I concluded that an epithelial cell contained a nucleus, when an impregnated nucleus appeared within the border lines of the cell. I then proceeded to fix and stain the embryonic lung of the same litter and found the microscopical image different from that of an 11-cm. embryo. The blood-capillaries in the walls of the alveoli were filled by blood-corpuscles, though respiration had not occurred, and accordingly could be traced without any injection. Seen in surface view (fig. 15) and at the cut plane, the nuclei rarely appeared on the blood-capillaries. In the intercapillary spaces there existed cuboidal, nucleated cells, which were nucleated epithelial cells. The border lines of the flat cells had disappeared in these stained preparations. I next tried silver impregnation and ordinary staining on the lungs of new-born rabbits just after

the birth. The silver preparations of these new-born animals appear almost the same as those of adult animals and no nuclei are visible in the flat cells (fig. 16). The flat cells were examined in the way mentioned above, and though I could find places in which the absence of nuclei was perfectly certain, it was technically impossible to show that all of the flat cells in the field were non-nucleated. The stained preparations also presented the same appearance as those of the full-term embryos (fig. 17).

It is clear from these descriptions that the respiratory epithelium of the embryo in early stages consists of a single kind of cuboidal cell and, as development proceeds and comes nearer to the final stage, some of them become flatter. This differentiation does not occur to the same extent in all alveoli, some alveoli being covered by cuboidal and flat epithelial cells and others by cuboidal cells alone. In the final stage the respiratory epithelium of all the alveoli consists of a mixture of the two kinds of cells. Therefore, the prevailing opinion that respiratory epithelial cells are not differentiated into two kinds until the first respiration is not true. But it is beyond doubt that the flat cells, which have differentiated before the beginning of respiration, become flatter in consequence of respiration.

Disappearance of the nuclei of flat cells takes place also in the final embryonic stages, and occurs not suddenly, but gradually. It can be inferred from preparations in silver and ordinary stains that the greater part of the nuclei probably has disappeared before parturition.

Now I will describe the process of disappearance of nuclei. As can be seen in figure 14, the nuclei of some of the flat cells are stained more deeply than those of other adjacent cells and are smaller in size and irregular in shape, not being round. Sometimes chromatin substances are assembled at one side of the nuclei and the free edges of the nuclei are irregular. Moreover, they are often stained by eosin. These different nuclear conditions, which cannot be considered as normal, correspond to the phenomena of pyknosis and karyorrhexis and may be interpreted as being in the process of disappearance. In the new-born foetus we sometimes find the same suggestion of nuclear disappearance in alveolar walls.

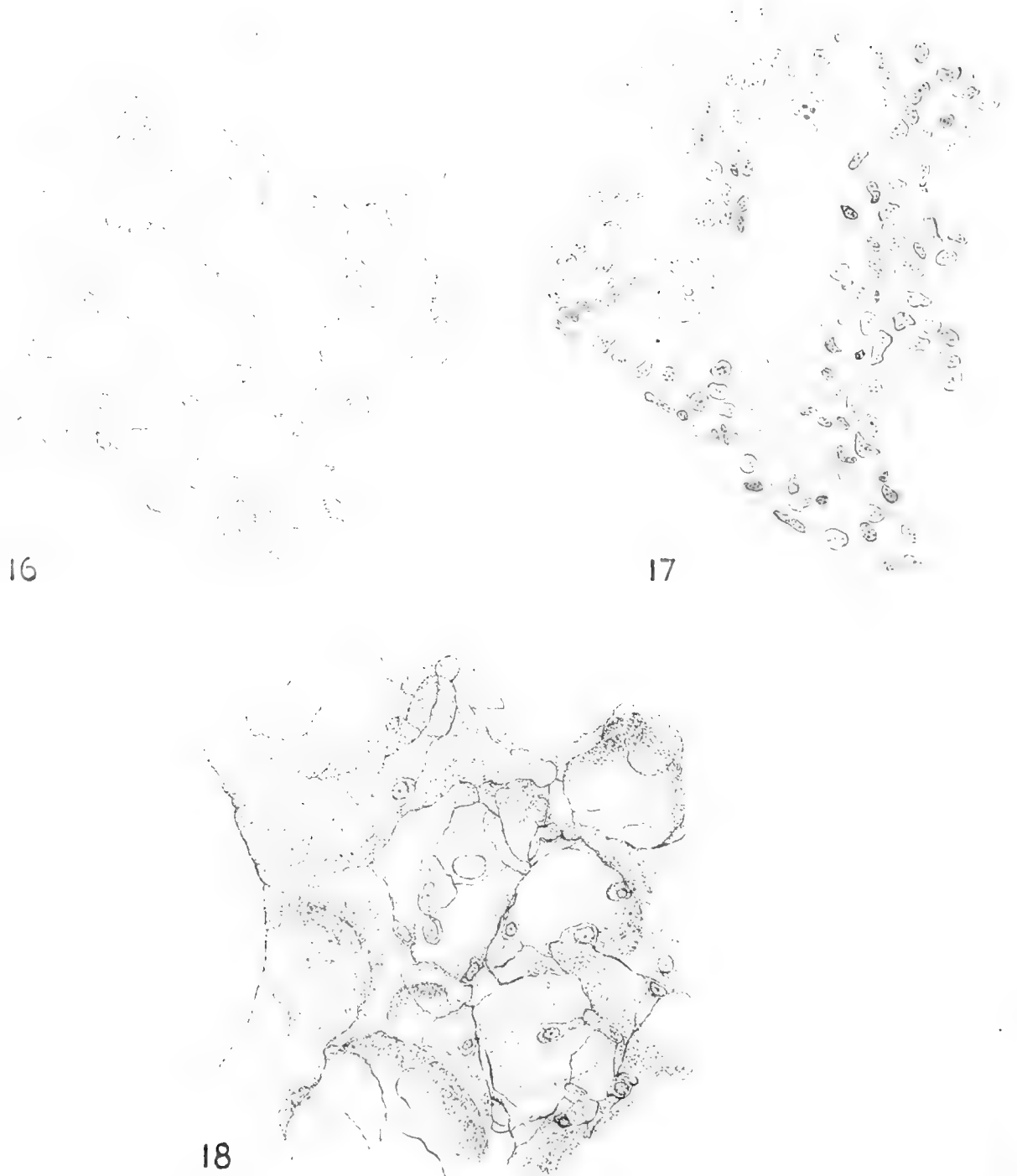

Fig. 16 Respiratory epithelium. Still-born rabbit embryo. Silver impregnation. $\times 350$.
Fig. 17 Respiratory epithelium. Still-born rabbit embryo. Hematoxylin-eosin. $\times 600$.
Fig. 18 Respiratory epithelium. Rat. Two days after water injection. Silver impregnation. $\times 350$.

I will now describe the cause of the formation of the two kinds of respiratory epithelial cells. According to Küttner, the formation of two kinds of cells is due to the pressure of air alone at the time of the inflation of the lung. However, as the alveolar walls are exposed to the same pressure at all points, it would seem that the epithelial cells would all become equally flattened unless there were some other cause at work, so that his opinion seems open to objection. Jalan de la Croix insists that instead of pressure the tension must be considered as the cause, but it seems to me that this is open to the same objection, as pressure and tension are merely different expressions of the same condition. Besides the tension, the existence of blood-capillaries is looked upon as another cause by Schulze, Croix, and Kölliker. According to Kölliker, the epithelial cells which coat the blood-capillaries will be particularly subject to strain and flattening by the expansion of the alveolar walls. All these investigators made these assumptions on the ground that the respiratory epithelial cells are homogeneous in the embryonic stage, but, as I explained above, the epithelial cells are already differentiated before respiration into two kinds, so that these conclusions are quite unsatisfactory. It seems to me that the best explanation is as follows: In the alveolar walls of the embryos no basal membranes are visible below the epithelium and the epithelial cells are located directly on the blood-capillaries. Therefore, they are gradually extended and flattened by the growing of the alveolar walls on one hand and of the blood-capillaries on the other hand, especially on the blood-capillaries. It can be easily imagined that as the epithelial cells are flattened, they acquire a great power of extension compared with the inter-capillary cells, so that, when respiration takes place and the alveoli are suddenly expanded, the flat cells become conspicuously extended. Whether or not this statement is accepted as correct, there can be no doubt about the fact that by some process a part of the epithelial cells become differentiated during later embryonic stages in such a way that they are more capable of expansion. Moreover, the extensibility of epithelial cells seems to have nothing to do with the disappearance of their nuclei, for the epithelial cells can be

flattened even in the presence of nuclei. This is clearly shown in figure 13, which represents the preparations made from an 11-cm. rabbit embryo, expanded by silver solution. It can be seen in a view of sectioned alveolar walls that the nuclei are flattened in accordance with the flattening of the cells.

According to Ebner and Schulze, the fusion of the epithelial cells is partly responsible for the formation of flat cells. But hitherto no positive proof of the fusion of embryonic epithelial cells has been given, and, as figure 13 shows, the flat cells can be formed without fusion, so that it seems superfluous to look for the cause there.

In conclusion of this topic, a brief description of the blood-capillaries of the alveolar walls of embryonic lungs may be given. It is already known that in the foetal circulating system most of the blood from the right ventricle flows into the aorta and only a small amount of it enters the lung. Therefore I imagine at first that the blood-capillaries of the alveolar walls would be in a somewhat collapsed state. But, on the contrary, the microscopic examination shows that the capillaries are filled with blood-corpuscles. Therefore, it cannot be true that the collapsed blood-capillaries are extended and produce new lumina at the time of the first respiration, but they increase in their length and caliber only in accordance with the expansion of the alveoli, and in consequence of increase of capacity the blood starts to flow into the lung from the general circulation.

E. Reparation of respiratory epithelium. There must be a limit to the duration of the respiratory epithelium. It would be an interesting problem to investigate how the degenerate epithelial cells, especially non-nucleated cells, are repaired, but up to this time there has been no report made along this line.

There is a distinct difference between the small, nucleated cells and large, non-nucleated cells in ordinary microscopical preparations, and no intermediate forms are found. The processes of reparation or regeneration cannot be followed in such material. In order to bring about regeneration in an experimental way, I tried several methods. At first I injected the various kinds of macerating solutions, such as alcohol, chromic

acid, and so on, into the lung through the thoracic wall of the rabbit with a hypodermic syringe, and after various intervals of time I killed the animals and impregnated the lungs. But no impregnation of the injected areas was obtained because of the inflammation and exudation which occurred there, precluding impregnation. Injection of macerating fluids into the trachea was also unsuccessful. I then tried injecting the lungs of the rats with 0.5 cc. of distilled water through the trachea and examined the impregnated lungs after various intervals of time. In some of the preparations areas were discovered in which no exudation had occurred and which showed certain variations in the respiratory epithelium. Besides the normal nucleated cells there occurred remarkably small and remarkably large nucleated cells, the latter being, in some cases, as large as the non-nucleated cells (fig. 18). Briefly, I discovered nucleated cells of various gradations of size. How can this best be explained? It seemed possible to interpret the small cells as the results of cell division, since they could not very well have become small as results of irritation due to injection of water, and often occurred in pairs. The presence of the nucleated cells which are larger than normal may be interpreted either as the results of swelling caused by slight irritation or as the result of change which the nucleated cells undergo in order to make up for the loss of non-nucleated cells. If the swelling be supposed to be the explanation, then the cells would have increased not only flat, but in all directions. I found, however, that the nucleated cells of various sizes seem to extend in one plane only, so that I am inclined to believe this increase in the size of the nucleated cells to be due to something else than mere swelling from injection of water; and it seems quite probable that the nucleated cells are able to change into large, flat cells. I would then suggest the following sequence of events. As a consequence of water injection of the lung, a slight inflammation takes place which leads to desquamation of the epithelial cells, after which the small nucleated cells change into large, flat ones in order to make up for the loss of the epithelial cells, especially flat non-nucleated ones, and at the same

time they multiply by cell division. To my regret, I could not confirm this by mitotic figures in the alveolar walls of the lungs which were injected with water and stained with ordinary dyes.

MUSCLE FIBERS

1. *Muscle fibers in Amphibia*

Diemyctylus pyrrhogaster. Müller demonstrated in the lung of Triton a muscle layer in which the whole lung was almost entirely enclosed. These muscle fibers are well developed in the Triton cristatus, but much less so in the Triton taeniatus. According to his statement, the fibers run circularly, crossing somewhat here and there and are located between the capillaries and weak connective tissue which cover the lung. Ooppel observed that the muscle layer of Triton alpestris consists of circularly arranged muscle cells which are often grouped. In *Diemyctylus pyrrhogaster* the muscle fibers are for the most part circular; occasionally longitudinal fibers are intermingled with them. The muscle fibers in *Diemyctylus* do not appear in groups, which is contrary to Ooppel's statement. They have interwoven with their substance elastic and collagenous fibers.

Rana nigromaculata. Concerning the lung of Rana, Gaupp has already made detailed statement, which is as follows: "The smooth muscle tissue, which represents essential foundation of the lung wall and septa, form finer and coarser bundles, which make a firm framework, connecting with each other. The strongest, thickest of these muscle bundles lie in the free, thickened edges of the chief septa, the muscle bundles in the septa of the secondary order are correspondingly thinner. From these principal bundles of the edges of the septa thinner fibers originate, which go down in the septa and connect with the finer muscle bundles of the outer lung wall." According to my finding in *Rana nigromaculata*, I can distinguish two systems of muscle fibers in the outer lung wall. One forms relatively strong bundles, the other consists some irregularly arranged fibers. In the septa the muscle fibers appear in bundles, and in no instance do they seem to appear singly. The muscle bundles in the edges

of the septum of the secondary order always have their origin in those of the first order, and similarly those of the third order are derived from the secondary. The manner of the interweaving of the muscle bundles in the free edges of the septa is similar to that of the tortoise, but, as it is not conspicuous here, it will be described later. In all other particulars my findings agree with Gaupp's descriptions.

Megalobatrachus japonicus. Before I proceed to a statement of muscle fibers, I will describe briefly the septa. The free edges of the primary septa are somewhat flattened and are perpendicular to the septa themselves, so that in transverse section they appear as T-shaped structures. The free edges of the secondary and tertiary septa are on the contrary not flat, but club-shaped (if seen in sections). The free edges of the secondary septa always arise from the inferior surface of the primary septa and take a concave course. The free edges of the tertiary septa pursue a similar course but arise from those of the secondary. The muscle fibers are well developed in the free edges, as in *Rana*. The muscle bundles of the free edges of the primary septa are strongest and flattened. Those of the other septa are less strong according to the order of their position.

The free edges of the septa come together from three or from as many as ten directions, sometimes even more. From this it will be seen that the muscle bundles must of necessity be interwoven with each other in a great number of ways. Several instances of this are given in the next diagram. Figures 19 and 20 show the muscle bundles of four free edges; figures 21 and 22, of eight free edges coming together at one point. The muscle bundle of any free edge passes in most cases to two different free edges. Figure 23 shows the muscle bundle of a free edge passing to the free edge of an adjacent septum, and particularly encircling the passage into the respiratory space.

The muscle bundles, which have their origin in the muscle tissue of the free edges, run in the septa and unite ultimately with those of the outer lung wall. The muscle fibers of the lung of *Megalobatrachus* generally form bundles. Though the muscle fibers of *Rana nigromaculata* form bundles, they also may be seen running singly or in groups of a few fibers.

2. Muscle fibers in Reptilia

Clemmys japonicus. The arrangement of the muscle fibers in the septum and the outer lung wall is the same as in *Rana* and *Megalobatrachus*; that is to say, the muscle bundles of various strengths interweave with each other, and among these the individual fibers may be seen. The free edges of septa come together from three or four directions. There are two ways in which the muscle fibers interweave in those portions where three free edges come together, as will be seen in figure 24. All three free edges exchange their muscle fibers as *a, b, c*, or only two adjacent edges exchange their fibers as *a-b, a-c*, in which no fibers connect *b* and *c*. In such a case *b* and *c* form usually a sharper angle. Where four free edges are merged, the muscle fibers are not only exchanged between adjacent, but also with those free edges directly opposite. Since the free edge in the tortoise is much thicker than that of *Rana*, the muscle fibers are of correspondingly greater strength in the former than in the latter. The muscle fibers of the free edges of the primary septa are not flat, such as in *Megalobatrachus*, but somewhat circular in section. This is true of the lower orders of septa as well.

Gecko japonicus. The muscle bundles in the free edges of the septa interweave each other just in the same manner as in the tortoise. The muscle bundles, which start from the free edges of septa and run therein, are weakest compared to the animals before mentioned. Observed in surface view, the bundles in the outer lung wall are also weak, but the fibers which are at right angles to the septa in the outer wall are somewhat stronger. They must be considered as incompletely developed septa because of their course and because they form small prominence on the wall.

Elaphe quadrivirgata. The muscle bundles in the edges of the primary septa are fairly well developed. Yet the bundles in septa themselves are not developed to a corresponding extent, sometimes even consisting of but a few fibers. From septa of the lower orders there are formed septa which run parallel to

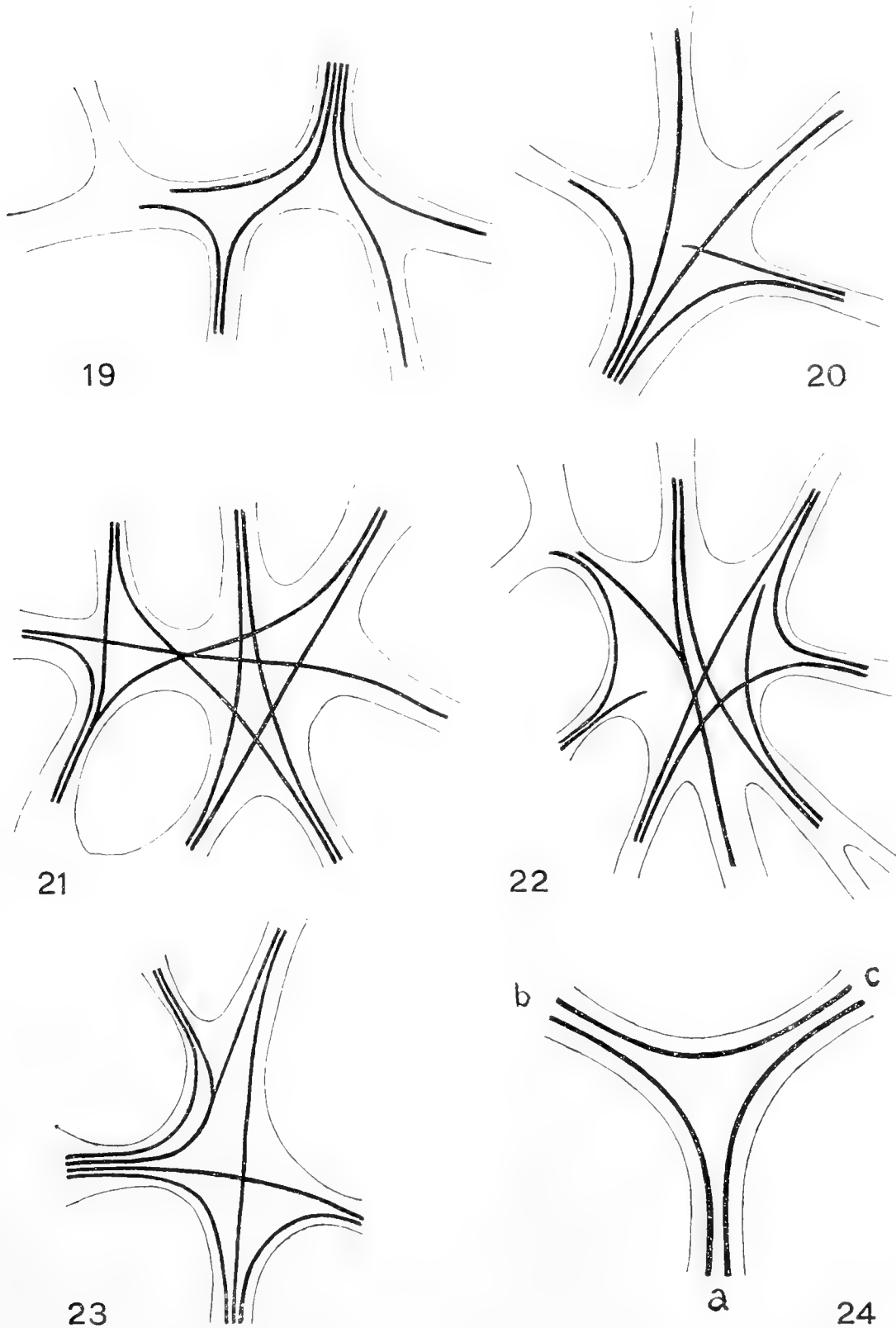

Figs. 19 to 23 Diagram of muscle bundles in free edges of septa in the lung of *Megalobatrachus japonicus*.

Fig. 24 Diagram of muscle bundles in free edges of septa in the lung of *Clemmys*.

the outer lung wall, accordingly in them the muscle fibers take the course parallel to the outer wall. In the outer lung wall I noticed weak muscle bundles similar to those in *Gecko*.

3. Muscle fibers in Aves

It is already known that muscle tissue is not found in the respiratory canaliculi, but they form circularly arranged muscle fibers in flute-holes. My investigations have not revealed any further differences. According to Piso-Borme's statement, birds capable of long flights have large numbers of muscle fibers around the flute-holes, but this statement seems to me rather unfounded.

4. Muscle fibers in Mammalia

Whether the muscle tissues are present in the alveolar system of mammalian lungs has been a much-debated question. But no conclusion has yet been drawn from a large literature. One reason for the lack of agreement in the reports of various observers is the difficulty in distinguishing the muscle tissue from the other tissue of the lung, especially from the other connective tissue. Where a number of muscle fibers constituting a bundle and having a regular arrangement are present, they are distinguished from the other tissues, but in instances where they are distributed singly in other tissues it is difficult to distinguish them by difference in staining. The form of nucleus of the muscle cell alone may be used as a criterion. Hirschmann says that the muscle cells can be distinguished by the form of the nucleus with certainty. Eberth holds that the form of the nucleus of the muscle cell cannot be used as a mark of distinction. I think both statements go to the extreme. If the form of the nucleus and the condition of its presence are taken into consideration, then it is not impossible to judge the existence of the muscle cells in other tissues. With the present microscopic technique we have no better way of determining their presence.

The thick sections are necessary for study of the alveolar system, but on the other hand the use of them makes it difficult to discover the muscle cells. Another reason for the disagree-

ment in the reports of investigation has been the tendency to generalize the results which were obtained in a few animals.

The materials were cut in sections $50\ \mu$ to $200\ \mu$. In the following animals, the mole, bat, rat, guinea-pig, which have smaller alveoli, thinner sections were used than in the cat, dog, and man, in which alveoli are larger. For staining I used besides van Gieson, hematoxylin-eosin, and Heidenhain's iron-hematoxylin.

The following description of the alveolar system is divided into three parts, viz., mouths of the alveolar ducts, mouths of the alveoli, and the alveolar walls.

(I mean by the term 'mouth of the alveolar ducts' not only the mouth of each system of alveolar ducts, but also the place of division of each branch of the duct into smaller branches.)

1. *Muscle fibers in the mouths of the alveolar ducts.* Stieda (in mammals) is of the opinion that the muscle fibers are missing in alveolar ducts. Schulze (in mammals) is of the contrary opinion, that the muscle fibers run circularly around the mouth of the first parts of the alveolar ducts. v. Ebner (in man) maintains that the muscle tissue is to be found in the mouths throughout the ducts. According to Prenant (in mammals), the muscle fibers disappear in the periphery of the alveolar ducts, while, according to Stöhr, they disappear in air sacs.

According to my findings, the presence or absence of the muscle tissues varies with the kind of animals. The muscle fibers are entirely absent in all parts of the alveolar ducts in the bat lung. But there are existent some circular arranged muscle fibers at the mouths of the alveolar ducts in the mole, rat, guinea-pig, rabbit, goat, cat, dog, and man (figs. 25 and 26). The muscle rings consist of bundles of fibers at the mouths of the main alveolar ducts and of less or sometimes of single fibers near the periphery. In the mole and guinea-pig, the muscle rings are sometimes absent at the mouths of the periphery of the ducts. As stated by Müller and confirmed by my study, the muscle rings in the mouths of the alveolar ducts of the cat lungs consist of bundles, fibers of which are well developed even in the mouth of periphery of the alveolar ducts. No remarkable difference can be seen in other animals.

2. *Muscle fibers in the alveolar mouths.* Kölliker and v. Ebner (in man), Sussdorf and Müller (in domestic mammals), demonstrated the muscle fibers in the alveolar mouths. These results were contrary to Schulze's description. I could not find any muscle fibers around the alveolar mouths in the lungs of (the bat), mole, rat, guinea-pig, rabbit, and goat, while in the lungs of the dog and man muscle fibers were demonstrated in some of the alveolar mouths and in the lung of the cat, the greater number of alveolar mouths showed fairly strong fibers. In the case of the cat, the muscle fibers, which depart from the muscle rings around the mouths of the alveolar ducts, run in the wall of the alveolar ducts in various directions and participate at the same time in formation of the muscle rings around the alveolar mouths. There are also present circular fibers which are confined to the mouths alone. In the lungs of the dog and man one may recognize only one or two muscle fibers around the alveolar mouths. Therefore, if there are only a few fibers around the mouths of the peripheral parts of the alveolar ducts, as well as around the alveolar mouths, it is hard to decide whether or not such fibers form closed rings.

3. *Muscle fibers in the alveolar walls.* Existence of the muscle fibers in alveolar walls has been confirmed by Piso-Borme (in several domestic mammals and man) and Müller (in sheep and oxen), but not by Kölliker and v. Ebner (in man) as well as by Schulze and Caradonna (in mammals). Though I could demonstrate occasional muscle fibers which originate from the muscle rings of the mouths of the alveolar ducts in alveolar walls of the lungs of the cat, dog (fig. 26), and man, I could find no such muscle fibers in the alveolar walls of the lungs of the other mammals before mentioned.

ELASTIC FIBERS

Though we have several detailed reports concerning the elastic fibers of the human lung, as yet no one seems to have undertaken an investigation of the whole vertebrate phylum for the purpose of comparison. The method used was observation of the lung wall and alveolar walls in surface view and in section. They were stained mainly in resorcin-fuchsin.



25



26

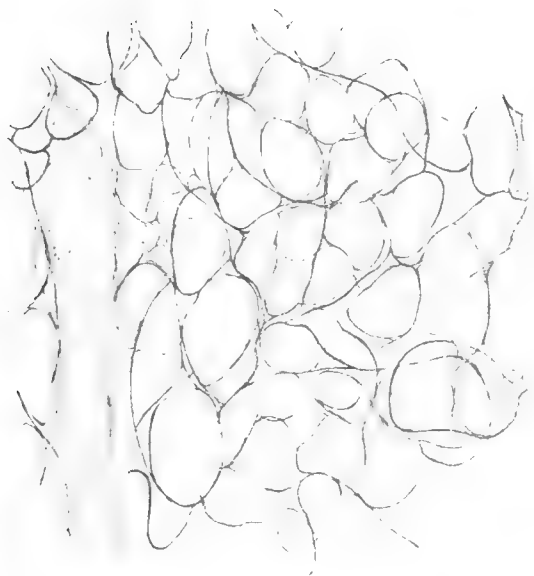

27

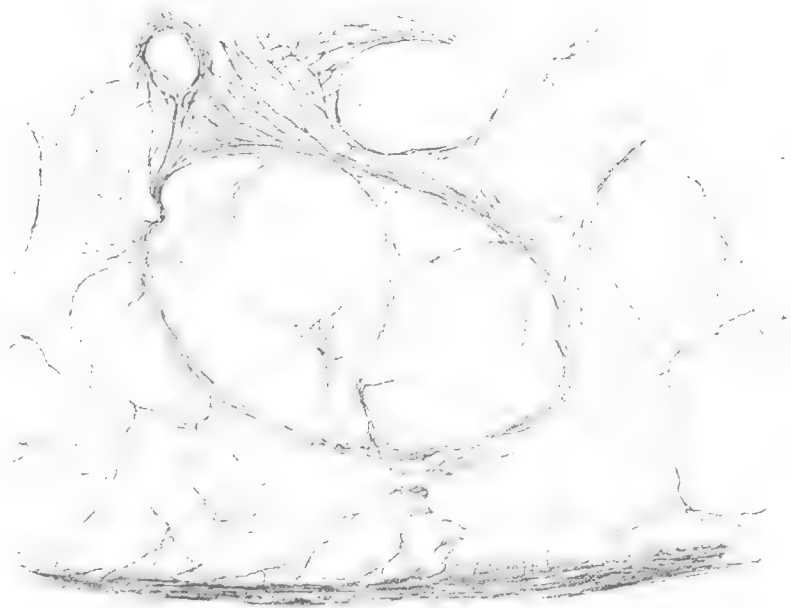

28

Fig. 25 Muscle fibers of the mouth of the alveolar duct. Mole. Hematoxylin-eosin. $\times 350$.

Fig. 26 Muscle fibers of the mouths of the alveolar ducts and alveoli. Dog. Hematoxylin-eosin. $\times 350$.

Fig. 27 Elastic fibers. The lung of the bat. Resorein-fuchsin. $\times 350$.

Fig. 28 Elastic fibers. The lung of the rat. Resorein-fuchsin. $\times 350$. Elliptic area in the center is the mouth of the alveolar duct.

1. *Elastic fibers in Amphibia*

Diemyctylus pyrrhogaster. The elastic fibers are fine and form thick nets in submucous layer of the lung wall. These fibers are seen in two layers: the inner, which is circular and rich in elastic fibers, the outer which is in the main longitudinal and less rich in fibers. In both layers the fibers are not wavy, but run straight, forming the nets by ramifications and anastomoses. The thickness of the net is uniform throughout the lung except for a slight increase in strands around the blood-vessels other than capillaries. According to Oppel, the elastic fibers are more strongly developed in the muscle bundles of the lung of Triton alpestris, while in the lung of Diemyctylus the muscle fibers do not present bundles and these fibers do not contain elastic tissue.

Oppel, moreover, states that in his Triton the outer layer (which he calls subserous) is stronger than the inner, while in Diemyctylus the reverse is the case.

Rana nigromaculata. The elastic fibers of this animal are seen in the connective tissue of the alveoli as well as the wall of the lung. Thus in the septa the fibers are situated between the two capillary nets. Here we see that, differing from Diemyctylus, elastic fibers take two distributions, one forms bundles which mix with muscle fibers, while the other has no relation to muscle tissue.

In general the elastic fibers in Rana form looser nets than in Diemyctylus. Since the muscle fibers in the free edges of the septa are well developed, the elastic fibers are also well developed, especially just around the muscle bundles. The interweaving nature of the fibers which accompany the muscle bundles is the same as described in the chapter dealing with muscle fibers.

Megalobatrachus japonicus. The elastic fibers seen in the connective tissue in the outer part of the lung are abundant and are coarser than in Diemyctylus. Although not as evident as in Diemyctylus, there are two layers, the outer consisting of longitudinal fibers, the inner of fibers of irregular course. In general the fibers differ from those in Diemyctylus by ramifying and anastomosing more frequently and resemble them by being present in muscle fibers.

In the septa the delicate elastic fibers run an irregular course. The elastic fibers in the muscle bundles of the free edges of the septa present the same picture as that described in *Rana nigromaculata*.

2. *Elastic fibers in Reptilia and Aves*

Clemmys japonicus. We can distinguish, according to arrangement, the same two layers of elastic fibers as in *Rana* and *Megalobatrachus*. The nets of fibers are slightly looser than those in *Diemyctylus*. In the muscle bundles in the edges of the septa the elastic fibers are especially abundant on the surface, contrasting to the looser structure in the muscle bundle.

Gecko japonicus. The elastic fibers in this animal are found only on the surfaces of the muscle bundles.

Elaphe quadrivirgata. The elastic fibers in the connective tissue in the outer wall of the lung are mainly longitudinal. Among these fibers are interspersed elastic strands which are somewhat coarser. We have also the fibers which accompany the muscle bundles. In the septa the elastic fibers are seen almost exclusively in relation to the muscle bundles. The fibers accompanying the muscle bundles are remarkably coarse, more so than in other localities in this animal, and even coarser than the fibers described in the preceding animals.

Aves. Eberth has not recognized any elastic fibers in the alveoli (respiratory canaliculi), while Schulze states their existence. The domestic fowl was studied and elastic fibers were not found in the respiratory canaliculi, but were seen accompanying the muscle bundles around the flute-holes. In the pigeon lung a parcel of elastic fibers is found in the part of the respiratory canaliculi nearest the flute holes.

3. *Elastic fibers in Mammalia*

For investigation of elastic tissue in mammalian material thick sections are essential. The conventional celloidin embedding method cannot be used because the dyes employed also stain the celloidin, giving a dark background. Thus frozen and

paraffin sections were used. The paraffin sections were not affixed, but treated the same as the frozen sections after the removal of the paraffin. The sections were cut to the same thickness mentioned in the chapter on muscle fibers.

A. Elastic fibers of adult mammals. Talpa (mole). In the mole there are few muscle fibers, these are paralleled by few elastic fibers. These fibers form rings which surround the mouths of the alveolar ducts. In the rings in some places the elastic fibers form a single sheaf, while in others they present a much looser appearance. The large mouths of the alveolar ducts are sometimes surrounded by rings consisting of several sheafs. In the mouth of periphery of the alveolar ducts the individual fibers in the rings are finer. The fiber rings send off fibers toward the alveolar mouths and the alveolar walls. In the first part of the alveolar ducts the branching fibers which run along in different directions the alveolar ducts are strong and participate in the formation of rings around the alveolar mouths, while we have also the fiber rings which confine the mouths alone. In parts other than this there are no branching fibers to strengthen the alveolar mouth rings which consist of one or more fibers. The fiber rings around the alveolar mouths in turn send out several fine fibers into the alveolar walls.

In this animal the intercapillary spaces are alveolar pores, thus the elastic fibers run along the capillaries. In their course, the fibers do not follow an individual capillary, but pursue as straight a path as the capillary area allows, which results in a slightly curved line. The fibers going into the alveolar walls anastomose with each other.

Vesperugo (bat). This animal resembles the mole in that the fiber rings are present around the mouth of ducts and alveoli, but differs in that the fibers are coarser and usually loosely united. As in the mole, there are fiber rings around the mouths of the alveolar ducts which also give off branches running along alveolar ducts and supplement the rings around the alveolar mouths.

In the bat, however, this condition is seen throughout the alveolar-duct system instead of being merely in the first part

of the ducts, as in the mole. Also in the bat the alveolar wall fibers are a little coarser than in the mole (fig. 27).

Epimys (rat). There are a great many more elastic fibers throughout the rat than in either the mole or bat. The fiber rings around the mouths of the alveolar ducts are very marked and consist of loose bundles composed of coarse and fine fibers. The fiber rings around the alveolar mouths also consist of many coarse fibers, which, when they cross each other, spread and interlace, forming a confused net (fig. 28).

This same picture was seen in the bat, although it was not evident enough to deserve description.

Cavia (guinea pig). No remarkable difference from the rat can be confirmed.

Lepus (rabbit). The fibers are remarkably rich and present the same arrangement around the mouths of the alveolar ducts and alveoli as in the preceding mammals, but the fibers in the alveolar walls differ slightly. Here we have often one or two thick fibers in addition to the fine fibers. These thick fibers pursue a course through the alveolar wall so that they unite with either the fiber ring where they started or an adjoining one. During this course the fibers have different appearances, namely, sometimes it divides itself in several less thick fibers, sometimes not, in either case it gives off finer fibers to the alveolar walls. The thick fibers show no wavy winding. At departure from the fiber ring the thick fiber is made by the union of many fine fibers, although seldom it begins at the ring in a single fiber.

Felis (cat). The arrangement and thickness of the fibers are about the same as in the rabbit. The elastic fibers in the alveolar walls often cross one another and sometimes there is a mutual exchange of fibers. In the above-mentioned mammals the elastic fibers of the blood-vessels give some fibers to the alveolar walls, but this process is especially evident in the lung of the cat, with the result that both coarse and fine fibers branch from the walls of the blood-vessels into the mouths of the alveolar ducts, as well as the alveoli, and into the adjacent alveolar walls.

Capra (goat). The difference from the cat seems to be that in this mammal the elastic fibers are a little richer.

Canis (dog). The dog differs from the above-described mammals in that the fibers form closer nets.

Homo (man). In man the elastic fibers are about as close as in the dog and they are full of coarse fibers. There is no principal difference between the arrangement of the elastic fibers in man and in the cat, dog, etc. We have detailed descriptions by Linser, Miller, and Orsòs. Linser states as follows: "Sometimes the alveoli are surrounded by a broad layer of elastic fibers, sometimes only by one or several fine fibers, and sometimes the fibrillary ground substance alone exists under the epithelium." According to my findings, there are always thick fibers passing through the alveolar walls in addition to the fine fibers. If Linser's statement, that "fibrillary ground substance alone exists under the epithelium," means the absence of elastic fibers in the alveolar walls, then our results disagree. Orsòs distinguished two systems in the elastic fibers of the alveolar walls, namely, the respiratory and the intercapillary, explaining as follows: "The former system branches from the elastic fiber rings of the alveolar mouths, spreads in the alveolar walls, and consists of strong fibers. The latter starts from the longitudinal elastic fibers of the larger blood-vessels, especially the arteries, and goes to the alveolar wall. Its course is partly along the ramifying vessels and partly independent, and forms fine fiber nets close to the capillaries. Both systems are different in origin, structure, and function." My work confirms the branching of fibers from the mouths of the alveolar ducts and the blood-vessel walls, but I cannot confirm his statement that the fibers from the mouths of the alveolar ducts are thick and that the fibers from the blood-vessels are fine. Besides it is difficult to distinguish two distinct systems, since greater numbers of the alveoli are not in contact with larger blood-vessels, so that the elastic fibers of these alveoli are branches of the fiber rings of the mouths of the alveolar ducts and alveoli.

B. Elastic fibers of embryonic and new-born mammals. In this study the rabbit, dog, and man were observed. Linser believes that the elastic fibers in the lung of the human embryo, thereby supposing the same condition in other mammals, are in an

undeveloped state as shown by their weak staining and that immediately after parturition they become developed. Ottolenghi says that the degree of staining of the elastic fibers is of value in forensic medicine. He finds that the fibers in the lung of a still-born fetus, which died after a few breaths of air showed much darker staining than those of a fetus before parturition. He concluded that this sudden change in staining was due to the contact of the elastic fibers with air.

I recognize also that the elastic fibers in the embryonic lung are stained weakly, but in addition it was observed that the elastic fiber rings of the alveolar ducts and alveoli were stained somewhat deeper than the fibers of the alveolar walls. Also it is seen that the elastic fibers in the respiratory spaces of the embryonic lung are in general not stretched and present a winding course, while if such lungs were expanded by a fixing solution, the elastic fibers are stretched as in the adult lung. In my comparison of the degree of staining of the elastic fibers of the mature embryo and the new-born, I was unable to confirm the differences described by Ottolenghi.

RETICULAR FIBERS

The reticular fibers have been studied rather by workers in pathology and somewhat neglected by histologists, though Mall has given detailed statements about them. This is true especially in the lung, notwithstanding the great importance of these fibers as the supporting tissue. No research seems to have been made in other vertebrates than the human, where Russakoff has studied these fibers in the lung.

The Bielschowsky method was used in the investigation. Both formol and formol alcohol were used in fixing, and the latter was found as effective as the former. The tannin-silver method was tried, but the results were poor, owing to some undetermined cause.

In *Diemyctylus* the lung was cut open and spread out, in the other *Amphibia* the septa were removed with scissors, these unsectioned specimens were stained, but with no success. This

led to cutting paraffin sections $10\ \mu$ thick and staining. It was impossible because of the structure of the lung to use frozen sections in Amphibia and Reptilia, except the snake. The sections in the mammalian lungs required a thickness of $40\ \mu$ to $50\ \mu$ for observation of these fibers, even in this thickness the results were satisfactory because of the inherent or natural thinness of the alveolar walls. Frozen sections were used in these thick mammalian specimens. Russakoff states that the elastic fibers are also stained by this method, resulting in a confused picture. I found that in my case no elastic fibers were stained, and in general these are easily distinguished by their morphological characteristics.

1. Reticular fibers in Amphibia, Reptilia, and Aves

Diemyctylus. Many attempts to get sufficient impregnation were made, but the results allow only the following observations. The surface view shows fine, somewhat parallel reticular fibers around the subepithelial blood-capillaries. The fibers are wavy in general, but sometimes are straight. It may be that these fibers are rather more characteristic of the capillaries than the lung itself. The stroma shows no reticular fibers, at least by Bielschowsky's method.

Rana nigromaculata, *Megalobatrachus japonicus*. No results were obtained.

Clemmys japonicus. Fine reticular fibers are seen around the blood-capillaries. Also there are extremely fine fibers which form anastomosing rings around the muscle fibers and fiber bundles. The reticular fibers are not visible in the collagenous ground substance.

Gecko japonicus. The technique proved so effective in this animal that a detailed description is possible. Two systems of reticular fibers are seen, the ones around the blood-capillaries and the others in the subepithelial connective tissue. The fibers appear to twine themselves closely around the capillaries and are marked by an especial fineness, these pursue a circular course and are not wavy (fig. 29). In the space of $10\ \mu$ there are from

seven to ten fibers. It was concluded that these fibers extend all the way around the capillary, although this conclusion could not be absolutely verified because the stroma stained very deeply. These fibers very seldom anastomose with each other. These same fibers are seen also in the larger capillaries and appear to form a continuous system in the lung. The fibers in the subepithelial connective tissue are somewhat thick and spread out flatly (fig. 30). Although a careful search was made, no fibers could be seen passing over capillaries, also no circular fibers were seen around the muscle fibers, as in the tortoise.

Elaphe quadrivirgata. An appearance similar to that in Gecko was seen, except that the subepithelial fibers are somewhat finer.

Aves. The domestic fowl and duck were used in this study. There are bundles of reticular fibers, slightly wavy, around the flute-holes. In the respiratory canaliculi the reticular fibers are exceedingly fine and twine themselves around the capillaries, but they do not encircle the capillaries as they do in the gecko and snake (fig. 31).

2. Reticular fibers in Mammalia

A. Reticular fibers of the adult mammals. The reticular fibers in the adult mammals are in general similar in arrangement to the elastic fibers.

Talpa (mole), Vesperugo (bat). The reticular fibers of the walls of the bronchioli continue into the walls of the alveolar ducts where they encircle the mouths of the alveoli (fig. 32). The fibers also form rings around the mouths of the alveolar ducts. A majority of these rings are composed of a single fiber, but some are made up of several fibers. These rings in turn send fibers into the walls of the alveolar ducts where they form rings around the alveolar mouths. The alveolar mouths in the first part of the alveolar ducts sometimes consist of several fibers, but further down the ducts the mouths have only a single fiber in the ring. In both the mouths of the alveolar ducts and the alveoli the fibers of the rings show a regular wavy or spiral winding. The fibers of two adjacent rings around alveolar duct

mouths or larger alveolar mouths do not join, but the rings of other adjacent alveolar mouths join together. The fiber rings of the alveolar mouths give off fine fibers to the alveolar walls. These fibers travel along the capillaries, ramifying, anastomosing, and forming loose nets. The reticular fibers of the blood-vessels and pleura give off fibers which anastomose with the fibers in the alveolar ducts and alveoli.

Epimys (rat). The arrangement of the fibers in the lung of this animal is similar to that in *Talpa* and *Vesperugo*. The fibers, however, are a little coarser (fig. 33). As in the previous animals, each fiber ring around the mouths of the alveolar ducts and alveoli consists of one fiber, but in this case the fiber sometimes splits and rejoins itself. Since the fiber rings of adjacent alveolar mouths are confluent in their common edge, triangular areas are sometimes formed between alveolar mouths. In this formation the rings send off finer ramifications to each other so that the rings here anastomose together. The fiber rings of the alveolar mouths again send off branches into the alveolar walls. The branches either leave the ring perpendicularly or in an oblique direction. It will be remembered that at the departure of elastic fibers from the ring there were several fibers which became confluent in a common fiber trunk, but the reticular fiber rings give off individual fibers. These vary in size; they are sometimes as thick as the fiber ring, sometimes branch immediately at departure, and sometimes they are exceedingly fine. In the alveolar walls the course of the fibers is more irregular than in the rings, and the fibers form close ramifications and many anastomoses.

Cavia (guinea-pig). The reticular fibers in this animal appear to be coarser than those in the rat. The rings around the mouths of the alveolar ducts and alveoli consist of several fibers, or, in other words, they have many splittings. When a fiber branches from the ring, it occasionally starts as several fibers which later form a thick fiber. As in the rat, the branches going into the alveolar wall are of various thicknesses, but here well-marked thick fibers are formed which give off fine branches and which extend to the opposite side of the ring or reach into the adjacent

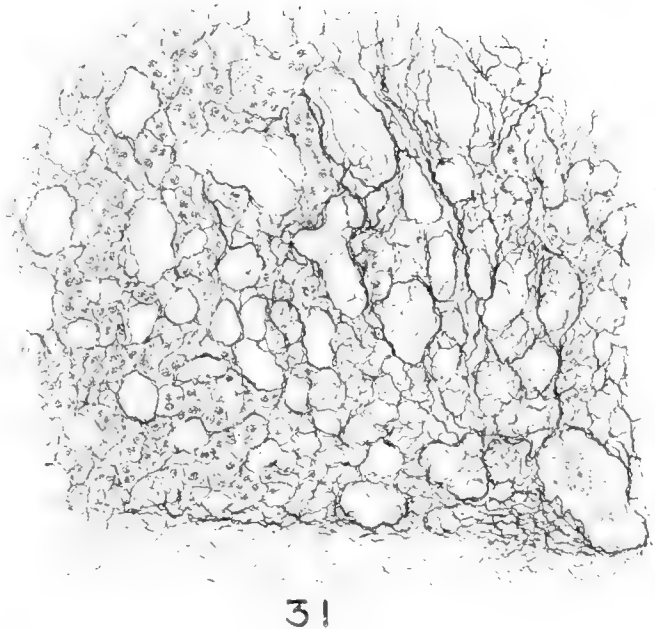
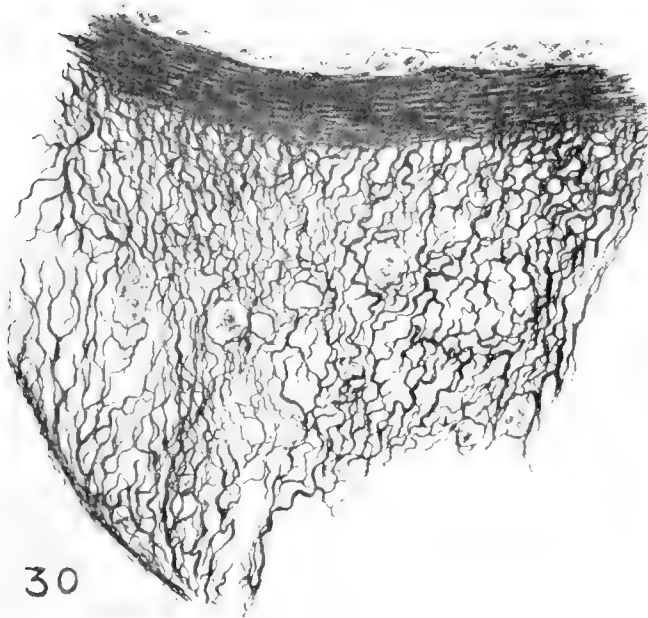
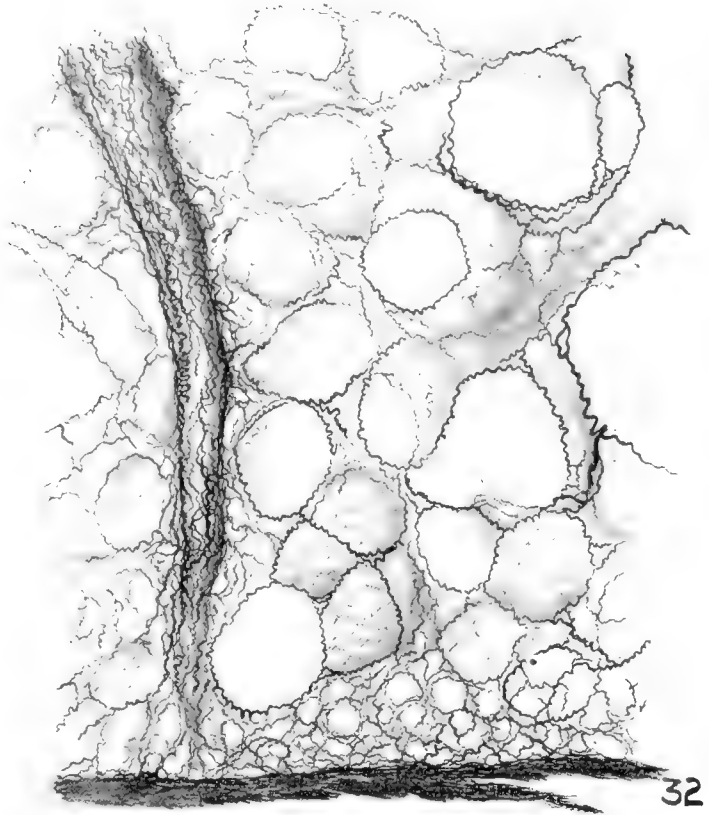
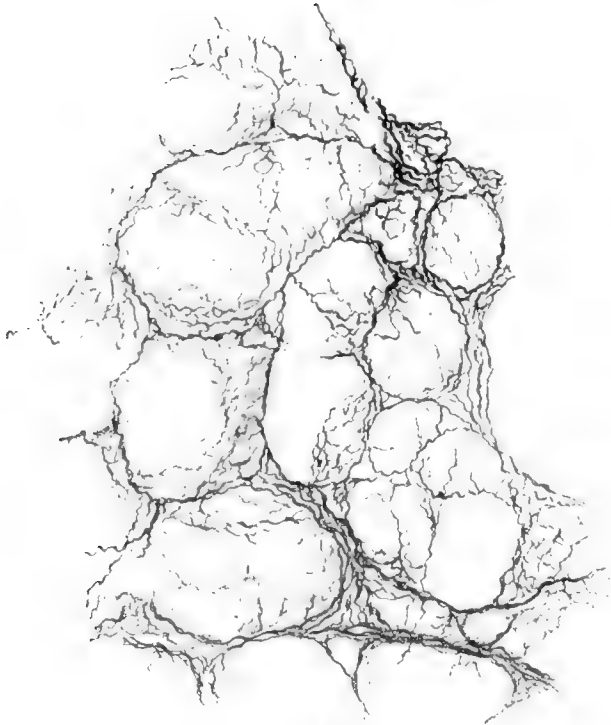

Fig. 29 Reticular fibers around the blood-capillary. The lung of Gecko. Tangential section. Bielschowsky's staining. $\times 350$.

Fig. 30 Subepithelial reticular fibers. The lung of Gecko. Tangential section. Bielschowsky's staining. $\times 350$.

Fig. 31 Reticular fibers in respiratory canaliculi. The lung of the domestic fowl. Bielschowsky's staining. $\times 350$.

Fig. 32 Reticular fibers. The lung of the mole. Bielschowsky's staining. $\times 300$.



33

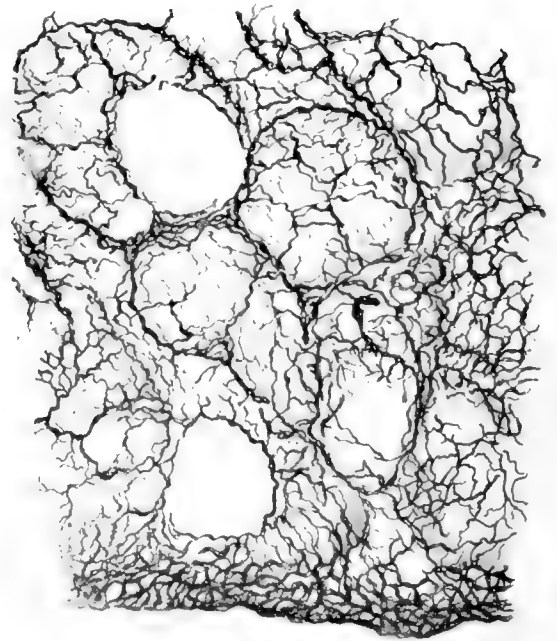

34

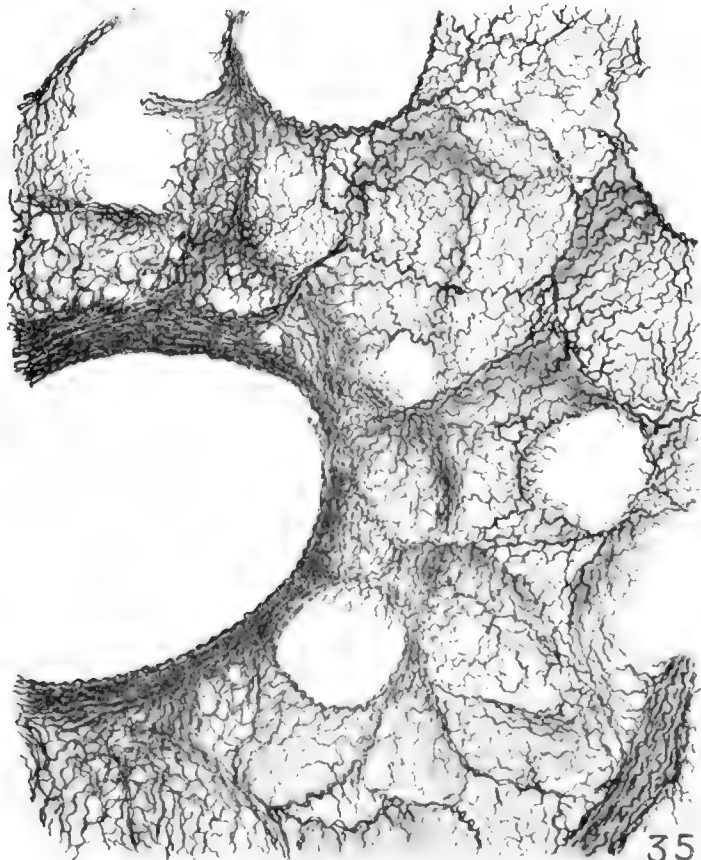

35

alveolar walls. The fibers in the alveolar wall do not always run on the same side, but sometimes pass through the intercapillary spaces and appear in the opposite side of the wall. (In the mole, bat, and rat the fibers might also pass through the intercapillary spaces, but this could not be confirmed because of the insufficiently impregnated specimens.) The finest reticular fibers in the alveolar walls are so fine that the oil immersion is necessary.

Lepus (rabbit). The situation here is similar to that in the guinea-pig, except that the fiber rings are coarser and the fiber nets in the alveolar nets are closer (fig. 34).

Felis (cat) and Canis (dog). The nets of reticular fibers are in general very dense and the fiber rings of the mouths of the alveolar ducts and alveoli are exceedingly thick (fig. 35). The arrangement of the fibers is the same as in the above-described animals. The specimens obtained showed the fibers in relation to the capillaries very clearly. The reticular fibers in the alveolar walls pass over the capillaries superficially, but may sink slightly into the alveolar spaces. The thick fibers either pass over the capillaries unchanged or form then several fine fibers; this will be described under the reticular fibers in man. The fibers in the intercapillary spaces sometimes run very close along the contour of the capillaries, in which case they sometimes form closed rings, and sometimes they are slightly apart from the capillary and pursue a course parallel to them (fig. 36). This condition is probably the same in the guinea-pig and rabbit, although I was unable to show it.

Homo (man). There is no significant difference in fibers between man and the cat or dog (fig. 37). Russakoff, however, points out that the reticular fibers of the alveolar walls of the human lungs seldom pass over the blood-capillaries. Contrary

Fig. 33 Reticular fibers. The lung of the rat. Bielschowsky's staining. $\times 150$.

Fig. 34 Reticular fibers. The lung of the rabbit. Bielschowsky's staining. $\times 150$.

Fig. 35 Reticular fibers. The lung of the dog. Bielschowsky's staining. $\times 150$.

to this, I find that the fibers often pass over the capillaries. Besides the fiber system which I have mentioned in the preceding animals, there is, according to Russakoff, a fine circular fiber system around the alveolar capillaries. I recognize the same circular fibers in the lungs of Amphibia and Reptilia, but I find in Mammalia and the human there is a different condition. Here, when the somewhat thick fibers pass from one intercapillary space to another, the fiber divides sometimes into fine fibers which either continue as such into the other intercapillary space or are again gathered into a single thick fiber (fig. 36). In this branching, the fibers may pass over one side of the capillary only or they may split and pass over both sides, but in all cases their course is one approximately at right angles to the axis of the capillary. In short, the fibers of the capillaries are connected with the fibers in the intercapillary spaces and thus belong to the same system. Perhaps Russakoff saw only these fine fibers in relation to the capillaries and concluded that they formed a separate system. I was unable to detect the fine reticular fibers on the capillaries in the lungs of the mole and bat, but in the rat these were indicated, although the technique did not allow confirmation.

B. The reticular fibers of the embryonic mammals. Russakoff observed in the 32-cm. new-born that the reticular fibers arise from cells in the alveolar walls, pursue a slightly tortuous course, and anastomose with each other. He also states that these fibers are in connection with fine fibers which form close nets beneath the epithelial cells. I was unable to see any special nets of subepithelial fibers in different stages of the rabbit embryo. In addition it was seen that in the embryo the fibers in the alveolar walls are less coarse, less tortuous, and form looser nets than in the adult (fig. 38). In the embryo, as in adult animals, the fiber rings of the alveolar ducts and alveoli are thicker than those of the alveolar walls.

The degree of staining of the reticular fibers does not vary with age as it does in the case of elastic fibers.

C. The relation between elastic fibers, reticular fibers, and muscle fibers in regard to position. Russakoff describes the relation

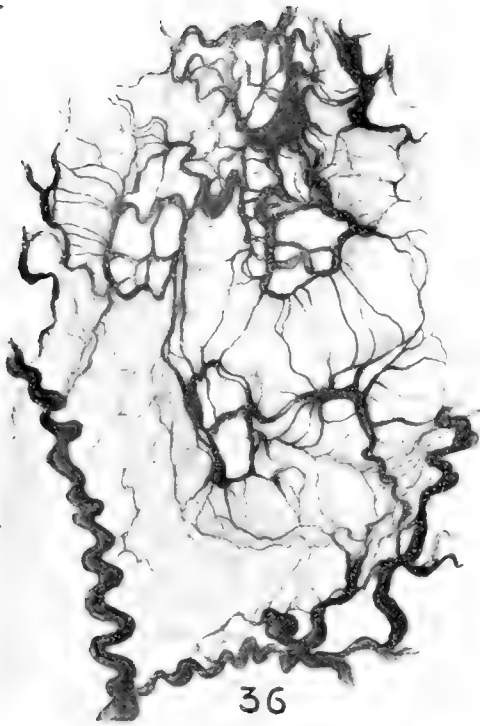

36

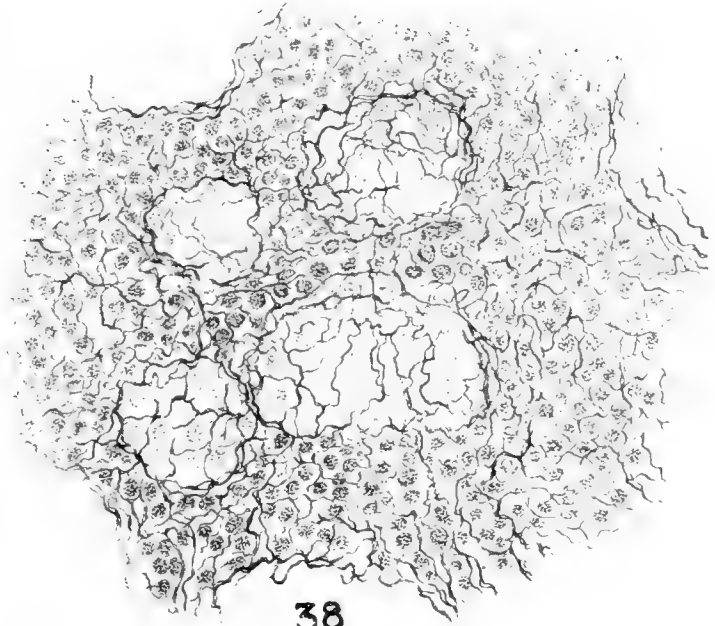

38

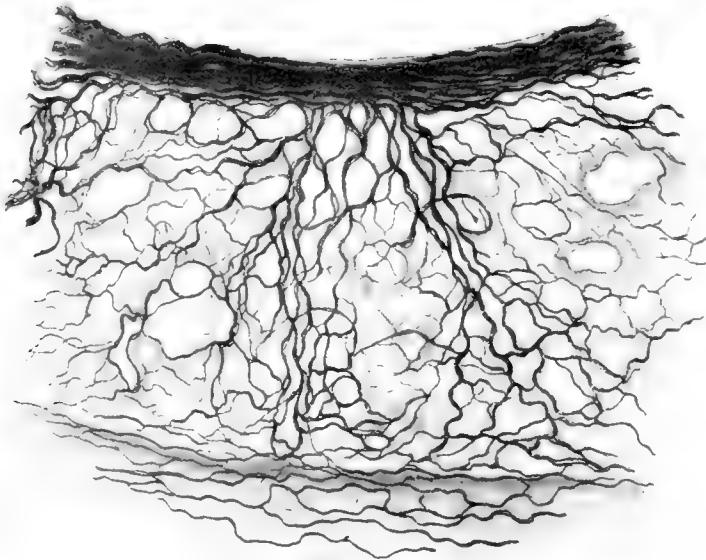

37

Fig. 36 Reticular fibers. The lung of the dog. Bielschowsky's staining. $\times 1000$. Reticular fibers on the capillaries and in the intercapillary spaces are shown.

Fig. 37 Reticular fibers. Human lung. Bielschowsky's staining. $\times 350$.

Fig. 38 Reticular fibers. The lung of the rabbit embryo. Bielschowsky's staining. $\times 350$.

between these three kinds of fibers in a five to six-month child as follows: "The reticular fibers in the mouths of the alveolar ducts and alveoli enclose the elastic fibers spirally and hold them tightly together. The elastic fibers in turn almost always accompany the muscle fibers. Several of the spiral reticular fibers accompany the elastic fibers which extend from the elastic rings of the alveolar ducts into the alveolar walls."

Now, sections from the above-mentioned animals were stained first by Bielschowsky's method and then for only a few minutes with resorcin-fuchsin, because this stain is deleterious to the silver precipitation. It was found that although the reticular fibers always accompany the elastic fibers at the mouths of the alveolar ducts and alveoli, there was a relation contrary to that described by Russakoff. The spiral reticular fibers are included within a sheath of elastic fibers and where there are few elastic fibers they enclose only the side of the reticular fibers nearest the lumen.

The thicker elastic fibers and the thicker reticular fibers which branch from the fiber rings into the alveolar wall always accompany one another, with the elastic fibers constantly superficial to the reticular fibers. This does not hold true for the finer branches.

Russakoff states that elastic fibers always accompany muscle fibers, but he does not describe them in detail. I investigated the preparations in which elastic fibers and nuclei of muscle fibers were stained, and found that the elastic fibers are likewise situated superficial to the muscle fibers.

The remainder of the article is devoted to the relation of reticular and muscle fibers. In Bielschowsky's method the reticular fibers are stained so deeply that the nuclei of the muscle fibers are concealed in the mouths of the alveolar ducts and alveoli. By van Gieson's picrofuchsin method both the nuclei and fiber rings are seen, although the fine reticular fibers are not stained. It is clear by this method that the nuclei of the muscle cells are usually located more deeply than the reticular fibers and sometimes they are situated side by side.

In the first part of the alveolar ducts in the lungs of the human, dog, cat, etc., the fiber rings are rich in the three kinds of fibers and they do not constantly adhere to the described relationship. In the alveolar walls of mammals the muscle fibers are usually absent, while the thicker elastic and reticular fibers accompany one another. The muscle fibers are even absent in the mouths of the alveolar ducts and alveoli in such animals as the mole and guinea-pig, while the bat has no musculature at all in the respiratory spaces. In short, it is seen in mammals that the thicker elastic and reticular fibers always accompany one another, but muscle fibers are not necessarily present.

MEMBRANA PROPRIA AND ALVEOLAR PORES

The elastic and reticular fibers are the principal tissues in the structure of the alveolar walls of mammalian lungs. These fibers are enclosed by a thin membrane which is called *membrana propria*. This membrane is usually considered as structureless, but Schulze and others state that it is slightly striped. Sussdorf and Müller believe that *membrana propria* (which they call alveolar membrane) is an elastic membrane. All of the proofs of this point given by Müller hold more true for the elastic fibers in the transverse section of the alveolar wall; he may have mistaken these fibers for an elastic membrane. I agree that the *membrana propria* is structureless. The striping seen by Schulze was probably caused by the presence of the fibers enclosed in the membrane.

It has already been mentioned that there is almost no membrane in the intercapillary spaces in the lungs of the mole and bat, but deducing from the fact that various fibers run along the capillaries, there must be a membrane to enclose these fibers, although it is impossible to inspect it directly because of its exceeding thinness.

The subject of alveolar pores has been one of much discussion. Up to the present it has not been decided whether or not alveolar pores are present in the alveolar walls of normal mammalian lungs. The detailed literature on this problem may be found

in Schulze, Marchand, Müller, etc., so that I will merely classify it as follows:

1. The so-called alveolar pores are artefacts.
2. The alveolar pores are not existent in young animals.
3. The alveolar pores are existent both in young animals and in adults.

In the microscopic investigation of alveolar pores it is only necessary to have thick sections in which alveolar walls are darkly stained. Thus the sections studied were selected from preparations with ordinary stain, with Bielschowsky stain, or with silver impregnation.

As it was referred to in the work of Schulze and Marchand, we observed that the intercapillary spaces in the alveolar walls of the lungs of the mole and bat lacked membranes. These spaces form pores. I agree with Marchand that there are seldom membranes in the intercapillary spaces. These membranes, when found, are perforated by several pores around which cells approximate closely. It was mentioned above that the intercapillary spaces in the alveolar walls in the lung of the young mole were not perforated, but were covered with epithelial cells; from this I conclude that the frequent alveolar pores in the adult mole lung appear as the animal grows. Materials were taken, moreover, from the rat, guinea-pig, rabbit, cat, dog, and human. They showed in the greater part of the specimens the existence of smooth-edged alveolar pores. The number and the size of the pores varied even in the same animal, sometimes only several pores could be seen in a section and sometimes every alveolus showed some pores. Miller's argument that the alveolar pores are artefacts seems to stand on an erroneous foundation. According to v. Ebner, it is difficult to decide whether or not the pores are artefacts. I am able to perceive in the surface view of the alveolar walls that there are breaches resulting from the treatment in preparation. These pores can be distinguished from the true alveolar pores because the latter differ markedly in being smooth-edged and round or elliptically shaped. By the regularity of shape it is impossible to deem them artefacts. In adult animals a few isolated cases showed no

alveolar pores, it is not known whether this result was due either to actual lack of pores because of individual discrepancy or to the fact that only a few pores were present and not shown in the sections studied. It was difficult to determine quantitatively the relation between age and alveolar pores because the exact ages of the investigated animals were not known.

In conclusion, the relation of elastic and reticular fibers to the alveolar pores will be considered. These fibers around the alveolar pores are sometimes present and sometimes absent; when present, the fibers either wholly or partially enclose the pore, and these fibers are sometimes relatively thick and sometimes thin. Linser's statement that there are mostly elastic fibers around the alveolar pores was not confirmed.

SUMMARY

1. The respiratory epithelium in Amphibia is of one kind and consists of flat and nucleated portions, while in Reptilia the epithelium consists of two kinds of cells, namely, large, flat cells and small cells, both being nucleated. Thus the respiratory epithelium of Reptilia takes the middle form of those of Amphibia and Mammalia.

2. The arrangement of the respiratory epithelium of *Elaphe quadrivirgata* (snake) is different in parts of the lung. The intercapillary spaces near the caudal sac-like portion and of the parts on both sides of the median line of the dorsal aspect are covered by groups of numerous small cells, while in most part the small cells are isolated or form groups of a few cells.

The small cells of respiratory epithelium of Gecko often present, singly or in groups, crescent or horseshoe form and are located eccentrically in the intercapillary spaces against the capillaries.

3. The respiratory epithelium seems to be absent in birds. It is also the case in the mole and bat. However the intercapillary spaces of the lung of the young mole and those of a part of alveolar bases, which are in contact with the pleura, in the lung of the adult mole are covered by nucleated cells.

4. Lange's experimental work concerning respiratory epithelium has some fundamental mistakes.

5. The non-nucleated cells of mammalian respiratory epithelium cannot be considered as parts of the nucleated cells, though some authors are inclined to believe so.

6. The respiratory epithelium of the rabbit embryo in early stages consists of a single kind of cuboidal cell, and as development proceeds and comes nearer to the final stage, some of them become flatter. In the final stage the respiratory epithelium of all the alveoli consists of a mixture of the two kinds of cells without respiration. The flat cells become flatter at the beginning of respiration. Disappearance of the nuclei of flat cells takes place in the final embryonic stages and occurs, not suddenly, but gradually by processes of pyknosis, karyorrhexis, etc. The greater part of the nuclei probably has disappeared before parturition.

7. Reparation and regeneration of non-nucleated flat cells seem to be brought about by extension of small nucleated cells and disappearance of nuclei.

8. The muscle fibers of the lung appear isolated in *Diemyctylus japonicus* and grouped in *Megalobatrachus japonicus*, while in *Rana nigromaculata* and *Clemmys japonicus* there are both kinds of appearance. The muscle fibers of *Elaphe quadrivirgata* and *Gecko japonicus* form mostly bundles.

9. The muscle fibers are entirely absent in all parts of the alveolar ducts in the bat lung. There are existent some circularly arranged muscle fibers at the mouths of the alveolar ducts in the mole, rat, guinea-pig, rabbit, goat, cat, dog, and man. In the mole and guinea-pig the muscle rings are sometimes absent at the mouths of the periphery of the ducts. There are no muscle fibers around the alveolar mouths in the lungs of the mole, rat, rabbit, and goat, while in the lungs of the dog and man muscle fibers are demonstrated in some of the alveolar mouths and in the lung of the cat the greater number of alveolar mouths show fairly strong fibers. Muscle fibers in the alveolar walls are very seldom demonstrated in the cat, dog, and man, but they are not found in the other mammals before mentioned.

10. The elastic fibers of the mole and bat form a weak ring around the mouths of the alveolar ducts and alveoli. From

these fiber rings a few fibers are sent off to the alveolar walls. In the bat the fiber rings around the alveolar mouths are supplemented also by the fibers which branch off from the mouths of the alveolar ducts and run along the alveolar ducts. In the lung of the bat and guinea-pig the elastic fiber rings consist of loose bundles of several fibers and the fibers in the alveolar walls become rich. The elastic fibers in the rabbit lung are richer and the thick main fibers appear in the alveolar walls. In the goat, cat, dog, and man the fibers increase in closeness. Findings by Linser and Orsòs concerning the elastic fibers in the human lung are sometimes contrary to mine.

11. Reticular fibers in the lung of Gecko and *Elaphe* are divided into two systems, the fine circular fibers around the blood-capillaries and flatly spreading fibers in the subepithelial connective tissue. In the respiratory canaliculi of the domestic fowl and duck the reticular fibers twine themselves around the capillaries.

12. In the lung of the mole and bat a majority of the reticular fiber rings around the alveolar ducts and alveoli are composed of a single fiber. From the fiber rings of the alveolar mouths several fine fibers are given off to the alveolar walls. In the rat and guinea-pig the fibers are coarser and closer; the fiber rings consist of several fibers. In the guinea-pig the thick main fibers appear in the alveolar walls. In the rabbit, cat, dog, and man the fibers are very close. Circular fibers around the blood-capillaries cannot be confirmed. Reticular fibers of the embryo (ripe rabbit embryo) are a little finer, less tortuous, and form looser nets.

13. The elastic fibers of the mouths of the alveolar ducts and alveoli are always located superficially to the reticular fibers and muscle fibers.

14. *Membrana propria* of the alveolar walls is not elastic membrane.

15. The alveolar pores are normally found in many mammals and only seldom cannot be seen.

BIBLIOGRAPHY

- BÄR 1896 Beiträge zur Kenntnis der Anatomie und Physiologie der Athmungs-
werkzeuge bei den Vögeln. Zeitschr. für. wiss. Zoolog., Bd. 61.
- CARADONNA 1913 Sur la présence de communications dans la paroi des alvéoles
pulmonaires et sur quelques points d'histologie comparée du poumon
des animaux domestique. Arch. ital. d. biol., T. 60.
- EBERTH 1863 Ueber den feineren Bau der Lunge. Zeitschr. f. wiss. Zoolog.,
Bd. 12.
- EBNER 1902 Kölliker's Handbuch der Gewebelehre des Menschen. Bd. 3, 6.
Auf.
- ELENZ 1864 Ueber das Lungenepithel. Würzburg. naturwiss. Zeitschr., Bd.
5 (according to Oppel).
- GAUPP 1901 Anatomie des Frosches.
- HIRSCHMANN 1866 Zur Lehre über den feineren Bau des Lungenparenchyms
bei Säugetieren. Arch. f. patholog. Anat. u. Physiol., Bd. 36.
- JALAN DE LA CROIX 1863 Zur Entwicklung des Lungenepithels. Arch. f.
mikr. Anat., Bd. 22.
- JUILLET 1911 Phases avancées du développement du poumon chez le poulet.
Compt. rend. soc. biol., Paris, T. 70.
- KÖLLIKER 1881 Zur Kenntnis des Baues der Lunge des Menschen. Ver-
handl. der physik.-medizin. Gesellsch. zu Würzburg, Neue Folge,
Bd. 16.
- KÖNIGSTEIN 1903 Die Funktion der Muskulatur der Amphibienlunge. 1.
Anat. Teil. Arch. f. d. ges. Physiol., Bd. 95.
- KÜTTNER 1876 Studien über das Lungenepithel. Virch. Arch., Bd. 66.
- LANGER 1909 Untersuchungen über das Epithel der Lungenalveolen. Frankf.
Zeitsch. f. Pathol., Bd. 3.
- LINSER 1900 Ueber den Bau und die Entwicklung des elastischen Gewebes in
der Lunge. Anat. Hefte, Bd. 13.
- MALL 1896 Reticulated tissue and its relation to the connective-tissue fibrils.
Johns Hopkins Hospital Reports, vol. 1.
- MARCHAND 1912 Les Pores interalvéolaires du poumon chez l'homme et chez
quelques Animaux. Thèse.
- MATSUI 1915 Ueber die Gitterfasern der Milz unter normalen und patho-
logischen Verhältnissen Beitr. z. path. Anat. u. Allgem. Pathol.,
Bd. 60.
- MERKEL 1902 Athmungsorgane in Bardeleben's Handbuch der Anatomie des
Menschen.
- MILLER 1913 The airspaces in the lung of the cat. Jour. Morph., vol. 24.
1906 The arrangement of the elastic fibers in the bronchi and lung.
Journ. of Anat. and Physiol., vol. 40.
- MINOT 1894 Lehrbuch der Entwicklungsgeschichte. (Uebersetzt von Kaest-
ner.)
- MOSER 1902 Beiträge zur vergleichenden Entwicklungsgeschichte der Wir-
beltierlunge. Arch. f. mikr. Anat., Bd. 60.
- MÜLLER 1907 Zur vergleichenden Histologie der Lungen unserer Haussäuge-
tiere. Arch. f. mikr. Anat., Bd. 69.

- MÜLLER 1861 Ueber Muskeln in den Lungen von Triton. Würzb. naturwiss. Zeitschr., Bd. 2 (Oppel, Lehrbuch).
- NICOLAS 1898 Appareil respiratoire in Poirier's *Traité d' Anatomie humaine*, T. 4.
- OPPEL 1905 Lehrbuch der vergleichenden mikroskopischen Anatomie, Bd. 4.
- ORSÓS 1906 Ueber das elastische Gerüst der normalen und der emphysematösen Lunge. Beitr. zur pathol. Anat., Bd. 41.
- OSAWA 1911 Epithelium of the respiratory organ and epithelial tissue in general. *Nisshin Igaku* (Japanese), vol. 2.
1907 Beiträge zur Lehre von den Eingeweidenorganen des japanischen Riesensalamanders. *Mitteil. d. medicin. Fakultät der kaiserl.-Japan. Universität zu Tokyo*, Bd. 8.
- OTTOLENGHI 1903 Die elastischen Fasern in der fötalen Lunge und in der Lunge des Neugeborenen. *Vierteljahrsschr. f. gerichtl. Medicin*, Bd. 26.
- PISO-BORME 1867 Anatom.-physiolog. Studien über die Gegenwart glatter Muskelfasern in den Lungenbläschen der Wirbeltiere. *Moleschott's Unters. z. Naturlehre*, Bd. 10 (according to Oppel).
- PRENENT ET BOUIN 1911 *Traité d'Histologie*.
- RUSSAKOFF 1909 Ueber die Gitterfasern der Lunge unter normalen und pathologischen Verhältnissen. *Beitr. z. pathol. Anat. und allgem. Pathol.*, Bd. 45.
- SCHULZE 1871 Die Lungen in Stricker's Handbuch der Lehre von den Geweben.
1906 Beiträge zur Anatomie der Säugetierlungen. *Sitzungsber. kgl. preuss. Akademie Wiss.*
- STIEDA 1878 Einiges über den Bau und Entwicklung der Säugetierlungen. *Zeitschr. f. wiss. Zoolog.*, Bd. 30, Supplement.
- STÖHR 1915 Lehrbuch der Histologie.
- SUCCHARD 1903 Structure du poumon du triton et de la salamandre maculée. *Arch. d' Anatom. microscop.*, T. 6. (according to Schwalbe's Jahresbericht).
- SUDSUKI 1899 Ueber das Lungenemphysem. *Virchow's Archiv.*, Bd. 157.
- SUSSDORF 1911 *Ellenberger's vergleichende mikroskopische Anatomie der Haustiere*.
- SZYMONOWICZ 1909 Lehrbuch der Histologie.
- TEUFFEL 1902 Zur Entwicklung der elastischen Fasern in der Lunge des Fötus und des Neugeborenen. *Arch. f. Anat. u. Physiol.*, Anat. Abteil.
- VERAGUT 1880 Ueber Veränderungen des Lungenepithels bei künstlich hervorgerufenen pneumonischen Processen. *Virchow's Archiv*, Bd. 82.

THE AMERICAN JOURNAL OF ANATOMY, VOL. 27, NO. 4
SEPTEMBER, 1920

Resumen por el autor, Alexander S. Begg.
Escuela Médica Harvard, Boston.

Ausencia de vena cava inferior en un embrión de cerdo de 12 mm.,
asociada con el drenaje del sistema de la porta
en el sistema cardinal.

Los casos de ausencia de la vena cava inferior descritos hasta el presente lo han sido en adultos o en embriones avanzados, en los cuales esta condición era duradera, mientras que el presente caso se presenta en un embrión joven (12 mm.), en un estado crítico de la formación de los vasos sanguíneos. Existen las dos venas cardinales posteriores, y los canales subcardinales no son grandes. Los sinusoides hepáticos y las venas subcardinales no se han unido todavía, aun cuando normalmente esta unión tiene lugar en un periodo mas temprano. El caracter de la cubierta del hígado es de tal clase que parece poco probable que la anastomosis tenga lugar mas tarde. El autor considera importante a este punto, porque si la unión no se lleva a cabo, habrá ausencia de la vena cava inferior aun cuando las otras porciones existan. La segunda anomalía es mas visible. Las conexiones de las venas mesentéricas con el hígado son muy delicadas y un nuevo canal está formándose por medio de la vena esplénica y el sistema cardinal posterior. El autor hace referencias de ciertos casos importantes de ambas anomalías previamente descritos en la literatura.

Translation by José F. Nonidez
Cornell Medical College, New York

ABSENCE OF THE VENA CAVA INFERIOR IN A 12-MM.
PIG EMBRYO, ASSOCIATED WITH THE DRAINAGE
OF THE PORTAL SYSTEM INTO THE CARDINAL
SYSTEM

ALEXANDER S. BEGG

Harvard Medical School, Boston, Massachusetts

THREE FIGURES

Anomalies of the adult venous system due to faulty development of the cardinal veins in the embryo have frequently been recorded. Naturally those in man have received the greatest attention from anatomists, and the number of cases reported is quite large. From Petsche's report in 1736 to the present year I find more than 150 cases of human anomalies definitely associated with the cardinal system in its relation to the inferior vena cava, and this number does not include the numerous cases limited strictly to the azygos veins. Other mammals have likewise been studied with reference to these veins; in fact, the earliest record of an abnormal condition appears to be the peculiar doubling of the vena cava inferior in a dog, recorded and figured by Kerckring in 1670. After a long series of observations on the cat, carried out with admirable thoroughness, Huntington, McClure and Darrach have elaborately classified the variations in this animal. Other observations include those of Hall on the rabbit, Korosky on the dog, Phisalix and Zumstein on the guinea-pig, Keith on gibbons, and other observers upon development and variations in many forms.

A study of the reported cases reveals interesting difficulties in regard to nomenclature and classification. There are, on one hand, cases in which the vena cava inferior is said to be double when the normal single vessel is but partially developed and, on the other hand, the vena cava inferior is said to be absent when the component parts are all present save one. This recalls Professor Dwight's query, "What constitutes the vena cava in-

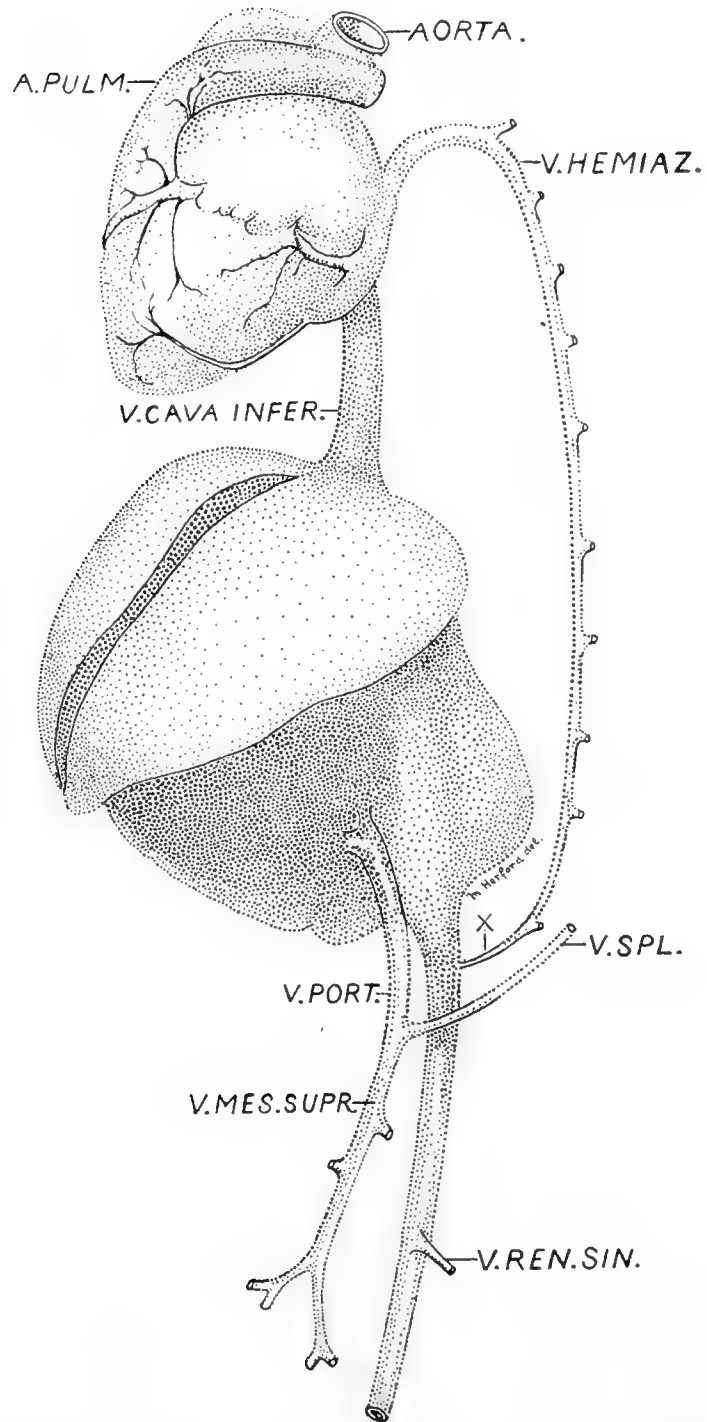

Fig. 1 The heart, liver, and associated veins of a pig six weeks after birth. From a dissection of an injected specimen. Reduced approximately $\frac{1}{2}$. *A. pulm.*, pulmonary artery; *V. hemiaz.*, hemiazygos (or left azygos) vein; *V. port.*, portal vein; *V. ren. sin.*, left renal vein; *V. spl.*, splenic vein.

ferior?" Dwight believed that the vein which extends through the diaphragm to empty into the lower part of the atrium is the inferior cava, regardless of the arrangement of its abdominal tributaries. If the vein, as in certain abnormal cases, receives only the branches from the liver, and if this vein is called the common hepatic vein (following Kaestner, '00), then consistency requires that in normal cases the cava be described as emptying into the common hepatic vein and not into the heart. The work of Lewis, however, on rabbits has fully established the importance of the subcardinal veins and the essential nature of their anastomosis with the sinusoids of the liver in the formation of the inferior vena cava. In fact, this seems to be the crux of the whole matter. If this anastomosis takes place, a cava is present; if it does not, then a cava is wanting, even though the other parts be present in proper sequence from heart to pelvis. In this sense only, the embryo about to be described is considered a case of absence of the vena cava.

The subcardinal veins may play a very important part in the production of anomalies, as shown by Johnson ('10), while considerable importance is attached by Huntington and McClure to the supracardinal veins in the production of various anomalies in the cat. There seem to be, therefore, a number of channels through which blood may drain from the pelvic limbs and abdominal parietes in order to reach the heart, namely, the cardinal veins, the subcardinal anastomosis with hepatic sinusoids, and the supracardinal veins, to which must be added their derivatives, the azygos veins (Parker and Tozier, Sabin).

To facilitate the interpretation of conditions in the embryo the azygos system has been studied in a series of young pigs after birth and in older embryos by means of injections and dissections. Figure 1 shows one such preparation drawn as seen from the left side. The vena hemiazygos is seen to lie somewhat to the left and behind the aorta throughout the greater part of its course, receiving the lateral wall veins from both sides. The connection with the vena cava at the lower end of the hemiazygos (*X* in figure) is not usual, but does occur. At the upper end the vein turns sharply forward, passing to the left of the aorta and over the root of the left lung where it turns downward in close

relation to the left atrium. At the atrioventricular groove the vein turns to the right, and after receiving the cardiac veins empties into the right atrium. The splenic vein and the hemiazygos are in rather close proximity, being separated by the crus of the diaphragm, and while no connecting vessel was observed, capillary connection would not seem improbable.

Heretofore the anomalous absence of the inferior vena cava has been found either after birth or in older embryos, at a time when the abnormal condition has been long established. The specimen here to be described is a pig embryo of 12 mm., a stage not much later than that in which the anastomosis between the subcardinals and the hepatic sinusoids first occurs. The arrangement of vessels so closely resembles the condition normally found at an earlier period that one questions, at first examination, if indeed anything is amiss, but a study of other embryos in the Harvard Collection shows that the formation of a vena cava inferior has begun in 6-mm. specimens and is well advanced in those of 7.5 mm. As is well known, a large vessel should be present at 12 mm. The development of the various organs corresponds with that in other 12-mm. embryos, and the presence of an associated and unquestioned anomaly in the portal system of veins confirms the correctness of the recorded measurements. In addition to these considerations, the density of the mesenchyma investing the liver, as well as that within the caval mesentery, leads to the conclusion that this specimen would never have possessed a vena cava inferior.

The cardinal system of veins with adjacent venous channels has been modeled in the abnormal specimen and also in a normal embryo of like size for comparison. These models were made in wax and plated with copper, following Wallin's method. While the cardinal and the veins of the Wolffian bodies of both sides were modeled, only the right side is shown in the drawing.

The appearance of the veins as shown by the model of the normal embryo is that made familiar by the graphic reconstructions published by Lewis ('03) and by the cleared injected embryos exhibited by Professor Sabin at the Philadelphia meeting of the American Association of Anatomists in 1913 (afterward published, 1915). The vena cava inferior is seen to have reached a

stage when it is already quite large, and the connection with the liver is well established. It receives the blood from the pelvic limbs through channels which lie at first along the dorsal surface of the Wolffian body and then are diverted ventrally to the inter-subcardinal anastomosis. In addition to these large channels, the Wolffian body shows many small transverse veins which encircle its peripheral part as described by Sabin. It will be noted further that although the veins of the right Wolffian body are drained anteriorly by the posterior cardinal vein, this channel is reduced in size and on the left side its continuity apparently has been interrupted.

In the model of the abnormal embryo, no connecting link is found between the cardinal and hepatic systems of veins. Moreover, the posterior cardinal veins are noted as prominent trunks along the whole length of the Wolffian body on its dorsolateral surface, receiving the veins of the pelvic limbs below and emptying into the common cardinal veins above. The subcardinals of the abnormal embryo are small, and the anastomoses across the ventral aspect of the aorta are not large. It would appear, therefore, from a study of this embryo that the two sides are as yet practically symmetrical. In a case described by Von Recklinghausen, in a child at birth, there was said to be a persistence of both cardinals, each receiving its corresponding renal vein, thus, the right cardinal emptied into the vena cava superior and the left terminated in the left subclavian. With the exception of the three cases of Hyrtl in anencephalic embryos, this is the only case of the sort which I have found. If the cardinal veins in the abnormal pig embryo should persist throughout, a condition similar to these rare cases would result, but it would be quite possible for the anterior part of either the right or left cardinal to disappear, giving rise to a more familiar type of anomaly. Whether, in case a single channel were formed, the renal vein from the opposite side would pass dorsal or ventral to the aorta would be determined by the fate of the small pre-aortic subcardinal anastomoses. The usual course of the renal vein in these cases is behind the aorta, but in this specimen post-aortic anastomoses have not yet developed. Because of the early stage in the production of the anomaly, it is impossible to

predict the permanent form which it would assume in this case. It serves as a common starting-point for several types of the absence of the vena cava inferior. This would of course be true of a normal embryo at a still earlier stage, and as the variation is one of arrested development, the striking resemblance to a younger embryo is to be expected.

A conspicuous and more unusual anomaly is in process of development in connection with the portal system. The common vitelline vein and the superior mesenteric vein are seen to be well formed, but the usual large portal vein is represented only by small capillary connections with the hepatic sinusoids. The main drainage from the portal system appears to be by way of the splenic vein into the subcardinal anastomosis. Since this anastomosis normally forms part of the left renal vein in the adult, it follows that this condition would lead to the production of a trunk passing from the splenic vein to the left renal. A rare case of this sort has been reported in the human adult by Pensa ('08), who cites a few other cases from the literature. In order to be compatible with continued development, however, the portal connection with the liver should be of some size. Cases in which the portal vein empties directly into the systemic circulation have, however, been reported, for example, by Abernathy (1793) in a child of ten months, by Lawrence (1814) in a person of some years, and by Hyrtl ('39) in two anencephalic monsters.

The anomaly of the portal system is of a radically different nature from that of the absent vena cava; in the latter case, large channels normally present in younger embryos have persisted in their earlier proportions, whereas in the portal anomaly, on the contrary, a large channel always found in younger embryos which should persist, has atrophied. The place of this channel has been taken by the enlargement of a normal but insignificant connection, which, however, has not escaped the attention of embryologists. Among others, Davis has particularly called attention to capillary connections between the splenic and subcardinal veins in pig embryos. These normally remain minute or disappear, but occasionally may enlarge and produce the extraordinary condition found in this embryo and, in the rare cases cited, in the adult. It is significant, in interpreting the condi-

tions found in the pig embryo, that the vena cava inferior was said to be absent in both Abernathy's and Hyrtl's cases. Although Abernathy's case was described many years ago his careful account of it is illustrated satisfactorily and his specimen has long been preserved in the museum of St. Bartholomew's Hospital, London. It has more recently been seen and described by McWhinnie ('40). Although Hyrtl's cases represent a slighter departure from the conditions found in the pig embryo, inasmuch as both cardinals persisted, it is quite possible that one of them should disappear in later development and the conditions found by Abernathy would then be realized. Morphologically, therefore, this embryo helps to explain two important types of venous anomaly which have not previously been seen in actual process of development.

LITERATURE CITED

- ABERNATHY, J. 1793 *Philosoph. Trans. Royal Society, London* pt. 1, pp. 59-63.
- DARRACH, W. 1907 *Anat. Rec.*, vol. 1, p. 30.
- DAVIS, D. M. 1910 *Am. Jour. Anat.*, vol. 10, pp. 461-471.
- DWIGHT, T. 1901 *Jour. Anat. and Phys.*, vol. 35, p. 7.
- HALL, E. S. 1890 *Proceedings Zool. Soc. London*, pt. 3, p. 577.
- HUNTINGTON, G. S., AND McCLURE, C. F. 1907 *Anat. Rec.*, vol. 1, p. 33.
- HYRTL, J. 1839 *Med. Jahrbücher des Oesterreich. Staates*, Bd. 27, S. 3-13. Wien.
- JOHNSON, F. B. 1912-13 *Jour. Anat. and Phys.*, vol. 47, p. 235.
- KAESTNER, S. 1900 *Archiv für Anat. u. Phys.*, Anat. Abt., S. 271-280.
- KEITH, ARTHUR 1895 *Proc. Anat. Soc. Gt. Britain and Ireland*, vol. 30, p. II, November.
- KERCKRINGIUS, T. 1670 *Spicilegium Anatomicum Amstelodam.*
- V. KOROSY, K. 1910 *Arch. f. Entw.-mech. d. Org.*, Bd. 29, H. 1, S. 150.
- LAWRENCE 1814 *Med. Chirurg. Trans.*, T. 5, p. 174.
- LEWIS, F. T. 1902 a *Am. Jour. Anat.*, vol. 1, pp. 229-244.
1903 b *Am. Jour. Anat.*, vol. 2, no. 2, pp. 211-225.
- MCWHINNIE 1839-40 *London Med. Gaz.*, March 27, vol. 2, New Series, p. 31.
- MARTIN 1862 *Monats. für Geburtskunde*, Bd. 20, S. 172.
- PARKER, G. H., AND TOZIER, C. H. 1898 *Bull. Mus. Comp. Zool.*, March.
- PENSA, A. 1908 *Boll. della Soc. Med. Chirurg. di Pavia*, June 26.
- PETSCHKE, J. Z. 1736 *Haller's Anat. Select.*, vol. 6, sect. 76, p. 781. Halle.
- PHISALIX, C. 1898 *Memrs. Comp. Rendu Soc. Biol.*, X series, T. 5, p. 152.
- SABIN, F. 1914 a *Anat. Rec.*, vol. 8, no. 2.
1915 b *Contributions to embryology. Carnegie Institution of Washington*, vol. 3, no. 7.
- WALLIN, I. E. 1913 *Anat. Rec.*, vol. 7, p. 251.
- ZUMSTEIN, J. 1897 *Anat. Hefte, Abt. I, H. 25, Bd. 8, S. 165-188.*

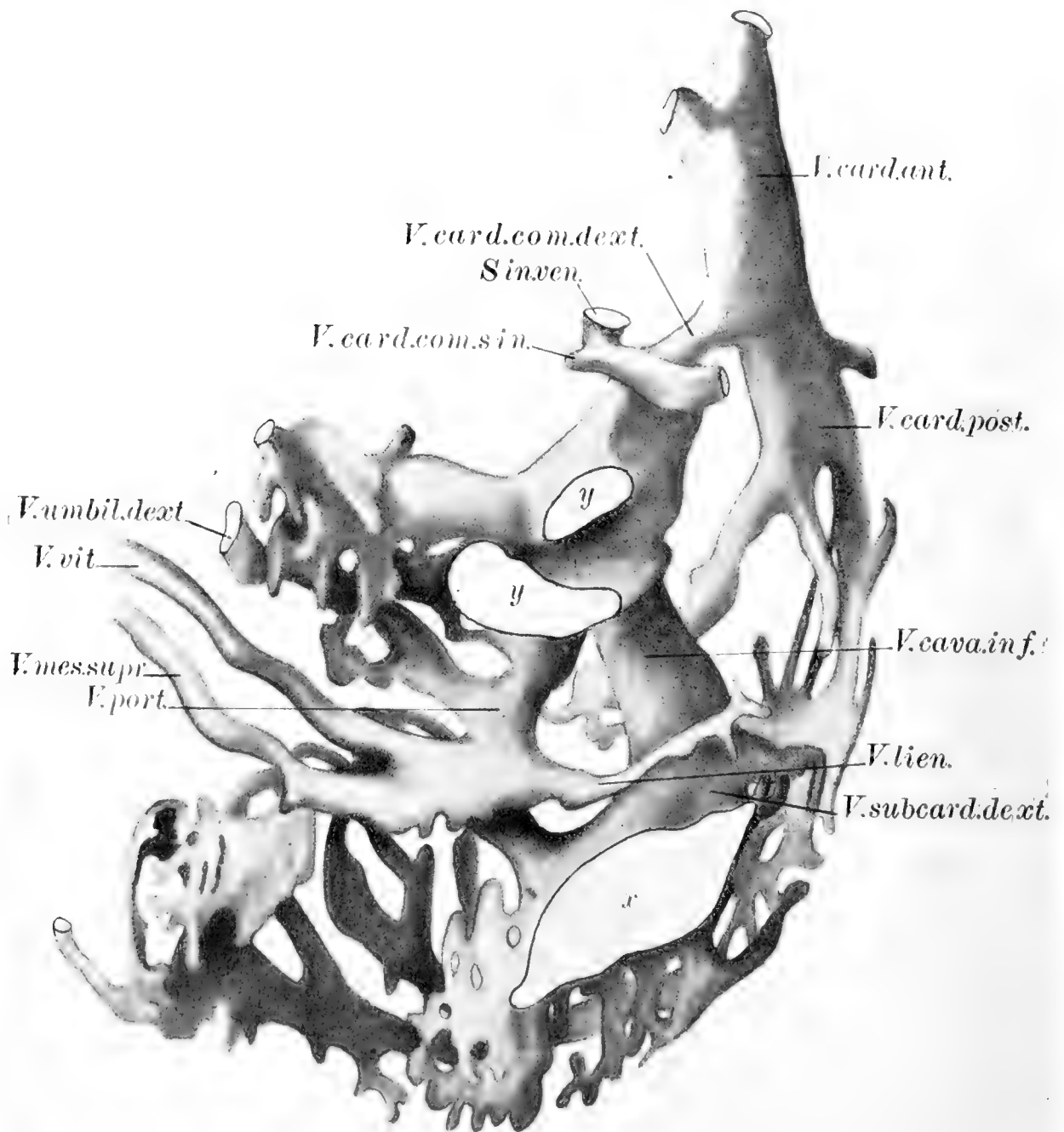
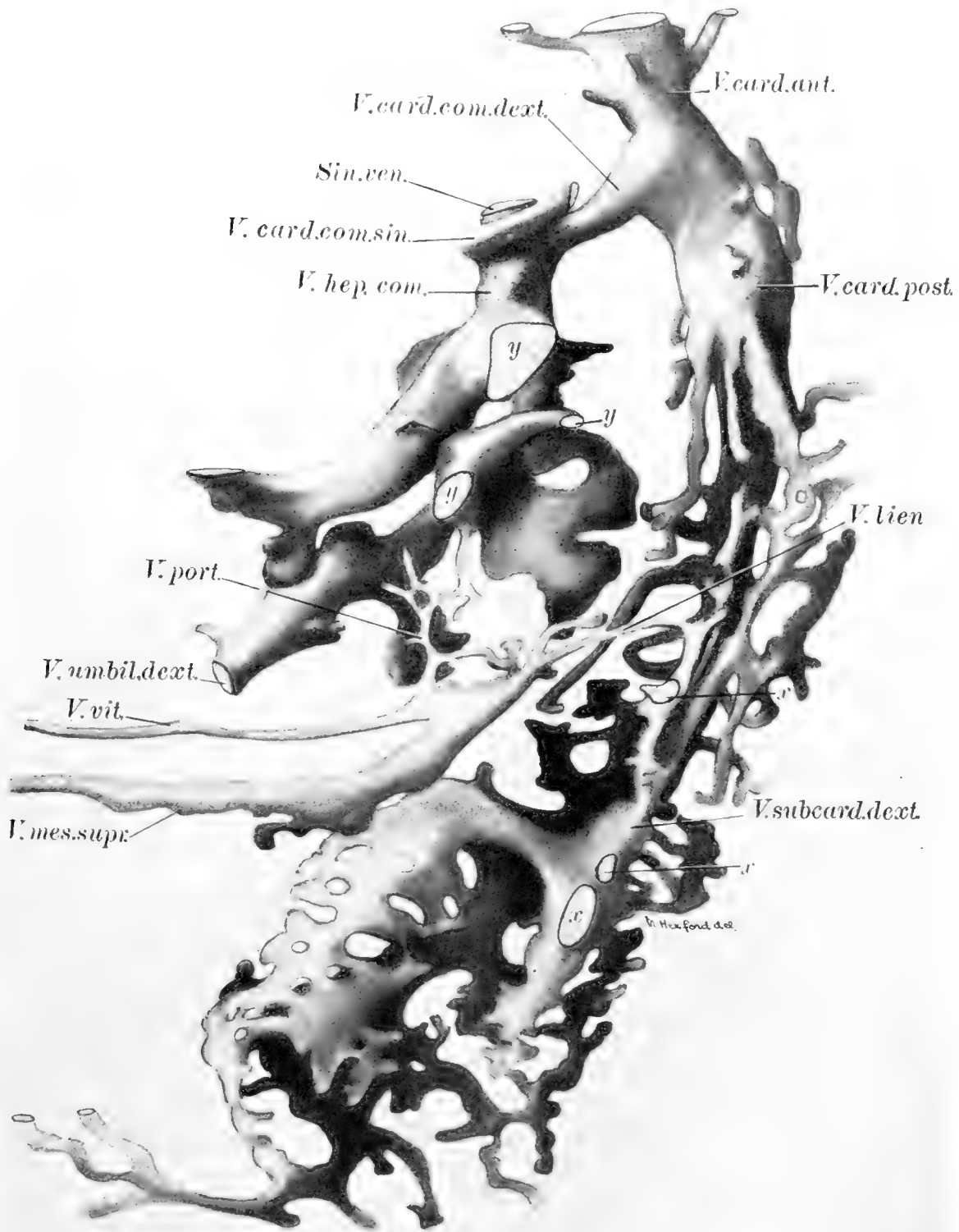

Fig. 2 Model showing normal arrangement of principal veins in the right half of a pig embryo of 12 mm. Magnification, $33\frac{1}{3}$. *V. card. com. dext.*, *V. card. com. sin.*, right and left cardinal vein (duct of Cuvier); *Sin. ven.*, sinus venosus; *V. card. ant.*, *V. card. post.*, anterior and posterior cardinal veins; *V. cava. inf.*, inferior vena cava; *V. hep. com.*, common hepatic vein; *V. lien.*, splenic vein;



V. mes. supr., superior mesenteric vein; *V. port.*, portal vein; *V. subcard. dext.*, right subcardinal vein; *V. umbil. dext.*, right umbilical vein; *V. vit.*, vitelline vein; *x*, intersubcardinal anastomosis; *y*, hepatic veins.

Fig. 3 Model showing an abnormal arrangement of veins in a pig embryo of 12 mm. Magnification, $33\frac{1}{3}$. Lettering as in figure 2.

Resumen por el autor, Hayato Arai.
Instituto Wistar de Anatomía y Biología.

Sobre el desarrollo postnatal del ovario (rata albina) con especial
mención del número de óvulos.

El peso de los ovarios aumenta continuamente con la edad, pero generalmente el ovario derecho es más ligero y pesa el 90 por ciento del peso del izquierdo. Al nacer, ambos ovarios contienen unos 35,000 óvulos, cuyo número disminuye a medida que aumenta la edad. A los veinte y tres días hay 11,000 óvulos, y este número se mantiene constante casi hasta la pubertad, siguiendo una disminución a 7,000 óvulos a los setenta días. Después hay una disminución bastante regular hasta que el número de óvulos es de 2,000 a los treinta y un meses. En general la disminución del número de óvulos se debe a la degeneración de los óvulos primitivos, pero los óvulos definitivos degeneran también. La nueva formación de óvulos a expensas del epitelio germinativo continúa después del nacimiento, formándose de este modo los óvulos definitivos. Durante la pubertad esta nueva formación se hace menos activa, pero puede continuar un año después del nacimiento. La ovulación puede tener lugar espontáneamente (sin la influencia del sexo macho). Los cuerpos amarillos se encuentran primeramente en las ratas que miden de 148 a 150 mm. de longitud y aparecen en ambos ovarios. Los que se forman en ratas que han sido fecundadas son un poco más grandes que los que aparecen en ratas sin fecundar. Hemos encontrado en ambos ovarios hasta veintium folículos próximos a madurar.

Translation by José F. Nonidez
Cornell Medical College, New York

ON THE POSTNATAL DEVELOPMENT OF THE OVARY
(ALBINO RAT), WITH ESPECIAL REFERENCE
TO THE NUMBER OF OVA

HAYATO ARAI

The Wistar Institute of Anatomy

FOUR CHARTS

INTRODUCTION

Numerous data on the postnatal development of the ovaries of lower mammals are to be found, but, so far as I am aware, there are no investigations on the number of ova in these animals. For the human ovaries, however, there are five observations on the number of ova, though the techniques used by several authors are open to some criticism.

Strange to say, despite the great emphasis recently placed on the study of reproductive phenomena, especially in relation to the questions of inheritance, sex difference, or of physiology of the internal secretions, no one has attempted to obtain fundamental data on the number of ova in the ovaries, although such data may throw some definite light on the various problems in the physiology of reproduction.

I have taken this study of the total number of ova in the rat during the entire span of life at the suggestion of Prof. H. H. Donaldson, to whom I am happy to acknowledge my indebtedness not only for his deep interest shown during the progress of the work, but also for numerous suggestions while preparing this paper.

I shall first present the data on the number of ova in human ovaries as reported by the five investigators.

Henle ('73) estimated the number of the follicles in an ovary of an eighteen-year-old woman, and stated that it contained about 36,000 follicles, or not less than 72,000 in both ovaries. The method by which he estimated this number is as follows:

Ich zählte in einem Sagittalschnitte aus dem Ovarium eines 18 jährigen Mädchens, welcher etwa den sechsten Theil der Peripherie umfasst, 20 solcher Bläschen; längs der ganzen Peripherie des Frontalschnittes würden deren also etwa 120, längs der Peripherie eines, dem längsten Durchmesser des Ovarium parallelen Durchschnitts vielleicht 300 anzunehmen sein, und sonach würde die Zahl der Bläschen in einem Ovarium etwa 36,000, in beiden nicht viel weniger als 72,000 betragen.

Thus Henle counted the number of the follicles contained in one-sixth of one section and then obtained his result by multiplying this number of ova by the total number of sections.

Heyse ('97) counted more exactly the number of follicles in the ovary of a woman seventeen years old. The method which he adopted was as follows:

Ich zählte in jedem der 42 Schnitte die Follikel und maass unterm Mikroskop die Flächenausdehnung jedes einzelnen Schnittes aus. Die Summe aller Follikel betrug 1165, die von der Summe der Schnitte eingenommene Fläche umfasste 1996 qmm. Da die Dicke der einzelnen Schnitte 0.05 mm. betrug, so ergibt sich ein Rauminhalt von 100 cbmm. auf welchen also die Zahl von 1165 Follikeln kommt. Nach Angaben von Gegenbaur und Vierordt nahm ich den Inhalt des ganzen Ovariums zu 3600 cbmm. an, danach würden im ganzen Ovarium ziemlich 42,000 Follikel zu zählen sein. Indessen besteht noch eine Hauptfehlerquelle. Wenn von den durchgezählten Schnitten zwei unmittelbar auf einander gehören, so werden die einzelnen, durchschnittenen Follikel in jedem der beiden Schnitte gezählt werden, also doppelt; Graafsche Follikel würden so sogar vielfach in Rechnung gesetzt werden. Aber auch wenn die einzelnen Schnitte durch dazwischen liegende Substanz getrennt sind, werden immer dem einzelnen Schnitte eine Anzahl Follikel zugerechnet, die mit ihrem Haupttheile ihm gar nicht angehören. Daher werden also alle Follikel, die nicht auf einen Schnitte beschränkt sind, implicite doppelt gezählt. So habe ich daher an 10 meiner Schnitte noch festgestellt, wieviel von den überhaupt in ihnen zählbaren Follikeln mit ihrem Centrum, oder bei den grösseren mit der Eizelle, in den Schnitten lagen. Ich fand, dass diese 41.95 procent der Gesamtmenge betrogen. Von den oben erhaltenen 42,000 Follikeln nahm ich daher auch 41.95 procent und es ergab sich als wirkliche Anzahl, der in dem normalen Ovarium vorhandenen Follikel (abgerundet) 17,600.

By the method just stated, Heyse determined the number of follicles in both ovaries to be 35,200. Heyse also obtained his number by estimation.

This method of Heyse is certainly more exact than Henle's, but it is not sufficiently so because, according to Vierordt's table

('06), the thickness of the ovary of a woman nineteen years old is on the average (left and right) 13.4 mm. If the sections were made 0.05 mm. in thickness, the total number of sections would be at least 270. From 270 sections, therefore, Heyse selected only forty-two sections, that is about one-sixth of the total ovary. Moreover, the distribution of follicles in the mature ovary is not so uniform as in the ovary of the new-born, but varies enormously between two sections when taken some distance apart. Therefore, Heyse should have counted at least half of the total ovary in order to obtain a fairly approximate number.

Joessel and Waldeyer ('99, p. 793) state that both ovaries of a new-born child contain 100,000 or more ova, but it is explicitly added that this is merely an estimate and probably too low rather than too high.

Sappey ('79) made a determination of the number of ova by counting those found in 1 sq. mm. of the section and then computing the number which should be present in the entire ovary. His numbers are very large. In one girl of three years he estimated 422,000 ova in one ovary. In another of four years 675,000, and in a third child 300,000. In a young woman of eighteen years he reports 300,000 in one ovary. Why these numbers are so high I cannot at the moment say.

The latest study on the number of ova in man is that by v. Hansemann ('13). I have taken the liberty of tabulating his results, which were obtained by counting the number of ova in every fifth section from a complete series of sections for each ovary. The number of ova thus counted was multiplied by five, and the results are those given. It is difficult to determine from the text whether the final number represents the ova in one or in both ovaries, but I assume that the numbers are for one ovary only.¹

¹ Several of the authors here quoted on the number of ova in man do not make it plain whether their numbers apply to one ovary or to both, so that I have had to decide the question by inference in most cases. In the article by v. Hansemann ('13) reference is made to the statement by Minot ('92) that there are 70,000 ova in man. This is evidently based on Henle's determination. Waldeyer ('06) (in Hertwig's Handbuch) states that there are probably 50,000 ova in each ovary of the human fetus.

Number of ova in one (?) ovary of man at different ages (v. Hansemann)

| <i>Age</i> | <i>Number of Ova</i> |
|----------------------|----------------------|
| 6.5 months..... | 30,339 |
| 1 year 2 months..... | 48,808 |
| 2 years..... | 46,174 |
| 8 years..... | 25,665 |
| 10 years..... | 20,862 |
| 14 years..... | 16,390 |
| 17 to 18 years..... | 5,000-7,000 |

While there is still some doubt whether the numbers given by v. Hansemann are for one or for both ovaries, yet they show clearly what the previous data suggest; namely, that there are many more ova present during the earliest years of life than at puberty, and that even after puberty the numbers show a significant decrease.

To obtain some accurate information regarding the relation between the number of ova and the age of the animal, I have utilized the ovaries of albino rats.

MATERIAL AND TECHNIQUE

The material used in this study was all supplied from the rat colony at The Wistar Institute. The number of rats examined for the standard table was thirty-nine—from one day after birth to 947 days of age—and the material was collected during seven months—from April to November, 1918.

In each instance the body weight, body length, the weights of the ovaries, and the appearance of corpora lutea were recorded. The removal of the ovary, especially when the rats are very small, requires some practice. Each ovary was quickly weighed and then fixed in Bouin's solution for from six to eight hours. The material was washed in running water for twenty to thirty minutes, sometimes for one hour, run through the alcohols, cleared in xylol, and finally imbedded in paraffin. Each entire ovary was sectioned in series at 10 μ , and the sections were stained with hematoxylin and eosin.

In order to obtain approximately the true number of ova in the ovaries, I have counted under the microscope the nucleus of every ovum in the series of sections obtained from each entire

ovary. The nuclei which were counted were those most distinctly stained by hematoxylin. The diameter of the nuclei of the ova range from 8 to 12 μ both in the primitive ova and in the definitive ova. By this method we might make a double counting occasionally, because it is based on the counting of the distinctly stained nuclei. On the other hand, there is no fear of missing ova, because the sections were 10 μ thick, while the smallest nucleus has a diameter of 8 μ at least.

For counting the number of ova in younger ovaries, especially those before twenty days of age, the use of the net-micrometer is necessary. For the measurement of the diameter of the larger ova a Zeiss compens. ocular no. 6 and object. 4 was used and the micrometer eyepiece was so adjusted that each division equalled 4 μ . I have divided all the ova, according to their diameters, into four groups:

| <i>Group</i> | <i>Diameter</i> |
|--------------|--------------------|
| I..... | less than 20 μ |
| II..... | 20 to 40 μ |
| III..... | 40 to 60 μ |
| IV..... | over 60 μ |

We find ova, especially in the mature ovaries, which show several stages of degeneration. These stages I have divided into four groups.

A. The follicles are poorly developed and have one to three layers of cells. In the centrum the ovum is not found, but instead there is a homogeneous hyalin mass which stains red with eosin.

B. The follicles which belong to this group show merely the outline of the ova in follicles, but the ovum is without a nucleus. Such ova stain red with eosin but faintly.

C. In this group the follicles are well developed, and sometimes are almost like the mature follicles, having many layers of follicle cells, but these cells are either already degenerated or are about to degenerate. In these follicles the large cavity usually contains fluid or sometimes a colloidal mass which stains a deep red with eosin. However, no ova can be found. The shape of the follicles is either circular or oval.

D. In this group the follicles show an appearance similar to those in Group C, but the outline of the ova shows an irregular contour and the nucleus cannot be found. Sometimes we find numerous cell contours, devoid of nuclei, which are stained more plainly by eosin than normal ova. Whether these numerous cell contours were produced from many ova or from degenerated follicle cells which have fallen into the cavity, is not yet determined.

In the ovary after about sixty to seventy days of age corpora lutea are present. These we divided into two groups according to their characters, while each of these may be further subdivided into two subgroups.

A. Large corpora lutea. 1. The corpus luteum which belongs to this subgroup is large in size and its lutein cells show no degenerative processes. It contains some blood in its centrum, and the lutein cells are full size.

2. Those belonging to the subgroup (2) show the lutein cells less fresh, and signs of degeneration are present. Whether or not these two subgroups of large corpora lutea are produced as the result of pregnancy, is not clear.

B. Small corpora lutea. In this second group the corpora lutea are small and the lutein cells in process of degeneration. Among them we can distinguish two forms: B (1) in which the corpus luteum is rich in blood capillaries and its lutein cells are fresh in appearance while in

B (2) the lutein cells appear to be resorbed and in their place the connective tissue appears, but this form can hardly be distinguished from the so-called 'corpora lutea atresia.'

We have counted separately the entire number of normal ova, making four groups according to diameter, the degenerate ova and the corpora lutea in each ovary—right and left side—and finally the total number of ova has been obtained by adding the numbers of ova found in both ovaries.

OBSERVATIONS

Under this head we shall merely present and describe our results, leaving the interpretation of them for the section entitled 'Discussion.'

1. *The comparison between the weight of ovaries and number of ova on the right and left sides*

There is, so far as I am aware, no statement concerning either the weight relations of the right and left ovaries, or concerning the number of ova in these.

To determine the weight relation between the ovaries when the left ovary is taken as the standard, we divide the entire series into two groups according to the presence or absence of the corpora lutea.

A. This group contains all cases in which the weight of one ovary is less than 10 mgm. and no corpora lutea are present. There are twenty such cases (up to 110 days), eleven of these have the ratio smaller than one, and seven the ratio larger than one, while in two cases the ratio equals one. The average ratio of all twenty cases is 0.93 for the right ovary. This ratio seems to indicate that in the absence of the corpora lutea the right ovary tends to be lighter than the left, though the difference is not great.

B. To this group belong all cases in which the weight of one ovary is greater than 10 mgm. and which show corpora lutea. We have altogether sixteen cases, among these thirteen cases show the ratio smaller than one, while three show the ratio more than one. The average of the ratios of the entire sixteen cases is 0.85 for the right ovary, thus giving a greater difference between the right and left ovaries in this group than in the former. The ratios for all thirty-six cases become 0.90, thus revealing clearly a tendency at all ages for the right ovary to weigh less than the left.

On the relative weights of the right and left ovaries of other mammals there are no observations. Wiedersheim ('97) states that in birds the right ovary undergoes an early and more or

less complete atrophy. In passing we may note that Riddle's ('18) observations on the testes of pigeons and doves show that in healthy birds the right testis is larger than the left in most cases, so that in birds asymmetry of the gonads appears in both sexes, but in opposite senses.

Since, as we shall see, the weight of the ovaries is influenced mainly by the abundance of well-developed follicles and of corpora lutea, it appears to me probable that the larger ovary should be better developed in this respect than the smaller.

The numbers of ova found in the two ovaries show the following ratios (table 1). The numbers of ova found in the right ovary were compared with those found in the left, taking the left as the standard. Out of the thirty-nine cases, seventeen show the ratios smaller than one; two show their ratios as 1.00, while in the remaining twenty cases the ratios are larger than one.

The averaged ratios in the two lots range from 0.91 to 1.12 for the right ovary. The average of all the thirty-nine cases gives the ratio of 1.03 for the right ovary, thus showing that the difference in the number of ova in the two ovaries is very slight.

From the above it is clear that the right ovary contains approximately the same number of ova as the left or a few more, despite the fact that it weighs somewhat less.

The apparent contradiction thus revealed may be due to the presence in the left ovary of a greater number of the larve ova, as well as of certain stages of the degenerating follicle, and may be influenced also by a slight inequality of the corpora lutea on the two sides.

If with these suggestions in mind we consult table 1, it appears that the combined numbers for the various classes of larger ova (more than $20\ \mu$ in diameter) are approximately the same in both ovaries, and by consequence the numbers of the smaller-sized ova are also approximately equal. It has not been deemed necessary to put in the numbers for the ova under $20\ \mu$ in diameter, as these may be obtained by subtraction. From the fact that while the total number of ova contained in both the right and the left ovary is approximately the same, while nevertheless the

TABLE 1

Giving with ages the number of ova in the left and the right ovary—together with their respective weights. Also the relative weights of the right ovary and the relative number of ova in it. The numbers for the corpora lutea are also given.

| AGE | LEFT OVARY | | | | RIGHT OVARY | | | | RATIOS | |
|---|----------------------|---------------|--------|---------------------|-----------------------|---------------|--------|---------------------|-----------------------------|-------------------------------|
| | Weight of ovary left | Ova | | Corpora lutea Total | Weight of ovary right | Ova | | Corpora lutea Total | Number of ova right to left | Weight of ovary right to left |
| | | Over 20 μ | Total | | | Over 20 μ | Total | | | |
| days | mgm. | | | | mgm. | | | | | |
| 1 | | | 16,807 | | | | 18,298 | | 1.09 | |
| 3 | | 174 | 14,138 | | | 208 | 14,114 | | 1.00 | |
| 5 | | 462 | 11,829 | | | 516 | 13,757 | | 1.17 | |
| 7 | 1.1 | 500 | 10,850 | | 0.7 | 475 | 10,135 | | 0.93 | 0.64 |
| 10 | 1.2 | 291 | 7,735 | | 1.0 | 289 | 7,671 | | 0.99 | 0.83 |
| 15 | 1.3 | 411 | 8,246 | | 1.1 | 382 | 7,630 | | 0.93 | 0.85 |
| 20 | 3.0 | 492 | 5,329 | | 3.4 | 494 | 5,747 | | 1.08 | 1.13 |
| 26 | 6.2 | 404 | 5,501 | | 4.6 | 355 | 4,921 | | 0.89 | 0.74 |
| 30 | 3.1 | 341 | 6,109 | | 3.6 | 260 | 6,432 | | 1.05 | 1.16 |
| 36 | 3.0 | 152 | 4,344 | | 2.6 | 186 | 4,705 | | 1.09 | 0.87 |
| 36 | 5.2 | 200 | 4,654 | | 5.2 | 233 | 4,344 | | 0.94 | 1.00 |
| 41 | 4.2 | 162 | 5,523 | | 3.2 | 138 | 6,448 | | 1.17 | 0.76 |
| 41 | 7.4 | 238 | 5,446 | | 6.6 | 203 | 4,827 | | 0.89 | 0.90 |
| 46 | 8.1 | 193 | 4,605 | | 6.0 | 138 | 5,761 | | 1.25 | 0.75 |
| 50 | 5.6 | 192 | 5,478 | | 5.6 | 143 | 5,555 | | 1.01 | 1.00 |
| 50 | 5.9 | 201 | 5,059 | | 7.0 | 183 | 5,014 | | 0.99 | 1.18 |
| 60 | 5.6 | 141 | 5,192 | | 4.7 | 139 | 5,260 | | 1.01 | 0.84 |
| 64 | 4.9 | 183 | 4,917 | | 3.0 | 179 | 5,114 | | 1.04 | 0.61 |
| 64 | 15.1 | 327 | 4,623 | 6 | 16.0 | 307 | 5,450 | 8 | 1.18 | 1.06 |
| 70 | 26.5 | 181 | 3,569 | 18 | 17.3 | 179 | 3,037 | 13 | 0.86 | 0.65 |
| 80 | 4.4 | 139 | 4,335 | | 5.0 | 169 | 4,231 | | 0.97 | 1.14 |
| 80* | 19.0 | 184 | 2,305 | 20 | 18.4 | 330 | 2,963 | 19 | 1.28 | 0.97 |
| 84 | 12.2 | 160 | 4,736 | 8 | 10.0 | 154 | 4,984 | 5 | 1.05 | 0.82 |
| 95 | 5.4 | 245 | 4,959 | | 6.8 | 226 | 5,805 | | 1.17 | 1.26 |
| 95* | 50.0 | 179 | 3,406 | 24 | 23.5 | 169 | 3,208 | 22 | 0.94 | 0.47 |
| 100 | 4.7 | 123 | 3,400 | | 4.1 | 86 | 2,341 | | 0.69 | 0.94 |
| 100 | 6.4 | 96 | 3,449 | | 6.7 | 119 | 3,619 | | 1.05 | 1.05 |
| 110 | 9.8 | 140 | 2,964 | | 9.9 | 152 | 2,429 | | 0.82 | 1.01 |
| 110 | 21.6 | 229 | 3,724 | 31 | 20.0 | 225 | 4,020 | 29 | 1.08 | 0.92 |
| 140 | 26.4 | 228 | 4,549 | 15 | 22.8 | 190 | 4,528 | 14 | 1.00 | 0.86 |
| 150 | 18.9 | 183 | 4,528 | 16 | 13.6 | 219 | 4,495 | 23 | 0.99 | 0.72 |
| 198 | 27.3 | 158 | 1,491 | 32 | 30.8 | 124 | 1,259 | 31 | 0.89 | 1.13 |
| 206* | 29.3 | 137 | 4,090 | 32 | 25.5 | 147 | 3,976 | 24 | 0.97 | 0.87 |
| 262 | 26.1 | 107 | 1,626 | 42 | 22.8 | 104 | 2,121 | 50 | 1.30 | 0.87 |
| 318 | 21.9 | 128 | 2,960 | 45 | 14.6 | 114 | 2,742 | 24 | 0.93 | 0.67 |
| 385 | 38.0 | 176 | 2,339 | 19 | 44.6 | 157 | 2,163 | 30 | 0.93 | 1.16 |
| 454 | 19.3 | 131 | 2,264 | 48 | 14.5 | 163 | 2,495 | 45 | 1.10 | 0.75 |
| 559* | 38.4 | 79 | 2,181 | 17 | 35.1 | 85 | 2,812 | 21 | 1.29 | 0.91 |
| 947 | 34.1 | 106 | 999 | 56 | 31.1 | 104 | 920 | 52 | 1.03 | 0.91 |
| Averages before appearance of corpora lutea | | | | | | | | | 1.03 | 0.88 |
| Averages after appearance of corpora lutea | | | | | | | | | 1.03 | 0.91 |

* Pregnant.

right ovary is smaller, it seems reasonable to infer that the right ovary may be slightly retarded, and consequently is smaller and also contains more ova than the left, as the number of ova decreases with increasing age.

This conclusion seems to be supported by the fact that previous to the first appearance of the corpora lutea at sixty-four days

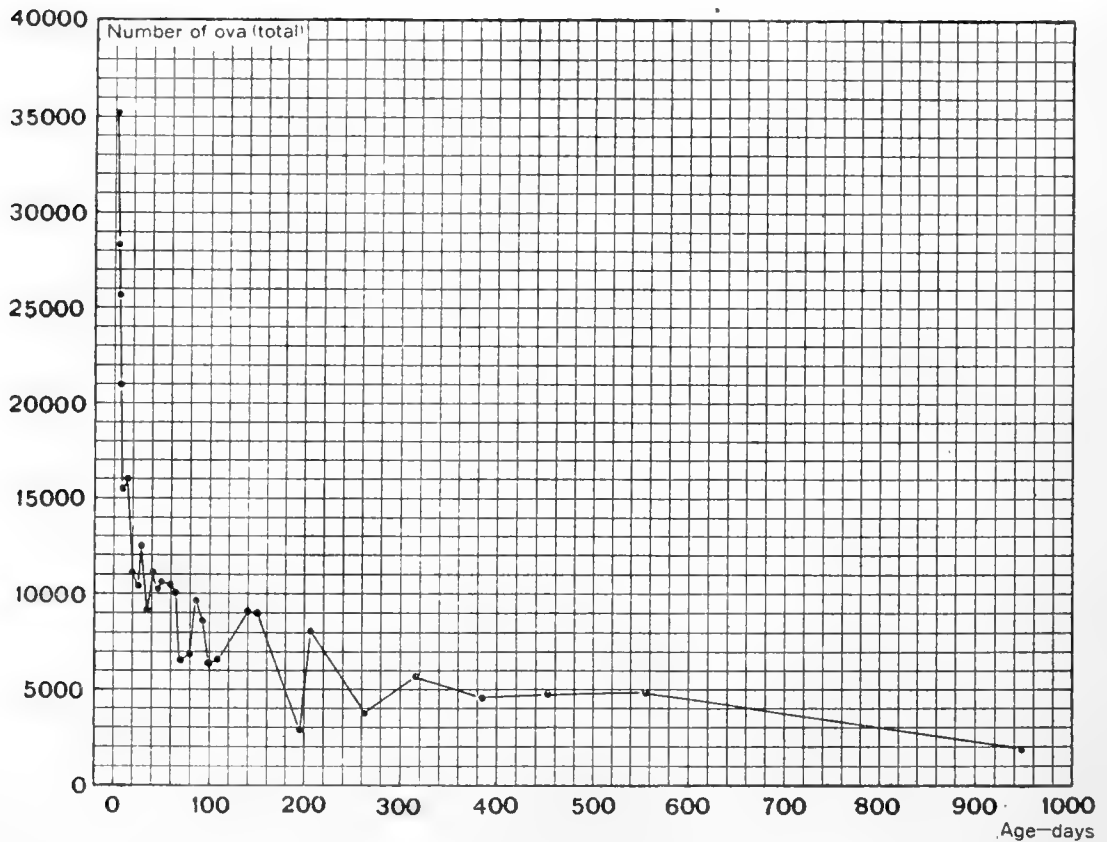

Chart 1 Showing the total number of ova in both ovaries of the albino rat at different ages (in detail).

the average relative weight of the right ovary is 0.88, while after this age it is 0.91 (bottom of table 1).

On the number of ova in relation to age

In table 2 the data on the thirty-nine rats are given.

As will be seen from both table 2 and chart 1, the total number of ova counted in both ovaries one day after birth was 35,105. This number decreases rapidly to 11,000 at twenty days, after which there is a very slow decrease to about 10,000 at sixty-four

TABLE 2

The relation between the age and the total number of ova, and of corpora lutea

| AGE | BODY WEIGHT | BODY LENGTH | WEIGHT OF BOTH OVARIES | NUMBER OF OVA | | | | | NUMBER OF CORPORA LUTEA | | | |
|-------------|--------------|-------------|------------------------|--------------------|----------------|----------------|--------------------|--------|-------------------------|-------|-------|--|
| | | | | Less than 20 μ | 20 to 40 μ | 40 to 60 μ | More than 60 μ | Total | Small | Large | Total | |
| <i>days</i> | <i>grams</i> | <i>mm.</i> | <i>mgm.</i> | | | | | | | | | |
| 1 | 5.5 | 47 | | 35,105 | | | | 35,105 | | | | |
| 3 | 7.3 | 52 | | 27,870 | 382 | | | 28,252 | | | | |
| 5 | 10.6 | 60 | | 24,608 | 978 | | | 25,586 | | | | |
| 7 | 13.9 | 69 | 1.8 | 20,009 | 974 | 2 | | 20,985 | | | | |
| 10 | 14.8 | 76 | 2.2 | 14,826 | 542 | 38 | | 15,406 | | | | |
| 15 | 20.5 | 83 | 2.4 | 15,083 | 470 | 323 | | 15,976 | | | | |
| 20 | 23.7 | 89 | 6.4 | 10,090 | 404 | 469 | 113 | 11,076 | | | | |
| 26 | 30.2 | 95 | 10.8 | 9,663 | 322 | 275 | 162 | 10,422 | | | | |
| 30 | 34.8 | 108 | 6.7 | 11,940 | 279 | 208 | 114 | 12,541 | | | | |
| 36 | 34.9 | 105 | 5.6 | 8,711 | 152 | 124 | 62 | 9,049 | | | | |
| 36 | 50.0 | 122 | 10.4 | 8,565 | 184 | 137 | 112 | 8,998 | | | | |
| 41 | 58.2 | 131 | 7.4 | 11,671 | 204 | 59 | 37 | 11,971 | | | | |
| 41 | 61.9 | 128 | 14.0 | 9,832 | 229 | 121 | 91 | 10,273 | | | | |
| 46 | 69.5 | 142 | 14.0 | 9,935 | 156 | 115 | 60 | 10,266 | | | | |
| 50 | 74.6 | 146 | 11.2 | 10,698 | 197 | 74 | 64 | 11,033 | | | | |
| 50 | 75.5 | 144 | 12.9 | 9,689 | 236 | 98 | 50 | 10,073 | | | | |
| 60 | 93.5 | 145 | 10.3 | 10,173 | 149 | 91 | 40 | 10,452 | | | | |
| 64 | 62.7 | 132 | 7.9 | 9,669 | 189 | 106 | 66 | 10,030 | | | | |
| 64 | 113.5 | 165 | 31.1 | 9,439 | 398 | 187 | 47 | 10,073 | 6 | 8 | 14 | |
| 70 | 106.3 | 162 | 42.8 | 6,246 | 197 | 99 | 64 | 6,606 | 9 | 22 | 31 | |
| 80 | 77.3 | 140 | 9.4 | 8,258 | 189 | 77 | 42 | 8,566 | | | | |
| 80* | 107.3 | 153 | 37.4 | 4,564 | 290 | 179 | 145 | 5,268 | 26 | 13 | 39 | |
| 84 | 125.0 | 165 | 22.2 | 9,406 | 177 | 85 | 52 | 9,720 | 2 | 11 | 13 | |
| 95 | 98.5 | 148 | 12.2 | 10,293 | 276 | 109 | 86 | 10,764 | | | | |
| 95* | 160.0 | 182 | 73.5 | 6,266 | 129 | 109 | 110 | 6,614 | 33 | 13 | 46 | |
| 100 | 97.8 | 156 | 13.1 | 6,853 | 133 | 43 | 39 | 7,068 | 16 | 7 | 23 | |
| 100 | 78.5 | 138 | 8.8 | 5,535 | 110 | 75 | 24 | 5,744 | | | | |
| 110 | 94.3 | 147 | 18.7 | 5,100 | 176 | 75 | 41 | 5,392 | | | | |
| 110 | 167.1 | 185 | 41.6 | 7,290 | 307 | 101 | 46 | 7,744 | 40 | 20 | 60 | |
| 140 | 123.0 | 168 | 49.2 | 8,659 | 243 | 113 | 62 | 9,077 | 12 | 17 | 29 | |
| 150 | 129.5 | 171 | 32.5 | 8,621 | 222 | 138 | 42 | 9,023 | 18 | 21 | 39 | |
| 198 | 142.7 | 171 | 58.1 | 2,468 | 164 | 100 | 18 | 2,750 | 33 | 30 | 63 | |
| 206* | 188.5 | 185 | 54.8 | 7,782 | 155 | 97 | 32 | 8,066 | 33 | 23 | 56 | |
| 262 | 145.0 | 182 | 48.9 | 3,536 | 126 | 70 | 15 | 3,747 | 61 | 31 | 92 | |
| 318 | 155.0 | 189 | 36.5 | 5,460 | 126 | 87 | 29 | 5,702 | 53 | 16 | 69 | |
| 385 | 161.3 | 194 | 82.6 | 4,169 | 222 | 93 | 18 | 4,502 | 24 | 25 | 49 | |
| 454 | 138.7 | 194 | 33.8 | 4,465 | 160 | 78 | 56 | 4,759 | 67 | 26 | 93 | |
| 559* | 198.7 | 200 | 73.5 | 4,729 | 107 | 37 | 20 | 4,893 | 27 | 11 | 38 | |
| 947 | 238.0 | 215 | 65.2 | 1,709 | 128 | 61 | 21 | 1,919 | 90 | 18 | 108 | |

* Pregnant.

days. At this age the corpora lutea may appear, that is at about sixty-four days ovulation occurs. From sixty-four days on the total number of ova decreases slowly but steadily to about 2,000 at 947 days. This was the oldest rat available for study. Using the ratio of the span of life, 1 to 30, which we commonly employ when comparing the rat with man, 947 days for the rat is equivalent to seventy-eight years for man.

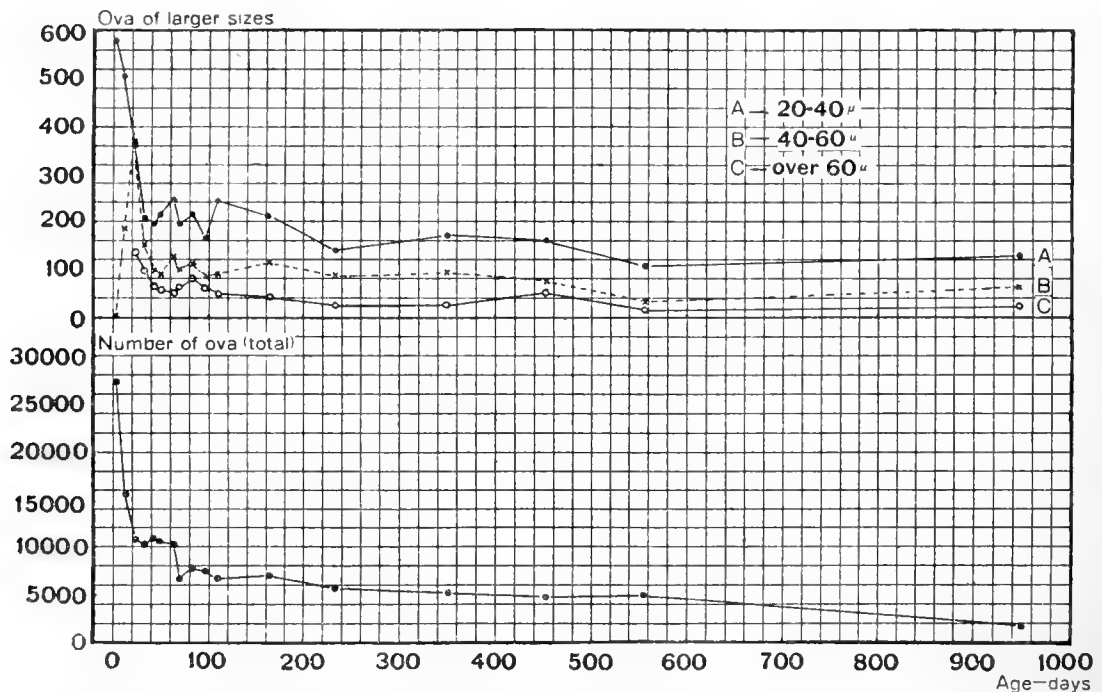

Chart 2 Showing the total number of ova, as well as the number of ova of different sizes in the albino rat at different ages (condensed).

On account of the high individual variation, I have averaged the data in table 2 and given the averages in table 3 and chart 2 with the hope that the data thus arranged might reveal more clearly the real tendency to the changes in the number of ova according to the age of the rat.

From birth up to 110 days the number of ova in the ovaries of the rats were grouped together within ten-day intervals, and after 110 days at intervals of about fifty days. The results of this grouping are shown in table 3 and chart 2. We notice that from the averages of four to twenty-three days the mean total number decreases very rapidly, from 27,483 to 10,746 ova, and

from twenty-three to sixty-three days the number of ova with slight variations diminishes from 10,746 (twenty-three days) to 10,185 (sixty-three days). From sixty-three days on it decreases rapidly at first, then rather steadily to 559 days, dropping markedly at the last entry for 947 days.

TABLE 3

The relation between the age and the number of ova in both ovaries; the average numbers. This is the fundamental table used for the discussion

| NUMBER OF RATS | INTERVAL OF AGE | AGE | BODY WEIGHT | BODY LENGTH | WEIGHT OF BOTH OVARIES | NUMBER OF OVA | | | | | NUMBER OF CORPORA LUTEA | | | |
|----------------|-----------------|------|-------------|-------------|------------------------|--------------------|----------------|----------------|--------------------|--------|-------------------------|-------|-------|--|
| | | | | | | Less than 20 μ | 20 to 40 μ | 40 to 60 μ | More than 60 μ | Total | Small | Large | Total | |
| | days | days | grams | mm. | mgm. | | | | | | | | | |
| 4 | 1-7 | 4 | 9.3 | 56 | | 26,898 | 584 | 1 | | 27,483 | | | | |
| 2 | 10-15 | 12 | 17.7 | 80 | 2.3 | 14,954 | 506 | 181 | | 15,641 | | | | |
| 2 | 20-26 | 23 | 26.9 | 92 | 8.6 | 9,877 | 362 | 372 | 138 | 10,746 | | | | |
| 3 | 30-36 | 34 | 32.6 | 112 | 7.6 | 9,737 | 205 | 156 | 96 | 10,196 | | | | |
| 3 | 41-46 | 43 | 63.2 | 134 | 11.8 | 10,479 | 196 | 98 | 63 | 10,836 | | | | |
| 2 | 50-50 | 50 | 75.0 | 145 | 12.1 | 10,193 | 217 | 86 | 57 | 10,553 | | | | |
| 3 | 60-64 | 63 | 89.7 | 147 | 16.4 | 9,760 | 245 | 129 | 51 | 10,185 | 2 | 3 | 5 | |
| 1 | | 70 | 106.3 | 162 | 43.8 | 6,246 | 197 | 99 | 64 | 6,606 | 9 | 22 | 31 | |
| 3 | 80-84 | 81 | 103.2 | 153 | 23.0 | 7,439 | 217 | 114 | 80 | 7,850 | 9 | 8 | 17 | |
| 4 | 95-100 | 97 | 108.4 | 156 | 28.6 | 7,237 | 162 | 84 | 65 | 7,548 | 12 | 9 | 21 | |
| 2 | 110-110 | 110 | 130.7 | 166 | 30.1 | 6,195 | 241 | 88 | 44 | 6,568 | 20 | 10 | 30 | |
| 3 | 140-198 | 163 | 131.7 | 170 | 47.1 | 6,583 | 209 | 117 | 41 | 6,950 | 21 | 23 | 44 | |
| 2 | 206-262 | 234 | 166.7 | 184 | 51.9 | 5,659 | 141 | 83 | 24 | 5,909 | 47 | 27 | 74 | |
| 2 | 318-385 | 351 | 158.4 | 192 | 59.2 | 4,814 | 174 | 90 | 24 | 5,102 | 38 | 21 | 59 | |
| 1 | | 454 | 138.7 | 194 | 33.8 | 4,465 | 160 | 78 | 56 | 4,759 | 67 | 26 | 93 | |
| 1 | | 559 | 198.9 | 200 | 73.5 | 4,729 | 107 | 37 | 20 | 4,893 | 27 | 11 | 38 | |
| 1 | | 947 | 238.0 | 215 | 65.2 | 1,709 | 128 | 61 | 21 | 1,919 | 90 | 18 | 108 | |

Chart 2 shows two sharp drops; the first drop extends from four to twenty-three days and the second extends from sixty-three to seventy days, with a period of relative constancy between twenty-three and sixty-three days. The significance of these phases will be taken up later (p. 440).

Since the total number of ova includes ova of various sizes, I have attempted to analyze the general graph—chart 2—into its

components in order to throw some light on the growth of the several groups.

The graph for the number of ova with diameters less than 20μ would be nearly the same as that shown by the graph for the total number of ova, and has therefore not been drawn.

The form of the graph for the number of ova with diameters of 20 to 40μ , however, shows a slight difference. The number decreases rapidly from four days until twenty-three days, and then continues to decrease gradually till 947 days, the fluctuations in number being apparently due to individual variation.

The graph for the number of ova with diameters of 40 to 60μ increases rapidly from twelve days and reaches its maximum at twenty-three days. After twenty-three days it decreases again at first rapidly, then more gradually.

The graph for the number of ova with diameters more than 60μ shows a rapid decrease from twenty-three days to forty-three days. After forty-three days it shows but a very slight fall. It is to be noted that as the diameters of the ova increase, the age of their appearance advances.

We can obtain more clearly the relative growth of these groups of ova from table 4, in which the total number of ova is taken as the standard, and the numbers of ova of various sizes are represented as the percentages of this total. The percentage values of the number of ova with diameters less than 20μ range from 100 per cent to 88 per cent of the total throughout the entire span of life. Within these two limits there are numerous fluctuations, the reasons for which will be discussed later.

Taking the entire series from twenty days, when the largest follicles appear, to 559 days, the approximate age of the menopause, the average percentage values for the several classes of ova are—

| | | |
|----------------|---|---------------|
| Under 20μ | = | 95.0 per cent |
| 20 to 40μ | = | 2.7 per cent |
| 40 to 60μ | = | 1.5 per cent |
| Over 60μ | = | 0.8 per cent |

1. Immediately after birth both the absolute number of small ova, as well as their percentage values, decrease rapidly, reaching

TABLE 4

Percentage values of the number of the ova of various sizes to the total number of ova

| AGE | MEAN NUMBER OF OVA PER MILLIGRAM OF OVARY WEIGHT | THE PERCENTAGE VALUES OF GROUPS OF OVA | | | |
|------------------|---|--|-----------------|-----------------|--------------------|
| | | Less than 20 μ | 20 to 40 μ | 40 to 60 μ | More than 60 μ |
| <i>days</i> | | <i>per cent</i> | <i>per cent</i> | <i>per cent</i> | <i>per cent</i> |
| 1 | | 100.0 | | | |
| 3 | | 98.7 | 1.3 | | |
| 5 | | 96.2 | 3.8 | | |
| 7 | 1,166 | 95.4 | 4.6 | 0.0 | |
| 10 | 700 | 96.2 | 3.5 | 0.3 | |
| 15 | 661 | 95.0 | 3.0 | 2.0 | |
| 20 | 173 | 91.1 | 3.7 | 4.2 | 1.0 |
| 26 | 97 | 92.7 | 3.1 | 2.6 | 1.4 |
| 30 | 189 | 95.2 | 2.2 | 1.7 | 0.9 |
| 36 | 161 | 96.3 | 1.7 | 1.4 | 0.7 |
| 36 | 86 | 95.2 | 2.1 | 1.5 | 1.3 |
| 41 | 161 | 97.5 | 1.7 | 0.5 | 0.3 |
| 41 | 73 | 95.7 | 2.2 | 1.2 | 0.9 |
| 46 | 73 | 96.8 | 1.5 | 1.1 | 0.6 |
| 50 | 98 | 97.0 | 1.8 | 0.7 | 0.6 |
| 50 | 77 | 96.2 | 2.3 | 1.0 | 0.5 |
| 60 | 101 | 97.3 | 1.4 | 0.9 | 0.4 |
| 64 | 127 | 96.4 | 1.9 | 1.1 | 0.6 |
| 64 ¹ | 32 | 93.7 | 4.0 | 1.9 | 0.5 |
| 70 ¹ | 15 | 94.6 | 3.0 | 1.5 | 1.0 |
| 80 ² | 14 | 88.3 | 5.5 | 3.4 | 2.8 |
| 80 | 91 | 96.4 | 2.2 | 0.9 | 0.5 |
| 84 ¹ | 44 | 96.8 | 1.8 | 0.9 | 0.5 |
| 95 ² | 9 | 94.7 | 2.0 | 1.6 | 1.7 |
| 95 | 88 | 95.6 | 2.6 | 1.0 | 0.8 |
| 100 | 54 | 97.0 | 1.9 | 0.6 | 0.6 |
| 100 | 65 | 96.4 | 1.9 | 1.3 | 0.4 |
| 100 | 29 | 94.6 | 3.3 | 1.4 | 0.8 |
| 110 ¹ | 17 | 94.1 | 4.0 | 1.3 | 0.6 |
| 140 ¹ | 18 | 95.4 | 2.7 | 1.2 | 0.7 |
| 150 ¹ | 28 | 95.5 | 2.5 | 1.5 | 0.5 |
| 198 ¹ | 5 | 89.7 | 6.0 | 3.6 | 0.7 |
| 206 ² | 15 | 96.5 | 1.9 | 1.2 | 0.4 |
| 262 ¹ | 8 | 94.4 | 3.3 | 1.9 | 0.4 |
| 318 ¹ | 15 | 95.8 | 2.2 | 1.5 | 0.5 |
| 385 ¹ | 5 | 92.6 | 4.9 | 2.1 | 0.4 |
| 454 ¹ | 14 | 93.8 | 3.4 | 1.6 | 1.1 |
| 559 ² | 7 | 96.7 | 2.2 | 0.8 | 0.4 |
| 947 ¹ | 3 | 89.1 | 6.7 | 3.2 | 1.1 |

¹ Corpora lutea present.² Pregnant.

a minimum at about twenty days. This striking phenomena is associated with the rapid increase of the larger ova during this period. From twenty days up to about thirty-six days, the percentage value increases again, though the absolute number of the small ova is decreased, owing to the appearance of the larger ova (table 2). From thirty-six to sixty-four days the percentage values for the number of small ova are approximately constant. This is associated with slight numerical changes in the number of ova of all sizes.

2. Between 64 and 110 days, in those ovaries in which corpora lutea have not yet appeared, the percentage values of the small ova range from 94.6 per cent to 97 per cent. In the ovaries in which the corpora lutea have appeared, but excluding the pregnant animals, the number of small ova ranges from 93.7 per cent to 96.8 per cent, showing no change in the number of these cells in relation to the appearance of the corpora lutea.

3. From 140 to 947 days the corpora lutea are always present and the percentage values fluctuate about a mean value of 94 per cent, the very oldest rat giving 89 per cent. Therefore, generally speaking, the percentage values of the small ova (less than $20\ \mu$ diameters) remain constant in the older rats.

4. In the pregnant rats—four cases—we find the percentage values 95 to 97 per cent in three cases and 88 per cent in one, which is the youngest. For this unusual value we have no explanation.

From the foregoing it seems that the percentage values for the ova under $20\ \mu$ decrease rapidly from one day after birth till twenty days. This is followed by an increase of 4 per cent up to thirty-six days. From thirty-six days on to the end of the series the percentage values remain nearly constant (the four pregnant cases are not included in this general statement).

The number of ova 20 to $40\ \mu$ in diameter show percentage values which increase rapidly from three days up to seven days, at which age they reach a maximum of 4.6 per cent. This initial increase is followed by lower values up to sixty-four days, after which there is a slight tendency to higher percentages with advancing age.

The percentage values for the number of ova with diameters from 40 to 60 μ increase rapidly from ten days to twenty days, at which age they reach an absolute maximum. This in turn is followed by a rapid decrease till forty-one days.

From forty-one days on to 947 days the percentage values remain less than 2 per cent, except in three cases. There seems to be, however, a slight tendency for the percentage values in this group to increase in the older animals.

The ova more than 60 μ in diameter only once represent more than 2 per cent of the total and usually less than 1 per cent, so that no attempt is made to correlate the variations in their abundance with other changes.

In this table are the determinations for four pregnant rats. In the ovaries from a rat pregnant at eighty days the percentage values of all ova with diameters more than 20 μ are considerably higher than in the ovaries of non-pregnant rats, but in the remaining three cases this peculiarity does not appear. Whether this is a significant difference cannot at the moment be determined.

From table 4 it may be seen that in the ovaries in which corpora lutea are absent the mean number of ova per 0.1 mgm. of ovary weight tends to run inversely to the percentage value for the number of ova having a diameter of 60 μ or more, and a similar relation holds after the corpora lutea appear in the ovaries. It therefore follows that in the former cases the number of largest ova is in large measure responsible for the greater weight of ovary, while in the latter cases both the largest ova and the corpora lutea may be taken as the responsible factors.

It should be stated that in young ovaries there are also many larger ova with diameters 40 to 60 μ or more, though it is questionable whether these are mature because the layer of follicle cells is about three to four cells thick, and moreover the cavity is not yet formed. I am rather inclined to believe that these ova are in the first stage of degeneration rather than in a stage of development. After thirty days we find in the ovaries many well-developed follicles, which not only have a cavity, but many layers of follicle cells, and as in the mature follicles the cumulus

ovigerus is well developed. These follicles contain ripe ova, whose diameter is usually 60 to 66 μ . Sometimes we observe a very large ovum with a diameter of 76 μ or more, but such an ovum may be in an early stage of degeneration, because both the nucleus and cell body are not well stained, as in the case in the normally ripened ovum.

The numbers of the mature follicles and of largest ova in both ovaries are given in table 5.

As is shown in table 5, the number of the mature follicles is not strictly proportional to the number of the largest ova with

TABLE 5
The numbers of mature follicles and of largest ova in both ovaries

| AGE | NUMBER OF MATURE FOLLICLES | NUMBER OF LARGEST OVA | AGE | NUMBER OF MATURE FOLLICLES | NUMBER OF LARGEST OVA |
|------------------|----------------------------|-----------------------|------------------|----------------------------|-----------------------|
| <i>days</i> | | | <i>days</i> | | |
| 46 | 15 | 60 | 140 ¹ | 22 | 62 |
| 64 | 31 | 66 | 150 ¹ | 26 | 42 |
| 64 ¹ | 39 | 47 | 198 ¹ | 16 | 18 |
| 80 ² | 38 | 145 | 206 ² | 12 | 32 |
| 80 | 23 | 42 | 262 ² | 15 | 15 |
| 100 | 21 | 39 | 318 ² | 18 | 29 |
| 100 | 16 | 24 | 385 ² | 9 | 18 |
| 110 | 23 | 41 | 559 ² | 13 | 20 |
| 110 ¹ | 25 | 46 | 947 ¹ | 19 | 21 |

¹ Shows presence of corpora lutea.

² Stands for pregnancy.

a diameter of 60 μ and more. Nevertheless, if we consider the data from forty-six to one hundred days the number of largest ova are a little more than twice as numerous as the mature follicles, while in the remainder of the table they are a little less than twice. Thus there is a tendency for the proportion of largest ova to slightly diminish with age.

We notice also that in the rat from sixty-four to eighty days the number of mature follicles ranges from thirty-one to thirty-nine, and this large number of follicles may be related to the attainment of sexual maturity, since after eighty days the number of follicles tends to decrease. The mean number of these mature follicles in all eighteen cases is twenty-one.

3. *On the number of ova in relation to body weight*

The data on the number of ova have been arranged according to the increasing body weight and the results are shown in table 6 and chart 3. In order to eliminate the individual fluctuations as much as possible, I have averaged the data which belong to the rats whose body weights differ not more than 10 grams from one another. From this table the pregnant rats have been omitted, because the weight of the foetuses was not recorded and consequently the true body weight of these pregnant rats cannot be accurately estimated. When these average values are plotted, we obtain the graph shown in chart 3.

It is evident from table 6 and chart 3 that the total number of ova decreases rapidly from 5.5 grams—one day after birth—until about 33 grams, and then after remaining at about the same value till 64 grams, decreases again gradually up to 238 grams.

The corpora lutea appeared first in the ovary of a rat with a body weight of 102 grams, and all rats which possessed a body weight heavier than 102 grams invariably showed corpora lutea. The general form of the graph shown in chart 2 is as a whole similar to that shown in chart 3.

The graph showing the number of ova with diameters less than $20\ \mu$ is approximately similar to the graph which shows the variation of the total number, but the latter graph only has been drawn. The graph showing the number of ova in the three groups having diameters 20 to $40\ \mu$, 40 to $60\ \mu$, and over $60\ \mu$ are quite similar to the corresponding graphs based on age (chart 2) and do not call for special comments.

The number of the large corpora lutea is nearly the same 15 to 14 at 102 to 122 grams, but increases to a maximum (29), and then after 142 grams falls off slightly. Similarly, the number of smaller corpora is at first nearly constant, but increases markedly toward the end of the series (chart 3).

When we compare these graphs for the number of ova according to body weight (chart 3) with those according to age (chart 2), we find a slight difference in their form. At twenty-three days we find in table 3 a body weight of 26.9 grams and at sixty-

three days, 89.7 grams. If, now, chart 3 is examined, we see that between these body-weight limits the number of ova shows little change—just as it did between the corresponding age limits in chart 2. The fall in number after the body weight of 89.7 grams is, however, less marked in chart 3 than after sixty-three days in chart 2. This slight difference is due to the fact that

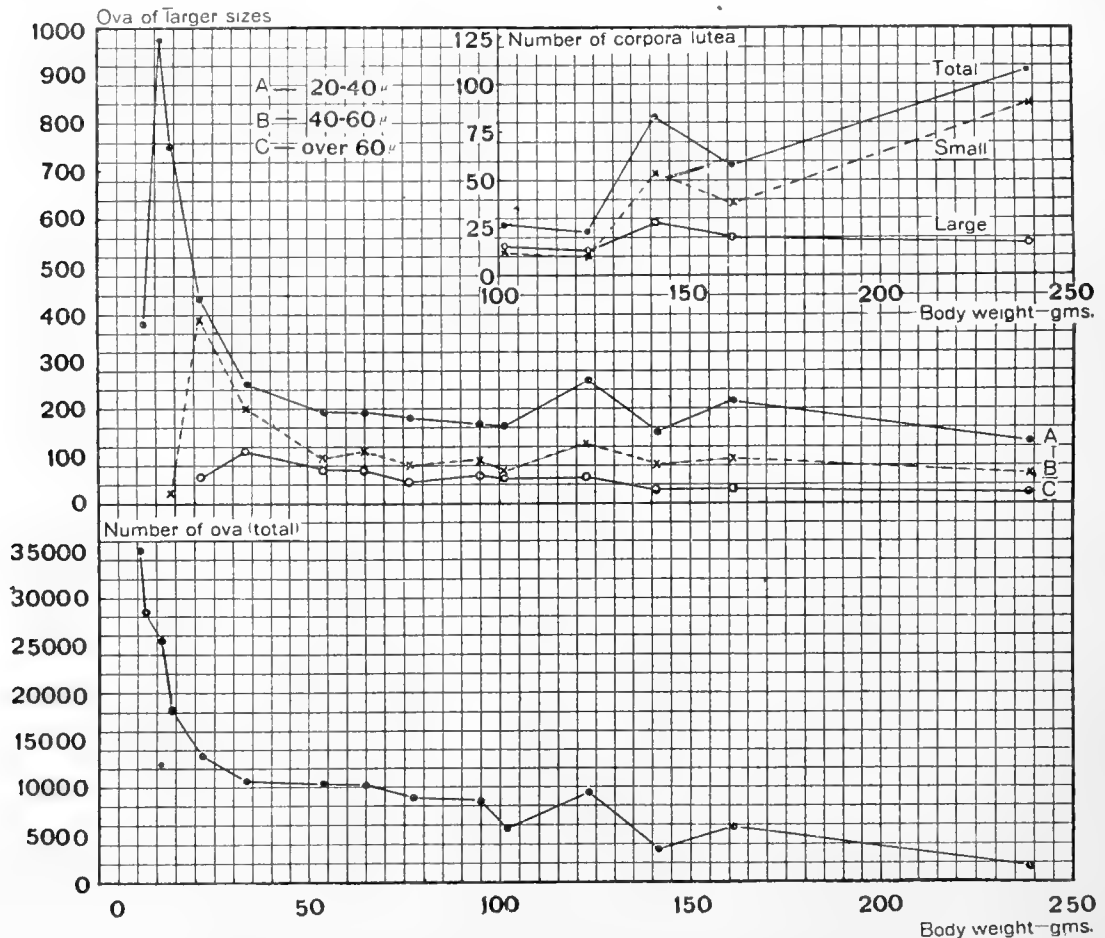

Chart 3 Graph showing the relation between the body weight and the total number of ova in both ovaries, together with the number of the corpora lutea and of the three groups of ova more than 20μ in diameter.

some of the older rats were ill nourished and small for their age. This is shown by table 7, in which the observed body weights for given ages are compared with the expected ages as recorded by Donaldson ('15).

As these figures show, the coincidence between the two series of ages is fair except for the last two body-weight groups. The animals in these groups were light for their age.

4. On the number of ova and the body length

I have arranged the number of ova according to the body length of the rats, and the results are given in table 8. Graphs

TABLE 6

The relation between the body weights and total number of ova in both ovaries; average number. From this table the pregnant rats were omitted

| NUM- BER OF RATS | INTERVAL OF BODY WEIGHT | BODY WEIGHT | WEIGHT OF BOTH OVA- RIES | NUMBER OF OVA | | | | | NUMBER OF CORPORA LUTEA | | |
|---------------------------|----------------------------|----------------|--------------------------------------|-----------------------|----------------|----------------|-----------------------|-------|----------------------------|-------|-------|
| | | | | Less than 20 μ | 20 to 40 μ | 40 to 60 μ | More than 60 μ | Total | Small | Large | Total |

Rats without corpora lutea

| | grams | grams | mgm. | | | | | | | | |
|---|-----------|-------|------|--------|-----|-----|-----|--------|--|--|--|
| 1 | | 5.5 | | 35,105 | | | | 35,105 | | | |
| 1 | | 7.3 | | 27,870 | 382 | | | 28,252 | | | |
| 1 | | 10.6 | | 24,608 | 978 | | | 25,586 | | | |
| 2 | 13.9-14.8 | 14.3 | 2.0 | 17,417 | 758 | 20 | | 18,195 | | | |
| 2 | 20.5-23.7 | 22.1 | 4.4 | 12,587 | 437 | 396 | 56 | 13,476 | | | |
| 3 | 30.2-34.9 | 33.3 | 7.7 | 10,105 | 251 | 202 | 113 | 10,671 | | | |
| 2 | 50.0-58.2 | 54.1 | 8.9 | 10,118 | 194 | 98 | 75 | 10,485 | | | |
| 3 | 61.9-69.5 | 64.7 | 11.9 | 9,812 | 191 | 114 | 72 | 10,189 | | | |
| 4 | 74.8-78.3 | 76.5 | 10.6 | 8,545 | 183 | 81 | 45 | 8,854 | | | |
| 3 | 93.5-98.5 | 95.4 | 13.8 | 8,522 | 167 | 92 | 56 | 8,837 | | | |

Rats with corpora lutea

| | | | | | | | | | | | |
|---|-------------|-------|------|-------|-----|-----|----|-------|----|----|-----|
| 2 | 97.8-106.3 | 102.0 | 32.0 | 6,549 | 165 | 71 | 52 | 6,837 | 12 | 15 | 27 |
| 4 | 113.5-129.5 | 122.8 | 33.8 | 9,031 | 260 | 131 | 51 | 9,473 | 10 | 14 | 24 |
| 3 | 138.7-145.0 | 142.1 | 46.9 | 3,490 | 150 | 83 | 30 | 3,753 | 54 | 29 | 83 |
| 3 | 155.0-167.1 | 161.1 | 53.6 | 5,640 | 218 | 94 | 31 | 5,983 | 39 | 20 | 59 |
| 1 | | 238.0 | 65.2 | 1,709 | 128 | 61 | 21 | 1,919 | 90 | 18 | 108 |

have been made for these data also, but they show relations which in all respects are so similar to those obtained when the data are plotted on body weight that they are now omitted. It is to be noted that when rats reach a body length of 148 mm. ovulation occurs almost invariably, as shown in tables 2 and 8, and I shall take up this point in the discussion.

TABLE 7
Data on body weight according to age

| BODY WEIGHT OF RATS (AVERAGED IN GRAMS) (OBSERVED) | THE AGE OF RATS (AVERAGED IN DAYS) (OBSERVED) | THE STANDARD AGE IN DAYS CORRESPONDING TO BODY WEIGHT (DONALDSON, '15) |
|--|--|--|
| 5.5 | 1 | 1 |
| 22.0 | 18 | 21 |
| 33.0 | 31 | 32 |
| 64.0 | 50 | 53 |
| 95.0 | 88 | 68 |
| 102.0 | 85 | 72 |

TABLE 8
The relation between the body length and the number of ova in both ovaries; average numbers

| NUMBER OF RATS | INTER- VAL OF BODY LENGTH | BODY LENGTH | WEIGHT OF BOTH OVA- RIES | NUMBER OF OVA | | | | | NUMBER OF CORPORA LUTEA | | |
|----------------------------|------------------------------------|----------------|-----------------------------------|-----------------------|----------------|----------------|-----------------------|-------|----------------------------|-------|-------|
| | | | | Less than 20 μ | 20 to 40 μ | 40 to 60 μ | More than 60 μ | Total | Small | Large | Total |
| Rats without corpora lutea | | | | | | | | | | | |
| | <i>mm.</i> | <i>mm.</i> | <i>mgm.</i> | | | | | | | | |
| 1 | | 47 | | 35,105 | | | | | 35,105 | | |
| 1 | | 52 | | 27,870 | 382 | | | | 28,252 | | |
| 1 | | 60 | | 24,608 | 978 | | | | 25,586 | | |
| 2 | 69-76 | 73 | 2.0 | 17,417 | 758 | 20 | | | 18,195 | | |
| 2 | 83-89 | 86 | 4.4 | 12,587 | 437 | 396 | 56 | | 13,476 | | |
| 2 | 95-105 | 100 | 8.2 | 9,187 | 237 | 200 | 112 | | 9,736 | | |
| 2 | 108-122 | 115 | 8.6 | 10,252 | 232 | 173 | 113 | | 10,770 | | |
| 3 | 128-132 | 130 | 9.4 | 10,391 | 207 | 95 | 65 | | 10,758 | | |
| 5 | 138-145 | 142 | 11.1 | 8,718 | 168 | 91 | 43 | | 9,020 | | |
| 3 | 146-148 | 147 | 14.1 | 8,697 | 216 | 86 | 64 | | 9,063 | | |
| Rats with corpora lutea | | | | | | | | | | | |
| 2 | 153-156 | 155 | 28.7 | 5,754 | 211 | 111 | 92 | 6,168 | 21 | 10 | 31 |
| 4 | 162-168 | 168 | 36.6 | 8,438 | 254 | 121 | 56 | 8,869 | 7 | 15 | 22 |
| 2 | 171-171 | 171 | 45.3 | 5,544 | 193 | 119 | 30 | 5,886 | 26 | 25 | 51 |
| 4 | 182-185 | 184 | 54.7 | 6,218 | 179 | 94 | 51 | 6,542 | 42 | 22 | 64 |
| 4 | 189-200 | 194 | 56.6 | 4,706 | 154 | 74 | 31 | 4,965 | 43 | 20 | 63 |
| 1 | | 215 | 65.2 | 1,709 | 128 | 61 | 21 | 1,919 | 90 | 18 | 108 |

If we compare the body lengths of the rats here employed with those for the standard values given by Donaldson ('06), we obtain the following relations (table 9).

This shows the larger rats to be short for their age—a relation which would naturally follow from those found in table 7 for the body weights.

5. *On the number of ova and the weight of the ovaries*

The numbers of ova have been arranged according to the observed weight of both ovaries, in order to examine the relationship between these two characters (table 10). For convenience the data on the weights of the ovaries were divided into two

TABLE 9
Relations of body length on age

| BODY LENGTH AVERAGED | AVERAGE AGE | STANDARD AGE CORRESPONDING TO THE BODY LENGTH |
|----------------------|-------------|---|
| <i>mm.</i> | <i>days</i> | <i>days</i> |
| 47 | 1 | 0 |
| 100 | 31 | 29 |
| 147 | 85 | 61 |

groups: *a*) the ovaries without corpora lutea and, *b*) the ovaries with corpora lutea.

We find rather high individual variations in this relation, as indicated in table 2. However, table 10 shows that when the weight of the ovaries reaches from 1.8 to 2.2 mgm., the ova 40 to 60 μ in diameter are present, and in the ovaries of 2.4 to 5.6 mgm. the ova with diameter of more than 60 μ are found. It is again to be noted that the first corpora lutea are seen in ovaries which weigh 20 mgm., and therefore in the ovaries which weigh more than 20 mgm., the relation between the number of ova and the weight of ovaries becomes highly complex, owing to the appearance of corpora lutea, the number and size of which are the most important factors in modifying the weight of the ovaries.

We notice from chart 4—based on table 10—that the number of ova falls steadily up to an ovary weight of 6.5 mgm. This is

followed by a period of approximate constancy up to an ovary weight of 16.5 mgm., the end of the period preceding the appearance of the corpora lutea. This stage, marked by a break in the graph, passes into the stage in which the corpora lutea appear, and after the appearance of the corpora lutea the graph

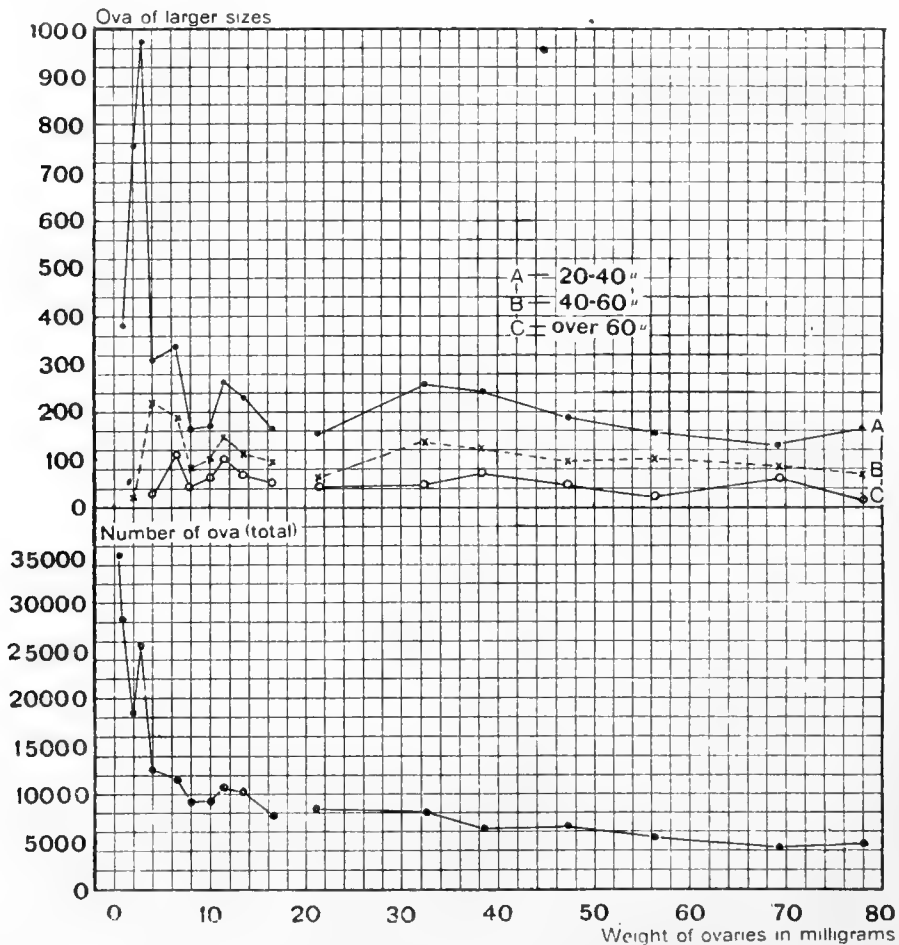

Chart 4 Graph showing the relation between the weight of both ovaries and the total number of ova, together with those of the three groups more than 20μ in diameter. The graphs are broken after puberty.

for the total number of ova falls very slowly to the end of the record. The several graphs for the number of ova more than 20μ in diameter are very similar in form to the corresponding graphs in chart 3 and are subject to a like interpretation.

It may be appropriate, however, to call attention here to the relations of the various groups of larger ova. In the first place, all the larger ova are derived from small ova. Moreover, the

arrangement in groups is for convenience merely, and they represent in reality a continuous series. It follows from this that the groups of smallest diameter should be the first to appear and

TABLE 10

The relation between the weight of both ovaries and the number of ova; average number

| NUMBER OF RATS | INTERVAL OF OVARY WEIGHT | WEIGHT OF BOTH OVARIES | BODY WEIGHT | NUMBER OF OVA | | | | | NUMBER OF CORPORA LUTEA | | |
|----------------------------|--------------------------|------------------------|--------------|--------------------|----------------|----------------|--------------------|-------|-------------------------|-------|-------|
| | | | | Less than 20 μ | 20 to 40 μ | 40 to 60 μ | More than 60 μ | Total | Small | Large | Total |
| Rats without corpora lutea | | | | | | | | | | | |
| | <i>mgm.</i> | <i>mgm.</i> | <i>grams</i> | | | | | | | | |
| 1 | | 0.6 ¹ | 5.5 | 35,105 | | | | | 35,105 | | |
| 1 | | 1.0 ¹ | 7.3 | 27,870 | 382 | | | | 28,252 | | |
| 1 | | 3.3 ¹ | 10.6 | 24,608 | 978 | | | | 25,586 | | |
| 2 | 1.8-2.2 | 2.0 | 14.3 | 17,417 | 756 | 20 | | | 18,195 | | |
| 2 | 2.4-5.6 | 4.0 | 27.4 | 11,897 | 311 | 224 | 31 | | 12,463 | | |
| 2 | 6.4-6.7 | 6.5 | 29.2 | 11,015 | 341 | 189 | 114 | | 11,659 | | |
| 3 | 7.4-8.8 | 8.0 | 66.5 | 8,958 | 168 | 80 | 42 | | 9,248 | | |
| 3 | 9.4-10.4 | 10.0 | 73.6 | 8,999 | 174 | 102 | 65 | | 9,340 | | |
| 3 | 10.8-12.2 | 11.5 | 67.8 | 10,216 | 265 | 153 | 104 | | 10,740 | | |
| 2 | 12.9-14.0 | 13.5 | 68.7 | 9,760 | 233 | 110 | 70 | | 10,173 | | |
| 2 | 14.0-18.9 | 16.5 | 81.9 | 7,517 | 166 | 95 | 51 | | 7,829 | | |
| Rats with corpora lutea | | | | | | | | | | | |
| 2 | 20.1-22.2 | 21.2 | 111.4 | 8,129 | 155 | 64 | 46 | 8,394 | 9 | 9 | 18 |
| 3 | 31.1-33.8 | 32.5 | 127.2 | 7,508 | 260 | 135 | 48 | 7,951 | 31 | 23 | 54 |
| 3 | 36.5-41.6 | 38.5 | 143.1 | 5,802 | 241 | 122 | 73 | 6,238 | 40 | 16 | 56 |
| 3 | 43.8-49.2 | 47.3 | 124.8 | 6,147 | 189 | 94 | 47 | 6,477 | 27 | 23 | 50 |
| 2 | 54.8-58.1 | 56.4 | 165.6 | 5,125 | 159 | 99 | 25 | 5,408 | 33 | 27 | 60 |
| 2 | 65.2-73.5 | 69.4 | 199.0 | 3,987 | 129 | 85 | 66 | 4,267 | 61 | 16 | 77 |
| 2 | 73.5-82.6 | 78.0 | 180.1 | 4,449 | 164 | 65 | 19 | 4,697 | 26 | 18 | 44 |

¹ Ovary weights were taken from 'The Rat' for the observed body weights.

the other groups follow, in time of appearance, in the order of their size.

Table 10 and chart 4 show that this is what occurs. Further, at the time of first appearance any group is represented by only a small number and the appearance of the next group coincides with the maximum number in the group just preceding. The

group with the smallest diameter (20 to 40 μ) is most subject to degeneration, for the numbers in it fall most rapidly and continuously. The group with the largest diameter (more than 60 μ) is most constant in number. This relation does not necessarily mean that these largest ova persist for any long period, but merely that the balance between their formation and degeneration is rather evenly maintained.

The first phase of the graph for the entire number of ova may be interpreted as due to the fact that during this phase many primitive germ cells are growing rapidly, yet at the same time an excess of cells is undergoing degeneration, so that the number falls rapidly.

From 8 up to 16.5 mgm. in ovary weight the enlargement of newly formed definitive ova is mainly responsible for the increase in the weight of the ovaries, containing a nearly constant number of ova. All the groups of ova more than 20 μ in diameter behave in much the same manner. After such ova are first recognized there is a short period in which they increase in number, followed in each group by a more or less pronounced decrease to the end of the series. On the whole, then, the total number of ova decreases according as the ovaries grow in weight, and in the first phase this decrease is very rapid, but from a weight of 6.5 mgm. it becomes much slower.

The number of ova less than 20 μ in diameter is not plotted on this chart, but, as table 10 shows, it would give a curve practically identical with that for the total number.

The comparison of my own data on the weights of the ovaries with those given by Donaldson ('15) shows the following relations according to age (table 11).

So far as the critical periods for the data are concerned, there is good agreement between the two determinations in table 11, but the last entry indicates that my animals were somewhat retarded. The data show that the weights of the ovaries hold an inverse relation to the number of ova, that is, the heavier the ovaries the fewer are the ova in them. This inverse relation may be due in part to the formation of the interstitial tissue, but depends mainly on several other factors, such as the corpora lutea, the number of well-developed follicles, degenerate follicles, etc.

DISCUSSION

The various topics will be discussed in the order in which the data have just been presented.

1. *Comparison of the weights of the ovaries and the number of ova on the right and left sides*

The data in table 1 show that the right ovary has, as a rule, only nine-tenths the weight of the left, but nevertheless contains the same (or a slightly greater) number of ova.

TABLE 11
The weights of both ovaries with ages

| THE WEIGHT OF BOTH OVARIES | THE AGE CORRESPONDING TO THESE AVERAGE OVARY WEIGHTS IN DAYS (MY OBSERVATION) | THE AGE CORRESPONDING TO THESE AVERAGE OVARY WEIGHTS IN DAYS (DONALDSON, '15) |
|----------------------------|---|---|
| <i>m gm.</i> | | |
| 6.5 | 25 | 26 |
| 10.0 | 59 | 55 |
| 11.5 | 57 | 57 |
| 21.2 | 92 | 67 |

It is interesting to note further that, so far as my observations go, the corpora lutea appear simultaneously in both ovaries when these reach the weight of more than 10 mgm. (for one ovary). They are not present earlier (table 1), and in no case do they appear on one side only. Sobotta ('10) found that, as a rule, in albino rats the mature ova are discharged at the same time from both ovaries.

We might expect this relation in other mammals which normally produce two or more young at a birth, but we have not found any observations on this point.

It is usually stated that in man only one ripe ovum at a time is discharged from either of the ovaries, and therefore in man the corpus luteum should appear on one side only. Whether the left or right human ovary supplies most of the ova or whether both ovaries give off the same number is not known. One striking relation worth emphasizing here is that variations in the

numbers of ova tend to be similar in both ovaries, even in the cases where the total number is markedly low (see 198 day rat in table 1 as the extreme instance), Approximate equality is also found for the numbers of ova on the right and left sides if the means of the values for the low records at 80, 100, 110, 198, and 262 days are compared. These are: right ovary 2223 and left ovary 2357.

The growth of ovary in weight according to age

The growth of the ovary of the albino rat after birth has been studied by Jackson ('13) and Hatai ('13, '14), and it shows several phases. Jackson, who constructed a chart showing the relative weight of ovaries on body weight, pointed out two of these; the first phase beginning at birth showing an increase to a maximum at a body weight of 10 to 15 grams, followed by a decrease up to a body weight of 60 grams. At 60 grams a second period of acceleration, which corresponds to the advent of puberty, begins, and during this phase the ovaries increase to a second maximum at 110 to 120 grams in body weight. After this the relative weight steadily decreases. To make a comparison with Jackson's results I have prepared table 12.

This shows that according to my data the relative weight of ovaries increases to the first maximum at a body weight of 22 to 33 grams, and then decreases gradually until a body weight of 95 grams. After 95 grams the curve rises rapidly at 102 grams in body weight. About this time corpora lutea appear in the ovaries, and the maximum relative weight is reached at a body weight of 142 to 161 grams, after which it decreases. In general the two sets of observations agree.

The disagreement in the exact periods of the maxima between Jackson's data and my own may be caused by the smaller number of rats (thirty-nine) used by me. The explanation as to the true significance of the two maxima is difficult, especially the first maximum, owing to the complexity of the factors which enter into the growth of ovaries, such as the enlargement of follicles, the increase of stroma tissue, etc. The cause for the second maximum may be interpreted as follows:

According to Donaldson ('15), the corresponding ages for the body weight of 110 to 120 grams in the female albino rat is about seventy-five to eighty days, and as ovulation has occurred at this age fresh corpora lutea are already present. According to Jackson, ovulation, that is the age of puberty, takes place at seventy

TABLE 12

The relation between the body weight and the weight of both ovaries; average number

| NUMBER OF RATS | INTERVAL OF BODY WEIGHT | AGE | BODY WEIGHT | OBSERVED WEIGHT OF BOTH OVARIES | WEIGHT OF BOTH OVARIES IN MILLIGRAMS ACCORDING TO BODY WEIGHT (DONALDSON) | PERCENTAGE WEIGHTS OF OVARIES ON BODY WEIGHT OBSERVED |
|----------------------------|-------------------------|-------------|--------------|---------------------------------|---|---|
| Rats without corpora lutea | | | | | | |
| | <i>grams</i> | <i>days</i> | <i>grams</i> | <i>mgm.</i> | | |
| 1 | | 1 | 5.5 | | 1.1 | |
| 1 | | 3 | 7.3 | | 2.0 | |
| 1 | | 5 | 10.6 | | 3.4 | |
| 2 | 13.9-14.8 | 9 | 14.3 | 2.0 | 4.3 | 0.014 |
| 2 | 20.5-23.7 | 18 | 22.1 | 4.4 | 5.8 | 0.020 |
| 3 | 30.2-34.9 | 31 | 33.3 | 7.7 | 7.2 | 0.023 |
| 2 | 50.0-58.2 | 39 | 54.1 | 8.9 | 8.9 | 0.016 |
| 3 | 61.0-69.5 | 50 | 64.7 | 11.9 | 9.4 | 0.018 |
| 4 | 74.8-77.3 | 70 | 76.5 | 10.6 | 13.2 | 0.014 |
| 3 | 93.5-98.5 | 88 | 95.4 | 13.8 | 24.7 | 0.014 |
| Rats with corpora lutea | | | | | | |
| 2 | 97.8-106.3 | 85 | 102.0 | 32.0 | 31.4 | 0.031 |
| 4 | 113.5-129.5 | 110 | 122.8 | 33.8 | 43.9 | 0.027 |
| 3 | 138.7-145.0 | 305 | 142.1 | 46.9 | 46.2 | 0.033 |
| 3 | 155.0-167.1 | 271 | 161.1 | 53.6 | 47.4 | 0.033 |
| 1 | | 947 | 238.0 | 65.2 | 50.0 | 0.027 |

From this table the pregnant rats were omitted.

days. In my rats, however, the age of seventy days is represented by a rapid increase in the weight of the ovaries, but they have not yet attained their maximum. Consequently the second maximum of Jackson, or the period of rapid increase, would be caused principally by the formation of a number of corpora lutea in the ovaries.

We have seen that in general the weight of ovaries in which the corpora lutea are not present increases with the growth of the rat, either in body weight or body length. With the appearance of the corpora lutea the weight of the ovaries becomes more fluctuating, owing perhaps to individual variations in the addition of the corpora lutea.

Thus these fluctuations just noted may have no meaning except as showing a greater variation in the growth rate of the ovary at this period. Even when the weights of the ovaries found by myself and those given by Donaldson are arranged according to the increasing body length, the results show a high degree of similarity to those which were arranged according to increasing body weight (table 11). My observations show that with the appearance of corpora lutea there is a sudden increase in the weight of the ovaries, and we may infer, therefore, that the increase in the weight of ovaries with increasing body weight, as noted in 'The Rat,' chart 21, is also due to the same cause.

In woman the ovaries are said to atrophy after the menopause, so the weight of ovaries might show a decrease after this event. Such weight alterations, as well as the period at which the maximum weight is attained, are not recorded in the literature. It would therefore be of interest to extend these observations to human ovaries.

We may now summarize the various factors which are responsible for the increase in the weight of the ovaries. In addition to the formation and enlargement of the individual ova, these are the growth of interstitial tissue, the number of the mature follicles; of degenerated follicles, small or large; of corpora lutea, fresh or old, as well as the content of blood. The exact amount of blood, however, has not been determined, yet it is worth while to note here that either a hyperaemic or anaemic state is recognizable according to the different physiological states of the ovary in relation to heat.

On the number of ova in relation to age

As was stated earlier, the total number of ova is greatest during the first days after birth, some ovaries containing as many as 35,105 ova. This number, however, decreases rapidly with increase of the ovaries in weight until it drops to about 11,000 at twenty days. From twenty-three days to sixty-three days the total number of ova varies only slightly—that is, from about 11,000 to 10,000. At about sixty-three days ovulation appears. The number of ova then decreases at first rapidly from about 10,000 at sixty-three days to about 2,000 at 947 days. The variation in the total number of ova according to increasing ages is different from that in most other organs of the rat, as, for instance, in the brain, in which the number of cells not only increases during the earlier period of growth, but soon becomes nearly constant, the individual neurons persisting for the most part throughout the entire span of life.

The progressive changes in the form of the graph (chart 2) at the different periods seem to be related to several factors, such as the new formation of ova, their degeneration, etc., and I wish to discuss these factors now.

The new formation and the degeneration of ova

According to Kingery's observation on the white mouse ('17), the proliferation of cells from the germinal epithelium does not take the form of tubular down-growth, but the cells are grouped in irregular masses just beneath the epithelium. The cell masses are made up of oocytes and indifferent cells or future follicle cells. In the course of development some of the flattened adjacent epithelial cells completely surround the oocyte which is still in the germinal epithelium. As growth proceeds, the other cells of the germinal epithelium extend up over this oocyte in its primary follicle, which is in this manner left behind in the tunica albuginea under the epithelium, and thus gradually passes through the tunica to reach the stroma beneath.

Since my study was concerned principally with the ova number and not with questions of the oogenesis, I am not prepared

to discuss Kingery's statement concerning the proliferation of the germ cells from the germinal epithelium in foetal life. However, in the ovaries of albino rats after birth the manner of the proliferation of germ cells appears to be similar to that described by Kingery. In my case the oocytes from the germinal epithelium begin to form at about ten to fifteen days after birth. The nuclei are large relatively to the cell body, nearly filling the cell, which begins to grow and enlarge in situ in the germinal epithelium. The shape of these cells is at first more or less spherical, and they are larger than the other epithelial cells. As they enlarge, the adjacent epithelial cells are crowded to either side, and when the development of the egg cells proceeds further, they are enclosed by the flattened epithelial cells, thus forming the primary follicle.

At this time the layer of tunica albuginea appears to be single or double, but as the development proceeds the follicles pass through the tunica albuginea into the stroma. This new formation continues with the growth of the ovaries, and the number of the follicles thus formed may reach its maximum at the period of puberty.

After puberty this process of new formation may yet continue, but is not as active as before puberty. Within the first ten days after birth this proliferation of new egg cells cannot usually be seen.

According to Kingery, in the mouse the cavity in the larger follicles begins to appear between fifteen and eighteen days after birth and a degeneration of the egg cells sets in at about the same time. In the albino rat the cavity in the large-sized follicles begins to appear at about twenty-days after birth, and at about twenty-six days the middle-sized degenerating follicles, according to my classification, are to be seen.

Kingery stated that the formation of egg cells from epithelium is most rapid from three to twenty-five days after birth and that it goes on practically up to sexual maturity, although more slowly in the later part of this period. It is completed at forty or forty-five days after birth, at which age, as a rule, female mice are sexually mature.

My own observations on the rat naturally show some slight difference in the age periods from those given by Kingery. In the rat the first appearance of the newly formed follicles is at about ten days after birth, and their number increases until about sixty to seventy days, at which age as a rule ovulation occurs; but this process continues at least to the age of one year, though not as rapidly as before.

The problem as to the origin of the definitive ova is not yet definitely settled. Some authors, Jenkinson ('13), Kirkham ('16), d'Hollander ('04), and Sonnenbrodt ('08), stated that the definitive ova are formed from the primordial germ cells, though some observers, Dustin, Karchakewitsch, Allen and Skrobansky (cited from "Oogenesis in the white mouse," '17), Winiwarter and Sainmont ('08), consider that the primordial germ cells mainly degenerate, and thus, as the rule, the definitive ova cannot be produced from these. Kingery holds the opinion that the definitive ova are developed from the primary follicles formed after birth, but he did not state clearly the relation between the primordial germ cells of other authors and the definitive ova of his own designation.

There is not much literature on the new formation of the egg cells after birth. Van Beneden ('80) described in the adult bat the egg cells as formed from the germinal epithelium. Lane-Clayton ('05), in the ovary of the rabbit, concluded that the follicle cells and the interstitial cells are formed from the germinal epithelium. These interstitial cells, from their origin, are potential egg cells, and under the proper stimulus, are capable of developing into ova. Von Winiwarter and Sainmont ('08) stated that in the cat, at about the age of three and one-half to four months, a renewal of the activity (the third proliferation) of the germinal epithelium produces a new supply of germ cells which develop into the definitive ova, when all the egg cells of the first (embryonic) and second (shortly after birth) proliferations have degenerated; and he stated further ('08) that these definitive ova come either entirely from the third proliferation or partly from it and partly from the undifferentiated cells left over from the second proliferation.

Kingsbury ('13) inclines to the opinion that there is no evidence of a new formation of ova by the third proliferation of Winiwarter and Sainmont. Van der Stricht ('11) does not discuss at all the new formation of ova, but simply states that in the adult ovary in cats the definitive ova are derived from the second proliferation. Felix ('12), in describing the development of the ovary in man, states that after the tunica albuginea is formed, in embryos of 180 mm. in length, no egg cells can be added to the interior of the ovary from the epithelial layer, and thus, according to this author, there is no possibility of a new formation of ova from the germinal epithelium.

Kingery ('17), in his studies on the white mouse, states that there is a new formation of germ cells after birth, and that the definitive ova come from the primary follicles. Briefly put, Kingery believes that at birth all the cells of the germinal epithelium seem equally capable of developing into oocytes, follicle cells or epithelial cells, though it is not evident just what factors are responsible for their eventual fate. As the ovary becomes more mature and the cells better differentiated, this potentiality of the cells of the germinal epithelium is lost, and after sexual maturity no more egg cells or follicle cells are derived from the epithelium.

He states also that all the egg cells of the first or embryonic proliferation in the mouse undergo degeneration and disappear. In ovaries of mice, from about seventeen days after birth up to sexual maturity, and at the adult stage, egg cells in their follicles may be seen in various stages of degeneration and atresia.

This is the evidence, of course, that a large number of these germ cells of embryonic origin degenerate and are resorbed. The degeneration of the definitive ova, which in all likelihood sets in before sexual maturity, is continued through the whole sexual life of the individual, as is well known. Since, then, a large number of definitive ova degenerate, and since these are situated more superficially than the primitive germ cells, which are mostly degenerated, it seems reasonable to conclude that all the primitive germ cells degenerate and are resorbed, and that all the definitive ova arise after birth from the germinal epithelium.

From these references we see how diverse are the opinions regarding the new formation of the oocytes; Van Beneden, Lane-Clayton, Winiwarter and Sainmont believing in a new formation of ova after birth in some mammals, and Van der Stricht considering the definitive ova to be developed from the second proliferation of the germinal epithelium, meaning probably a new formation of ova after birth. On the other hand, Kingsbury and Felix find no evidence of the new formation after birth. Lastly, Kingery concludes after birth that a new formation of ova occurs from the germinal epithelium and these in turn form the definitive ova.

As far as my observations go, the new formation of germ cells from the germinal epithelium occurs at ten to fifteen days after birth, and this new formation is much more active in the period from fifteen to sixty days—i.e., up to puberty—but after puberty the process becomes slow, differing from that found in the mouse.

Thus my own observations on the rat agree with the observation of Kingery that there is a new formation of the germ cells from which the definitive ova originate.

In chart 2 the total number of ova, which include the primitive germ cells, formed in embryonic life, and the definitive ova, so-called second postnatal proliferation of the germ cells from the germinal epithelium, are shown, but it would be impossible to determine the relative number of the primitive germ cells and the definitive ova, owing to the lack of structural characters differentiating these two kinds of ova, at a glance, while counting.

In chart 2 also two characteristic features are shown between four and sixty-three days, and I have attempted to interpret these in the following way:

From four days after birth the total number of ova decreases very rapidly up to twenty-three days. This rapid decrease is probably due to the degeneration and resorption of the primitive germ cells. But even during this period of rapid fall the formation of the new germ cells is going on since these are found from ten days of age. However, on account of the much greater number of the degenerating cells, the graph inevitably shows a rapid

fall. Following this rapid fall, the next period is represented by one of constancy from about twenty-three up to about sixty-three days. This period of constancy may be due to a balance between the degenerating cells on one hand and the newly formed germ cells on the other. Among the degenerating germ cells may be some of the germ cells of the second proliferation besides the primitive germ cells, and, though lacking evidence, I am inclined to believe that at this time the majority of the primitive germ cells have already disappeared.

The statements made by Winiwarter and Sainmont and by Kingery that all primitive germ cells are degenerated, and the view of the two former investigators that all of the second proliferated germ cells have disappeared, may very likely apply to this prepubertal period in the rat as mentioned above.

Following this period of constancy, the curve again shows a rapid decrease up to seventy days. Since during this period the corpora lutea begin to appear, we may assume that at this period also the cells are degenerating rapidly. Although even after puberty there is some new formation of oocytes, the sudden decrease in the number of ova must be due to a great excess of the degenerating cells.

Following this second rapid fall, the curve now shows a gradual decrease up to 947 days, though there occur some slight fluctuations, probably merely individual, especially at the earlier period. We may safely state that, though some few ova might be newly formed, the decrease in the total number of ova is due to the degeneration of the germ cells which represent those of the second proliferation.

I wish to emphasize the fact that the degeneration of the primitive germ cells begins from one day after birth and continues up to about sixty-three days, at which time all of the primitive ova may disappear completely—a result which in general agrees with the observation of Kingery.

Chart 2 also shows that the larger oocytes are relatively more numerous at an earlier age than at puberty.

This relation may indicate that the primitive ova before puberty, especially at the earlier period, enlarge rapidly, and before

ripening may undergo degeneration and be resorbed. From thirty days on the proliferated definitive ova are added to the primitive germ cells which are already present, and thus the definitive ova are very few at first, but increase rapidly concomitantly with the degeneration of the primitive germ-cells. This process maintains an approximately constant number of the larger oocytes, and this continues with more or less fluctuation up to 947 days.

The effect of pregnancy on the total number of ova is given in table 4, but the number of instances is too small to furnish a basis for any general statement.

Stratz ('98) considers that during pregnancy there are small follicles which become atretic before they can develop, and only toward the end of pregnancy the follicles begin to grow to a considerable size and come to maturity. On the other hand, Loeb ('11) maintains that while some of the large follicles degenerate, the small, medium, and some of the large follicles also remain without degeneration in the last days of pregnancy.

According to my own observations, the condition of the follicles as a whole agrees with part of the statements given by the two authors mentioned above, though differing in detail. During pregnancy in young rats the small follicles are few compared with the medium and large follicles. In the later stages of pregnancy in older rats the relative number of small follicles increases considerably (table 4), while the numbers of the medium and large-sized follicles are considerably reduced when compared with those found in non-pregnant rats of about the same age.

We infer from these facts that in pregnancy in older rats the majority of the medium and large-sized follicles have degenerated. However, this statement is based on a limited number of cases, and, in addition, cytological studies on the cells were not made, so that no great emphasis can be put on the conclusion. It is my hope to continue the study on these problems in the future.

On the weight of the ovaries and the presence of corpora lutea and of degenerate follicles

The graph for the number of ova which illustrates the group in which the ovaries possess the corpora lutea, gradually falls, with some fluctuations, from 21.3 to 78 mgm. in the weight of the ovaries (chart 4).

The two graphs which illustrate the numbers of corpora lutea show rather considerable fluctuations, but indicate that the number of small, increases more rapidly than the number of large corpora lutea—a result which is in accord with expectation. In this (b) group, then, the relation between the weight of ovaries and the ova number is also inverse, though it is not so striking as in the (a) group, and the inverse relation is due in some measure to the appearance of the corpora lutea.

It is desirable now to discuss the influence which the number of degenerate follicles may have on the weight of the ovaries. Previously it was mentioned that an effort had been made to divide the degenerate follicles into four groups (p. 409).

However, on account of the great difficulty in making even an approximate estimate of the number of the small degenerated follicles, I have not attempted to record these in the table. For convenience, the number of the C and D types of my classification, or those which correspond to large degenerated follicles, and the B type, or the middle-sized degenerated follicles, are grouped together and the results given in table 13.

Table 13 suggests that in the rat before puberty the weight of ovaries, in which the large degenerated follicles are the more numerous, tend to be greater than that of the ovaries in which these are less numerous. After puberty, though the similar relation seems to hold, nevertheless the presence of the corpora lutea obscures the relation. Generally speaking, in the ovaries of young rats (twenty-six days old) before the corpora lutea are formed, we find a considerable number of large degenerated follicles.

From table 13 it is clear that before the formation of the corpora lutea the number of these follicles decreases slowly with the

increase in the weight of both ovaries. When the corpora lutea do appear, the number of large degenerated follicles remains about the same (namely, twenty-seven) from sixty-seven up to 133 days, but after that period is reduced to about half, namely, fifteen, and this value is maintained up to 506 days. At 947 days, however, the number of large degenerated follicles becomes only

TABLE 13

The relation between the weights of both ovaries and the middle-sized and large degenerate follicles, arranged by age in days; the average number

| NUMBER OF RATS | INTERVAL OF AGE | AGE | WEIGHT OF BOTH OVARIES | NUMBER OF DEGENERATE FOLLICLES | | |
|----------------------------|-----------------|-------------|------------------------|--------------------------------|-------|-------|
| | | | | Middle | Large | Total |
| Rats without corpora lutea | | | | | | |
| | <i>days</i> | <i>days</i> | <i>mgm.</i> | | | |
| 1 | | 26 | 10.8 | 9 | 92 | 101 |
| 3 | 30-36 | 34 | 7.6 | 63 | 44 | 107 |
| 3 | 41-46 | 43 | 11.8 | 56 | 35 | 91 |
| 4 | 50-64 | 56 | 10.6 | 36 | 19 | 55 |
| 2 | 80-95 | 87 | 10.8 | 36 | 26 | 62 |
| 2 | 100-110 | 105 | 13.8 | 33 | 12 | 45 |
| Rats with corpora lutea | | | | | | |
| 2 | 64-70 | 67 | 37.4 | 55 | 26 | 81 |
| 2 | 80-84 | 82 | 29.8 | 21 | 28 | 49 |
| 2 | 95-100 | 97 | 46.8 | 32 | 27 | 59 |
| 3 | 110-150 | 133 | 41.1 | 32 | 28 | 60 |
| 3 | 198-262 | 222 | 53.9 | 22 | 13 | 35 |
| 2 | 318-385 | 352 | 59.6 | 17 | 16 | 33 |
| 2 | 454-559 | 506 | 53.7 | 24 | 17 | 41 |
| 1 | | 947 | 65.2 | 4 | 6 | 10 |

six, yet the weight of the ovaries is 65.2 mgm. Similar relations appear when the numbers of degenerated follicles are arranged according to the weight of both ovaries instead of age.

As was already stated, the precise number of small degenerated follicles is hard to determine on account of the lack of any distinct character, such as the presence of a nucleus in the ovum. However, some notion of even an approximate number is highly desirable.

The number of these small degenerated follicles in the ovaries without corpora lutea lies between 300 and 900, while in the ovaries with corpora lutea their number varies from 600 to 1400. It is a remarkable fact that the number of these small follicles is not particularly different in the ovaries of pregnant as compared with the non-pregnant rats. Often in the ovaries in which corpora lutea are not present the small degenerated follicles are abundant, as, for instance, in the rat at 110 days, in which the number was 1500. Also in the ovaries with corpora lutea the number of small degenerated follicles may be very small, as in the rat at seventy days, in which it was 300. The average num-

TABLE 14
Tabulation of degenerated follicles

| | SMALL | MIDDLE-SIZED | LARGE | TOTAL NUMBER |
|--------------------------------------|--------|--------------|-------|--------------|
| Fourteen cases without corpora lutea | | | | |
| Sum..... | 6,734 | 651 | 460 | 7,845 |
| Average..... | 484 | 46 | 33 | 563 |
| Seventeen cases with corpora lutea | | | | |
| Sum..... | 14,280 | 463 | 357 | 5,100 |
| Average..... | 840 | 27 | 21 | 888 |

bers of the different sized degenerated follicles in all cases are shown in table 14.

Ovulation

In regard to the ovulation of mammals, as well as the maturation of the ova, there are numerous observations. It is generally held that the maturation process takes place only as the result of a specific stimulus which may follow copulation or the entry of the spermatozoon into the oviducts. Yet there are also numerous observations which show that the maturation process may take place independently of any such stimulus. For instance, Weil ('73) in the rabbit, Sobotta ('95) in the mouse, Tafani ('89)

in the rat, and Rubaschkin ('05) in the guinea-pig, stated that ovulation occurs spontaneously during heat and is independent of coitus. Iwanoff ('00) showed that in the rabbit pregnancy is also possible by the artificial insemination, and Heape ('97) tried artificial insemination on mares, donkeys, and cows, and succeeded in producing pregnancy in all.

Loeb ('11) also believes that in the guinea-pig ovulation occurs in the large majority of cases independently of copulation. Marshall and Jolly ('05), in the dog and in the ferret, described the spontaneous ovulation at each of the earlier heat periods during the breeding season.

To test this matter in the albino rat, I used the control females employed in a study of the surviving ovary after semispaying. These control female rats were separated from the males at twenty days of age, and were kept together with the semispayed rats of the same litter. Nevertheless, in the ovaries of these two control rats were found corpora lutea at sixty-two and sixty-nine days, respectively; that is, ovulation occurred spontaneously without any association with the male. From all these results there is little doubt that in the majority of mammals ovulation occurs regularly during the oestrus period and is independent of copulation.

Although many investigators have studied the relation between menstruation and ovulation in the higher mammals, such as the monkey and man, yet whether ovulation occurs before, during, or after menstruation has not been determined. It follows, therefore, that at least in monkeys, as well as in man, the process of ovulation does not seem to be necessarily associated with menstruation, though such a statement is not definitely made by most of the observers.

According to Heape ('98), ovulation and menstruation are not associated, since in monkeys menstruation may occur periodically all the year round, but the season for ovulation and conception is limited. Van Herwerden ('06) has also given further evidence that there is no close connection between ovulation and menstruation, either in monkeys or in the aberrant lemur, *Tarsius spectrum*.

In the case of the human female there are several opinions as to the usual time for the discharging of the ovum. Some authors report that ovulation occurs before menstruation; others, during that process, and still others, that it follows menstruation.

Hergesell ('05) holds that ovulation precedes menstruation for the reason that the most usual period for ovulation in the human female, as in many of the lower mammals, was during a definitive oestrus following the preoestrus; for the period of most active sexual feeling is generally just after the close of the menstrual period, while, according to Raciborsky (*Traité de Menstruation*: cited from "Physiology of reproduction, Marshall," '10), this is also the commonest season for fertile coition. Contrary to this, Bryce and Teacher ('08) hold that the ovum is discharged shortly after the cessation of the last menstruation.

Touching the question whether a special stimulus induces ovulation in woman, Oliver ('02) regards the view that coitus accelerates ovulation as the more probable, since at this time there is an increased blood supply to the whole genital tract. Heape ('05), however, maintains that the cause which determines the rupture of the Graafian follicle is, in the rabbit, the stimulation of erectile tissue, due to a nervous reflex, and not simply the result of internal pressure arising from an increased blood supply or a greater quantity of liquor folliculi.

Harper ('04), in pigeons, concludes that ovulation requires only a slight stimulus, 'mental,' and that the presence of sperm in the oviduct cannot be regarded as important. Kölliker ('02) considers the cause of rupture as a simple mechanical process because the irritation of vasomotor nerves increases the pressure of the liquor folliculi thus inducing the rupture.

From the foregoing it is evident that the real cause of the rupture of the Graafian follicle is not clearly established, and therefore that the factors which may induce ovulation require further study.

Whatever may be the final conclusion as to the cause, it is clear that ovulation is closely related to the maturing of the ovary, as my present study indicates.

As was shown in table 2, during relatively early stages, for instance at twenty days after birth, many follicles containing ova from 40 to 60 μ or more in diameter were found, and again in the rat at twenty-six days after birth there were found large numbers of well-developed follicles, which cannot be differentiated from mature follicles by mere examination (table 2); yet, despite the presence of these larger follicles, there is no evidence of ovulation in these younger rats.

Runge ('06) stated that enlarged follicles are by no means uncommon in ovaries of young children. In the first year of life he found follicles of considerable size, and in the second year still larger ones, some having a diameter of 135 μ . In the third year degenerate follicles were also found, and he concluded that the maturing of the follicles begins early. Loeb ('11) also found in the guinea-pig, eighteen days old, relatively large follicles in the ovaries which were yet small in size.

Though to my regret I have not studied the relation between the stroma and the development of the ovaries, or the internal secretion of the ovaries and its relation to their development, yet the observations of many investigators, as well as my own, indicate that the period of puberty is induced principally by the ripening of the ova in the follicles.

In the absence of coitus it is difficult to detect any special stimulus as the cause of the first ovulation or those which follow. It naturally suggests itself that influences arising outside of the ovaries may determine the rupture of the mature follicles, and one turns to the various glands associated with the reproductive system as possibly concerned. Thus the hypophysis and suprarenal glands in albino rats are larger in the female than in the male, the differences in size between the two sexes appearing usually somewhat before puberty (Hatai, '13), thus indicating greater activity at that time.

Again, the hypophysis has an intimate relation with the reproductive organs. It is also known that the thyroid changes in size during menstruation in man, and in the mammary glands, according to the recent studies of Myers ('16) on the rat, the branching of the ducts goes on at an unusually rapid rate about

the ninth week, which probably corresponds to the age of puberty. Myers did not discuss the relation of this rapid growth to puberty. The suggestion is that these various organs might be, some or all of them, related to the process of ovulation in the sense of forming stimulating substances causing ovulation, and it is my hope to make further studies along this line in the future.

Corpora lutea

I now wish to consider the relation between the first appearance of corpora lutea and puberty.

For this purpose I have assembled the data from seventy-nine albino rats, ranging in age from thirty days up to about thirty-two months. For some of them the weights of the ovaries were not determined.

As is shown in table 15, the corpora lutea first appear in a rat at sixty-one days, but after sixty-one days, though corpora lutea are present in most cases, they are not present in all. The absence of the corpora lutea in the rats after sixty-one days is always associated with a body weight too small for the age, showing poor nutrition. The weights of the ovaries are also small.

I have next rearranged some of the data, given in table 15, according to the body weights of rats, omitting those with body weights less than 75.5 grams and greater than 113.5 grams (table 16).

We notice the first appearance of the corpora lutea in the rats with a body weight of 78.5 grams, but they are not always present until the rats reach 100 grams in body weight.

Beyond 100 grams we always find corpora lutea in ovaries. So far, then, as the body weight is concerned, the first appearance of the corpora lutea occurs at from 78.5 up to 100 grams. These body weights of 78.5 to 100 grams correspond to sixty-one and seventy-one days, respectively, as given in Donaldson's table. Thus in my series the appearance of puberty approximately coincides with the observation of Donaldson ('15). From these data it appears that while puberty is attained as a rule between sixty-one to seventy-one days in rats that have grown approxi-

TABLE 15

The relation between the corpora lutea and the age, body weight and body length

| AGE | BODY WEIGHT | BODY LENGTH | WEIGHT OF BOTH OVARIES | COR-PORA LUTEA | AGE | BODY WEIGHT | BODY LENGTH | WEIGHT OF BOTH OVARIES | COR-PORA LUTEA |
|-------------|--------------|-------------|------------------------|----------------|-------------|--------------|-------------|------------------------|----------------|
| <i>days</i> | <i>grams</i> | <i>mm.</i> | <i>mgm.</i> | | <i>days</i> | <i>grams</i> | <i>mm.</i> | <i>mgm.</i> | |
| 30 | 34.8 | 108 | 6.4 | — | 91 | 125.7 | 180 | 55.6 | + |
| 36 | 34.9 | 105 | 5.6 | — | 91 | 131.8 | 176 | 45.7 | + |
| 36 | 50.0 | 122 | 10.4 | — | 91 | 93.5 | 158 | 57.1 | + |
| 41 | 58.2 | 131 | 7.4 | — | 95 | 72.0 | 146 | | — |
| 41 | 61.9 | 128 | 14.0 | — | 95 | 67.9 | 132 | | — |
| 50 | 74.6 | 146 | 11.2 | — | 95 | 98.5 | 148 | 12.2 | — |
| 50 | 75.5 | 144 | 12.9 | — | 95 | 160.0 | 182 | 73.5 | + |
| 60 | 93.5 | 145 | 10.3 | — | 100 | 78.5 | 138 | 8.8 | — |
| 61 | 80.5 | 153 | 23.0 | + | 100 | 97.8 | 156 | 20.1 | + |
| 62 | 84.0 | 152 | 30.8 | + | 102 | 95.0 | 150 | | + |
| 62 | 120.9 | 169 | 36.6 | + | 102 | 132.5 | 171 | | + |
| 64 | 62.7 | 132 | 7.9 | — | 110 | 94.3 | 147 | 18.9 | — |
| 64 | 113.5 | 165 | 31.1 | + | 110 | 167.1 | 185 | 41.6 | + |
| 65 | 77.2 | 145 | 12.2 | — | 112 | 86.5 | 148 | | — |
| 69 | 78.5 | 148 | 40.5 | + | 112 | 95.8 | 152 | | + |
| 69 | 88.8 | 154 | 34.1 | + | 112 | 122.8 | 164 | | + |
| 69 | 90.0 | 154 | 23.5 | + | 130 | 122.3 | 170 | 42.8 | + |
| 70 | 106.3 | 162 | 43.8 | + | 130 | 103.3 | 158 | 38.8 | + |
| 74 | 87.3 | 154 | 22.1 | + | 140 | 123.0 | 168 | 49.2 | + |
| 74 | 111.7 | 163 | 34.5 | + | 141 | 140.5 | 175 | 33.8 | + |
| 75 | 91.7 | 155 | 22.7 | + | 150 | 129.5 | 171 | 32.5 | + |
| 75 | 97.9 | 156 | 23.0 | + | 170 | 130.5 | 173 | 28.0 | + |
| 79 | 119.8 | 166 | 34.9 | + | 172 | 124.6 | 178 | 31.7 | + |
| 80 | 77.3 | 140 | 9.4 | — | 179 | 130.0 | 173 | 26.2 | + |
| 80 | 107.3 | 153 | 37.4 | + | 181 | 150.3 | 173 | 53.9 | + |
| 82 | 41.9 | 118 | | — | 181 | 156.3 | 194 | 50.8 | + |
| 82 | 58.0 | 125 | | — | 194 | 100.0 | 148 | 15.1 | — |
| 82 | 73.1 | 141 | | — | 194 | 90.3 | 145 | 14.2 | — |
| 82 | 58.6 | 128 | | — | 198 | 142.7 | 171 | 58.1 | + |
| 82 | 65.0 | 132 | | — | 206 | 188.5 | 185 | 54.8 | + |
| 83 | 47.6 | 118 | | — | 262 | 145.0 | 185 | 48.9 | + |
| 83 | 82.0 | 147 | | — | 315 | 190.8 | 193 | 53.1 | + |
| 84 | 48.5 | 125 | | — | 318 | 155.0 | 189 | 38.5 | + |
| 84 | 61.0 | 132 | | — | 385 | 161.3 | 194 | 82.6 | + |
| 84 | 41.1 | 114 | | — | 454 | 138.7 | 194 | 33.8 | + |
| 84 | 55.5 | 127 | | — | 559 | 198.9 | 200 | 73.5 | + |
| 84 | 64.5 | 124 | | — | 947 | 238.0 | 215 | 65.2 | + |
| 84 | 125.0 | 165 | 22.2 | + | | | | | |
| 86 | 59.5 | 125 | | — | | | | | |
| 86 | 70.5 | 135 | | — | | | | | |
| 86 | 60.0 | 132 | | — | | | | | |
| 88 | 88.6 | 150 | | — | | | | | |

mately normally, yet malnutrition as represented by a deficient body weight may delay its appearance or even entirely prevent it. This is in accord with laboratory observations on breeding.

TABLE 16

The relation between the corpora lutea and the body weight. Body, weight, 75 to 115 grams

| AGE | BODY WEIGHT | BODY LENGTH | WEIGHT OF BOTH OVARIES | CORPORA LUTEA |
|-------------|--------------|-------------|------------------------|---------------|
| <i>days</i> | <i>grams</i> | <i>mm.</i> | <i>mgm.</i> | |
| 50 | 75.5 | 144 | 12.9 | — |
| 65 | 77.2 | 145 | 12.2 | — |
| 80 | 77.3 | 140 | 9.4 | — |
| 69 | 78.5 | 148 | 40.5 | + |
| 100 | 78.5 | 138 | 8.8 | — |
| | 80.0 | 148 | | + |
| 61 | 80.5 | 153 | 23.0 | + |
| 83 | 82.0 | 147 | | — |
| 62 | 84.0 | 152 | 30.8 | + |
| 112 | 86.5 | 148 | | — |
| 74 | 87.3 | 154 | 22.1 | + |
| 88 | 88.6 | 150 | | — |
| 69 | 88.8 | 154 | 34.1 | + |
| 69 | 90.0 | 154 | 23.5 | + |
| 194 | 90.3 | 145 | 14.2 | — |
| 75 | 91.7 | 155 | 22.7 | + |
| 60 | 93.5 | 145 | 10.3 | — |
| 91 | 93.5 | 158 | 57.1 | + |
| 110 | 94.3 | 147 | 18.9 | — |
| 102 | 95.0 | 150 | | — |
| 112 | 95.8 | 152 | | + |
| 100 | 97.8 | 156 | 20.1 | + |
| 75 | 97.9 | 156 | 23.0 | + |
| 95 | 98.5 | 148 | 12.2 | — |
| 194 | 100.0 | 148 | 15.2 | — |
| 130 | 103.3 | 158 | 33.8 | + |
| 70 | 106.3 | 162 | 43.8 | + |
| 80 | 107.3 | 153 | 37.4 | + |
| | 113.0 | 167 | | + |
| 64 | 113.5 | 165 | 31.1 | + |

Finally, I have arranged the data given in table 15 according to the body length of the rats. Rats whose body lengths are less than 145 mm. and greater than 155 mm. have been eliminated, and the results are shown in table 17.

As is seen in the table, the first appearance of corpora lutea takes place in the ovaries of a rat having a body length of 148 mm. From 148 mm. to 155 mm. we find but one exception in which the rat is notably short for its age. The body length of 148 mm. to 150 mm. coincides with the age of sixty-two to sixty-

TABLE 17

The relation between the corpora lutea and the body length. Body length 145 to 155 mm.

| AGE | BODY WEIGHT | BODY LENGTH | WEIGHT OF BOTH OVARIES | CORPORA LUTEA |
|-------------|--------------|-------------|------------------------|---------------|
| <i>days</i> | <i>grams</i> | <i>mm.</i> | <i>mgm.</i> | |
| 60 | 93.5 | 145 | 10.3 | — |
| 65 | 77.2 | 145 | 12.2 | — |
| 194 | 90.3 | 145 | 14.2 | — |
| 50 | 74.6 | 146 | 11.2 | — |
| 95 | 72.0 | 146 | | — |
| 83 | 82.0 | 147 | | — |
| 110 | 94.3 | 147 | 18.9 | — |
| 95 | 98.5 | 148 | 12.2 | — |
| 194 | 100.0 | 148 | 15.1 | — |
| 112 | 86.5 | 148 | | — |
| 69 | 78.5 | 148 | 40.5 | + |
| | 80.0 | 148 | | + |
| 88 | 88.6 | 150 | | — |
| 102 | 95.0 | 150 | | + |
| 62 | 84.0 | 152 | 30.8 | + |
| 112 | 95.8 | 152 | | + |
| 61 | 80.5 | 153 | 23.0 | + |
| 80 | 107.3 | 153 | 37.4 | + |
| 69 | 88.8 | 154 | 34.1 | + |
| 69 | 90.0 | 154 | 23.5 | + |
| 74 | 87.3 | 154 | 22.1 | + |
| 75 | 91.7 | 155 | 22.7 | + |

five days in Donaldson's table. In my rats, however, the corresponding ages are from sixty-nine to eighty-eight days, respectively. This disagreement between my own determination and that by Donaldson is undoubtedly due to the poor nutritional condition of the rats here employed. I therefore conclude that the body length is the best criterion among the three characters, age, body weight and body length, so far considered. I have

compared the results obtained by the three different methods in table 18.

It is at once clear from table 18 that when body length is taken as a criterion, the range at which period the corpora lutea first appear is least, namely, the age of sixty-two to sixty-five days.

Corpora lutea in pregnant and non-pregnant rats

In regard to the corpora lutea there are numerous observations, especially on their origin. Von Baer ('27) considers that the corpora lutea consist entirely of connective tissue, and in their formation the follicular epithelium has no share. On the

TABLE 18

Conditions determining the appearance of the first corpora lutea

| THE METHOD OF COMPARISON | THE TIME OF FIRST APPEARANCE OF CORPORA LUTEA | THE AGE IN DAYS FROM DONALDSON'S TABLE ('15) |
|--------------------------|---|--|
| By age | 62 to 110 days | 60 to 70 |
| By body weight | 78.5 to 100.0 grams | 61 to 71 |
| By body length | 148 to 150 mm. | 62 to 65 |

other hand, Bischoff ('42) concluded that the luteal cells were formed by the hypertrophy of the epithelial cells of the undischarged Graafian follicles. Ever since these statements were made by Von Baer and by Bischoff they have been the subject of discussion.

Marshall ('10) stated that if the discharged ovum fails to become fertilized, the corpus luteum goes on growing for a short time and then degenerates. In the smaller animals it disappears after a comparatively short time. If, on the other hand, conception follows ovulation, the corpus luteum continues to increase in size until almost the middle of pregnancy.

Loeb ('11) also found in guinea-pigs that the corpora lutea which are formed without pregnancy are much smaller, and shrank more rapidly than those the formation of which was followed by pregnancy.

On the other hand, Sobotta ('06), from his study on the mouse, expressed the view that the persistence of the corpora lutea and their ultimate size are not altered by conception.

In the present study we have examined four pregnant rats, and found that, as Loeb described, the corpora lutea in the pregnant rats were larger than those in rats not pregnant. However, the difference is slight. The completely formed corpora lutea at about ten days after conception, judging from the size of the fetus, are about 2.7 mm. in diameter. This size has diminished to about 2.4 mm. in diameter about seventeen days after pregnancy, that is, in the later phase.

So long as I did not collect the material with a view to studying the fate of corpora lutea, I am unable to discuss their age. If, however, we divide the entire population of corpora lutea into two groups, the larger and the smaller ones, it is possible to study the influence of these on the weight of ovaries.

As is shown in tables 3, 6, 8, and 10, both the total number of the corpora lutea, as well as the number of small ones, show an unmistakable tendency to increase, despite great individual variation, according to the age or other measurements of the rats. On the other hand, the number of corpora lutea of large size remains approximately constant.

From these results we conclude that after puberty the accumulation of the smaller corpora lutea is mainly responsible for the increase in the weight of the ovaries with increasing age.

The degeneration of the follicles

So far I have simply stated the relation which exists between the total number of ova and of the degenerated follicles; but I now wish to consider these degenerated follicles in their relation to the corpora lutea. As has been mentioned already (table 13), the degenerated follicles are not found in the rat until about twenty-six days. The failure to find any degenerated follicles up to this time may be due partly to the extreme difficulty in recognizing them and partly to a possible resorption immediately after they are formed. However this may be, after twenty-six

days the degenerated follicles were first found and these probably originated from enlarged primitive follicles.

Loeb ('11), while studying the cyclic changes in the ovaries of guinea-pigs, found that at eighteen days of age the degenerative process in some follicles had been entirely completed, and connective tissue had begun to grow into the cavity. Thus the degenerative processes occur at about the same phase both in the rat and in the more precocious guinea-pig.

Moreover, Loeb states that, associated with ovulation, all the follicles, with the exception of very small ones, degenerate. The general degeneration of the follicular granulosa cannot be seen before ovulation. This sudden degenerative process, as well as typical follicular degeneration, is quite independent of coitus. He further found that in newly ruptured follicles the degeneration of the granulosa is shown, except in the very small follicles, while in a large majority of the follicles almost the whole granulosa is found in the process of degeneration, and this degeneration is essentially independent of copulation and of pregnancy, but directly connected with ovulation. Furthermore, from the age of the corpora lutea, the ultimate fate of the follicles, i.e., whether these will disappear or not may be inferred. At a given time, approximately ten days after ovulation, a certain equilibrium is reached between the follicles which undergo degeneration and those which grow further. Among those which were growing, the degenerative process may also take place.

Though in my study the exact age of the corpora lutea cannot be determined, we can assume for the two pregnant rats, whose ages are eighty and ninety-five days, respectively, that the corpora lutea (from the estimated age of the fetus) were formed within the ten preceding days. In these cases the number of the degenerated follicles of middle and large sizes is far greater than in the other rats at about the same age. Although in these cases the corpora lutea may have been present within ten days after ovulation, as was inferred, yet it is premature to conclude from my study that all of the follicles of large and medium size undergo degeneration after the appearance of relatively new corpora lutea, as Loeb stated. The number of middle-sized

and large degenerate follicles is about the same, whether the ovaries contain new or old corpora lutea. Although there are slight differences before or after puberty, as shown by the average values of their numbers—74 and 49, respectively.

As was mentioned already (p. 444), the number of small degenerated follicles shows large fluctuations—between 300 to 900—in ovaries without corpora lutea, and thus an accurate determination of degenerated small follicles is very difficult. However, it seems certain that after puberty the number of degenerated small follicles increases from about 600 to 1400. The average number of fourteen cases before puberty gives 563 small follicles, while the average number of seventeen cases after puberty is increased to 888. The average number of all thirty-

TABLE 19

Numbers of degenerated follicles before and after puberty

| | MEAN OF THE TOTAL NUMBER OF OVA | AVERAGE NUMBER OF ALL DEGENERATE FOLLICLES | THE PERCENTAGE OF DEGENERATE FOLLICLES TO TOTAL NUMBER OF OVA |
|--------------------------|------------------------------------|--|--|
| Before puberty | 9380 | 637 | 6.79 |
| After puberty | 5592 | 933 | 16.66 |

one cases is therefore 740 follicles. To this, the mean number of fifty-nine medium and large degenerated follicles are to be added, so that we obtain about 800 as the total number.

In table 19 the proportion of these degenerated follicles to the total number of ova is shown.

It is reasonable to conclude from all the data (tables 2 and 4) that before puberty the number of the large degenerate follicles is one and a half times that found in the ovaries of rats after puberty, while we have already found that the number of small degenerate follicles after puberty is one and a half times that found before puberty.

Loeb ('06) described the small follicles as always present after either ovulation or the appearance of the corpus luteum. My own data, however, show that after puberty, that is after the appearance of corpora lutea, the number of small degenerated fol-

licles is considerably increased as compared with their number before puberty. This finding is different from that of Loeb, but the difference may be due partly to the difference in the animals used. However, it seems to me more probable that the appearance of the corpora lutea gives an impulse to the degeneration of the small follicles.

At any rate, the percentage of degenerated follicles after puberty is higher than before puberty, as is shown in the above calculation, where the number of degenerated follicles is as high as about 16 per cent of the total number of ova. Therefore, the decrease in the number of ova according to the age seems to be caused principally by the degenerated follicles. We can neglect the ripened ova, eight to ten of which are discharged into the oviducts at every ovulation period, as this number is insignificant in relation to that of the degenerate follicles.

Sobotta and Burckard ('10) stated that in white rats the maximum number of ripe ova which enter the oviducts is altogether thirteen from both ovaries and the minimum is four, although eight to ten ova are more usual. The maximum number of ripe ova from one ovary is said to be eight.

According to Donaldson, the largest litter noted in the common albino is seventeen, while Kolazy ('71) also reported a litter consisting of seventeen young.

According to these observations, the highest number of ova discharged into the fallopian tubes is seventeen and the lowest is four. Usually it is eight to ten. The average number of the mature follicles in the ovaries at several ages, however, is twenty-one, and therefore about half of these mature follicles must rupture and discharge their ova into the oviducts, and the remaining half must undergo atresia.

Comparison between man and the rat in regard to the postnatal changes in the ovaries

It may be worth while to compare the results obtained from these studies on the development of the ovary in the rat with those in man, especially during the period in which the degeneration of the primitive germ cells and the new formation of definitive ova is most active.

If we take sixty-five days as the mean age for the first ovulation, we find that the rat is distinctly precocious for sixty-five days, corresponds to about sixty-five months of human life, or roughly, five and a half years. According to Vierordt's table, the first menstruation in man may occur in tropical countries at eight years, but more commonly a year or two later.

On the other hand, the cessation of the breeding period in the female rat at eighteen to twenty months (= 45 to 50 years) agree very well with the appearance of the menopause which occurs in man between forty-five and fifty years.

As is to be expected, individual rats may breed for a longer period, and King ('15) has reported a female bearing a litter of one at twenty-two months and, as table 15 shows, the rat at 947 days (= thirty-one months) had newly formed corpora lutea in its ovaries.

SUMMARY

1. The total number of ova in both ovaries was counted in thirty-nine albino rats ranging in age from birth to 947 days.

2. In relation to the body weight the size of the ovaries increases to a maximum at 33 grams of the body weight, then decreases up to puberty, after which it increases rapidly and reaches the second maximum.

The ovary weight according to age shows continuous increase up to thirty-one months (table 12).

3. The weight of the right ovary is less than that of the left—about 90 per cent—while the total number of ova in the right ovary is slightly more than in the left, though the difference is small (table 1).

4. In general the number of ova decreases with age. The total number of ova in both ovaries decreases rapidly from 35,100 at birth to about 11,000 at twenty-three days. From twenty-three to sixty-three days the number is nearly constant (11,000 to 10,000). It then decreases again rapidly (to about 6600) at seventy days. During this last period ovulation usually occurs. From seventy days up to the thirty-one months there is a slow decrease to about 2000 ova. In general, this decrease results mainly from the degeneration of the primitive ova, but in part from that of the definitive ova (tables 2 and 3, charts 1 and 2).

5. In non-pregnant rats the percentage of larger-sized ova to the total number remains nearly constant. In young pregnant rats the percentage of ova more than 20μ in diameter is greater than in the non-pregnant rat, but in older pregnant rats this percentage decreases. These conclusions are, however, based on four instances only.

6. The graphs illustrating the change in the total number of ova are similar in form whether they are based on the body weight or the body length (table 6, chart 3).

7. With the increasing weight of the ovary the total number of ova decreases. The increase in weight is associated before puberty principally with the formation of large degenerate follicles together with mature follicles and growth of connective tissue, but after puberty the increase depends mainly on the accumulation of small corpora lutea in addition to the mature and degenerate follicles and connective tissue. After puberty the number of large corpora lutea is about the same in all ovaries, and these, therefore, are not responsible for the regular age changes in the weight of ovaries (table 10, chart 4).

8. In albino rats the new formation of the egg cells takes place after birth from the germinal epithelium. These ova grow in situ and, as development proceeds, are covered by the adjacent epithelial cells and extend into the stroma, passing through the tunica albuginea. From these newly formed germ cells the definitive ova appear to develop, beginning from about the second week after birth, and the formation of them is most active in the period between the third and ninth weeks. During puberty

this new formation becomes less active, though it may continue for a year after birth (chart 2).

9. The primitive ova, which are present during foetal life, are found degenerating immediately after birth. The rate of degeneration rapidly diminishes from birth to three weeks of age, but continues up to sexual maturity, at a slower rate. The exact period of degeneration of definitive ova is not known, but probably it begins before puberty, and after puberty the degenerate follicles are derived principally from the definitive ova. In the rat about four weeks old the medium-sized follicles show degeneration, and in general the number of degenerated follicles of large size is more than one and a half times that found before puberty. The converse relation is true in the case of small follicles. The mean number of all degenerated follicles is about 10 per cent of the total number of ova.

10. Ovulation can occur spontaneously, independent of sexual intercourse and without the influence of the male sex. Well-developed follicles appear as early as twenty-six days after birth. These follicles contain ova with a diameter of $60\ \mu$ —equal to those found in well-developed mature follicles. Should some special stimulus be deemed necessary for the discharge of the ovum, it is suggested that either the ovary itself or some other ductless gland might furnish such an hypothetical stimulating substance.

11. The body length of rats was found a better criterion for the first appearance of corpora lutea than either age or body weight. The corpora lutea are found in rats between 148 to 150 mm. in body length (table 18).

12. The corpora lutea formed in rats in which the ova have been fertilized are a little larger than those in non-fertilized rats. It is stated that usually eight to ten ripened ova are discharged at the same time. We found, however, that near maturity there may be as many as twenty-one follicles in both ovaries.

LITERATURE CITED

- ALLEN, B. M. 1904 The embryonic development of the ovary and testis of the mammals. *Am. Jour. Anat.*, vol. 3.
- VON BAER, C. E. 1827 *De ovi mammalium et hominis genesi*. L. Vossii, Lipsiae.
- VAN BENEDEN, E. 1880 Contribution a la connaissance de l'ovaire des mammiferes, etc. *Arch. d. Biol.*, T. 1.
- BISCHOFF, T. L. W. 1842 *Entwicklungsgeschichte des Kannedchen-Eies*. Braunschweig, F. Vieweg u. Sohn, 154 pp.
- BRYCE, T. H., AND TEACHER, J. H. 1908 Contributions to the study of the early development and imbedding of the human ovum. Glasgow.
- DONALDSON, H. H. 1906 A comparison of the white rat with man in respect to the growth of the entire body. Boas anniversary volume.
1915 The rat. Reference tables and data for the albino rat (*Mus norvegicus albinus*) and the Norway rat (*Mus norvegicus*). *Memoirs of The Wistar Institute of Anatomy and Biology*, no. 6.
- DUSTIN, A. P. 1907 Recherches sur l'origine des Gonocytes chez les Amphibiens. *Arch. de Biol.*, T. 21.
- FELIX, W. 1912 The development of the urinogenital organs. In *Manual of Human Embryology*. Keibel and Mall, vol. 2. J. B. Lippincott Co., Phila.
- FIRKET, JEAN 1920 On the origin of germ cells in higher vertebrates. *Anat. Rec.*, vol. 18, pp. 309-316.
- VON HANSEMANN, D. 1913 Über den Kampf der Eier in den Ovarien. *Archiv für Entwcklngs. der Organismen*, Bd. 35.
- HARPER, E. H. 1904 The fertilization and early development of the pigeon's egg. *Am. Jour. Anat.*, vol. 3.
- HATAI, S. 1913 On the weights of the abdominal and the thoracic viscera, the sex glands, ductless glands and the eyeballs of the albino rat (*Mus norvegicus albinus*) according to body weight. *Am. Jour. Anat.*, vol. 15.
1914 On the weight of some of the ductless glands of Norway and of the albino rat according to sex and variety. *Anat. Rec.*, vol. 8.
- HEAPE, W. 1897 The artificial insemination of mammals and subsequent possible fertilization or impregnation of their ova. *Proc. Roy. Soc. London*, vol. 61.
1898 The menstruation of *semnopithecus*. *Trans. Obstet. Soc.*, vol. 40.
1905 Ovulation and degeneration of ova in the rabbit. *Proc. Roy. Soc. London*, vol. 76 B.
- HENLE, J. 1873 *Handbuch der systematischen Anatomie des Menschen*. Bd. 2, 2 Aufl., S. 504. Braunschweig.
- HERGESELL, G. 1905 *Das zeitliche Verhalten der Ovulation zur Menstruation*. Inaug. Diss., Leipzig.
- VAN HERWERDEN, M. 1906 Bijdrage tot de kennis van den menstrueelen cyclus. *Tijdschr. nederl. dierk. Vereen*, vol. 10.

- HEYSE, G. 1897 Einige Beiträge zur mikroskopischen Anatomie der Ovarien Osteomalatischer. Arch. für Gynäkologie, Bd. 53, S. 334.
- D'HOLLANDER, F. G. 1904 Recherches sur l'oogenese et sur la structure et la signification du noyau vitellin de Balbiani chez les Oiseaux. Arch. Anat. Microsc., T. 7.
- IWANOFF, E. 1900 La fonction des vesicles seminales et de la glande prostaticque. Jour. de Phys. et de Path. Gen., T. 2.
- JACKSON, C. M. 1913 Postnatal growth and variability of the body and of the various organs in the albino rat. Am. Jour. Anat., vol. 15, p. 40.
- JENKINSON, J. W. 1913 Vertebrate embryology. Clarendon Press, Oxford, 267 pp.
- JOESSEL, G. 1899 Lehrbuch der topographisch-chirurgischen Anatomie. Zweiter Theil fortgesetzt von W. Waldeyer, p. 793. Friedrich Cohen, Bonn.
- KARCHAKEWITSCH 1908 Über den Ursprung des Urgeschlechtszellen bei Rana escul. Sitzber. d. mat.-phys. Kl. d. Bayer Ak. d. Wiss., Bd. 38.
- KING, H. D. 1915 On the normal sex ratio and the size of the litter in the albino rat (*Mus norvegicus albinus*). Anat. Rec., vol. 9.
- KINGERY, H. M. 1917 Oogenesis in the white mouse. Jour. Morph., vol. 30.
- KINGSBURY, B. F. 1913 The morphogenesis of the mammalian ovary: *Felis domestica*. Am. Jour. Anat., vol. 15.
- KIRKHAM, W. B. 1916 The germ cell cycle in the mouse. Abstract in Anat. Rec., vol. 10, p. 217.
- KOLAZY, J. 1871 Ueber die Lebensweise von *Mus rattus*, varietas, alba. Verhandl. Zool. Bot. Gesellsch. Wien.
- KÖLLIKER, A., UND V. ENNER, V. 1902 Handbuch der Gewebslehre d. Menschen. Bd. 3, 6. umarbeitete Aufl., S. 553-554 and 557.
- LANE-CLAYPON, JANET E. 1905 On the origin and life history of the interstitial cells of the ovary in the rabbit. Prov. R. Soc. London, vol. 77 B.
- LOEB, L. 1906 The formation of the corpus luteum in the guinea-pig. J. of Am. Med. Assoc., February 10th.
- 1911 The cyclic changes in the ovary of the guinea-pig. Jour. Morph., vol. 22.
- MARSHALL, F. H. A., AND JOLLY, W. A. 1905 Contributions to the physiology of mammalian reproduction. Phil. Trans. Roy. Soc. Series B, vol. 198.
- MARSHALL, F. H. A. 1910 The physiology of reproduction. Longmans, Green & Co., N. Y., pp. 134-140.
- MINOT, CHARLES S. 1892 Human embryology, page 49. William Wood & Co., N. Y.
- MYERS, J. A. 1916 Studies on the mammary gland. Am. Jour. Anat., vol. 19, p. 379.
- OLIVER, J. 1902 A study of fertilisation with reference to the occurrence of ectopic pregnancy. Edin. Med. Jour., vol. 54.
- RACIBORSKY, A. 1868 Traité du menstruation. Paris, J. B. Baillière et Fils.
- RIDDLE, O. 1918 Further observations on the relative size and form of the right and left testes of pigeons in health and disease and as influenced by hybridity. Anat. Rec., vol. 14.
- RUBASCHKIN, W. 1905 Ueber die Reifungs und Befruchtungsprozesse des Meer-schweincheneies. Anat. Hefte, Bd. 29.

- RUNGE, E. 1906 Beitrag zur Anatomie der Ovarien Neugeborener und Kinder vor der Pubertätszeit. Arch. Gynäk., Bd. 80.
- SAPPEY, P. C. 1879 Traité d'anatomie descriptive. T. 4, pp. 720-721. Paris, V. Adrien Delahaye et Libraires-Editeurs.
- SKROBANSKY, K. V. 1903 Beiträge zur Kenntnis der Oogenese bei Säugetieren. Arch. f. mikr. Anat., Bd. 62.
- SOBOTTA, J. 1895 Die Befruchtung und Furchung des Eies der Maus. Arch. f. mikr. Anat., Bd. 45.
1906 Ueber die Bildung des Corpus luteum beim Meerschweinchen. Anat. Hefte, Bd. 32.
- SOBOTTA, J., UND BURCKHARD, G. 1910 Reifung und Befruchtung des Eies der weissen Ratte. Anat. Hefte, Bd. 42, p. 444.
- SONNENBRODT 1908 Die Wachstumsperiode der Oocyte des Huhnes. Arch. f. mikr. Anat., Bd. 72.
- STRATZ, C. H. 1898 Der geschlechtsreife Säugethiereierstock. M. Nijhoff, Haag.
- VAN DER STRICHT, R. 1911 Vitellogenèse dans l'ovule de Chatte. Arch. Biol. T. 26.
- TAFANI, A. 1889 La fécondation et la segmentation. Etudiées dans les oeufs des rats. Arch. Ital. de Biol., vol. 11.
- VIERORDT, H. 1906 Daten und Tabellen für Mediziner. 3 Aufl. Gustav Fischer. Jena.
- WALDEYER, W. 1906 Die Geschlechtszellen. In "Handbuch der vergleichenden und experimentellen Entwicklungslehre der Wirbeltiere," by Oskar Hertwig, erster Band, erster Teil, erste Hälfte, S. 351.
- WEIL, C. 1873 Beiträge zur Kenntnis der Befruchtung und Entwicklung des Kännincheneies. Wien Med. Jahrbuch.
- WIEDERSHEIM, R. 1897 Elements of the comparative anatomy of vertebrates. 2nd ed. Trans. by W. N. Parker. Macmillan, London, p. 368.
- VON WINIWARTER, H., ET SAINMONT, G. 1908 Nouvelles recherches sur l'ovogenèse et l'organogenèse de l'ovaire des mammifères (chat). Arch. Biol., T. 24.
1908 Ueber die ausschliesslich postfetale Bildung der definitiven Eier bei der Katze. Anat. Anz., Bd. 32.

Resumen por el autor, Leon Augustus Hausman.
Universidad Cornell, Ithaca.

Investigación micrológica de la estructura del pelo en los
Monotremas.

Lo mismo *Ornithorhynchus* que *Tachyglossus* poseen varios tipos diferentes de pelo en su cuerpo. El tipo de pelo que parece ser característico de los Monotremas es el de tipo muy aplanado, representado por los pelos denominados pelos escuteliformes en *Ornithorhynchus* y por los pelos llamados pelos ondulados aplanados y pelos espinosos en *Tachyglossus*. *Ornithorhynchus* posee un recubrimiento de pelos semejantes a los que forman la piel de otros mamíferos, los cuales faltan en *Tachyglossus*. La estructura de dichos pelos es semejante a la del tipo general de pelos cilíndricos que se encuentran en la mayor parte de los mamíferos.

Translation by José F. Nonidez
Cornell Medical College, New York

A MICROLOGICAL INVESTIGATION OF THE HAIR STRUCTURE OF THE MONOTREMATA

LEON AUGUSTUS HAUSMAN

Zoological Laboratory, Cornell University

FOUR PLATES (NINETY-EIGHT FIGURES) AND THREE TEXT FIGURES

CONTENTS

| | |
|--|-----|
| Introduction..... | 463 |
| Collection of hair samples..... | 463 |
| Preparation of hairs for microscopical examination..... | 464 |
| The hair of <i>Ornithorhynchus anatinus</i> | 472 |
| Summary for <i>Ornithorhynchus</i> | 479 |
| The hair and spines of <i>Tachyglossus hystrix</i> | 479 |
| Summary for <i>Tachyglossus</i> | 484 |
| Bibliography..... | 485 |

INTRODUCTION

The observations and conclusions embodied in the present contribution are the outgrowth of a comparative study of the microscopic structure of the hairs of the monotremes, *Ornithorhynchus anatinus* and *Tachyglossus hystrix*, and incidentally and for comparison of members of all of the existing families of mammals, except the Cetacea.

Collection of hair samples

The majority of the hair samples were collected by the writer from skins and mounted specimens in the collections at Cornell University and from those in the American Museum of Natural History in New York City and in the United States National Museum in Washington. Other institutions kindly furnished many samples.

Within each family samples were examined from species representing various types of environments, and from each family

three species were selected, where possible, to illustrate the typical trichologic structures in their various modifications.

It was found that, after collection, the hair samples were most satisfactorily disposed of by placing them, together with their data slips, in gelatin veterinary capsules. One-ounce capsules were used for the longer hairs, and half- and quarter-ounce for the shorter ones. These containers were much more satisfactory than glass vials, for they could be transported loosely, with little care, without danger of breakage; were less expensive, and much lighter in weight.

Preparation of hairs for microscopical examination

1. *Preparation for examination of cuticular scales.* First method—dry mounting. Some authors recommend placing the hair directly beneath the microscope on a slide and making the examination dry, without previous preparation. This method was tried, and while it revealed in general the arrangement of the scales in those hairs which are coarse and in which the scales are unusually prominent, it failed to yield accurate results. It was found to be quite essential to have the hair shaft perfectly clean, otherwise dust fibers which adhered to it were quite likely to be mistaken for the fine transverse markings which indicate the outlines of the scale edges. The simplest method of preparation employed was that of washing the hair carefully in a solution composed of equal parts of 95 per cent alcohol and ether. This removed all the oleaginous matter from the surface of the hair shaft and made it difficult for dust fibers to find lodgment upon it. It was then transferred to a clean slide, covered with a cover-glass, and allowed to stand on a tripod over a low alcohol flame until the whole had become perfectly dry. Throughout the entire manipulation of hairs it was found to be absolutely imperative to keep all utensils and instruments, and especially all glassware, scrupulously clean. A dry examination of the hair was then made. This sort of treatment was found to be effective in the examination of hair whose scales were large or prominent, such as the hair of some of the Cervidae, or of the Camelidae. In the great majority of cases, however, it became necessary to have

recourse to some methods of staining or of otherwise rendering the scales more certainly visible.

Second method—thickening the cuticular scales. Several methods of rendering the cuticular scales visible by treating the hair with reagents which thicken the scales, making them stand out from the cortex, are sometimes used. In the writer's opinion, such methods cannot to advantage be employed where a careful determination of the exact scale form is the end in view. By a series of experiments he has become convinced that the use of caustic potash or soda, sulphuric acid, and so forth, which are recommended for use, often hot, distort the scales, and furthermore cause them to bulge and to project outward from the cortex in an unnatural manner. This destroys at once both their characteristic outlines and their relationships one with another. Cuticular scales which have thus been dissociated from the cortex may, by pressure upon and a gentle rotation or agitation of the cover-glass, be entirely loosened from their connection with the remainder of the hair. Such scales are believed not to be useful for a careful correlative study of form. It was found that the following procedures might be used in the maceration of hairs for the dissociation of the cuticular scales where merely a crude notion of their form was the goal desired. Such scales revealed, in a general way, the arrangement patterns in which they were disposed about the hair shaft. These methods are: 1) heat gently in a 10 per cent aqueous solution of acetic acid until the hair shaft is slightly softened; 2) treat similarly, using a 1 per cent aqueous solution of chromic acid; 3) boil in a 5 per cent aqueous solution of hydrochloric acid. In each case various trials are necessary before the requisite degree of softness of the hair shaft can be obtained. After any of these procedures, the hairs may be mounted in water before examination, in order that the scales may float outward and not cling tightly against the cortex.

Third method—staining. The method which afforded the greatest measure of success, however, was one which was devised after the method of thickening the scales, and thereby distorting them, with caustics or acids, had been tried. The external sur-

face of the hair shaft presents an alternating series of transverse ridges and transverse depressions, due to the overlapping, imbricate cuticular scales. The method devised for making clear the outline of the scales is, in principle, to lodge finely divided coloring matter in all of these transverse depressions, leaving the elevations uncolored. This was accomplished in the following manner: The hair shaft was first washed in a solution composed of equal parts of 95 per cent alcohol and ether, to free its surface from oily matter. It was then heated very slightly or fanned gently, to insure complete drying, and then immersed in a 95 per cent alcoholic solution of gentian violet or safranin. After remaining in this solution for a minute or more, it was removed with forceps and held in a gentle draft of air or in the current of warm air rising from a bunsen flame until the alcohol had completely evaporated. The gentian violet or safranin, it was found, had been deposited from the solution and had gathered in all the transverse depressions on the surface of the hair, thus marking out clearly the outline, in sharp color, of every cuticular scale. The most delicate scale sculpturings which are capable of determination upon the finest of the hairs with the immersion objectives were by this method of treatment rendered plain, though for the very finest of the hairs this method was combined with examination under oblique illumination, hereafter described. It was found, however, that while this method gave almost ideal results with some hairs at the very first trial, it was necessary with other hairs to subject them to the processes again and again before the evaporation of the alcohol deposited the pigment uniformly in the cuticular grooves over any considerable portion of the hair surface.

Other stains which go easily into solution in the 95 per cent alcohol and are readily deposited upon its evaporation, such as iodine (with potassium iodide), methyl green, methyl and methylene blue, and toluidin blue, were also used, but for some unknown reason the best success was obtained with the gentian violet and safranin.

In the case of those hairs in which the scales are so prominent as to project notably out from the shaft, a very striking profile

was obtained by soaking the whole hair (after washing in the ether-alcohol solution) for several minutes in a 10 per cent aqueous solution of caustic soda, yet not long enough to render the hair slimy or to distort the scales, and then dipping it into a pink solution of safranin and 82 per cent alcohol. The entire surface of the hair assumed a pink color, and while the scale sculpturings over the surface of the hair were obliterated by the uniformity of the coloration, yet the profile of the hair shaft stood out with great clarity against the white light of the microscopic field, or even more strikingly against the black background when very oblique illumination and a low-power objective were utilized. This manipulation was often resorted to to determine the relation of the transverse scale sculpturings on the surface of the hair to the profile of the serrate edge.

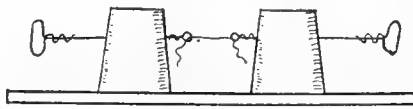

Figure A

For immediate examination the hairs stained to show the scale sculpturings on the surface were put into temporary dry mounts by fastening over them a cover-glass touched about its edges with balsam. Permanent mounts were obtained by ringing the cover-glasses with cement upon a turn-table. They were often, for immediate use, also mounted in very viscous gelatin gum dammar, or balsam. It was found that if very fluid balsam, dammar, or gelatin were used, the coloring material was quickly dissolved from out the scale depressions and distributed throughout the whole of the mounting medium. For the coarser hairs dry mounts were the most successful; for the finer, the glycerin, balsam, and dammar mounts.

It was frequently found desirable to trace completely around the hair the course of the markings indicating the edges of the cuticular scales, particularly in the study of the form of the coronal type of scales. To render the rotation of the hair under the highest powers of the microscope practicable, the apparatus shown in figure A was devised, and termed 'hair rotator.' It was con-

structed as follows: Upon a glass slide were fastened with Canada balsam two small corks, of firm texture, transpierced by fine copper wires, with their opposite ends bent into loops. Between the inner loops of these wires and between the corks, the hair under study was stretched and fastened at each end with droplets of balsam or viscous mucilage. The copper wires were now drawn out carefully away from one another until the hair between them was stretched taut, and the whole device placed upon the stage of the microscope. By gently tapping the outer loops of the copper wires with a dissecting needle, the hair could be with the greatest delicacy turned in either direction while under examination. It was discovered that a small drop of a 25 per cent aqueous solution of caustic soda or potash placed near one extremity of the stretched hair softened this portion to such an extent that the hair could be more easily rotated by turning but one of the copper wire loops. Not only could the hair be rotated, but also stretched slightly, and this was an advantage often, inasmuch as the lengthening of the cortex slightly separated the cuticular scales and rendered the depressions between them a trifle deeper. This device proved equally useful also in the examination of the medulla. The hair was first washed in the ordinary way, as has been described, and then cleared in clove or cedar oil, after which it was dried between two pieces of lens paper and stretched in the hair rotator as previously described. The configuration of the medullary cells and the relation of individual and groups of cells to each other was by this means brought out in the most satisfactory manner. Several of the hairs were, after having been cleared in xylene, allowed to remain in a bath of balsam for several hours, and then taken out, hung up like candles, and allowed to dry covered with a thin film of hardening balsam. These were then mounted in the hair rotator, and thus a completely balsam-mounted hair secured for examination. It was found, however, that in the main this procedure gave no more satisfactory results than simply clearing in clove or cedar oil before mounting in the rotator, though there were instances in the cases of some of the larger hairs in which it was thought that the clearing in xylene insured a slightly greater clarification of

the hair shaft. For the study of both the cuticular scales and the medulla with the hair rotator, both reflected and transmitted light were employed. Were the device made in such a way that the hair was held more closely to the upper surface of the slide, no doubt both indirect (or dark-field illumination) and polarized light might also be utilized with advantage. For securing a profile view of the hair, with its serrated outline of the cuticular scales, the rotator was used with reflected light, the source of which was placed in front, slightly above and a little to the side of the microscope, and the slide beneath the hair covered with black unglazed paper.

Another method of securing a profile view of the hair was to use indirect lighting or dark-field illumination, with the hair mounted dry. This method of illumination was best secured by the use of the dark-field illuminator, in which the central column of light is intercepted by an opaque disc in the condensing lens. For all dark-ground work it was found necessary to utilize a very brilliant light, especially with the higher powers. Because of the great degree of obliquity of the light required when using the 1.8-mm. (or higher) objective, it was necessary to form an oil connection between the upper surface of the condensing lens and the lower surface of the slide. If this is not done, nearly all of the light passing through the condenser from the mirror will not be transmitted through the upper surface of the former, but will be reflected, leaving the object to be examined in darkness. The use of oblique light was found necessary in many cases to demonstrate to the examiner's satisfaction the relations of the finer markings on the surface of many of the smallest hairs—markings that proved to be elusive under any of the methods of treatment heretofore described.

In the study of the medulla the dark-field type of lighting was also found helpful, though here the grosser structure of this element of the hair shaft rendered such refined manipulation not so essential.

In certain instances the polariscope was found to be an invaluable aid, particularly in detecting the presence within the hair shaft of vestiges of medullary cells or groups of cells, and in indi-

cating the extent of some of the cuticular scales. The disposition of the colors shown indicated often the location and relative thickness of the various hair elements, and not infrequently caused the transverse edges of the cuticular scales to stand out prominently in black tracery against the background of some vividly contrasting color. The state of fusion of the cortical cells was often also indicated by the appearance of certain characteristic color associations. By arranging the hairs under examination at different angles on the slide and by including in one mount hairs of many different species, various beautifully colored demonstrations of differences and similarities were obtained. It was found most satisfactory to mount hairs designed for polariscopic examination in some heavy oil (e.g., castor oil) or balsam. This treatment was, in fact, imperative for those hairs whose medullas were the objects of investigation.

2. *Preparation for the examination of the medulla.* The methods used to render the scales of hair prominent obscure the medulla. Consequently it was found necessary to devise some means of rendering the hair shaft transparent in order to bring the medullary cells or chambers into visibility. This was accomplished in the following ways:

First method—clearing in water. This is the method of clarification commonly used for hairs of a not too great diameter in general. It works fairly well with the finer hairs which lack pigment in the cortex and whose cuticular scales are not closely set together, which is tantamount to saying that it works well with but very few.

Second method—clearing in oils. It was found that clearing the hair in oils of various sorts, such as oil of bergamot, oil of cloves, oil of cedar, oil of origanum, and castor oil, tended to obscure almost entirely the markings of the scales and to make the hair shaft, in effect, a glassy cylinder, through which the medullary cells could be seen with great distinctness. The hair was first washed in the ether-alcohol solution as before, and then transferred to a bath of oil, where it was allowed to remain for several minutes. It was then mounted in the same oil for microscopical examination. In the case of the larger hairs, it was often neces-

sary to transfer the hair from the ether-alcohol solution to 95 per cent alcohol, then to a solution composed of equal parts of 95 per cent alcohol and the mounting oil, and then to the mounting oil itself. In each of these solutions the hair was allowed to remain for several minutes before transferring it to the mounting oil. The latter was often heated to 100°C. or thereabouts, to insure its penetration into all of the transverse ridges of the cuticular scales.

Third method—clearing in balsam. Often the finer hairs were cleared and mounted in balsam. After having been washed in the ether-alcohol solution, they were dried and immersed in a bath of xylene and then transferred directly to a mount of very thin balsam. With hairs as those of the bats, shrews, and many of the rodents, this treatment proved to be the best.

3. *Sectioning and mounting.* Transverse and longitudinal sections of the larger spines, such as those of the spiny ant-eater (*Tachyglossus hystrix*) (figs. 52 to 56), were secured by fastening the spine between two pieces of very hard, firm-grained cork in an immovable fashion, and then filing the spine to the desired thinness with a smooth, parallel-grooved file. The section was then removed from the cork and ground gently upon a hone moistened with water to render the surface perfectly smooth, after which it was dehydrated in several alcohols, impregnated with xylene and xylene-balsam, and mounted in balsam in the usual way. Those possessing the pithy type of medulla were differentially stained with eosin, the medulla taking the color, the firmer cortex and cuticle not.

For hairs in general the usual processes of dehydrating, impregnating with xylene, paraffin-xylene, infiltration with paraffin, mounting on blocks, sectioning, staining, and mounting were employed. It was found advisable to use xylene and paraffin-xylene baths hot, and to keep them so in the oven, allowing the hairs to remain therein for several days each. In staining with eosin, safranin, gentian violet, or methyl green, the medulla always took the stain, the cortex and cuticle remaining uncolored.

With most hairs, and more particularly with the finer ones, a very hard paraffin gave the best results. When it occurred that

the hairs pulled from out the block during the sectioning, a longer period in the hot xylene and zylene-paraffin baths was found to be the remedy.

The author here wishes gratefully to acknowledge his indebtedness to the Museum of Vertebrate Zoology of the University of California and to the Peabody Museum of Yale University for hair samples sent him, and to Dr. G. S. Miller, of the United States National Museum at Washington, and Dr. J. A. Allen, of the American Museum of Natural History in New York City, both for sending hair samples and aids of one kind and another at various times, and for allowing the author the free use of their extensive collections of skins. Dr. A. H. Wright, of the Department of Zoology at Cornell University, lent his kindly aid in the determination of some of the vernacular names of species mentioned in this paper.

Especial thanks are due to Professor H. D. Reed and to Professor Simon Henry Gage for guidance and counsel during the course of the investigation.

THE HAIR OF ORNITHORHYNCHUS ANATINUS

The hair types of Ornithorhynchus (plates 1 and 2)

The fact that *Ornithorhynchus* possesses two distinct types of hair was made known in 1802, when Blumenbach (1802) described its gross appearance. Later Home (1802) recorded the same facts. Apparently independently, Glockner (1819), van de Hoeven ('23), and Peron and Lesseur ('23) made a more careful study of some of the structural features, in a general way. A summary of the observations up to the year 1825 was made by Meckel ('26). The relations of the hairs to each other within the follicle was the subject of the investigations of Leydig ('58) while the size and general gross appearance of the hairs occupied the researches of Welcker ('66).

The first systematic attempt to review the histology of the hair is that of Waldeyer ('84), who was followed in this same endeavor by Poulton ('94). The latter first clearly indicated the relation-

ship between the flattened hair and the fur hair. He applied the term 'shield' to the tips of the flattened hair, which suggested to the present writer the term 'shield hair,' which is here employed as a designation of the larger hairs, to distinguish them as a group from the finer, or fur hairs, in which the shield does not appear.

Spencer and Sweet ('98-'99) declared it their belief that in structure and in growth, the hairs of the Monotremata are not different from the hairs of the members of the higher orders, while on the contrary, Toldt ('05) maintained that hairs with thickened ends (the shield hairs), such as *Ornithorhynchus* possesses, is to be found nowhere else among mammals. This statement he retracted a year later, however, when he discovered that the hairs of *Tachyglossus* were structurally the same.

Upon the body of *Ornithorhynchus* are six rather well-defined areas, each bearing its characteristic type of the longer protective shield hair. The type covering the greater part of the body is that found upon the dorsum (fig. 1, *F*). This type occurs over the whole of the back, caudad of the area of truncated shield hair (fig. 1, *C*), and is regarded as the form which all of the protective hairs of the body would assume, were not some worn off at the tips during growth.

Figure 3 shows the characteristic form of the dorsal shield hair, and figures 13 to 31 its structure. The shield hairs upon the other parts of the body exhibit similar structural details, but each type possesses its own distinctive distribution of pigment. Of this distribution later mention will be made.

The tract which is here called the area of truncated pigmented shield hair (fig. 1, *C*), bears hair possessing shields whose truncated tips indicated that they are exposed to considerable attrition. These hairs, and more particularly those between the eyes, contain less pigment than the dorsal shield hairs, varying from a light to a distinctly yellowish brown. Upon the pinnae of the ears and likewise over a small area immediately surrounding them, the shield hair is lacking altogether, and its place is taken by a very fine, short, soft fur hair, a continuation of that occurring beneath the shield hair over the larger portion of the body. This fur hair of the pinnae is the finest which the animal possesses.

Covering the venter is a type of the shield hair somewhat similar to that which clothes the head, but bearing a much longer shield, and, as might be expected, containing less pigment (fig. 1, *D*). Upon the sides of the venter (the region of the transition in color from the dark brown of the back to the creamy white of the abdomen) the pigment is confined to the proximal fourth of the shield. In all cases the shaft of this venter hair contains so few of the brown pigment granules as to show no color except under the microscope.

From the middle of the back to the base of the tail the shield undergoes a progressive increase in length and rigidity, and the shaft becomes correspondingly shorter (fig. 5). When the tail is reached each hair consists almost wholly of the flattened, stiffened shield element, a construction which gives it the character of very fine bristles. Near the base of the tail the top of the shield is weakly pigmented, while near the end of the tail the shields of the hairs exhibit an increased number of pigment granules.

The tail hairs are similar to those of the feet, and are subject to much attrition. They are consequently considerably worn and frayed, and are held closely against the skin. The forefeet are almost entirely shorn of their hair as far as the wrist, since it is upon these feet that the brunt of the labor of swimming and of burrowing falls. Upon the hind feet more hair is present. On both feet the hair is of a light brown color. Unlike the shields of the hair upon the venter, the shields of the hair of the feet are pigmented with their characteristic color throughout their lengths. This suggests that the lighter color of the hair upon the fore feet is not due to the fact that the tips of the shields have been worn away.

In all these varieties of the shield hair the three elements, shield, isthmus, and shaft, are invariably present (fig. 14, *B*, *C*, *D*), though different elements rise into prominence and determine the gross appearance of the hair upon different parts of the body (figs. 3 to 7). In all of these varieties, likewise, the relationships between the cortex, medulla, and cuticle are fundamentally the same, but in certain of the hairs, as will be shown, the medulla is lacking altogether.

There exists a variety of the shield hair which differs so markedly in its appearance from all the other types as to suggest at first the necessity of according it a separate classification. This aberrant type is restricted to a meager tract about the base of the snout, more particularly to an area just ventrad of the base, a region which may be termed the chin (fig. 1, A). Figure 8 shows the gross appearance of this hair, and figures 32 to 35 its structure. All distinctions between shield, isthmus, and shaft have disappeared, but the configuration of the cuticular scales, their mode of imbrication, and the character of those dissipated medullary cells which still remain are the same as those of all the other types of shield hairs. The fact that these ultimate structural elements of the hair preserve their integrity of appearance even though the general aspect of the hair as a whole may be radically modified, would seem to substantiate the assumption that, in *Ornithorhynchus* at least, the cuticular scales and the medullary cells offer the readiest means of identification and the most trustworthy criterion for the classification of the various types of hair.

The finer hair, found next the skin and underneath the shield hair, and which will be termed the 'fur hair,' is of a grayish-brown color, a trifle darker on the dorsum than on the venter. It covers the entire body, with the exception of the tail and feet, and is everywhere approximately from one-third to one-half the length of the shield hair (fig. 9). Vestiges of this fur hair may sometimes be found upon the tail in adults and a considerable amount is present on the tail of young individuals. This fur hair soon disappears, as a rule, early in adult life over such portions of the body as the tail and more distal portions of the limbs, where its presence is unnecessary for warmth and protection from water. Like the shield hair, the fur hair occurs upon one restricted portion of the body in a much modified form, namely, upon the area immediately surrounding the pinnae of the ears. Here it differs from the typical form in both length and diameter, though its characteristic histological structures are unchanged. It is, as has been said, the softest and finest hair which the creature possesses.

The medulla of the fur hair is somewhat similar to that of the shield hair (fig. 42), its principal differences lying in the conformation of the individual cells and in their closer compaction in the shaft. The shield hair, however, possesses a structurally distinctly different medulla in the region of the shield (figs. 23, 24, and 42).

The hairless areas of the body are the ventral surface of the tail and the distal portions of the feet. The denuded state of the former is acquired by the wearing away of the few hairs which make their appearance in the young. Stumps of these early hairs remain imbedded in the follicles throughout the life of the animal and apparently continue to grow, but are constantly worn away. A similar condition obtains on the distal portions of the feet.

The cuticular scales of the shield hair. At the base of the shield hair shaft the exposed portion of the cuticular scales is triangular in form, with the acute apex directed distad (fig. 15). As the middle of the shaft is approached, the scales become more obtuse, until their edges form a series of fine, transverse, roughly parallel ridges extending obliquely across the shaft (fig. 13). No difference in the thickness of the cuticle of the extal and ental surfaces of the cylindrical shaft are apparent (fig. 20).

The scales of the isthmus (fig. 14, *C*), are like those of the shaft in outline, but are smaller and more compactly grouped. The transverse markings indicating their edges are, in consequence, more crowded. Due to the angle at which the isthmus is bent, the scales in the convex region of the bend are much more closely impacted than those above and often present the appearance of having been fused into a solid plate. This is due to the fact that the edges are so closely crowded together that they are not distinguishable except under very careful examination. Upon the outer, or convex side of the bend, where the wear occurs, the scale edges are much modified in outline and present a much more evenly parallel appearance than any of the others. From this and from similar observations on other hairs in various situations upon the bodies both of *Ornithorhynchus* and of other species of mammals, it is concluded that the change in form be-

tween the scales of the proximal and the distal portions of hairs is due to increasing amounts of attrition and consequent removal of material from the free distal edges of the scales. On the shield itself their edges are also much worn and smooth (fig. 14). This condition is best illustrated in the shields of the hairs from the tail and feet (figs. 5 and 6). Scales from different regions of the shield hair are shown in figures 13 to 17.

The distinguishing feature of the cuticle of the shield is, however, its greater thickness on the ectal than on the ental surface, the difference being due, possibly, to a demand for maximum protection where maximum attrition occurs (fig. 19).

The medulla of the shield hair. The medulla of the shaft, in its characteristic appearance, is shown in figure 13. Toward the base of the shaft (fig. 12, *Q*) it pinches out, existing only as isolated, elongated cells. This it also does at the isthmus, but reappears again faintly in the base of the shield (fig. 14). About two-thirds of the way toward its tip it gathers together again in a well-defined band, but with a different structure from that which it possessed in the shaft (fig. 17). The region of this reappearance of the medulla in the shield is not always the same in different hairs; sometimes it is found nearer the tip, sometimes nearer the middle. The relation of the medulla to the cortex in the shield and shaft is shown in figures 13 to 18.

Upon a gross examination the medulla of the shield appears similar to that of the shaft, but a minuter study reveals the fact that the two differ markedly in their cellular elements. In the former the cells are globular, of various sizes, and are grouped into botryoidal masses; in the latter they exist as discoid cells, of uniform size and shape, and are regularly superimposed (figs. 23 and 24).

The shield hairs of the feet and tail, which apparently consist almost wholly of the shield element, bear medullas which do not at all resemble those of the shields of the back just described. Although the cells are somewhat fragmentary, they resemble those of the shaft of the shield hair (figs. 26 and 27). Cross-sections of these hairs show that the cuticle is no thicker on the extal than on the ental surface. Here likewise they resemble the

shaft of the typical shield hair rather than the shield. It may be that these hairs represent, anatomically, an expanded and flattened portion of the shaft element rather than an added shield element. The name shield hairs, however, in this case is not a misnomer when taken to refer to the form of the hair and not to its derivation.

The cortex of the shield hair. The cortical element is that to which is primarily due the variations in form of the shield hair. In its simplest condition in the shaft of the hair it consists of elongated, distorted, fused, nucleated cells, which are compacted longitudinally as shown in figure 22. In the shield the cortex expands and comprises the major portion of that structure (figs. 17 and 19). It is this element of the hair structure also which bears the pigment to which the color of the hair is due. In all but the cortex of the shield this pigment is distributed uniformly, but here it occurs most abundantly in the form of masses of granules in the ectal half of the shield (fig. 19).

The relation of the cortex to the medulla and cuticle in the shield hairs of the feet and tail is shown in figures 25 to 29.

The cuticular scales of the fur hair. The cuticular scales of the fur hair also differ in form from the base to the tip of the hair. Near the base the scales are very elongate (figs. 38 and 39) and their free distal edges project away from the shaft, giving to it a distinctly serrate profile (fig. 38).

Near the middle of the hair the worn edges of the scales give the hair the appearance shown in figure 42, and near the tip that illustrated in figure 37.

The medulla of the fur hair. No marked difference between the medulla of this type of hair and that of the shaft of the shield hair exists. Throughout four-fifths of the length of the shaft the medulla persists (fig. 42), and near the tip, where it does gradually thin out and disappear, there is no place where it shows any modification in form such as that which is noted in the case of the shield of the shield hair of the dorsum.

The cortex of the fur hair. This element presents no differences from its homologous structure in the shaft of the shield hair.

Summary for Ornithorhynchus

Ornithorhynchus anatinus possesses six well-defined areas upon the body, each of which is characterized by the growth of a different kind of hair. These different kinds, or varieties, have, apparently, judging from the form of the cuticular scales and medulla, been derived from two structurally distinct types of hair, the fur hair and the shield hair.

The shield hair, because of its structure, acts as a protection against physical injury to the skin and precludes the entrance of water, while the fur hair serves as an insulating medium, guarding the body against changes in temperature.

THE HAIR AND SPINES OF TACHYGLOSSUS (ECHIDNA) HYSTRIX

The hair and spine types of Tachyglossus (plates 3 and 4)

The first systematic account of the body covering of *Tachyglossus* was given by Meijere in 1894, and in 1898 an account virtually similar, but with especial consideration to the disposal of the groups of hairs and spines, was published by Römer. During 1898 also, Spencer and Sweet had issued their work on the development of the hairs and spines in the monotremes and marsupials, in which a careful study is made particularly of the development of the new hairs and spines and of the various follicular layers taking part in their growth.

Toldt ('05), in a discussion of the genera which he maintained as *Proechidna* and *Tachyglossus*, was the first to suggest that the criterion of hair structure and form is, at least as far as these genera are concerned, significant from the standpoint of their phylogenetic study, and may be used as aids in determining the position of the species. In 1906 he described the hair and spine covering of a species allied closely to the one now under consideration, *Zaglossus bruijnnii bruijnnii*.

A further contribution to the knowledge of the growth and development of the hairs and spines, with especial emphasis upon their grouping in the skin, was made by Pinkus in 1906.

The body covering of *Tachyglossus* has been commonly described as of two types, spines and hairs. This is, however, a

very general classification and may be used only in a rough way to indicate the general nature of the covering of the dorsum and venter, respectively. The covering of the latter consists of long, stiff hairs, while the former is beset with long, sharp, rigid spines so thickly placed as to cover effectively both the skin and their own bases.

A closer examination of these spines and hairs reveals the fact that no definite line of demarcation can be drawn between them. From the longest and most robust of the spines of the back to the finest of the hairs which can be found on the venter, there exist all gradational estates. More will be said later regarding this transition in form from the hairs to the spines. It will first be necessary, however, to pass in review the various parts of the body with reference to the type of hair and spine covering which each possesses.

The dorsum (fig. 43, *G*) is, as has been said, clothed with a formidable panoply of long, rigid, acuminate spines, closely massed together. The largest of these are those which occur in what we shall term the 'hip tufts' (fig. 43, *F*). These spines are approximately 50 mm. in length and about 4 mm. in diameter in their thickest portions. They are of a light yellowish-white hue with very dark brown, almost black, tips, the color extending down the spine for a distance of about 7 mm. in the case of the longest spines (fig. 54). The smaller dorsal spines are like the larger, with the exception that their tips are pigmented for a greater distance down the shaft, often extending to one-fourth its entire length (fig. 56). Because of the closeness with which the larger spines are set together, the lower three-fourths of the shafts of the smaller spines are hidden. Thus it appears as though the dorsum possesses spines of two colors, large yellowish spines and smaller black ones.

The hair of the dorsum is obscured by the spines, and consists of two general types: one flattened, straight, and somewhat stiff and spinous (fig. 58), and the other smaller, also flattened and somewhat stiff, but, in addition, slightly wavy (fig. 59).

Upon the venter occur three types of hair: a spiny, flattened type (fig. 48), a flattened wavy type (fig. 47), and a still finer

flattened and more wavy type (fig. 45). The first two are similar to the spiny and wavy hairs already described as occurring on the dorsum.

The covering of the tail is similar to that of the dorsum except that the spines are a trifle more slender and acuminate (figs. 60 and 61). About the periphery of this caudal tuft of spines occurs a zone or border of smaller spines which are unpigmented, and are much lighter in color than any of the spines elsewhere upon the body. Whenever the spines of the tail are elevated, these lighter marginal spines obscure the darker ones in the center of the tuft and cause the tail to appear a light creamy white color, and consequently to be very conspicuous when viewed from behind.

Upon the head occur short, light colored spines (fig. 62), short spiny flattened hairs (figs. 63 to 65), and short wavy hairs (fig. 66). All of these are similar to the spines and hairs of the dorsum, but shorter.

The flanks are covered by small curved spines (fig. 50) and long spiny hairs (fig. 49) which appear to be transitional between the spiny hairs of the venter and the curved spines of the flanks just mentioned.

The feet bear long spiny flattened hairs and shorter flattened wavy hairs as does the venter, though these of the latter type are few in number or absent altogether.

A comparison of figures 45 to 53 will give a notion of the nature of the transition from the finest wavy hair of the body to the most robust of the spines which are found in the hip tufts.

The wavy hair with its thickness slightly increased becomes the flattened straighter type shown in figures 47 and 48, and this becoming still thicker, especially in its medial portion, gives rise to the spines of the type illustrated by figure 50. A progressive increase in length and thickness of such a spine produces those of the types represented by figures 51 to 53, successively.

Thus a comparison of the gross characteristics of the hairs and spines suggests a transition in form, and an examination of their microscopic structure lends support to such a supposition.

The cuticular scales of the hairs and spines. The finest of the hairs—the wavy hairs from the auricular depression (fig. 43, *A* and *E*), dorsum (fig. 43, *G*), and venter (fig. 43, *I*)—bear the largest cuticular scales (fig. 87), and as we pass in our examination from the wavy hair to the thicker, stiffer, straighter type (the type here called the flattened spiny hair), we find that the scales decrease in size; their edges become more closely set together. The greater the thickness of the spiny flattened hair (and the consequently greater spinosity), the smaller, relatively, and the more irregular in ectal outline are the cuticular scales.

This alteration in the form of the scales is illustrated by the three types of the spiny flattened hair, each one, in the order given, being thicker and consequently a trifle more stiff and spinous than its predecessor. These types are: the spiny flattened hair of the dorsum (fig. 58), the short spiny flattened hair of the top of the head (fig. 64), and the long spiny flattened hair of the venter (fig. 67). A comparison of the figures referred to will make clear the relations of the scales. It will be noted that the larger and stiffer and more spinous the hair becomes, the smaller, relatively, are the cuticular scales and the more closely are their ectal edges crowded together.

As the transition from the spiny hairs to the true spines progresses, so also does the decrease in the relative sizes and irregularity of the scales, until upon the surface of the true spines, such as the largest of those found upon the dorsum, the scales are so closely massed together as to render the tracing of their individual edges extremely difficult. These can be seen only near the base of the spine; higher up the attrition, to which so stiff an appendage as a rigid, immobile spine is subjected, leaving the surface smoothly polished and obliterating all traces of the edges of the scales.

The medulla of the hairs and spines. The medulla likewise shows regular transitional forms between the wavy hairs and the spines. In the fine wavy hairs it is to be found only as streaks of minute, isolated cell fragments in various portions of the hair shaft, which, as has been indicated in the discussion of the hairs of the mammals in general, may denote that this type of

hair has been derived from a still finer variety which possessed a complete medulla. These isolated medullary cell fragments in the shaft are never in a continuous band. Seldom, indeed, are they discoverable. Often a close search of the entire length of the hair shaft with the highest powers of the microscope is necessary before the minute vestiges of the medulla can be described. They are, I think, present in some degree in all wavy hairs (figs. 85 and 86).

In the spiny flattened hairs more of the medulla appears, although it still exists, in most instances, as streaks of isolated cell fragments (fig. 89). At the base of the shaft, in this type of hair, and just below the mouth of the follicle, there often occurs a large group of medullary cells which resembles the fully formed medulla found throughout the shaft of the smaller spines. This group of cells pinches out and disappears just before the emergence of the hair shaft from the mouth of the follicle (fig. 80). Waldeyer observes that in the center of the large, strong spiny hair there may occasionally occur large, nodose, pigment masses (as he calls them) which perhaps may be regarded as the rudiments of a medulla. That these masses are medullary cells, I think there is now no doubt.

At the ectal extremity of the spiny flattened hair of the dorsum there commonly occurs, for the first time in the series, a complete medulla (figs. 71 and 72) which persists for a short distance down the shaft and then fragments into minute particles as the middle of the hair is approached (fig. 73). These fragments become progressively smaller and fewer in number in the lower portion of the hair (fig. 74), but gather together again into a continuous medulla at its base (fig. 75).

In the smaller spines the medulla is complete, and in the larger it reaches its maximum expansion, occupying an important position in the structure of the spine (figs. 94, 95, 96, and 98).

The cortex of the hairs and spines. The cortex in all the hairs and spines is a homogeneous hyaline, horny mass, in which no distinct evidences of its fused component cells could with certainty be determined. When macerated in a 25 per cent aqueous solution of sodium hydroxide it splits up into a fibrous mass,

which may be suggestive of the configuration of the fused cells. Similarly, when a spine is broken obliquely across, the irregularity of the fracture of the broken cortex element may also be indicative of the original cell form (fig. 98, *B.CO.*), though it may be that these cortical cells have lost all originality of contour and have completely fused into a truly homogeneous substance. At present no statement can be made regarding their form in the various hairs and spines.

While it is not within the province of this paper to discuss the development of the hairs and spines, from what has been observed it may not be amiss to call attention to the supposition that the different varieties of hairs and spines of *Tachyglossus* may have been derived from a single hair type, possibly of the wavy variety, by an increase in the thickness of the middle portion of the shaft. Their development can be determined with certainty, however, only by a careful study of the stages of their growth from the follicle in the embryo and young.

Summary for Tachyglossus

In all essential respects the hairs of *Ornithorhynchus* and *Tachyglossus* are similar. The curious flattened type of hairs is the characteristic form for this order. In both *Ornithorhynchus* and *Tachyglossus* this type comprises about 50 per cent of the body covering. In *Tachyglossus* the suggestion is advanced that the spines are developed from the wavy hairs. Not only in structure, but also in development are the hairs of *Ornithorhynchus* and *Tachyglossus* alike. Spencer and Sweet observe, "So far as essential points are concerned, the development of the large and small hairs alike agrees in both *Ornithorhynchus* and *Echidna* [*Tachyglossus*]."

The type of hair, therefore, characteristic of the Monotremata, is the flattened type, represented by the shield hairs of *Ornithorhynchus* and by the flattened wavy and spiny hairs of *Tachyglossus*. On the other hand, the fur hairs, found in *Ornithorhynchus*, but not present in *Tachyglossus*, are like the general type of cylindrical fur hairs possessed by the majority of the mam-

malia. Text figures B and C, representing the structure of the fur hairs of the European mole (*Talpa europaea*) and the pygmy flying phalanger (*Acrobates pygmaea*), respectively, illustrate this similarity.

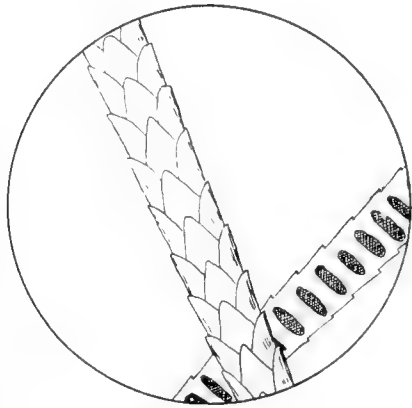

Figure B

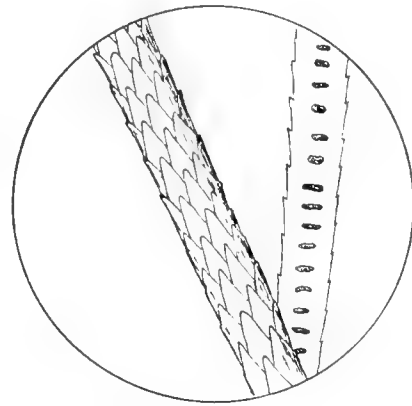

Figure C

BIBLIOGRAPHY

- BEDDARD, F. E. 1902 Observation on the carpal vibrissae in mammals. Proc. Zool. Soc., Lond., p. 127.
- BLUMENBACH 1802 Anatomical observations on the structure of *Ornithorhynchus paradoxus*. Phil. Mag., vol. 11, p. 366.
- BOHM, A. A., AND DAVIDOFF, M. VON 1900 A textbook of histology.
- BOSCH, E. 1910 Untersuchungen ueber die Ursache der Haarwirbelbildung bei den Haustieren, mit besonderer Beruecksichtigung, u. s. w. Jahrb. Wiss. Tiersucht, Hanover, Bd. 5, S. 94.
- BRANDT, J. F. 1900 Zur Phylogenie der Säugethierehaare. Biol. Centralbl., Bd. 20.
- BROWNE, P. A. 1883 Trichologia Mammalium. Philadelphia.
- BROWNE, P. A., AND DICKESON, M. W. 1848 Trichographia Mammalium. Philadelphia.
- EHRlich, KRAUSE, MOSSE, ROSIN, AND WEIGERT 1903 Encyclopädie der Mikroskopischen Technik. Berlin u. Wien.
- FONTES, L. R. DES. 1879 Beiträge zur anatomischen Kenntniss der Hautdecke des *Ornithorhynchus paradoxus*. Inaug. Diss., Univ. Bonn.
- FREDERIC, J. 1906 Sinushaare der Affen. Zeitschr. für Morph., Stuttgart, Bd. 9, S. 323.
- FRIEDENTHAL, H. 1906 Ueber die Behaarung des Menschen und auch anderer Affenarten. Verh. Ges. der Naturfor. Leip., Bd. 79, II, S. 306.
- 1909 Haarparasiten und Haarbau als Hinweise auf Blutverwandtschaft. Ber. Sits. Ber. Ges. der Naturfor. Fr., S. 379.
- 1911 Ueber der Behaarung der Menschenaffen und Menschenrassen. Zeitschr. Ethn. Ber., Bd. 43, S. 974.

- FRIEDENTHAL, H. 1911 Zur Technik der Untersuchung des Haarkleides und der Haare der Säugetiere. *Zeitschr. für Morph. u. Anthrop.*, Bd. 14, S. 441.
1911 Tierhaaratlas. Jena.
- GARCIA, S. A. 1892 Beiträge zur Kenntnis des Haarwechsels bei menschlichen Embryonen und Neugeborenen. *Morph. Arb.*, Bd. 1.
- GLOCKNER, E. F. 1819 Über die Haare des *Ornithorhynchus*. *Isis*, S. 651.
- HAGER, H., AND MEZ, C. 1899 Das Mikroskop und seine Anwendung. Berlin.
- HESSE UND DÖFLEIN 1914 Tierbau und Tierleben. Leip. u. Berlin.
- HOME 1802 A description of the anatomy of *Ornithorhynchus paradoxus*. *Phil. Trans.*, p. 67.
- JAPHA, A. 1911 Die Haare der Waltiere. *Zool. Jahrb. (Anat.)*, Bd. 32.
1911 Ueber die Haare der Wale. *Verh. Ges. der Naturfor.*, Leip., Bd. 82, S. 168.
- KAZZANDER, J. 1910 Nochmals zur Biologie der *Talpa europaea* (Haarapparat am Fuss). *Anat. Anz.*, Jena, Bd. 37, S. 4.
- KEIBEL, F. 1895 Ontogenie und Phylogenie von Haar und Feder. *Ergb. der Anat.*, Bd. 5, S. 619.
- KIDD, W. 1901 Use inheritance illustrated by the direction of the hair on the bodies of animals. London.
1902 Hair slope in connection with habits. *Proc. Zool. Soc.*, Lond., vol. 2, p. 145.
1903 Notes on the hair slope of four typical mammals (otter, dog, ox, and horse). *Proc. Zool. Soc.*, Lond., vol. 1, p. 79.
1914 The direction of hair in animals and man. New York.
- KÜKENTHAL, W. 1909 Untersuchungen an Walen. *Jen. Zeitschr. für Naturwiss.*, Bd. 45, S. 545.
- LAMPERT, M. 1910 Contributions a l'étude des poils de l'homme et des animaux. Paris.
- LANGLEY J. N. 1901 Practical histology.
- LATTEUX, P. 1887 Manuel de technique microscopique. Paris.
- LEYDIG 1859 Ueber die äusseren Bedeckungen der Säugethiere. *Archiv. für Anat. Phys. u. Wiss. Med.*, S. 677.
- LORENZ, L. 1909 Betrachtung ueber das Haarkleid der Säugetiere. *Verh. der Zool.-Bot. Gesell. zu Wein.*, Bd. 59 S. 271.
- MECKEL 1826 *Ornithorhynchi paradoxi* Descriptio Anatomica.
- MEIJERE 1894 Ueber die Haare der Säugethiere, besonders ueber ihre Anordnung. *Morph. Jahrb.*, Bd. 21, S. 312.
- MERTSCHING, A. 1888 Beiträge zur Histologie des Haares und Haarbalges. *Archiv für mikr. Anat.*, Bd. 31, S. 32.
- MEYER-LIERHEIM, F. 1910 Die Dichtigkeit der Behaarung beim Fetus des Menschen und der Affen. *Zeitschr. Morph.*, Stuttgart, Bd. 13, S. 131.
- PERON ET LESSUEUR Voyage de Decouvertes aux Terre Australe pendant les années 1880-1884.
- PINKUS, F. 1906 Ueber der Haarscheiben der Monotremen. *Zool. Forschungsreisen in Australien und dem malayischen Archipel*, R. Semon, 3. Band, 3. Lieferung (in *Denkschr. der Med. Naturwiss. Gesell.*, Jena).

- POULTON 1894 Structure of the bill and hairs of *Ornithorhynchus paradoxus*, etc. Quart. Jour. Mic. Sci., p. 143.
- RAWITZ, B. 1906 Beiträge zur mikroskopischen Anatomie der Cetaceen (Ueber der Feineren Bau der Haare, u. s. w.). Intern. Monatschr., Anat., Leip., Bd. 23, S. 19.
- ROMER, F. 1898 Studien ueber das Integument der Säugetiere. II. Das Integument der Monotremen. Zool. Forschungsreisen in Australien und dem malayischen Archipel, R. Semon, 3. Band, 2. Lieferung (in Denkschr. der Med. Naturwiss. Gesell., Jena).
- SARASIN, P. 1912 Ueber die zoologische Schätzung der sogenannten Haarmenschen. u. s. w. Zool. Jahrb. Suppl., S. 289.
- SCHWALBE, G. 1909 Ueber die Richtung der Haare bei Säugetiere, speziell beim Menschen. Müncher med. Wochenschr., Bd. 56, S. 315.
1911 Ueber die Richtung der Haare bei den Affenembryonen, u. s. w.
1912 Mitteilungen ueber die Haare, besonders ueber ihre Richtung. Mitt. Philomath. Ges. Strass., Bd. 4, S. 517.
- SPENCER AND SWEET 1898-99 The structure and development of the hairs of monotremes and marsupials. Part I. Monotremes. Quart. Jour. Mic. Sci., p. 549.
- TOLDT, K. JUN. 1905 Ueber das Genus *Proechidna*. Ver. der E. K. Zool. Bot. Gesell. zu Wien, Bd. 55, S. 5.
1906 Ueber das Haar- und Stachelkleid von *Zaglossus*, Gill (*Proechidna* Gervais). Ann. des K. K. Naturhist. Hofmus., Bd. 21, S. 1.
1906 Interessante Haarformen bei einem kurzschnabeligen Ameisenigel. Zool. Anz., Bd. 30, S. 305.
1907-08 Studien ueber das Haarkleid von *Vulpes vulpes*, L. Ann. des K. K. Naturhist. Hofmus. Wien, Bd. 22, S. 197.
1909 Betrachtung über das Haarkleid der Säugetiere. Wien. Verh. Zool. Bot. Gesell., Bd. 59, S. 271.
1910 Ueber eine Beachtenswerte Haarsorte und ueber das Haarformensystem der Säugetiere. Wien Ann. Naturhist. Hofmus., Bd. 24, S. 195.
1912 Beiträge zur Kenntnis der Bahaarung der Säugetiere. Zool. Jahrb. Jena, Abt. f. Sys., Bd. 33, S. 9.
1912 Epidermusstreifen, Haareiben, und Wiltzeichnung in der Entwicklung der Hauskatze. Wien. Verh. Zool. Bot. Gesell., Bd. 16.
1913 Ueber die äussere Körpergestalt eines Fetus von *Elephas maximus*. Wien, Denkschr. der Akad. Wiss. Med. Nat. Klasse, Bd. 90, S. 259.
- VAN DE HOEVEN 1823 Memoire sur le Genre *Ornithorhynque*, Nova Acta. Acad. Caes. Leop., vol. 11, p. 351.
- WALDEYER 1884 Atlas der menschlichen und tierischen Haare, sowie der ähnlichen Fasergebilde. Lahr.
- WEBER, M. 1904 Die Säugethiere. Jena.

PLATE 1

EXPLANATION OF FIGURES

1 Outline drawing of *Ornithorhynchus anatinus*, to show the location of the various hair tracts. *A*, modified shield hair of the chin; *B*, fur hair of the ear; *C*, area of pigmented, truncated shield hair; *D*, area of unpigmented, truncated shield hair; *E*, truncated shield hairs of feet and venter of tail; *F*, shield hair of dorsum; *G*, large shield hair of dorsum of tail. The areas *E* and *G* lack the fur hair. None of the areas are sharply defined (with the exception of the area of the ear), but merge gradually into one another. $\times \frac{1}{4}$.

2 Arrangement of the follicles of the shield hair and fur hair on the dorsum (after Meijere). *A*, shield hair; *B*, bundles of fur hair. $\times 200$.

3 to 11 illustrate the various types of hair found on *Ornithorhynchus* (cir. nat. size).

3 Shield hair from the dorsum.

4 Shield hair from midway between the eyes.

5 Shield hair from the proximal end of the tail.

6 Shield hair from the distal end of the tail.

7 Shield hair from the venter.

8 Modified shield hair from the chin.

9 Fur hair of the dorsum and venter.

10 Fur hair from the area of the ear.

11 Shield hair from the area of the ear.

12 Guide figure.

13 Shield hair at point *o*, figure 12, showing the cuticular scales. *M*, medulla; *CO*, cortex. $\times 800$.

14 Shield hair at *m-n*, figure 12. *B*, shaft; *C*, isthmus; *D*, shield; *M*, medulla; *CO*, cortex. $\times 800$.

15 Shaft of shield hair at *p*, figure 12. *M*, medulla; *CO*, cortex. $\times 800$.

16 Shaft of shield hair below *q*, figure 12. *B*, bulb; *M*, medulla; *CO*, cortex. $\times 800$.

17 Shield of shield hair. *M*, medulla; *CO*, cortex; *CU*, cuticle; *M'*, vestiges of the medulla which often persist near the base of the shield. $\times 400$.

18 Guide figure.

19 Transverse section through various portions of the shield as shown by the guide figure, figure 18. Letters indicate where the sections were made. Note the greater thickness of the cuticle on the ectal surface of the shield. $\times 90$.

20 Transverse sections through the shaft of the shield hair, midway from the base of the shaft to the isthmus. *M*, medulla; *CU*, cuticle; *CO*, cortex. $\times 280$.

21 Transverse section through the shaft of the shield hair near the base of the shaft just above the mouth of the follicle. *M*, medulla; *CU*, cuticle; *CO*, cortex. $\times 280$.

22 Shaft of the shield hair, dissected. *CU*, cuticle, intact; *CO*, long distorted cells of the cortex exposed, after the removal of the cuticular scales; *M*, medullary cells exposed after the removal of the cortex element. $\times 2400$.

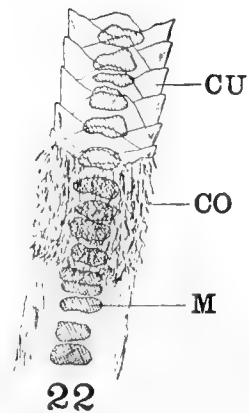
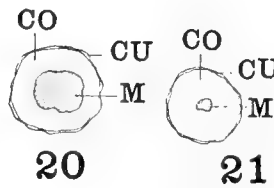
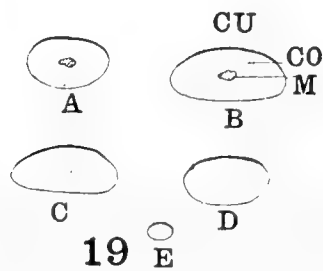
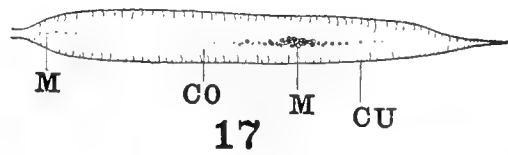
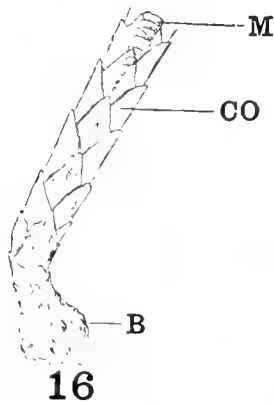
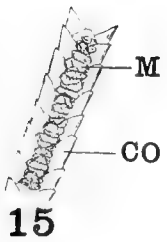
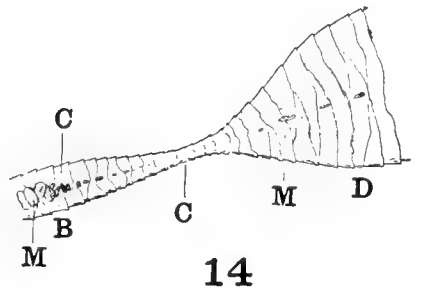
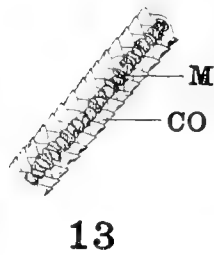
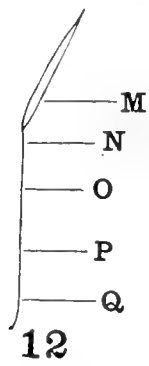
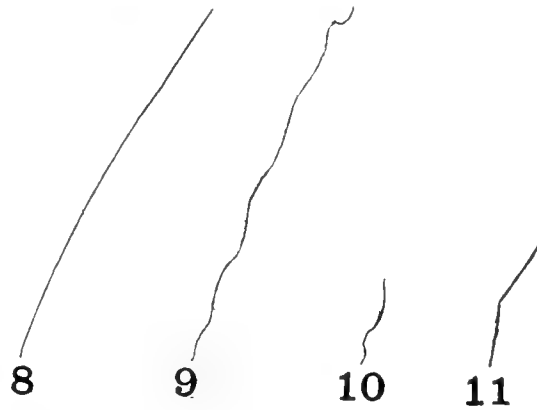
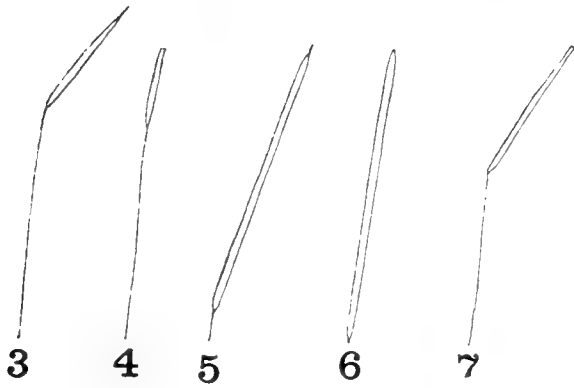
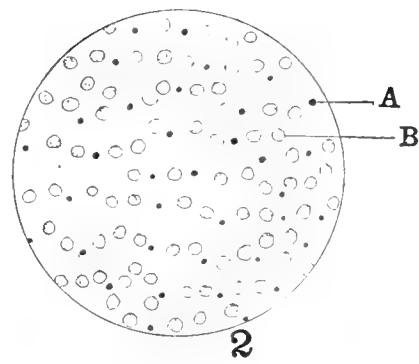
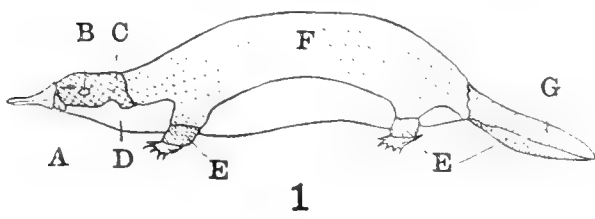
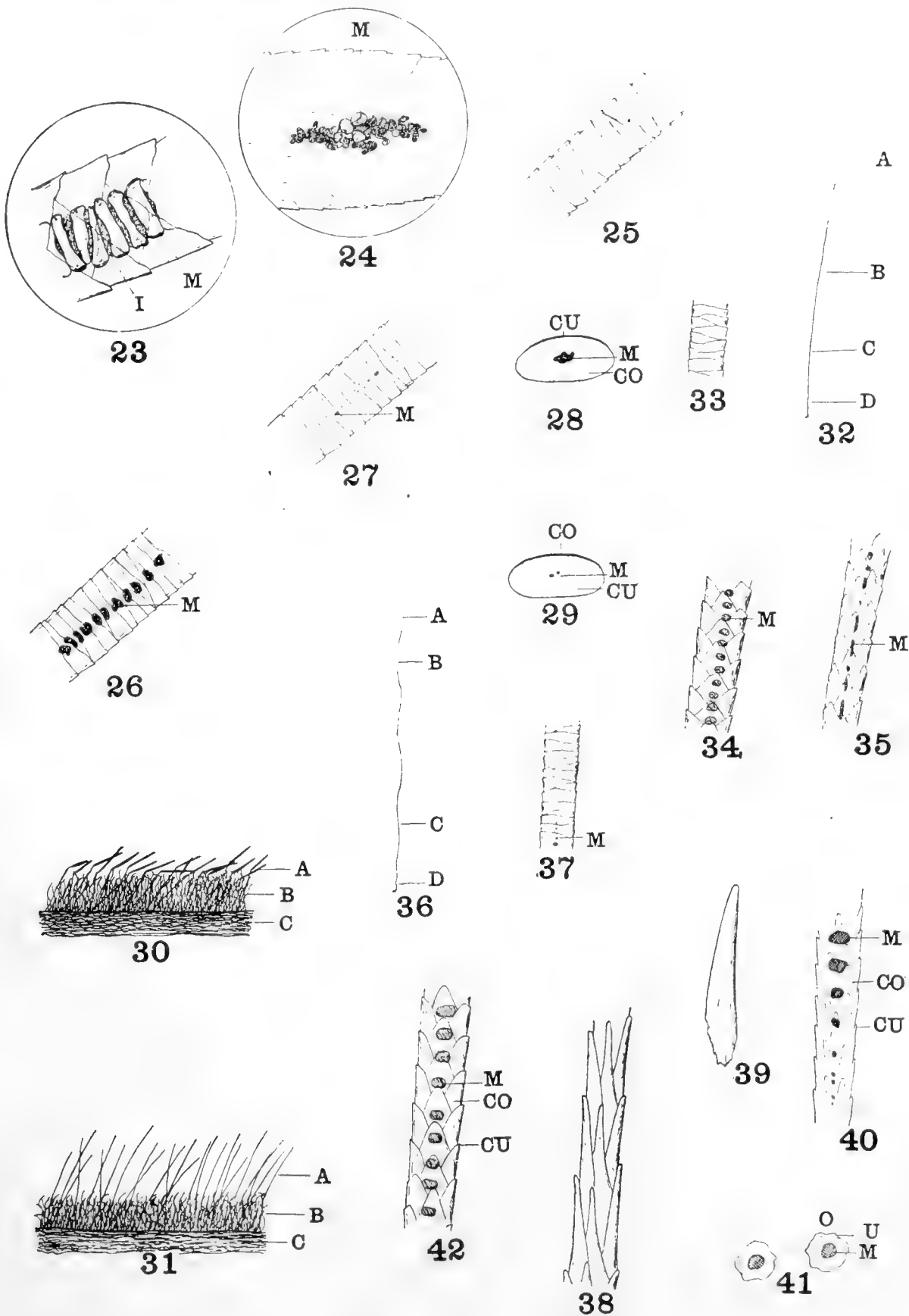

PLATE 2

EXPLANATION OF FIGURES

- 23 Medulla of the shield hair in the shaft below the isthmus. *M*, medullary cell; *I*, interstitial or intermedullary space. $\times 4000$.
- 24 Medulla of the shield hair midway between the isthmus and the tip of the shield. *M*, medullary cell. $\times 200$.
- 25 Shield hair of the tail, near the base. $\times 535$.
- 26 Shield hair of the tail, midway from base to tip. *M*, medulla. $\times 45$.
- 27 Shield hair of the feet, midway from base to tip. *M*, medulla. $\times 45$.
- 28 Section through the shield hair of the tail, midway from base to tip. *M*, medulla; *CU*, cuticle; *CO*, cortex. $\times 73$.
- 29 Section through shield hair of the feet, midway from base to tip. *M*, medulla; *CU*, cuticle; *CO*, cortex. $\times 73$.
- 30 Showing the relations of the shield and fur hair on the dorsum of *Ornithorhynchus*. *A*, shield hair; *B*, fur hair; *C*, skin. $\times \frac{1}{2}$.
- 31 Showing the relations of the modified shield and fur hair on the chin area of *Ornithorhynchus*. *A*, modified shield hair; *B*, fur hair; *C*, skin. $\times \frac{1}{2}$.
- 32 Guide figure.
- 33 Modified shield hair of chin, at *A*, figure 32. $\times 200$.
- 34 Modified shield hair of chin, at *B*, figure 32. *M*, medulla. $\times 210$.
- 35 Modified shield hair of chin, below *C*, figure 32. $\times 200$.
- 36 Guide figure.
- 37 Fur hair, *A-B*, figure 36. $\times 450$.
- 38 Fur hair, *C-D*, figure 36. $\times 600$.
- 39 Single, isolated cuticular scale from the shaft of the fur hair, near base. $\times 1250$.
- 40 Fur hair at the base. *M*, medulla; *CU*, cuticle; *CO*, cortex. $\times 650$.
- 41 Transverse section through the shaft of the fur hair, midway between the base and tip. *M*, medulla; *CU*, cuticle; *CO*, cortex. $\times 700$.
- 42 Shaft of the fur hair, midway between the base and tip. *M*, medulla; *CU*, cuticle; *CO*, cortex. $\times 750$.



EXPLANATION OF FIGURES

43 Outline drawing of *Tachyglossus hystrix*, to show the location of the various spine and hair tracts. *A*, small spines of the auricular depression; *B* and *B'*, curved spines and spiny hairs of the flanks; *C* and *C'*, curved spines and spiny hairs of the feet; *D*, caudal spines; *E*, wavy hair of the auricular depression; *F*, hip tufts of spines; *G*, large spines and hairs of the dorsum; *H*, short spines and spiny hairs of the head; *I*, long spiny and wavy hairs of the venter. $\times \frac{1}{5}$.

44 Arrangement of spines and hairs upon the dorsum and sides of *Tachyglossus* (after Römer). $\times \frac{1}{5}$.

45 Small wavy hair from the venter. $\times \frac{1}{2}$.

46 Long wavy hair from the venter. $\times \frac{1}{2}$.

47 Long spiny hair from the venter. $\times \frac{1}{2}$.

48 Long spiny hair from venter. $\times \frac{1}{2}$.

49 Curved spiny hair from fore flank. $\times \frac{1}{2}$.

50 Small spine from fore flank. $\times \frac{1}{2}$.

51 Small spine from near auricular depression. $\times \frac{1}{2}$.

52 Large spine from dorsum. $\times \frac{1}{2}$.

53 Large spine from hip tuft. $\times \frac{1}{2}$.

54 Largest of the spines from near the median line of the dorsum. *A*, pigmented portion; *B*, unpigmented portion; *C*, isthmus; *D* to *E*, portion within the follicle (bulb). $\times \frac{1}{2}$.

55 Largest of the spines from the hip tufts, or from the lateral caudal tufts. *A*, pigmented portion; *B*, unpigmented portion; *C*, isthmus; *D* to *E*, portion within the follicle (bulb). $\times \frac{1}{2}$.

56 Smaller, 'black spine' from near the median line of the dorsum, or from the median dorsal line of the tail. *A*, pigmented portion; *B*, unpigmented portion; *C*, isthmus; *D* to *E*, portion within follicle (bulb). $\times \frac{1}{2}$.

57 Smallest of the spines of the body, unpigmented, and more acuminate than any of the others, from the sides of the body, top of the head, auricular depression, or periphery of tail. *B*, unpigmented portion; *C*, isthmus; *D* to *E*, portion within the follicle (bulb). $\times \frac{1}{2}$.

58 Flattened, smewhat spiny hair, from near the median line of the dorsum. *A*, top of view; *B*, lateral view. $\times 1\frac{1}{2}$.

59 Slightly finer wavy hair from near the side of the body where the smaller spines begin to appear. *A*, top view; *B*, lateral view. (cir. nat. size.)

60 Slender, pigmented spine, from lateral caudal tuft. *A*, pigmented portion; *B*, unpigmented portion; *C*, isthmus; *D* to *E*, portion within the follicle (bulb). $\times \frac{1}{2}$.

61 Slender, unpigmented spine, from lateral caudal tuft. *B*, unpigmented portion; *C*, isthmus; *D* to *E*, portion within the follicle (bulb). $\times \frac{1}{2}$.

62 Small spine from top or sides of head, or from the auricular depression. *B*, unpigmented portion; *C*, isthmus; *D*, portion within the follicle (bulb). $\times 2$.

63, 64, and 65 Forms of the spiny hairs of the head. *C*, isthmus; *D*, portion within the follicle (bulb). $\times 2\frac{1}{2}$.

66 Wavy hairs from beneath the spines and spiny hairs and from the auricular depression. *D*, portion within the follicle (bulb). (cir. nat. size.)

67 Long spiny hairs, the longest on the body, from the venter. *A*, top view; *B*, lateral view; *C*, isthmus; *D*, portion within the follicle (bulb). (cir. nat. size.)

68 Short spiny, somewhat wavy hairs, from the venter. *A*, top view; *B*, lateral view; *C*, isthmus; *D*, portion within the follicle (bulb). $\times 1\frac{1}{2}$,

69 Long wavy hairs, the longest on the body from venter. $\times \frac{1}{2}$.

70 Guide figure.

71 Tip of flattened spiny hair from near the median line of the dorsum, from *A-B*, figure 70. $\times 170$.

72 Section of the same hair between *B-C*, figure 70. *M*, medulla. $\times 120$.

73 Section of the same hair, between *C-D*, figure 70. *M*, medulla. $\times 120$.

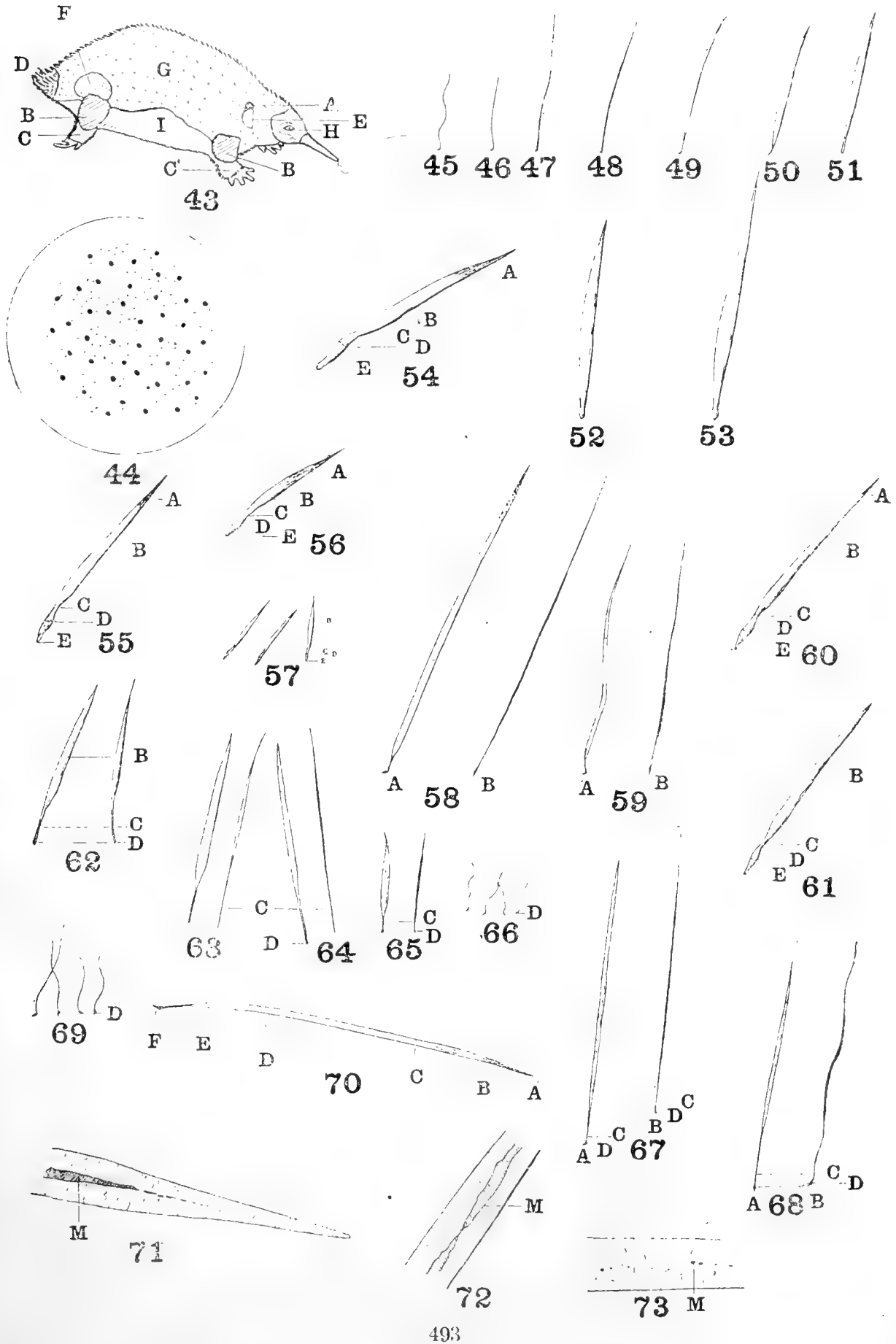
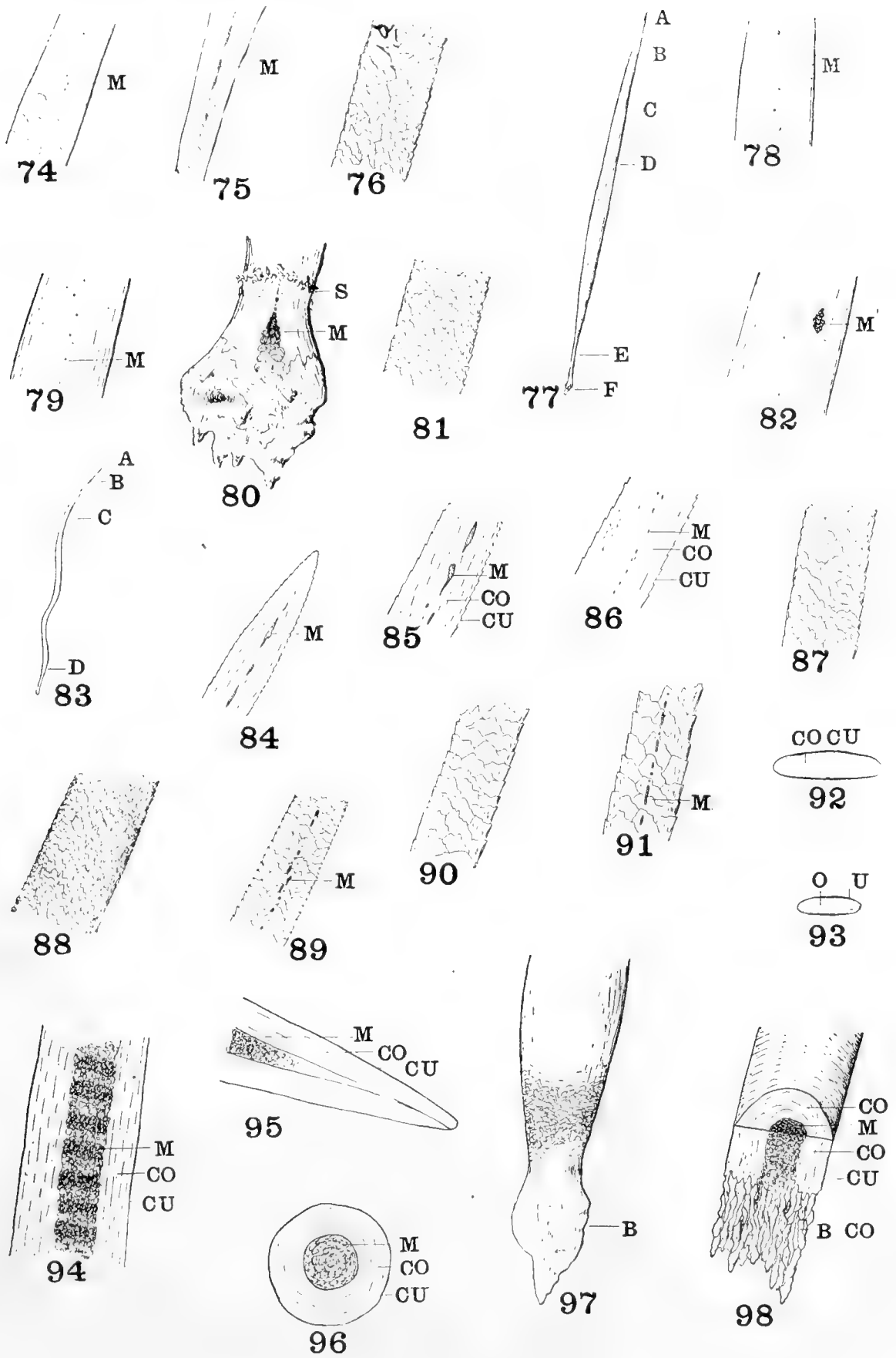

PLATE 4

EXPLANATION OF FIGURES

- 74 Section of the same hair, between *D-E*, figure 70. *M*, medulla. × 120.
- 75 Section of the same hair, between *E-F*, figure 70. *M*, medulla × 120.
- 76 Cuticular scales of the same hair, midway between the base and tip. × 175.
- 77 Guide figure.
- 78 Section of the spiny flattened hair of the top of the head, between *B-C*, figure 77. *M*, medulla. × 20.
- 79 Section of the same hair, between *C-D*, figure 77. *M*, medulla. × 22.
- 80 Bulb of the same hair, at *F*, figure 77. *M*, medulla; *S*, level of the epidermis (mouth of the follicle). × 32.
- 81 Cuticular scales of the same hair at point *D*, figure 77. × 20.
- 82 Section of the same hair, near *D*, figures 77, showing the isolated group of adventitious medullary cells sometimes present in different portions of the shaft. *M*, medullary cells. × 27.
- 83 Guide figure.
- 84 Tip of the wavy hair from the auricular depression, at the pigmented portion, *A-B*, figure 83. *M*, medulla. × 500.
- 85 Section of the same hair, between *B-C*, figure 83. *M*, medulla; *CU*, cuticle; *CO*, cortex. × 450.
- 86 Section of the same hair, at *D*, figure 83. *M*, medulla; *CU*, cuticle; *CO*, cortex. × 450.
- 87 Cuticular scales of the same hair, midway between *C-D*, figure 83. × 500.
- 88 Shaft of the flattened spiny hair of the venter, midway between the base and tip. × 18.
- 89 Shaft of the same hair, near the base. *M*, medulla. × 18.
- 90 Shaft of the long wavy hair of the venter, midway between the base and tip. × 40.
- 91 Shaft of the same hair near the base. *M*, medulla. × 40.
- 92 Transverse section of the spiny flattened hair of the venter, midway between the base and tip. *CU*, cuticle; *CO*, cortex. × 20.
- 93 Transverse section of the same hair near the base. *CU*, cuticle; *CO*, cortex. × 20.
- 94 Median longitudinal section through large spine of the dorsum, midway between the base and tip. *M*, medulla; *CU*, cuticle; *CO*, cortex. × 4.
- 95 Median longitudinal section through the tip of the same spine. *M*, medulla; *CU*, cuticle; *CO*, cortex. × 4.
- 96 Transverse section through same spine, midway between the base and tip. *M*, medulla; *CU*, cuticle; *CO*, cortex. × 4.
- 97 Showing the cuticular scales near the base of the same spine. *B*, portion within the follicle (bulb). × 4.
- 98 Stereogram of portion of dorsal spine, sectioned, and with the ectal end broken. The method of fracturing may be indicative of the form of the horny, coalesced, fusiform cuticular cells which compose the cortex of the spine. *M*, medulla; *CU*, cuticle; *CO*, cortex; *B.CO*, broken cortex. × 4.



SUBJECT AND AUTHOR INDEX

- A**CTIVITY on the part of the giant-cells, and to the significance of the so-called mitotic figures in these cells. Further studies on red bone-marrow. I. Experimental. II. Cytologic, with special reference to the data suggesting intracellular hemocytogenic. 287
- Amphibian larvae to injected croton oil (aseptic inflammation). Reactions of cells in the tail of. 221
- ARAI, HAYATO. On the postnatal development of the ovary (albino rat), with especial reference to the number of ova. . . . 405
- Atria. Heart, musculature of the. 255
- B**ANDS and intercalated discs. Studies on striped muscle structure. VI. The comparative histology of the leg and wing muscle of the wasp, with special reference to the phenomenon of stripe reversal during contraction and to the genetic relation between contraction. 1
- BAUMGARTNER, E. A., NELSON, M. T., AND DOCK, WM. Development of the uterine glands in man. 207
- BEGG, ALEXANDER S. Absence of the vena cava inferior in a 12-mm. pig embryo, associated with the drainage of the portal system into the cardinal system. 395
- Bone-marrow. I. Experimental. II. Cytologic, with special reference to the data suggesting intracellular hemocytogenic activity on the part of the giant-cells, and to the significance of the so-called mitotic figures in these cells. Further studies on red. 287
- C**ARDINAL system. Absence of the vena cava inferior in a 12-mm. pig embryo, associated with the drainage of the portal system into the. 395
- Cava inferior in a 12-mm. pig embryo, associated with the drainage of the portal system into the cardinal system. Absence of the vena. 395
- Cells, and to the significance of the so-called mitotic figures in these cells. Further studies on red bone-marrow. I. Experimental. II. Cytologic, with special reference to the data suggesting intracellular hemocytogenic activity on the part of the giant. 287
- Cells in the tail of Amphibian larvae to injected croton oil (aseptic inflammation). Reactions of. 221
- CLARK, ELEANOR LINTON, CLARK, ELIOT R., AND. Reactions of cells in the tail of Amphibian larvae to injected croton oil (aseptic inflammation). 221
- CLARK, ELIOT R., AND CLARK, ELEANOR LINTON. Reactions of cells in the tail of Amphibian larvae to injected croton oil (aseptic inflammation). 221
- Content of the kidney tubule. A study of the lipid. 69
- Contraction bands and intercalated discs. Studies on striped muscle structure. VI. The comparative histology of the leg and wing muscle of the wasp, with special reference to the phenomenon of stripe reversal during contraction and to the genetic relation between. 1
- Croton oil (aseptic inflammation). Reactions of cells in the tail of Amphibian larvae to injected. 221
- D**EVELOPMENT of the ovary (albino rat), with especial reference to the number of ova. On the postnatal. 405
- Discs. Studies on striped muscle structure. VI. The comparative histology of the leg and wing muscle of the wasp, with special reference to the phenomenon of stripe reversal during contraction and to the genetic relations between contraction bands and intercalated. 1
- DOCK, WM., BAUMGARTNER, E. A., NELSON, M. T., AND. Development of the uterine glands in man. 207
- E**MBRYO, associated with the drainage of the portal system into the cardinal system. Absence of the vena cava inferior in a 12-mm. pig. 395
- Evolution in the mammalia. A critique of the theories of pulmonary. 99
- F**IGURES in these cells. Further studies on red bone-marrow. I. Experimental. II. Cytologic, with special reference to the data suggesting intracellular hemocytogenic activity on the part of the giant-cells, and to the significance of the so-called mitotic. 287
- G**IANT-CELLS, and to the significance of the so-called mitotic figures in these cells. Further studies on red bone-marrow. I. Experimental. II. Cytologic, with special reference to the data suggesting intracellular hemocytogenic activity on the part of the. 287
- Glands in man. Development of the uterine. 207
- H**AIR structure of the Monotremata. A micrological investigation of the. 463
- HAUSMAN, LEON AUGUSTUS. A micrological investigation of the hair structure of the Monotremata. 463
- Heart, musculature of the atria. 255
- Hemocytogenic activity on the part of the giant-cells, and to the significance of the so-called mitotic figures in these cells. Further studies on red bone-marrow. I. Experimental. II. Cytologic, with special reference to the data suggesting intracellular. 287
- Human lung. The finer ramifications of the. 315
- HUNTINGTON, GEO. S. A critique of the theories of pulmonary evolution in the mammalia. 99

- I**NFERIOR in a 12-mm. pig embryo, associated with the drainage of the portal system into the cardinal system. Absence of the vena cava. 395
- I**nflammation). Reactions of cells in the tail of Amphibian larvae to injected croton oil (aseptic). 221
- I**ntercalated discs. Studies on striped muscle structure. VI. The comparative histology of the leg and wing muscle of the wasp, with special reference to the phenomenon of stripe reversal during contraction and to the genetic relation between contraction bands and. 1
- I**ntracellular hemocytogenic activity on the part of the giant-cells, and to the significance of the so-called mitotic figures in these cells. Further studies on red bone-marrow. I. Experimental. II. Cytologic, with special reference to the data suggesting. 287
- J**ORDAN, H. E. Further studies on red bone-marrow. I. Experimental. II. Cytologic, with special reference to the data suggesting intracellular hemocytogenic activity on the part of the giant-cells, and to the significance of the so-called mitotic figures in these cells. 287
- J**ORDAN, H. E. Studies on striped muscle structure. VI. The comparative histology of the leg and wing muscle of the wasp, with special reference to the phenomenon of stripe reversal during contraction and to the genetic relation between contraction bands and intercalated discs. 1
- K**IDNEY tubule. A study of the lipid content of the. 69
- L**ARVAE to injected croton oil (aseptic inflammation). Reactions of cells in the tail of Amphibian. 221
- L**eg and wing muscle of the wasp, with special reference to the phenomenon of stripe reversal during contraction and to the genetic relation between contraction bands and intercalated discs. Studies on striped muscle structure. VI. The comparative histology of the. 1
- L**ipoid content of the kidney tubule. A study of the. 69
- L**ung The finer ramifications of the human
- L**ungs. Contributions to the histology of the respiratory spaces of the vertebrate. 333
- M**AMMALIA. A critique of the theories of pulmonary evolution in the. 99
- M**arrow. I. Experimental. II. Cytologic, with special reference to the data suggesting intracellular hemocytogenic activity on the part of the giant-cells, and to the significance of the so-called mitotic figures in these cells. Further studies on red-bone- 287
- M**itotic figures in these cells. Further studies on red bone-marrow. I. Experimental. II. Cytologic, with special reference to the data suggesting intracellular hemocytogenic activity on the part of the giant-cells, and to the significance of the so-called. 287
- M**onotremata. A micrological investigation of the hair structure of the. 463
- M**uscle structure. VI. The comparative histology of the leg and wing muscle of the wasp, with special reference to the phenomenon of stripe reversal during contraction and to the genetic relation between contraction bands and intercalated discs. Studies on striped. 1
- M**usculature of the atria. Heart. 255
- N**ELSON, M. T., AND DOCK, WM., BAUMGARTNER, E. A. Development of the uterine glands in man. 207
- N**umber of ova. On the postnatal development of the ovary (albino rat), with especial reference to the. 405
- O**GAWA, CHIKANOSUKE. Contribution to the histology of the respiratory spaces of the vertebrate lungs. 333
- O**GAWA, CHIKANOSUKE. The finer ramifications of the human lung. 315
- O**il (aseptic inflammation). Reactions of cells in the tail of Amphibian larvae to injected croton. 221
- O**va. On the postnatal development of the ovary (albino rat), with especial reference to the number of. 405
- O**vary (albino rat), with especial reference to the number of ova. On the postnatal development of the. 405
- P**APEZ, JAMES W. Heart, musculature of the atria. 255
- P**ig embryo, associated with the drainage of the portal system into the cardinal system. Absence of the vena cava inferior in a 12-mm. 395
- P**ortal system into the cardinal system. Absence of the vena cava inferior in a 12-mm. pig embryo, associated with the drainage of the. 395
- P**ulmonary evolution in the mammalia. A critique of the theories of. 99
- R**AT), with especial reference to the number of ova. On the postnatal development of the ovary (albino 405
- R**eactions of cells in the tail of Amphibian larvae to injected croton oil (aseptic inflammation). 221
- R**ed bone-marrow. I. Experimental. II. Cytologic, with special reference to the data suggesting intracellular hemocytogenic activity on the part of the giant-cells, and to the significance of the so-called mitotic figures in these cells. Further studies on. 287
- R**espiratory spaces of the vertebrate lungs. Contributions to the histology of the. 333
- S**MITH, CHRISTIANNA. A study of the lipid content of the kidney tubule. 69
- S**paces of the vertebrate lungs. Contributions to the histology of the respiratory. 333
- S**triped muscle structure. VI. The comparative histology of the leg and wing muscle of the wasp, with special reference to the phenomenon of stripe reversal during contraction and to the genetic relation between contraction bands and intercalated discs. Studies on. 1
- S**tructure of the Monotremata. A micrological investigation of the hair. 463
- S**tructure. VI. The comparative histology of the leg and wing muscle of the wasp, with special reference to the phenomenon of stripe reversal during contraction and to the genetic relation between contraction bands and intercalated discs. Studies on striped muscle. 1
- S**ystem. Absence of the vena cava inferior in a 12-mm. pig embryo, associated with the drainage of the portal system into the cardinal. 395
- S**ystem into the cardinal system. Absence of the vena cava inferior in a 12-mm. pig embryo, associated with the drainage of the portal. 395

| | | | |
|---|-----|--|---|
| T AIL of Amphibian larvae to injected croton oil (aseptic inflammation). Reactions of cells in the..... | 221 | W ASP, with special reference to the phenomenon of stripe reversal during contraction and to the genetic relation between contraction bands and intercalated discs. Studies on striped muscle structure. VI. The comparative histology of the leg and wing muscle of the..... | 1 |
| T ubule. A study of the lipoid content of the kidney..... | 69 | W ing muscle of the wasp, with special reference to the phenomenon of stripe reversal during contraction and to the genetic relation between contraction bands and intercalated discs. Studies on striped muscle structure. VI. The comparative histology of the leg and..... | |
| U TERINE glands in man. Development of the..... | 207 | | |
| V ENA cava inferior in a 12-mm pig embryo, associated with the drainage of the portal system into the cardinal system. Absence of the..... | 395 | | |
| V ertebrate lungs. Contributions to the histology of the respiratory spaces of the.... | 333 | | |





MBL WHOI Library - Serials



5 WHSE 02079

