



THE AMERICAN

MONTHLY

MICROSCOPICAL JOURNAL:

CONTAINING

CONTRIBUTIONS TO BIOLOGY.

VOLUME X

FOR

1889.

FOUNDED IN 1880, BY ROMYN HITCHCOCK, F. R. M. S.

PUBLISHED, SINCE 1887, BY CHAS. W. SMILEY,

WASHINGTON, D. C.

611514
4.7.55

QH
201
A32
7.11

LIST OF ILLUSTRATIONS.

	PAGE.
Common Mould (plate)	1
Eye of the Cray-fish (plate)	25
Zeiss Microscope Stand B, medium size (plate)	49
Zeiss Achromatic Condenser (figure)	51
Zeiss Heating Oven (figure)	51
Zeiss Sliding Objective Changer (figure)	52
Zentmayer's Abbe Condenser (figure)	60
Desmids (plate)	73
King Microtome (figure)	83
Bacteria (plate)	97
Zeiss Photo-micrographic Apparatus (plate)	121
Zeiss Photo-micrographic Apparatus for Vertical Microscope (figure)	122
Tentacle-bearing Animalcule (plate)	145
Spores of Plant Rusts (plate)	169
Inferior Side of Barberry Leaf (figure)	173
Section of <i>Æcidium</i> Fruit of <i>Æcidium hepaticarum</i> (figure)	176
Section of Liver Containing Eggs of a Worm (plate)	193
Apparatus for Examining Blood (plate)	217
Apparatus for Examining Blood (plate)	241
Frog-plate and Irrigating Apparatus (figure)	244
Thoma's Apparatus for Studying Circulation of the Blood (figure)	245
Lighton's Dark-field Illumination (plate)	265
Griffith's Fine Adjustment (figures)	272

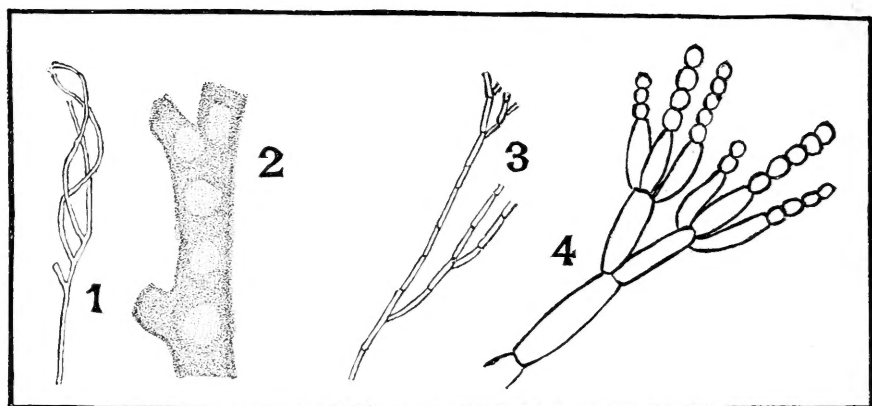

A COMMON MOULD,
(*PENCILLIUM GLAUCUM.*)

THE AMERICAN MONTHLY MICROSCOPICAL JOURNAL.

VOL. X.

JANUARY, 1889.

No. 1.

All communications for this Journal, whether relating to business or to editorial matters, and all books, pamphlets, exchanges, etc., should be addressed to American Monthly Microscopical Journal, Box 630, Washington, D. C.

European subscriptions may be sent directly to the above address accompanied by International Postal Order for \$1.15 per annum, or they may be sent to Messrs. Trübner & Co., 57 Ludgate Hill, London, accompanied by the yearly price of five shillings.

Examination of Mould. (*Pencillium glaucum*.)

BY PROF. H. L. OSBORN.

HAMLIN, MINN.

Every one is familiar with mould, such as accumulates on bread, jelly or old boots after they have been left in damp places. Not every one, however, knows that mould is a vegetable and few understand its real nature. With a microscope of good power (250 dia.) one can see most of what is herein described; with 350 diameters everything will be made clear to the careful observer.

There are many kinds of mould. Some are not *Pencillium* at all; others are quite like it, varying only in minute particulars. That is, not all mould is *Pencillium* and not all *Pencillium* is *P. glaucum*. But this description will nearly fit any *Pencillium* and aid the student in examining whatever species he happens to find. To be sure of getting a specimen of *Pencillium*, put a moist cracker in a damp place for 48 hours and then examine it for a sage-green spot which will probably appear. *Pencillium* is recognized with the naked eye by its color, by the low film it forms where it is attached, and by the fine dust which can be blown from its surface. Other moulds common to such places are either of a different color or they form a fuzzy, thicker growth, reaching from $\frac{1}{2}$ to $\frac{3}{4}$ inch over the "moulding" surface.

1. **Gross Anatomy.**—Observe with naked eye the velvety appearance of the surface of *Pencillium*. Let fall a drop of water upon it from a dropping tube, and notice (1) the powdery dust which the drop has disturbed and which forms a fine cloud, soon dissipated, and (2) that the water does not spread and moisten the surface of the film, but remains in droplets which can be shaken off the film. But alcohol and some other fluids so dropped upon it spread and moisten it.

A few instructive experiments may be named:—First, arrange six vessels (tumblers are good) in pairs—two of distilled water, two of distilled and sweetened water (using sugar enough to make a weak syrup), and two containing moistened cracker or cake. Holding over each vessel a piece of mould, shake off upon the water and moist

cracker some of the dust. Cover each tumbler with paper to keep out dust but to let in air. Put them away, a set of three in a moist *dark* place, a set of three in a moist *light* place. In the pure water, whether in the dark or the light place, two or three days will have produced no change. In the syrup or the cake, from both places, spots of green will have appeared upon the surface. Therefore, mould grows in the dark as well as in the light, and will not grow in water containing no organic matter.

In similar ways it may be shown that mould grows well on meat broth and other watery media; that it grows faster in warm places and slower in cold places.

2. **Examination with Low Power.**—Upon the tip of a needle catch the smallest possible speck of mould, add a drop of water, cover it and place under the low power. There will perhaps appear some very fine threads, but mainly a great dimness with some very dark curved lines. This mount is a failure, proving that water is not a universal mounting medium. That might have been suspected from the water not moistening the film when first tried. Begin again with the needle, and now use alcohol upon the slide. When viewed under the microscope it will appear that the mould is made up of fibres matted together. These will show still better under the high powers. Before using them, mount a new slide in alcohol, carefully teasing the speck of mould before covering it. To “tease” it, take a needle in each hand, hold down the speck with one needle and pull the mould away with the other one. This separates the fibres for easier inspection. As the alcohol evaporates rapidly meanwhile, some more must be added from time to time, getting it under the cover with a pipette.

3. **Under High Power.**—The teased speck now appears to be a great complex of fine wavy threads. They make up the large part of the mould, and are called *Hyphæ* (webs) because of their being matted and woven together. These are of two kinds:—(1) which run indefinitely, many having no cross partitions; (2) which are broken by transverse joints and which terminate in branches tipped with small spheres. Besides these two kinds of *hyphæ* numerous small spheres called *conidia* will be found in the mount. The *hyphæ* and *conidia* together constitute the mould. The next question is, how are they put together? If a mould growing on a fluid-like broth be carefully examined one can see that it consists of a coat or scum which floats on the fluid, and that from this, called the *mycelium*, *hyphæ* carrying the dust before noticed are borne aloft into the air. These are invisible to the naked eye, but careful examination of bits caught with the needle from such a film convinces you that there are two kinds of *hyphæ*, those of the *mycelium* and others arising from them into the air.

4. **The Mycelial Hyphæ.**—A single thread from the complex, under medium power, is illustrated in figure 1 of the plate. Observe the long and narrow, flexuous, and parallel-sided thread or *hypha*: that it branches frequently; that these branches are of equal diameter with the main stem; that the stem is not empty but contains something, and that the stem is one continuous tube through all its length and not broken by subdividing cross-walls. The older mycelial *hyphæ* are not one single tube, but, like the aerial *hyphæ*, are transversely divided. In newly raised *mycelium* many of the undivided ones will be found.

which, when older, will become broken up by partitions. It is well to draw one or more of the hyphæ with all the branches. While doing this it may be necessary to move the slide about. If so, care should be taken not to draw different parts of the hyphæ on different scales. A camera lucida will help in drawing.

Having noted carefully and drawn the outline of one hypha of the mycelium, next, with the highest magnifying powers and best illumination, examine in greater detail some single portion of one of these hyphæ. Its interior will show patches of lighter and darker color. Very skilful staining would help in demonstrating these, but it is rather difficult. To stain, irrigate with hæmatoxylin, which, when afterward cleared with alcohol, will make the light and dark patches more conspicuous. Careful study of the lighter patches will show that they are vacant spaces in the centre of the hypha surrounded by a darker exterior substance. The former are vacuoles; the latter, the protoplasm, of the hypha. Along the tube in the protoplasm may be seen dark spots, the nuclei of the protoplasm. The hypha is not green colored, and contains no trace of green bodies such as are found in protococcus. The mycelial hyphæ being left for a day or two in pure water the contents of the hyphæ will disappear, and the clear, empty hyphæ will be seen like the dead cell-walls of yeast. They have no power to retain life except they be fed. See figure 2.

5. **The Aerial Hyphæ.**—These are derived by branching from the mycelial hyphæ. They are short and cut across by transverse partitions, as are some of the mycelial hyphæ near where they arise. These hyphæ are peculiar because of the very complicated growth to be found at their tips. The plan of arrangement at the tips of the erect hyphæ is not easy to discover. It is helpful to mount the specimen in dilute caustic potash (5%), but it can be made out in an alcoholic mount. It will be seen that the small spheres or conidia are arranged in rows like a string of beads, and at the base of each row a single large piece can be seen (fig. 4). This is the *basidium*. One of these basidia is at the base of each row of conidia. Several basidia are carried in turn by one joint and a similar joint bearing a similar lot of basidia and conidia, or perhaps several others may be borne upon the end of one erect hypha. All these parts form a sort of broom-shaped expansion on the hypha, far more complicated in fact than is shown in the figure. Closer examination of the basidium will show that it is pointed above; that the conidium grows from this cone, and that the other conidia are held together by a fine connective piece not shown in the figure. When these observations have all been made and recorded by sketches, the chief facts in the structure of the mould will have been made out.

6. **Physiology.**—The uses of the various parts of this organism may be noted briefly. The mycelium, spread out over the surface of the nutrient host, absorbs from it the substances which as food promote the growth of the parasite. The aerial hyphæ, on the other hand, have nothing to do with absorption of food from the host, and are wholly concerned in producing certain buds—the conidia—which are especially well adapted to a wide distribution from their minute size. The conidia themselves are spores from which may grow an entire new mycelium. Any hypha could grow and produce a mycelium, but the conidia are far more favorable both for preservation and distribution than ordinary

hyphæ. Here, then, is a simple division of labor, one set of hyphæ being nutritive organs, the other reproductive.

7. **Mould a Plant.**—That *Pencilium* is a living organism has now been shown by its power of growth, the forming from spores or conidia of new mycelia.

Its presence on damp and warm nutrient substance is also readily understood when we recall how light the conidia are and how they float off as a cloud of dust. Experiments on the vitality of conidia would show that their power of growth is not at all impaired by drying up, and that examination of the air of closets and rooms would show them to be present. We have then, in the moulding of bread, a very simple condition of affairs, as intelligible as any gardening process.

Following the course of events from the conidium, it first sends out a small tube, which growing longer and longer, branching and re-branching, becomes a hypha, then a mycelium. Later still you would find this mycelium shooting up aerial hyphæ, and these in turn producing conidia like the one we start from. Here, then, is a somewhat more complicated course of life from that observed in yeast, for we have the yeast buds made directly from the body of yeast; but the conidia buds arise not from the body which grows from the conidia (viz., the mycelial hypha), but from the body which grows from it (viz., the aerial hypha). This introduces us to a degree of complication surpassing anything found in yeast or in protococcus. The branching and division of the threads, the new members remaining attached to the mass, make possible the building up of a complex structure like the mycelium. Here, as in all the fungi or moulds, the cells are never formed by longitudinal division but only by transverse division. If mould is an organic being or a living thing, is it animal or plant? We find that the protococcus, which can live and thrive in rain-water by the power it has, through the presence of chlorophyll, can do what no animal can do. It would shortly die in rain-water. Hence we can separate the two by this power through chlorophyll. But is yeast or the mould an animal also? There are reasons based on a study of plants as a whole which make it imperative to consider the mould a plant, but a parasitic plant, one living upon food ready-made, and not elaborating, from simple mineral sources, the complex chemical constituents of its own protoplasmic substance.

Conclusion.—This is hardly the place for any discussion of the numerous biological speculations which are suggested by *Pencilium*, but it may be said that we are here in that realm of the organic world to which the bacteria are believed to belong, and that here started the theory of spontaneous generation from the seemingly spontaneous growth of mould, the conidia being then entirely overlooked.

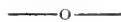

The Hoagland Laboratory, of Brooklyn, N. Y., is now open for work. The director is Dr. Geo. M. Sternberg. Dr. G. T. Kemp, of Johns Hopkins University, who is associate in bacteriology and physiology, will conduct practical courses in bacteriology and physiology during the spring. The medical schools are realizing the importance of thorough scientific work in the medicine of to-day, and providing for it more and more extensively.

The Character of Bacteria.*

By B. M. BOLTON, M. D.,

PROFESSOR OF PHYSIOLOGY, HYGIENE AND BACTERIOLOGY IN THE UNIVERSITY OF SOUTH CAROLINA.

A great many phenomena which occur around us every day are due to the activity of microscopic beings. The subject has aroused very great interest, not only among strictly scientific men, but in persons engaged in other callings as well; for it has been shown that many of the most important processes in nature are caused by bacteria. The subjects which are of most interest to us at present are the decomposition of vegetable and animal matter, and infectious diseases. Strictly speaking, fermentation is not due to bacteria.

Bacteria are very minute plants. They are the smallest living things that we know. Many millions of them together do not weigh as much as a grain of sand. The individual bacterium can only be seen with a microscope of high power. But most of them grow so rapidly that even starting from an invisible amount, they form a mass readily observable with the naked eye in a few days. They form, for the most part, very characteristic masses upon potatoes or nutrient gelatine, so that, even without the microscope, we see marked differences. Their cultures are of various colors, and they differ also in other respects. So we can study bacteria at the present day largely without the microscope.

There are other minute plants which also cause diseases. Certain mould fungi belonging to the same class as the mould every one has seen upon old bread and cheese also cause disease, but bacteria cause such diseases as typhoid fever, cholera, anthrax, etc., and so they are of more interest at present.

Fermentation is caused by the yeast fungi, which are larger than bacteria, and are ovoid in shape. They multiply by budding. A little knob appears on one side of one of the oval bodies and grows and sends out another knob or bud. The bacteria multiply by fission. A bacterium divides into two, which again divide, etc. Bacteria are divided into (1) cocci or round bacteria, (2) bacilli or rod-shaped bacteria, and (3) spirilla or cork-screw shaped bacteria. But how are we able to assert so confidently at the present day that decomposition and disease are caused by bacteria? The proof is perfectly conclusive. Take a piece of meat, or vegetables, or fruits of any sort, and free them from bacteria, and then prevent the access of bacteria afterwards; the substances so treated do not spoil. Cut out a piece of flesh from a freshly killed animal and merely stop it up in a tube plugged with raw cotton, and if you succeed in doing this without getting any bacteria on it, it can be preserved indefinitely. Or take a fresh piece of flesh or other perishable article, and stop it up in this way, and then kill out the bacteria by heat. Articles treated in this way are also prevented from spoiling. It is not necessary to exclude the air, for of course the raw cotton does not exclude it. All that the cotton does is to filter out the bacteria, so that the air which comes in contact with the substance to be preserved is purified from the things which cause decomposition. In every case where there is decomposition there are always bacteria, and where there is no decomposition there are no bacteria.

The proof in the case of certain infectious diseases of animals and

*From a report of the Department of Agriculture of South Carolina, October, 1888.

plants is equally convincing. Several observers noticed that the blood and other tissues of animals suffering from the disease known as anthrax or malignant pustule contained small rod-like bodies, and it was supposed that these were in some way the cause of the disease. Inoculation of traces of blood or tissues from affected animals was always followed by the disease, but how was it possible to separate out the little rods from the other things contained in the blood? If this could be accomplished, they could be tried upon animals, and if they produced the disease the proof would be conclusive. This is just what Koch accomplished. He found that the little rod-like bodies grew very well outside of the body, and by cultivating them through many generations he freed them from anything which might have been clinging to them in the blood. The only thing which his cultures contained were the little rods which had descended from those in the blood. Now he found his cultures to be just as virulent as the blood, etc., from an animal suffering from anthrax, which proves conclusively that it is these little rod-shaped bacteria which cause the disease.

I have cultures obtained from Koch's laboratory, and can produce anthrax in mice, guinea pigs, rabbits, etc., by inoculating the smallest trace. Not only has this been proved for anthrax, but for many other diseases as well. But if I inoculate with such a small amount, how is it that bacteria are found in all the organs and tissues? The answer is evidently that the bacteria have multiplied enormously in the animal.

Fermentation has been proven to be due to a yeast fungus as conclusively as infectious diseases and decomposition have been shown to be due to bacteria.

Although we are so positive at the present time that we know the cause of many infectious diseases, of decomposition, and of fermentation, it has not been many years since the whole subject was looked upon with skepticism by men whose opinion was of weight. Still, for at least 230 years the idea that infectious diseases are caused by a living contagion has been entertained by men of learning. But the deductions of the advocates of the theory were more philosophical speculations than facts proven by experiment, and the whole subject fell into disrepute. There was about it so much that appeared vague and intangible, and even ludicrous, to medical men of 150 years ago, that in 1726 a comic poem appeared, placing the germ theory and its advocates in such a ridiculous light that it was well into the present century before anything like general interest was again aroused. The German anatomist, Jacob Henle, in 1840 expressed the conviction that contagious diseases must be caused by a living microscopic organism, and the weight of his opinion did much to give a new impetus to investigation in this line of research. The reasons why Henle was led to his conclusions are the following:

In infectious diseases there is something which is directly or indirectly communicated from a sick animal to a well one and causes disease in the latter. It is very probable that the thing which causes the sickness does so in very small quantities, because one sick animal can infect a whole herd. It is also invisible to the naked eye. If it were an invisible gas, it would begin to affect the animal at once, whereas we all know that a certain time always elapses between the exposure and the breaking out of the disease. If you bring a sick animal into a

herd the well animals are not affected for a day or more, if at all. If the sick animal gave off an injurious gas, the chemist will tell you that it would begin to show itself at once. There are no chemical substances which take such a long time to operate. It seems, therefore, that it must be a very small amount of an invisible substance. But if the substance is too small in amount to cause the disease at once, why does it cause it after several days? The answer is that the substance, whatever it is, must have increased; it must have the power of growing at the expense of the animal. If it does so increase and multiply, it must be a living being of some sort—either an animal or a plant. And it is now known to be plants of a different sort in each disease.

These, of course, are purely theoretical reasons, but they are so logical that they have rapidly won conviction. About the same time that Henle, in Germany, arrived at these conclusions, an American, Dr. J. K. Mitchell, also came to the same opinion, independently. From this time to 1876 a great deal of work was done to prove the connection between bacteria and disease. It had already been proven in 1837 by Cagniard, Latour, and Schwann, independently, that fermentation is due to yeast fungi, and Pasteur and others had also done valuable work, but it was reserved for Robert Koch to establish in the manner already described that for malignant pustule and other diseases bacteria are the cause.

Since 1876 bacteriology has developed into a science of itself, in which are engaged numbers of specialists. The laboratories in Europe and in America give evidence of the interest and zeal with which the subject is being studied. Not only have the physicians and veterinarians found it of great benefit in their branches, but agriculturists and chemists as well.

Report upon the Postal Club Boxes—II.

By QUEEN MAB.

Box cd.—The charm and value of the Cole Studies consists in their being real studies, and not superficialities. The text accompanying the slides gives the etymology, their megascopic and microscopic characteristics, together with illustrations of the objects, their mode of preparation, and the bibliography of the subject.

Slide No. 1 contains a transverse vertical section of the blade of a foliage leaf of *Rhododendron ponticum*, selected because of the excellent type it affords of leaf structure. The leaf was decolorized in alcohol previous to cutting, was stained with logwood, and mounted in Canada balsam.

Slide No. 2 is a vertical section of cluster cup, *Æcidium compositarum* var. *tussilaginis*, in situ on leaf of *Tussilago farfara*. It shows two *Æcidia* on the lower surface of the leaf, and one spermogonium, which, as usual, is on the upper surface and directly above the *Æcidium* cup. The method of preparation should be as follows:—The freshly gathered leaf with its parasitic growth should be sliced before it has time to decay, or be preserved in a 50% solution of alcohol. The sections may be mounted in glycerine, glycerine jelly, or Farrant's liquid. If allowed to dry, the spores may be wet in turpentine and

mounted in Canada balsam. The appearance of these slides is somewhat marred by the fallibility of the cement used. A good jet black and permant cement, working as easily and drying as readily as asphalt, is a great desideratum among preparers. As the tags only of the Club boxes contain addresses, members will greatly facilitate the work of the club by securely attaching these tags.

Box y².—Mr. John Kruttschnitt contributes slides illustrative of the anatomy of *Victoria regia*, which he regards as somewhat anomalous. The specimens are (1) Transverse section of petiole. (2) Perpendicular section of a main rib. (3) Longitudinal section of same. (4) Fibro-vascular tissue of same. (5) Tissue from main rib near its juncture with the petiole, showing stellate structure. (6) Tissue from lamina, and perpendicular section of same showing stellate structure.

The contributor calls attention to the almost total absence of fibro-vascular tissue in this plant, suggesting that the sparing manner in which this tissue is represented in the common white lily (*Nymphaea odorata*) may have its compensation in the abundance of its stellar structure. In *Victoria regia* he finds stellate structure in the leaf only, but as showing that some isolated vascular fibres do occur he refers to slide No. 4. All are mounted in a saturated solution of camphor and chloroform, about a teaspoonful to a pint of water. Unfortunately the white zinc cement of these slides has yielded and is encroaching upon the field.

The increasing fullness of the notes which accompany the Club boxes shows that the members realize the truth of the saying, "Knowledge is not given us to keep, but to impart; its worth is lost in concealment." Minute details of methods of preparation are of value, not only for the amount of actual information conveyed, but for the suggestiveness of that information also.

Box W².—Slide No. 1, contributed by Prof. C. H. Kain, of Philadelphia, is a group of 22 arranged diatoms, fossil and recent, from Nottingham, Md., Isle of Mors, Jutland, and Hammonton, N. J. The following species are included: *Actinocyclus ehrenbergii*, *Pinnularia nobilis*, *Navicula firma*, *Heliopelta ehrenbergii*, and *Trinacria regina*. The diatoms are arranged with mechanical finger on the slide, mounted in balsam, and the cement used is Brown's rubber. Forgetting the caution as to care in the use of higher powers, somebody has brought an objective down upon the cover, to its detriment and that of two of the valves of *Trinacria*.

No 2 by Prof. C. H. Kain has marine diatoms from mouth of Squan River, N. J., prepared by boiling in nitric acid, adding bichromate of potash, and mounted in balsam. The point of interest shown in this slide is the exceedingly variable nature of the diatom *Navicula lyra*. Three photographic reproductions of the Schmidt's plates are appended showing under how many names have been figured what are clearly varieties of *Navicula lyra*. Prof. Kain says it is not difficult to arrange these diatoms in a series which shows scarcely any difference between the two consecutive forms, and yet between the first and last of the series a wide difference will be manifest. It is not strange that the student of the diatomaceæ often becomes puzzled in such a labyrinth, where a single line more or less, or some slight difference in curvature, is deemed sufficient to warrant the constitution of a new species.

Notice of New Methods—VI.

By GEORGE C. FREEBORN, M. D..

INSTRUCTOR IN NORMAL HISTOLOGY, COLLEGE OF PHYSICIANS AND SURGEONS, NEW YORK

Application of Methyl Green for Demonstrating the Chemical Reaction and Death of Cells.—Mosso.-Virchow's Arch., cxiii. 1888, p. 397.

The author uses a 0.2% solution of methyl green in a 1% aqueous solution of sodium chloride. A drop of this solution is placed on a slide; the finger is pricked with a needle, and the resulting drop of blood is brought in slight contact with the drop of methyl green solution on the slide and a cover-glass put on. On observing such a preparation under the microscope, at first the leucocytes seem to resist the action of the fluid. After a few minutes they become stained a light violet color, which gradually darkens. The red cells change; some become becher formed; others appear to become irregularly excavated in their interior, and figures, resembling those described by Marchiafava and Celli as being characteristic of malarial infection, appear.

For studying these changes in the cells, the preparation is placed in a moist chamber, or the cover-glass is painted round with a ring of vaseline, and then observed for several hours. At the end of three hours, some of the leucocytes become stained bluish, others green, while others, the greater number, stain an intense violet. The plasmodian figures in the red cells entirely disappear and most of the cells become clear. At the end of twenty-four hours, the so-called nuclei of the leucocytes become stained an intense green; the remaining parts undergo a degeneration and a granular violet colored detritus remains. The violet colored leucocytes, on the contrary, retain the green stained nuclei and hyaline drops appear in their bodies. Some of the red cells lose their hæmoglobin, become colorless, and form the so-called phantoms. Others, resisting cells, show differences. Some become granular and stain blue-violet; others stain a blue-violet without becoming granular; while others remain homogeneous in their centres, stain greenish-blue, and surround themselves with a fine granular zone.

If, while a drop of fresh blood from a fish is under observation, a drop of the above methyl green solution is allowed to run under the cover-glass, rapid changes in the cells take place. The active leucocytes immediately draw in their processes, become round, and numerous small globules appear in their interior. The white cells stain a pale violet color. The vacuoles remain colorless, while the so-called nuclei stain an intense violet. Some cells change, in a few moments, into a hyaline globule with thick granules and nuclei like fragments on one side, while on the other side and in the interior fine granules, in active motion, are seen.

The present author has also used this methyl green solution for the study of ciliated epithelium. If a piece of the mucous membrane from the mouth of a frog is placed in a drop of the solution, one notices the following changes:—The cell bodies stain a violet color while the cilia are still in motion; those in which the motion of the cilia have ceased stain green. While the cilia are in motion no signs of a nucleus is to be seen; after half an hour the cilia cease to move and one or two

nuclei, stained blue, appear. Their outlines are indistinct and the color gradually changes to green. The cilia remain colorless. After four to five hours all the nuclei become stained emerald-green and only a very few cells remain colored violet.

The author has also found that methyl green prevents the coagulation of blood. A $\frac{1}{2}\%$ solution in a $\frac{3}{4}\%$ aqueous solution of sodium chloride retards the coagulation, when used in the proportion of 2 c.c. to 40 c.c. of blood. In the proportion of 3 to 4 c.c. to 40 c.c. of blood it entirely prevents the coagulation.

Method of Making Sections of Teeth and Bone with the Preservation of the Delicate Parts.—Weil, *Zeitsch. f. Wiss. Mikros.* v, 1888, p. 300.

The fresh tooth is broken in half and placed in a concentrated solution of mercuric chloride for one hour; then in 30% alcohol. After 24 hours this is replaced with 50% alcohol, and at the end of another 24 hours by 70%. After 12 hours the tooth is placed in a mixture of 100 c.c. of strong alcohol and 2 c.c. of the tincture of iodine, for the removal of the black precipitate of mercury. This requires about 12 hours. The iodine is then removed by washing in strong alcohol, which is renewed as long as it becomes colored.

The specimen is now to be stained. For this purpose, the author recommends either an aqueous or alcoholic solution of borax carmine. The specimen is removed from the alcohol, washed in water, frequently changed, for half an hour, and then placed in the staining fluid. The aqueous fluid requires 1 to 2 days; the alcoholic fluid 2 to 3 days for staining. When the staining is complete, place the specimen in acidulated alcohol [70% alcohol 100 c.c., Hcl. 1 c.c.] for 12 hours if the aqueous solution has been used, and for 24 to 36 hours if the alcoholic staining fluid has been used. Then in 97% alcohol for 15 minutes, double this time in absolute alcohol, and finally in an etherial oil for 24 hours or more.

On removing the specimen from the oil, wash quickly in xylol and place in chloroform for 24 hours; then in a solution of chloroform and hard Canada balsam for 24 hours; then add to this solution as much of hard balsam as it will take up, and pour the specimen with as much of the balsam as will cover it into a porcelain dish. Place the dish on a water-bath and heat gradually to 90° C.; keep at this temperature until a sample of the balsam becomes hard-like glass upon cooling.

Thin slices are now cut off with a fine saw, wet with cold water. These are ground and polished in the usual manner, and finally mounted in hard balsam dissolved in chloroform.

An Easy Method of Reproducing. Photographically, Histological Sections.—Tambusti, *Zeitsch. f. Wiss. Mikros.* v, 1888, p. 335.

The author covers a piece of board with several layers of black cloth and stretches on this a small strip of albumen paper, sensitized with silver nitrate. The slide containing the specimen to be reproduced is placed upon this paper, cover side down, firmly clamped to the board, and the whole exposed to direct sunlight until the paper becomes sufficiently blackened. The print is then developed in the usual way. In place of the sensitized albumen paper the ferrocyanide of iron paper used for making blue prints may be used.

BIOLOGICAL NOTES.*

Color of Flowers and Fruits.—In the December number of the *Am. Jour. Sci.* Prof. Goodale reviews the work of Courchet, Schimper, and previous observers upon the origin of color granules in flowers and fruits. To the granular proteid bodies found in the living protoplasm the name *plasts* or *plastids* has been given, and they are termed *leucoplasts*, *chloroplasts*, or *chromoplasts*, as they contain no color, are colored with chlorophyll, or have some other coloring matter. The *chromoplasts* always originate from either *leucoplasts* or *chloroplasts*. Blue, violet, and rose tints are generally due to colored cell sap while yellow and orange tints are chiefly due to crystals or solid masses which originate from the *chromoplasts*.

To Remove the Gelatinous Covering of Amphibian Eggs.—Prof. C. O. Whitman (*Am. Nat.*, vol. xxii, p. 857) recommends the use of a 10% solution of sodium hypochlorite diluted by five or six times its volume of water. The eggs are immersed, after hardening, only long enough to dissolve the covering. *Necturus* eggs required about five minutes.

Clover Rust.—Prof. L. M. Underwood reports (*Bot. Gaz.*, vol. xiii, p. 302) the appearance of this rust, *Uromyces trifolii*, upon *Trifolium pratense* in the vicinity of Syracuse the past summer. The damage done to the clover crop he estimates from 5 to 20 per cent. of the value of the crop. As this is its first reported attack upon the red clover in this country, it is a question of special interest to agriculturists as well as botanists.

Pores of Libriform Tissue.—Dr. Emily L. Gregory, in the Bulletin of the Torrey Botanical Club (vol. xiii, p. 197), has an elaborate discussion of the relation of the bordered pores in the cells of libriform tissue to the flow of the sap of plants. The tissues of representatives of 64 families of plants were examined, and the author finds the arrangement of these pores such as to lead to the conclusion that they are the most important means of sap flow, especially in that portion of tissue lying next the cambium layer. The pores in a large number of cases are on the tangential side of these cells, thus facilitating the supply of sap to the newly forming tissues of early summer.

Poison Organs of the Mosquito.—Prof. Geo. Macloskie describes (*Am. Nat.*, vol. xxii, p. 885) the poison glands and duct of the mosquito (*Culex*). He has been able, by staining and dissection, to show that the poison gland is one of three minute glands (the others being ordinary salivary glands) on each side of the head, and connected with a minute duct which traverses the length of the long pointed piercer which forms an important portion of the mouth parts of the mosquito. The

* This department is conducted by Prof. J. H. Pillsbury.

writer maintains that this fluid is intended mainly to prevent the coagulation of the proteids of plants which the animal sucks from the tissues, and that its poisonous effect upon other animals is only secondary. If so, it would perhaps follow that it is not introduced into the human flesh as a poison. It is difficult to see what purpose the irritating effect of the bite upon other animals can serve the mosquito, since it must make the chances of its getting nourishment from the blood of other animals many times less than it otherwise would be. It may be worthy of inquiry whether the irritating effect is not incidental and perhaps only occasional, and due to other causes than the fluid which seems, by analogy, to have another distinct purpose. The bite of the mosquito is ordinarily extremely irritating to the writer, but under many circumstances this effect is entirely wanting. My house is on the border of a wood, through which flows a sluggish stream, and the region is infested with mosquitoes, the bite of which is exceedingly poisonous. During the cold evenings of summer these pests enter the cellar windows through the coarse netting with which they are stopped, and occasionally find their way into the living rooms. I have noticed that these rarely give me any trouble from their bites. I am not able to offer any explanation, but cannot see why these should have less power to use their poison glands, if such they are, than those which attack me upon the piazza.

Haplodiscus piger, Weldon.—Mr. W. F. R. Weldon, of St. John's College, Cambridge, describes in *Quar. Jour. Mic. Sci.* (vol. xxix, p. 1) a new organism, to which he gives the above name, found by him occasionally in a tow-net near New Providence, Bahamas. It is 1.3 mm. long by 1.1 mm. broad, having a general resemblance to a protozoan, but possessing a structure which indicates its relationship to the worms. Mr. Weldon is uncertain as to its systematic position, but seems inclined to place it among the Cestodes.

Blastopore of *Rana temporaria*.—Mr. Harold Sidebotham, in the same journal (vol. xxix, p. 49), gives the result of his studies upon the embryo of the frog (*Rana temporaria*), in which he shows that the anus does not rise from the persistence of the blastopore, but from a separate invagination, and that the neural folds do not enclose the blastopore, as maintained respectively by Spencer and Balfour.

Mesozoic Mammalia.—H. F. Osborn, of Princeton College, gives (Jour. Acad. N. Sci., Phila., vol. ix, No. 2) a very valuable review of the characters and relations of the mesozoic mammals of America, Great Britain, and other countries, with figures illustrating the subject, and new facts and figures relating to the American species. The animals were all small, the length varying from half an inch to an inch and a half. Prof. Osborn sustains the view that they are not all marsupial, but that placental mammals are included, probably the insectivora or their predecessors, and that marsupial and placental mammals have not successional but parallel genetic relations.—*Am. Jour. Sci.*

MEDICAL MICROSCOPY.*

Trichinosis.—A mechanic, aged 37, died of this disease in the Boston City Hospital, March 9, 1888, after a month's confinement. The history of the case, its symptoms, and treatment are given in the *Boston Medical and Surgical Journal* of Sept. 13, 1888. Trichinæ were not found until after his death, and hence the real cause of his intense suffering was not discovered in time to treat it intelligently. On Feb. 24 microscopic examination of muscle from the the right forearm failed to reveal the parasite. Feb. 29 a second examination of muscle from the right thigh resulted similarly. The specimens were procured in each instance by injecting a few minims of 4% solution of cocaine subcutaneously and intramuscularly and cutting down upon the muscle. The operation was painless, and the wounds healed readily. After death some intercostal muscle was removed from the right side, and upon microscopical examination a few encapsulated trichinæ were found. Permission for an autopsy was refused by his relatives.

The patient had stated, Feb. 21, that pork was his favorite dish, and that he had last eaten it as fried bacon about Feb. 1, one week before entrance to the hospital. He had for years lived a migratory life, often stopping at low-priced boarding-houses.

—o—

The Bacillus Pyocyaneus.—At a meeting of the Chicago Medical Society, Sept. 3, Dr. Bayard Holmes read a paper and presented some tubes containing cultures of this pyogenic microbe. An abstract of the paper is given in the *Western Medical Reporter*.

The presence of the *Bacillus pyocyaneus* is to be inferred from the green or blue color of secretions—pus, sweat, etc., and from a peculiar odor emanating therefrom. The odor is more significant than the color. It is probable that the green coloring matter, pyocyanin, is a by-product of the growth of the bacillus, and it is neither constant nor pathologically significant.

The specimens presented by Dr. Holmes were derived by tube and plate culture, from the pus of a sub-mental abscess. The bacilli were associated with streptococci. They are small, often found in twos, and very motile in solutions. On gelatin plates it grows as a greenish white spot surrounded by green gelatin. The gelatin is liquified conically below the colony. The growth is slow. In tubes with needle cultures it grows as a greenish-white pelicle on the surface of the gelatin, and as small colonies below along the back of the needle. After two or three days the gelatin begins to be liquified at the top, and the whole tube becomes liquified in a few days. On the potato it grows slowly, as a reddish or greenish-white mass, which turns bright green on the application of fumes of ammonia, and bright red by the fumes of hydrochloric acid.

Subcutaneous injections of the pure culture in rabbits and guinea pigs produce sero-fibrinous or phlegmonous inflammations, and, at times, abscess. The progressive phlegmonous inflammation resulted fatally to the animals in some cases. The bacillus is capable of pro-

* Conducted by F. Blanchard, M. D.

ducing suppuration in man also. Full reference to the literature of the subject is appended to Dr. Holmes' paper.

The Emperor's Cancer.—Sir Morell Mackenzie has given to the public his version of the Emperor Frederick's case. The microscopy of it is interesting. A small tumour develops upon a vocal cord. A most eminent laryngologist excises a section of the tumour and submits the specimen to microscopic analysis by the most eminent pathologist in the world. He (Virchow) opines that the tumour is not a cancer, but a wart. The progress of the case proves that the tumour was a cancer.

Bacillus of Diphtheria.—D'Espine of Geneva confirms Löffler's claim that a certain bacillus discovered by him in diphtheritic false membranes is the causal agent of diphtheria. He never failed to find Löffler's bacillus in cases of true diphtheria or diphtheritic croup; and he has often reproduced the disease in hares and guinea pigs by inoculating the products of a series of pure cultures; bacilli from a 25th culture were proved to have the same pathogenic properties, and speedily produced the disease.—*Lyon Médical.*

Transmission of Tuberculosis.—It is coming to be believed that tuberculosis in man is caused largely by eating the meat and drinking the milk of animals so infected. The bacilli are believed to be transmitted from animal to animal by the habit of licking each others noses, the discharges being doubtless heavily loaded with the germs. This suggests a useful field for microscopists in examining the excretions from the nostrils of animals. It is also thought that vaccine virus may contain the bacilli. The Belgium government has ordered that calves from which virus is taken shall be killed and carefully examined for bacilli.

A Prize Essay.—The American Association for the Study and Cure of Inebriety offers the sum of one hundred dollars to be paid by Dr. L. D. Mason, Vice-President of the Society, for the best original essay on "*The Pathological Lesions of Chronic Alcoholism Capable of Microscopic Demonstration.*" The object of the essay will be to demonstrate:—(1) Are there pathological lesions due to chronic alcoholism? (2) Are these lesions peculiar or not to chronic alcoholism? The essay is to be accompanied by carefully prepared microscopic slides, which are to demonstrate clearly and satisfactorily the pathological conditions which the essay considers. Accurate drawings or micro-photographs of the slides are desired. The microscopic specimens should be accompanied by an authentic alcoholic history, and other complications, as syphilis, should be excluded.

Conclusions resulting from experiments on animals will be admissible. The essay, microscopic slides, drawings, or micro-photographs are to be marked with a private motto or legend and sent to the Chairman of the Committee on or before October 1, 1890. The successful author will be asked to read and demonstrate his essay before the "Medical Microscopical Society" of Brooklyn. The essay will then be published.

The following gentlemen have consented to act as a Committee:—*Chairman*, W. H. Bates, M. D., F. R. M. S., Lond., Eng. (President of the Medical Microscopical Society of Brooklyn), 175 Remsen

St., Brooklyn, N. Y.; John E. Weeks, M. D., 43 West 18th street, New York; Richmond Lennox, M. D., 164 Montague St., Brooklyn, N. Y.

—o—

Micrococcus Tetragonus in a Tubercular Ulcer.—Dr. B. Vangel of Buda-Pesth, on the microscopical examination of an ulcerated nose in a phthisical subject, found, besides tubercle bacilli, some cocci, which he cultivated, inoculating a white mouse with the culture. The organs and blood, after being treated with Gram's stain, were found to contain cocci grouped in fours and enclosed in a capsule—micrococcus tetragonus, in fact—which Koch and Gaffky found in phthisical lung cavities, but which, as far as Dr. Vangel is aware, had not hitherto been found in other organs. What part this micrococcus plays in phthisis is unknown. It would appear, however, that tissue in the process of breaking down forms a soil suitable for its development. The ulcer in which the micrococcus tetragonus was found healed with suitable treatment, but the swelling and redness of the nose remained for a long time.—*Lancet*, October 6, 1888.

The Eggs of an Eel.

BY FRED. MATHER.

COLD SPRING HARBOR, N. Y.

Scientists have known that the eel is an egg-producing fish for a dozen years or more, the Russian naturalist, Syrski, having first figured the ovaries of the female and the spermaries of the male, but how and where these minute eggs are laid is still unknown. In October the eels run down to salt water to breed, and in the spring the young eels ascend the brooks and rivers in swarms. As they are then some two inches long and of the size of a darning needle, it is evident that they must have been hatched several weeks before, perhaps in February, to have grown so much from so small an egg.

The number of eggs in a six-pound eel in November (in what is known to fisherman as 'eel fat,' but which are really the ovaries) is fully 9,000,000. Under the microscope they measure 80 to the linear inch, and taking one ovary and dividing it by means of the most delicate scales known to science, I halved, quartered, and further divided the mass seventeen times, until I had a section small enough to count the eggs in it. This section represented 1—131,072 of the total number, and three sections were laboriously counted under the microscope. One of the sections contained 68 eggs, making the total 8,912,896 eggs. The second held 77 eggs, or 10,092,544 in the whole. The third section consisted of 71, from which it would appear that there were 9,306,112 eggs in the eel.

There have been many theories about the reproduction of the eel, some of them being wildly absurd, such as their being hatched by fresh-water muscles, or that the lamprey was the female and the so-called silver eel the male, etc. The fact is that the lamprey, miscalled "lamper eel," is a form of life lower than that of the true fishes, to which the eel belongs, and is a vertebrate with a cartilaginous skeleton instead of a bony one, has its skull imperfectly developed, and has no lower jaw. Superficially it appears like an eel, but is not nearly related to it.

EDITORIAL.

BY CHAS. W. SMILEY.

Prologue to 1889.—With the coming of the new year the editorial office of this periodical returns to Washington, it having proved very inconvenient for our increasing business to have that work done so far away. Besides, Professor Osborn is engaged upon some other important matters that take up much of his time. While he will not hereafter be responsible for each issue editorially, his connection will continue. He will contribute, render advice, and assist in every way practicable.

The occasion is utilized for establishing several departments, each in charge of a competent specialist. Thus, without losing our genial and learned friend, Osborn, we add several gentlemen to the staff, each of whom is skilled in his field of work.

In addition to the departments represented in this number, there will commence in February a serial entitled, "Loiterings in a Microscopist's Laboratory," in which one of the very foremost microscopists of this country will give valuable information and incidentally express some opinions quite freely. As he writes in a very pleasing style, his chapters will doubtless attract the attention of many who are not familiar with the subject. We only regret that he has sworn us to secrecy as to the location of his busy laboratory. He will write under a *nom de plume*.

—o—

Biological Notes.—In this department of the Journal, to be conducted by Prof. J. H. Pillsbury, of Smith College, Northampton, Mass., we endeavor to give, in such plain English that all may understand, the most important and interesting facts in natural history developed by a score or more of the periodicals, transactions, and other publications of the day. It is for those who are unwilling to be ignorant of biological progress and unable to read the many prints now issued. In all cases we cite the source of information so as to enable readers to look up details when they desire so to do.

—o—

Bacteriology.—This new science or branch of science requires for its study the higher power of lenses magnifying from 500 to 1200 diameters, as well as certain special apparatus, methods, and cultures. It is proposed hereafter to devote more attention to it in this periodical, and to present not only its technique but its bibliography, and particularly to state in plain language what progress is constantly being made by those professionally engaged in its study. In this number there is room for but a short statement of the character of bacteria. This is from an address by Dr. Bolton, of the South Carolina University, and lately from Johns Hopkins University. It will be followed by his description of the practical and economic value of the study, and by other articles. We are especially fortunate in having the friendship of Dr. Smith, of the Bureau of Animal Industry, and his able corps of workers, from whom contributions will be expected in due time.

Our Medical and Biological readers as well as the microscopists will be glad to know the latest discoveries relative to infectious diseases, from tuberculosis to swine plague. A large part of the literature is in German, and of the workers Germans. Our own Bureau of Animal

Industry, under Dr. Salmon's direction, is doing as much good work as can be found in this country.

— o —
Medical Microscopy.—This department, conducted by F. Blanchard, M. D., of Peacham, Vt., seeks to present the most important applications of the microscope in the study and practice of medicine. No physician can properly claim to be competent to-day unless he uses a microscope, and knows how to prepare material for mounting as well as to mount it properly.

— o —
Technique.—Dr. Geo. C. Freeborn, instructor in normal histology in the College of Physicians and Surgeons, New York City, has kindly consented to continue his "Notices of New Methods," of which No. VI will be found in this issue. Under this heading comes also the reports on the Postal Club Boxes by Queen Mab, one of the most skillful preparers of material in the country. These will be continued regularly. Some excellent matter by Dr. F. L. James, of St. Louis, is crowded over to a future issue.

— o —
Bibliography.—It is proposed to insert such bibliographical matter as will enable readers to see at a glance what literature is being published from time to time bearing upon Microscopy and upon certain phases of Biology. This will include lists of books and pamphlets published, with such information, when available, as will show the reader how and where to buy them, as well as titles of articles in periodicals, both foreign and domestic. It is also thought desirable to present quite complete bibliographies of past and present literature relating to the special topics in which our readers are interested. There are facilities for this work in Washington not equalled elsewhere in the United States. A copy of every copyrighted book has to be deposited in the Library of Congress. The Surgeon-General's library contains the greatest collection of medical books and periodicals in the world. The National Museum and Smithsonian Institution collect biological and other matter from all sources. The Microscopical Society, the Patent Office, and this Journal all make special collections of microscopical literature.

— o —
Subscriptions.—All paid subscriptions expired with the December number. Please enclose your dollar for 1889, and a card (postal or other) to blind the contents of the envelope. If not convenient to enclose the money now, please notify us. This will greatly assist in writing up the lists for 1889. It is a *little* courtesy *greatly* appreciated. If you want any other periodicals we can club them to you at special rates. Our club list published in the advertising columns contains only a few of the more common periodicals. We can order any you want and save you some money. Your orders need not come all at once. Any subscriber to this Journal can have the allowance if ordering a second or third periodical at any time during the year.

— o —
Binding.—Look up your sets to see what you lack, and if you want them bound we will put on our neat cloth covers for 35 cents each, or four years in separate covers for \$1.20. This is too low a price, but we want the sets to be preserved. If you will present them to any public library we will present the binding of them.

MICROSCOPICAL SOCIETIES.

ESSEX COUNTY, N. J.—F. VANDERPOEL, *Secy.*

October 4, 1888.—A meeting was held at the office of Dr. Brown. Two new members were elected. The subject for the meeting was "Pus," and was illustrated by slides prepared by Drs. Ayres and Brown. Pus from a suppurating wound on the hand was examined under different microscopes and with different powers. A case of acute Nephritis furnished material for one of the slides. There was an animated discussion as to the true nature of pus, authorities differing on this subject. The following were Dr. M. W. Ayres' remarks:—

The question of the *origin* of pus will be one to engage the attention of pathologists for some years to come, judging the coming experience by the past.

The thralldom of *authority* is shown in the acceptance of the view brought prominently forward by Cohnheim, in effect that the migration and degeneration of leucocytes is the sole element in the formation of pus.

Granting that leucocytes are present, what will account for the immense majority of *white* over *red*, in pus, when in the *interior* of the vessels the case is reversed, the ratio being 1 to 500?

What special reason can be found for the diapedesis of a large cell in such immense quantities, when a relatively smaller and much more numerous cell must remain within the capillary walls?

In the inflammatory process there is a purpose to be accomplished, viz., the removal of something from the individual, whatever may have been the cause of the initial irritation.

To best subserve the interest of the past, and the individual in general, the efforts of the tissues are to isolate the infected district by cutting off communication with the surrounding territory, and gradually exfoliating or throwing off the now dying mass. Cut off from the circulation, the cellular elements break down into pus, or a degenerated mass of proliferated tissue-cells, the debris of blood, lymph, water, salts, and gases.

What, then, is the origin of this mass of exuded material?

Without necessarily any blood supply of sufficiently large character to warrant the assertion that nothing but leucocytes are present, the formation of pus continues and will go on indefinitely, through the liquefaction of material adjacent to the centre of irritation.

Hence it will be found that the connective tissue corpuscle is the prime seat of origin of the puriform mass, the corpuscles swelling, dividing, and throwing out rounded granulations and pus cells.

October 18.—The meeting was held at the office of Dr. Brown. The subject for the evening was "Blood," and the members brought a variety of slides and specimens.

Dr. Ayres brought some of the blood of a bitch which was reported to have died of rabies. When mounted, the specimen was a very interesting one.

Other slides were shown, containing, respectively, blood from amphiuma, catfish, beaver, mouse, meadow-lark, horse, frog, and man.

Mr. Carter had a slide containing some blood corpuscles, *uncovered*, eleven years old. They were in a remarkable state of preservation.

Mr. Woolman exhibited a photograph of blood plaques made by

some one not a member of the Society. This gentleman also referred to a statement recently made by a member of the Royal Society to the effect that the normal blood corpuscle of man was not bi-concave, but that this form was given to it by mechanical action, chemical re-agents, and the like. No proof of this was offered in the statement, however, and the latter did not meet with the endorsement of those of the members who had examined blood under all conditions. Until proof is given there seems to be no reason for giving up the hitherto accepted belief in the bi-concavity of the normal human blood disc.

November 1, 1888.—The attendance constituted about two-thirds of the membership. Rev. F. B. Carter gave an account of some observations which he had made upon vegetable protoplasm. The results were very remarkable, and seemed to point to a common starting point for animals and vegetables.

Some of the protoplasm which he had seen emerge from an undoubted vegetable cell assumed, after a time, the well-known amœboid motion, and he had watched the slide for several hours while this process of change or development was going on. This seems to go further than Schultze, who states that there is, chemically, no difference between animal and vegetable protoplasm; this latter, however, cannot be considered as conclusive proof of their identity since there are various chemical substances among the carbon compounds which are similar in chemical constitution, but differ widely in their physical properties. The ever beautiful movement of protoplasm called Cyclosis in the cells of plants was also shown in a specimen of *Nitella*. Though strictly vegetable in every sense of the term, this circulation is always suggestive of the movement of blood corpuscles through the capillaries of the animal.

November 13, 1888.—Meeting held at the residence of Rev. Mr. Carter, Montclair, who gave a paper upon the "Desmids: their life history and classification." After the reading of the paper, a variety of the forms were illustrated by means of the lantern. Among them were seen *Vampirella*, *Protococcus pluviatus*, *Cosmarium*, *Microsterias*, and *Eurastrum*. The conjugation of two *Closteria* was shown. Bi-lateral symmetry was also well illustrated by many of the specimens. Filamentous forms were also shown, with the caution not to mistake for one desmid a group or colony of these plants joined together.

IRON CITY MICROSCOPICAL SOCIETY, PITTSBURGH, PA.

October 22.—The annual meeting for election of officers and transaction of business was held at headquarters in the Pittsburgh Library rooms. There was a large attendance of active members, many of whom came laden with cases of instruments or carefully prepared specimens for inspection. Before and after the business session these specimens were examined and discussed in an informal manner.

Among the objects shown was a rare and beautiful animal, *Stephanoceros eichhornii*, and also a polyzoa or coral-like animal, *Aleyonella*, both from a pond near Edgewood. Also cyclosis, or flow of protoplasm in the cells of a *Chara*, a submerged water plant from New Brighton, stained section of human scalp, blood corpuscles, with a number of zoophytes and other similar objects.

Mr. Mellor, the President for the last three years, announced the busi-

ness before the Society to be the election of officers, stating that he thought he had served his full time in an executive capacity, and that he must be released from further duty. He therefore declined another term in his present office, but assured the members that his interest would be even greater than heretofore, and that he would give all the assistance possible to the new officers. He then reviewed the history and condition of the organization, and gave expression to some hopeful ideas as to the future scope and extent of its work.

The following were elected for the ensuing year:—President, Rev. W. J. Holland, D. D.; First Vice-President, Prof. James M. Logan; Second Vice-President, C. C. Mellor; Recording Secretary, Dr. H. DePuy; Corresponding Secretary, George M. Clapp; Treasurer, C. G. Milner; Curator, Herbert Walker.

In taking the chair, Rev. Mr. Holland said:—Nothing but the assurance that we shall continue to have the help and co-operation of the retiring President has influenced me to consent to my nomination. In taking the chair I desire to emphasize a point which he has touched upon; that is, the desirability of enlarging the scope and purposes of our body—in fact, making it the initial point for a grander enterprise. Pittsburgh and Allegheny are rich in brain and talent as well as in wealth. Why should we not have an academy of sciences which should unite in that fellowship and co-operation which we have found so pleasant not only those who are devoted to the art of microscopy, but those who are cultivating the great sciences to which the use of the microscope is simply subsidiary? We have chemists, electricians, astronomers, botanists, ornithologists, and geologists in the present ranks of the Society. Why not through these, our brethren, reach forth, and draw into the larger society, of which ours shall form a section, the great body of thinking men among us, many of whom have a more than local reputation. If Philadelphia, when half the size of this community, laid the foundations of an academy of sciences, the fame and power of which is world-wide, why should not we? “If Buffalo, Cleveland, and Cincinnati support such institutions, why should not Pittsburgh and Allegheny?”

Dr. J. A. Lippincott and Prof. J. G. Ogden were elected members, making the total enrollment 88. The regular meeting night was changed to the second Tuesday of each month in order to accommodate the members who belong to the Allegheny County Medical Society. It was also decided to give a public soirée next month, with the object of securing funds for scientific equipments.

November 13.—Mr. C. C. Mellor read a paper on “*Stephanoceros eichhornii*,” a rotifer rarely met with, and which was discovered in 1761 by Eichorn, of Dantzic. The paper was illustrated with drawings.

Prof. Logan exhibited by polarized light a fine specimen of basalt from Bridgeport, Conn. Rev. W. J. Holland exhibited a parasite, presumably a species of Anobium, which he had found feeding upon the tissues of a Goliath beetle. The animal was remarkably tenacious of life, having lived 48 hours in an atmosphere of hydrocyanic acid. Other exhibits were:—crystals of Guanadine and acetanalide; section of lower jaw of pup. *Aspergillus niger*, or mould fungus from diseased human ear, and sponge spicules from Indian Ocean. The Society has

increased in attendance considerably of late and preparations are being made for a soirée in January next.

TORRY BOTANICAL CLUB, NEW YORK CITY.

November 12, 1888.—Professor Schrenk read a paper on the inflorescence of *Callitriche*, illustrated by microscopical preparations, specimens, and drawings. He held that the two bracts or sepals at the base of the flower are in reality floats, as he had found them in *C. heterophylla* to be hollow and filled with air.

MICROSCOPICAL SOCIETY, WASHINGTON, D. C.

80th Meeting, Tuesday, September 25, 1888.—Prof. Seaman gave an account of the meeting of the American Society of Microscopists and donated a copy of the "Proceedings." He called especial attention to the papers of Prof. Smith and Miss Detmers. He presented a resumé of his work as curator. Three lines of acquisition are desirable—books, apparatus, and slides. He had procured catalogues of all European makers except two; also the Abbé Condenser recently ordered by the Society.

Dr. J. M. Lamb showed and described a paraffine bath made by the Boston Educational Supply Co. Dr. Taylor showed some colored lantern slides made for him by Queen & Co., and described the manner of preparing them.

81st Meeting, Oct. 9, 1888.—The annual election of officers resulted thus:—President, Dr. Geo. N. Acker; Vice-Pres., Dr. I. W. Blackburn; Cor. Sec., Dr. J. M. Lamb; Rec. Sec., Dr. E. A. Balloch; Treas., Mr. F. T. Chapman; Curator, Dr. Wm. H. Seaman.

Mr. C. W. Smiley was elected an active member.

Dr. Reyburn made a few remarks on the use of photography in microscopic work, saying that photography is comparatively a simple thing if ordinary powers from 75 to 100 diameters are used. All that is necessary is a microscope, a lamp, and a small camera; a condensing lens may be substituted for the mirror. The focus is easily obtained and a dry plate slipped in. An exposure of from 20 to 40 seconds will give the desired result. By the contact process, pictures can be taken without camera or microscope. Cover a plate with black cloth, make an opening in it the size of the cover-glass, apply the slide to this opening, and expose to light. The copy is, of course, the exact size of the original. Dr. Reyburn also explained the process of developing.

Dr. Taylor thought the exposure should be longer than usually stated. Mr. Chapman said that some photographers used orange or yellow instead of red light when daylight was used.

Mr. Skinner gave a description of stellar photography. Prof. Seaman thought that photography was of great advantage in class demonstration.

Dr. Balloch gave an account of some work in photography done by Dr. J. M. Lamb and himself during the summer.

NOTICES OF BOOKS.

Dissection of the Dog as a Basis for the Study of Physiology.
By W. H. Howell. Henry Holt & Co. New York, 1888.

There have appeared during the year several books containing guides for mammalian dissection, and there were in existence previously a host of others. And yet one cannot say that most of them are not a decided gain. For the requirements of different courses are not often exactly alike. In fact, what teacher does not feel that no text-book yet written fully meets his special needs. But Dr. Howell has produced a book whose counterpart will not be easy to find. Nearly all the guides to mammalian dissection are the production of morphologists, and therefore dwell most upon topics of interest in comparative anatomy. The one we are now reviewing is written by a physiologist expressly to prepare students for a practical or theoretical course in physiology. It does not follow the dissection with exhaustive thoroughness, but, taking out of the vast detail the parts of most use in an elementary physiology course, tells the seeker how to discover them with his own scalpel. From practical experience in conducting college courses in animal physiology we can testify to the value to the student of a clear, even though not exhaustive, knowledge of anatomy and histology before he attempts to proceed far in pure physiological study. It has a twofold use:—it not only shows him the elaborate complexity of the animal body and helps him to realize how very much more needs to be taken into account in studying physiological problems, but it also makes it possible for him to closely follow steps in the processes. For instance, the absorption of carbohydrate and its storage in the liver or secretion by the salivary gland become real processes to him in proportion as he understands the morphological factors involved. Dr. Howell has undertaken to provide a practical treatise for such a purpose, and not an exhaustive work on mammalian anatomy. It is decidedly convenient to have in a brief and inexpensive form a book which can be put into the students' hands as a guide to elementary dissection of a mammal prior to the study of animal physiology. The subjects taken up cover most of the anatomy of muscles, the principal nerve and blood vessels, the glandular, excretory, and reproductive systems, the dissection of the brain and eye. It would seem as if any one without assistance could use this work to guide him in the dissection of a dog or cat. Since it was written for use where abundant material would be at hand for dissection, it is not as economical of material as one would perhaps be compelled to be in many places.

—o—

The Home of Shakespeare. L. Prang & Co. Boston, Mass., 1888.

Nature was very kind to William Shakespeare and Anne Hathaway in adorning their homes with picturesque surroundings to entice the eye and cheer the heart. All the interesting and now familiar scenes of Shakespeare's birthplace and early life are here depicted by full-page illustrations from water-color sketches taken on the spot by Louis K. Harlow, with such extracts from the great poet's writings as fitly describe the spot or appear to have been themselves suggested by it. The contents include the Poet's Home, the Grammar School, the West Gate,

Guy's Mill, Warwick Castle, Kenilworth Castle, the West Tower, the Old Mill, the Bridge, Anne Hathaway's Cottage, the Weir's Walk, Holy Trinity Church, the Avenue, the Tomb, and other beautiful scenes of the village and its surroundings. To any true lover of Shakespeare or of art this book is a most fitting holiday gift. It is bound in full cloth, beveled edges, with rich gilt stamping in white and gold relief. Everything about this book is neat and worthy of the publishers, whose reputation is unexcelled.

BIBLIOGRAPHY—RECENT WRITINGS OF INTEREST.

[This list will report books and articles of interest to microscopists and biologists. It will enable specialists to find literature of real value to them which space does not permit to be noticed more at length. It is prepared solely in the interest of readers and not of advertisers. But in ordering from publishers, always cite this page and date for convenience of identification. Requests from subscribers will be entertained, in special cases, for fuller information than is here given.]

ADAMS, FRANK D. and LAWSON, ANDREW C.—On some Canadian rocks containing scapolite, with a few notes on some rocks associated with the apatite deposits. (Contains allusions to microscopical examinations of rock.) *Canadian Record of Science*, Oct., 1888, pp. 185-201.

ANON.—How to make lantern slides on gelatino-bromide and gelatino-chloride plates. *Anthony's Photographic Bulletin*, Nov. and Dec., 1888. Reprint from *Photographic News*.

BOWEN, JOHN T.—Two forms of skin tuberculosis. *Boston Medical and Surgical Journal*, Aug. 16, 1888. Vol. cxix, No. 7, pp. 151, 152.

BOWYER, R. W.—Some methods of moth-collecting. Paper read at Hertford, England, Feb. 28, 1888. (Adapted to beginners and very practical.) *Trans. Hert. Nat. Hist. Soc.*, Aug., 1888, pp. 23-29.

BRYANT, W. S.—Valves in the veins of human intestines. (8 figures, photo-micrographs.) *Boston Med. and Surg. Journal*, Oct. 25, 1888.

CAMPBELL, F. MAULE.—The means of protection possessed by plants. Anniversary Address, Hertford, Feb. 21, 1888. (A valuable contribution to the doctrine of evolution.) *Trans. Hert. Nat. Hist. Soc.*, Aug., 1888, pp. 5-17.

COLLINS, FRANK S.—Algae from Atlantic City, N. J. (An annotated list of species found.) *Torrey Bulletin*, Dec., 1888, pp. 309-314.

DAVIS, J. R. AINSWORTH.—A text-book of biology, comprising vegetable and animal morphology and physiology. London: Chas. Griffin & Co., 1888. 462 pp., 158 illustrations.

DAWSON, SIR WM.—Eozoon Canadense. (Among the photo-micrographic illustrations are coral system of eozoon injected with serpentine; very fine canals and tubuli filled with dolomite.) *Canadian Record of Science*, Oct., 1888. Vol. iii, No. 4, pp. 201-226. 11 figures.

DEXTER, RANSOM.—The kingdoms of nature, or life and organization from the elements to man; being a following of matter and force into vitality, vitality into organization, and organization into the various types of being, culminating in man. Chicago: C. H. Kerr & Co., 1888. 8°, cloth, \$3.50.

DULCKEN, H. W. (Editor).—Men, Animals, and Plants of all quarters of the globe. (For schools.) 500 illustrations. N. Y.: Ward, Lock & Co., 1888. 30 pp., folio. Cloth, \$2.00.

FEWKES, J. WALTER.—On a new parasite of *Amphiura*. *Proc. Boston Soc. Natural History*, xxiv, pp. 31-33.

FEWKES, J. WALTER.—A new marine larva and its affinities. pp. 1-4, plate. Reprint from *The Microscope*, June, 1888.

FORBES, S. A.—The lake as a microcosm. *Bulletin Scientific Association*, Peoria, Ill., pp. 77-87.

GARMAN, S.—On the lateral canal system of the Selachia and Holocephala. (Morphology only.) *Bull. Mus. Comp. Zoöl.*, xvii, No. 2, pp. 57-119. 53 plates.

HENSLOW, REV. G.—The origin of floral structures through insect and other agencies. N. Y.: Appleton, 1888. (International Science Series No. 63.) 16 + 349 pages. 12°, cloth, \$1.75.

HOWELL, W. H.—Dissection of the dog as a basis for the study of physiology. N. Y.: Henry Holt & Co. 8°, \$1.00.

HOLLAND, J. W.—The urine and the common poisons. Memoranda; chemical and microscopical for laboratory use. P. Blakiston, Son & Co, Phila., 1888.

IDDINGS, JOS. P. (Translator).—Microscopical physiography of the rock-making minerals. An aid to the microscopical study of rocks. Vol. i. Minerals by H. Rosenbusch. (Review next month.) N. Y.: John Wiley & Sons. 8°, pp. 333. Illustrated; plates. \$5.00.

JAMES, FRANK L.—Elementary Microscopical Technology. Part I: The Technical history of a slide from the crude materials to a finished mount. (A fine book for students, giving the reasons for what it advises. Review hereafter.) St. Louis, Mo., Medical and Surgical Journal Co. 8°, pp. 107. Illustrated.

JEFFRIES, JOHN A.—The bacteria of the alimentary canal, especially in the diarrhœas of infancy. *Boston Med. and Surg. Journal*, Sept. 6, 1888. pp. 217-223.

MANTON, W. P.—Primary methods in zoölogy-teaching, for teachers in common schools. Boston: Lee & Shepard. 1888. 61pp. Cloth, 50c.

NEWMAN, L. G.—Traité des Maladies parasitaires non microbiennes des animaux domestiques. Paris, 1888. 16 et 675pp. 306 figures.

PITKIN, LUCIUS.—Disease germs and how to combat them. *The Century*, July, 1888. pp. 375-378, with 12 figures of bacteria.

PUTNAM, J. J.—A case of Hereditary Muscular Dystrophy with Microscopical Demonstrations. *Boston Med. and Surg. Journal*, Nov. 1888.

VAUGHAN, VICTOR C., and NOVY, F. G.—Ptomaines and Leucomaines; or, the putrefactive and physiological alkaloids. Phila.: Lea Bros. & Co., 1888. 316pp. 12° cloth, \$1.75

WEST, WM.—Desmids of Maine. (List of species collected by Prof. A. B. Aubert, at Orono, Me.) *Journal of Botany*, xxvi, 339-340.

Exchanges.

[Exchanges are inserted in this column without charge. They will be strictly limited to mounted objects, and material for mounting.]

OFFERED.—Diatomaceous earth from Thibet, various localities (12,000 feet); also, material and slides of diatoms from Scottish Highlands, and continental foraminiferæ. WANTED.—Slides of American diatoms, insects, or botany.

W. D. STEWART, 2 Gilmore Terrace, Edinburgh, Scotland.

OFFERED.—Sections of vegetable ivory and slides of crystalized maple sugar. Good mounts taken in exchange.

WM. LIGHTON, 106 Fifth Avenue, Leavenworth, Kansas.

WANTED.—Parasites and books on Parasites and other micro. subjects. Will give Anatomical, Pathological, Botanical, Micro-fungi, Zoophytes, Polycistine, Foraminifera, Parasites, and other slides in return.

FRED. LEE CARTER, Gosforth, near Newcastle-on-Tyne, England.

Wanted, Diatomaceous earth from Mégillanes, Bolivia, South America. Can give in exchange either Diatomaceous earth from New Zealand or cash.

E. MICHALEK, I. Fleischmarkt, No. 1, Vienna, Austria.

Mounted sections of Fœtal Lung (5 months), sections across entire lobe. $\frac{25}{100}$ in. thick, beautifully stained, in exchange for first-class pathological slides.

W. C. BORDEN, M. D., U. S. A., Fort Douglas, Utah.

Wanted, earths, recent diatoms, and miscellaneous objects for mounting. Only first-class material offered or desired.

MARY A. BOOTH, Longmeadow, Mass.

Fossil Diatomaceous deposits (marine) wanted from Bermuda, Virginia, Maryland, California, etc.

I. ELLIOTT, Ardwyn Villa, Aberystwith, Wales, England.

Labels for slides.

EUGENE PINCKNEY, Dixon, Ill.

Correspondence relative to exchange in microscopical material or prepared mounts.

HENRY L. OSBORN, Hamline, Minn.

First-class Histological Slides for other good mounts: Histological and Pathological material cut on shares.

S. G. SHANKS, M. D., 547 Clinton Ave., Albany, N. Y.

FOR EXCHANGE.—Strichnia Chromate (Strichnia $\frac{2}{10}$ gr.) and Strichnia Ferri-Cyanide (Strichnia $\frac{1}{10}$ gr.) Will exchange for other slides, Botanical preferred. Only first-class slides offered or desired.

L. A. HARDING, Fergus Falls, Minn.

FOR EXCHANGE.—Mounted slides of Gold Sand, Gold Washings, Wire Silver, Pyrites of Iron, Petrified Wood, etc., for Pathological slides and cut material or other desirable mounted specimens.

W. N. SHERMAN, M. D., Kingman, Ariz.

FOR EXCHANGE.—Diatomaceous earth from Richmond, Va., Nottingham, & Calvert Co., Md., Los Angeles and Santa Monica, Cal., for other diatomaceous material, crude or cleaned, recent or fossil (marine forms preferred), or for diatom or miscellaneous slides (only good mounts wanted).

F. W. DUNNING, 37 Garrison Ave., Battle Creek, Mich.

WANTED.—A set of Proceedings of the American Society of Microscopists. State price of set or of single volumes, kind of binding, etc. Also, any other microscopical periodicals.

P. O. BOX 630, Washington, D. C.



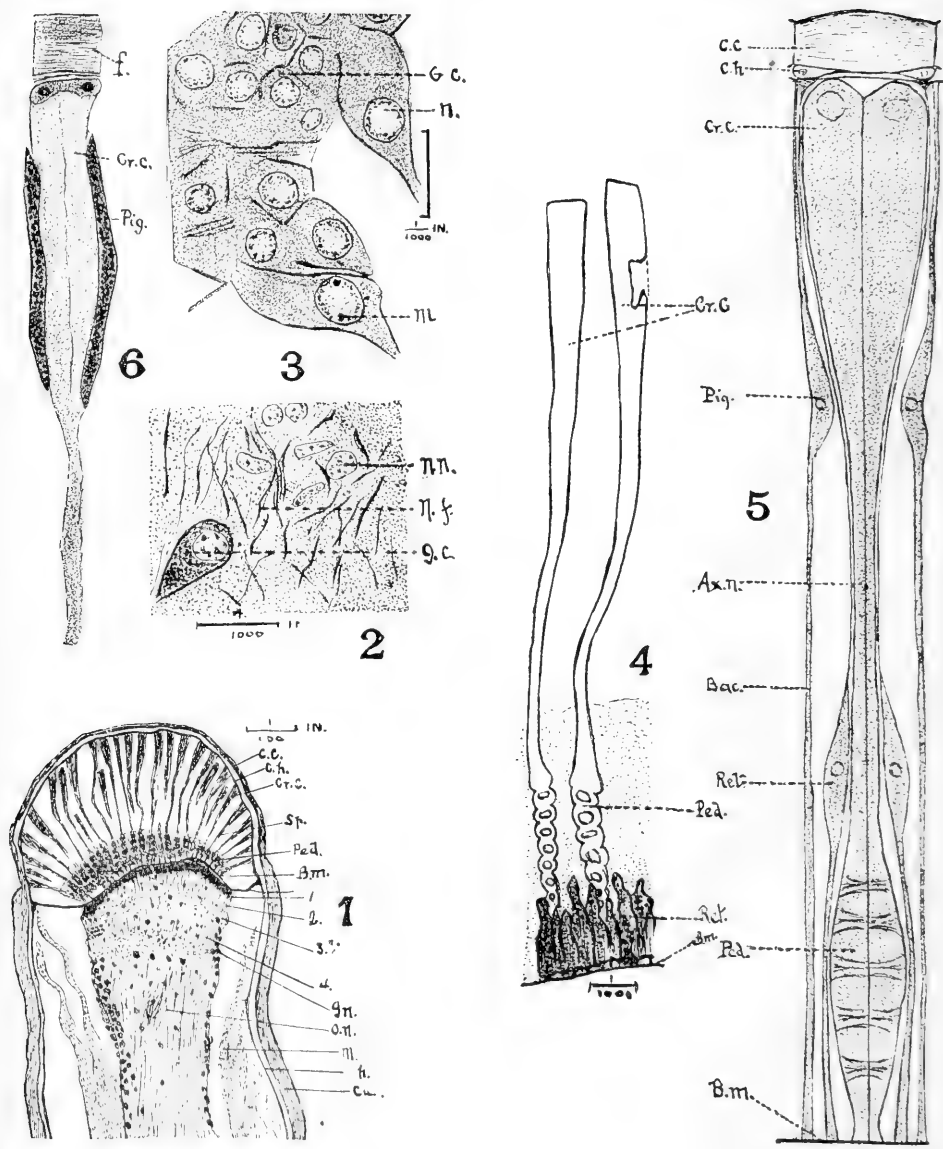

THE EYE OF THE CRAY-FISH

THE AMERICAN MONTHLY MICROSCOPICAL JOURNAL.

VOL. X.

FEBRUARY, 1889.

No. 2.

All communications for this Journal, whether relating to business or to editorial matters, and all books, pamphlets, exchanges, etc., should be addressed to American Monthly Microscopical Journal, Box 630, Washington, D. C.

European subscriptions may be sent directly to the above address accompanied by International Postal Order for \$1.15 per annum, or they may be sent to Messrs. Trübner & Co., 57 Ludgate Hill, London, accompanied by the yearly price of five shillings.

Elementary Histological Studies of the Cray-fish—XII.

BY HENRY LESLIE OSBORN.

HAMLIN, MINN.

CHAPTER V.—THE EYE.

It will be remembered, by those who have followed through from the first this course in the Cray-fish Histology, that the design has been rather to teach how to study histology than to fully elucidate the histology of *Cambarus*. What has been said in describing the green-gland, the liver, etc., has all of it been true so far as I am aware, but it has in no case been the entire exhaustive truth. So many details enter into the mechanism of even the simplest animal, and many are so minute, or for other reasons so difficult of demonstration, that they are passed over by all elementary treatises. Many of them have been only very recently discovered. It has been the aim throughout this series to treat of such appearances in an ordinarily well-made section as can be observed by any one, and of the interpretation of these appearances to form a true mental picture of the real object. Since the articles are written primarily to show microscopists how to become histologists, much is included which does not interest the professional histologist. This didactic style will characterize this chapter upon the eye, and subsequent chapters on teasing and isolation in the study of muscle and nerve.

1. Preparation of the Slide.—The eye of the Arthropod is a far more difficult subject to prepare well than anything we have as yet attempted. In fact, so difficult is it that the best authorities upon its structure are at variance as to the finer points. Much of its more easily learned anatomy is within the reach of any one, and will furnish, by reason of its greater complexity than that of any organ thus far studied, an admirable theme for one of the "elementary studies." If you examine a live cray-fish you will see on either side of the long beak-like projection at the front end of the body a sort of socket bearing a short stump.

rounded and dark colored at the free end and movable. This is the eye, mounted upon a stalk controlled by muscles so as to be movable in a variety of directions. If you leave the cray-fish "to his own devices" you will see that he moves the eye about to suit his own convenience. After killing in chloroform (see vol. viii, p. 82), remove both eyes with a scalpel by cutting carefully at the joint between the eye and the body. In doing this do not pull or tear anything, as it might injure the parts within the stalk; cut straight across them with sharp scalpel or fine sharp scissors. One unused to cells can hardly realize their extreme delicacy and how little crushing, tearing and pushing they can stand. Preserve the eyes, after removal, in some hardening reagent. The reagent can reach the tissue within the stalk by the opening at the base. Any of many methods may be used. Here are two actual records, either of which imitated perfectly will give a fair result. (My sections of the eye, not being the result of special experiments, are by no means ideally perfect. They are, however, as good as or better than a beginner can expect to make, and will therefore be better for this purpose than sections which he could not expect to imitate.)

First Method.—Immerse the eye in 1% chromic acid 5 days, then in 50% alcohol one hour, then in 70% one day, then in absolute alcohol or stain, and then imbed in paraffin by the usual method.

Second Method.—The rods shown in figure 4 were drawn from a section prepared by first method in 1884. When I began this series of articles in 1886, I prepared an eye in a different manner and with better success so far as regards some features. Its exact history was as follows:

(1) Saturated watery solution of corrosive sublimate, 45 min. (2) Running water, 75 min. (3) 50% alcohol, 30 min. (4) 70% alcohol, 27 hours. (5) Picronitric acid, full strength, 60½ hours. (6) 70% alcohol, 11 days 2½ hours. (7) Kleinenberg's hæmatoxylin, 2 days. (8) Washed in 70% alcohol, 10 min. (9) Absolute alcohol, 1½ days. (10) Chloroform, 21 hours. (11) Chloroform and paraffin solution, 5½ hours. (12) Pure paraffin at 56° C., 1 hour. (13) Blocked for section cutting. (14) Sliced in microtome longitudinally. (15) Sections cemented to slide with collodion and oil of cloves. (16) Warmed gently over lamp and washed with turpentine. (17) Turpentine wiped away and replaced by chloroform balsam and covered.

For the sake of any who have begun using this periodical since the beginning of this series of articles, brief comment may be added upon the different steps of this somewhat complicated process, showing the reasons for some of them.

The purpose of the second method was chiefly to secure good preparations of the parts in the lower part of the stalk of the eye. The corrosive sublimate was used for them and to reach the terminal portion if possible. This latter it accomplished, but poorly in places, though it did succeed here and there. The running water is to remove the corrosive so that it will not crystallize in the cells. When alcohol is used it is followed at once by dilute and this by strong alcohol. The water and weak alcohol should not be continued longer than here practised, but the specimen once in 70% alcohol can remain there for any time longer than 24 hours. Picronitric acid (made by adding 2 parts strong nitric

acid to 98 parts saturated watery picric acid solution) was used to decalcify the outer shell. In the first method, this decalcifying was done by the chromic acid at the same time with the hardening. The resultant sections by the first method are not as good as those by the second, except with regard to the crystalline cones. These are some of them shown by the second method, but are badly confused with other retinal elements. The alcohol next used removed the picric acid from the specimen and permitted the access of borax carmine, which stained beautifully the ganglionic nerve cells and also demonstrated very clearly the cells of the corneal hypodermis in many places. The remaining treatment was the ordinary treatment for imbedding and mounting and does not require special comment. One who follows this method carefully will have no difficulty in finding all the structures pointed out by Professor Huxley in "The Cray-fish" (page 119), and many more which he there passes by without remark. A section prepared in this way and examined with the low power is represented in figure 1 of the accompanying plate. To its examination let us now proceed. It must be noticed that since the eye is in reality hemi-spherical, not every longitudinal section will give the appearance seen in figure 1, but only the few which pass through the centre of the stalk or near it. Those which pass to one side of the centre will of course cut diagonally through the radially disposed parts, and such sections will be very much harder to interpret. I have chosen the most favorable section for description. In securing such a section, it will be necessary to mount every section when you think you are near the centre of the stalk, and examine each one until you reach the one passing in the plane of a radius. Several successive sections will now be good, and then the remainder of the eye will be of little use.

2. **Minute Anatomy with the low power.**—Since the entire section cannot be seen at once with a $\frac{1}{2}$ -inch objective it will be well first to examine it with a hand lens or with an inch or lower objective to identify its chief parts, and then place these under a $\frac{1}{2}$ -inch objective for low power study. You will at once observe (1) the semi-circular *cornea* bounded by a band which suddenly on the side becomes thicker, and bounds the stalk as the ordinary *epidermis* or *cuticle* (cu); (2) the area within the cornea occupied by rod-shaped bodies which radiate toward the cornea from the central part of the semi-circular area and form collectively the *retina* or terminal portion of the optic nerve; (3) the area within the stalk which is occupied by several different structures, being shut off in front from the retinal chamber by a sharp line which is the edge of the basilar membrane (B. m.), and on the sides by a second sharp line parallel with the epidermis, the *hypodermis* (h), which may be interrupted in places or pulled away from the cuticle in the process of preparation of the section; (4) the central part of the stalk occupied by the optic nerve (o.n.) and optic ganglion (g.n.); (5) the bands between the nerve stalk and the hypodermis running lengthwise of the stalk, the *eye-muscles* (m). These various parts of the eye once located, we can apply the high power to a study of the various positions in detail.

3. **Histological study with the high power.**

1. *The epidermis* of the stalk, which should be examined before that of the retinal chamber of the eye, is found to be of very considerable thickness and deeply stained in its outer portion, but only faintly within.

It is not obviously cellular in character but banded with alternate stripes of material denser or more open. It is not a tissue of cells, but a condensed secretion poured out from the cells of the layer next below and hardened by contact with the air or water.

2. *The cornea*, which is directly continuous with the cuticle of the stalk, is plainly seen at the point of junction of the two to be of the same composition, viz., layers of non-cellular matter, but it is unlike the cuticle in two respects,—it is thinner and more compact, not being made of alternate denser and more open layers, and it is seen in the section to be divided up into blocks (see fig. 6, f), which fall opposite the retinal elements. These blocks or facets can be seen best in a surface view, which may be made with the low power without any special preparation. They are thus seen as four-sided areas into which the entire corneal cuticle is subdivided. Each is further seen to be slightly convex outward. In life it acts as a lens, and this peculiarity of the eye, so common in all the crustaceans and insects, has given origin to the name “compound eye,” by which such eyes are commonly designated. If desired, a small portion of the cornea of an eye can be sliced off parallel with the surface, the inside removed by short maceration in 5% potash solution and mounted in glycerine jelly. It will show these corneal facets as a very beautifully regular tessellated pavement. A comparison of the cornea will show that both its peculiarities cease at the basilar membrane, no facets being present over the stalk and the cuticle being there less uniform and dense, but thicker. Such a modification of the skin, to serve a particular purpose instead of the introduction of a new sort of substance for a new purpose, is very characteristic of the mode of building found in organisms. The transparent cornea of our own eyes is no wise different in general character from the skin of our faces, though the one is utterly opaque and the other very transparent.

3. *The hypodermis* in the living eye and over the entire body as well is a thin tissue of living cells from which the outer cuticle is produced as an excretion. The hypodermis forms a sort of cone, upon which the outer skin is formed as an entirely lifeless product. In the stalk the cellular character of the hypodermis can be very readily seen from the number and position of the nuclei as well as from the position of occasional cell-walls to be an ordinary columnar epithelium. In the retinal chamber of the eye, however, the character of the hypodermis is not at all plainly cellular (in any of my sections), but it can be seen as a structureless thin strip (see fig. 6 between f and c and c, also fig. 1 c h), which usually tears away from the cuticle and follows the retinal rod or *crystalline cone*, though usually quite distinct from it. It is really cellular as well as that of the stalk. Within the hypodermis the eye structures fall into two distinct sorts—those of the anterior chamber of the eye or the *retina*, and those of the stalk. Let us study first the section of the retina.

4. *The Visual Rod* (taking the name used by Professor Huxley to designate the entire structure shown in figure 4 of the plate) is a transparent body consisting of three different, unlike parts. Outwardly, near the hypodermis, it is broadest, and from this it tapers, at first slowly then more rapidly, as it runs inward. At its inner end it enlarges to a spindle-shaped swelling, which contracts again as it reaches

the basilar membrane. The single rods are illustrated in fig. 4, and the different parts are called in Huxley's account, the (1) *crystalline cone*, (2) the filament, and (3) the striated spindle. Careful examination of the rod will show at its outer end, in many places, a deeper coloration, and perhaps demonstrate a couple of nuclei there (see fig. 6, from sections by second method). Running down the centre of the crystalline cone in places can be faintly seen a very fine line. It can rarely be traced the length of the cone. It indicates that the cone may be composed of two halves. The striated spindle or *pedicle* cannot be clearly seen in the section by the second method, for it is entirely surrounded by certain investing matters. But the chromic acid method displayed them in a very perfect manner with their connection with the rest of the rod. In the corrosive sublimate preparations they can be seen, though less distinctly.

5. *Pigment Cells*.—On the sides of the crystalline cone can be seen very plainly masses of dark, coarsely granular pigment, which more careful study in various places will probably show disposed in long narrow cells between the cones, cells which seem shorter than the cones. In some slides these are plainly cells because their nuclei can be observed. They together form (in good sections) a distinct zone, the "outer dark zone," as it is called by Huxley. The individual cell shapes are but poorly preserved in most sections, those by the second method being compacted, as if by pressure, with the crystalline cones.

6. *Retinulae*.—Surrounding the striated spindles, in the same way as the pigment cells surround the crystalline cones, may be seen a second set of greatly pigmented bodies forming a second "inner dark zone." Carefully analyzed, this is found to be made by a second set of pigment cells embracing the spindle at this lower level. In the chromic acid specimens these cells seem to be much contracted and drawn down toward the basilar membrane, thereby displaying, in a clear manner, the outlines of the spindles, and also, to a certain extent, their own form. In the specimens by the second method the cells are so compressed with the visual rods that neither can be clearly observed.

7. *Basilar Membrane*.—At the back of the anterior chamber of the eye the better sections will show a sharp line limiting this chamber from the cavity of the stalk (see B. m., fig. 1 and fig. 5.) This is a connective tissue membrane which shuts off the retinal chamber from the remainder of the organ. There is reason to suppose that it does not shut off communication between these places in fact, for, though it may not be observable upon your sections, it is believed to be a fact that nerves pass through this membrane and into the visual rods. The parts behind this membrane and a consideration of the proper interpretation of these appearances will form the next number of this series of articles.

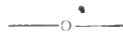

Section Staining by Fluids Mixed with Turpentine.—Prof. C. O. Whitman (*Am. Nat.*, v. 22, p. 1140) describes a process of mixing staining substances dissolved in absolute alcohol with turpentine, thus allowing the staining of serial sections after they have been fixed to the slides and before being mounted in balsam. This method, if it proves practicable, will be a great convenience in the preparation of serial sections.

Notice of New Methods—VII.

By GEORGE C. FREEBORN, M. D.,

INSTRUCTOR IN NORMAL HISTOLOGY, COLLEGE OF PHYSICIANS AND SURGEONS, NEW YORK.

Microscopical Staining. Greisbach, H.—At the meeting of the Anatomical Society held at Würzburg in May, 1888, the author demonstrated several methods of double, triple and quadruple staining. The dyes used were in part anilines of the azo group, and part those of other groups. They were all used in concentrated aqueous solutions, either in combination or as single successive stains. The dyes all bear careful washing in water and alcohol. The stained specimens were cleared in anis oil and mounted in balsam.

The combinations employed were as follows :

DOUBLE STAINS.

Metanil Yellow [Phenylamidobenzolmetasulphonate of soda] and **Azo Blue** [Tetraazoditolybetanaphtholdisulphonate of soda].—Preparation: ala nasi of a child, alcohol hardening.

The sections are stained in a mixture of equal parts of the two staining fluids for 10 minutes, or for ten minutes in the yellow fluid and then for 4 minutes in the blue.

The epidermis, hair shaft, inner root-sheath, striated and smooth muscle stain yellow; the rete Malpighi, the outer root-sheaf, sebaceous and sweat glands stain brownish-yellow; connective tissue, elastic fibres, and membrane of fat cells stain violet-blue; hyaline cartilage and nuclei do not stain.

Metanil Yellow and Methyl Green.—Preparation: ala nasi of a child, alcohol hardening.

The sections are stained in a mixture of 5 c.c. of the yellow staining fluid and 3 c.c. of the green. A crystalline precipitate forms which does not interfere with the staining. The sections are allowed to remain in this fluid for 8 minutes or longer [$\frac{1}{4}$ of an hour], or they are stained for 8 minutes in the yellow fluid and then for 1 minute in the green.

Epidermis, hair-shaft, inner root-sheath, striated and smooth muscle stain yellow; the rete Malpighi, outer root-sheath hair-follicle, sweat and sebaceous glands, and nuclei stain green; hyaline cartilage and cells stain green.

Metanil Yellow and Crystal Violet [Hydrochloride of hexamethylparaoaniline].—Preparation: ala nasi of child, alcohol hardening.

Mix 7 c.c. of the yellow fluid with 2 c.c. of the violet. An amorphous precipitate results which does not interfere with the staining. The sections are stained in this mixture for 6 minutes, or they are stained for 10 minutes in the yellow fluid and then for 30 seconds in the violet.

Epidermis, hair-shaft, inner root-sheath, connective tissue, and elastic fibres, the membrane of fat cells, and striated muscle stain yellow; the rete Malpighi, the outer root-sheath, all glands, smooth muscle, and cartilage with its cell nuclei stain violet.

Metanil Yellow and Safranin.—Preparation: human lip, alcohol hardening.

Mix 6 c.c. of the yellow fluid with 1 c.c. of safranin. An amorphous precipitate forms. This mixture gives either with a long or short stain more sharp pictures than the successive single staining.

Connective tissue stains yellow; epidermis, the rete Malpighi and the analogous layer in the mucous tissue, muscle, and labial glands stain light red, the nuclei standing out sharply.

Metanil Yellow and Crystal Ponceau [Alphaazonaphthallin-disulfobetaphenanthroline of soda].—Preparation: spinal cord of calf, alcohol hardening.

For the single as well as the combined stain, twenty-four hours are required.*

The gray matter stains yellow, the white reddish. Under strong magnification the neuroglia and connective tissue are found to be stained yellow; the axis cylinders dark bluish red; the myelin light yellowish red; one sort of ganglion cells dark purple, another bluish red; nuclei do not stand out sharp.

Metanil Yellow and Congo Red [Tetraazodiphenyldinaphthylaminodisulphonate of soda].—Preparation: spinal cord of calf, alcohol hardening.

The sections are stained in a mixture of the staining fluids for 8 minutes, or they are stained for 10 minutes in the yellow stain and then for 5 minutes in the red.

Ganglion cells [without clear nuclei staining] and axis cylinders stain dark violet-red; the medullary sheath light citron-yellow; neuroglia and all connective tissue light violet-red; epithelium of the central canal brownish-red.

Carminate of Soda and Metanil Yellow.—The central nervous system is hardened in Müller's fluid, then stained *in toto* with the carmine fluid. Sections are then stained for ten minutes in the yellow stain.

All nervous elements are stained red, all connective tissue elements yellow.

Crystal Ponceau and Crystal Violet.—Preparation: transverse section of the carotid of the calf, alcohol hardening.

The sections are stained for 5 minutes in the red ponceau fluid and then for 1 minute in the violet.

Nuclei of the endothelium and smooth muscle stain violet; all the other tissues red.

Congo Red and Anisol Red [Bisulfoxylnatronbetaoxynaphthalinazoorthometoxylbenzol].—Preparation: spinal cord of the calf, alcohol hardening.

The sections are stained for 5 minutes in the combined stains, or for 5 minutes in the Congo red solution and then for 5 minutes in the anisol red.

Axis cylinders and cell bodies stain purple; all other tissues stain light red. Nuclei do not stain.

Metanil Yellow and Athylin Blue.—Preparation: ala nasi of a child, alcohol hardening.

When the two staining solutions are combined a black precipitate is formed, which re-dissolves in an excess of the metanil yellow solution. This solution stains yellowish-green, the cartilage only being stained blue. If the sections are first stained for 5 minutes in a mixture of 5 c.c. of the yellow and 4 c.c. of the blue stains, or if the sections are stained for ten minutes in the yellow and then for 2 minutes in the blue, the pictures will be sharp.

The epidermis, hair-shaft, outer root-sheath, connective tissue, elastic fibres, smooth and striated muscle stain yellow; all glands, membrane of fat cells, cartilage and nuclei stain blue.

TRIPLE STAINING.

Metanil Yellow, Methyl Green and Safranin.—Preparation: ala nasi of a child, alcohol hardening.

The sections are stained for 8 minutes in the yellow solution, then for 30 seconds in the safranin solution, then for 20 seconds in the methyl green solution, and finally passed through the metanil yellow solution.

The different elements are differentiated as in the double stain with metanil yellow and methyl green, except the color is of a darker shade and all muscular elements are stained red.

Metanil Yellow, Crystal Ponceau and Crystal Violet.—Preparation: ala nasi of a child, alcohol hardening.

The sections are stained for 2 to 16 minutes in a mixture of 5 c.c. of the yellow solution, 5 c.c. of the ponceau solution, and 3 c.c. of the violet solution, or they are stained for 8 minutes in the yellow solution, then for 6 minutes in the ponceau solution, and finally for 15 seconds in the violet solution.

Cartilage and nuclei of cartilage cells, the superficial layer of the epidermis stain blueish-violet; connective tissue, elastic fibres and glands stain light red; the deep layer of the epidermis, the rete Malpighi, hair-shaft, the root-sheaths, membrane of fat cells and muscle stain yellow.

Metanil Yellow, Azo Blue, and Methyl Green.—Preparation: ala nasi of a child, alcohol hardening.

The sections are stained for 10 minutes in the yellow solution, then for 6 minutes in the blue solution, and then for 2 minutes in the green solution; finally the sections are passed through the yellow solution.

The epidermis, hair-shaft, inner root-sheath, smooth and striated muscle stain yellow; membrane of cells, the rete Malpighi, membrana propria of glands, elastic fibres and connective tissue stain violet; nuclei of gland cells and nuclei of the cells of the Malpighian layer, outer root-sheath, smooth muscle and connective tissue stain green.

Crystal Ponceau, Methyl Green and Crystal Violet.—Preparation: ala nasi of a child, alcohol hardening.

The sections are stained for 8 minutes in a mixture of 10 c.c. of the ponceau solution, 4 c.c. of the green, and 2 c.c. of the violet, or they are stained for 8 minutes in the ponceau solution, then for 3 minutes in the methyl green solution, and then for 5 seconds in the violet solution.

The epidermis, hair-shaft and outer root-sheath stain violet; smooth and striated muscle, elastic fibres and connective tissue stain rose-red; the stratum mucosum stains green; the inner root-sheath, all glands and membrane of fat cells, cartilage and nuclei of its cells stain green.

QUADRUPLE STAINING.

Metanil Yellow, Safranin, Methyl Green and Crystal Violet.—Preparation: ala nasi of a child, alcohol hardening.

The sections are stained for 20 minutes in the yellow solution, then for 1 minute in the safranin solution, then again for 5 seconds in the yellow solution, then for 2 minutes in the methyl green solution, then again for 5 seconds in the safranin, then again for 5 seconds in the yellow solution, and finally for 10 seconds in the violet solution.

The epidermis, hair-shaft, inner root-sheath, and all nuclei stain yellow; the rete Malpighi, outer root-sheath, sweat glands, sebaceous glands, the nuclei of cells and smooth muscle stain green; nuclei of connective tissue, elastic fibres, lobes of the sebaceous glands with the nuclei of their cells, membrane of fat cells, stain red; cartilage and the nuclei of its cells stain violet.

Report upon the Postal Club Boxes—III.

By QUEEN MAB.

(Continued from page 8.)

Box W².—No. 3 contains crystals of sulphur by Prof. C. H. Kain.

No. 4 is by E. E. Read, Jr., Camden, N. J., and contains the transverse section of a seed of *Collomia*. It was cut with a common razor while held between the thumb and finger, mounted in balsam, and ringed with Brunswick black, which is unfortunately showing its fallibility by 'running in.' Objectives recommended; 1" for cell structure, and $\frac{1}{4}$ to $\frac{1}{6}$ for protoplasm.

No. 5 is a section of *Nelumbium luteum*, mounted in balsam, and is by A. P. Brown, of Camden. To a querist asking whether there is any probable difference in the chemical composition of those portions which stain with carmine and those taking iodine green, Rev. A. B. Hervey replies:—'Some of the cell-walls colored green in this specimen are those which are usually lignified, viz., those of the vessels and sheath of the vascular bundles. The presence of lignin in these cut walls could easily be detected by the use of proper re-agents, as set forth on page 330 of the translation of Dr. Behren's 'Guide to the Microscopical Investigation of Vegetable Substances.'

Slide No. 6 is a desmid, by John M. Betts, of Camden, and though a difficult object to preserve, retains its form perfectly, having been mounted in weak camphor water for over two years.

The irregular arrival of boxes in January emphasizes anew the importance of each member strictly conforming to the rules by forwarding boxes at the expiration of the three days during which each is entitled to keep them. Only thus can the greatest efficiency be attained. A new departure has been instituted this year by circulating a larger number of the Cole Studies, and calling for fewer contributions from the circuits, thus raising the standard of the preparations circulated. There is one serious drawback to the enjoyment of the Cole Studies as now circulated. A pamphlet of text and box of slides enclosed in a pasteboard roll being unable to withstand the rough usage encountered in the mails, it has become necessary to have the boxes enclosed in tin and leather cases, while the pages of the text have been cut in halves to fit a letter envelope. This prevents consecutive paging of the re-modeled text, and to some whose time is too valuable to be applied to the solution it constitutes a serious annoyance. Probably the present form is the least of two evils, but it is to be hoped that Mr. Cole will consider this defect. His studies are otherwise incomparable and present excellent examples of that happy medium—a popular style without sacrifice of scientific accuracy—while many of the slides are ideal preparations.

Box be.—The description of this box is a model of minuteness and

completeness. It contains one preparation each of vegetable and animal anatomy. The vegetable section is a transverse one of the stem of maize, selected as presenting a typical Monocotyledon, is mounted in balsam, and is to be viewed with polariscope and paraboloid. Roots in general are first described. Beyond their primary function of fixing plants to the ground and absorbing nutriment therefrom, roots are often reservoirs of nutritious matter and become greatly enlarged, *e. g.*, the turnip, carrot, etc. Aerial roots formed by tree ferns and orchids are modifications meeting special needs: in orchids both fibrous and bulbous roots are developed, the one as organs of absorption, and the other storing up nutriment. The microscopic characteristics of root are then described. The stem of a plant is the organ which develops leaves, flowers and fruits; the part of the plant which grows in an opposite direction from the roots, shooting upwards through and above the ground. The popular application of the term "stem" to that portion only which grows above the earth is incorrect, for many plants possess under-ground stems. For further descriptions of stems, the student is referred to text-books of botany. The forms of stems are then considered, the typical form, approaching the cylindrical, and its variations. The special functions of the stem are the support of the leaves, flowers, and fruits, and the conveyance, through channels, throughout the plant of the nutritious compounds absorbed from the soil. The nature and texture of stems vary according to the duration of the life of plants: annuals, and biennials having as a rule soft stems, while perennials and trees have stems more or less woody.

Numerous bundles of fibro-vascular tissue are scattered throughout the stems of monocotyledonous plants, the whole structure being invested with an epidermis. A plate represents an isolated fibro-vascular bundle, surrounded by the ground tissue of the stem. The two large ovoid orifices lying side by side in the centre of the fibro-vascular bundle are very wide vessels, having pitted markings and comparatively thin walls. The circular orifice between these is a spiral vessel; the oval space under this is a vessel with annular markings or thickenings, and below it is an air space. Between the two large central vessels lie *tracheides*, which convey water. Above and between the pair of central vessels is a patch of soft *bast* formed of sieve tubes, whose function is the conveyance throughout the plant body of nitrogenous food supplies. A sheath of narrow, elongated, thick-walled cells (*sclerenchyma*) completely surrounds and protects each fibro-vascular bundle. If a transverse section of stem of maize be examined, there will be seen —

1st. The *epidermis*, formed of flattened cells (protected by a *cuticle*), with openings (*stomata*) here and there through it.

2d. A layer of cells with thick walls (*sclerenchyma*) developed in order to strengthen the stem.

3d. The *ground tissue*, made up of thin-walled *parenchymatous* cells, with inter-cellular spaces.

4th. The *fibro-vascular* bundles, distributed through, and surrounded by, the ground tissue, as already described.

The remaining slide of this box is a section of normal human kidney, hardened in Müller's fluid and spirit, cut with the freezing microtome, stained with logwood and eosine, and mounted in Canada balsam, and it is described with the minuteness, completeness, and lucidity of the first preparation.

Desmids: Their Life History and Their Classification.*

By REV. FRED'K B. CARTER,

MONTCLAIR, N. J.

Hardly any attention has been bestowed upon the desmids by the microscopists of this country, if we are to judge by the pages of the *Microscopical Journal* for the past seven years. There are but two or three articles which deal with this subject in all those volumes. Note the multitude of pages on the diatoms and be struck by the contrast. Microscopists seem almost to have gone diatom-mad. The amount that has been written on the resolution of fine lines and dots would alone fill a volume. Now, while the attempt to resolve the more difficult diatoms has been vastly beneficial to the makers of objectives, it has not proved of much solid benefit to the amateur. Had he spent a quarter of the time he has given to this task in the observation of any one of half a dozen interesting members of the animal or vegetable world, biologically and systematically considered, he would have gotten far more use out of his tube and been able to help others as well. These neglected desmids, for example, are equally worthy of study with the diatoms—far ahead of them in interest if the examination of the latter is confined to the resolution of delicate markings.

The desmids are to be found everywhere, climate interposing no barrier to their distribution, from the north pole to the equator. Wolle says:—‘They are nearly equal in number of species to that of all the other orders of fresh-water algæ.’ They occur in immense quantities. Last spring a good sized pond in Orange, N. J., was so coated with a single species of *Closterium* along the border that the mud beneath was almost concealed. The mind wearies as it tries to conceive of the billions upon billions of this single species in that one pond alone. They are of wonderful diversity, ‘no other family in the whole range of the plant world presenting such a boundless variety of forms.’† They are strikingly beautiful in shape and color and markings.

They are almost at the bottom of the vegetable kingdom, among the lowest of all green things upon the earth, in this respect rivalling the rhizopods in the animal scale. Furthermore, they give us the key to the whole biological problem, the typical cell; surely here is enough to attract any one. I confess I feel strongly on their neglect. Nor is it strange, since it was a desmid which, by its exquisite symmetry, first really started me on my microscopical work twelve years and more ago. I can see the little beauty as plainly as if it were yesterday. All the surroundings of the room and the persons who were present are photographed on my memory, and I can feel again the thrill of delight that came with the discovery of that *Micrasterias*. That little plant gave me the first impetus; created an enthusiasm which has not died out yet, but rather has increased as the years have gone on. No wonder then that the desmids are favorites of mine.

The desmids are algæ which, in the matter of reproduction, resemble Palmogloea. Now, Palmogloea is a ‘humble Protophyte which presents the phenomena of cell division, conjugation, and gonidial multiplication, under their simplest and most instructive aspect.’ A marked feature of all plants is the cells of which they are composed, and as the

* Read before the Essex County Microscopical Society, Nov. 15, 1888.

† Nave's Handy Book of Algæ.

desmids are one-celled plants of the lowest type, we have here the vegetable kingdom as it were in a nutshell, reduced to the last analysis. The life-history of the individual cell forming, according to Schleiden,* the true basis of the study of vegetable life in general, the desmids afford admirable examples for just such study and furnish the key to the whole problem.

In the typical plant cell we have the cell-wall and the cell contents. Now, this cell-wall is double, and the two layers are different; the inner is the more important of the two and it is practically identical with the protoplasm which fills it, being albuminous in character and having little to distinguish it but its thicker consistence and the absence of granules. But the outer layer is made up of cellulose which, says Carpenter, seems to be excreted from the surface of the inner layer. Now, the sarcode of animals and the protoplasm of plants are identical.† We may say then that the *animal* cell is free protoplasm, the *plant* cell protoplasm enclosed and limited by a *cellulose* layer or covering. For chlorophyll is not a necessity to the vegetable cell; it is absent in the fungi and in lichens; so close is the vegetable to the animal kingdom at this point. Indeed, as Carpenter says, 'it is impossible to draw a definite line of division between fungi and protozoa in some cases.' The plant protoplasm excretes cellulose, the animal sarcode or protoplasm excretes chitin, and as the outer layer (of cellulose) is not essential‡ to the existence of the plant, nor the shell or test to the rhizopod, we may say that the plant and the animal are identical so far as substance is concerned. Protoplasm and the primordial utricle—whether ectosarc or ectoplasm—these are what really constitute protophytes and protozoa alike. We may represent it by a circle of which the inner portion is protoplasm and the boundary primordial utricle. Here are the essentials of plant and animal, and they are the same in both cases. The protoplasm is the same in each, the *primordial utricle* is the same in each, *nitrogenous*, *albuminous* in plant as well as in animal. A marvellous fact this and well worth remembering carefully. Add on now a *cellulose* wall (represented by an outer boundary line to the circle) and you have the typical plant cell with its protoplasm limited by the primordial utricle and enclosed in a layer of cellulose; and the test is carmine, which stains dead protoplasm but leaves the cellulose unstained.

Under the contents of the plant cell we have chiefly to consider the nucleus and the chlorophyll corpuscles. Note, again, that the former is *albuminous* in both plant and animal, another striking bond of union, as it is the very centre of vital activity. The *initial force*, therefore, is of the same character in both kingdoms. Within the nucleus there are frequently smaller bodies, the nucleoli. Others go still further and speak of nucleo-nucleoli, and a recent writer, Conn. tells us that we must, on this account, as well as for other reasons, entirely change our ideas regarding the typical cell. But it is hardly necessary to do more here and now than refer you to his striking article in the August number of the *Microscopical Journal* (1888), and to Prof. Whitman's abstract in the same *Journal* for November. The chlorophyll corpuscles

* Carpenter, The Microscope.

‡ Max Schultze, quoted by Carpenter.

† Encyclopædia Britannica, Article on Biology.

are also bits of protoplasm which are largely *albuminous* (note that again), distinguished by their green color. These 'decompose CO². and fix its carbon, by union with the oxygen and hydrogen of water, into starch.'* They are of the utmost importance, therefore laying the foundations on which the various vegetable substances are built; but there is nothing more to say about them from an optical stand-point than has been said.

But even these few parts, we are reminded, are not always distinguishable in the lowest forms. The cellulose wall and the nucleus are sometimes apparently absent, and the inner layer hardly differs from the substance it encloses. This would correspond almost exactly to a naked rhizopod, an amœba, so far as structure is concerned. And here let me quote some striking words of Huxley on this point. 'It is not necessary,' he says, 'to the morphological unit of the plant that it should be provided with a cell-wall. Certain plants, such as *Protococcus*, spend longer or shorter periods of their existence in the condition of a mere spheroid of protoplasm. . . . Therefore, just as the nucleus, the primordial utricle, and the central fluid are no essential constituents of the morphological unit of the plant, but represent results of the metamorphosis, so the cell-wall is equally unessential. . . . The histological analysis of animal tissues has led to results . . . of precisely the same character. . . . It is certain that in the animal, as in the plant, neither cell-wall nor nucleus are essential constituents of the cell. . . . For the whole living world, then, it results:—that the morphological units—the primary and fundamental form of life—is merely an individual mass of protoplasm, in which no further structure is discernible.'† Another striking point of resemblance between the two kingdoms Carpenter brings to our notice, that certain Protophytes 'not only move like animalcules by cilia or flagella, but exhibit the rhythmically contracting vacuoles which are specially characteristic of *Protozoic* organisms.'

Now the desmids have the outer coat, primordial utricle, and protoplasm with its chlorophyll corpuscles which are found in the typical cell as commonly understood. They afford a splendid opportunity, therefore, for the study of cell life. It is evident, also, that their structure is almost as simple and easily mastered as that of the rhizopods. There is little to describe. They have no differential parts, I mean, such as root, stem, branches, leaves, organs of reproduction; there is no nucleus visible in the majority of cases. In *Cosmarium*, *Euastrum*, and other genera, however, there are often large circular masses of granules which Wolle in some cases calls *chlorophyll nuclei*, in others *inflations* or *protuberances*; and some regard the whole endochrome as a diffused nucleus, the scattered granules of which they term nucleoli. But we may disregard this as still a matter of dispute. Outside and inside, cell-wall and endochrome, these are all we have to study usually. The inside is much the same in general appearance in the different genera: the outside gives us great variety of shapes, markings, and processes, and sometimes, as in *Closterium*, seems to be of a siliceous character. Occasionally crystals are met with in the interior, and at the period of reproduction the endochrome presents an altered arrangement. In

* Carpenter.

† Encyclopædia Britannica, Article on Biology.

common with other families of algæ, some of the desmids (*Euastrum* for example) present the phenomena of polarization to some extent. But as far as structure is concerned, from an optical point of view, it is a very simple study in biology. We are at our A, B, C's. This is primer work in the vegetable kingdom. You can hardly get any lower down. The lichens and fungi are the only things beneath. Of all the green things upon the earth, let me say again, the desmids are among the very simplest.

But when you pass from their structure to their motion a difficult problem presents itself. This motion is of three kinds. There is the flow of the protoplasm; the twisting or swarming of little granules in the vacuoles of some genera and in the body of the cell or semi-cell in others, at certain stages; and the motion of the plant, as a whole, resulting in change of place. And of neither of these can any satisfactory explanation be given; all that can be done is to state the facts and describe the several movements respectively. The flow of the protoplasm seems to be a true cyclosis or circulation extending over the whole cell or semi-cell; the dancing of the granules in the vacuoles of *Closterium* is local, and is apparently produced by the general flow; the swarming of the little bodies in *Cosmarium* and other genera is also local, but not connected with the circulation, as it is not always present. It appears when the plant is at its fullest life, and would seem to be related to reproduction. The external motion is a slow sailing, and is not characterized by the definiteness of direction so marked in diatoms, the desmid frequently turning half-way or completely around as it moves across the field. The dancing granules at the ends are confined, so far as I know, to *Closterium*, *Penium*, and *Docidium*, and the swarming is most pronounced in *Cosmarium* and *Euastrum*. In *Micrasterias* and *Euastrum* you will sometimes find black bodies of considerable size scattered over the interior of the cell. In a gathering of large specimens of these genera made during the past summer and that of the previous year they were very distinct. What their purport is no one appears to know.

Reproduction is by both subdivision and conjugation. In the first process each semi-cell forms the counterpart of itself. These may remain attached for a time and up to a certain number, as in *Docidium* or *Micrasterias*, where we may have from two to twenty cells in a row, or they may keep together until the period of conjugation, forming the filamentous desmids. In conjugation, which is a true generative process, two cells separate each into two valves, and the contents of both fuse and form a zygospore. In the filamentous species a connecting tube unites the cells, and the contents of one pass entirely over into the other and form the spore. Wollé says that the germination of the spore is very rarely detected. I, for one, have never observed it, although the desmids have been constantly under my eye for years. Germination is said to occur in the spring and the result is a copy of the parent; in *Cosmarium* the spore is said to produce a number of such like forms. There is a chance here for the student to add to our knowledge, but it would appear to be slight. So much for the life-history of the desmids; next we come to the classification.

BIOLOGICAL NOTES.*

Typhoid Fever and Water Supply.—One of the most timely and sensible papers recently reported is that of Dr. Chas. Smart, Surgeon U. S. A., given before the American Public Health Association at its recent meeting. The paper itself has not come to our notice, but if the reports are in any fair degree accurate the paper treats the question of water supply as connected with typhoid fever in a way that reflects credit upon the author. The enormous number of deaths from this disease throughout the country is a sad reflection upon the carelessness with which this matter of water supply is considered. When the authorities of our cities and larger towns take a more intelligent view of the question, private supplies in the smaller towns will be more scrupulously attended to. Wells in thickly-settled towns are hardly better than death pots. If ever used to supply drinking water they should be frequently examined by an expert with the microscope. Chemical examination often fails to detect the worst dangers. A case examined by us a few years ago in which several members of a family had been prostrated by the disease afforded little chemical warning, but a careful microscopic examination revealed the source of danger.

Yellow Fever.—The adverse report of Surgeon General Hamilton regarding the bill offering a reward of \$100,000 for the discovery of the true germ of yellow fever is wise. More liberal reward for work done and results obtained by accurate and patient research cannot fail to meet the approval of all scientists, but such a bill as the one proposed would hardly fail to lead to contention and would be far from certain to place the reward where it would be most deserved. The spirit of research will give the facts to the world without the offer of inducements in the form of prizes, if only the means of carrying on the research can be provided. Meanwhile, however, much may be done to render investigations more fruitful of results by the encouragement of investigators in connection with the National Bureau of Health, and the enforcement of more rigid laws of sanitation in the sections subject to the scourge will accomplish much more for the immunity of the people. The condition of Jacksonville as regards sanitary provisions, according to the report of General Hamilton, is a crying demand for more strict regulations. Self-interest will not induce certain members of society to guard themselves against sources of danger which are not of the most glaring nature, and for the protection of others these recreant members should be forced to abide by such rules as the common interest demands.

Black Rot of the Grape.—To all who are interested in the culture of the grape, Bulletin No. 7 of the Botanical Section of the Department of Agriculture is specially important. It is the report of Mr. F. Lamson Scribner, Chief of the Section of Vegetable Pathology, upon the ravages and mode of treatment of the parasitic fungus, *Laestadia bidwellii*, which causes the disease known as the black rot of the grape. The very wide distribution of the disease and the small number of varieties

* This department is conducted by Prof. J. H. Pillsbury.

of the grape that are even in a slight degree exempt from its attacks renders the investigations, the results of which are given in this report, of great practical value. The regions in which a moist and warm atmosphere prevails while the grape is maturing and ripening are found to be most favorable for the development of the disease. Nearly all the most popular varieties are very susceptible to the disease, and those especially which have a rich juicy pulp. A few varieties that have been much cultivated, notably the Concord, are nearly free from the attacks. The most important part of the report, however, is that which treats of the remedy. The report claims that treatment with a mixture of copper-sulphate and lime in solution sprayed upon the vines completely protects them from the attacks of the fungus. Six pounds of copper-sulphate is dissolved in 16 gallons of water, and 6 pounds of lime slaked in 6 gallons of water. After the latter is cool the two are mixed and the solution sprayed upon the vines. It was found that there are two periods of attack, one about June 22 and another about July 18 or 19. Another bulletin is promised, giving a more detailed account of the experiments, and it is to be hoped that it will contain definite instructions concerning the mode of treatment likely to be most effectual and universally applicable. Mr. Scribner deserves great credit for the efficient service he has rendered grape cultivators. Prof. Pierre Viola, who was appointed by the French government to visit this country in the interest of viticulture, worked with Mr. Scribner during the summer of 1887, and the report is issued by them jointly.

—o—

New Staining Fluid.—Dr. Gustav Platner has used a new stain, which he calls "nucleus black," for staining nuclei. It is found to work much more generally than safranin, and is capable of giving any degree of intensity.—(*Zeit. f. Wiss. Mic.*)

—o—

Healing of Wounds.—Prof. Leon Le Fort is reported (*Science*, vol. 12, p. 211) as believing that the impurity of the air has no injurious effect upon the healing of wounds. This opinion seems remarkable in view of the various tests that have been applied by various investigators, both to determine the presence of disease germs in the air and effect of purified air upon the healing of wounds. Something more than an opinion will be needed to convince the intelligent public that the Professor is correct.

—o—

Killing the Yellow Fever Germs.—At Jacksonville, Fla., steaming and drying rooms are building to be used for disinfecting bedding, carpets, and clothing. The rooms are tight compartments, 10 × 12 × 6½ feet in dimensions and are closed by trap-doors which are raised by means of pulleys. There is one steaming room and two drying rooms. The floors of the rooms are covered with steam pipes, those in the steaming room being perforated every six inches to allow of the escape of fine jets of steam. It was expected to begin operations on Dec. 4.

For blankets and such other articles of bedding as can be saved, three large cylindrical vats have been prepared, where they will be thoroughly purified with boiling water, after which they will be put through a steam wringer which revolves with great rapidity, forcing the water out.

BACTERIOLOGY.*

Method of Preparing Nutritive Gelatine.—The following method is one of the best. Tubes to be used for the storing and subsequent inoculation of the gelatine must be thoroughly cleansed, dried, plugged with cotton-wool or fine cotton, and sterilized. This is done by heating them for one hour in a hot-air sterilizer or oven at a temperature of 150° C. (300° F.)

Care should be taken that the plugs fit firmly, but not too tight. When the tubes are ready the following method is recommended:

Take, for example, 250 grams (about one-half pound) of good beef after all fat has been removed. Chop or grind this to a fine pulpy mass. Transfer it to a beaker, and add 500 c.cm. of distilled water—*i. e.*, 2 c.cm. of water for every gram of chopped beef. Thoroughly stir up the beef in the water, and then place it in an ice-box, or, if in winter, in a cold room until the next day.

On the following morning the meat infusion should be thoroughly stirred, and the liquid portion separated by filtering and squeezing through a linen cloth. The red liquid thus obtained must be brought up to the amount of water taken on the previous day by adding distilled water. To this is now added 1% of peptone, $\frac{1}{2}$ % sodium chloride, and 10% of the best gelatine. This would be in the case taken, 5 grams of peptone, 2.5 grams of salt, and 50 grams of gelatine. The beaker containing this mixture is now placed in a water bath and heated to 45° C. and allowed to stand for some minutes, until the gelatine is completely dissolved.

The next process requires the greatest care and attention. Most micro-organisms grow best in a slightly alkaline medium. This is obtained by adding, drop by drop, a nearly saturated solution of sodium carbonate to the beef-infusion-peptone gelatine mass until the reaction is slightly alkaline, which is determined by its turning red litmus paper to a faint blue. If by accident it should be made too alkaline it can be neutralized by the addition of lactic acid. In order to clarify it the white of two eggs is now added and thoroughly stirred into the gelatine mixture.

It is now boiled for one-half hour by placing the beaker or flask containing it in a large water bath or covered kettle. After boiling it is allowed to cool and set, after which it is again heated to the boiling point, and filtered while hot. A hot filtering apparatus is necessary for this. It may, however, be filtered with the ordinary filter in a hot-air chamber at a temperature of 60° C. The funnel should be kept covered while filtering to avoid evaporation.

The process of filtration must be repeated if necessary until the filtrate is perfectly clear. It is of a pale amber color generally, varying in tint according to the amount of blood in the meat used. It is desirable to filter it into a sterilized narrow-necked flask to avoid evaporation. It is now ready to be distributed in tubes. The sterilized test-tubes are filled for about one-third of their depth (7 to 8 c.cm. in each) by pouring in the gelatine carefully and steadily to prevent the mixture from touching the part of the tube with which the plug comes in con-

* This department is conducted by V. A. Moore, assistant in the laboratory of the Bureau of Animal Industry.

tact, otherwise when the gelatine sets the cotton-wool adheres to the tube and becomes a source of embarrassment in subsequent procedures. Care also should be taken not to contaminate by touching or otherwise that part of the plug that belongs within the tube during the process of pouring the gelatine into them.

After the tubes are filled they should be placed in a wire basket and suspended in a steam sterilizer for ten minutes after the thermometer indicates a temperature of 100° C. This is repeated each day for three successive days. This has been found sufficient to sterilize the gelatine. If one has not a sterilizer the tubes may be placed in a water bath and be boiled for five minutes each day for three successive days. If the gelatine is boiled too much it will not set upon cooling and is therefore worthless. After the gelatine is sterilized it should be kept in a cool place until used.

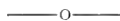

Cultivation of Bacillus Tuberculosis on Potato.*—Dr. A. D. Pawlowsky cultivates the bacillus of tubercle on potato as follows:—Into narrow test-tubes of the shape devised by Roux are placed slips of potato. These are then sterilized for half an hour at a temperature of 115° C. When withdrawn from the steamer, the tubes are placed at an angle of 30° in order to get cool, and also to drain. The potato is then inoculated, the tubes plugged, and kept at a temperature of 39° C.

After twelve days' incubation the culture appears. It is whitish and glossy, and shows up distinctly against the yellow color of the potato. In 5 to 6 weeks the surface is covered with greyish white granulations. If glycerinated potato be used, the bacillus seems to develop with greater rapidity. The pathogenic properties of the bacillus are quite maintained; rabbits inoculated therewith die in 18 days.

The author is of opinion that the reason why other experimenters have failed to propagate the bacillus on potato is that they have failed to recognize that humidity is an essential condition of the life of this microbe.

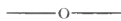

Spore formation in the Bacillus of Glanders.†—Prof. P. Baumgarten states that Dr. Rosenthal has made numerous experiments to determine the question, previously unsolved, of endogenous spore formation in glanders bacillus. Numerous experiments with cover glass preparations from somewhat old potato cultivations of this microbe have shown the presence of spores, the appearances resembling those obtained with anthrax bacillus. Neisser's method for staining spores (one hour's staining in Ehrlich's fuchsin solution in a steam sterilizer at 100° C., or 150° C. with dry heat, decolorizing in hydrochloric acid and alcohol, and after staining with methylin blue) was adopted. The spores were colored a deep red, and the rest of the rodlet blue. The spores were for the most part free, but sometimes within the bacilli. It must therefore be considered as settled that glanders bacillus forms spores, but whether always or only under certain conditions remains to be determined.

* Ann. Institut. Pasteur, ii, 1888, 303.

† Centralb. f. Bak. u. Parasit., 1888, iii, 397.

EDITORIAL.

The Scientific Publications of the Government.—A word upon the increasing importance of these issues and especially *how to obtain them* will be welcomed by every scientific worker. Numerous pamphlets, and at times very costly books, are being printed by order of Congress. A given number (between 1,500 and 2,000) are always printed, and of important volumes "extra copies" are ordered. These are placed at the disposal of Senators, Representatives, and heads of Bureaux, for gratuitous distribution. Frequently copies are also printed to be sold merely at a *pro rata* cost price of the mechanical work involved.

Senators and Representatives who feel sure of retaining their places distribute their quotas largely to public libraries in their States and districts. Those who feel the need of friends often place their books "where they will do the most good." Those who have lost their places and their friends are said at times to sell their books to dealers.

Dealers have three sources for obtaining books: (1) They buy at the Government Printing Office or Departments. (2) They buy out retiring Congressmen. (3) They buy at library auctions and from other private sources.

How to get the books.—First. You must know definitely what to ask for. A general request to send you something on Meteorology or on Yellow Fever will usually fail: (1) because your correspondent sees that you have nothing definitely in mind; (2) because he has not time to hunt out a title for you.

Second. Prefer a polite request to the Representative from your district, especially if he is of your party. If that fails, and your name is well known in the State, try one and then the other Senator from your State. If you can enclose a letter of introduction from a citizen *influential in politics* do so.

Third. If you yourself have published something—anything—enclose a copy to the head of a Department or Bureau, requesting in exchange a publication of theirs, which you specify. This will work in most cases, unless you ask for too much, and they will usually give you far more than you give them.

Fourth. When all else fails, money will do the deed. There are dealers in Washington who make a business of getting and mailing this class of literature.

The key to the situation is a list of all scientific prints as they appear. We have a "Monthly Catalogue of all Government Publications," but it costs \$5.00 per annum. You can perhaps consult that in a large public library. Some of the Bureaux print lists of their publications for gratuitous distribution. This is especially true of the Smithsonian Institution and Geological Survey, to whom application can be made. But so far as biological topics are concerned, with perhaps some other scientific titles, we will try to keep you posted, and will add the dealers' prices. All orders sent to our care will be handed to a responsible dealer, and we will guarantee our subscribers right treatment. We cannot take this trouble except for subscribers.

Librarians should give this subject their earnest attention. Scores of most valuable publications are lost to them simply because they are

not on the alert for them. Leidy's Rhizopods now sells for \$5 here and \$10 in London. Soon it will bring more. When first issued libraries should have obtained it free. The beautifully illustrated "Fishing Industries of the United States" cost over \$50,000, and would be put on the market by New York publishers at \$10 a volume. This could at first be bought for \$2.45, but the Government Printer's stock is about exhausted. Dealers ask \$4.50. A few public libraries have it. Others neither asked their Senators for it nor bought it at cost. Many do not to this day know that there is such a valuable work. Each Congressman had but a few copies, which were early exhausted.

If librarians would ascertain what valuable books and pamphlets are being issued and at once secure copies they would find their scientific collections greatly enriched and at very trivial cost. Our bibliographical lists will help them to hundreds of dollars' worth if they will promptly use the means above indicated. College professors who cannot obtain the publications for their private libraries should remember that the college libraries may succeed where they fail if the librarian's attention is promptly called to the matter.

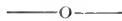

Professor Hitchcock at Home.—It is a pleasure to announce the safe return from Japan, after an absence of nearly three years, of the founder of this Journal. Prof. and Mrs. Hitchcock arrived in New York by the German line of steamers on January 12th, and came immediately to Washington, where they are at present making their arrangements for future work. Before leaving home he was the curator of Textile Fabrics in the United States National Museum, the director of which kindly granted him a furlough. On the way homeward he has paid some very satisfactory visits to the optical establishments in Germany and promises some contributions descriptive of what he saw there. In behalf of many friends whose names are still on our mailing list we welcome Prof. and Mrs. Hitchcock home again, and congratulate them upon having enjoyed what comes to but few of us—a trip around the world.

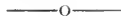

Kissing the Bible.—The lips are most sensitive to the reception of disease germs, and from the motley throng of dirty and diseased persons who appear in court and kiss the book, what infectious germs may not be obtained through this medium of distribution? It would be interesting for microscopists to examine such greasy and worn backs of court bibles as they can have access to and to report the kinds and amounts of bacteria found thereon.

Certainly it is a wise precaution to keep court bibles off the lips. Swearing with uplifted hand is not only safer, but more dignified.

In a Massachusetts school where scarlet fever and measles had prevailed some text-books fell into disuse, were put away for a time, and, when wanted, gotten out and re-distributed, several months having elapsed. In but a few days after the re-issue of the books the children began to come down with measles. There can be little doubt that scarlet fever is transmitted in the same way.

c. w. s.

MICROSCOPICAL SOCIETIES.

SAN FRANCISCO MICROSCOPICAL SOCIETY.

Wednesday, Oct. 24, 1888.—The subject of anthrax in meat, which is at present receiving much attention from the California Board of Health, provided a subject for deliberation and research among the microscopists. A section of cow's liver containing a large number of anthrax bacilli was presented by Dr. Stallard. Though not very distinct, the germs were easily discernible, and were by no means calculated to increase the observer's appetite for liver puddings.

Mr. Norris exhibited one of Bourgoyne's slides, containing a specimen of diatomaceous earth, found some years ago by an officer of the Coast Signal Service on the beach at Santa Monica. The specimen is especially interesting, as one like it has never yet been found. Some of the members thought that it had been washed from the shores of Santa Catalina Island, while others inclined to the opinion that it had come from the bottom of the sea, though how it could have detached itself from the parent mass and risen to the surface of the water was apparently a rather knotty question.

Among those present at the meeting was Dr. Thomas Porter, of Australia, who presented the society with a fine collection of Australian protozoa, for which he received a unanimous vote of thanks.

—o—

ESSEX COUNTY, N. J.—F. VANDERPOEL, *Secy.*

Dec. 6, 1888.—Met at the office of Dr. Brown in Montclair. The subject announced was a discussion of Mr. Carter's paper, but there was really a continuation of his paper. Mr. Carter had a number of fine forms of desmids which were examined through the tube by all present. Mr. C. H. Loomis also exhibited a number of mounted specimens. The desmids exhibited by Mr. Carter were mounted in carbolized water. *Euastrum* was observed through a $\frac{1}{5}$ " objective of 85° and later through another ($\frac{1}{5}$ ") of 125, both being used with the binocular with very good stereoscopic effect. By his homogenous immersion $\frac{1}{5}$ " and the double tube a good stereoscopic effect was obtained even with this high magnification. Other forms exhibited were: *Xanthidium*, *Penium digitus*, *Closterium intermedium*, *Closterium acuminatum*, *Cosmarium botrytis*.

One of Zeiss' high-class stands was exhibited with a number of accessories, and was critically examined. Opinions varied with regard to its appearance, working qualities, etc., but it certainly did not compare as favorably with the stands made in this country as one might think who had read the late attacks upon American stands.

December 20, 1888.—This evening was devoted to the comparison of objectives in the possession of the different members. Mr. Carter opened the tests by resolving the markings on *Amphipectra pellucida* (in Smith's medium) with his hom. imm. $\frac{1}{8}$ ", the illumination being obtained through an Abbé condenser provided with a diaphragm, the opening of which was quite small, and placed at the extreme left of the centre. The resolution was very fine. A Tolles amplifier did not improve it; in fact, the latter seemed to operate disadvantageously.

Mr. J. Lee Smith showed one of the same diatoms (in balsam) upon

his large Powell and Lealand stand. The objective was a hom. imm. $\frac{1}{8}$ " the companion lens to Mr. Carter's, and the illumination was by means of a Wenham Reflex. The test in balsam being much more difficult than that in Smith's medium, the details of form and markings were not seen with the same clearness, but the result was highly satisfactory and was probably as fine as could be accomplished with that particular diatom. Dr. G. S. Allan exhibited a *Podura* scale with his Apochromatic $\frac{1}{12}$ " and satisfied the Society that for central light at least this glass has, as yet, no equal. A comparison was then made between this lens and a fine Water imm. $\frac{1}{16}$ " upon the same scale, showing the superiority of the former in the matter of achromatism. Dr. Allan had also a dry $\frac{1}{8}$ " of Powell and Lealand's make. One characteristic of this glass is a long working distance. It turned out to be a very valuable objective, as was proven by trying it upon some histological slides.

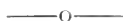

MICROSCOPICAL SOCIETY, WASHINGTON, D. C.

82d Meeting, Tuesday, Oct. 23, 1888.—Dr. Taylor exhibited a large number of photographs of microscopical objects, the most of them by Dr. G. W. Rafter, of Rochester, N. Y. He also spoke of his examination of spices with reference to adulteration. Beautifully drawn and colored sections were shown. As in pepper the cellular structure varies, many sections should be made. Sulphuric acid will bring out the oil cells. He also made sections of cloves. The principal adulterants of pepper are ground cocoa, nut-shells, and ground olive stones. White pepper is more adulterated than black.

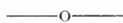

83d Meeting, Nov. 13, 1888.—Mr. Chapman reported experiments with crystallized carbolic acid. Having poured some water on it, then poured off the water and added 95% alcohol, then poured this off and added water to the remainder of the acid, the two aqueous solutions had become discolored while the alcoholic solution remained clear. He found that insects clear up well in the alcoholic solution. Dr. Taylor said that his experience had been that alcohol and carbolic acid contracted the limbs of insects, but the addition of chloroform would relax them.

Dr. Taylor read a paper on a freezing microtome invented by him. It will be printed in full in the microscopical journals.

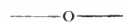

LEAVENWORTH.—W. D. BIDWELL, Secy.

Jan. 7, 1889.—A regular meeting was held at Dr. Bidwell's office. The subject was the optical principles involved in determining angular aperture, and the value of a large angular aperture. Prof. Lighton exhibited a diagram showing the points under discussion very lucidly. He also spoke of some experiments he is making to obtain a material which will supplant the Nickels prism, the idea occurring to him as a slide of selenite mounted in styrax lay upon his hand in the sunlight.

Dr. Bidwell described and showed the advantages of his new cabinet for slides. Drs. Van Eman and Carpenter discussed some of the difficulties of section cutting.

NOTICES OF BOOKS.

Proceedings of the American Society of Microscopists. Tenth Annual Meeting held at Pittsburgh, Pa., Aug. 30-Sept. 2, 1887. 8°, pp. 359. Peoria, 1888.

No single volume published in this country contains a greater amount of matter designed to show the progress which microscopy is making year by year than these proceedings. The committee, Messrs. Burrill, Kellicott, and Mosgrove, have published the volume in an entirely satisfactory manner, if the unavoidable delay be pardoned. Most of those who receive the book will forget to thank this committee as they deserve for doing gratuitously a job worth from \$500 to \$1000. As to the contents of the papers, which are mostly very valuable, we will refer the reader to our Bibliography where all the titles are cited. Those desiring copies should address Dr. S. M. Mosgrove, the treasurer, Urbana, Ohio.

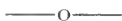

Proceedings of the American Society of Microscopists. Eleventh Annual Meeting held at Columbus, Ohio, August 21-24, 1888. 8°, pp. 204. Hartford, 1889.

Our remarks upon the 1887 volume apply also to this, except that we wish to commend more highly the prompt publication. The volume is smaller, contains some papers read at the meeting only by titles, the constitution, list of members, and an index. Dr. Lewis seems to have had quite an influence in getting out this volume in fine style, as well as promptly.

BIBLIOGRAPHY—RECENT WRITINGS OF INTEREST.

[This list will report books and articles of interest to microscopists and biologists. It will enable specialists to find literature of real value to them which space does not permit to be noticed more at length. It is prepared solely in the interest of readers and not of advertisers. But in ordering from publishers, always cite this page and date for convenience of identification. Requests from subscribers will be entertained, in special cases, for fuller information than is here given.]

I.—IN PROCEEDINGS OF THE AMERICAN SOCIETY OF MICROSCOPISTS, 1887.

BURRILL, T. J.—Disease Germs: Another illustration of the fact that bacteria causes disease. pp. 193-206.

BURRILL, T. J.—The Erysipheæ of Illinois. (List of species given. Illustrated.) pp. 301-10.

DETMERS, FRED A.—The Comparative Size of Blood Corpuscles of Man and Domestic Animals. (Large plate, tables of measurements, etc.) pp. 216-32.

EWELL, M. D.—Comparison of Centimeter Scale "Fasoldt II" with Centimeter Scale "A." pp. 299-300.

FELLOWS, CHARLES S.—A Description of *Ergasilus Chautauquaensis*: A new species of Copepoda and a list of other Entamostraca found at Lake Chautauqua, in August, 1886. (Illustrated.) pp. 246-9.

FRANCIS, MARK.—The Bacillus of Foot-Rot in Sheep. pp. 209-13.

GAGE, SIMON H.—Microscopical Tube Length and the parts included in it by various opticians of the world. II. The thickness of cover-glass for which unadjustable objectives are corrected. pp. 168-172.

GAGE, SIMON H.—Determination of the Number of Trichinæ or other Animal Parasites in a given Quantity of Meat. pp. 191-2.

GAGE, SUSANNA S. PHELPS.—Ending and Relation of the Muscular Fibers in

the Muscles of Minute Animals (Mouse, Mole, Bat, and English Sparrow). Abstract. pp. 207-8.

HENRICI, JACOB F.—Note on a Microscope presented by Linnæus to Bernard Jussieu in 1738. (Illustrated.) pp. 214-15.

JAMES, FRANK L.—Shrinkage of Cement-Cells the Cause of Leakage and Creeping in glycerine Mounts. pp. 173-180.

KELLCOTT, D. S.—Additional Notes on a Certain Species of Rotifera. pp. 181-86.

KELLCOTT, D. S.—Some New and Rare Infusoria. pp. 187-190.

LEWIS, GEORGE W.—The Fallacies of Popular Bacterial Research. pp. 254-62.

OVIATT, BORDMAN L.—Cardiac Muscle Cells in Man and certain other Mammals. (Illustrated.) pp. 283-98.

RAFTER, GEORGE W.—On the Use of the Amplifier, with Observations on the Theory and Practice of Photo-Micrography, suggested by the Design of a New Photo-Micro-Camera. (Illustrated.) pp. 263-82.

ROGERS, WM. A.—The Microscope as a Factor in the Study of the Behavior of Metals under Variations of Temperature. (The presidential address.) pp. 5-125.

SMITH, HAMILTON L.—A contribution to the Life History of the Diatomaceæ. Part II. (Six colored plates and several figures. Important paper.) pp. 126-167.

STEDMAN, J. M.—The Tape-Worm: Methods of Preparation for the Museum and the Microscope. pp. 242-5.

TAYLOR, THOMAS.—The Crystallography of Butter and other Fats. (Illustrated. Same as published in this Journal in 1887.) pp. 315-17.

VOICE, C. M.—Note on a new Rotifer—*Gomphogaster Areolatus*. (Illustrated.) pp. 250-3.

WARD, R. H.—On a Microscopical Slide-Catalogue. pp. 233-41.

WARD, R. H.—Note on Microscopical Exhibitions. pp. 311-314.

II.—IN PROCEEDINGS OF THE AMERICAN SOCIETY OF MICROSCOPISTS, 1888.

BURRILL, T. J.—The Ustilagineæ, or Smuts; with a list of Illinois Species. pp. 45-57.

DETMERS, H. J.—American and European Microscopes. pp. 149-154.

DETMERS, H. J.—Photographing with High Power by Lamp-light. (1 figure) pp. 143-8.

GAGE, S. H.—The Form and Size of the Red Blood-Corpuscles of the Adult and Larval Lamprey Eels of Cayuga Lake (with bibliography and illustrations). pp. 77-83.

GRIFFITH, E. H.—A new Fine Adjustment. (Illustrated.) pp. 161-2.

HENRICI, J. F., and MELLOR, C. C.—An Old Microscope of the Culpeper Type. (Illustrated.) pp. 140-2.

JACKSON, C. Q.—The Bacillus of Leprosy. A Microscopical Study of its Morphological Characteristics. (4 figures.) pp. 119-127.

KELLCOTT, D. S.—The Nature of Protozoa, and Lessons of these Simplest Animals. (Presidential address. See, also, this JOURNAL for September, 1888.) pp. 5-32.

KELLCOTT, D. S.—Partial List of Rotifera of Shiawassee River at Corunna, Michigan. (3 cuts.) pp. 84-96.

KELLCOTT, D. S.—Observations on Fresh-Water Infusoria. (5 figures.) pp. 97-106.

MCINTOSH, L. D.—A Microscope Attachment, for use with Solar or Artificial Light for Projecting or Photographing Microscopic Objects with Oblique Illumination or Projecting Opaque Objects. (Illustrated.) pp. 155-8.

PEARSON, LEONARD.—The Muscular Coats of the Œsophagus of the Domestic Animals (with Bibliography). pp. 128-139.

ROGERS, W. A.—On the Radiation of Heat between Metals, with Numerical Results for Brass and for Steel. pp. 33-44.

STEDMAN, JOHN M.—On the Development and a Supposed New Method of Reproduction in the Sun-Animalcule - *Actinospharium eichhornii*. (1 plate.) pp. 107-118.

STOWELL, T. B.—The Soft Palate in the Domestic Cat (with Bibliography). (Illustrated.) pp. 58-76.

TAYLOR, THOS.—A New Pocket Polariscopes. (Oleomargariscope.) (Illustrated.) pp. 158-9.





ZEISS MICROSCOPE STAND B, MEDIUM SIZE

THE AMERICAN MONTHLY MICROSCOPICAL JOURNAL.

VOL. X.

MARCH, 1889.

No. 3.

All communications for this Journal, whether relating to business or to editorial matters, and all books, pamphlets, exchanges, etc., should be addressed to American Monthly Microscopical Journal, Box 630, Washington, D. C.

European subscriptions may be sent directly to the above address accompanied by International Postal Order for \$1.15 per annum, or they may be sent to Messrs. Trübner & Co., 57 Ludgate Hill, London, or to Mr. W. P. Collins, 157 Great Portland street, London, accompanied by the yearly price of five shillings.

The Making of Apochromatics.

BY ROMYN HITCHCOCK.

Jena is situated about three hours by rail from Leipzig, but to get there one must change cars twice. We arrived there at 8 o'clock on the 13th of December, and were most cordially welcomed by Professor Dr. Abbe, whom we found awaiting us at the station. In a few minutes we were in very comfortable quarters at the Hotel zum schwarzen Bären, on Luther Place, where Luther was several times a guest. We visited many places of interest in the old town with Dr. and Mrs. Abbe, among others the houses once occupied by Schiller and Göthe. In the garden of the Schiller house, until lately Dr. Abbe's home, a stone slab marks the spot where stood a summer-house in which the poet wrote his *Wallenstein*, and near by a stone table over which he and Göthe enjoyed many a talk. The town has many old monuments of the past, but it has lost much of its former importance. It dates from the twelfth century. The University was founded in the time of the Reformation, and during the last century it had a large number of students. The average number now is about six hundred.

On Monday morning I went to Mr. Zeiss' establishment, and Dr. R. Zeiss, who succeeds his father in the business, conducted me through the works. Although some of the methods in use at this place differ from those employed elsewhere, and although the excellence and accuracy of the work is rendered possible only by the application of such methods, nothing is concealed from the visitor. As Dr. Zeiss says, they have no secrets. The brass work is done by machinery of the best kind, much of it specially made for the purpose, as, for instance, the ingenious device for cutting the diagonal rack-work for moving the body-tube. The rack is of brass, but the pinion wheel is steel. Brass polishing is done, as usual, with French emery, but I was much interested to learn that the dead black portions, such as the stages and other parts, are made black by grinding with emery powder. This may be the usual, or, at least, a very common method, but I have always been under the

impression that the brass was blackened by chemical methods. When the parts are put together they require to be adjusted by the most skilful workmen, and no stand is passed until it is as perfect as skill can make it. The machinery is run by two engines, of respectively 16 and 8-horse power.

By far the most interesting part of the work is the glass grinding. The glass is cut by means of a disk of metal revolving like a circular saw, the edge charged with diamond dust, and turning in a well of petroleum. It is astonishing to see how quickly a thick block of glass can be cut in this way. Even rock crystal does not seem to be very hard when put against the wheel. The glass being cut into slices of suitable thickness, the larger lenses are roughly rounded on a grindstone, and the curvature of the surfaces made to correspond with metal patterns or matrixes. Then follows more careful grinding by boys. Each boy sits at a table and grinds with a lathe and a brass matrix with emery, testing the curves as he goes on. Five grades of emery are used in this work. The final polish is given with rouge, in a matrix of pitch and shellac mixed together.* Every lens is inspected by an experienced foreman before it leaves the room.

Such, in brief, is the method of grinding all lenses, but for achromatics and for microscope objectives, more practiced workmen are employed and more rigid tests applied. Fraunhofer, many years ago, proposed the use of quartz patterns to test the curvature of telescope lenses, but this method was independently invented by a workman in the employ of Mr. Zeiss about the year 1860, and by him first applied in the grinding of microscope lenses. It is now used throughout the establishment for all achromatic lenses. Each workman has his quartz pattern, which he keeps under a glass shade on his table. As the polishing goes on he cleans off the rouge from time to time, and tries the lens in the pattern, being extremely careful lest the smallest particle of dust or grit should get between them. The lens must fit the pattern perfectly. If it does not, the workman can detect the error at once by the feeling, or by the appearance of the colored rings, known as Newton's rings, where the contact is not perfect. These quartz test-patterns have enabled the workmen to do the most perfect work—far more perfect than is possible by the old method of grinding—and it will be seen as we go on, that some such accurate method for testing is required in order to work strictly to the formulæ calculated by Dr. Abbe for each objective.

There is another feature of the grinding that is also of great importance, for, when the curves are right, it is also necessary that the lens should be of the exact thickness required. The workman has an instrument for accurately measuring the thickness of the lenses as he grinds them. This is quickly done, for the device is very simple. Each lens is finally measured and examined by the foreman of the grinding-room, and when the lenses leave his hands they are ready to be cemented together and put into the brass mountings.

In these operations we see the results of the perfect methods of grinding, for, although each single lens is ground by itself, when the different lenses of an objective are brought together, and once set in their mounting,

* There is a special polishing composition used for the finest glasses, which gives a more perfect polish than rouge.

the objective is perfect. The mounter has on his table, for example, the lenses of an apochromatic. The lenses of several apochromatics may be indiscriminately mixed before him, but as they are all ground exactly to measure, it is of no consequence which ones he puts together. He picks up the separate lenses, which have never before been brought together, puts on a drop of balsam, examines it with a hand-lens to see that there is no dust, then presses on the other lens, and the work is sure to be right. The lenses are then accurately set in their brass mounting. The distances between their surfaces are measured with

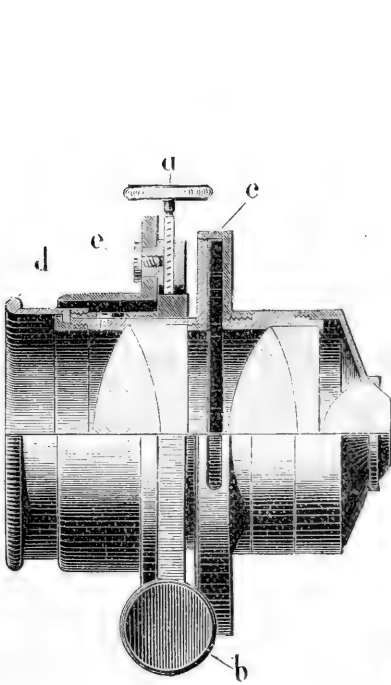

FIG. 1.—Zeiss Achromatic Condenser.

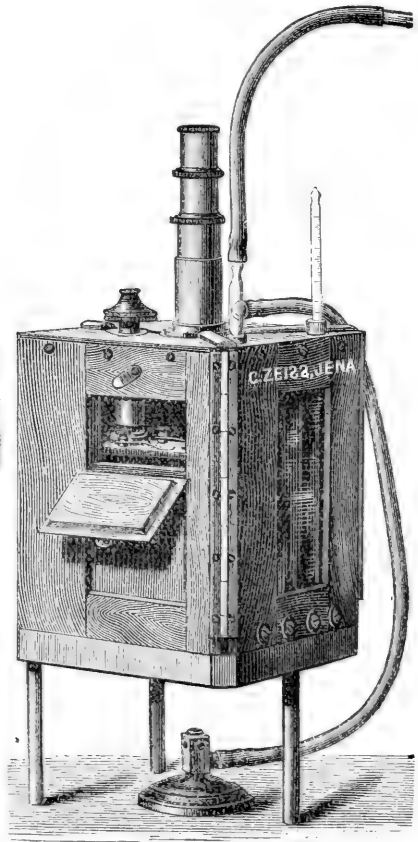

FIG. 2.—Zeiss Heating Oven

great care and made to conform exactly to the calculations. It is interesting to know that when the first apochromatic, a 3 mm., was put together it was perfect, proving that the calculations were right. The second was not perfect, but it was found that the workman had made a slight error in putting in the lenses. I believe he put one lens in wrong side up. When this error was corrected the objective was right. The instrument for measuring is graduated to 0.01 mm., but half of that can be estimated by the eye.

When we consider that an apochromatic objective consists of ten separately ground lenses; that the first lens being more than a hemisphere in form is consequently very difficult to grind; that each lens has to be ground strictly to measure in curvature and thickness; and that these lenses have all to be put together in a brass mounting so that their distances apart must be adjusted to within half a hundredth of a millimeter, and that when all this is done the objectives are as perfect as it is possible to make them, we may appreciate in some degree the value of mathematical formulæ coupled with the finest mathematical skill in perfecting the microscope.

There is another form of apochromatic objective which has only nine lenses and the front is not more than a hemisphere. This will be easier to make, but so far as I know it is not yet on the market.

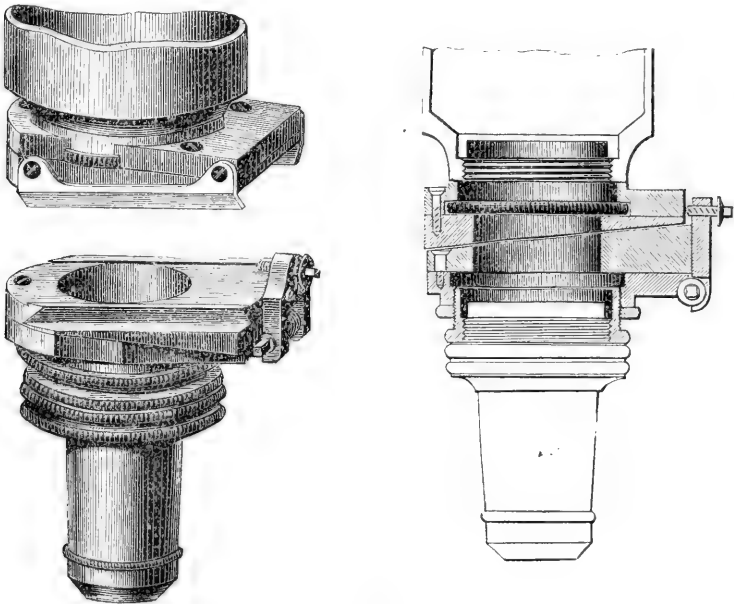

FIG. 3. — Zeiss Sliding Objective Changer.

The perfection of these new lenses is largely due to the use of the new glass, but I cannot now enter into a description of what is to be seen at the glass-works, nor refer more particularly to the uses of the new glass.

A few words concerning new apparatus may be of interest. The latest form of stand, which will be described in the new illustrated catalogue soon to be issued, is shown in the frontispiece. It is a compact and convenient stand, well made, carrying an Abbe condenser of the latest construction with iris diaphragm; price 290 marks.

An achromatic condenser which is especially recommended for photographing is shown in fig. 1. This condenser is constructed to give a sharp image of the source of light in the plane of the object, for projecting purposes. It has a numerical aperture of 1.0, iris diaphragm and centering adjustments.

Fig. 2 represents an arrangement for heating microscopic objects during observation, according to Pfeiffer's design. It will be seen that the microscope stage is within the apparatus, the body-tube projecting from the top. By this construction the temperature of the object is known to a certainty, as the object, stand and surrounding air are all at the same temperature, and can be maintained so for any length of time. A temperature of 40° C. may be maintained without injury to the stand or objective. This apparatus is made of two sizes, costing, respectively, 60 and 70 marks.

A new objective carrier and changing device is illustrated in fig. 3. Each objective can be accurately centered by means of an ordinary watch-key. As the objective slides in, on an inclined plane, the change can be made without danger of injuring the mounting of the specimen. The construction can readily be understood from the figures.

American and European Microscopes.

By H. J. DETMERS,

COLUMBUS, OHIO.

[The following, extracted from the Proceedings of the American Society of Microscopists, 1888, represents the substance of Dr. Detmers' remarks, and is republished here as a substitute for the report given on pages 137 and 138 of last year's JOURNAL, Dr. Zeiss having stated that that report was quite untrue, and Dr. Detmers having confirmed that statement.—EDITOR.]

At the meeting in Pittsburgh (1887) I had occasion to make some remarks concerning an examination of a new Zeiss apochromatic $\frac{1}{2}$ -inch homogeneous immersion objective, N. A. 1.40, and its workings with its compensating and projecting eye-pieces. I compared its performance by central and oblique light on test objects and on bacteria, etc., with that of some of our best American objectives, but particularly with a $\frac{1}{5}$ -inch homogeneous immersion objective of Tolles, N. A. 1.30. The conclusions arrived at I expressed in the following words: "I am convinced that the apochromatic objective examined in no way surpasses the best work (objectives) of our best American makers." This sentence evoked considerable discussion. I therefore offered to back my statement with facts; to photograph *Amphiptera pellucida* with oblique, and bacteria with central light, with American objectives and American accessories, and challenged my opponents to produce as good or better work with European apochromatic objectives, if they could. I made this offer because photo-micrography, it must be admitted, constitutes the crucial test for perfect achromatism, and hence for the very quality in which the new apochromatic objectives are claimed to be superior to all others. I have done what I promised, have made the photo-micrographs of *Amphiptera pellucida* and of several bacteria—amplification 1120 and 692 diameters, respectively—and hand them to the members of the Society for inspection.

Since the Pittsburgh meeting, I have made a trip to Germany, from whence I returned only last week. In Germany I visited three of the principal optical establishments of that country, namely, those of Ernst Leitz, in Wetzlar, of Seibert & Seibert, in Wetzlar, and of Dr. Carl Zeiss, in Jena. I stopped one day in Wetzlar and one day in Jena. The proprietors of all three establishments received me with great kind-

ness, and very courteously showed me their fine work. I had some test objects with me, some balsam-mounted *Amphipleuras* from Lake Nippersink and from Lake Pistakee, objects which my American homogeneous immersion objectives, a $\frac{1}{10}$ -inch Spencer, N. A. 1.38, and a $\frac{1}{15}$ -inch (in reality a $\frac{1}{16}$) Tolles, N. A. 1.30, will resolve with and without sub-stage accessories with comparative ease by lamp-light. These test objects I showed to Mr. Ernst Leitz, to Mr. Seibert, and to Dr. Roderick Zeiss. I also showed bromide prints and lantern slides (transparencies) of my photographs of *Amphipleura pellucida* (magnified 1120 and 692 diameters) and of *Bacillus anthracis*, *Bacillus tuberculosis*, Dr. Koch's Comma bacillus, my *Bacillus suis*, and several others (taken from the same negatives as those now in your hands for inspection), and all three opticians admitted that they were good, and that my photographs of *Amphipleura* were the best they had ever seen. Dr. Roderick Zeiss was kind enough to exchange some of his photographs of *Amphipleura* for mine, and as I have them here with me, I lay them before you that you may judge for yourselves. For further comparison I will also show you some photographs of *Amphipleura* made in Dr. Koch's laboratory, and one made by Dr. Neuhaus, an expert in photo-micrography. I only have to remark that mine have been made by lamp-light, and the others by sunlight, and with the aid of a heliostat. Dr. Zeiss's photographs have been made with his apochromatic $\frac{1}{12}$ -inch homogeneous immersion objectives, N. A. 1.30, his No. 2 projection eye-piece, a very ingenious, complicated, and costly camera, and an illuminating apparatus composed of an Abbe homogeneous immersion condenser, N. A. 1.40, and several condensing lenses. A light-filter was also used. In Dr. Koch's laboratory the same appliances are in use. My photographs, on the other hand, have been made in a very simple way. The appliances used by me consist of a Spencer $\frac{1}{16}$ -inch homogeneous immersion objective, N. A. 1.38, a common Huyghenian eye-piece (a No. 2 for the higher, and a No. 1 for the lower amplification), a Bulloch "Professional" microscope stand, a common Blair camera, a coal-oil lamp worth fifty cents, and a condensing apparatus composed of a medium-sized bull's-eye condenser, made by Bausch & Lomb, and an Abbe condenser, made by Bulloch. The frustules photographed by Dr. Zeiss, and in Dr. Koch's laboratory, were mounted in a medium of a refractive index of 2.40 (Stannic chloride), and those photographed by me in a medium of which I do not know the composition and the refractive index, but which probably is not higher than 2 or thereabout.

In at least one respect our first-class American homogeneous immersion objectives are preferable. They have collar correction, which is not found in any of the apochromatic homogeneous immersion objectives of German opticians. Our American objectives, therefore, are adapted to a larger range of work, and can be used with any tube-length, while the German apochromatics can not. Still, the latter, it seems to me, are not quite so sensitive to tube-length as is claimed. Further, the German apochromatic homogeneous immersion objectives are more expensive than our American objectives of corresponding quality. So, for instance, apochromatic homogeneous immersion objectives of Zeiss are offered in Jena—a $\frac{1}{8}$ -inch, N. A. 1.30, for 450 marks, or about \$110; a $\frac{1}{8}$ -inch, N. A. 1.40, for 550 marks, or about \$135; a $\frac{1}{12}$ -inch, N. A.

1.30, for 400 marks, or a little less than \$100; and a $\frac{1}{12}$ -inch, N. A. 1.40, for 500 marks, or almost \$125; while Bausch & Lomb Optical Co. and H. R. Spencer offer their homogeneous immersion objectives, N. A. 1.40 and 1.38, respectively, at from 40 to 80 per cent. less, as their catalogues will show.

[Referring to the reports of his address which appeared last September, Dr. Detmers says, in contradiction, that he did not take microscopes, objectives, or accessories to Europe; that he did not make a test of skill with the Germans; that he did not photograph objects in competition with them; and, in short, that no such fighting of objectives as was described occurred.]

Notes on the Substage Condenser, with Special Reference to that of Professor Abbe.

BY THE LOITERER IN A MICROSCOPIST'S LABORATORY.

This piece of illuminating apparatus is one of the most important and valuable that the microscopist can possess. It may be used to increase the illumination until the eye refuses to endure it, or the light by its means may be reduced to the faintest glimmer. With it the whole aperture of the objective may be filled by a solid cone of light, and by the use of the proper diaphragms or by moving the entire condenser laterally, illumination of the greatest obliquity may be obtained for the resolution of tests, or for the study of obscure structures of a certain character; and with the best of the modern substage condensers, black-ground illumination of the most exquisite beauty may be accomplished. The defining and resolving power of the objective are improved by its use. Indeed, the best high power homogeneous immersions will not do themselves entire justice without the use of the wide angled condensers now so common.

In what is called black-ground illumination the object appears to be self-luminous, gleaming with the vivid radiance of molten silver, seeming to rest softly on a back ground of the blackest velvet. Living animals appear like moving creatures fashioned from moonbeams; minute particles shimmer and flash like silver stars; a little heap of colored sand grains seems a little heap of rubies and diamonds from Sinbad the Sailor's Valley of Gems. And to obtain such exquisite pictures it is only necessary to obstruct the central beams of light by a circular opaque disk, allowing the object to be illuminated by the light that comes to it from the periphery. No rays reach the objective directly. All must first enter the object and there be properly refracted or inflected, or after passing through the object, they must be thrown back on it by reflection from the cover glass, so that under the beating of those waves of light it shall appear to glow with a soft intensity indescribable. This effect may be obtained, sometimes better and more easily, by substage apparatus especially intended for the purpose, rather than by any substage condenser.

The accessory just mentioned is a collection of two or three lenses forming an instrument somewhat similar to an objective. It is fitted to

the substage ring so that it may be accurately centred, which is essential to its best performance, and so that it may be moved upward to bring the light from the mirror to a focus on the object, or removed from the latter toward the mirror to reduce the intensity of the illumination. Some method, therefore, for changing its position vertically, either by rack and pinion or by direct finger movements, is absolutely essential.

It is always accompanied by diaphragms to reduce the size of the illuminating cone, to obtain light of great obliquity, or black-ground illumination. In the best condensers these are applied below the lenses, while in the cheaper and less desirable forms they are placed above the uppermost lens.

Low power objectives, those, for instance, up to the one-four or one-fifth inch, and those of small angular aperture, do not call for the use of the condenser. Sufficient illumination, generally more than is needed, may be had from the concave mirror alone. For small-angled lenses, if a condenser is desired, the one-inch objective, or an eye-piece of the proper construction, is useful. The objective, when used for this purpose, is screwed into an adapter fitting the substage ring with the front lens upward, the light being reflected from the plane mirror. If the Acme or other microscopical lamp be used, or if a bull's-eye condensing lens be interposed between the light and the mirror, the objective is then to be raised or lowered until the proper illumination is obtained. With this, however, only central light may be used.

Messrs. J. W. Queen and Co. make a simple and useful form, with an adapter for the substage ring, centring adjustments, and three diaphragms, which are placed above the lenses. The diaphragm with the smallest opening is used here, as elsewhere, for centring the condenser to the objective, the former being moved from side to side and forward or backward, while the eye is at the top of the body tube, the ocular having been removed. This small opening can be easily seen through the objective as a bright spot of light which must be brought accurately to the centre. For low powers where a larger field is to be illuminated with less intensity than with high powers, the upper lens of this condenser is removed, and the lower one focussed on the object in the usual way after the diaphragm with the largest opening has been applied. This is a commendable, inexpensive condenser for use with small angled, dry objectives, but for the best wide-angled objectives there are other forms better adapted to the purpose.

Several English and American opticians have produced substage condensers which are praiseworthy in some respects, but it was for Prof. Abbe to devise the best ever offered by any optician. This is the popular Abbe condenser, as supplied by Zeiss, of Jena, and so frequently referred to in microscopical literature.

The condenser as made by Zeiss for his own stands is very large and heavy, and is not intended to be used on those of any other maker. He says that since this is the case "adaptation to stands of other make, therefore, is nearly always impracticable and will not be undertaken." The contrivance is too useful, however, to be abandoned by English and American microscopists, so that the majority of our opticians make modified forms, which preserve the essential features and are adapted to American and English stands. Mr. Zentmayer, Mr. Grunow, Messrs. J. W. Queen & Co., and Messrs. Bausch & Lomb all offer

the device with minor points of difference from Prof. Abbe's and from each other's.

The condenser, as made by Mr. Zentmayer, is in two forms, one for use with objectives having a numerical aperture of not more than 1.20, the other for the widest angled glasses, itself having a numerical aperture of 1.40. The purchaser should, before final selection, consider which form he needs, his objectives deciding the question.

It is not achromatic. As to the desirability of seeking achromatism for it, microscopists differ. Mr. James Swift states that "the superiority of light from an achromatic condenser over that of any non-achromatic arrangement is due to the fact that rays, in their passage through a simple lens or combination of simple lenses, are decomposed into their elementary colors, which seriously impair the beauty of uncolored objects, such as the *Podura* scale, etc., whereas, in the achromatic condenser this defect is obviated, and all objects are seen with natural colors; moreover, confused pencils of light are produced by the spherical aberration of the single lenses which fogs the image of fine structure, whilst the achromatic condenser, being thoroughly corrected for spherical aberration, provides illumination of the greatest purity, and the most delicate objects are seen with a clearness and sharpness of detail quite unknown to those microscopists whose experience has been confined to the use of non-achromatic condensers." Prof. Abbe, however, says, "the condenser is not made achromatic for the reason that, for the effect contemplated, it would be altogether useless to seek to obtain a sharp image of the cloud or other source of light, as it is in like manner quite immaterial whether the image is formed precisely on a level with the object, or somewhat above or below it." Mr. E. M. Nelson also takes issue with Prof. Abbe's opinion. But no optician in America, so far as I am aware, has offered microscopists an achromatic wide-angled condenser. The only one made, I believe, is the oil-immersion of Messrs. Powell and Lealand, of London.

The modification of the Abbe condenser with 1.20 N. A. has but two component lenses, a large bi-convex posterior one, with surfaces of unequal curvature, and an anterior which is more than a hemisphere in form. The other, with 1.40 numerical aperture, consists of three lenses, the posterior being similar to that of the smaller angled form, while the middle lens is concavo-convex, and the anterior a smaller hemisphere.

When used with wide-angled objectives, to avoid loss of light and to obtain the best results, the space between the lower surface of the slide and the top of the condenser should be filled with water or homogeneous immersion fluid, and in all cases, except when oblique illumination is desired by a lateral movement of the condenser, it must be accurately centred. This is essential to its best performance. For ordinary purposes, however, with dry objectives it may be used dry.

Its focus is only a short distance below the object, or the upper surface of the slide. This distance varies with the aperture of the special form used, and is to be ascertained by experiment, but I think the condenser can seldom be employed when accurately focused, except, perhaps, while studying the striæ of diatoms with high power objectives and high power eye-pieces. With medium powers the exact focus of the condenser produces a little spot of light of terrible intensity. It is.

at least, my own custom with the form having 1.40 N. A., to use it out of focus, except on special occasions; what others may do I have no means of knowing. The thickness of the slide is, however, to be considered, particularly when using it as an immersion with wide angled glasses.

When employing low powers with central light or black-ground illumination, the concave mirror may be needed to illuminate the entire field; in other cases the plane mirror is always used, especially with the bull's-eye lens.

Several diaphragms, which are used below the posterior lens, for central, oblique and black-ground illumination, accompany both forms. Those for central light have a central opening, the size of the cone of light and the obliquity of its lateral rays varying with the size of the diaphragm opening employed. For oblique illumination usually two lune-shaped diaphragms are supplied. These are placed in the carrier, one at a time, of course, in any position that may be needed to produce the effects desired. For black-ground illumination those with the central disk supported by radiating arms are used, but to obtain the effect with wide-angled glasses something more is needed than the use of these special disks. A circular diaphragm must also be placed at the back of the objective.

The diaphragm carrier in the American forms of the condenser is usually a sliding plate into whose aperture the various diaphragms are placed, when it is pushed below the lenses until a spring catch indicates that it is properly centered to the condenser, but this has nothing to do with the centring of the condenser to the objective. The spring catch is usually a delicate one, and the microscopist is in danger of forcing the carrier beyond the centre.

The light may be readily modified by the use of the circular diaphragms, or, if the change is inconvenient, by lowering or raising the condenser.

For oblique illumination, the lunate disks are used, the larger when the greater portion of the cone of light is to be intercepted, the smaller when more of the rays nearer the centre are desired. With either sized concavity the condenser will give light of greater obliquity than many objectives will receive. The object, however, may be obliquely illuminated with rays from any direction, either by withdrawing the carrier and inserting the moon-shaped diaphragm in another position, or by rotating the entire condenser, so that the light shall sweep around a circular course. This requires delicate manipulation, an objective of the proper angular aperture to receive light of that obliquity, and very accurate centring of all the parts. It may be done, however, with fine effect in the resolution of lined objects, diatoms for instance, but if the microscopist owns the condenser of 1.40 numerical aperture, and this form of oblique light is to be employed, the front hemispherical lens of the condenser should be removed and the remainder of the combination focused on the object without any diaphragm. Then insert the lunate disk, and, if all is well, a glance down the body tube, without the ocular, will show a small double-convex spot of light near one border of the back lens of the objective, with the diffraction spectra also, if they are specially looked for, particularly if *Pleurosigma angulatum* be the object on the stage. With the condenser of 1.40 N. A., the front lens being removed, and the lunate diaphragm in the carrier, Mr. Gundlach's dry one-fifth inch objective, 135°, resolves balsam mounted

Pleurosigma into beads, bearing the half-inch solid eye-piece to perfection, and with this objective, under these conditions, the bright spot may be seen, when the eye-piece is removed, to sweep around the edge of the back lens like a drop of fire. To accomplish this with the condenser of 1.40 N. A., it and the objective must be in immersion contact with the slide, while the objective itself should be a wide-angled homogeneous immersion.

If the substage has lateral movements, as it has on some first-class stands, oblique illumination with the circular diaphragm openings may be obtained, but somewhat less effectually, by moving the entire condenser from side to side.

For black-ground illumination, the central disk diaphragm must be used, and with the one-inch objective brilliant effects may be produced, under this illumination, with the proper objects. To do this with the one-inch of 33° and the condenser of 1.40 N. A., it is necessary to remove the front lens of the condenser, when the effect will be exceedingly fine. Here again if the bull's-eye lens is placed between the mirror and the source of light, the plane mirror is to be used; if the light is taken directly from the lamp flame, the concave mirror is the proper one to be employed. Black-ground illumination may be obtained with powers of from five hundred to six hundred diameters, but according to my experience it is not praiseworthy. The field is not brilliant, the object does not glow with that peculiar and attractive silvery fire that seems to come from an internal source, but the picture is foggy with a bluish mist, and the silvery gleams are dull and lifeless.

With his form of the condenser, Dr. Zeiss supplies diaphragms to be applied to the back lens of the wide-angled objectives when black-ground illumination is desired with them. The proper disk-bearing plate is placed in the diaphragm carrier, and immersion contact is made with the lower surface of the slide. The difficulty with any but Zeiss's objectives is to prepare the diaphragms for the back lens. With his they may be made of metal, to properly fit when dropped into the mounting, and the opening will then be central. But if the microscopist must cut them from paper, he need not expect to obtain the best results. The directions are to drop diaphragms into the back of the wide-angled objectives, and then the microscopist is left, by all except Zeiss, to take care of himself. Yet it is, of course, impossible for any one optician to supply these little parts, since no two objectives of even the same magnifying power have the same sized mounting. The microscopist *must* depend upon himself, and he will speedily observe that when the aperture is reduced by a diaphragm at the back lens, the defining and resolving powers of the objective suffer an injurious diminution. The experiment is worth making though no other result than this be obtained.

While black-ground illumination is beautiful, it has little scientific value. I do not know that any discovery, or even any observation of importance, has ever been made by its use. It will at times exhibit certain structural features in a conspicuous way, but only, I think, after they have been previously observed, for in most cases this peculiar lighting appears to make the structure obscure. It may render the contour lines more distinct, and envelop the whole object in a glamour of brilliant beauty, but the microscopist, while he never disdains beauty, never makes it the object of his pursuit.

That the black-ground illumination obtainable by means of the Abbe condenser is not entirely satisfactory with high power, or wide-angled objectives, need give the prospective purchaser no uneasiness. The condenser is the best in existence, except perhaps the oil-immersion of Messrs. Powell and Lealand, of London. And all of the special adaptations made in this country are equally good. They do not differ in their optical portions, except so far as the aperture is concerned, but in the manner of introducing the diaphragms, which affects only the price of the appliance, and that in all the forms, seems unnecessarily high.

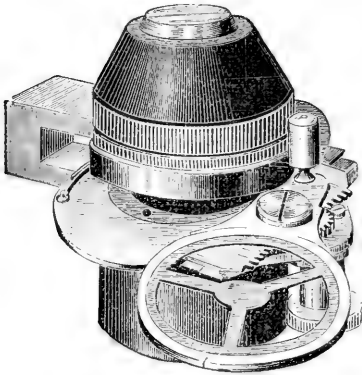

Zentmayer's Abbe Condenser.

Mr. Zentmayer's modification of the Abbe condenser is shown in the accompanying figure.

A Land Title Settled by The Microscope.

By W. D. BIDWELL, M. D.,

LEAVENWORTH, KANSAS.

Yesterday a microscope decided the title to 80 acres of land. There was verbal testimony on both sides of the case, but one party introduced in evidence some lead pencil memoranda alleged to be of different dates, but which his opponent claimed might have been prepared at the same time. The microscope showed that there was a decided difference in the marks on each paper,—the one being made on a soft or yielding surface, the other upon a hard and smooth surface; one mark was clear and square cut, the other irregular and uneven. An experiment made yesterday showed that marks made with the same pencil under similar circumstances to those existing when the memoranda were made produced results opposite to those present in the papers, thus making it extremely probable that the two were written with different pencils as well as at different dates. Then again, on one memorandum a figure 2 was made over a figure 0, and the close resemblance of the two marks in point of evenness and shading made it very probable that the "2" was made on the same day as the "0" as an after-thought, and was not a correction made some months later as suggested by opponent's counsel. Upon these appearances alone, confirming each other as they did, rested the decision in this case. Personally, I should not like to rest my title to property on so slight a basis; but other testimony being equally balanced, and these two appearances being confirmatory of each other and of the testimony of the witness offering them, the judge decided in his favor, and, as I think, rightly.

This case would probably not have come to me for an opinion but for a very interesting murder case a year ago in which I testified as to the character of certain stains on clothing.

The Philosophy of Mounting Objects.*

By FRANK L. JAMES, M. D.

In order that the student may understand the *rationale* of the processes through which an object must be carried in its transition from crude material to the finished slide, we will briefly describe the making of a supposititious mount. Suppose the object to be a pathological specimen, a tumor for instance, recently removed. It is plain that the direct examination of such an object can only be made with very low magnifying powers, such, for instance, as may be obtained by the use of a pocket magnifier or Coddington lens. In order to reach the histological elements we must use high powers, and these can only be used by transmitted light—that is, light sent through the object to be examined. We must therefore contrive a method by which the object, or a *representative portion* of it, may be made translucent. This may be done by taking a small portion of the material and mashing it out very thin between two pieces of glass. In former times this method was frequently resorted to, but as it could manifestly yield but very distorted results it has long since been abandoned by those who use the microscope as an instrument of precision. The other alternative at our disposal is the cutting of a section from the object with a very keen knife; and here we meet with another difficulty, viz., the object is (usually) too soft to offer such resistance to the passage of the blade as will enable us to cut a section of sufficient and uniform thinness. It is true that formerly such sections were cut with a Valentine's knife and which were supposed to be thin enough to yield practical results, but the device is now very rarely resorted to. The object must therefore be submitted to a process which will harden it and at the same time preserve it. If we are in a great hurry to arrive at results we may attain the desired end by freezing our object, but we will suppose that in the present instance resort is had to one of the hardening and preserving fluids. Having hardened the material our next step is to cut it into thin sections. Formerly this was accomplished by holding the hardened object in the hand and slicing off a section with a razor. This process is no longer used in exact and scientific work. Free-hand cutting has given place to the microtome or section cutter—just as in exact work free-hand drawing has yielded to photography. The object is therefore transferred to a section cutter to be sliced into sections, and as these sections must be made extremely thin and uniform, it must be securely held in the microtome. It must be arranged so that it can be fed to the knife and at the same time have no lost lateral motion. This necessitates embedding it in some liquid material that will harden around it and hold it firmly in place. This done, the section-knife is brought into play and the object is sliced to the requisite degree of thinness. Here we must digress a little in order to explain subsequent operations.

If we take any very thin substance—say a piece of paper—and place it under the microscope in a dry state, we will find on examination that we get a very insufficient idea of its intimate structure. If we moisten the object with water we find that many details of the structure are brought out and shown us which were invisible under the former examination. If, instead of water, we use glycerine or Canada balsam,

* From Elementary Microscopical Technology.

the structure is rendered still more distinct, and if the specimen be only thin enough the minutest detail is thus finally brought into view.

Let us suppose, further, that this bit of paper consists of two or three, or more kinds of fibres—say silk, cotton, and linen—all of the same color and so interwoven with each other that it is impossible for the eye to follow the ramifications of either material. It is plain that if we can find a dye or stain which will attack the cotton and not the silk or linen, or *vice versa*, or that stains cotton one shade or hue, silk another, and linen another, the problem of differentiating the elements which enter into the structure is a very simple one.

With these two hints as to the reason why the sections are put through the next two processes, and leaving the philosophy of the same, we will resume the progress of our slide toward completion.

The sections as they fall from the knife are received in a vessel filled with fluid—water, glycerine, or alcohol, according to circumstances, and when a sufficient number has been cut we pick out one of the thinnest and best and place it in the staining fluid, where we will leave it while we prepare the glass slip upon which it is to be mounted.

We take for this purpose a piece of clear glass 3 inches long and 1 inch wide, the edges of which have been ground and polished, and placing it on an instrument called a turn-table with a pencil dipped in cement (the nature of which depends upon the fluid which we shall use as a mounting medium), we spin a ring in the centre of it. This ring is large enough and deep enough to receive the object to be mounted, and should be allowed to get quite dry before the slip is used. The object, in the meantime, has been removed from the staining fluid and put through a number of little details to fix the stain, clear away the embedding material, etc., and is now soaking in the fluid which is to serve as a mounting medium, the functions of which are to render the object transparent and preserve it against decay. In this instance we will suppose that glycerine has been chosen as a medium. The ringed slip, thoroughly cleaned, is now placed on the mounting box (a frame with a glass top and provided with a mirror so arranged as to throw light upwards through the top and object laid on it) and a drop of pure glycerine is allowed to fall in the centre of the ring; the object is quickly transferred from the glycerine bath in which it has been laying, placed on the drop of glycerine already on the slip, and arranged in the position it is henceforth to occupy. Air bubbles are gotten rid of, the cover glass is applied and clamped in position; surplus glycerine is washed away and the slip and cover glass carefully and thoroughly dried with prepared blotting-paper. The clamp holding the cover glass in place is now removed and the slip transferred back to the turn-table, where a ring of cement is spun around the edges of the cover glass. This ring is allowed to dry, and the slip is again washed and carefully dried before a second layer of cement is applied. The final touches, which vary according to the taste, skill, etc., of operator, are then given to the slide; it is labelled, and, if the job is properly done, is good for an indefinite number of years.

Such, in brief, is the ordinary routine of processes usually employed in making a mount of a pathological or histological specimen of the soft tissues. There are many minor operations, matters of detail, entirely omitted or barely alluded to in the foregoing sketch, while many

of the manipulations there described are varied according to the nature of the mounting medium finally chosen; but an analysis of the processes enables us to divide them into three principal groups as follows, viz:

1. Those pertaining to the preparation of the material.
2. The preparation of the slide to receive the object.
3. The mounting of the object on the slide, including finishing.

Report upon the Postal Club Boxes—IV.

By QUEEN MAB.

Box V².—The itinerancy of the Postal Club slides tells severely upon their durability, as this box illustrates. It would be interesting to have with each box the date when placed in circulation, thus affording, to some extent, a test of the comparative durability of the various modes of preparation. It would seem that a far more desirable method of forming the reference collection of slides to be kept at headquarters, which the Club Managers have for some time contemplated, than by the accumulation of such slides as have survived the vicissitudes of mail transportation to be retired from the circuits, would be to procure from experienced preparers their perfect work. Such, in their respective specialties, they would no doubt willingly contribute for this purpose. Box V², is contributed from Jamestown, N. Y., and represents six contributors and three preparers.

Slide No. 1, prepared by Dr. A. Waterman, shows transverse section of leaves of four species of Pine,—bleached, stained with aniline green, and mounted in glycerine jelly. These sections show (1) fibro-vascular patch of matter in centre, (2) Mesophyll surrounding this tissue, with a number of openings (resin ducts) in it, (3) Narrow cortical area," and the accompanying note-book contains photo-micrographs of the slides,—an excellent idea, and one worthy of more frequent imitation. Slides 2, 3, 5, and 6 are prepared by S. Winsor Baker, and are, respectively, Stained Pinnule of Fern, Diatoms from Mobile Bay, Transverse Section of Skin of Banana, Striated Muscle from Leg of *Dytiscus*. This last is stained with carmine and mounted in glycerine jelly,—a very interesting object to those not familiar with it. A critic suggests in the note-book that these are all common objects. The rapid improvement in microscopical methods should certainly spur members to do their best work and to offer only a choice selection.

One of the slides of this box is contributed by a lady who is not the preparer. Comparatively few preparations by ladies find their way into the Club boxes. We cannot too warmly urge upon the attention of ladies the fascination and instruction to be found in the use of the microscope, a branch of science for which nature has especially adapted them both mentally and manually. If, as some would have us believe, the limit of perfection in the construction of the microscope has been reached, the field for its use is absolutely illimitable, and though but few will make brilliant, or even important, discoveries in microscopical science, a general advance all along the line will result from the multitude of workers. That more ladies devote their surplus leisure and brain power to the faithful, persistent use of the microscope is our earnest wish.

Box F comes from New Britain, Conn., and vicinity, is evidently not yet a veteran in the Club service, and represents the work of five preparers.

Slide No. 1 is a remarkably clean specimen of head of Wasp, by Dr. I. F. Stidham. Nos. 2 and 6 are the work of Mr. M. S. Wiard, and bear testimony alike to the skill of the preparer and the excellence of the cement used. The slides are: five species of pollen, unstained, mounted in castor oil on one slide, and Young of Horse-shoe Crab, *Limulus polyphemus*, stained with carmine and mounted in balsam. The cements used are those so well known of Rev. J. D. King. No. 3, by Chas. N. Burgess, picROTOXIN crystals, a bitter intoxicating poison sometimes used as a narcotic in medicine, from the seeds of the climbing plant *Cocculus Indicus*. No. 4, Skin of Sole, opaque, by J. R. Stoddard. No. 5, by H. C. Deane, Section of Human Bronchial Tube, stained with hæmatoxylin, and mounted in balsam.

Box 45. This extra box of diatom slides was prepared and contributed by M. A. Booth, of Longmeadow, Mass. The diatoms are from the following localities: Anjino, Russia, newly discovered and differing somewhat from the famous Simbirsk deposit; Brunn, Bohemia; Moron, Spain; Szent Peters, Hungary; Pudasjocai, Finland; and Bay of Bengal. The special point of interest for which these slides are contributed is their rarity. All, save that from Bay of Bengal, are fossil. These forms from Bay of Bengal are so peculiar that it would be hard to convince the novice, accustomed to the regular outline of diatoms, that these are really members of the diatom family, but the fact that besides the usual treatment they have been exposed to a glowing heat until all the organic matter has been burned out indisputably proves their silicious nature. They consist largely of species of *Chaetoceros* and *Bacteriastrum* (figured on Nos. 50 and 51 of the Greville Plates). Carpenter on page 353 says, of *Bacteriastrum*, "there are sometimes as many as 12 of these awns radiating from each frustule like the spokes of a wheel, in some instances regularly bifurcating."

A caution is uttered in the note-book which accompanies this box as to the too common careless handling of slides by piling them upon each other, a usage which no slide capable of injury can bear unharmed. An expression of the experience of the members of the Club with regard to dry mounts is sought (the Bay of Bengal slide being a dry mount), and the opinion of Mr. A. C. Cole, as set forth in his "Studies in Microscopical Science," vol. ii, is quoted: "All dry mounts of diatoms, whether strewed or selected, are liable to destruction or deterioration from an accumulation of moisture upon the under side of the cover, which moisture, sooner or later, and in defiance of all precautions, always makes its appearance. Dry mounts are therefore always more or less unsatisfactory and unreliable and to be avoided as much as possible. The best method of mounting diatoms dry, whether for test or as arranged slides, is to make a cell of the *best* asphalt."

It is possible that climate may exert an important influence on the reliability of a cement. Obviously in this country our climate or our asphalt is at fault.

W. C. Walker, F. R. M. S., of Utica, N. Y., gave an illustrated lecture on the microscope in that city January 16th, under the auspices of St. Andrew's Brotherhood.

Microscopical Laboratory Notes.

BY PROF. H. M. WHELPLEY,

ST. LOUIS, MO.

Read before the St. Louis Club of Microscopists at the January meeting.

Cold Weather.—Do not permit the mounts to be reduced to the freezing temperature. Even those preparations in liquids that do not congeal at 32° F. will be injured by sudden or great changes in temperature.

Benzol is not Benzin, and microscopists should remember it, even if some wholesale druggists do endeavor to sell benzin for benzol. I have seen work spoiled and time and patience lost by those who tried to use benzin for benzol.

Handling Thin Animal Sections.—Those who are accustomed to handling vegetable sections must remember when they come to work with animal specimens that the latter are much more liable to break or tear than vegetable sections. If this is not borne in mind valuable specimens will be ruined while handling them.

Another Use for Benzol.—This liquid is a great solvent of oils and grease. It will clean off the old grease that has been used to lubricate a joint, and leave the surface bright and clean for a fresh application of the lubricant. Benzol is very convenient for cleaning the spindle to a turn-table when the table does not run smoothly.

Spoiled Mounts are of no value, but the slides and cover glasses are. When a mount spoils beyond repair place it in a wide-mouthed bottle containing equal parts of alcohol, oil of turpentine, coal oil and benzol. After a few days' maceration in this liquid, the slides and cover glasses may be wiped clean, and are then just as good as new.

Cover Glasses, as sold now a days, are quite clean. I wash them in distilled water and keep them in a wide-mouthed bottle filled with alcohol acidulated with hydrochloric acid. They are readily cleaned with tissue or Japanese napkin paper between the thumb and forefinger. The patent devices for cleaning cover glasses are only serviceable to make a show of those who use them.

Hair-pin Clips.—Those who make many balsam mounts at a time soon find that a number of clips are required to hold the cover glasses in position until the balsam hardens. The clips in the market cost from seventy-five cents per dozen upwards. I find it much cheaper and just as convenient to make my own clips from ordinary hair-pins, as proposed by Professor Wall. Such clips will cost about five cents per dozen.

To Handle Small Thin Sections.—A very convenient trowel for this purpose is made by inserting the head of a large needle in a pen-holder or other suitable handle; then filing the needle flat on two opposite sides and breaking off the point. Such an instrument does not take up as much fluid with a small specimen as the ordinary trowel does. It also has other advantages over the customary methods of handling small thin sections of either animal or vegetable tissue.

Glycerin Mounts that will Keep.—Glycerin is a very desirable mounting medium for many purposes, and has but one drawback, and that is its tendency to creep out of the cell. When mounting such substances as will admit of such a procedure, I overcome this difficulty by using less glycerin than is required to fill the cell. This should be placed

in the centre of the cell, so that a circle of air will surround it in the finished mount. A coating of cement can be run on the cover glass over the circle of air, so that it does not show, but gives the mount the appearance of one with the cell full of glycerin.

Notices of New Methods — VIII.

By GEORGE C. FREEBORN, M. D.

INSTRUCTOR IN NORMAL HISTOLOGY, COLLEGE OF PHYSICIANS AND SURGEONS, NEW YORK.

Carmine Stains for Nerve Tissue.—Upson, H. S.—*Neurol. Centralbl.*, vii, 1888, p. 391.

I. One gramme of carmine is boiled for 20 minutes with 100 c.c. of a 5% solution of alum; this solution is allowed to cool and is then filtered. To 5 c.c. of this solution add 10 to 20 drops of hydric acetate, 1 to 2 drops of phosphomolybdic acid and filter. Stain sections in this fluid for 2 to 10 minutes, then wash well in water, dehydrate, clear and mount in balsam. Axis cylinders, ganglionic cells and connective tissue stain deeply; nuclei stain faintly.

II. To 5 c.c. of Grenacher's alum carmine add zinc sulphate to saturation and then filter. Stain sections in this fluid for one-half to twelve hours; then wash well in water, dehydrate, clear and mount in balsam. Axis cylinders, the medullary sheath and Schwann's sheath are sharply differentiated.

III. To a mixture of 4 c.c. of water and 1 c.c. of alcohol add 0.06 gm. of carminic acid. Stain sections in this fluid for 3 to 10 minutes, then wash in water and place in one of the decolorizing fluids given below. The sections are to remain in the decolorizing fluid for 1 minute, they are then removed, washed well in water and mounted in the usual manner in balsam. The tint of the section depends upon the decolorizing fluid used. Dilute hydric acetate gives a yellowish-red tint; saturated solution of lead acetate, blue; ferrous sulphate, black; manganese sulphate, red; nickel sulphate or barium chloride, violet. Axis cylinders, ganglionic cells and connective tissue are stained. Nuclei do not stain sharply.

Nucina, a New Stain for Histological Work.—Leon, *Zool. Anz.*, xi, 1888, p. 624.

The author employs a coloring matter extracted from the green walnut. It stains nuclei black; also bacteria. He prepares the stain in one of the following ways:

a. Aqueous Extract.—The green walnuts are placed in a vessel and covered with alcohol; when the alcohol has become green, from the dissolving out of the chlorophyll, they are removed and washed well in water. Twenty-five walnuts are then placed in a porcelain dish with 500 c.c. of water and boiled until the amount of water is reduced to one half. This extract is then filtered several times through paper and the filtrate boiled with 10% of alum. This fluid is used for staining. Its action is less active than the alcoholic but the staining is more sharp.

b. Alcoholic Extract.—After the green walnuts have been boiled for a long time in water, the fluid is allowed to stand, when the Nucina will be deposited. The water is poured off and 100 c.c. of 80% alcohol for each 3 gms. of nuclei are added. The color of this solution is black and is to be used for staining after adding a few drops of hydric chloride.

BIOLOGICAL NOTES.*

Is Hydrophobia a Disease?—In a paper recently read before the Medical Society of the State of Pennsylvania, Dr. Charles W. Dulles presents what he considers abundant proof that hydrophobia is not a specific disease that can be communicated by the bite of an animal, but rather a physical condition, and that the word should be used to describe this physical condition in the same way that the word convulsions is used. In substantiation of this he maintains that hydrophobia is practically unknown except where a superstitious fear of it is common; that in most cases there is no evidence that the animal which did the biting was rabid, and that the tests for hydrophobia, which have not generally been sufficiently accurate to be of any scientific value, have in many cases been so applied as to aid in producing the symptoms usually expected to make their appearance. He maintains that Pasteur's methods of treatment have had no effect in reducing the mortality from so-called hydrophobia in Paris, but that the number of deaths in 1887 was greater than in 1880, 1883, 1884, or 1886. He claims also that the interest in Pasteur's methods of treatment has greatly decreased, and urges that the banishment of the superstitious fear of hydrophobia will render it a thing unknown. On the other hand, the report of the Pasteur Institute held in Paris Nov. 14th, as given by the New York Medical Record, shows that the rate of mortality for the year 1886 was 1.24 per cent. of those treated; for 1887, 1.12 per cent.; and for 1888, 0.77 per cent., while the estimated mortality previous to the introduction of inoculation for rabies in 1885 was 15.90 per cent. This would go to show that much has been accomplished toward decreasing the number of deaths from hydrophobia, whether we are to consider it as a specific disease or not.

Respiration of a Fish by the Caudal Fin.—Mr. Alfred C. Haddon in a letter to *Nature* (vol. xxxix, p. 285) reports that he covered the caudal fin of a species of *Periophthalmus* with gold size and the fish lived on an average only twelve to eighteen hours, although the gills were in a normal condition. If the fish were placed in sea water so that the tail was completely covered but the gills left exposed, it lived a day and a half. The microscopic examination of the caudal fin showed that the circulation of the blood was very vigorous in it. The fish is in a habit of resting with its tail immersed in water when the rest of the body is out of the water.

Consumption.—It is now not quite seven years since Dr. Koch announced to the Physiological Society of Berlin the result of his investigations upon the causes of consumption and his discovery of the universal presence of a particular microbe, which he named *Bacillus tuberculosis*, in the diseased organs of both men and lower animals who were suffering from the disease called tuberculosis or tuberculous consumption, and yet the acceptance of the theory that this organism is the cause of the disease has become so general that it must soon be practically universal. With this acceptance of the conclusions of Dr. Koch has gone a rapid progress in our knowledge of the circumstances that tend to propagate it, and the extent to which the most important domestic animals are susceptible to the disease, and may therefore be

* This department is conducted by Prof. J. H. Pillsbury.

the means of spreading it. That the disease is contagious there can be little doubt, and that certain conditions of the general health and hereditary physical weakness are likely to render the introduction of the germs of the disease more probable is equally well established. Prof. C. H. Fernald has recently published, in Bulletin No. 3 of the Hatch Experiment Station of Massachusetts Agricultural College, an interesting account of the growth of our knowledge of the disease and many important points bearing upon its prevalence among domestic animals. Dr. C. V. Chapin, of Providence, R. I., has published an essay upon the relation of the germ theory to the prevention and treatment of consumption. Dr. Chapin admits that little advantage has yet been taken of the rapid progress that has been made in our knowledge of the cause of the disease, but hopes for better results and urges physicians to educate the public to a higher appreciation of the large extent to which the disease may be controlled by proper care. Considering the still too large class of practitioners who do not yet heartily accept the idea that consumption is a contagious germ disease the hope of this being accomplished at an early day is very small. It is certainly high time that this discovery of biology should be made familiar to the intelligent citizen in order that such measures as may be available may be taken to lessen the enormous number of victims which annually fall beneath the stroke of this grim destroyer. A few of the well-established facts relating to the subject can be easily promulgated, and thereby thousands saved from untimely death. These are among the most important:

1. Tuberculosis in man and domestic animals is caused by a minute organism called *Bacillus tuberculosis*.

2. The bacillus may be transmitted from animal to animal by many means, so that whole herds are liable to become infected when once it enters. Cattle, swine, hens, rabbits, and guinea-pigs are very susceptible to the disease. Prof. Fernald reports a diseased chicken sent to him for examination as completely infected with tuberculosis.

3. The bacillus may be transmitted to man through the flesh of infected animals used as food, the milk of diseased cows, and probably through the eggs of diseased fowls. Hence, public safety demands that more stringent measures be adopted for the suppression of every manifestation of the disease by the destruction of all infected animals, even if it be at a considerable pecuniary loss. Long continued heating to the boiling point probably destroys the vitality of the bacillus, but it is not certain that the spores are thus destroyed.

4. The bacillus may be transmitted from persons suffering with the disease by the air of the sick room, by handkerchiefs used by them, or by exposed sputum which is usually laden with germs. All sputum should be treated with a solution of bichloride of mercury, the most powerful germicide known, and cloths used in place of handkerchiefs should be burned; or if handkerchiefs are used they should be soaked in the bichloride solution.

5. The bacillus seems not able to establish itself in persons who are in vigorous health. Hence the need of great care of the general health, especially when there is any danger from exposure to the disease. Plenty of exercise, abundant and wholesome food, and pure air taken by deep and full respiration are doubtless the best safeguards against contracting the disease.

MEDICAL MICROSCOPY.*

The Menstrual Organ.—A most interesting paper with this title and by Dr. A. W. Johnstone is published in the *Annals of Gynecology*, October, 1888. It gives some results of microscopic study of the endometrium, tending to the following conclusions: That the endometrium is a cytogenic organ analogous in function to the spleen, thymus gland, etc.; that the product of its cytogenesis is the placenta; that menstruation is the washing away of corpuscles too old to make a placenta, and that the reason why lower animals do not menstruate is because in them the uterine lymphatic net-work is much more abundant, and through these lymph canals the ripe but unused placental material is washed away into the general circulation.

—o—

Influence of Microbes.—In a paper read before the Virginia Medical Society Dr. W. E. McGuire enumerates ways in which the baneful influence of microbes upon living organisms may be explained: (1) As cell-food destroyers; (2) As obstructionists interfering with the action of excreting organs; (3) By leaving poisonous excretions; (4) By tissue-deoxygenization wherefrom ptomaines result.

—o—

Trachoma.—Dr Kükarsky, of Tiflis, has been studying the bacteriology of trachoma. He formulates the differential, morphological, and biological characteristics of the microbes which he invariably found in trachomatous follicles; but the results of inoculative experiments upon rabbits, cats, dogs, pigeons, and men, either with pure cultures or with the fluids from diseased eyes, were inconclusive.—*Phil. Med. Times*, Dec. 15, '88.

—o—

Dying of Trichinosis.—It was discovered December 28, 1888, by examination with the *microscope*, that the mysterious disease with which Mr. Crumbaugh, of Leroy, has for a year been a sufferer, is trichinosis. He has suffered indescribable tortures since he was first attacked with the mysterious malady. He had no recollection of eating raw or imperfectly cooked pork. He died in January, 1889.

—o—

News.—“Pork affected with trichina when used for food produces the *Tænia solium*, or common tape-worm.”—*Bulletin Tenn. State Board of Health*.

—o—

A case of alcoholic multiple neuritis occurring at the Philadelphia Hospital was reported to the Philadelphia Neurological Society by Dr. J. H. Lloyd. The microscopical specimens from this case “became decomposed in some unaccountable way, and were unfit for microscopic study.” This may be worth noting by competitors for Dr. Mason’s prize.

*This department is conducted by F. Blanchard, M. D.

The Influence of Bacteria upon the Digestion of Children.*

Baginsky, in a paper before the Berlin Medical Society, states that the bacterium of the lactic fermentation causes the production of acetic acid and acetone, as well as lactic acid. This formation goes on without oxygen, and is not hindered by the bile.

The neutral lactates are changed to butyric acid; starch is not changed to sugar, nor is casein or albumin decomposed. The gases formed when acetic acid is produced are carbonic acid, hydrogen, and methane.

He proposes to name this bacterium the "acetic bacterium." He further found that this bacterium is destroyed by acetic acid.

In examining the stools of children suffering from cholera infantum, he isolated a bacterium which produced green stools (the germ of Hayem and Lesage), and also a bacterium growing in white colonies. Both of these liquefy gelatine, and both are inhibited in their development by the acetic bacterium; this germ has the property of preventing the growth of pathogenic germs in the intestine.

Baginsky considers that only the primary manifestations of cholera infantum are caused by bacteria, and that the secondary, severer phases result from the extensive anatomical lesions which have occurred in the intestine. It is evident that the treatment of a given case will depend upon the stage of the disease. He found that calomel, boric acid, and resorcin prevent the growth of the acetic bacteria; naphthaline and iodoform are inert. If the case is seen early, when acetic fermentation is excessive, these remedies and the withdrawal of milk are indicated. If pathogenic bacteria have accumulated in the stomach or intestines, irrigation with anti-septic fluids is advised. Each case must be studied separately, and interference with the conservative process, as shown in the inhibitory action of certain bacteria, should only be undertaken intelligently.

EDITORIAL.

International Competition in Microscopy.—This term does not well express what we wish to say, but will perhaps do for lack of a better. In the present number Prof. Hitchcock gives us an interesting account of work abroad upon microscopical apparatus, and Dr. Detmers tells of his excellent success with home-made apparatus. The former is perhaps one of the most appreciative writers upon German goods and the latter upon American. What we particularly want to say is that it is the business of this periodical to give all sides a hearing. But in so doing there is sometimes danger of writers getting antagonistic to each other and of their wishing to say sharp things. Before the occasion arises, therefore, we announce that while giving the utmost liberty to each to praise his favorite apparatus, no matter where made, we shall draw a firm line at the point where personalities might occur; and, if we know it, we shall not admit untrue or questionable statements even when authors do assume the responsibility. If such creep in, the gravity of the case will determine whether to correct the same. Whatever is said or not said must be with due regard to the rights and

**Berlin, Klinisch, Wochensh.*, No. 26, 1888; *Amer. Jour. Med. Sciences*, Oct. 1888

feelings of all our friends and correspondents at home and abroad. We want to do all we can to advance this science, but especially to promote friendship among the workers—to destroy rather than to awaken antagonisms.

Some of our German friends have felt annoyed by a brief quotation which occurred in this periodical last year and which was rather derogatory to their goods. We assure them that no injustice was intended, and if any occurred we are very sorry. Circumstances have been such, however, that we could not until now allude to it, and it is not wise to recall and to discuss it in detail. Let it pass, and the Germans or the friends of their goods shall have all the space they require in which to describe and praise their apparatus. Only let it be fraternal and for the promotion of the cause in general. Error easily dies a natural death. It is not necessary that we all stop in the pursuit of truth to take cudgels and pursue every little error that is born of inadvertence, of ignorance, or even of malice. Criticism is good and necessary, but in this critical age it often goes so far as to wound feelings unnecessarily. Why should not the critic temper his words with kindness and reserve them for great occasions? The microscopist should magnify the good but not the bad in life.

MICROSCOPICAL SOCIETIES.

THE IRON CITY MICROSCOPICAL SOCIETY.

Tuesday, January 8, 1889.—There was a full attendance and an interesting meeting. The most important exhibits were: Specimens of zoöphytes from deep-sea soundings in the southern Pacific, rare diatoms, and many pathological exhibits.

The paper of the evening, on *Demodex follicorum*, or the flesh-worm parasite in the human face, was by Dr. Chevalier Q. Jackson, and was illustrated by several photographs taken by Mr. W. S. Bell; also by several well prepared slides. Discussion followed.

Preparations are being made for the annual soiree.

SAN FRANCISCO, CAL.

Wednesday, January 9, 1889.—President Ferrer made his annual report, as he is about to leave for Europe. He said that the Society now counts thirty-three regular, eight honorary, and eight life members. Dr. F. Riehl read a paper on "Bacteriological Examination of Water." He exhibited specimens of surface water taken from a well situated near sewers, Spring Valley water, and Alameda well water. He found these so very full of bacteria that he concluded all were unfit to drink. Artesian water had proved to be the purest.

MANCHESTER MICROSCOPICAL SOCIETY, ENGLAND.

Thursday, January 10, 1889.—At this meeting Mr. Thomas E. Hoyle presented a paper on the construction and use of the micro-spectroscope.

January 17, 1889.—In the mounting section there were demonstrations: Mounting in glycerine by Mr. James Fleming, reflection and refraction by Mr. T. E. Hoyle, also a practical demonstration course

upon organs of digestion (tongue, teeth, salivary glands, œsophagus). For this each member attending brings microscope, $\frac{1}{2}$ " or $\frac{1}{4}$ " objectives, and a few slips and cover-glasses. (Fee for the session ending June, 1889, 2s. 6d.)

January 26, 1889.—Annual soiree and lecture. Subject: Electrical phenomena in animals. By Prof. W. Stirling, M. D., of Owens College. (Admission, 1s.)

January 31, 1889.—Annual election of officers. President, Prof. A. Milnes Marshall, M. D.; Vice-Presidents, Alex. Hay, E. W. Napper, and Thos. E. Hoyle; Hon. Treasurer, James Fleming; Hon. Secretary, Geo. Wilks; Hon. Librarian, E. C. Stump; a standing committee of ten members.

Thursday, February 7, 1889.—Program: Devitrification, by Percy F. Kendall, with lantern illuminations and polarized light, under direction of Wm. Leach. Distribution of specimens of dog-fish skin from Robert Thornton Brain, of Great Yarmouth. Conversazione.

Thursday, February 21, 1889.—Mounting section. This section has its own Chairman, Vice-Chairman, Hon. Secretary and Treasurer, and committee of seven members. Demonstrations: Dry mounting by Mr. A. Flatters; properties and arrangement of lenses by Mr. T. E. Hoyle. Practical demonstration course: Organs of digestion, continued (stomach, small intestines, large intestines).

Exchanges.

[Exchanges are inserted in this column without charge. They will be strictly limited to mounted objects, and material for mounting.]

OFFERED.—Diatomaceous earth from Thibet, various localities (12,000 feet); also, material and slides of diatoms from Scottish Highlands, and continental foraminifera. WANTED.—Slides of American diatoms, insects, or botany.

W. D. STEWART, 2 Gilmore Terrace, Edinburgh, Scotland.

OFFERED.—Sections of vegetable ivory and slides of crystalized maple sugar. Good mounts taken in exchange.

WM. LIGHTON, 106 Fifth Avenue, Leavenworth, Kansas.

WANTED.—Parasites and books on Parasites and other micro. subjects. Will give Anatomical, Pathological, Botanical, Micro-fungi, Zoophytes, Polycistina, Foraminifera, Parasites, and other slides in return.

FRED. LEE CARTER, Gosforth, near Newcastle-on-Tyne, England.

Wanted, Diatomaceous earth from Mègillanes, Bolivia, South America. Can give in exchange either Diatomaceous earth from New Zealand or cash.

E. MICHALEK, I. Fleischmarkt, No. 1, Vienna, Austria.

Mounted sections of Fœtal Lung (5 months), sections across entire lobe, $\frac{20}{1000}$ in. thick, beautifully stained, in exchange for first-class pathological slides.

W. C. BORDEN, M. D., U. S. A., Fort Douglas, Utah.

Wanted, earths, recent diatoms, and miscellaneous objects for mounting. Only first-class material offered or desired.

MARY A. BOOTH, Longmeadow, Mass.

Fossil Diatomaceous deposits (marine) wanted from Bermuda, Virginia, Maryland, California, etc.

I. ELLIOTT, Ardwyn Villa, Aberystwith, Wales, England.

Labels for slides.

EUGENE PINCKNEY, Dixon, Ill.

Correspondence relative to exchange in microscopical material or prepared mounts.

HENRY L. OSBORN, Hamline, Minn.

First-class Histological Slides for other good mounts: Histological and Pathological material cut on shares.

S. G. SHANKS, M. D., 547 Clinton Ave., Albany, N. Y.

FOR EXCHANGE.—Strichnia Chromate (Strichnia $\frac{23}{10}$ gr.) and Strichnia Ferri-Cyanide (Strichnia $\frac{10}{100}$ gr.) Will exchange for other slides, Botanical preferred.

L. A. HARDING, Fergus Falls, Minn.

FOR EXCHANGE.—Mounted slides of Gold Sand, Gold Washings, Wire Silver, Pyrites of Iron, Petrified Wood, etc., for Pathological slides and cut material or other desirable mounted specimens.

W. N. SHERMAN, M. D., Kingman, Ariz.

FOR EXCHANGE.—Diatomaceous earth from Richmond, Va., Nottingham, & Calvert Co., Md., Los Angeles and Santa Monica, Cal., for other diatomaceous material, crude or cleaned, recent or fossil (marine forms preferred), or for diatom or miscellaneous slides (only good mounts wanted).

F. W. DUNNING, 37 Garrison Ave., Battle Creek, Mich.

WANTED.—A set of Proceedings of the American Society of Microscopists. State price of set or of single volumes, kind of binding, etc. Also, any other microscopical periodicals.

P. O. BOX 630, Washington, D. C.

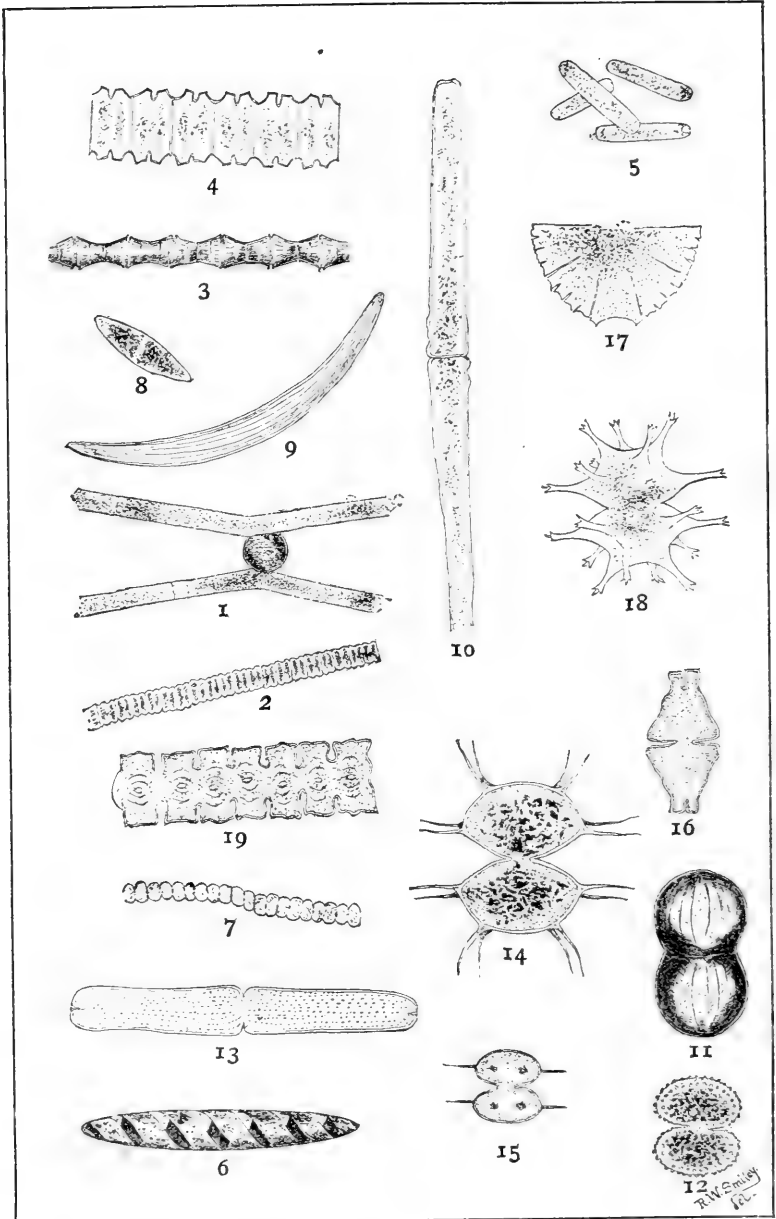

DESMIDS.

THE AMERICAN

MONTHLY

MICROSCOPICAL JOURNAL

VOL. X.

APRIL, 1889.

No. 4.

All communications for this Journal, whether relating to business or to editorial matters, and all books, pamphlets, exchanges, etc., should be addressed to American Monthly Microscopical Journal, Box 630, Washington, D. C.

European subscriptions may be sent directly to the above address accompanied by International Postal Order for \$1.15 per annum, or they may be sent to Messrs. Trübner & Co., 57 Ludgate Hill, London, or to Mr. W. P. Collins, 157 Great Portland street, London, accompanied by the yearly price of five shillings.

Desmids: Their Life History and Their Classification.—II.

BY REV. FRED'K B. CARTER,

MONTCLAIR, N. J.

(Continued from page 38.)

For a long time the desmids were held to be animals. Ehrenberg so considered them, and it is only within the last thirty years that the question has been definitely settled in regard to their vegetable nature. We separate, then, first the mineral and animal kingdoms and confine ourselves to that which lies between. Now this vegetable kingdom has two grand divisions, the Phanerogamia and the Cryptogamia, the flowering and the non-flowering plants; or more correctly, according to the latest definition, the plants which reproduce by seeds and those which are propagated by spores. The Cryptogamia again comprise two distinct sub-divisions, plants with woody matter and those without. The Horse-tails, Ferns, and Club-mosses belong to the first: the other mosses, Sea-weeds, Lichens, and Fungi belong to the second; and this is the section which concerns us. Mosses, Sea-weeds, Lichens, and Fungi, then, the four lowest classes of the lowest grand division of the vegetable kingdom—among these our favorites find their true place. Sea-weeds or algæ, that is the name of the class or group, and they are at the very bottom of the list, *the lowest of all green things upon the*

LIST OF FIGURES IN THE FRONTISPIECE.

- FIG. 1. *Gonatozygon asperum*. Filaments and zygospore.
 2. *Hyalotheca dissiliens*.
 3. *Bambusina brebissonii*.
 4. *Desmidiium swartzii*. Filaments in vegetative condition.
 5. *Mesotenum endlicherianum*. A group of four cells.
 6. *Spirotenia condensata*.
 7. *Sphaerosma filiforme*.
 8. *Pentium navicula*. A larger sized cell.
 9. *Closterium striolatum*.

- FIG. 10. *Docidium baculum*.
 11. *Calocylindrus pseudoconnatus*.
 12. *Cosmarium margaritifera*.
 13. *Tetmemoris brebissonii*. Longer form.
 14. *Xanthidium fasciculatum*.
 15. *Arthrodesmus fragile*. Front view.
 16. *Euastrum didelta*.
 17. *Micrasterias denticulata*. Semi cell of a smaller form.
 18. *Staurastrum arcticon*.
 19. *Phyatodocis nordstedtianum*.

All of these figures are copied from Wolle's Desmids of the United States.

earth, remember, nothing ranking below them but the Lichens and Fungi.

But the sea-weeds bear an unfortunate name, for many of them are fresh-water plants. Let us say *algæ* therefore, which, though meaning the same, does not strike the English ear so unpleasantly; and then we have salt-water *algæ* and fresh-water *algæ*, and among the latter we come upon the desmids. Remembering then that no desmids are ever found in salt-water, we can ignore that whole division and confine ourselves to the fresh-water plants.

The fresh-water *algæ* include some twenty families, viz: 1, *Lemnaceæ*; 2, *Porphyraceæ*; 3, *Batrachospermaceæ*; 4, *Hildibrandtiaceæ*; 5, *Coleochætaceæ*; 6, *Ædogoniaceæ*; 7, *Sphæropleaceæ*; 8, *Confervaceæ*; 9, *Pithophoraceæ*; 10, *Vaucheriaceæ*; 11, *Botrydiaceæ*; 12, *Volvocaceæ*; 13, *Protococcaceæ*; 14, *Palmellaceæ*; 15, *Chytridicæ*; 16, *Conjugatæ*; 17, *Desmidiæ*; 18, *Diatomaceæ*; 19, *Nostochaceæ*; 20, *Chroococcaceæ*. That is to say, the desmids and the diatoms are in the same general group with all the rest of these families. These fall again into two divisions; the filamentous and the cellæ form *algæ*, and there happen to be the same characteristics in the family of desmids. This may cause the student some trouble. He may mistake some other filamentous or cell-shaped species of *algæ* for a desmid. What is the distinction? This: that the filamentous desmids are *notched in the middle of each cell*, giving a wavy or toothed appearance to the outline; the other filamentous unbranched *algæ* never so. There is but one exception. *Gonatozygon* might be taken for one of the brown *Oscillariæ*, of the family *Nostochaceæ*. But the cells in *Oscillaria* and allies are never much longer than wide, while in *Gonatozygon* they are 10–20 times longer than wide. Of the cell-shaped forms, again, two other families will bother him, the *Palmellaceæ* and the *Diatomaceæ*, which are also free one-celled *algæ*. But the symmetry or bilaterality of the cell will distinguish the desmids from the former, and their motion and color in addition from the latter. The desmids are remarkable for their symmetry. The human form is symmetrical, but the desmid still more so. Given the outline of half the man, on a line drawn from head to foot, and one can draw the man entire; but we need only to see a *quarter* of the desmid to complete the figure in almost every case, *Closterium* being the single exception. The quarter reversed gives the half, and the half reversed gives the whole figure. As illustrations take *Micrasterias*, *Cosmarium*, *Docidium*, *Xanthidium*, *Staurastrum*. The only exceptions are *Closterium* (whose shape makes it known at once), and some others *in the early stages of multiplication*, as, for example, *Micrasterias*. Now it is true that in the *Palmellaceæ* each quarter is like every other quarter, but there is no bilaterality, no fissure which divides the cell into two halves, each the exact counterpart of the other. And this distinction will separate the diatoms also, for though there is here symmetry—bilaterality—it is differently produced. In the diatoms it is effected by a band or hoop which runs across the long diameter; in the desmids by a division across the short diameter. The bilaterality of the diatom may be represented by a pill-box standing on edge with a narrow strip pasted on the middle of the circumference; that of the desmid by a tube with a groove running round the middle between the two ends. But we seldom get this view of the diatom any

way. It is the side view of the diatom that is almost always uppermost, but the front view of the desmid. It is true the side view of the diatom also often exhibits symmetry, owing to the midrib, but this is on account of an internal, not external, fissure, and it also runs *lengthwise*, and not across the shorter diameter. In the discoidal forms even this median line is wanting. The fissure in the diatoms, I repeat, is *internal*, not *external*. This is a better distinction than the color it seems to me, for the diatoms in the young state are also green. Finally, the diatoms move quickly, the desmids slowly, the former reminding one of little tug-boats by their rapid, jerky motions. Let me add right here that in studying the filamentous desmids one should remember that the real desmid is not the filament but the *single cell*, by repetition of which the filament is produced, and confine his attention entirely to that, enlarging it if possible until it fills the whole field. If he will do this with two or three species he will be rewarded by a far clearer idea of those forms. *The filaments are not real filaments*; the connection of the cells is only by chance as it were. *The desmid in each case is the single cell*, not the chain of cells, as in many other algæ. Furthermore it should be noted that the two original semi-cells are at the *ends* of the filament, the growth taking place in the middle and not at the apex of the filament, as is the case in other families of algæ.

Assuming now that we can tell the desmids at sight, and confining ourselves to them, we take up their special classification. The micrographic makes five large groups, namely: 1, *Closteriæ*; 2, *Cosmariæ*; 3, *Desmidiæ*; 4, *Ankistrodesmiæ*; 5, *Pediastrææ*. But the two latter are now referred by the latest authority (Wolle) to other families of algæ and may be struck out of the list. We have then nineteen genera arranged in three divisions, which, for convenience, let us place thus: 1, *Desmidiæ*; 2, *Closteriæ*; 3, *Cosmariæ*. Now there is a striking difference between the first of these groups and the others. In the first the cells are *in filaments*. In the second and third the cells are *not in filaments*. Six genera then may be recognized at once and they are: 1. *Desmidium*; 2, *Bambusina*; 3, *Sphærozosma*; 4, *Phymatodocis*; 5, *Hyalotheca*; 6, *Gonatozygon*. In all these the cells are united end to end, and the following points will serve to distinguish them: if the cells are *toothed* and *angular* it is *Desmidium*; if *barrel-shaped*, *Bambusina*; if *deeply notched* it is either *Sphærozosma* or *Phymatodocis*, and the square shape will make it the latter, while the scalloped edge will assign it to the former. If there is hardly any notch it is *Hyalotheca*; if none at all, and the cells are much longer than wide, it is *Gonatozygon*.

And so the labor narrows down to only thirteen genera, to wit: 7, *Closterium*; 8, *Penium*; 9, *Mesotentrum*; 10, *Spirotania*; 11, *Docidium*; 12, *Tetmemorus*; 13, *Micrasterias*; 14, *Euastrum*; 15, *Calocylindrus*; 16, *Arthrodesmus*; 17, *Arthrodesmus*; 18, *Xanthidium*; 19, *Stannastrum*.

But here another marked feature comes to our aid, for we can divide these again by the *relative length and breadth of the cell*. In the *Closteriæ* the *length* is *much greater* than the *breadth*. In the *Cosmariæ* the *length* is *not much greater* than the *breadth*. The *Closteriæ* are all long forms, resembling in this respect the type from which they are named.

Note now the shape and ends. If the cell is *curved* it is *Closterium*; if the ends are *round* and *notched* it is *Tetmemorus*; if the semi-cells are *swollen* at the *base* it is *Docidium*. If there is *no notch* in *end* or *side* it is *Mesotænium*, *Penium*, or *Spirotænia*. The spiral bands will make it the last, the regular arrangement of the chlorophyll will point to *Penium* rather than *Mesotænium*. The first three and the last genera are easily recognized. *Penium* and *Mesotænium* alone will occasion any difficulty. *Penium* is the more regular, however, in form and arrangement of chlorophyll, and is generally much the larger.

So far then the road is still comparatively easy, and we have only seven genera left to bother us. In these *Cosmaria* the cell is *not much longer than broad*, they are short in comparison with most of the former group, and as a rule highly ornamental. Of these seven again three can be separated on account of their *spines*, of which *Arthrodesmus* has four, two on each end, *Xanthidium* many, while *Staurastrum* has veritable horns, the end view is always very angular, and the shape is exceedingly irregular, the most so of all the desmids, the widest diversity existing between the different species.

Thus we have only four left, all of which have *no spines* or *horns*. And of these, *Micrasterias* can be told by its flat and *slitted surface* (as if it had been snipped all round by the scissors); *Euastrum* by its *wavy outline* and inflated surface; *Cosmarium* by its *beaded* or warty *markings*. *Calocylindrus* resembles some of the plain species of *Cosmarium*, but is less deeply notched on the sides; in fact the depression is so rounded as hardly to amount to a notch at all. Besides, the number of species of *Calocylindrus* is small, only 12 being figured by Wolle as against 127 *Cosmaria*—that is to say it will not be seen so frequently.

And this leads me to say that there is a great difference, between the various genera, in the number of species, which makes some much harder to study than others in the last analysis (excluding varieties). Here is the list, approximately, according to the number of species: *Staurastrum*, 130; *Cosmarium*, 125; *Closterium*, 50; *Micrasterias* and *Euastrum*, each, 40; *Docidium*, 25; *Penium*, 18; *Arthrodesmus*, 13; *Calocylindrus*, 12; *Xanthidium*, 10; *Sphærozosma*, 8; *Desmidiium*, 7; *Tetmemorus*, 5; *Hyalotheca* and *Mesotænium*, each, 4; *Spirotænia*, *Gonatozygon*, and *Bambusina*, each, 3; *Phymatodocis*, 1. It will be observed that the genus which is most noted for the diversity of its forms has also the greatest number of species.

But when the student gets thus far he needs Wolle's help, and with his splendid volume he can go bravely on. Stokes' Key to the Species will also prove exceedingly valuable. However, it is not easy work, this distinguishing of species; no easier than any other botanical analysis. It is true the signs are all before you without any need of dissection, but the most careful discrimination is required, all the more because of the close similarity of many of the forms in the same genus.

And here let me advise you to make constant use of the binocular, which will often prove of great assistance in identifying specimens, bringing to view elevations and contours of which the monocular would give slight, if any, impression. In many cases the difference is striking, the apparently flat surface rising right up before you as the little prism is interposed and both eyes take a peep. You must use considerable

power, however, for the desmids are mostly small objects, ranging in diameter from $\frac{1}{60}$ th inch in the larger forms of *Micrasterias* to $\frac{1}{4000}$ th inch in the smaller species of *Closterium*. The length varies between $\frac{1}{50}$ th inch (*Docidium*) and $\frac{1}{1100}$ th inch (*Staurastrum*). The average diameter is not more than $\frac{1}{300}$ th inch, probably less. A $\frac{1}{4}$ th, $\frac{1}{5}$ th, or even $\frac{1}{8}$ th objective will be needed at times. And to use these with the binocular you must have fairly wide-angled objectives, and the Abbe condenser, the binocular diaphragm, and the flat-wick lamp turned broadside to the condenser *without the mirror*. It is well to use the Hopkins' light modifier also—the pale blue tint. By these means I get both fields perfectly lighted with the $\frac{1}{5}$ th of 85° Crouch, and the $\frac{1}{4}$ th of 125° Bausch & Lomb, and well enough lighted with *even the $\frac{1}{8}$ th homogeneous immersion* of same make to view any object in the centre. The dark bands appear on the sides of the field, but occasion no real difficulty.

To those who have never used the binocular with such powers on the desmids, the very first trial will be a revelation, and I am confident they will employ it ever after in their examination of these forms. At a meeting of the Roy. Mic. Soc. of London some years ago, Mr. Beck said he “remembered that when his brother Richard showed *Aulacodiscus* to Mr. Tuffen West for the first time under the binocular, that distinguished draughtsman looked at it for some time in silence and then jumping up exclaimed: ‘all the drawings of *Diatomaceæ* which I have done will have to be done over again!’”* And that is the feeling one will have after applying the double tube to *Euastrum* or *Staurastrum*, for example,—all his slides of desmids will have to be examined over again.

COLLECTING.

But here I am reminded of the old recipe for rabbit stew, “First catch your hare.” Before one can examine the desmids he must first gather and mount them. A few words, therefore, about their collection and preservation are necessary in such a paper as this. The best places for desmids, from my experience, are small, shallow pools and ditches, and the best outfit is the simplest possible,—a wide-necked bottle and a coffee strainer some 3 inches in diameter, with a fine mesh, $\frac{1}{16}$ th inch or less. These, with a cane or a jointed rod (a Japanese fishing pole costing a trifle will do), are positively all you need. For the small pools the strainer alone is sufficient; for the larger it can be fastened by its handle and two pieces of string or tape to the cane or rod. The advantage of this simple outfit is that you will often take it when tomato cans, etc., which are recommended, *would be left behind*. The desmids are said to be free floating, but I have had far better success with the superficial ooze on the bottom than with the water at the surface. Skim the ooze gently with the coffee strainer and pour into the bottle, repeating till it is full. After the stuff has settled pour off most of the water and refill. If there are any desmids in the pool, pond, or ditch, you will be sure to have a good gathering by this means. Don't slight any pool or ditch because it is small or shallow. The best gathering of *Euastrum* I ever made was from a pool not more than four feet in diameter and six inches deep, while one about twelve feet across and a

* Amer. Mon. Mic. Jour., June, 1883.

foot deep has yielded a large variety of forms, and the ditch which was next richest was about two feet wide and had barely three inches of water in it, almost nothing but ooze. Each of these spots was by the side of and quite close to a small creek, formed by springs a mile or so further inland, which runs toward the sea-coast at Westhampton, Long Island, and they were all within the radius of a mile. A fourth spot was the outlet of a mill-pond, to the side of the wheel where the water backed up and was quite still, and was not more than a foot or two deep. The light brown ooze is almost sure to contain desmids. From those four spots alone I have taken species of all the genera except *Phy-matodocis*, *Gonatozygon*, *Mesotenum*, and *Calocylindrus*: in other words, of 15 out of the 19 genera given by Wolle. This may serve to show how little trouble is often required to secure a large variety for study. Sphagnum has also furnished a number of specimens, but it is rather an uncertain habitat, some sphagnum yielding few or none; at least that has been my experience. The rain-pools alongside the railroad tracks are also good collecting grounds. A fine gathering was made by one of our Society from such a spot at Montclair Heights.

PRESERVING AND MOUNTING.

After gathering, if you want to keep the desmids alive, the material should be put in wide beakers or flat-bottomed glass dishes about three inches high filled with fresh water, and the amount of ooze in each dish ought not to be more than a quarter of an inch in depth. If given sufficient light without being exposed to the direct rays of the sun they will thrive for some time. And here let me give you a hint about getting clean specimens for mounting. Wolle says, "it is so difficult to separate specimens from their accompanying foreign matter that it is seldom amateurs can mount them satisfactorily on slides, and, therefore, this method is not open to recommendation." I cannot agree with him in the latter statement and am sorry he made it, for it has probably deterred some from trying to preserve their gatherings. I should feel much poorer if I had followed his advice myself, for I have a number of slides and prize them highly in spite of the foreign matter mixed with them, which really interferes very little with the view of most of them. But, besides, it is possible at times *to get them quite clean*. The desmids make their way to the light and form films or tufts on the surface of the ooze in the glass after it has stood a day or two, and by careful manipulation of the pipette they can often be drawn out with hardly any foreign material at all. I remember I made a gathering from a little pool at Westhampton a few summers since, and after it had stood in a glass jar a day or two I was surprised to find regular little green tufts scattered over the ooze at the bottom, and on using the pipette was rewarded by an almost perfectly clean gathering of *Euastrum*, a score or more at a dip. Let the student then allow his gathering to settle for a day or two before he transfers his desmids to the smaller bottle with carbolic acid or to Stokes' fluid. If the beaker is of good size, as the desmids will gather mostly at the side nearest the light, he will be able to exclude a great deal of the ooze or light brown mud. It is true *you* can't separate them from it; but *they can and will separate themselves* if you will only give them the chance. But in any case the student need not be deterred from mounting because of the extraneous matter. If he puts only a small amount of material in his little phial, and shakes

it up well before applying the pipette, the stuff in mounting will be so separated on the slide that he will be sure to have a number of desmids freely exposed to view. For the purposes of study it doesn't matter how much dirt there is on the slide so long as the desmids are free from it.

Either carbolic acid or Stokes' fluid preserves them well. The latter comes already prepared, or it may be made up by the druggist according to the formula, and the desmids are to be transferred to it, or the small phial containing them is to have almost all the water poured off and then to be refilled with the fluid. But if the carbolic acid is used two or three drops of the strongest solution is enough for a four or six ounce bottle, which ought to be well shaken after it is added, and the material ought not to be more than half an inch deep, otherwise it may not keep. I do not find much difference between the two preservative media. Stokes' fluid gives a brighter field and keeps the chlorophyll perhaps a trifle greener, but it causes it to shrink rather more. However, both are excellent, and the student may consider himself fortunate in having two such good fluids to choose between. For years it was a serious question to get anything that would do at all.

As to the mounting a shallow ring is necessary, and shellac answers admirably. Brown's cement may also be used for this purpose, but it takes longer to make the cell. When the ring is thoroughly dry, brush it over lightly on the turn-table with the rubber cement. Wait a second till it has partially set. Then with the pipette take up a few drops of the material from the carbolized water or Stokes' fluid and fill the cell, tilting the slide *so that the fluid touches the shellac ring all round and rises above it in the centre*. Now apply the cover, inclining it a little to one side and letting it fall gradually so as not to enclose any air-bubbles. Take up the superfluous fluid, which will be forced out, with a bit of blotting paper, press down the cover evenly all round by the needle or end of the holder, and apply a thin coat of the cement right at the junction of cell and cover. After a minute or so another coat, this time wider, taking in more of the cell ring and a little of the cover. When this has had time to stiffen give it a third and thicker coat. And the next day go over it as much as you like and finish off smoothly, without any fear that the cement will run in, and you have a mount which will last and be well adapted for study.

Notices of New Methods — IX.

By GEORGE C. FREEBORN, M. D.

INSTRUCTOR IN NORMAL HISTOLOGY, COLLEGE OF PHYSICIANS AND SURGEONS, NEW YORK.

Some New Dyes for Histological Work. Zachokke. Zeitschr. f. Wiss. Mikros, v., 1888, p. 416.

Benzopurpurin B.—This dye comes in the form of an amorphous brownish powder, freely soluble in water. The solution is a cinnabar-red color and gives a corresponding colored stain. The solution stains in a few moments, giving a diffuse stain, like acid fuchsin. The celloidin stains first, then the connective tissue, and finally the nuclei. The color is not changed by water, glycerine, acidulated alcohol, dilute solutions of hydric acetate or potassa solutions; acids darken the color. Alcohol extracts the color from the celloidin, also slightly from the protoplasm and nuclei, while the connective tissue remains intensely

stained. The color is entirely and quickly removed by alkaline alcohol. The author uses this dye in combination with hæmatoxylin in the place of eosin. It has the advantage over the latter that it is not withdrawn from the sections by alcohol or any of the clearing media, while it is withdrawn from the celloidin. He uses it in dilute aqueous solutions and does not stain the sections too deeply, and then withdraws the color from the celloidin with alcohol.

Benzopurpurin 4b.—An orange red dye, freely soluble in alcohol. It stains diffusely. Sections are placed in the staining solution from alcohol and stain for a few moments only. Connective tissue stains orange, the nuclei of a slightly darker shade; the celloidin stains lilac. The stain is altered slightly by acids and alkalis. Alcohol extracts a part of the color, especially from the celloidin. This dye is best used in combination with hæmatoxylin, but the sections must be washed in water before placing in the hæmatoxylin because of the acidity of the benzopurpurin.

Deltapurpurin.—A brownish-red powder, freely soluble in water. The aqueous solution stains sections, in two minutes, a diffuse purple-red color. The color is not withdrawn from the tissues by alcohol, acids, or potassa. Alcohol withdraws the color from the celloidin after an half hour. Acids change the color in the celloidin to a bluish tint. This dye is to be used in combination with hæmatoxylin, the latter being used first and then a faint stain with the deltapurpurin. Then wash well in water and withdraw the color from the celloidin with alcohol. Connective tissue stains red, somewhat on a violet tint; nuclei stain bluish.

Benzo-Azurin.—A brownish powder that dissolves easily in water with a blue-violet color. Concentrated solutions stain quickly, weak solutions slowly. A weak solution is to be preferred. All tissue elements as well as the celloidin stain; nuclei of a darker shade than the protoplasm. Sometimes the connective tissue elements stain of a reddish tint, the nuclei of a hæmatoxylin color. This may be due to the reaction of the tissues. Alkalis change the color of the solution to red; they also completely decolorize stained sections. Alcohol withdraws the color slightly from the tissues and the celloidin. Clearing and mounting media do alter the color. Acids do not change the color, consequently decolorization must be done in alkaline solutions.

This dye stains quickly and intensely, resembling hæmatoxylin somewhat in the results, although the nuclei do not stain as sharply as with the former. Beautiful pictures are obtained in the skin and kidney. In sections of the central nervous system, the neuroglia and the branches of Purkinje's cells are especially sharp.

Chrysophenin.—A sulphur-yellow dye, slightly soluble in water, easily so in alcohol, in which sections are to be stained. The staining is quick and diffuse, the color bright yellow. Alcohol extracts the color from the celloidin, but the color in the tissues is not affected by either alkalis or acids.

Rhodanin-red and Rhodanin-violet.—Two basic dyes soluble in both alcohol and water with a strength of color equal to that of fuchsin. Solutions of these dyes stain, diffusely, a carmin-red and reddish-violet. Water and alcohol extract the color from the sections, so they are of no use for histological work. Bacteria stain, but as yet no method of fixing the dye has been found. Further experiments are being carried on.

Motions of Certain Diatoms and Oscillaria.

By WM. A. TERRY,

BRISTOL, CONN.

In a previous article published in this periodical I stated that vigorous specimens of certain diatoms would travel a distance equal to their length in about two seconds; this is maximum speed, and is not common except in small forms, the average rate being about five seconds. The *Pleurosigma*, although as active as most varieties, requires about seven seconds to travel its length, as it is much longer than most other kinds.

I sometimes see published statements from other observers that are not in accordance with my observations. One writer states that diatoms always travel with one valve uppermost; others say that the valves are in a vertical position, showing the hoop. *Stauroneis acuta* travels with the valves vertical, showing the broad hoop or band and the edges of the valves or shells. So, also, do several varieties of *Pinnularia* and *Surirella*. *Stauroneis phenicenteron* travels with the shells horizontal, showing one uppermost; as also several *Pinnularia*, *Surirella*, etc., including all the *Pleurosigma*. In studying the motions of such diatoms as the *Pleurosigma* from Dike creek, it is difficult to avoid crediting them with some amount of volition. Although blindly running against obstructions without attempting to avoid them, yet when stopped by such obstructions, the impulse is not continued in that direction, as long as would be the case were the organism free to move. It soon backs out and travels in the opposite direction. When stopped by an obstruction this diatom comes nearer to showing currents in the water than any other I have observed, small particles passing rapidly along its side apparently without being in contact with it. Pieces of sediment resting upon it near the median line may sometimes be seen moving in an opposite direction to those in contact with the side.

This uniformity of position in all the different individuals of the same variety during motion seems to me very suggestive, as indicating a line of investigation by which their means of motion may be detected, and also showing that their motions are not so purely automatic as is generally supposed.

The motions of the *Oscillaria* seem to me to require a different explanation from those usually given. Mr. Wolle, in his 'Fresh-water Algæ of the United States,' quotes Dr. Hansgirg as advancing the supposition that the movements are of the same nature as those of the sarcode in the pseudopodia of rhizopods. As the protoplasm is enclosed in a rigid sheath, it is difficult to see how its movements can cause the motion of the entire filament, as Dr. Hansgirg states it does not protrude. Mr. Wolle believes the motion to be caused by the rapid division of cells. If an active filament short enough to be entirely within the field of the microscope be carefully observed, it will be seen that the entire filament is in uniform motion in the direction of its length, and if the variety is one in which the ends are bent or curved it will also be seen that the onward movement is accompanied by a revolution upon its axis, so that a point on the outside of the sheath describes a spiral path through the water. After the filament has travelled a certain time in one direction, the motion stops and is then reversed. The filament retraces its path in the opposite direction, the axial revolution

being also reversed at the same time. The same thing occurs in all filaments of whatever length, the whole filament travelling a certain time in one direction and then reversing its motion; the rear end apparently travelling as fast in the same direction as the front end, though of course there must be a slight difference due to cell division or growth, but it is so small as to be unnoticeable. The rapidity of axial revolution varies greatly in different varieties, some moving onward a considerable distance before completing a revolution, in others the revolving motion is the most rapid; some of the minute varieties found in the brackish water of salt marshes revolving with great rapidity, while the onward motion is comparatively slow. *Spirulina tenuissima* makes one or two complete revolutions per second.

When the end of a long-moving filament strikes an obstruction the moving impulse is sufficiently powerful to cause the filament to bend or double up, and the revolving motion may cause it to twist upon itself or others so as to resemble the strands of a rope, but it generally works itself free and resumes its natural position. In all cases under my observation the waving or nodding movements of which so much has been written are caused simply by the elasticity of the filament springing out to regain its normal position while working itself free from obstructions. The proper motion is an onward spiral movement forward and backward in the direction of its length, thus showing a striking resemblance to the motion of diatoms and probably produced in a similar manner.

When a tuft of active *Oscillaria* is placed in water in a shallow dish and exposed to light the filaments are free to move in all directions away from the central mass. Returning, they meet obstructions; consequently they move a little further in one direction than in the other. Thus their rate of speed over the dish, instead of showing their true rate of motion, only shows the excess produced by free motion over that retarded. To detect the axial revolution of some varieties requires very close observation. I do not at present propose to advance any theory as to the cause of motion, but simply record my observations and my conviction that the movements of *Oscillaria*, like those of diatoms, are entirely distinct and separate from those due to growth.

The *Oscillaria* are very plentiful in the salt marshes. The filamentous growth, mentioned in a former article as covering the active groups of *Bacillaria paradoxa*, appears to have been *Leptothrix tinctoria*. I found a class of many varieties, from the minute *Spirulina tenuissima* up to those as large as the filamentous desmids, which I do not recognize in Mr. Wollé's illustrations, with the exception of the *Spirulina*. They were colorless, and I should have supposed them in advanced stages of growth, but their very active movements seemed to preclude the idea of old age; one of them was as large as *Hyalotheca dissiliens* and somewhat resembled it in outline, excepting that the cells were rounded and not notched, and appeared to have a division in the centre. They were hyaline with the exception of small, irregular, opaque patches. Opposite ends of some of these filaments were sometimes moving in opposite directions, so as to bend or double up the filament into a sigmoid form, and as the ends approached each other the motion would reverse.

When the end of one of these filaments suddenly obtrudes itself into the field of the microscope it bears a most startling resemblance to an

animal. These forms were not found among the floating mats of *Oscillaria* on the surface, but were at the bottom of several feet of water among the *Pleurosigma* and other diatoms and in detached filaments.

NOTES ON APPARATUS.

The King Microtome.—This microtome, by J. D. King, Edgartown, Mass., will cut anything that can be cut with any microtome, and do its work as well as the best, but it is designed especially for botanical work, or for cutting any hard substance that requires the greatest possible rigidity in the instrument.

The knife is attached to a heavy nickel-plated iron carriage, *A*, by a steel clamp and shoe, *b* and *c*, with milled head-screws, *a*. The carriage runs on a solid iron track, *h* and *B*, which is held to a table by a clamp-screw, *k*.

For cutting very hard objects, like the wiry stems of plants, or the chitinous skeletons of insects, there is an attachment with a very stout blade, on the principle of a carpenter's plane, *d*, which screws on to the carriage in place of the knife, and like the knife it can be used straight across or obliquely.

Diameter of well, *j*, $\frac{7}{8}$ of an inch: depth of well, $1\frac{1}{4}$ inches: depth of well with chuck, *L*, 1 inch.

For cutting soft material, paraffine may be cast directly into the well, or into a chuck, not shown, which is held firmly by being screwed into the bottom of the well. The adjustable chuck, *L*, is intended for harder material.

Microtome No. 1 gauges to 1-10,000 of an inch by turning the ratchet.

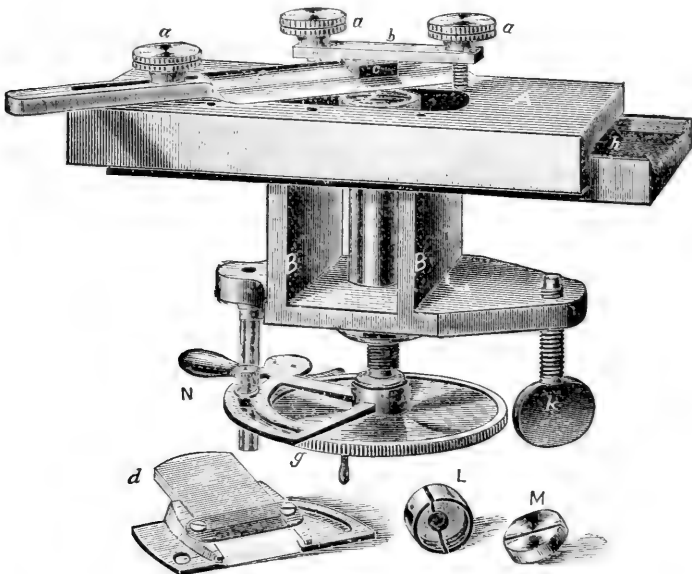

(Cut about one-third actual size.)

g., one click, but can be set to any desirable thickness less, by the adjustable arc, *N.* No. 2 gauges to 1-2,000 inch, adjustable like No. 1.

The King Microtome should not be confounded with "King's Providence Microtome," which is not now in the market; the principle is the same, but the mechanism is very much simplified and improved. It is made by Charles X. Dalton, of Boston, who did R. B. Tolles' brass work for twenty years, and whose name is a guarantee for the best of workmanship.

The following table gives thickness of sections by clicks, on No. 1 Microtome, omitting fractions of ten-thousandths of an inch: 1 click, 1-10,000 inch; 2 clicks, 1-5,000 inch; 6 clicks, 1-1,500 inch; 7 clicks, 1-1,400 inch; 8 clicks, 1-1,200 inch; 9 clicks, 1-1,100 inch; 10 clicks, 1-1,000 inch; 11 clicks, 1-900 inch; 12 clicks, 1-800 inch; 14 clicks, 1-700 inch; 16 clicks, 1-600 inch; 20 clicks, 1-500 inch; 25 clicks, 1-400 inch; 33 clicks, 1-300 inch; 50 clicks, 1-200 inch.

—o—

Zeiss' Catalogue.—Messrs. F. J. Emmerich & Son announce that a new edition of Mr. Zeiss' Catalogue (No. 28) in German has just been received, and will be forwarded to applicants for 10 cents in postage stamps. It contains many new apparatus and improvements of importance.

—o—

Queen's Catalogue.—James W. Queen & Company, of Philadelphia, have recently issued a clearance sale catalogue of microscopes and sundries. It comprises (besides other goods in this line) a large number of accessories from their regular list greatly reduced in price. A commendable feature is the fact that Queen & Co. guarantee the condition and proper working of every article.

New Method for Staining Fibrin and Micro-organisms.*—

Prof. C. Weigert has devised a modification of Gram's method in which the alcohol and oil of cloves are replaced by anilin oil. The procedure is as follows:—The section (hardening in spirit) is stained with the anilin-gentian violet solution. The staining may be done either on the slide or in a watch-glass. In the latter case the section must be washed with water or with Na Cl solution to remove excess of dye before it is placed on the slide. The section is then nearly dried with bibulous paper and the iodine solution dropped on; when the latter has acted sufficiently the section is again blotted and then covered with a drop of anilin oil, which must be renewed several times as it quickly takes up the stain. The section becomes gradually transparent and the anilin oil is removed with xylol and the section mounted in balsam.

If a double stain be desired the additional color must be imparted before the violet. In this method there is no need to remove the celloidin. By this procedure fungi and pneumonia cocci are more easily demonstrated than by Gram's method, but its principal recommendation is the sharp stain it imparts to threads of fibrin. Bacteria and fungi appear quite dark, almost black, the fibrin threads a beautiful blue.

* Fortschr. d. Med, v. (1887) p. 228.

Report upon the Postal Club Boxes—V.

BY QUEEN MAB.

Box E. The last three boxes of slides have been of unusual interest, either from the exceptional character of the slides, or from the especially interesting notes which have accompanied them. And in this connection the words of the late Dr. M. N. Miller, as given in the Annual Report of the Club, are appropriate: "I cannot but feel that the members are depriving themselves of much of the value which they might gain from membership by neglecting the pages of the note-books." And again: "Would it not be better to have more extended descriptions of our slides? Persons contribute things very familiar to themselves and seem to think they ought to be self-evident to others." The managers of the Club also say: "Not only are the notes by our professional teachers and experts models of instructive demonstration, but the less experienced members are often able to present most interesting things which they have had exceptional opportunities for observing. Such notes, if really good of their kind, are sure to be useful."

Slide No. 1 is by Louis H. Noe, Elizabeth, N. J., and the information imparted concerning the nature of the object, the methods of its preparation and preservation, is summed up in these three words, "HYDROIDEA, *Pennaria tiarella*." This is a very interesting slide, the tentacles being well expanded.

No. 2, T. D. Hodges, So. Orange, N. J., has an even more chary description, *Pandanus odoratus*; all the rest is left to conjecture.

Slide No. 3, prepared by J. D. Hyatt, and contributed by Dr. Samuel Lockwood, of Freehold, N. J., the president of the Club, is accompanied by a model description. This slide shows the "Fossil Rhizopod, *Eozoon canadense*, from Laurentian Rocks of Canada." Objectives recommended from $\frac{2}{3}$ to $\frac{1}{3}$. "This fossil is regarded by Dr. Dawson, of Montreal, as a Rhizopod, which would extend life down to Archæan time. This has been the subject of very warm discussion. The late Dr. W. B. Carpenter advocated the Rhizopod view, and performed great labor in the investigation. At his visit to this country he made it the subject of an address to the N. Y. Microscopical Society, at which time he exhibited a large number of his own preparations of the fossil. This specimen of Mr. Hyatt's preparation is very beautiful. It is not a show slide, but will interest those who care to put a little thought on the earliest possible records of animal life. See Dana's Manual of Geology. Consult index on word Eozoon."

Slide No. 4, Edward Field, preparer and contributor, Red Bank, N. J. "Portion of sac containing periwinkle spawn. Balsam."

Slide No. 5. W. C. Gorman, Randolph, N. Y., Suckers on Leg of *Dytiscus marginalis*. Mounted in Canada balsam, and cement used. Zinc White. For description, members are referred to Carpenter.

Slide No. 6. H. S. Housekeeper, So. Bethlehem, Pa. "Pollen of *Erythronium americanum*. Dry."

Box U². No. 1, by S. G. Shanks, M. D. Albany, N. Y., Vertical Section of Scalp of Man. Section cut in freezing microtome, stained with borax carmine. Medium, balsam in benzole; cement, shellac. Objectives recommended 1 inch and $\frac{1}{4}$. There is a figure of this preparation in the note-book, and the following description: "The hair rises

from a papilla at the bottom of the follicle. A sebaceous gland near the top of the follicle secretes a sort of an oily substance which keeps the hair glossy. A sweat gland is seen to the left of the hair—the gland is simply a coil; the duct ascends spirally to the surface of the skin. Fat cells and fibrous tissue surround the hair roots.

Slide No. 2, the work of Dr. G. A. Marietta, of Clarion, Iowa, is a section of Epithelioma, frozen and cut with razor, stained with hæmatoxylin, and mounted in balsam. No. 3, is by Frank French of Lawrence, Kansas. Head of *Gyrinus natator*.

Slide No. 4, by A. G. Field, M. D., Des Moines, Iowa, is transverse section of 4 months' fœtus. Cleaned in acetic acid and mounted unstained, in glycerine. "M. N. M." comments: 1. Harden your tissue in alcohol. 2. Imbed in paraffine. 3. Cut with razor flooded with alcohol. Don't bother about getting a section of the whole alimentary tract, teeth and all, in a single section at first. 4. Stain with hæmatoxylin. 5. Dehydrate with 95% alcohol. 6. Clarify with oil of cloves. 7. Mount in dammar.

Slide No. 5, by J. J. Davis, Racine, Wis., Section of Sarcomata, hardened in 40, 60, 80, and 95% alcohol, imbedded in paraffine and cut in a well microtome. "The Sarcomata are tumors composed of embryonic tissue, connective tissue, classified according to size and shape of cells. This specimen is of small round-celled sarcomata, the special point of interest being presence of giant cells, which are rare in tumors of this kind, though common in those that spring from bone medulla."

No. 6, prepared by W. H. Walmsley, and contributed by G. M. Houston, of Harrisonville, Mo. Transverse Sections of leaf and midrib of *Ficus elastica*. Double stained and mounted in balsam. Artificial light, and 1 inch and $\frac{1}{2}$ inch objectives recommended.

Some Habits of the Crayfish.

By Prof. L. W. CHANEY, Jr.

NORTHFIELD, MINN.

To those who have followed the series of articles in this periodical by Prof. Osborn on the histology of the crayfish, some memoranda of my own concerning this handy arthropod may be of interest. In the small river which runs by our town, and to which attention often turns for biological material, the crayfish much abounds. The annual raids to meet our demands do not seem in the least to decrease the supply. It is a delight to the soul, whether æsthetically or biologically inclined, to float down over the shallows and study through the clear water the quaint lives of the aquatic animals and plants.

The crayfish chooses the shady side of a rock and lies in wait. The stalked eyes peer about with a comical twist, and if some savory morsel comes floating along the claws begin to sway and reach with sluggish alertness. The crayfish is by no means dainty and will consume any bit of garbage which may come in his way. Like the sea-shore cogeners it may be enticed and taken by a bit of meat tied to a string, and the enticement is specially strong if the meat is tainted. It seems that an animal provided with such a formidable armature would sometimes seize living prey, but many observation have failed to show that it ever does

so, although the contents of the stomach seem at times to indicate something of the kind. How bits of mussel shell find their way into the maw of these little scavengers it is not easy to understand. It is interesting to watch the munching and grinding which form a part of the eating process. If the crayfish be kept for some time in an aquarium it becomes to a certain extent domesticated, and its habits may be studied. If the aquarium has a transparent bottom the motions of the mouth parts may be well observed. The animal balances itself skilfully on three pairs of legs, while the great claws and the next pair are used to press up to the mouth the desired morsel. The foot jaws work with a combination of a crushing and sawing motion, while the strong mandibles at each side of the mouth take sharp nips from pieces torn away by the foot jaws. When we remember that in the stomach there is another masticatory apparatus it certainly seems as though these animals were somewhat redundantly supplied.

I had supposed the crayfish to be principally a nocturnal animal, but its actions in the aquarium are not in accord with that idea. It seems to have no special time for activity, but to be very irregular in its habits. This may be due to the artificial conditions of life.

The mode of locomotion has passed into a proverb, and every one knows what it means to "crawl like a crayfish." The idea that progression is exclusively retrograde is not true. Four pairs of legs are generally used in locomotion, and they are moved in a definite order, whether the animal moves forward or sideways. Observations on this point have not been close enough to warrant positive statements, but usually the first and third upon one side are moved and immediately after the second and fourth on the other side. I have never observed that they have more than two feet raised at the same time. This of course does not include the large claws, which are not used in locomotion.

The working of the little pump by which water is made to flow over the gills may be readily observed by cutting away a little notch from the carapace at the point where the cervical suture runs down to the edge of the gill-cover. This causes no apparent inconvenience to the crayfish, and is certainly not painful. The gill plate is as hard and insensitive as the finger nail. The pump is a little scoop-shaped apparatus which is attached to one of the appendages near the mouth, and its working, which may be plainly seen, is a good lesson in animal mechanics. The gills which this pump supplies with fresh water are objects of much interest to the microscopist, as they exhibit in simple form the essential points of all respiratory structures.

The egg-laying process is not without its points of interest. The reproductive orifices are double and placed upon the bases of the thoracic legs. The eggs when extruded are covered with a substance which attaches them very firmly to the fine hairs which fringe the abdominal feet. When the eggs are to be deposited the female curves the tip of the abdomen forward under the thorax. As the eggs pass into the space between the thorax and the under-folded abdomen they are moved about by the motions of the abdominal feet and finally become attached as stated above. The crayfish is very careful of the mass of eggs, guarding it and carefully keeping it out of harm. Thus far no young have hatched in confinement. Strangest of all habits which these lowly animals have is that of changing their clothes. This

they share with other animals, such as the toad and the snakes. But the method of change is unique. Any one who has noticed the claws of the crayfish or lobster would be likely to say that it was impossible that the mass of tissue contained within them should be drawn through the slender joints which unite the claw with the body as one might withdraw the hand from a glove. This is exactly what they do, however. It is not often that one may see the process, and it was I presume an unusually good fortune which enabled me to see the last part of this curious disrobing. The integument of the crustaceæ and their relatives is so hard and unyielding that increase in size is impossible in the ordinary way. It is provided for either by all growth occurring before the adult form is assumed or by this periodical change. When the old skin is to be cast off some secluded place is chosen if such can be found. The animal goes through a series of strange contortions, wringing the claws about like the hands of one stricken with great agony. Head and tail are drawn violently together which would in a more flexible animal hump the back with force. Sometimes several of these paroxysms occur before a long slit appears down the middle of the back. Through the slit appears the lighter brown of the new integument. At this point I surprised my captive and stayed with him until the change of raiment was completed.

The change is usually made in the night. Happening to approach with a lamp the aquarium where I had a number of crayfish confined I looked in upon them and found one in the condition stated. I was obliged to wait nearly an hour before it went on with the process. The next step seemed to be the release of the great claws. It was comical and painful to see the poor creature tug and strain. Suddenly, while attention was turned to the claws, the antennæ and other adjacent parts slipped neatly out and the head of the animal popped up through the slit in his back. He then took another rest. The animal next worked to release the claws, leaning back upon the tail and pulling steadily. The claws stuck hard, but with a final twist they were released. After a short rest the animal easily released the remaining legs and then seemed to walk forward, withdrawing the abdomen from its old casing with scarcely an effort.

Beside the habits above noted there are several others of much interest to the patient observer.

BIOLOGICAL LABORATORIES, CARLETON COLLEGE, Mar. 11, 1889.

Genuine and Manufactured Honey.—Worthington G. Smith, of Pittsburg, announces that genuine honey can be readily distinguished from manufactured honey by the microscope. The former has few or no sugar crystals and abounds with pollen grains, while the imitations have little else than these crystals, with rarely a trace of pollen grains. The honeyed taste of the manufactured article, he thinks, may come from honey-comb or beeswax being mashed up with the article used in the manufacture. Each class of plants has its own specific form of pollen grain. Any one conversant with this branch of botany could tell from what part of the world the honey came by studying the pollen grains that it might contain.

Henry Mills, of Buffalo, N. Y., died February 7, in Chattanooga, Tenn., of pneumonia. He was a member of the American Society of Microscopists.

BIOLOGICAL NOTES.*

Ventilating Bees.—A correspondent of *Nature* from Mauritius writes (vol. xxxix, p. 224) that in that as well as in other tropical countries certain bees are delegated to stand at the entrance of the hive, and by the incessant motion of their wings “fan the interior” of the hive, these being relieved at intervals by fresh bees, and all kept at their duty by a guard. We venture to question the logic of this statement. The fact being acceded, it is more reasonable to suppose that the fanning bees are luxurating in the current of air the motion of their wings produces rather than working for the good of the community without the possibility of knowing that there is such a good. We would suggest the importance of observing more accurately with this question in mind.

Botanical Laboratories.—The *Botanical Gazette* for January, in continuation of its articles upon this topic, has an illustrated article upon the Laboratory of the University of Pennsylvania.

Newly Discovered Organ in the Cockroach.—Mr. Edward A. Mierchin, in the *Quar. Jour. of Mic. Science* (vol. xxix, p. 229), describes a new organ under the fifth tergite on the back of the cockroach, *Periplaneta orientalis*. It consists of a pair of small glands, which are considered by him as odor producing glands.

Finger Prints.—Mr. Francis Galton, F. R. S., in an address before the Anthropological Institute, describes an interesting method of identifying individuals when other means are insufficient, by impressions made by the ridges on the ends of the fingers and thumbs. These are made either by pressing the thumb or finger upon a copperplate upon which is a very thin film of printer's ink, and then pressing the finger upon white paper, or using a piece of metal or glass with a coating of smoke upon it, and making the impression upon a moistened gummed paper. The impression is said to be very characteristic, and the form to remain constant through life.

The Common Dodder.—Dr. Henrietta E. Hooker contributes to the *Botanical Gazette* (vol. xiv, p. 31) a valuable article on the growth and structure of this interesting parasite, which is abundant in many parts of the United States. For the microscopic structure fresh specimens were preserved in alcohol and afterwards imbedded in celloidin, and sections made so as to reveal the structure of the plant and its connection with its host.

Cestodes in Marine Fishes.—An abstract of the report of Prof. Edwin Linton on subject in connection with the report of the U. S. Fish Commission for 1886, given in *Am. Journ. Sci.*, gives the number of those parasites found in marine fishes at forty-two. The full report will be of interest to biologists inasmuch as it relates to a group of worms presenting many erratic features.

* This department is conducted by Prof. J. H. Pillsbury.

Diseases of Swine.—The Commissioner of Agriculture has appointed a commission, consisting of Professor William H. Welch, of Johns Hopkins University, Dr. E. O. Shakespere, of Philadelphia, and Professor T. J. Burrill, of the University of Illinois, to investigate the subject of swine diseases in the United States, and the methods of their treatment and prevention.

—o—

Water Supplies Again.—The North American Review for February, in its "notes and comments," gives some crisp points upon this subject, some of which are, to say the least, overstated, but many of which deserve consideration.

—o—

A New Moss.—Prof. C. R. Barnes publishes in the *Bot. Gaz.* (vol. xiv, p. 44) a list of mosses from the Mingan Islands on the southern shore of Labrador, among which is a new species which he names *Bryum Knowltoni*.

—o—

Certain Relations of the Cell-wall.—Dr. Kohl (*Bot. Central.* vol. xxxvii, p. 1) demonstrates that the growth in thickness of the hairs of many plants is not strictly by interseption nor by opposition, but by periodic deposition of layers of cellulose, and he notes the fact that, between these successive layers, there is generally a trace of protoplasmic matter not easily detected by Millon's reagent. Kravon has already shown that the growth of vast fibres is substantially of the same character.

—o—

Lichens and Their Hosts.—No subject perhaps affords the amateur worker with the microscope a better illustration of what the instrument has aided the scientist in doing than does the progress which has been made in the study of the lichens and the microscopic algæ upon which some species of lichens feed. The *Am. Nat.* for May presents an interesting sketch of progress of investigation in this direction from the pen of Thos. A. Williams. The green bodies which are found in great abundance in the tissues of many lichens were supposed to be a part of the lichen and were named gonidia. Long continued observation and experiment showed, however, that this was not the case, and after many patient and oft repeated cultures of the so-called gonidia it has been found that they have a life history entirely independent of the lichen, and are therefore to be classed among other plants. It is found moreover that these so-called gonidia represent certain groups of chlorophyll bearing plants among the Protophyta and Zygomycota, and many are easily identified with well-known species of these algæ or chlorophyll bearing plants. The nature of the relation of the gonidia to the lichen is shown by the culture of the spores of those lichens in which the gonidia are found. If the spores of these lichens are subjected to the proper conditions of warmth and moisture they will germinate in the course of a few days and growth will continue for a time, after which it will cease unless the germinating hyphae of the lichen comes in contact with algæ upon which it can feed, in which case the growth continues.

BACTERIOLOGY.*

Staining Tubercle-Bacilli.—The Koch-Ehrlich's† method is probably the most trustworthy of any in use. According to this method, specimens to be examined for tubercle-bacilli are prepared and stained in the following manner :

The cover-glasses must be thoroughly cleansed in some cleaning mixture to free them from any adherent particles of grease or dirt that might prevent the substance to be examined from sticking to the glass. The suspected material must then be spread on a cover-glass in the thinnest possible layer. If a hard tubercular nodule is to be examined it must be crushed and completely broken up before spreading it on the cover-glass. In case of sputum the more solid, yellowish masses should be taken, excluding as much as possible the accompanying mucus. The film thus prepared must now be allowed to dry in the air of the room *without extra heat*. As soon as it is thoroughly dry the cover-glass with the film uppermost is passed three times moderately quickly through the flame of a spirit-lamp or Bunsen burner, in order to fix the film so that it may not be washed away during the staining process.

After heating, the cover-glass must be floated film downwards on the surface of the staining fluid, care being taken that no air-bubbles lie beneath it, which would protect the specimen from exposure to the staining fluid at this point. The cover-glass should remain in the stain for from 12 to 24 hours at the temperature of the room.

The stain consists of a solution composed of 100 c.cm. of aniline water, 11 c.cm. of a saturated alcoholic solution of methyl violet (or fuchsin), and 10 c.cm. of absolute alcohol. The aniline water is made by adding about 5 c.cm. of aniline oil to 100 c.cm. of distilled water, and shaking the two thoroughly together. From 3 to 4 per cent. of aniline is taken up by the water; the remainder adheres to the bottom of the vessel in the form of thick drops. This saturated solution of aniline is obtained in about one-half hour, when it is filtered. The filtrate should be as transparent and colorless as water. It is better to prepare afresh a few c.cm. of the stain each time that it is required, for owing to the aniline water it will not keep for any length of time. The saturated alcoholic solution of methyl violet (or fuchsin) is obtained by pouring about 100 c.cm. of absolute alcohol upon about 20 grms. of dry methyl violet (or fuchsin) in a well-stoppered glass vessel and shaking frequently.

After the necessary time has elapsed the cover-glass is removed from the stain by means of fine forceps. The preparation is now stained very dark, almost black. It is immediately placed in nitric acid diluted with three to four parts of water; in this it is freely moved about for some seconds until it becomes of a greenish-blue color, when it is transferred to a vessel containing 60 per cent. alcohol. It is left in the alcohol for several minutes until no more of the staining fluid is washed out, when it is ready for the next staining process.

In preparations treated with nitric acid and alcohol the tissue elements are quite colorless, or of a very light blue tint, while the tubercle-bacilli

* Conducted by V. A. Moore, assistant in the laboratory of the Bureau of Animal Industry.

† Volume xcv of the New Sydenham Society. *Microparasites in Disease*. London, 1886.

present an intense blue color, if methyl violet was used. It is almost impossible to determine the position of the bacilli in relation to their surroundings in specimens so prepared. In order to get the strongest possible contrast between the staining of the bacilli and the cell-nuclei, a yellow or light brown stain is chosen when the bacilli are blue, and when they are red, green or blue is preferred for the tissue; in the first case vesuvin or Bismark brown is best suited, in the second methylene blue. Both of these dyes must be used in weak solutions and their time of action limited. The cover-glass preparation stained in methyl violet and decolorized in nitric acid and alcohol is then placed, film downwards, in a vessel containing the vesuvin solution.

From the vesuvin solution the cover-glass is rinsed in water and then allowed to dry in the atmosphere of the room. When it is thoroughly dried it is mounted in Canada balsam diluted with oil of turpentine or xylol. Very thick balsam, which has to be used warm, cannot be employed, as the heating would quickly decolorize the tubercle-bacilli.

Contrast staining, as a rule, is not required in examining sputum for tubercle-bacilli, so that preparations of sputum may be examined immediately after treatment with the nitric acid and alcohol. They can be examined at once in water, or allowed to dry and then mounted in Canada balsam.

Sections of tissues that have been hardened in alcohol can be stained for tubercle-bacilli in the same manner as cover-glass preparations. After staining in the contrast stain, they must, however, be passed through first 70%, then 95%, and finally absolute alcohol, and then cleared in oil of turpentine or cedar oil before mounting them in the Canada balsam.

The Koch-Ehrlich-Rindfleisch rapid method of staining tubercle-bacilli is reported by Dr. E. O. Shakespeare* as giving constantly satisfactory results, both as to reliability and rapidity. With it the examination of sputum or other fluid or semi-fluid material for the presence of the tubercle-bacilli requires no more time and trouble than the examination of urine for tube casts, and often not so much of either.

The method is Ehrlich's, modified by heating the staining fluid containing the specimen over a spirit or gas flame until bubbles begin to appear. Remove the heat at once and allow the cover-glass to remain in the hot fluid from two to four minutes. Then remove it, immerse it in acid, then alcohol, and so on as described above.

Philip Henry Gosse was born at Worcester, England, in 1810, and died at Marychurch, April 23, 1888. Among his early works were "The Canadian Naturalist" (1840) and "The Birds of Jamaica" (1851), "A Naturalist's Rambles on the Devonshire Coast" and "The Aquarium" (1853-'4). Of greater importance was his "Manual of Marine Zoölogy" (1855-'6), and "Actinologia Britannica." The latter is still an authority on sea-anemones and corals of the British Isles. To microscopists his work on the Rotifera in connection with Dr. C. T. Hudson is invaluable. All his works were finely illustrated, he being an ingenious artist.

* Journal of Comparative Medicine and Surgery, 1887, p. 241.

MICROSCOPICAL SOCIETIES.

ESSEX COUNTY, N. J.—F. VANDERPOEL, *Secy.*

Jan. 17, 1889.—The subject was bacteria, and the members brought a large number of valuable and interesting slides, representing work in bacterial pathology by Pasteur, Koch, and others. Mr. Loomis brought a modified Zentmayer histological stand, and upon the stage he placed a slide of bacillus anthrax, the microbe of splenic fever. This exhibit was interesting for two reasons: First, because of the microbe itself, by the study of which Pasteur has made his name famous, and second, because of the objective used, which was an apochromatic $\frac{1}{12}$ " made by Swift of London. Mr. J. Lee Smith exhibited a slide of bacillus tuberculosis, which the members examined and compared with a slide of the same bacillus under the microscope of the secretary. Dr. Ayres showed upon his stand what is known as the pneumonia bacillus, and Dr. Brown had a number of pathological slides, among which he selected the microbe of malignant œdema. This was followed by an exhibit, by Mr. Smith, of bacillus typhi. One of the finest exhibits of the evening was a slide of the comma bacillus, prepared by Dr. Koch and shown by Mr. Loomis. The field was literally full of the bacilli, and the members expressed their admiration of the slide.

Feb. 7.—Meeting held at Montclair. The subject was mould. There were a variety of slides, some being the work of professional preparers outside of the Society, and others had been prepared for this particular meeting by members. Mr. Carter exhibited a specimen of mould which he had found on a piece of decayed parsnip and said that it was penicilium glaucum. He then proceeded to explain the growth of this mould: the formation of mycelium, then of the reproductive cells, termed conida, which are simply masses of protoplasm enclosed in walls of cellulose. The formation of mucor mucedo was also explained, and a very fine specimen was shown by Mr. Loomis. He also showed the Society some Aspergillus glaucus (cheese mould), and Asterosporium hoffmanni (spores of the star mould—a very beautiful object indeed, and one which from its peculiar shape might be recognized whenever seen). Another slide of Mr. Loomis' was that of mucor mucedo, containing one spore case full of spores and another one very close to it, but empty. The president, Dr. Ayres, exhibited some mould which had formed upon a piece of paper used to cover a cup of jelly (*i. e.*, placed upon the top of the jelly itself). This was a very interesting object, showing a beautiful network of mycelium with the spores scattered all over it. This gentleman also exhibited a slide of potato mould (perenospora infestans). Several other slides were exhibited.

NEW YORK MICROSCOPICAL SOCIETY—G. E. ASHBY, *Secy.*

January 4, 1889.—The following were elected officers for 1889: Rev. J. L. Zabriskie, President; Geo. M. Mather, Vice-President; Geo. E. Ashby, Secretary; Edw. C. Chapman, Treasurer; A. A. Hopkins, Curator.

January 18.—Dr. Samuel Lockwood read a paper on "The Hygiene of the Atmosphere: a comparative study in relation to Hay-fever."

Dr. A. A. Julien read a paper entitled, "Notes on a new Ochraceous Thallophte." The regular meetings occur on the first and third Fridays of each month at No. 64 Madison avenue.

—o—

ILLINOIS STATE SOCIETY.

Tuesday, January 22, 1889.—On the occasion of its annual conversation, the Calumet Club put its elegant club-house at the disposal of the Society. A fashionable audience of about 350 ladies and gentlemen responded to the invitations. On the first and second floors were arranged seventy microscopes, and, as the slides were all changed at 9 o'clock, there were 135 slides on exhibition. Among those which attracted most attention were specimens of unfiltered drinking water taken from a large building in the centre of the city, and mounted by Prof. J. H. Long and Mr. Mark Powers. Mr. W. H. Bullock exhibited a large number of slides, one containing the eye of a beetle. On the third floor a beautiful and elaborate stereopticon exhibition was given.

—o—

TROY SCIENTIFIC ASSOCIATION, N. Y.

Monday, February 4, 1889.—The microscopical section met at the residence of Joseph McKay. An exhibition of objects was made by C. E. Hanaman.

NOTICES OF BOOKS.

Merck's Index of Fine Chemicals and Drugs for the Materia Medica and the Arts. By E. Merck. 8°, pp. 168. New York, 1889.

This purports to be a catalogue of all drugs and chemical products used by the physician or druggist. Over 4,000 different articles are specified. The alphabetical arrangement is excellent. Blank columns are given in which to insert prices, memoranda, etc. Synonyms are freely given, melting points, chemical composition, and miscellaneous notes of value. There is a useful table of abbreviations at the close. The reader is exhorted at the bottom of each of 154 pages thus: "When ordering, specify Merck's!" This indicates an advertising purpose in the volume, and seems to us an unnecessary blemish.

—o—

A Manual of the Vertebrate Animals of the Northern United States, inclusive of Marine Species. By David Starr Jordan. Chicago. A. C. McClurg & Co. 1888. 12°, pp. 375. \$2.50.

Few treatises on systematic zoölogy or botany have the good fortune to run through several editions and become indispensable, but President Jordan's Manual seems likely to. Fifteen years ago a little pamphlet key to our birds was published by him. Twelve years ago the first edition of the present Manual was issued to give collectors and students who are not specialists a ready means of identifying the families, genera, and species of our vertebrate animals. Two years later a second edi-

tion was issued in which the account of the fishes was completely recast. A third and fourth edition followed (in 1880 and 1884), and now a fifth edition wholly rewritten and rearranged.

A complete key to the vertebrates known to inhabit northern and eastern United States means the definition of 1145 species, 607 genera, 213 families, 54 orders, and 7 classes. The vertebrates may now be studied by college classes with the Manual as a key as readily as hitherto the flowering plants could be identified with Gray's Manual.

The range of the work has been widened, so that it now embraces all known vertebrates of Missouri, Iowa, Minnesota, Canada, Nova Scotia, and the Atlantic coast as far south as Cape Hatteras. This is a great gain in completeness, for it adds numerous large mammals, such as the coyote, grizzly bear, harbor seal (among carnivores), the white-tailed deer, mule-deer, carabou, prong-horn, big-horn, and buffalo (among ruminants), the order *Cete* (among mammals), some birds, as the auks, and a very large number of fishes.

The revision has included the nomenclature, bringing the names up to the present agreement among the specialists. The omission throughout the work of all synonymy is doubtless of advantage for brevity, but the addition of a brief and judicious condensed synonymy would be a great gain. Such a change in nomenclature as that of the generic name of the loon from *Colymbus* to *Urinator*, and the use of *Colymbus* for the grebe formerly known as *Podiceps*, is in the interest of good nomenclature and should be followed, although it would be confusing to the tyro, for whose benefit a clue could be easily given.

The greatest improvement observed in the new edition is the change in the order of description, beginning now with the lowest and proceeding to the highest, and ending with man, who in the earlier editions was entirely ignored. With this improved order of treatment is also an improved method, the withdrawal of artificial keys based on characters of easy recognition, but of slight or often no morphologic significance, and the substitution of natural keys based on characters of true genetic value. In the former work the intention was to name the specimen as quickly and as easily as possible; now is added to this chief aim the purpose to exhibit classificatory facts with their proper value so as to draw attention to natural affinities among the vertebrates. This is in the direction of sounder learning. A key built upon the natural system is not always the shortest, but it is the surest, and hence in science the best. The new edition thus steps out into a somewhat larger place than its predecessors and is no longer merely a key to the names of vertebrates. It is an introduction to a more scientific study of vertebrate zoölogy. It is well fitted to be used as a college text-book, and will find a place in many laboratories for that purpose.

Besides the matter of most purely systematic importance the author has made space for the etymology of all the names and items of historical interest, and he occasionally hints at some economic feature or curious habit, or even at times indulges in a touch of guarded humor.

Though the new edition contains perhaps twice as much matter as the second edition it is shortened 32 pages by the more economical use of space and the employment of smaller type. So good, however, is the press-work that the new page is more attractive to the eye than the page of the old editions.—H. L. OSBORN.

The Educator. Buffalo, N. Y. Vol. I, No. 1.

This is a monthly devoted to the education of young men and women in the current events of the day. It is also intended as a repository of what is of most importance in periodical literature. It has three departments devoted, respectively, to current history, current literature, and current science. Under current history is given proceedings of Congress, State legislatures, and of foreign legislative bodies, an explanation of the most important political and social events, biographical sketches. Current literature is devoted principally to reviewing such works as are of importance to the younger portion of society, especially to teachers and to students in high schools and colleges. In the pages devoted to current science is found a description of the new and important inventions, likewise an account and explanation of new discoveries in the sciences—chemistry, physics, astronomy, etc.

—o—

Ultimate Finance; A True Theory of Wealth. By William Nelson Black. Humboldt Publishing Company. New York.

This is part second of an economic work begun in the September number of the *Humboldt Library of Science*. The first two chapters treat of the origin of property and the evolution of wealth, the third and fourth discuss the principles and possibilities of banking and insurance, and the fifth, sixth, and seventh are devoted to a correction of the many misconceptions that abound on the nature of accumulation and the administration of property. The second chapter seems to be intended to show the reactionary character of theories of land confiscation. But the main purpose is an exposition of the theory of bonded insurance. The book defines a system which, if found organically practicable, will enable men to carry insurance always without sacrifice of personal resources, and sometimes with considerable gain. This is promised by giving to the person contributing to an insurance fund the increase to be drawn from investment and profits.

SUBSCRIBERS' NOTICES.

[These notices will be given six insertions in this column at 25 cents per line or fraction thereof.]

FOR EXCHANGE.—Slides of selected diatoms.

D. B. WARD, Poughkeepsie, N. Y.

WANTED.—Unmounted microscopical material, also micrographic dictionary. Will exchange or buy.

CHARLES VON EIFE, 124 Clinton Place, New York City.

WANTED.—A clean copy of Rev. William Smith's *British Diatoms*, and Schmidt's *Atlas of the Diatomaceæ*.

JAMES B. SHEARER, Bay City, Mich.

WANTED.—To give diatom slides and cash, or either, for copy of Van Heurck's work on diatoms, bound or unbound.

ALBERT MANN, Jr., Newark, N. J.

CORRESPONDENCE invited with a view to the exchange of either mounted or unmounted Oribatida (British) for American species.

E. BOSTOCK, Stone, Staffordshire.

WANTED.—Specimens of rocks for slicing and grinding into sections; also bones and teeth of different animals, diatoms *in situ* on algae, diatomaceous and polycestinous earths, ocean soundings, etc., etc. Liberal exchange in microscopic slides or cash.

ARTHUR J. DOHERTY, 63 Burlington St., Manchester, Eng.

TO EXCHANGE.—Native gold, silver, copper, lead, zinc, and other beautiful cabinet specimens, polished ornaments and sections of petrified wood—Chalcedony—and native turquois-, agate, amethyst, rubies, etc.; also Indian ornaments, curios, arrows, blankets, pottery, etc.; pelts of wild animals, species of native cactus, and a good second-hand "Burt's Solar Compass" complete. Any or all of the above are offered in exchange for new, or good second-hand, objectives, condensers, polarizers, stand, or other microscopical apparatus.

W. N. SHERMAN, M. D., Kingman, Arizona.

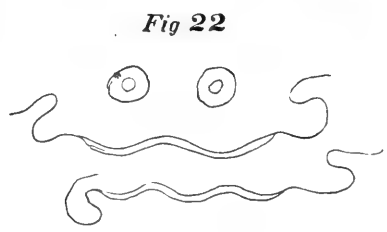
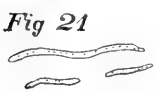
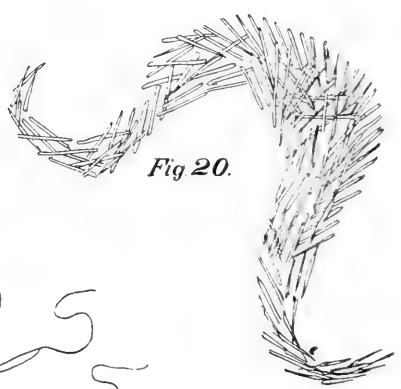
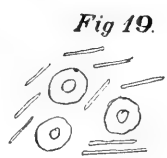
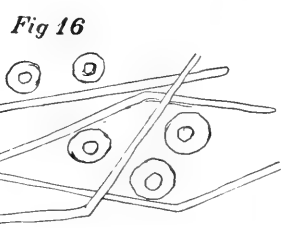
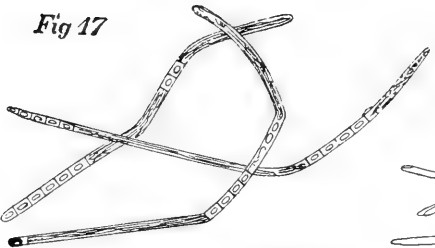
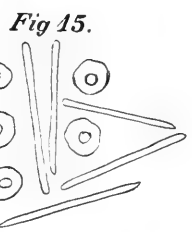
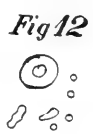
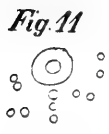
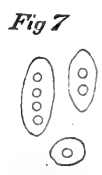
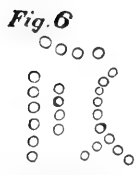
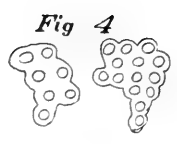
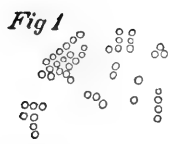

BACTERIA.

THE AMERICAN MONTHLY MICROSCOPICAL JOURNAL

VOL. X.

MAY, 1889.

No. 5.

All communications for this Journal, whether relating to business or to editorial matters, and all books, pamphlets, exchanges, etc., should be addressed to American Monthly Microscopical Journal, Box 630, Washington, D. C.

European subscriptions may be sent directly to the above address accompanied by International Postal Order for \$1.15 per annum, or they may be sent to Messrs. Trübner & Co., 57 Ludgate Hill, London, or to Mr. W. P. Collins, 157 Great Portland street, London, accompanied by the yearly price of five shillings.

Contagious Diseases in Animals.*

BY PROFESSOR JAMES LAW,

ITHACA, N. Y.

The study of contagion to-day is essentially the study of the work of parasites, or minute living beings that subsist on other living beings. The contagious fevers of man and animals are now nearly all demonstrated to be the result of the propagation in the system of the most minute of these living beings, the bacteria. These, as found in the body, are the simplest of all vital organisms, being in the form of simple cells or filaments, straight, bent, or spiral, though they do grow into other forms in different cases when removed from the animal economy. To give an idea of their extreme minuteness, I may say that if 15,000 of the *Bacterium termo* were placed end to end they would form a chain

DESCRIPTION OF THE PLATE.

- | | |
|--|--|
| Fig. 1. Micrococcus vaccinæ (cow-pox). | Fig. 12. Micrococcus of rinderpest (Russian cattle plague) and blood globules. |
| " 2. Streptococcus (spherical bacteria in a chain). | " 13. Diplococcus of swine plague. |
| " 3. Diplococcus (spherical bacteria in pairs). | " 14. Bacillus of swine plague. |
| " 4. Staphylococcus (spherical bacteria in groups or clusters) | " 15. Bacillus anthracis (from blood of infected guinea pig) and blood globules. |
| " 5. Macrooccus monas (large spherical bacterium). | " 16. Bacillus anthracis (after three hours cultivation in broth) and blood globules. |
| " 6. Micrococcus ureæ (infecting inflammation of bladder). | " 17. Bacillus anthracis forming spores. |
| " 7. Pneumococcus (bacteria of lobular inflammation of the lungs). | " 18. Bacillus from septicæmia in mouse (two species, large and small) and blood globules. |
| " 8. Micrococcus pasteurii (septicæmia in rabbit from inoculation with saliva of man). | " 19. Bacillus tuberculosis and blood globules. |
| " 9. Micrococcus of fowl cholera and oval blood globules. | " 20. Bacillus tuberculosis, in sigmoid colony, from kidney. |
| " 10. Bacterium termo (of ordinary putrefaction). | " 21. Vibrio. |
| " 11. Micrococcus of lung plague of cattle (contagious pleuro-pneumonia) and blood globules. | " 22. Spirillum of "surra" (equine relapsing fever) and blood globules. |

This plate has been kindly loaned by Mr. J. S. Woodward, Secretary of the Society.

* From Transactions of the N. Y. State Agricultural Society.

extending about exactly one inch. On the table they are mainly shown in company with the red blood globules so that their relative size may be appreciated. The blood globules are individually about $\frac{1}{32000}$ of an inch in diameter.

Bacteria, like other living beings, perform all the functions of organic life; they feed, excrete, multiply their numbers, and produce elaborate chemical products, in many cases of a highly poisonous nature. Those living in free air, and feeding upon carbo-hydrates, produce, as a rule, little or no elaborately poisonous products; those living in confined spaces apart from air, and feeding upon flesh-forming or nitrogenous compounds, tend to produce poisons more or less deadly. These are the bacteria that are fitted to live in the animal body, to poison it and to create diseases of a contagious nature. Then, again, different bacteria require for their active life different amounts of air, heat, light, and electricity, and if these are widely different from those found in the animal body, they cannot live in that body and become a contagion. Others require special chemical conditions of their food, and if they cannot find these in the animal body, they cannot fix themselves upon it as parasites. As an example, most of animal juices are alkaline or neutral, and can only maintain bacteria that normally live in alkaline or neutral solutions. If a germ requiring an acid liquid is introduced, it can only survive in the acid contents of the stomach or large intestines, or in the acid secretions of the skin or open sores. For the same reason the alkaline-feeding bacteria, if taken with food, are, to a large extent, destroyed in passing through the acid stomach, which thus acts as a protective sentinel, keeping guard over the intestinal canal. It is only during disease of the stomach, or in the absence of its acid contents, that these bacteria pass in scatheless. When, however, the bacteria have formed spores, these, like dried seeds, may safely pass through the acid stomach and germinate in the intestine.

Again, bacteria are the common scavengers of the universe. We have long known that plants and animals reciprocate with each other in producing each the food required by the other. Plants take up simple soluble and gaseous materials and build them up into complex compounds fit for the food of animals. Animals, on their part, break down these complex compounds, and furnish them again to the plants in the simple forms available for their food. In the case of carbon dioxide, ammonia, and some other forms this is true, but after this there is still a large body of animal products that are not soluble in water and not available for plant food. Those it is the function of the bacteria to transform and prepare. They are the cooks of the vegetable creation. Every fermenting manure heap, every rotting vegetable and animal, is a great kitchen in which this preparation of vegetable food is going on. But for the constant beneficent work of the bacteria the world would soon be choked up with the undecomposed remains of plants and animals, and vegetable and animal life must alike perish. They are at once the scavengers, caterers, and cooks of nature, then, and as no living beings are so widely distributed, so no living beings are more beneficent in their work. When covered or preserved foods fail to keep it is because we have failed to kill all the bacteria; when we make bread, beer, wine, sauerkraut, and other common products, we harness these infinitesimal beings and employ them for our uses.

This much it is only fair to say for these most minute but much dreaded beings—taking them all in all, they do far more good than harm. It is only a few that can enter the animal body, feed upon its elements, and produce disease. On these I would make one or two remarks.

Bacteria that grow apart from free air, in nitrogenous material, having an alkaline reaction, can in some cases attack the animal system and live on it. They seem to do this mainly by virtue of two of their products: First, a poisonous vegetable alkaloid; and, second, a soluble ferment or solvent of the material making up the animal tissues.

The primary attack comes from the poisonous alkaloid, which lowers or destroys the vitality of the cells of the lymph, blood, or tissues, so that they can no longer resist the chemical action of the ferment. The second assault is made by the ferment in dissolving the animal cells and tissues, and rendering them up in this condition as food for the living bacterium.

It should be noted here that the living corpuscles of the blood and the living cells of the animal tissues are also endowed with power to produce a ferment or digesting principle, which is also deodorizing and disinfectant, and which can safely dispose of any very small amount of bacteria poison introduced. When the virus is introduced there is at once set up a contest between the bacteria and their products on the one hand, and the animal cells and their products on the other, and, as in other contests, the stronger or the most advantageously situated prevails.

But the animal cells can acquire a power of resistance to alkaloid and other poisons, and thereafter resist any moderate dose. Thus many of you have acquired a comparative immunity from the poisonous action of nicotine, the deadly alkaloid of tobacco; and other men have acquired immunity as regards alcohol, opium, ether, chloral, arsenic, or other poison. This immunity is acquired by accustoming the animal cells to bear the poison in question, and this is the explanation of the fact that many contagious diseases will not readily occur a second time in the same individual.

As regards the reproduction of bacteria, many of them can double their numbers every hour when placed in the best conditions for their activity. In such circumstances, then, a single bacterium would in twenty-four hours produce no less than 16,777,220. At the end of forty-eight hours the offspring would amount to 281,500,000,000, and would fill a half-pint measure—all produced in two days from a single germ measuring $\frac{1}{15000}$ of an inch in length. The figures are easily tested. It is the old story of selling the horse at a cent for the first nail in his shoe, two cents for the second, and so on, doubling the value each time to the thirty-second nail. Whoever has worked out this problem will not be surprised at this marvellous increase in the bacteria.

Fortunately, however, bacteria can rarely so propagate themselves: they meet with all sorts of drawbacks, and thus, in spite of their enormous fertility, the survivors are, in a general way, only enough to keep up a fair balance in nature. The disease-producing bacteria, however, have no such claim upon our forbearance, and in these the enormous fecundity is a fact that we cannot too closely contemplate. Some, like the bacillus of tuberculosis and glanders, propagate themselves slowly; but the great majority of the bacteria causing animal plagues will, in

favorable circumstances, double their numbers hourly, so that you can judge for yourselves whether it is best to preserve infected animals, the systems of which are the spheres of this extraordinary fecundity of poison, or to obliterate the system, the poison, and the rapidly growing danger at one blow. It is manifest that the limits naturally set to the propagation and increase of one of these plague-bacteria are only set by the number of animals that are susceptible to its attacks and within its reach. The greater, therefore, our live-stock possessions of a genus receptive of a given poison, and the more the material wealth of this kind at stake, the more rapid is the spread of the infection and the greater the national loss.

It also follows, without saying it, that a specific plague-bacterium, unknown on this continent for the centuries since its discovery, and finally imported from abroad, should be stamped out remorselessly, and at once, whatever the temporary inconvenience and outlay. We have heard that the only way to root out thistles is to draw off the coat and eradicate them one by one by sheer manual labor. But no amount of labor nor effort which the individual man can apply can root out these *bacteridean weeds* that average only $\frac{1}{1,500,000}$ of an inch in length, that can only be seen under the highest available powers of the microscope, and then only after they have been deeply dyed with some bright pigment.

Following is a partial list of the disease-producing bacteria of the farm animals, which give some idea of the extent of this great subject. This is, however, only the beginning of the animal plagues caused by parasites. The fungi and animal parasites are responsible for a long list beside.

DISEASE-PRODUCING BACTERIA.

1st. *Micrococcus*.—Round or ovoid cell.

- M. of cow-pox and horse-pox.
- M. of sheep-pox.
- M. of cystitis.
- M. of erysipelas.
- M. of ulcerative endocarditis.
- M. of osteo-myelitis.
- M. of lobular pneumonia (horse).
- M. of lung plague (cattle).
- M. of influenza.
- M. of suppuration.
- M. of septic wounds.
- M. of gangrenous wounds.
- M. of fowl cholera.
- M. of diphtheria.
- Diplococcus of swine plague.
- Sarcina of the stomach.
- Sarcina of the urine.

2d. *Bacterium*.—Short rod.

- B. of blue cream.
- B. of yellow cream.
- B. of red cream.

3d. *Leptothrix*.—Chain of very fine cells.

- L. of mouth and carious teeth.
- L. of abortion (cattle).

- 4th. *Bacillus*.—Fine filament, straight or bent.
B. of anthrax.
B. of malignant œdema (horse).
B. of glanders.
B. of tuberculosis.
B. of septicæmia.
B. of swine plague.
B. of carious teeth.
B. of leprosy.
- 5th. *Vibrio*.—Wavy, flexible filament.
V. of emphysematous anthrax (black-leg).
V. of septicæmia.
V. of cholera (comma bacillus).
- 6th. *Spirillum*.—Spiral, rigid filament.
S. of relapsing fever (horse).
S. of milk-sickness.
S. of gums and teeth (spirochæte cohni).

Actinomycosis.*

By C. T. CALDWELL, M. D.,
WASHINGTON, D. C.

It is only within a few years that attention has been called to the disease which bears this name, or more correctly speaking to its true character, as distinct from osteo-sarcoma, with which it was confounded, until Bollinger in 1877 studied the disease in cattle, and for the first time described the fungus and made known the nature and cause of the malady.

The disease appears to be far more common in cattle than in other animals, and begins usually in the alveolar processes of the jaw, where it may first be detected by the presence of small nodular growths from the size of a pea to that of a walnut. These growths may be few or many in number. They have a tendency to spread or increase in size until they coalesce and form large hard tumors attached to the bone. This appearance led to the supposition that the disease was a form of osteo-sarcoma and was supposed to affect no other part than the jaw and no other than the bovine species. Its presence in other parts of the body and in other animals has since been frequently shown, although cattle and pigs seem to suffer most, and the jaw is the starting-point in a great majority of cases. Its appearance in man is rare. The number of recorded cases from 1878, when the first case was reported, up to 1885 had not exceeded 20 in all, most of these happening in Europe, no case having been reported in the United States up to that time. During the past three years, however, a larger number of cases have been found, until now the recorded cases number about 100 all told, of which a few have occurred in this country.

With this brief sketch of its history let us look a little deeper into the subject and study more closely by the aid of our microscope the parasite which is the cause of this disease, ascertain if possible its nature.

* Read at the 86th meeting of the Washington Microscopical Society.

mode of introduction into the system, and growth, and the pathological changes resulting from its presence.

If we take a part of the tumor we have mentioned or a piece of tissue adjacent thereto, we find on examination small round bodies lying either singly or in groups or clusters.

One of these bodies we will proceed to examine with the microscope and describe. Occupying the centre of the mass we find a thready fungus, the filaments being similar to the ordinary mycelium. These threads have a single bulb-like termination or may branch in various directions, each branch being tipped with a similar enlargement at its extremity. Some filaments present bead-like enlargements.

These filaments appear to be attached to the centre of the growth, from which they radiate, as shown in the complete fungus, giving the entire mass the appearance which has led to the name of actinomyces or ray-fungus.

Surrounding some of these masses of fungus, and in fact all the larger and older ones, we find evidences of inflammation set up by the presence of this foreign body. We have a dense layer of granulation tissue with some epithelioid cells and bands of fibrous tissue, but the giant cells and capsule described by some observers I have not seen. In some of the smallest deposits this appearance is wanting, the deposit being seemingly a recent event, and the inflammatory process not yet begun.

From this last observation we are led to conclude (and this corresponds to the facts observed in the history of recorded cases) that this fungus causes inflammation and the deposit of granulation tissue, which mass is prone to undergo degeneration, giving rise to suppuration in the surrounding tissues, the small seed-like masses of the fungus being found in the pus escaping from abscesses thus formed. These small particles may be seen with the unaided eye and felt with the fingers, being of a yellowish color, about the size of millet seed, and of a cheesy or greasy feel.

The questions now arise, Where does this fungus come from, and how does it gain admission into the system? Of the first it is sufficient to say that the source of supply is not known. The fungus so far has not been found outside the body of animals. It is probable, however, that it does exist attached to vegetable matter which is used for food by man and herbivorous animals, as the carnivorous animals are said to be exempt from its unfriendly visitations. From the fact that it usually attacks the jaw and finds an entrance into the system through abrasions of the mouth, carious teeth or the extraction of teeth, it has been supposed that when taken into the stomach the fungus is destroyed by the action of gastric juice, but if arrested in the buccal cavity and finding an entrance to and lodgment in the teeth or jaw, it rapidly grows and spreads by burrowing into neighboring tissues or by embolism to distant parts of the body. There are, however, cases which cannot be accounted for in this way. Where the fungus has appeared as a primary deposit in kidneys, lungs, and even the brain, in such cases it is supposed that a minute particle of the fungus was taken into the lungs during inspiration, and gaining an entrance into the blood was carried to a distant organ, where it grew and developed, and caused the pathological changes which brought about its discovery in these unusual locations.

Once implanted in the tissues there seems to be no means of arresting its ravages, for although much of it is carried off in pus, there is always an increase, as the invasion of new tissue by the fungus is constantly going on in advance of the suppuration, which seems to be the only means of getting rid of it, and this through caries of bones and multiple abscesses ends only in the death of the unfortunate victim. I will quote from the Annual of the Universal Medical Sciences, 1888, vol. i. a report of one case of primary actinomycosis of the brain :

“ Bollinger, of Munich, reports the case, which he considers unique (the only one out of 89 cases of actinomycosis in man) : Female, age 26 years, complained of headache one year before death. A month later temporary paralysis of the left abducens. Eight months later, attacks of headache, diplopia, difficult speech, choked disks ; occasionally loss of consciousness. Temporary amelioration. Death after headache, vomiting and coma. Autopsy showed a tumor, size of a walnut, in the third ventricle, apparently developed from its choroid plexus. The surface was smooth, and its color pale yellowish-gray. There was internal hydrocephalus. Microscopic examination revealed the usual appearances of actinomycotic masses. The author thinks it probable that the germs were absorbed with raw goats' and cows' milk, which the patient was in the habit of drinking largely ; from the intestinal tract it had reached the brain by embolism, through unknown channels. Only three cases of actinomycosis have been thus far observed in Bavaria.”

The disease is infectious, as not only will inoculations with pieces of the tissue or pus containing the fungus cause the disease, but cultivations have produced the same result.

The disease has been found in the cavities of carious teeth, in the tonsils, and as a secondary deposit even in the cavities of the heart. The exact nature and botanical position of the fungus are in doubt ; it may be the conidia form of some known species. For the slides containing the fungus that I have here to-night I am indebted to Dr. I. W. Blackburn, special pathologist of the Government Hospital for the Insane in this city, and vice-president of this Society. The sections are four in number, and in reply to my inquiries as to when and where the case occurred, the tissue used in making the sections, and how prepared, he informs me as follows :

“ The specimen of actinomycosis was found by our house steward on inspecting some beef bought of one of the great “ *dressed beef* ” companies of our city for the use of the hospital. He rejected the piece and brought it to me for examination. I found it to be the so-called “ *knee-joint* ” of the fore-quarter, which was pretty extensively diseased. The butcher had removed some of the diseased tissue, but quite a mass yet remained. I recognized it by the naked eye, by the presence of the minute masses of fungus scattered through the tissue, and confirmed the diagnosis by the hastily prepared specimens I was obliged to give you.

“ This is all the history I can give you of the case, I am sorry to say. It shows the care with which all dressed meats should be examined, though probably if *well cooked* actinomyces would be palatable and nutritious, and possibly perfectly safe.”

These slides were not prepared with any special process for bringing out their structure, but the following note may serve to show how this may be done :

A. Baranski uses picro-carmin for staining fresh preparations of actinomyces bovis. A small amount of the contents of a yellow nodule or pus from the part is spread in a thin layer on a cover-glass, and dried in the air. The cover is then passed three times through the flame, care being taken not to overheat the preparation. It is then floated in the picro-carmin solution, or a few drops of the stain are placed on the cover. In two or three minutes the staining is finished. The cover is then carefully washed by agitating it in water or alcohol, and examined in water or glycerine. The actinomyces takes a yellow color, while the remaining structure appears red. In this way not only the actinomyces tufts are easily distinguished, but single nodes which are found scattered about in the preparation are sharply defined from the surrounding red mass. For permanent preparations, the cover-glass should be dried before mounting in balsam. Sections of tissue are handled as usual, and are mounted either in glycerine or balsam.*

References (none prior to 1880).

Green's Pathology and Medical Anatomy, pp. 293-95.

Reference Hand-book of the Medical Sciences, vol. 1, pp. 70-71.

Annual of the Universal Medical Sciences, 1888, vol. i, p. 71; vol. v, p. 377.

Papers by Dr. A. J. Ochsner: Chicago Med. Journal, 1886, vol. liii, No. 6, pp. 1-3; Journal Amer. Med. Assn., 1886, No. 7, pp. 608-10. Dr. Skerrit: Am. Journal Med. Science, Phil., 1887, N. S., 93, pp. 75-88. Dr. T. Bilroth: Ala. Med. and Surg. Journal, 1887, vol. ii, pp. 321-29; and a paper on Primary Abdominal Actinomycosis, N. Y. Med. Journal, vol. xlv, p. 297.

Examining a Shellbark Hickory Bud.

By DR. HENRY SHIMER,

MOUNT CARROLL, ILL.

Cut a longitudinal section near the middle. (A somewhat thick section, $\frac{1}{100}$ to $\frac{1}{300}$ in., is easily cut.) Transfer it to a slide, apply glycerine with a brush; after it has pretty well soaked, drain off the superfluous fluid, warm the slide, apply glycerine-jelly, or better, my new mounting formula: glycerine-jelly, 1 part, Farrant's medium, 1 part, glycerine, 1 part, thoroughly mixed. Apply a heavy cover-glass, press it down a little, at length seal the edges with cement, and the result is a very beautiful specimen permanently mounted.

Examine it with a 1-inch objective, the stand being in the sunshine with a piece of sky-blue blotting paper over the mirror for a background, and we have a more beautiful and instructive specimen than a $\frac{1}{1000}$ inch section made in celloidin. The arrangement of the leaves and the hairs are all that could be desired. Even the cellular structure can be studied. This process is given, not to supersede other fine methods, but only as an easy method to aid in the study of a beautiful bud. If it is a side bud it will show the origin of the bud in the side of the limb and its progress to the surface.

* The discussion upon this paper will be found in the report of the Washington Microscopical Society page 119.

Economic Value of Bacteriology.*

By B. M. BOLTON, M. D.

PROFESSOR OF PHYSIOLOGY, HYGIENE AND BACTERIOLOGY IN THE UNIVERSITY OF SOUTH CAROLINA.

In what way have the results of bacteriological investigations been applied to matters of every-day life, and what can we expect from them in the future? Of course it is interesting, scientifically, to know that infectious diseases, decomposition and fermentation are caused by minute plants, and even if we could make no application of our knowledge, the satisfaction of studying these facts amply rewards the student. But aside from purely scientific interest, it is evidently of great use in matters of common every-day life. In the first place, the benefit that has been derived to the husbandman has been very great. After Cagniard, Latour and Schwann established the fact that fermentation is due to micro-organisms, Pasteur devoted himself to the study of this phenomenon, and his results have saved the French people many thousands of dollars. He found that the so-called diseases of wine are due to bacteria. The souring of wine and the bitter taste which formerly caused great loss to the wine-growers of France are no longer met with, for by heating the wine so as to kill the bacteria and then sealing it up it does not sour or turn bitter. The silk industry of France is equally indebted to Pasteur. He discovered the remedy for an infectious disease which threatened to break up silk growing. Pasteur also found that by the use of pure yeast the fermentation of beer, the success of which was largely a matter of chance, renders it possible for the brewers to rely upon their results. Although Pasteur's method is a great improvement upon the old method of brewing, it has not found as universal application as that introduced by Hansen. In Holland and Germany the brewers all use Hansen's yeast, which means that they use pure cultures of yeast fungus, which Hansen and others found to make the best sort of beer. Instead of the uncertainty attending the manufacture of beer, which was formerly a source of great loss to the brewers, they have no uneasiness upon this score at the present day. Impure yeast causes beer to have a disagreeable taste.

Bacteriological investigation has therefore been of advantage to the wine, beer and silk industries, but the benefit in the prevention of infectious diseases is still greater. It is not so much in the treatment of each individual case, though even here much good has resulted, but in the prevention of the spread of disease that the advantage is incalculable. If an animal becomes sick, the bacteriologist can say, in many cases, positively whether it is an infectious disease or not, and can isolate the sick animal, so preventing the spread of the disease. It is of great importance to diagnose the first case. Some of you, doubtless, remember reading of several cases of cholera which occurred on board a vessel in the port of New York about a year ago. A bacteriologist was immediately sent for and declared the disease to be genuine Asiatic cholera, and thus prevented the patients from being allowed to infect other persons. The German government recognize the importance of diagnosing the first case to such an extent that they required a number of marine and army surgeons to go to Berlin and receive instruction from Koch in his methods for studying the cholera bacterium.

* From a report of the Department of Agriculture of South Carolina.

The greatest benefit which has been derived from bacteriology is probably in the prevention and treatment of boils, abscesses and wounds. All boils and suppurating wounds which are ordinarily met with are caused by certain sorts of bacteria. It seems to be true that certain chemical substances under peculiar circumstances also cause suppuration but in every-day life the pus which the surgeon or physician meets with is caused by bacteria. If now a substance is known which kills these bacteria and at the same time does no injury itself, then there will be very little trouble in avoiding suppuration, as it is called. In the old days of surgery, it used to be thought necessary to have a lot of matter come from a wound, but now-a-days it is a disgrace to any surgeon to have suppuration under ordinary circumstances. All sorts of operations, from cutting off a toe or finger up to cutting out the breast or a hole in the abdomen, are now performed, and in no case well managed is there more than a few drops of pus. Sir Joseph Lister was the first to attempt what is called aseptic or antiseptic surgery. He used very successfully carbolic acid to wash out the wounds he made and then bandaged them with many layers of carbolized gauze and cotton batting. But Koch found out that corrosive sublimate, even in very weak solutions, is much better for killing bacteria, or in other words, is a better antiseptic than carbolic acid. So at the present day corrosive sublimate plays the main part in the treatment of all sorts of wounds and abscesses. If a boil is just started, it can be aborted by injecting corrosive sublimate into it. If an abscess is fully formed, it can be rapidly cured by using solutions of corrosive sublimate.

Where surgeons have kept up with the advances in medicine in this respect there is a great deal less suffering and fewer deaths. In the best hospitals there are no longer such scourges as blood poisoning, lock-jaw, etc. So the study of bacteriology has been of incalculable benefit if we consider this point alone. Since the introduction of antiseptic surgery lock-jaw never occurs from an operation in the hands of those surgeons who keep abreast with the times. Lock-jaw of new-born infants has been banished where the proper use of aseptics is resorted to. If a new-born infant dies of lock-jaw at the present day, the attending physician is entirely to blame. These precautions are much more easily carried out in a hospital, and it would be much better to have hospitals in America as they have in Europe, so that our dwelling-houses would no longer be infected with disease and where the surgeon could do his work properly.

Although many important processes and many terrible diseases are caused by bacteria, still we are able to control their action to a large extent, making them do useful work on the one hand, and preventing their injurious effects on the other. I have stated that by the introduction of corrosive sublimate solution in the treatment of wounds the surgeon is enabled to perform the most serious operations with absolute certainty that he will not produce gangrene, blood poisoning or even suppuration. But the use of disinfectants, as they are called, is not only beneficial in surgery but in other cases as well. And although corrosive sublimate is the best disinfectant known, it cannot always be applied. In some cases it is better to use steam.

In many cities in Germany they have large steamers constructed so as to subject clothing, bedding, etc., which have been used by persons suffering from small-pox or other infectious diseases, to steaming.

This use of steam as a disinfectant is of great use, and in most cases does no damage whatever to clothes, etc. As soon as the articles are removed from the steamer they are spread out and dry of themselves almost immediately. Such articles as feather beds are dried in an oven built for the purpose. Leather is ruined by steaming, but shoes and other articles made of leather are not injured by corrosive sublimate. In the hospitals in Berlin, in Germany, the clothing and everything else used by a person suffering from an infectious disease are either sterilized by steam or with corrosive sublimate; and the expensive process of burning up infected clothing, etc., is no longer resorted to.

Many other applications of bacteriology to affairs of every-day life might be enumerated, but these incidents are enough to show that this study has already assumed very great importance. It is not going too far to say that the benefit which has been derived and the possible advantages in the future can scarcely be over-estimated. Men of all nationalities are flocking to Germany every year for the purpose of studying bacteria, so great has the importance of this branch become. It was predicted at first that this noise about bacteria would soon die out; that it would be found out that their importance was greatly exaggerated. Just the opposite is the case. Instead of interest lagging, the more bacteria are studied the more important they appear.

Although we are indebted to Pasteur for much valuable work, and his opinion is of the greatest worth, he has probably gone a step too far in his preventive inoculations. He has established the fact that it is possible to vaccinate for certain diseases and render the animal so vaccinated immune, but the methods are not perfect enough as yet to allow of introduction into general use. It is to be hoped that such will finally be the case, but at present it is a matter of purely scientific value. The time may come when we shall be able to vaccinate for malignant pustule, chicken cholera, swine plague, etc., just as we vaccinate for small-pox now-a-days, but in some cases, at least, it is questionable whether this will ever be accomplished. Of course much the best way to guard against infectious diseases is to get rid of the cause of infection, and the study of bacteria has given us valuable means with which to accomplish this end. It has already been stated that Koch has found corrosive sublimate a very potent disinfectant. Now, how would we apply this in case of an epidemic? Suppose an epidemic of chicken cholera were to break out. As we know of no trustworthy means of curing the disease, we should try to limit it as much as possible. In the first place, the fowls should be confined in the chicken house where this is feasible, and every few days the walls and floor should be scoured with lye and then wiped out with a solution of corrosive sublimate. The sublimate should be allowed to remain several hours, and the walls and floor again scoured with lye or soap. The corrosive sublimate solution need not be stronger than 60 grains or 1 dram to the gallon of water. This is a very weak solution, but of course it must not be left carelessly around so that any one would be likely to drink any of it, as it is a deadly poison. It has been recommended to color the solution with a small quantity of some cheap dye stuff, so that it would not be mistaken for water. It would be better to have two hen houses, to disinfect them with the corrosive sublimate solution and transfer the fowls every few days from one to the other, disinfecting every time as soon as the

fowls are removed in the manner already described. Our hen houses and stables should be so constructed that they could be wiped over with a solution of corrosive sublimate and leave no corners unwiped. There should be no sharp corners where dust can accumulate and which are difficult to reach. If, in spite of disinfection, the fowls all die, the house should be thoroughly scoured with soap and water and corrosive sublimate solution applied liberally and allowed to remain a day or so, and again scoured and again disinfected several times before other fowls are allowed to go in. If the yard is also infected, it should be liberally doused with freshly slaked lime. It would be more effectual to use corrosive sublimate even for disinfecting the yard, but that would hardly be advisable. Freshly slaked lime is a good disinfectant, but it must be applied to every part of the yard. The fences and ground in every nook and corner should receive a thorough drenching. Not only in chicken cholera, but in other infectious diseases the same means should be used.

The fact has been mentioned that lock-jaw does not occur any more after surgical operations. If the wounds in animals are treated at once with corrosive sublimate or strong carbolic acid, there need be no fear of lock-jaw. If a horse has run a nail in his foot, the wound should be thoroughly washed out with a strong solution of corrosive sublimate and stopped up with a plug of cotton soaked in corrosive sublimate solution. The bacteria of lock-jaw are very wide-spread. They have been found in garden earth, upon splinters of dirty wood, in old rags and in the dust of rooms.

Consider now the part played by bacteria in decomposition. As you already know, the chief supply of food for the higher plants is furnished by decomposed animal and vegetable matter. The higher plants cannot make use of elaborate food—they can only assimilate such simple bodies as the nitrates, etc. Complicated substances, such as animal and vegetable matter, must be broken up before they can serve as food. Now these complicated substances are just the things which form the best food for bacteria, and bacteria decompose them so that the higher plants can use them as food. It is, therefore, evident that bacteria are necessary to the higher plants, and without them there would soon be no life upon the earth, for animals are all ultimately dependent for food upon plants. So bacteria prepare the food for the higher plants, the higher plants supply food to animals, and animals and plants supply food to the bacteria. For the sake of illustration, take the nitrogen found in various albuminous substances. It amounts to 16 or 18 per cent. in different cases, but as long as it is contained in the albumen it is useless to the higher plants. The bacteria feed upon these albuminous substances and liberate the nitrogen in the form of ammonia and nitric acid, the only compounds of nitrogen which the higher plants are capable of using. The higher plants require nitrogen in the form of these two compounds. Now here is a formula: $C_{17}H_{33}No_3$, showing that this substance called *cerebrin* contains nitrogen, but the nitrogen is held so closely by the C, H and O that the higher plant could not use it at all if it were not liberated. Nitrogen is used merely as an example. What is said applies equally well to other substances besides. Thus the mineral salts are also liberated from complicated compounds by bacteria.

Now, if decomposition is caused by bacteria it is important to find out whether all bacteria cause it or whether there are only certain kinds which do so. Also, whether they do so under all circumstances. It has been discovered that all sorts of bacteria do not produce decomposition, at least, not entire decomposition, and those which do require certain conditions. Prof. Wollny states that those bacteria which are concerned in the process of decomposition require abundance of air and moisture, and also warmth. Applying this knowledge to every-day life, we see it is necessary to keep vegetable and animal matter moist and warm and allow abundance of air to prepare it as a fertilizer. It follows that if your compost heap is too dry it will not decompose, and if it is too cold it decomposes very slowly. If the compost heap is too wet it will not thoroughly decompose for reasons to be given presently. For the same reason, crops which are turned under have to be kept moist and warm and allowed to have plenty of air. Of course the exact preparation of the compost of the soils which are turned under must be varied to suit each case. If soil is sandy, the crop should be turned thoroughly under and the earth above it rolled so as to retain as much moisture and heat as possible. With clay land of course the opposite course is indicated. Again, if a compost pile is too much packed to allow access of air, it should be opened up; at the same time it must not be too loose, otherwise it will dry out too much and lose heat.

So we have to bear in mind that the bacteria which prepare the food for our crops will only do so when they have the conditions favorable to their growth. If the conditions are unfavorable they either do their work imperfectly, or they are supplanted by other bacteria which split up vegetable and animal matter into substances which are for the most part of no use to plants as food. This takes place when the air is partially or wholly cut off. If a crop is turned under and the air is not allowed free access there will be very little benefit derived, and in some cases even injury to the soil may result. It can readily happen in a clay soil that the earth may become so packed that the air is excluded. Even in a sandy soil the pores may become so clogged with water that the air is kept out.

Pasteur first called attention to the fact that there are two kinds of bacteria, one not requiring free access of air, and the other unable to grow in full oxygen. To repeat: those which require the presence of free oxygen cause decomposition, and those growing without oxygen cause only partial decomposition.

But besides the influence exerted by the presence or absence of oxygen there are other things which influence the growth of bacteria. Certain metallic salts interfere with it. The concentrated solutions of common salt act in this way. Corrosive sublimate, which is a salt of mercury, even in very dilute solutions kills bacteria. The same is true, to a greater or less extent, of mineral acids or other substances.

So a soil must not only have abundance of moisture, warmth, and air, but it must also be free from substances injurious to bacteria. This can be tested even without a chemical analysis, by simply taking cultures derived from the soil, and seeing whether the bacteria from them grow in the soil to be examined. This is a more direct test than a chemical examination.

Not only do these principles underlie the process of decomposition,

but they also find application in the opposite direction, namely, in preserving perishable articles from becoming decomposed. Meats, vegetables, and fruits are kept from spoiling in various ways.

1. They can be heated up to a temperature which kills the bacteria, and then sealed up so as to prevent any bacteria from getting in. This method is employed in the ordinary process of canning. The meats, vegetables, or fruits are put into cans, which are then heated up to the boiling point of water or higher, and then sealed up. In actual practice the cans containing the meats or other contents are nearly sealed before they are heated, all except a small opening in one end, which is closed with a drop of solder after the cans have been heated long enough to kill the bacteria. But instead of sealing the substances up in cans they can be preserved by stopping up the vessel containing them with cotton, as with a tube of nutrient agar. Most bacteria are killed by a temperature much below the boiling point of water. Still, certain sorts of bacteria have the power of forming so-called spores which are very resistant. It has been recently discovered that there are several kinds of bacteria in the ground which form spores so resistant that they can be boiled several hours without being killed.

2. Meats, vegetables, etc., are also preserved by drying. This needs no further explanation, for moisture is essential to the growth of micro-organisms.

3. The addition of certain substances which are injurious to bacteria is also often employed. Concentrated solutions of salt, that is to say, brine, prevents the growth of bacteria. Other substances, such as salicylic acid, copperas and a great number of other things either kill bacteria or prevent their growth, and consequently may be used as preservatives. The most effectual of all is corrosive sublimate. The great objection to this method of preserving substances for food is that most of the germicides, as they are called, are injurious to health, and many of them are very poisonous. Of course this objection does not hold in the case of brine.

4. Articles are preserved on ice, but generally for a short time only, as this is an expensive method. It is hardly worth while to explain the principle of this method, that bacteria require warmth in order to grow. The study of bacteria has thus led to a clearer understanding of the way in which the food is prepared for the higher plants on the one hand, and the preservation of perishable articles on the other. It has led to the prevention of many infectious diseases of animals and plants and an improvement in wine making and brewing.

The Botanical Preparations of Walter White.

By CHAS. W. SMILEY.

Though not pretending to take the place of objects mounted in the usual way, yet, being enclosed in a transparent envelope, they are available for immediate examination, either without or with magnification—in many cases even with the higher powers of the microscope.

Many of these preparations will be found figured in Strasburger's "Hand-book of Practical Botany," as well as in "Thome's Text-Book" and "Sach's Hand-book."

Strasburger says: "The study of vegetable structure is especially favorable as an initiation into the use of the microscope; and any one

whose future career will require command over this instrument should commence with the study under the microscope of vegetable anatomy."

The following items from the catalogue will give some idea of the objects prepared:

3. Orchid leaf. Fibro spiral cells.
4. Elder pith. Pitted parenchyma.
19. Yew. Isolated wood cells.
21. Cinchona bark. Thickened bast cells fusiform.
27. Brake fern. Scalariform vessels.
53. Pampas grass. Closed vesicular bundles.
59. Ivy. Resin cells.
73. Horse chestnut. Petiole. Sphæraphides.
75. Mistletoe. Thickened cuticle cells.
99. Eucalyptus. Oil glands in leaf.
134. Begonia. Axile placentation.
161. Wheat. Starch.

In many cases the objects have been stained, either singly or doubly, and some stained three years ago have not faded. Their very low cost commends them to every student of biology or collector of microscopic objects. The polariscope assists in bringing out the details of structure.

They may be mounted in either resinous media (damar, benzobalsam), or glycerine, or glycerine jelly, the former being the easier for a beginner to manage, while the latter, though more trouble, shows structure better. It is well to have the same object mounted in both ways.

Mr. White's instructions for mounting are as follows:

"Carefully separate the enclosing films, and remove the object. If for resinous media, soak in spirit of turpentine till clear, rinse in a fresh portion of the same, then drain, transfer to the cover or slide, and finish in the usual way. For glycerine: If the object be oily, first wash out the oil with strong methylated spirit till clear, transfer to a mixture of glycerine and water, equal parts, in which let it remain an hour or two, then mount.

"Minute objects, such as isolated cells, should be transferred on the point of a scalpel to a slide (or cover), and separated with a needle in a drop of spirit; then, if for glycerine, mount while still moist; but if for resinous media, allow to dry, then moisten with a drop of turpentine before applying the medium. Spiral and other vessels, and long fibre cells, which mat together, should be soaked in a drop of weak spirit, and a few of the most perfect picked out under a simple lens."

Professor Seaman was the first in this country to import samples of White's preparations. He tells us that he can recommend them without qualification. A Boston friend who sent for 10 as specimens immediately wrote back: "The preparations received are exceptionally good. I enclose \$5, for which select and send me a large assortment."

Another writer says: "The sections are much better than I looked for at the price. They are very good. Please send me 20 more."

The orders sent in during March and April twice exhausted our supply, but all have now been supplied. If any have failed to receive their quota they should make it known. Mr. White has been extremely gratified with the more than cordial reception his work has met with in America.

MEDICAL MICROSCOPY.*

The Etiology of Diphtheria.—A valuable paper with the above title, by Dr. Samuel N. Nelson, of Boston, appears in the *Jour. Am. Med. Ass'n* for April 6. The paper consists partly of citations of authorities and partly of records of experiments, both tending to prove the bacterial nature of diphtheritic contagion. There are still many who deny the contagiousness of diphtheria, and who would, of course, deny that its bacterium was discoverable. To such we commend a perusal of Dr. Nelson's paper, and particularly the part which records the following experiment:

Sterilized beef-bouillon was inoculated with pseudo-membrane from a child who died of diphtheria. The culture was carried to the sixth generation; guinea pigs were inoculated with the sixth culture, and the pigs developed diphtheria. Further, on the third day after dissecting the diseased pigs, the doctor himself was attacked with diphtheria.

The Structure of Dentine.—Mr. F. J. Bennett read a paper recently at the Odontological Society on "Certain Points connected with the Structure of Dentine." Mr. Bennett employed a new, and what may in future prove a valuable, method of decalcification, namely, by glycerine. The idea was suggested by some papers by Dr. Ord, in which it was shown that glass, mother of pearl, ivory, and other substances became slowly etched by immersing them in a solution of subcarbonate of potash in glycerine. Mr. Bennett applied this solution to the dental tissues, and in the course of experimentation was surprised to find that precisely the same results could be obtained by using glycerine alone, and thenceforward confined himself to the use of this reagent. His method of procedure was as follows: 1. Freshly-extracted teeth were ground and polished sufficiently thin to allow of microscopical examination; these were suspended in glycerine for periods of from one to six months, washed, and mounted in glycerine for examination. 2. Freshly-ground teeth were immersed whole in pure glycerine for similar periods, then ground, polished, and mounted as before. 3. Whole teeth were placed in extremely dilute solutions of glycerine, the strength of which was daily increased until pure glycerine was used; the specimens were then kept in this for one or two months. It is interesting to note that cementum which is poorest in inorganic matter is most readily acted on by glycerine. Thus treated, dentine, especially that portion nearest the pulp and that newly formed, shows very distinctly the outlines of the dentinal tubules, and the matrix, which is generally stated to be absolutely structureless, is apparently made up of superimposed layers of membranes, with a number of stellate cells. The tubules perforate these layers, and can be seen in some sections to communicate with or arise from the cells. In the discussion which ensued, Dr. Ord, referring to the cells, said he could not express an opinion until the specimens had been examined by polarized light to see whether the cells were organic spheroids or inorganic matter, suggesting that the appearances might be due to a rearrangement of the earthy matter.—*Lancet*, Jan., '89.

* This department is conducted by F. Blanchard, M. D.

BIOLOGICAL NOTES.*

Development of Macrospores of *Isoetis lacustris* L.—Prof. Vines, in a communication to the Royal Society of London, January 31, concerning *Isoetes* macrospores, says that the protoplasm contains large quantities of oil and starch, and is provided with a large nucleus, in which are imbedded certain bodies, which appear yellow in preparations stained with hematoxylin, but as to whose nature it is not at present possible to speak definitely. During germination hematoxylin fails to reveal the presence of a nucleus, and the cytoplasm at this period stains so uniformly and deeply that it is possible that the nuclear substance may be diffused through it. It is when stained thus deeply that the first indications of cell formation appear. The mass of protoplasm seems to be traversed by "cracks," which divide it into a few large and isolated parts, and it is in the direction of these cracks that the wall of the new cells first appears. Prof. Vines infers that the cracking of the protoplasm is due to changes which have already occurred in the protoplasm preparatory to the formation of cell-walls. After the formation of the cell-walls the nucleus again appears distinctly in each cell.

The effect of girdling a tree.—The *American Journal of Science* (vol. xxxvii, p. 79) cites from the *Canadian Record of Science* the account of a pine tree that has lived a number of years (probably 15) after having been completely girdled. The circumference of the tree above the girdling is 26.5 inches, while below it is only 19.5. While the cambium layer above the ring is in a perfectly normal condition, below it is dead for some inches. The foliage shows signs of decaying health.

Assimilation of chlorophyll-bearing cells.—Th. Bokomy of Erlangen is also reported (same citation) as having found that the assimilating cells of *spirogyra* are capable of assimilating methyl-aldehyde, methyl-alcohol, and glycerin. Formic aldehyde killed the protoplasm. This is of interest since, according to Baeyer's hypothesis, carbon dioxide, under the influence of chlorophyll acted on by sunlight, is converted into carbon monoxide, which takes up a molecule of water, converting it thereby into formic aldehyde, which, in the presence of free alkalies, can be changed at once to sugar.

Peripatus.—Mr. Arthur Dendy reports (*Nature*, v. xxxix, p. 366) a new species of *peripatus* found in Victoria. Mr. Adam Sedgwick, however, in a subsequent issue (p. 412) doubts the distinctness of this species on account of the great variation in the known species of this exceedingly interesting genus. Mr. S. reports *peripatus* also from Carisilis, New South Wales.

Deteriorated air.—M. Th. Schloesing, in a communication to the Paris Academy of Sciences, claims that the injurious effects of breathing exhaled air are not due to the presence of carbon dioxide, but to other substances given off by the lungs during respiration, and especially in the cases of person suffering from pulmonary diseases. Tests made by Brown Sequerd and d'Arsenal proved that air containing 20 per cent. of carbon dioxide can be breathed for one or two hours without any marked inconvenience or lasting consequences, whereas air exhaled from tuberculous lungs may prove fatal even in very small doses

*This department is conducted by Prof. J. H. Pillsbury.

to lower animals, in most cases producing death within twenty-four hours.

Cholera and drinking water.—F. G. McKean, chief engineer in the United States Navy, states that during ten days in 1885 nine hundred persons died of cholera on the island Takashima, in Japan, and that the disease often appears on the island. Suspicion was drawn to the drinking water, which was brought from the mainland. During 1888 the use of this water for drinking purposes was abandoned, and distilled water was used instead. Although cholera prevailed on the neighboring islands, Takashima was entirely exempt. This exemption may have been a coincidence; still, it is more than probable, from our knowledge of this disease, that the purity of the drinking water is to be credited with the immunity which the population of the island enjoyed. To be absolutely certain of this will, however, require more extended observation.—*Science*.

Rhizopods.—Dr. Max Werworn, of Berlin, gives in the *Zeitschrift für wissen. Zoölogie* (vol. xlvi, p. 455) a very valuable paper on the certain biological investigations upon several species of rhizopods. The first of these was to determine whether those forms which incorporate grains of sand into the ectosarc to form a shell-like covering are able to repair this covering when once it is injured. He became satisfied that they were not. Seeking to ascertain the origin of the cell revealed the fact that before the division of an individual particles of sand are taken into the protoplasm of the original individual to form the shell of the new individual. These tests were made upon *diffugia*.

Rhizopods that secrete a true shell he found able to repair the shell to a limited extent. When the protoplasm as well as the shell was divided into two portions, only one portion, and that the one containing the nucleus, was able to rebuild its shell, although the other portion seemed capable of performing all the other functions of life.

Agricultural Experiment Stations.—We are happy to note that valuable experiments are being undertaken by many of the stations established under the Hatch bill. We have already cited from at least one of them, and shall be glad to do so frequently if valuable biological facts are reported.

Diseases of Swine.—The Commissioner of Agriculture has appointed a commission, consisting of Professor William H. Welch, of Johns Hopkins University, Dr. E. O. Shakespere, of Philadelphia, and Professor T. J. Burrill, of the University of Illinois, to investigate the subject of swine diseases in the United States, and the methods of their treatment and prevention.

Water Supplies Again.—The North American Review for February, in its "notes and comments," gives some crisp points upon this subject, some of which are, to say the least, overstated, but many of which deserve consideration.

Botanical Laboratories.—The Botanical Gazette for January, in continuation of its articles upon this topic, has an illustrated article upon the Laboratory of the University of Pennsylvania.

Report upon the Postal Club Boxes—VI.

BY QUEEN MAB.

Box bd. One takes up the Cole Studies with a feeling of regret that their publication should have been suspended. The text of this box, "Lung of Duck" has no plate, and but a few words of written description. Speaking of the structure of birds it says that the bronchii do not subdivide with the minuteness seen in the mammals: "The lungs of birds are covered on their ventral surface only by the peritoneal membrane, many of the principal branches run right through the lungs and open into large delicate walled sacs in various positions among the viscera, and send tubular prolongations into many of the bones; thus reducing the specific gravity of the bird and facilitating flight."

No. 2 is the most interesting of the Cole Studies which have been circulated for a long time, and is a transverse section, between the suckers of the Liver Fluke, *Fasciola hepaticum*. This object has been selected because, for its size and low type of organization, it possesses a remarkably well developed and complex reproductive system, and enormous reproductive activity, and to practical agriculture especially as to its dispersion it has an important bearing. This fluke belongs to a class of trematode worms which are parasitic, have flat unsegmented bodies, and none of them exceed an inch or two in length. Its economic importance is derived from its casual relation to the liver rot in sheep, which has to so great an extent proved fatal. This same species has been found in man. Other species infest various animals, as oxen, horses, dogs, deer, etc. Apart from its reproductive system, which occupies nearly the whole of the body, the organization of this *Fasciola* is very simple. The lateral margins of the body and whole posterior portion are occupied by a pair of very ramified vitellaria or yolk glands. A smaller organ, the shell gland, secretes the yellow horny material with which the eggs are invested. The developmental cycle through which the embryo passes before it attains maturity is strange. The fluke presents the phenomena of alternate generation and heteræcism in a very complete form. Between the free egg and the vertebrate inhabiting adult fluke, a number of intermediate and dissimilar forms occur, and for the support of some of these an invertebrate host is essential. At least three generations are necessary to produce the original form. Something of this life history is as follows:

GENERATION A. 1. *The egg* is laid in an oval yellow horny case, by the egg gland. At one end a sinuous line marks out a portion which serves as an operculum, and is later cut off for the liberation of the embryo. A hundred or two flukes inhabit the bile ducts, distending them enormously, hundreds of thousands of eggs are laid by a single fluke, and as they are discharged they pass out of the bile duct into the intestine and thence with the faces out of the body. The development of the embryo with the proper temperature requires two or three months. When ready to emerge, the embryo among other investments is provided with cilia, which however do not move until the shell is burst.

2. *Free embryo.* By a vigorous extension of its body the embryo throws off the operculum, and on contact with water on the damp grass the cilia begin to move and the embryo swims about actively. An intermediate host now becomes necessary, else the embryo soon dies. A small semi-aquatic snail, *Lymnæus truncatulus*, has been found to be

the intermediate host. If the embryo encounters one of these snails it presses its sharp head papilla against some part of the snail's body, and then spinning rapidly on its axis bores into the tissues of the snail and finally forces its passage into the interior.

3. *The Sporocyst.* Having entered the snail the embryo loses its cilia etc. and grows into an elongated inert sac, called the sporocyst.

GENERATION B. *Development of Redia.* Certain cells in the interior of the sporocyst become converted by division and differentiation into elongated motile bodies with collar near anterior end, and a pair of pedal processes near the posterior end, etc. When the redia attain a length of about $\frac{1}{90}$ of an inch they burst through the wall of the sporocyst and emerge, and the wound heals up.

2. *Free redia.* The free redia passes from the part of the snail at which it is liberated to the other parts, especially the liver, eating its way as it goes, and at last grows to the length of about $\frac{1}{16}$ of an inch. The snail seldom survives three weeks after the entrance of the embryo. Germinal cells in the interior of the redia then divide as in the sporocyst and give rise to embryos, which may either develop into a second generation for redia, or into a form called cercaria, which is devoid of collar and pedal processes, but possesses a stumpy tail attached to a broad oval body.

GENERATION C. 1. *Development of Cercaria.* The embryo, if it is to develop into a cercaria, comes to acquire besides a tail a bifurcated alimentary canal, etc., the tail increases in length, but no reproductive organs appear. At the sides of the body an accumulation of cells appears and gives the body a milky-white appearance when viewed by reflected light.

2. *Free Cercaria.* The cercaria escapes from the body of the redia by a special "birth opening" at the base of the collar, and not by perforation. Then by the help of its suckers and tail it crawls out of its host, the snail, on to the wet grass. It can now swim very actively by lashing its tail, which is now about twice as long as its body, and can crawl by means of its suckers.

3. *The Cyst.* The cercaria soon attaches itself to a leaf or some other object and in a few minutes much mucus is poured out from the whole body, together with granules from the cells just spoken of. During this process the tail is rapidly lashed and at last broken off. Then the mucus hardens and forms a cyst, in which the tailless cercaria remains inert until liberated by the solution of its cyst by the digestive juices of the alimentary canal of the mammalian host into which it has passed with the grass to which it was attached.

4. *Mature Sexual Fluke.* The liberated tailless cercaria crawls by means of its suckers into the bile duct of the mammalian host, where it grows rapidly. The body elongates, the alimentary canal becomes sacculated, reproductive organs are developed, and the creature attains the condition first described. The first eggs are produced about six months after the fluke's entrance into the sheep, and it is usually supposed to live only about nine months, and to pass out of the sheep at the beginning of summer, but it may live beyond a year.

Henry Mills, of Buffalo, N. Y., died February 7, in Chattanooga, Tenn., of pneumonia. He was a member of the American Society of Microscopists.

EDITORIAL.

Agricultural Experiment Stations.—These institutions are beginning to make themselves heard in reports, some of which are of practical value to agriculturists and others will delight the specialists who clamor for “original research.” Some of the matter published is not entirely new and some that is new will interest only specialists. Now all this is well enough. We have seen no bulletins that were worthless nor deserving of ridicule, since it is to be remembered that the agriculturists themselves are the ones to be most benefited. It is entirely proper to refresh their minds or to teach them anew some things that have been long known to a few scholars or experts.

The constituency in one state will need more rudimentary instruction than that in some other state. We must therefore not pronounce too hastily upon the reports issued.

Although it is entirely fair to expect abstract research at each station, it is not to be regretted if the workers keep the practical and economic questions to the front and endeavor first of all to supply the agriculturists' needs, be it in a way that interests specialists or be it disgusting to them. The people's money is being used and the people (not the scientists) are the ones to be most benefited.

These stations were established not with the *primary* view of advancing biology, botany, chemistry, or other sciences. Incidentally they will sooner or later make acceptable contributions to our knowledge there is no doubt, but their primary function is economic. They are to be serviceable to farmers first of all in their task of coining money out of the soil. They must economically prove their right to exist, and to do this must meet first of all the demands of agriculturists. Now, if people who are not in contact with economic questions but who are absorbed in botany, biology, and chemistry, as taught in the schools, undertake to criticise the work of these stations from their personal horizon, they will be in danger of saying some very unjust and unkind things. Furthermore, as they have access to the columns of scientific periodicals, they can create an amount of feeling entirely injurious to the cause. One such man, skilled in the methods of the press, may accomplish more than the thousand farmers might accomplish if they felt that *their* interests were neglected. Which, then, would the station people listen to,—the scientific specialists clamoring for abstract research, who can do much harm if they do not get it, or the multitude of agriculturists who are not so able to assert their rights? We sincerely trust that it may not come squarely to such an alternative and that our scientific friends will give the stations a fair chance to carry out the purposes of the Hatch law, and that they will avoid every suspicion of there being a feeling of jealousy or lack of confidence on the part of those outside the stations against those who are inside.

The Relation of Bacteria to Puerperal Fever.—A very interesting paper with the above title, by Dr. F. S. Johnson, is published in the *Western Medical Reporter* for March, 1889. From it we gather that the phenomena of puerperal fever may be produced by the ravages of either the streptococcus erysipelatosus, or streptococcus pyogenes aureus.

BOYS' DEPARTMENT.

Jack's Visit to the Natural History Society.*

BY DR. J. E. TAYLOR.

One wet evening Willie Ranson got Jack to go to the Society just because there was nothing else to do. There was a short paper being read on "Fish Scales," and a number of them were mounted for microscopical examination, of course with a low power, say inch and half-inch. Anything relating to fish or fishing was certain to gain Jack's attention, therefore a better subject could not have been selected to engage his notice. Besides, Jack had never yet even looked through a microscope! He felt a bit ashamed of this now; but there were a couple of microscopes present, and Jack determined to have a good look through them. The scales of different sorts of British fishes were on view. Of course, fish-scales are common enough; but who would think that each kind has its own pattern of scale, and that you could tell a species of fish by its scales?

The paper showed that the scales of fishes were composed of the same material, *chitine*, as the feathers of birds, or the hair and nails of animals—a kind of substance only found in the animal kingdom, and never in the vegetable; that these scales are developed in little pockets in the fish's skin, which you can plainly see for yourself when a herring is scaled. They are arranged all over the fish's body like the tiles covering a roof, partly overlapping each other, as is seen by one part of the scale being often different from the other.

Jack looked through the microscope and was delighted. He was always a reverent-minded boy, and the sight broke on his mind like a new revelation. How exquisitely chased and beautiful were the markings, lines, dots, and other peculiarities! Then the scales which run along the middle line of the fish were shown him, and the ducts perforating them, out of which the mucus flows to anoint the fish's body, and thus reduce the friction of its rapid movement through the water. The lad was half bewildered at the possibility of the new knowledge. "Could anybody get to know about these things?" he asked Willie, who told him of course he could, if he would only take a little trouble.

QUERIES.

1. Does photomicrography constitute a crucial test for perfect achromatism? If so, please explain why and how.
2. Is a collar correction for an apochromatic with a compensating ocular of any benefit? If so, how and why?
3. Are apochromatics sensitive to tube length? If not, why not? If so, explain how.
4. What is the process of obtaining dead black parts of the microscope through the use of emery?

* From "Beginnings in Science at Mugby School," in the Popular Science Monthly for May.

MICROSCOPICAL SOCIETIES.

WASHINGTON, D. C.—E. A. BALLOCH, *Secy.*

February, 1889.—86th meeting. The paper of the evening was by Dr. C. T. Caldwell upon Actinomycosis and will be found upon pages 101-4 of this Journal. The discussion of Dr. Caldwell's paper was as follows:

Dr. Acker said that it was his impression that Dr. Taylor, of the Society, had described a case of this disease occurring in the domestic fowl. Dr. Gibbs called attention to a note in a late number of the *Medical News* in which the details of a case of this disease, under the care of Dr. Bodamer, in the human subject were given.

Dr. Blackburn said: My first acquaintance with this disease was about four years ago, when I made the drawings for an essay on this subject which Dr. Bodamer presented to the faculty of the University of Pennsylvania and which took the Clark or the Henry C. Lea prize, I forget which. The disease is easily recognized by the naked eye. I think we sometimes undervalue descriptions of disease as contrasted with microscopical examinations. I do not know whether the growth was sub-periosteal or not. The bone cavity was extensively excavated. Sometimes the fungus will stain as well as the surrounding tissue. I call attention to the large epitheloid cells surrounding the masses of fungus. These I think are inflammation products and show the efforts of nature to limit the disease.

Dr. Seaman said: The Americans, as a rule, are remarkably free from diseases caused by intestinal parasites and fungi, and I attribute this to the fact that they eat their meat well cooked and not to the fact that the parasites and fungi are destroyed by the gastric juice.

Dr. Caldwell said: This may be true as regards intestinal parasites, but it is not the fact as regards this fungus. As I have shown in my preceding remarks, the carnivora are free from actinomycosis, and as carnivora eat flesh in a raw state their immunity from the disease must be attributed to the action of the gastric juice on the fungi.

Dr. Acker showed preparations of Psammoma, a rare form of brain tumor. The brain containing the tumor was from a dissipated man, and was brought him by the attending physician who had observed anomalous cerebral symptoms during the patient's last illness. The brain was normal with the exception of the cerebellum. It was deeply injected and the arteries were extensively calcified. The fourth ventricle was filled with a villous growth springing from the lining membrane. On microscopical examination this was found to be Psammoma, a tumor of a villo-sarcomatous nature. The tumor contains chalky concretions, which have the same structure as normal brain-sand and are made up of concentric strata.

Dr. Acker also showed a female specimen of *Trichocephalus dispar*, containing ova similar in all respects to those shown in the liver of a rat by Dr. Balloch at the last meeting.

Miss M. A. Booth, of Longmeadow, Mass., presented to the Society six beautiful mounted slides of diatoms, all foreign, and one fossil, for which the Society desires to return its grateful thanks.

NOTICES OF BOOKS.

Homer's Odyssey, Books I-IV. Edited by Prof. B. Perrin, of Adelbert College. 8°, 230pp. Ginn & Co., Boston. (Price \$1.40).

This volume constitutes one of the college series of Greek authors edited under the supervision of Prof. White of Harvard and Prof. Seymour of Yale. A dozen volumes are now ready, and include writings of Homer, Plato, Thucydides, Xenophon, Sophocles, Euripides, and Aristophanes.

This volume has a number of attractions to the student. Each page is from one-third to one-half text (clear and beautiful type) and half or more is foot-notes. These are claimed to be sufficient to enable any good teacher to introduce the pupil to the study of Homer,—not an extravagant claim. The presence of notes with text is to be commended as a time-saving arrangement. The absence of a vocabulary will cause a loss of time (to be put on a large lexicon) and will prevent the student getting his lesson in the class-room (a still further loss of time, he will probably say). There are two good indexes.

The German edition has been freely changed to adapt it to the needs of American college classes, but record is made in the appendix of all important deviations from the opinions of the German editors. References are rather liberally given to the American grammars, and also to Monro's *Homeric Grammar*. As the gist of matter referred to is always given in the current note, such references are usually meant for those who desire to collect further illustrative material. Much attention has been paid to the indication or citation of *iterati*, conventional phrases, and metrical formulæ. The student should realize in some measure both the bulk of this material and its bearing on the critical analysis of the poem. The latest accepted views in Homeric Archæology are presented. The Appendix gives not only strictly critical data, but also material which should enable a student with limited apparatus to understand the historical and literary status of controverted views.

SUBSCRIBERS' NOTICES.

[These notices will be given six insertions in this column at 25 cents per line or fraction thereof.]

FOR EXCHANGE.—Slides of selected diatoms. D. B. WARD, Poughkeepsie, N. Y.

WANTED.—Unmounted microscopical material, also micrographic dictionary. Will exchange or buy. CHARLES VON EIFF, 124 Clinton Place, New York City.

WANTED.—A clean copy of Rev. William Smith's *British Diatoms*, and Schmidt's *Atlas of the Diatomaceæ*. JAMES B. SHEARER, Bay City, Mich.

OFFERED.—Diatomaceous Earth from Utah (Desert) for Histological Mounts. PROF. ORSON HOWARD, Salt Lake City, Utah.

CORRESPONDENCE invited with a view to the exchange of either mounted or unmounted Oribatida (British) for American species. E. BOSTOCK, Stone, Staffordshire.

WANTED.—Specimens of rocks for slicing and grinding into sections; also bones and teeth of different animals, diatoms *in situ* on algæ, diatomaceous and polycystinous earths, ocean soundings, etc., etc. Liberal exchange in microscopic slides or cash.

ARTHUR J. DOHERTY, 63 Burlington St., Manchester, Eng.

TO EXCHANGE.—Native gold, silver, copper, lead, zinc, and other beautiful cabinet specimens, polished ornaments and sections of petrified wood—Chalcedony—and native turquoise, agate, amethyst, rubies, etc.; also Indian ornaments, curios, arrows, blankets, pottery, etc.; pelts of wild animals, species of native cactus, and a good second hand "Burt's Solar Compass" complete. Any or all of the above are offered in exchange for new, or good second-hand, objectives, condensers, polarizers, stand, or other microscopical apparatus.

W. N. SHERMAN, M. D., Kingman, Arizona.

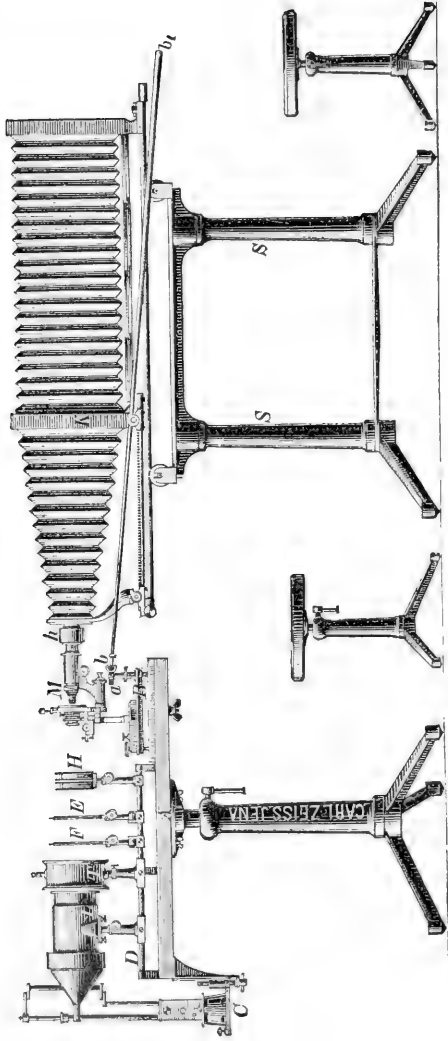

ZEISS' PHOTOMICROGRAPHIC APPARATUS

THE AMERICAN MONTHLY MICROSCOPICAL JOURNAL

VOL. X.

JUNE, 1889.

No. 6.

All communications for this Journal, whether relating to business or to editorial matters, and all books, pamphlets, exchanges, etc., should be addressed to American Monthly Microscopical Journal, Box 630, Washington, D. C.

European subscriptions may be sent directly to the above address accompanied by International Postal Order for \$1.15 per annum, or they may be sent to Messrs. Trübner & Co., 57 Ludgate Hill, London, or to Mr. W. P. Collins, 157 Great Portland street, London, accompanied by the yearly price of five shillings.

Zeiss's Large Photomicrographic Apparatus.*

Dr. Zeiss supplies for photomicrographic purposes a special stand, which is generally similar in form and size to the other large stands of the maker. There is, however, in addition, an unusually large stage, with mechanical movements, rotating by rack and pinion, and having a wide opening for use with a low-power objective, giving a very large field of view. The Abbe illuminating apparatus is so arranged that it can be easily removed and replaced by special spectral, polarization, etc., apparatus. The body-tube is also of an unusually large diameter, partly for avoiding internal reflection, and partly to render possible the use of the low-power objective.

The microscope is not attached to the same support as the camera, but both parts are on separate stands, which it is claimed is more convenient for working. The stand, screwed to a metal support which is provided with three levelling screws, is set up at one end of the platform A (see frontispiece), which is adjustable for height. At the other end of the platform is an angle-plate, C, which supports an electric lamp; while the space between the lamp and the microscope M is occupied by an optical arrangement consisting of two stout metal rails carrying the illuminating apparatus for use with sunlight: two vertical screens, E and F, movable by rack and pinion, which can be quickly turned on one side, and again brought back exactly to their old position; a plane mirror, G, adjustable in height, with coarse and fine adjustment in the vertical as well as in the horizontal axis, in order to correct slight irregularities in the course of the heliostat; and a stand, H, for the reception of glasses for yellow and blue absorption liquids. For the use of the arc-lamp, as shown in frontispiece, there is a water-chamber, T, with plate-glass ends for the absorption of the heat-rays, and a lens, L, for projecting the image of the carbon points on the ground-

* From Journal of Royal Microscopical Society, April, 1889, pp 278-283.

glass plate. On the end of the metal support B is an arrangement, *a*, by which the movement of a Hooke's joint *b* with rod *b'* can be transferred to the micrometer screw. This is effected by means of a toothed wheel, which can be brought into gear with the toothed wheel of the micrometer screw. The tube carries a double socket, *h*, into which, by turning the camera, slides a corresponding socket-piece attached to the end of the camera, so that a very perfect light-proof connection between microscope and camera is effected without disturbing the former. The socket-piece can be easily removed and replaced by a macroscopic objective for ordinary photographic work. The camera K is mounted on a separate light but solid cast-iron stand, SS, provided with iron rails on which it can slide smoothly by means of rollers. The total length of the camera when fully extended is one 1.5 m.

In order to fit the apparatus for taking fluid preparations, the camera is divided into two halves, of which the one nearest the microscope can be turned up vertically, as in fig. 1, or inclined at any angle.

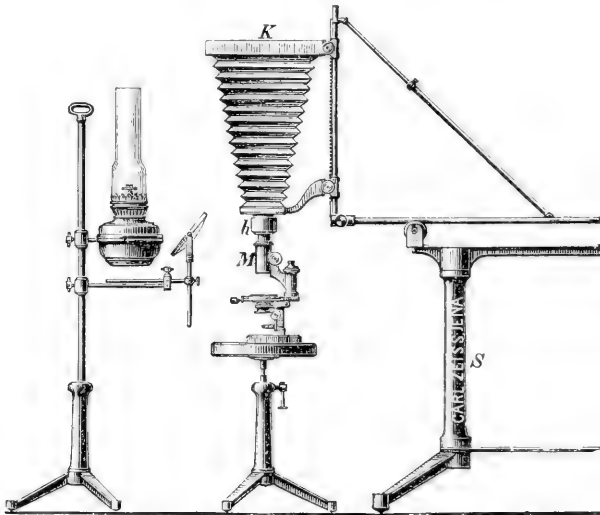

FIG. 1.—Zeiss' Photo-Micrographic Apparatus for Vertical Microscope.

Movement of the plane of the image, and also of the microscope end of the camera, is effected by pinions acting on a strong rack. Both halves of the camera are arranged for plate-holders of 24 by 24 cm. which, however, by the addition of frames can be used for plates of any smaller size. Two adjusting plates, one of ground glass and the other transparent, and provided with a cross on the microscope side, serve for the coarse and fine adjustment of the image. A third plate-holder can be added, which, for the purpose of ascertaining the best time of exposure, permits a great number of proofs to be taken one after another on the same plate. To this end the holder is movable in a guide, and is made to pass in front of a slit which allows only a small strip of the image to fall on the sensitive plate. The bellows of the camera can be drawn a little away from the plate-holder so as to permit the image

to be viewed from the front, it being thrown on a piece of white paper, as in Nacet's method.

With regard to the choice of a room to serve as a laboratory for photomicrographic work, and the setting up and adjustment of the apparatus, Dr. Zeiss's very elaborate catalogue of photomicrographic apparatus, to be obtained from F. R. Emerich & Son, New York, should be consulted, in which valuable information is also given on the nature of different sources of light and the manner of their use for photomicrography, and on the special precautions required in the chemical part of photomicrography.

In photomicrographic work an objective of 75 mm. focal length has been constructed which serves to take large objects (2 to 4 cm.) under a magnification of ten to fifteen times. It possesses all the advantages of the other apochromatic objectives.

As illuminating apparatus, either an Abbe condenser of 1.20 to 1.40 mm. aperture or a specially constructed *achromatic* condenser of 1.0 mm. aperture can be used. To obtain a successful photomicrograph it is necessary that the illumination should be limited to that part of the object which it is desired to photograph, because otherwise the light coming from the surrounding parts has the effect of fogging the picture. A sharp image of the source of light must therefore be projected upon the object, and to this end the condenser is provided with an arrangement for cross-centering and for fine-adjustment. The limitation of the illuminating cone is effected by an iris-diaphragm.

For the 75 mm. objective a specially small lens of great focal length is used as condenser, since it is here necessary to project an image of the source of light within the objective. The condenser for use with the electric arc light consists of two plano-convex and one concavo-convex lens. The part of the system near the lamp is fixed once for all at the proper distance for producing a parallel beam, and to diminish spherical aberration the concave face is turned to the lamp. The part turned to the microscope, which brings the parallel rays again to a focus, is movable in a sliding socket which permits the displacement of the image on the optic axis within pretty wide limits.

Note by Professor Hitchcock.—As soon as time permits him to write up some notes a few words may be anticipated, especially with reference to the use of plates prepared with coloring matters. The Zeiss apparatus for photography is unquestionably the most perfect and complete arrangement yet devised. It is expensive to be sure, but it is always ready for use. About 600 marks would cover the cost of the essential parts.

If larger pictures are desired a dark room may be used and the image projected through the long camera upon a screen.

A New Apochromatic Test.—The new test just discovered is the butterfly *Colias cæsonia* (foreign). Those scales distinguished by fine ribs widely separated are remarkable for closely-packed molecules, lying in curvilinear rouleaux generally about 1-120000th of an inch, and with the best glasses throw up brilliant focal discs.—*G. W. Royston-Pigott in English Mechanic, Apr. 19, 1889.*

Investigation of Bacteria by Means of Cultivation.*

BY R. A. FOSTER, M. D.

WASHINGTON, D. C.

The materials employed in cultivating the different species of bacterium are of two classes, namely, fluids and solids; the former being commonly designated as "wet cultures," and the latter as "dry cultures."

Before commencing the cultures, the fluid or solid medium employed must be sterilized—that is, rendered free from all bacteria and bacterial germs. This may be accomplished by raising it to a high temperature. All bacteria and their spores are killed by steam or boiling hot water, after exposure for a short time. A jet of steam will kill all kinds of germs in from ten to fifteen minutes; besides, it is more potent than steam in a closed chamber.

Of the many fluid media, an infusion of meat is the one most frequently used at the present time. It is made by putting a pound of lean beef, previously cut up into small pieces, in a vessel containing a litre [quart] of water. The vessel is then placed in an ice safe, where it is allowed to remain not less than twenty-four hours. At the end of the twenty-four hours it is taken out and all the juice of the meat squeezed out by means of a press. If an ice safe and press are not at hand, it is sufficient to keep the material simmering for two or three hours. In either case, the resulting fluid must be well boiled—that is, long enough to precipitate the albumen. After filtration it may be at once introduced into suitable vessels. As the meat is acid in this condition, and as an acid medium is a poor soil for many forms of bacteria, it can be neutralized with carbonate of soda; but this should be done before it is boiled. To make the infusion still more serviceable, about one per cent. of peptone and a little chloride of sodium should be added to it.

An infusion of cucumber is a very good medium for cultivating micrococci. Cow's milk, blood and urine are also good cultivating fluids.

Artificial cultivating materials are seldom if ever used now. The two solutions that have been most frequently employed are Pasteur's and Cohn's.

Pasteur's solution is composed of candy sugar, 10 grammes; tartrate of ammonia, 1 gramme; ashes of yeast, 1 gramme; distilled water, 100 c.cm.

Cohn's solution is a modification of Mayer's; it contains phosphate of potash, 0.5 gramme; crystallized sulphate of magnesia, 0.5 gramme; tribasic phosphate of lime, 0.05 gramme; tartrate of ammonia, 1 gramme; distilled water, 100 c.cm.

Gelatinized materials and potato are the chief solid cultivating media. The former may be made by adding from five to ten per cent. of gelatine to the different fluid media mentioned above.

"For potato cultivations," Cheyne says, "ripe potatoes are best, the small new potato not being nearly such a good medium. As the earth on the outside of the potato is full of bacteria and spores, it must be washed off as much as possible, and the eyes of the potato cleaned out.

* Read at the Washington Microscopical Society at its 83th Regular Meeting, Feb. 26, 1889.

The potato is then laid in a 1 to 1000 watery solution of corrosive sublimate for about an hour. Afterward it is washed in water and placed in the steaming apparatus, and kept at the temperature of 100 c. for a half to three-quarters of an hour. It is then allowed to cool under cover from dust. In the meantime a couple of glass dishes, one larger than the other so as to form a cover, are washed out with 1.1000 sublimate solution, and a piece of filter paper moistened with the same solution is placed on the bottom of each, so that when the one is inverted over the other there is a moist surface at the upper and lower part of the chamber. This is to keep the air moist so that the surface of the potato does not dry. The potato after being cooked and cooled is cut into halves in the following manner: a long flat knife is heated in the flame and allowed to cool. The left hand is then dipped into 1.1000 sublimate solution, and the potato is taken up with it. With the knife held in the right hand a single sweep is made through the potato, and the cover of the moist chamber being lifted, the two halves are separated and laid down with the cut surface uppermost. The cover is then replaced and the potato is ready for inoculation. In some cases, where the potato is to be placed at the body temperature and kept for some time, tall narrow vessels similar to those used by Koch for testing air, plugged with cotton-wool and sterilized, and large enough to hold half a potato, are employed.

“The surface of the potato may be inoculated by platinum wire, or by a thin, flat knife, by means of which the material is rubbed over the surface of the potato. The knife or needle is dipped in the cultivation to be inoculated and drawn rapidly over the surface of the newly prepared potato.”

Fluid cultivations have given place to solid culture media. There are two serious drawbacks to them. One is, that if they should in any way become contaminated the cultivation will be entirely spoiled, the newcomers mixing thoroughly with the original bacteria. Further inoculations, therefore, from flasks thus contaminated simply carry over the two kinds. The second disadvantage is, that the original culture must be started from a material containing only one kind of bacterium, it being almost impossible to separate one form from another with fluid media. •

In special cases, however, fluid cultivation materials have certain advantages, one being that they can be placed in an incubator at the temperature of the body without the result being spoiled. With gelatinized media, however, this cannot be done, all melting at the temperature of the body. Agar-agar (a material derived from the plant *Gracilaria lichenoides*) is sometimes used in place of gelatine; mostly, however, to maintain pure cultivations of bacteria which grow at the temperature of the body. Agar jelly is difficult to prepare; moreover, it is not as satisfactory as the other.

Fluid media are also more serviceable than solids in experiments on the growth of micro-organisms in different gases.

Test-tube cultivations, plate cultivations, and glass slide cultivations are the three principal modes of using nutrient jelly for cultivations. The best temperature for growth and for solidity is said to be from 20 C. to 22° C. At 25° C. 10 per cent. gelatine is just solid.

Test-tube cultivations are employed when it is desired to keep up a

series of cultivations. The jelly is allowed to solidify in tubes placed perpendicularly.

For separating bacteria from one another in a mixture, or for studying the peculiarities of certain forms, plate cultivations are preferable.

For glass slide cultivations the ordinary microscopic slides may be employed. After sterilization in the usual manner, they are kept, after inoculation, on glass trays in glass vessels. When using the jelly in these cultivations, it is first liquified and then poured out on the glass slides. When it has solidified, a platinum wire, bent at the end, and dipped in the material to be tested, is lightly and rapidly drawn over the surface. As the wire passes over the surface of the jelly it leaves the bacteria along its track.

Blood serum as a cultivating medium is mainly limited to tubercle and glanders bacilli.

Pastes are very useful, especially for fungi. They may be made of crushed potato, bread, various fruits, etc.

Cultivations of the various micro-organisms may be obtained pure from mixtures of various kinds—such as are commonly found in decomposing materials, etc. It is best, however, to get pathogenic organisms from the body of the animal affected.

In examining earth for bacteria, it should not be forgotten that they are close to the surface, and that only spores and anaërobes are deep down.

In testing water both the numbers and the kinds of bacteria present must be taken into consideration. The vessels in which the water to be tested is received must, of course, be sterilized before the water is introduced.

For testing air, Hueppe's method is one of the best. "He aspirates a definite quantity of air through a certain amount of culture fluid, and then, shaking the flask well to distribute the bacteria equally through the fluid, he makes plate cultivations with known quantities of the fluid in nutrient jelly and agar, testing the mixture of air and culture fluid in the same way that water is tested."

Detecting Alterations in Manuscripts.—As accessory to the use of the microscope, the use of photography is recommended by Mr. Geo. G. Rockwood, of 17 Union Square, New York. He has for years been in the habit of photographing manuscripts, models, books of account, checks, and drafts, whenever their genuineness was questioned. The process sometimes makes legible figures, amendments, and alterations which even the microscope does not fully bring out. This is due to the extreme sensitiveness of photographic plates to shades of color. With the new "Autho-chromatic" or color-sensitive plates almost imperceptible stains on old yellow paper have been made clear and legible.

(Our Utah friend, whose signature to a will was tampered with, may like to consult Mr. Rockwood.)

Carbolic Acid in Mounting.*

By F. T. CHAPMAN.

Phenol, carbolic acid, coal tar, creosote, phenic acid, and phenylic alcohol are various names, according to Ure, for a substance more commonly known by the second name, carbolic acid. At ordinary temperatures, according to the same authority, it crystallized in long colorless needles, which easily deliquesce to an oil taking up a mere trace of water, but which may be made to immediately solidify by the addition of chloride of lime. It dissolves sparingly in water but well in alcohol, ether, and strong acetic acid.

I became interested in the use of carbolic acid for preparing insects for mounting, as the usual methods were open to objection. With liq. potassa, none but the harder, chitinous parts remained, and the "skeleton" was usually distorted by being mashed. Turpentine is a good clearing agent, but takes too long a time to act, being, however, in most other respects unobjectionable.

According to all the information I could gather; the strongest uncolored acid must be used, and small insects could be cleaned in a few seconds, and immediately mounted in balsam without further treatment.

To liquefy the crystallized acid I find that the addition of a few drops of water is amply sufficient, say about 5 or 10 drops to the ounce of acid. Or if it can be used warm, and its action is hastened by heat, it may be temporarily liquefied at a comparatively low temperature, and does not again solidify until quite cold. No set time for treatment of the insect can be given, as it will vary from a few minutes to several days. For instance, the head of the common house fly, which is an unusually difficult object to clear, takes about a week, but well repays one for the labor when finished.

I have not succeeded in any instance in mounting an object in benzole balsam directly from the acid, as a permanent, opaque cloudiness invariably appeared, whether the acid was liquefied by water or 95% alcohol. To prevent this clouding, which was probably due to the presence of water in the carbolic acid, the object was first passed through clove oil, that is, the object was allowed to remain in the oil until all surface agitation disappeared, and was then mounted in benzole balsam in the usual manner.

It may be well to mention that the object is mounted without pressure, in a cell of suitable depth, and that flattening, and consequently distorting, the object is to be condemned, as it is then misleading and does not present its well rounded and beautiful natural proportions. When strong carbolic acid is used to clear insects it causes all the exterior retractile organs to protrude as they do naturally.

It was suggested in the *Microscope* for January, 1889, that the analine dyes could be dissolved in creosote, and the object stained as well as cleared. Although creosote ($C^{13} H^{16} O^2$) differs from carbolic acid ($C^6 H^6 O$) when both are pure, it is quite probable that the latter will prove a good vehicle for stains. The analines will probably dissolve freely, as will also picric acid and carmine, and double staining can likely be successfully performed. The strength of the stains will have to be graded according to the object, or it may be cleared and then

* Read at the Washington Mic. Soc. 87th Regular Meeting, Feby. 12, 1889.

stained. Other stains can probably be used with success, but whatever stain is used, it must usually be very weak if the clearing action is to be simultaneous with the staining; for instance, a solution of one-tenth of one per cent. would be sufficient for a fly's head, while a one per cent. solution would probably not be too strong for a leg or other like part.

Carbolic acid has the disadvantage of coloring on exposure to light. The crystals of the acid color very slowly, more than a year having elapsed in one instance before they changed to a light amber, and even then some portions of the mass (an ounce bottle full) remained clear. The acid dissolved in a very small portion of water turned dark very quickly, that is in a few days. That dissolved in 95% alcohol has remained a light amber color after three months' exposure to daylight and direct sunlight, being clear and transparent, while the aqueous solution is dark and almost translucent.

A solution of red aniline in carbolic acid liquefied with alcohol has remained brilliant and clear for a like period. Carbolic acid liquefied by benzole has changed but very little, much less than the alcohol solution, after a month's exposure to daylight and direct sunlight. In each instance the bottles holding the acid were corked. A combined solution of picric acid and carmine in carbolic acid dissolved in acetic acid has shown no perceptible change for several days. Pure creosote does not color on exposure to the air, and may possibly present all the advantages of carbolic acid with none of its disadvantages, but having had no opportunity to investigate I cannot give any information on the matter.

If for any reason any part of an insect has been removed so that the acid can readily enter the interior of the body it will, after clearing the soft parts, begin to dissolve or destroy them, and if an object be left in the acid for some weeks nothing but the chitine will remain.

Although the properties of carbolic acid and creosote have been known for years, little appears to have been done with them, and an interesting, fascinating field of study and experiment is open to any one who can devote the necessary time and labor.

The Reddening of Codfish.

By CHAS. W. SMILEY,

WASHINGTON, D. C.

As early as 1838 it was noticed that salted codfish sometimes turned red. In France, at that time, it was considered not injurious, but even preferable. Within a few years the allegation that red cod was poisonous has led to a careful examination of the subject.

Its Appearance.—Sometimes small rosy specks are found to show themselves upon the fish and to spread rapidly, so as to cover it quickly and give it a thoroughly reddish appearance. This redness is frequently to be found only on the surface, and then may easily be scraped off; but sometimes it penetrates into the fissures of the flesh, and even into the muscles and tissues of the fish. Entire cargoes sometimes become more or less reddened before the termination of the voyage, where there is heat and moisture. But this redness, which springs up

so quickly, is usually only on the surface, and may be removed by brushing and washing. This reddening has sometimes been accompanied by a tendency to decomposition, which of itself would entirely unfit the fish for market.

Alleged Poisoning.—In regard to the actual poisonous nature of this substance, while there are several well-authenticated cases of poisoning occurring after eating reddened fish, yet it seems to be shown that cases of the same symptoms, which resemble those of cholera, have occurred from eating codfish which had undergone putrefactive changes, but in which there was no trace of this redness. There have been seven instances carefully recorded where poisoning has resulted from eating spoiled codfish, in which a total of 700 persons were affected; but the poisoning was rather annoying than dangerous, as only one person out of the whole 700 died from the effects. In four of the seven recorded instances—and it should be observed that many of them were among troops or sailors, where the food was not of the best quality, and was prepared and served by wholesale methods—no specially reddish color was observed; and the poisoning from eating in the other instances was not so severe, nor were so many persons affected, while there was some putridity of the flesh in the fish causing all the cases.

Especially in all the cases of poisoning attributed to reddened codfish, mention is made of a putrid odor of the flesh, of its softening and tendency to crumble to pieces. These are marks of decomposition, and are usually attended by the formation of a poisonous alkaloid in the substance used as food. This poisonous alkaloid is not attributed necessarily to the action or presence of the red parasitic growth, and it is even found that in a number of cases where the redness was apparent, yet where there was no decomposition, the fish had been eaten with perfect impunity. This reddening of the flesh seems to be simply a coincidence of the poisoning in some cases, but not in all or the most severe—the only case reported where death resulted was from eating a codfish that had not this redness—while it appeared in a vast number of cases where no injurious results can be traced. In some of the cities of France large quantities of red codfish from the suburban drying establishments have been consumed by the people with no resulting cases of sickness. Enormous amounts of reddened cod are eaten in some of the French colonies and in other hot countries with impunity; and in some regions, especially in the Antilles and the island of Reunion, consumers at present give the preference to codfish having a rosy tinge.

Microscopic Examination.—The French researches seem to show that this redness is produced by a cryptogamous vegetable growth, frequently found in masses, and particularly dense about the salt crystals. The nature of this growth they did not fully determine; some considering it a fungus, others an alga; but by most it was regarded as a parasitic alga. The germs of this growth seem to be specially found in the Mediterranean salts.

As early as the summer of 1878 the U. S. Fish Commissioner called the attention of Prof. Wm. G. Farlow to the peculiar condition to which salt codfish is liable during the moist summer weather, and observations were made, particularly at Gloucester, Mass., by Prof. Farlow during that summer and fall. During his investigations at Gloucester, Prof.

Farlow ascertained that the redness was present in troublesome amounts only during the hot season, and disappeared with the return of cold weather; also that it was rarely to be found until after the fish had been landed from the vessel, though occasionally it began on board. Considerable moisture as well as heat seemed necessary for its best development. A careful microscopic examination convinced the professor that the redness was due to a very minute plant, the *Clathrocystis roseo-persicina*. This plant consists merely of minute cells, tinged with red coloring-matter, and imbedded in a mass of slime. The cells as usually seen seem to be arranged without order, but under more favorable conditions for observation they are found grouped in spheroidal masses. This plant is closely related to *Clathrocystis æruginosa*, a common species occurring in fresh-water ponds, and which exhales a peculiarly unpleasant odor when decaying. The *Clathrocystis* found on codfish is very widely diffused both in Europe and America, being abundant enough in the marshes near Gloucester. It does not flourish, however, at a temperature below 65° Fahr. At Gloucester this minute plant was found in large quantities on the woodwork, from which it could easily be communicated to the fish. Also, Prof. Farlow's investigations led him to conclude that the same microscopic alga was found on the Cadiz salt used by the fishermen for preserving their fish. The presence of the alga in the salt is accounted for, doubtless, by its being derived from the vats or evaporating places along the coast where the salt is made. (Prof. Farlow at the same time discovered a second parasite, which he called *Sarcina morrhue*, occurring along with the alga above mentioned.) Curiously enough, also, the same peculiar redness has been found on salt pork in the region of Gloucester, but it is not at all certain that it is the same microscopic growth which causes it.

Economic Effects.—Early in 1886 the French Ministry of Commerce prohibited the sale of this reddened fish throughout all French territory, but this prohibition has since been suspended until the matter could be thoroughly investigated.

That this parasite tends to cause decomposition by breaking up the tissues and giving occasion for the formation of other compounds may be true, but that it is itself neither poisonous nor the direct cause of the poisonous matter has been demonstrated over and over again by experiments in eating this reddened flesh where it was free from decomposition, and no harm has ever thus occurred. Careful experiments made on the reddish parts of codfish have failed to find any poisonous alkaloids there; while these ptomaines were found in the fish that had begun to decay.

The reddening seems, then, rather to be an occasional attendant upon the cause of poisoning than directly connected with the cause itself, which is the more or less advanced stage of the putrid decomposition of the flesh of the codfish. This decomposition can always be detected by examination of both the outside and the inside of the flesh by feeling and smell. Whence it results that codfish may be eaten with impunity when it has its normal odor and a firm consistence of the flesh; but it should be carefully avoided when there is any putrid smell about it, and its flesh has become soft and crumbling, no matter whether redness is present or not in either case.

Report upon the Postal Club Boxes—VII.

BY QUEEN MAB.

Box D. A prominent member of the Club over his initials characterizes slide No. 1 as an example of how *not* to do a thing. The information imparted by the preparer concerning this slide is thus concisely given under the head of "How prepared?" "Pretty poorly, I fear." No. 2 is prepared by F. T. Ascham, of Sharon, Pa., in order to study the characteristic structure of the tobacco leaf, with a view to detecting the alleged adulterations in commercial tobacco, being a transverse section of tobacco leaf showing midrib, veins, etc. Mr. Ascham finds, at most, an undue proportion of powdered stems, and seeks the experience of his brother members as to finding cabbage leaves, paper, etc., which are said to be among the adulterants used. F. F. Colwell, M. D., Urbana, Ohio, in No. 3, contributes epidermal layer from foot of horse. Chain cocci were numerous in the pus from the abscess. No. 4 is contributed by C. K. Wells, Marietta, Ohio. S. M. Mosgrove, M. D., contributes No. 5, *Trichina spiralis* in biceps muscle, stating that while the subject is old, the slide is of interest because of the profuseness of the occurrence of this parasite. E. L. Cheesman, of Knowlesville, N. Y., sends out in No. 6 pollen of evening primrose, *Oenothera*, stained with one of the aniline dyes and mounted in benzole balsam.

Box C. No. 1, prepared and contributed by W. C. Weymouth, of Renovo, Pa., is a transverse section of stem of potato, stained with carmine and aniline green, mounted in balsam, and ringed with shellac, which is followed by white zinc. No. 2 is by E. L. Hewitt, of Burlington, N. J., the sting of wasp, *Vespa vulgaris*, showing "sting drawn out of sheath for better display, and the palpi and poison glands." No. 3 is contributed by Edward Pennock, of Philadelphia, and is a section of rock, ground down to show horizontal sections of fossil diatoms in their matrix, being a section of the famous "Cementstein," of Jutland, Isle of Mors, Denmark. Objectives recommended, $\frac{4}{10}$ to $\frac{1}{2}$ in. No. 4 is the work of Dr. Geo. A. Rex, of Philadelphia, and the subject one to which he has given much study, the Myxomycetes. This particular slide is a mount of "lattice fungus," *Stemonitis morgani* Pk., showing the thready frame or net-work of two sporangia. Glycerine jelly cell, gold size with lead oxides, cover fixed with shellac and ringed with asphalt. Objectives, $\frac{1}{2}$ to $\frac{1}{2}$ in. The object of this mount—for it is not one of the desultory class too freely represented in the Club boxes—is to show an unusual amount of variation within specific limits, even for the very variable group of Myxomycetes. But for careful watching of these plants during two seasons, which proved the development of intermediate stages between the two extreme forms, a new species would have been added to the list, so great is the variation between these two forms. To appreciate the description the slide must be seen. Of Slide No. 5, L. Brewer Hall, M. D., is the preparer and contributor. It is the prothallus and young frond of a maiden-hair fern, a species of *Adiantum*, stained with aniline green and mounted in thick glycerine, ringed with gold size and lead oxides. These prothallia, Dr. Hall says, he finds abundant on the tops and sides of pots in green-houses in early spring, a fact which those who would like to study prothallia will do well to note.

No. 6 is transverse section of mucus membrane of stomach, contributed by R. M. Luther, of Philadelphia, Pa. It is stained with carmine and mounted in balsam. Attention is called to the arrangement of the blood vessels and columnar epithelium.

Box T². Recalls two members who have, since the issue of this box, passed on to fuller light and knowledge, Dr. L. M. Kenyon and Henry L. Mills, Esq. An excellent feature of some of the late note-books is the date of the preparation of the slides. Slide No. 1 is by Dr. Geo. E. Fell, of Buffalo, prepared in 1886, and, perhaps owing to the nature of the medium, is faring badly. It is human renal tube casts, in natural medium. The casts on the slide are chiefly blood casts and from a case of renal hyperæmia. Some one queries whether it would not have been better to have stained these casts in the urinary fluid before mounting.

Slide No. 2 is a fresh-water sponge, by the late Henry Mills, *Myenia fluviatilis*, cleared in carbolic acid and mounted in Canada balsam. The preparation shows skeleton spicula, several statoblasts or winter eggs, with their birotulate spicules. No. 3 was contributed for the late Dr. Kenyon by Mr. Mills, a section of yellow water-lily, *Nuphar lutea*. No. 4 is the work of Dr. Geo. E. Fell, of Buffalo. "Tumor, human." Section of growth from inside of knee joint. "Many of these growths, a little larger than the size of a pea, were removed from the joint with quite satisfactory results by Dr. Hartwig, of Buffalo." This is the comment which this slide has received: "The word tumor seems to court a diagnosis. It would be better to diagnose this before sending out, as it would be more interesting."

No. 5, prepared by B. W. Thomas, of Chicago, is contributed by Miss A. M. Kenyon, of Buffalo, and is a slide of spicula of the sponge shown on Slide No. 2, *Myenia fluviatilis*, boiled in acid, washed out like diatoms, and mounted in balsam. A member asks, What acid? To which query another member replies, Probably treated with nitric acid. This destroys the statoblasts or winter eggs, but leaves clean the birotulate spicules, which are seen in great numbers on the slide. Slide No. 6, contributed by Prof. D. S. Kellicott, of Columbus, Ohio, was unfortunately broken and withdrawn, but the notes and comments remain. Flea of woodchuck. It was mounted by passing from alcohol into oil of cloves and balsam. This flea is stated to be very odd. One of the best American microscopists says of this slide: "Beautifully prepared. Carbolic acid gives much the same result." This comment is of interest as coming from such an authority, and yet much in contradiction of another commentator recently quoted in these reports. Indeed, so often do authorities disagree as to details that it is impossible for the individual worker implicitly to follow any set of rules. There is ample room for the development of the individuality and skill of every worker.

Tobacco Smoke and Bacteria.—It would seem that a powerful poison, like nicotine, ought to be destructive to bacteria, and therefore that smoking should exert some protective action against those bacteria that gain access to the system through the nasal and buccal mucous membranes. Some observations by Hajeck, of Vienna, and Tassinari, of Pisa, seem to confirm this idea.

BIOLOGICAL NOTES.*

British Fungi.—M. C. Cooke reports in *Grevillea* for March four new species of British fungi, three of them belonging to the genus *Phoma* and one to the genus *Physarum*. This number has also a review of Mr. Plowright's "Monograph of the British Uridineæ and Ustilagineæ" and many interesting notes on fungi.

Pollen Mother Cells.—Bryon D. Halstead, in the *Botanical Gazette* for April (p. 109), describes a method of obtaining from the partly grown anthers of *Negundo aceroides*, Moench. the pollen mother cells. Transverse sections are made through the staminate flower and a weak solution of azorubin is recommended for bringing out the young grains more prominently.

North American Umbelliferæ.—The revision of this group of plants, so difficult for beginners in botany, by Profs. J. M. Coulter and J. N. Rose, is announced. This will be welcomed by botanists if it sustains as high a character as the ability of the authors promises.

Yellow Fever.—Jerome Cochran, M.D., of Alabama, in the *Sanitarian* for February, discusses the "problems in regard to yellow fever" under the three following heads, viz :

1. To prevent the introduction among us of yellow fever across the sea from foreign countries.
2. To prevent the transmission of yellow fever from one part of our own country to another by land.
3. To prevent the spread of yellow fever in our towns and cities after the outburst of a few cases.

The doctor says that the sea quarantine is much less difficult to manage than that on the land. While disinfectants are valuable, non-intercourse with infected persons, localities, and things is the only reliable safeguard. Depopulation of a large city is impossible and of a small village is unnecessary, and this method of non-intercourse is not therefore of great value. Prompt and rigid quarantine of infected localities is not an easy thing to accomplish in the midst of a densely, populated city, and it would seem that Dr. Cochran does not overstate the gravity of the problems which arise in the treatment of this dreaded disease.

Microbes in the Human Stomach.—M. Abelson is reported to have discovered sixteen species of microbes in the human stomach in normal health, nine of which are new species. He maintains that these play an important part in the processes of digestion, as he finds that some of them attack albumen and other various substances which figure as ingredients of food.

Rotifera.—Dr. C. T. Hudson, president of the Royal Microscopical Society, in his inaugural address, delivered February 13, 1889, discusses in a very interesting manner the distribution of the rotifera. After alluding to the fact that certain species seem to find a limited locality in regions very widely apart and citing records to show how remarkably is this true, he attempts to show in what way they may have been transported to these widely separated areas. Among the methods mentioned are the following :

1. Many rotifera live in temporary pools, the drying up of which enables the wind to carry in the form of dust the eggs of the rotifera, especially the more imperishable or thickly-coated eggs. These, when

* Conducted by J. H. Pillsbury.

borne to the upper regions of air by whirlwinds or otherwise, may be transported to great distances.

2. The entanglement of these eggs, many of which have hooks upon them, in the plumage of birds or the hair of animals while bathing, is another means of transportation. In the former case they may escape in mid-air, and so be carried by aerial currents for long distances.

3. The transportation of these eggs as dust with the cargoes of vessels, even to foreign countries, may account for appearance of the same species in countries intimately connected in commercial relations.

Marine Laboratory.—The circular announcing the second season of the new Marine Biological Laboratory at Woods Holl, Mass., is out. The laboratory is under the direction of Prof. C. O. Whitman, as last year, and will consist of two departments, one for investigators and another for students. That for investigators will be open from June 3 to August 31, and Howard Ayers, Ph. D., and E. G. Gardiner will be assistants. Aquaria, glassware, reagents, &c., will be supplied, but microscopes and microtomes must be furnished by the investigators. Eight private rooms are offered for the use of investigators who do not require instruction. Others desiring special aid by way of suggestions and criticism or instruction in technique will occupy tables in a general laboratory on the second floor of the building. For the privileges of this laboratory a fee of \$50 will be charged. The laboratory for students will occupy the first floor and the regular courses of instruction will begin July 10, and continue seven weeks, under the following instructors: J. S. Kingsley, Sc. D. in zoölogy, Jas. E. Humphrey, S. B. in botany, and Playfair McMurrich in microscopical technique. Occasional lectures are promised by Prof. E. B. Wilson, of Bryn Mawr, Prof. S. C. Minot, of Harvard Medical School, and others. The fee for the privileges of this laboratory will be \$25. The success of this enterprise has thus far been very encouraging to those interested, and it is expected that this season will afford a still larger number of workers the privileges of a well-equipped sea-side laboratory, the need of which has been greatly felt for several years. Correspondence relative to the laboratory should be addressed to Miss A. D. Phillips, 23 Marlborough st., Boston, Mass.

Microbes in Snow.—Recent investigations regarding the presence of bacteria in snow and the possibility of some species retaining their vitality, or even increasing when subjected to a very low temperature have led to the following conclusions, viz :

1. Snow always contains bacteria, some forms of which are capable of multiplying in gelatin cultures.

2. These are more numerous in the first snow that falls than after it has been falling for some time, indicating that a portion of these at least are derived from the air. The remainder may come from the vapor that arises from water containing bacteria in considerable numbers.

3. Snow that has been lying upon the ground for some time contains a smaller number of those forms which liquefy gelatin than when freshly fallen and a larger number of those forms which do not liquify gelatin, showing that these forms are capable of multiplying at low temperatures.

The Rabbit Pest of Australia.—The experiment of trying to rid Australia of its rabbit pest by introducing the chicken cholera, to artificial inoculation of which the rabbit is extremely susceptible, is reported to be a failure.

BACTERIOLOGY.

The Bacillus of Leprosy.*—The bacillus of leprosy is met with as a fine rod-shaped bacillus, rounded or slightly pointed at the extremities, and averaging about 5 micromillimeters in length by a little less than 1 micromillimeter in diameter. Some individual bacilli may be observed with bright oval spores, and many, though not all, present an active to-and-fro motion. In quite a number of specimens studied there was a beaded appearance, owing to the local centralization of protoplasmic masses.

The bacilli are found most abundantly in the leprous nodules of the skin, in which they literally swarm, appearing in some portions almost as plentiful as the cells of the tissue itself. They are also very plentiful in the leprous lesions of the buccal, laryngial, and other cavities of the body. Some bacilli are found in the internal organs, as the kidneys, liver, spleen, and lymphatic system.

There are several good methods of staining *Bacillus lepræ*, but that which was found to be the most satisfactory for the cover-glass preparations is the acid solution of eosin-hæmatoxylin of Ehrlich. Sections also may be stained in this manner; but the method of Babes is more satisfactory. It consists in first staining with a solution of rosaniline hydrochlorate in aniline water. Then bleach with a solution of hydrochloric acid in water (1 to 4), afterwards re-staining with methylene blue.

Observations of the Mode of Growth of Bacillus Lepræ.—A cover-glass in the centre of which had been deposited a drop of sterilized blood serum inoculated with the bacilli was placed, culture downward, on a cell slide. The latter was made by cementing a glass ring to the centre of a glass slip, making, with the cover-glass, a closed cell, in the bottom of which was placed a drop of water to maintain the moisture of the culture. The cover-glass was sealed in its position on the top of the glass ring with olive oil, as it is not necessary to admit air, the spores germinating freely independent of its admission. The whole, prepared in this manner, was placed on the stage and all of that portion of the microscope below the focusing apparatus was enclosed in a box kept at a temperature of about 100° F. This arrangement afforded the means of observing everything taking place in the culture thus placed immediately beneath the cover-glass, which latter, being of the ordinary thickness, permitted of the same facility of observation as an ordinary slide preparation.

From among several preparations a sufficient number were successful to show the formation and growth from spore to mature bacillus. The spores would swell, then the sharp outline would fade and become transparent at a certain portion of its circumference. From this spot would appear a faint, pale projection, which would grow in length until it reached the size of the mature organism—the outlines of the original spore entirely disappearing. The new bacillus would divide by fission into two, these into four, and so on *ad infinitum*.

The microscopical character and general morphology of *Bacillus lepræ* greatly resemble *Bacillus tuberculosis*. The giant-cells in which

* Proceedings of the American Society of Microscopists, 1888. Paper of Chevalier Q. Jackson, M. D.

the latter is found display great similarity to the large leprosy cells of Virchow, in which *Bacillus lepræ* occurs. One point of difference is, the motility of the bacillus lepræ and the non-motility of the tubercle bacillus. Another point of difference is, that tuberculosis may be produced in animals by inoculation; while the bacillus of leprosy is only with difficulty inoculable in the lower animals, and in man probably requires a certain predisposing condition, just as a phthisical tendency is usually necessary for the development of consumption. The bacillus of leprosy is stained much more readily than that of tuberculosis.

The material was procured in Vienna from which the bacillus lepræ was obtained.

A New Wax Cell.

Dr. S. E. Stiles, of Brooklyn, N. Y., has invented a new wax cell and demonstrated before the Microscopical Section of the Brooklyn Institute the method of constructing the cell and mounting of objects therein. The cell is both simple and effective. Sheet wax, such as is used by the makers of artificial flowers, is the material employed. Three or four sheets of different colors are pressed together by the thumb and finger to cause them to adhere, and a square of the combined sheet thus formed of sufficient size for a cell is cut out and pressed upon a glass slide. The slide is then placed upon a turn-table, when, by the use of an ordinary penknife, the wax is cut into a circular form, and the centre is cut out to the required depth. If the cell is to contain a transparent or translucent object, the entire central portion of the wax is removed; but if a ground is required for the object, one or more layers of wax are allowed to remain. A portion of the upper layer of wax is removed to form a rim for the reception of the cover glass. Where a black ground is required, a small disk of black paper is pressed upon the lower layer of wax. The final finish is given to the cell by a coating of shellac varnish, applied while the slide is on the turn-table. These cells are very quickly made and have the finished appearance of cells formed of different colored cements.

Bud Sectioning—The Shell-bark Hickory.

By DR. HENRY SHIMER,
MT. CARROLL, ILL.

Continuing the remarks published on page 104, it may be stated that the cross section, though not so beautiful, is as important as the longitudinal section.

This bud is prepared by soaking it several days in water. The one we now section has been in cold water over two months, in a cold room, changing it twice a week. Now cut a section above the centre toward the apex; the razor is well flooded with water and held horizontal. As the cut is being made the water flows into the segments of the bud leaves and holds them *in situ*. We now float the section off carefully on the slide, and mount as before. Then cut away a portion of the bud and make another section near its middle, and so on down, making several sections at intervals until the base is reached. These several mounts give us a good understanding of the plan and arrangement of the bud leaves. In the long section the hairs are in place, but in the cross sections they are cut off and lying around like mown grass.

MICROSCOPICAL SOCIETIES.

PATHOLOGICAL MICROSCOPICAL CLUB.—GEO. W. LIBBY, *Secy.*

WORCESTER, MASS., *Jan. 1, 1889.*—Dr. Trowbridge read a paper on "Ovarian Tumors." The histological structure and derivation of the cysts and contents were especially discussed. Fibro-cyst of the uterus is very apt to be confounded with the ovarian, and the structure of this also was described. A recent specimen of the latter was shown, together with slides showing structure and contents, and slides of the ordinary and papillomatous cystoma were presented.

Jan. 15.—Dr. Jordan read an interesting paper on "The Brain," illustrating the subject by 30 or 40 slides, prepared by himself from various parts of both normal and pathological brains.

Jan. 22.—Several gross specimens were presented; among them a cystic tumor, an enlarged præpatellar bursa, an anencephalous monster, and a papillomatous cancer of the cæcum. The subject of the evening was "Peritonitis."

Jan. 29.—Gross specimens were bones of a leg showing exostoses and a small bony cyst of the jaw containing hard rice-like bodies. Sections of a blood-clot, cysto-sarcoma of the uterus, and tumor of the kidney were shown. Dr. Miller then read his third paper on "Entozoa," the topic this evening being "Nematoda," illustrated by specimens.

Feb. 5.—Sections from a set of organs, lung, liver, kidney, and intestine, characterized by granular degeneration of the epithelium, especially marked in the intestine, were exhibited by Dr. Libby. The lung showed purulent and fibrinous infiltration. The cause was pneumonia, going on to suppuration and death. The "Pathology of the Placenta" was the subject of the evening's discourse by Dr. Greene.

Feb. 12.—A five-months' fetus and a battle-door placenta were the specimens, and the subject "Hydrocele." The chemical and microscopic characters of the fluid were a prominent feature of the evening's study.

Feb. 19.—Dr. Miller exhibited his new freezing microtome, explaining and illustrating its use. By this method we are able to get fresh microtome sections only a few hours after autopsy. The only preparation needed is soaking the blocks for a few hours in a thick gum solution. The histological structure is well preserved. The sections stain well with carmine and the aniline dyes, but not with hæmatoxylin. The subject of "Cystitis" was then presented by Dr. Welch.

Feb. 26.—Dr. Clark spoke on the subject of "Epilepsy." No uniform lesions occur, but areas of occipital softening and capillary dilatations in the medulla are sometimes found. A spicule of bone near the second frontal convolution was the cause in a recent case.

Mar. 5.—Dr. Getchell gave the anatomy of "Tubercle." He doubted that in all cases the bacillus is the exciting cause. Cases occur where no bacilli can be found. In devoting our attention exclusively to the bacillus we had forgotten the importance of shreds of lung tissue in diagnosis. These can always be found and are sure proof of phthisis. Cheesy degeneration is now thought to be caused by the chemical action of the microbe. It is not characteristic of tubercle alone. Numerous slides illustrating the subject were shown, besides slides of normal in-

jected spleen, epithelioma of the lip, abscess of the kidney, and cervix uteri in anteflexion.

Mar. 12.—Dr. Trowbridge presented the subject of "Addison's Disease," illustrating it by sections taken from a recent case, including skin, supra renal capsule, and kidney. Brown pigment occupying the cells of the rete malpighii, and the usual appearance of tubercular matter in the supra renal capsule were very beautifully demonstrated. The kidney showed a small pus cavity (tubercular?) in one of the pyramids, and numerous small points of round-cell infiltration in the adjacent kidney substance.

—o—

SAN FRANCISCO, CAL.—C. P. BATES, *Secy.*

April 10, 1889.—The announcement of a paper by A. B. Leckenby on the preparation and mounting of insects resulted in a large attendance. Mr. Leckenby spoke briefly of the difficulties experienced in manipulating the numerous forms of insect life for slide-mounting and lantern-projection. The method pursued by him embodies the result of many years' labor.

Starting with the *Coleoptera*, or beetle family, the first step is to de-vitalize them quickly and while they are in flight, which he accomplishes by dropping them through a long glass tube into boiling water. The elytra and wings are by this means immovably fixed in the extended position, and remain unaltered during the subsequent operations. The body of the insect is then injected hypodermically with a strong solution of caustic potash and allowed to remain three or four hours, then transferred to a glass slip and gentle pressure applied, when the viscera and other tissues forming the interior of the body will be expelled. To dehydrate or remove the watery portion absolute alcohol is generally recommended, but the lecturer contended that it was expensive and not always at hand, while equally good results would follow by placing an ounce or two of refined gelatine in a vessel, pouring on alcohol of 95 per cent., and immersing the object for a short time—the gelatine, from its affinity for water, absorbing that fluid from both the object and alcohol. The insect is then placed in oil of cloves to clear or render it transparent, and is ready for mounting permanently in balsam. By this method the insect is rendered entirely transparent, the peculiar geometrical markings of the wings, the abdominal and thoracic rings, and the various parts forming the head and limbs are beautifully displayed.

In preparing the *Lepidoptera* a somewhat different course is pursued, as the wings of all butterflies and moths, being covered with easily detached scales, must be protected. The butterfly or moth is placed on a square of glass and liquid paraffine flowed carefully over the entire insect. After cooling, a small aperture is made, exposing a portion of the body, and caustic potash injected; the subsequent operations being the same as for beetles, excepting that sulphuric ether must be used to dissolve off the paraffine, leaving the soft velvety covering of the wings unimpaired. In this manner are prepared the beetles, dragonflies, bees, wasps, caterpillars, etc., and when mounted in balsam they form some of the most beautiful and instructive objects imaginable, whether viewed through the microscope or projected on the screen. Mr. Leckenby exhibited many fine specimens, noticeable among which

were a gigantic tarantula spider, several gorgeous members of the *Papilio* genus, fierce-looking dragon-flies, beetles, wasps, and a large collection of small objects.

The advisability of holding an annual reception was discussed, and a motion favorable to the proposition carried, the details to be arranged in the near future. Dr. Harkness made some excellent remarks bearing on the subject of microscopical receptions here and in Europe, which were listened to with pleasure, and will probably be stored away in the memory of the prospective committee of arrangements.

The acquisition to the library consisted of the usual microscopical miscellany, while the cabinet was increased by a fine slide of *Mentzelia* from Colorado, donated by Mr. Leckenby.

April 24, 1889.—The regular meeting was held at the rooms, 120 Sutter street, President Payzant presiding. A fine series of photographs was exhibited, containing some graphic enlargements on the new Eastman bromide paper. This process of enlarging on bromide paper, though quite recent, is very popular and produces excellent results, the effect, when exposure and negatives are properly manipulated, being almost equal to steel engraving. The bromide process commends itself to those interested in photo-micrography by its simplicity compared with the tedious work of printing from silver paper.

Mr. Lickenby occupied most of the evening in concluding his practical demonstration of preparing and mounting insects in balsam. It is quite difficult in preparing many of the smaller forms of insects to remove the debris from the surface of the specimen without injuring the delicate portions. This the gentleman accomplishes by the aid of albumen, flowing the white of an egg over the object and immersing the slide in hot water till the albumen is coagulated, when it will generally crack open, and may be removed in two portions, carrying with it all the foreign matter and leaving the surface of the specimen perfectly clean. Another thing strongly advocated is thorough washing of the objects in running water, and a final rinsing in either filtered or distilled water before placing in alcohol. In mounting, the insect is placed under the cover-glass arranged in proper shape, the clearing solution applied, and when sufficiently transparent the oil of cloves is drained away and Canada balsam introduced at one edge of the cover-glass, the slide being held over the flame of a lamp to gently warm the balsam and allow it to flow in and displace the remaining oil of cloves. No annoyance need be felt at the presence of bubbles of air, as they will gradually disappear. The mount when filled with balsam is placed in a warm oven or incubator and kept at a temperature of from 120° to 130° Fahrenheit for twenty-four hours, when the balsam will be thoroughly hardened and all the air bubbles driven out. Mr. Lickenby does not advocate the use of volatile solvents with balsam, he being convinced that a certain amount of gas is always retained in the mount in a latent state, requiring only a slight amount of heat to produce bubbles and disfigure the specimen. The outer skeleton of insects is composed of a substance called chitine, which is quite unique in its chemical composition. It appears to be, within certain limits, very resistant to acids and alkalis, and it is owing to this fact that caustic potash can be used in such varying proportions in treating them for microscopical study. It is said, however, that chitine succumbs to the action of chlorine compounds, which

would render that substance unfit for use in bleaching many of the delicate forms. The Society tendered Mr. Lickenby a hearty vote of thanks for his skilful and instructive demonstrations.

The members are strongly in favor of practical demonstrations and quite a discussion of the matter was indulged in, the result of which may be the inauguration of a movement that will tend greatly to arouse the zeal and add to the effectiveness of future microscopic work.

Examples were shown of *Pleurosigma angulatum*, the negatives of which were taken at a magnification of sixteen hundred diameters.

The donations to the library included a very satisfactory *résumé* of the progress of microscopical investigation both at home and abroad.

NOTICES OF BOOKS.

The Etiology of Diphtheria: An experimental study by T. Mitchell Prudden. (Reprint from *Am. Jour. Med. Sci.*) pp. 50.

This is the best American contribution thus far to the bacteriology of diphtheria. Dr. Prudden first reviews the work done in this field by Loeffler, Klebs, Emmerich, Babes, Penzoldt, Fränkel, D'Espine, V. Hoffmann, Roux, and Yersin. He then records his own observations on twenty-four fatal cases of diphtheria, giving in each case a brief clinical history, the results of the autopsy, and of microscopic examination of affected organs. Then, in each case, careful cultures were made of the various bacteria present.

In nearly every case immense numbers of streptococci were present. Bacilli were few. To such an extent did one form of streptococcus predominate over all other forms of bacterial life that Dr. Prudden is inclined to consider it the cause of diphtheria, at least in this series of cases. He also suspects it to be identical with the streptococcus of erysipelas and phlegmon. However, inoculations with pure cultures failed to produce anything that could fairly be called diphtheria in animals.

Not least in practical value are the experiments testing the power of various germicides. The accompanying colored plates are well executed. The tone of the essay is philosophical and modest. When hundreds of series of such observations shall have been made, and when a medical Daniel shall arise competent to interpret their results, then shall we learn the nature and cause of diphtheria.

Traité de Microscopie Médicale et Pharmaceutique. By Aug. Zune. Bruxelles. 1889. pp. 136.

This is prepared as a hand-book for druggists and doctors wishing to practise microscopy. It omits theoretical and historical matters, and presuming the reader ignorant of the microscope and its accessories, proceeds to instruct him in the most direct manner. It seems to have covered the essentials of the subject in good style. Naturally, it speaks only of European apparatus, and would not be useful to Americans. There are 41 illustrations, including all the principal European stands. The same author will follow with treatises upon various uses of the microscope in medicine and pharmacy. We shall look with much interest for these publications.

The Preferable Climate for Phthisis. By Charles Denison, M. D. (Reprint from the "Transactions of the Ninth International Medical Congress.") Pp. 15.

This is, practically, a plea for the climate of Colorado for cases of phthisis in the first stages, and the plea is a good one. The author accepts with confidence the bacillus theory of Koch, and argues that the bacillus of phthisis works worse ravage in a moist, warm, dense, cloudy atmosphere with equable temperature than in one dry, cool, rare, and sunny with variable temperature. Further, that a clear atmosphere is better for the phthisical patient than the smoke of cities; a rocky or sandy soil better than wet clay; mountains better than plains; frequent electrical changes better than continual stillness of the air; inland better than sea-shore. The argument is well sustained, and we believe that statistics thoroughly back the author's statements. At the close are some contraindications for change to a high altitude, dictated by common sense.

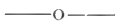

A Vocabulary to the First Six Books of Homer's Iliad. By Professor Thomas D. Seymour. 120 pp. Ginn & Co., Boston. (75 cents.)

Within a hundred pages (12 mo. nearly square) are given all words that one needs. Not only the usual words, but many irregular forms are included and explained, as they should be. The two dozen illustrations are picture definitions of words. This most admirable idea should be more fully carried out. Getting up several hundred such illustrations for the next vocabulary would be expensive, but would be advisable. This is the only improvement worth suggesting in the book, which pleases us very much indeed.

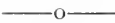

A Hand-book of Rhetorical Analysis. By John F. Genung, Professor of Rhetoric in Amherst College. 12^o, 306 pp. Ginn & Co., Boston. (Price, \$1.25.)

The present Hand-book enables the student of rhetoric to study the principles of style and invention which characterize the writings of the great English prose masters without a long search through dusty volumes. One cannot become a writer, it is justly urged, by learning rules and reading ready-made opinions on style and invention; he must have examples of many different styles before him in order that he may cultivate individuality in his own writings. The aim of this book is to give a practical answer to the question how to study literary models.

Under the two heads of Studies in Style and Studies in Invention is given a series of selections from the best prose writers, including the well-known names of Bunyan, Ruskin, Carlyle, Huxley, Hawthorne, Arnold, De Quincy, Lowell, Addison, Scott, John Stuart Mill, Lord Macaulay, Curtis, and others. At the foot of each page are given complete notes, questions, and references, bringing out whatever is theoretically instructive therein; the whole is so arranged as to illustrate in progressive and cumulative order the various procedures of discourse, from simple choice of words up to the delicate inventive problems of narration and oratory. The lines are numbered for easy reference, and a Directory of Selections is also included.

The clear type, skilful press-work, and neat binding of this volume reflect great credit on the publishers.—R. W. S.

College Botany, including Organography, Vegetable Histology, Vegetable Physiology, and Vegetable Taxonomy. By Edson S. Bastin. G. P. Englehard & Co. Chicago, 1889. 8°, pp. 451. (Price \$3.00.)

From the above title it will be seen that the teaching of botany may now be revolutionized. Just as the first botanists, herpetologists, ichthyologists, ornithologists, and mammalogists amused themselves with collecting, describing by superficial characters, classifying, and identifying specimens, so have we been too much in the habit of rearing students to do the same. Our text-book makers have prepared books with the above object in view and admitted that they had little better to offer. But such will be the case no longer.

Here is a botany that actually gives us the science of plant life and how to study it in all its forms and phases. It introduces us to their minute structure, their organs, and the functions of all these organs. One may now study biology, the science of life, while dealing with plants as effectively as if dealing with animals. One need no longer confine his botanical studies to collecting and identifying plants. This book of Prof. Bastin's ought at once to supersede Gray's *Botany* in all the schools and colleges, and even if Gray's is to be used it should be only in connection with or after Bastin's. This is saying that the student should now devote himself to acquiring a knowledge of vegetable structure as illustrated not only in flowering plants but in cryptogams, ferns, algæ, fungi, lichens, leaving the identification of genera and species to spare moments. The new method will lay for him the foundations of horticulture, agriculture, etc., as the old method never could do.

You have already suspected truly that to be a botanist of Bastin's school one must be a microscopist to some extent. To provide for this he has included a chapter on the use of the microscope and its accessories. The 18 pages of small type devoted thereto are judiciously used.

The whole volume is profusely illustrated, there being no less than 579 figures. Let every teacher procure a specimen copy at once and put the new method into immediate use.

—o—

Force and Energy; a Theory of Dynamics. By Grant Allen. Humboldt Publishing Co. New York, 1889.

This octavo of 55 pages is the January number of a monthly periodical which has now reached Number 106. It is offered at 15 cents per copy and should reach the hands of every physicist. Some of the earlier numbers relating to biological topics would prove valuable to our readers. A catalogue will be found in the April number.

—o—

Essays on God and Man, or a Philosophical Inquiry into the Principles of Religion. By Rev. Henry Truro Bray, LL. D. St. Louis, 1888. 12°, pp. 270.

This book is both radical and conservative in the best sense of these words. It goes to the root of matters, but only to find it, not to pull it up or throw it away. On the themes of which it treats it presents the best that has been thought and written in every age. The style of the author is clear and strong, his temper judicial, his spirit reverent.

He has read widely, thought profoundly, and reasoned closely. The book is one that should be on the table of every religious student. It is simply invaluable as a book of reference.—A. KENT.

NOTES.

Albino Bees.—Mr. J. C. Robinson, of Richford, Ill., states in the *Bee-Keeper's Guide* for February that a well-established breed of albino bees, originating in 1872, is now recognized.

Nervous Influence on Cell Life.—Dr. T. Wesley Mills, of McGill University, contributes to the *Canadian Record of Science* an able paper upon "The influence of the nervous system on cell life," in which he shows by a large array of facts that there is probably a very important connection between the nerve influence upon the cells which make up the body and the proper development of those cells. The brief review of the article which our space would allow is entirely inadequate to give a clear idea of the reasoning of Dr. Mills, but we are constrained to say that his theory would explain many phenomena on the development of organs of the human body not now explained. The article is worthy a wide reading.

The Discovery of the Microscope.—M. Govi, an Italian savant, has presented a paper to the French Academy of Sciences, in which he claims for Galileo the distinction of having discovered the microscope as well as the telescope. He has found a book, printed in 1610, according to which Galileo had already directed his tube fitted with lenses to the observation of small near subjects. The philosopher himself stated shortly after this date that he had been able to observe through the lens the movements of minute animals and their organs of sense. In a letter written in 1614 to a Signor Tarde he states that he has with his microscope "seen and observed flies as large as sheep, and how their bodies were covered with hairs, and they had sharp claws." The date usually assigned to the discovery of the microscope is 1621, and the invention is attributed to Cornelius Drebbel, a Dutchman; but according to M. Govi the date must be thrown back eleven years, and the credit of the first construction awarded to Galileo.

The Microscopical Diagnosis of Cancer.—Dr. Schaeffer, in a paper in the *Jour. Am. Med. Ass'n* for March 23, claims for the microscope an important place in the diagnosis of cancer in its various forms.

Ginn & Co. announce that the sixth volume of their Library of Anglo-Saxon Poetry, Cynewulf's *Elene*, edited by Charles W. Kent, will be ready in May. The introduction will contain an account of the manuscript, author, sources, theme of poem, and versification, particularly of rhyme. The text is accompanied by the Latin original. The notes, intended as aids to the student, will be full. The glossary will be on the plan of Heyne's *Beowulf*.

Slides Received.

We return thanks to the donors for the following interesting slides: *Chromate of Strichnia*.— $5\frac{1}{10}$ gr. strichnia from stomach of frog mounted in Damar. From L. A. Harding, Fergus Falls, Minn.

Star-Fish.—Dorsal and ventral mounts. Prepared by J. D. King, Edgartown, Mass.

Amphipleura pellucida.—Dr. John Sloan, New Albany, Ind.

SUBSCRIBERS' NOTICES.

[These notices will be given six insertions in this column at 25 cents per line or fraction thereof.]
FOR EXCHANGE.—Slides of selected diatoms. D. B. WARD, Poughkeepsie, N. Y.

WANTED.—Unmounted microscopical material, also micrographic dictionary. Will exchange or buy. CHARLES VON EIFF, 124 Clinton Place, New York City.

WANTED.—A clean copy of Rev. William Smith's British Diatoms, and Schmidt's Atlas of the Diatomaceæ. JAMES B. SHEARER, Bay City, Mich.

OFFERED.—Diatomaceous Earth from Utah (Desert) for Histological Mounts. PROF. ORSON HOWARD, Salt Lake City, Utah.

CORRESPONDENCE invited with a view to the exchange of either mounted or unmounted Oribatida (British) for American species. E. BOSTOCK, Stone, Staffordshire.

WANTED.—Specimens of rocks for slicing and grinding into sections; also bones and teeth of different animals, diatoms *in situ* on algæ, diatomaceous and polycystinous earths, ocean soundings, etc., etc. Liberal exchange in microscopic slides or cash.

ARTHUR J. DOHERTY, 63 Burlington St., Manchester, Eng.

TO EXCHANGE.—Native gold, silver, copper, lead, zinc, and other beautiful cabinet specimens, polished ornaments and sections of petrified wood—Chalcedony—and native turquoise, agate, amethyst, rubies, etc.; also Indian ornaments, curios, arrows, blankets, pottery, etc.; pelts of wild animals, species of native cactus, and a good second-hand "Burt's Solar Compass" complete. Any or all of the above are offered in exchange for new, or good second-hand, objectives, condensers, polarizers, stand, or other microscopical apparatus. W. N. SHERMAN, M. D., Kingman, Arizona.

OFFERED.—Zeiss' New Catalogue (in German) forwarded for 10 cents in stamps. F. J. EMMERICH & SONS, 43 Barclay St., New York City.

FOR SALE.—Preparations of Diatoms, the work of I. D. Moller, at 10 cents per slide. E. A. SCHULTZE, Box 56, New York City.

OFFERED.—Diatomaceous earth from Thibet, various localities (12,000 feet); also, material and slides of diatoms from Scottish Highlands, and continental foraminiferæ. WANTED.—Slides of American diatoms, insects, or botany.

W. D. STEWART, 2 Gilmore Terrace, Edinburgh, Scotland.

OFFERED.—Sections of vegetable ivory and slides of crystallized maple sugar. Good mounts taken in exchange. WM. LIGHTON, 106 Fifth Avenue, Leavenworth, Kansas.

WANTED.—Parasites and books on Parasites and other micro. subjects. Will give Anatomical, Pathological, Botanical, Micro-fungi, Zoophytes, Polycistinae, Foraminifera, Parasites, and other slides in return. FRED. LEE CARTER, Gosforth, near Newcastle-on-Tyne, England.

Wanted, Diatomaceous earth from Mégillanes, Bolivia, South America. Can give in exchange either Diatomaceous earth from New Zealand or cash.

E. MICHALEK, I. Fleischmarkt, No. 1, Vienna, Austria.

Mounted sections of Foetal Lung (5 months), sections across entire lobe, $\frac{1}{2000}$ in, thick, beautifully stained, in exchange for first-class pathological slides.

W. C. BORDEN, M. D., U. S. A., Fort Douglas, Utah.

Wanted, earths, recent diatoms, and miscellaneous objects for mounting. Only first-class material offered or desired. MARY A. BOOTH, Longmeadow, Mass.

Fossil Diatomaceous deposits (marine) wanted from Bermuda, Virginia, Maryland, California, etc. I. ELLIOTT, Ardwyn Villa, Aberystwith, Wales, England.

Labels for slides. EUGENE PINCKNEY, Dixon, Ill.

Correspondence relative to exchange in microscopical material or prepared mounts. HENRY L. OSBORN, Hamline, Minn.

First-class Histological Slides for other good mounts; Histological and Pathological material cut on shares. S. G. SHANKS, M. D., 547 Clinton Ave., Albany, N. Y.

FOR EXCHANGE.—Diatomaceous earth from Richmond, Va., Nottingham, & Calvert Co., Md., Los Angeles and Santa Monica, Cal., for other diatomaceous material, crude or cleaned, recent or fossil (marine forms preferred), or for diatom or miscellaneous slides (only good mounts wanted).

F. W. DUNNING, 37 Garrison Ave., Battle Creek, Mich.

WANTED.—A set of Proceedings of the American Society of Microscopists. State price of set or of single volumes, kind of binding, etc. Also, any other microscopical periodicals.

P. O. BOX 630, Washington, D. C.

WANTED.—Any works on Microscopy not already in my library.

H. M. WHELPLEY, F. R. M. S., St. Louis, Mo.

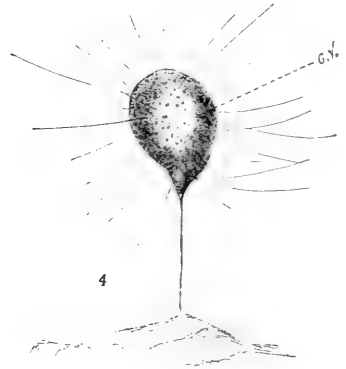
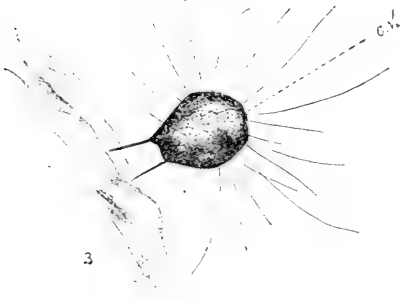
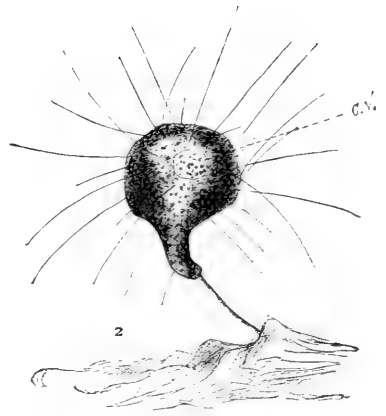
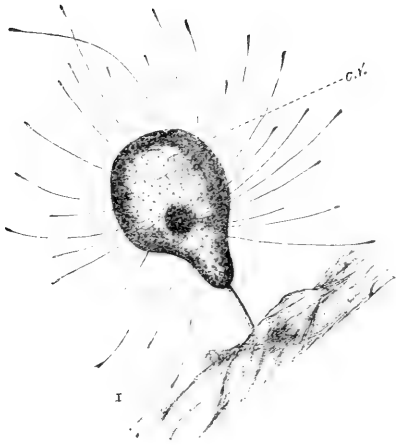

C.V. contractile vesicle.

A TENTACLE-BEARING ANIMALCULE.
MAGNIFIED 700 DIAMETERS.

THE AMERICAN MONTHLY MICROSCOPICAL JOURNAL.

VOL. X.

JULY, 1889.

No. 7.

All communications for this Journal, whether relating to business or to editorial matters, and all books, pamphlets, exchanges, etc., should be addressed to American Monthly Microscopical Journal, Box 630, Washington, D. C.

European subscriptions may be sent directly to the above address accompanied by International Postal Order for \$1.15 per annum, or they may be sent to Messrs. Trübner & Co., 57 Ludgate Hill, London, or to Mr. W. P. Collins, 157 Great Portland street, London, accompanied by the yearly price of five shillings.

Note on a Species of *Podophrya* found in Calcutta.*

By W. J. SIMMONS,

CALCUTTA, INDIA.

All of us who have searched the Calcutta tank waters are familiar with numerous forms of ciliated and flagellate infusoria, but you will agree with me when I say that we less frequently meet with the tentacle-bearing animalcules. The organism I am about to describe belongs to the *Tentaculifera*, and was found by me in a phial of water taken from the "Teencooniah (or triangular) Tank" at the head of Wood street. Our President sent me the bottle, which he had received from the Rev. Father Lafont, about the 10th January. At that time the tank was covered with a red scum of *Euglena*, the organism which is referred to in Dr. D. D. Cunningham's valuable memoir on "The Relation of Cholera to Schizomycete Organisms," p. 10. The rain we had two or three weeks ago broke up this red scum, and when I visited the tank on Sunday week, the 3d instant, there was very little left (along the southern side of the tank), and in this scum a species of *cyclops* preponderated, while the *Euglena* were less numerous and less active. To return, however, to the phial above referred to. On the 16th January I found the dusty debris, composed of decaying *Euglena*, etc., which lay at the bottom of the bottle, contained several *Podophrya*, which I at once placed under observation and sketched. They bear a superficial resemblance to the Sun-animalcule, *Actinophrys sol*, but differ from it in that *Actinophrys* is a free swimmer, while *Podophrya* is fixed to a single, and, in the case of the species found by me, a slender stem. The hyaline rays or tenacles are numerous in this species, and are rather longer than the diameter of the body. The length of the body varies from about $\frac{1}{800}$ th to $\frac{3}{4000}$ th of an inch; its breadth is about $\frac{1}{1000}$ th, and the posteriorly attached stem averages

* Read before the Microscopical Society of Calcutta, on the 14th February, 1889.

from about $\frac{1}{1500}$ th to $\frac{1}{2000}$ th of an inch in length. The form of the body in some of these infusorians as observed by me was ovate, in others pear shaped, or pyriform; both forms are delineated in the plate. The color was whitish, the tentacles and pedicel being hyaline. At the point of junction with the body the pedicel in some cases expanded abruptly, but not in the manner shown in Kent's illustration of *P. Steinii*. In one case only the tentacles presented a knobbed appearance, and in this instance one of them was curved over, as shown in frontispiece fig. 1. Ehrenberg says it is interesting to see this animalcule seize its prey with its tentacula. I noticed several *spirillæ* (with which the water abounded) and other minute particles adhere for a short time to a tentacle; but as they always freed themselves without any apparent injury I did not regard this as the function observed by Ehrenberg, although the curved tentacle was eminently suggestive of the curving tentacles of *Drosera*; and, therefore, of the act of prehension. The bodies of these infusorians are filled with granular protoplasm, similar to that observable in many other animalculæ, and each contains near its upper and free end an active contractile vesicle. In one the granular matter was centrally massed, as shown in one of my sketches.

There are two or three points of general interest to which I may, perhaps, usefully refer in closing. The tentacles of *Podophrya* differ from those of the various species of *Hydra*, one of which Mr. Miles has given us an opportunity of observing to-night. In *Hydra* the tentacles are studded with minute capsules which contain a filament at the base of which there are four minute spines or barbs, employed by the animal to wound its prey. There are also indications of formic acid in the capsules. In the *Acineta* the tentacles bear no such capsules as occur in *Hydra*, but they possess a remarkable suctorial character, which, however, has not been proved to exist in all the species. "When an infusorium touches the button-like end of the tentacle, it usually remains adherent to it; the end becoming still more dilated, so as to constitute a sucking disk, and the ray becomes thicker and shorter, the other rays at the same time making grasping movements and endeavoring to attach their extremities to the captured prey. A current of chyme-particles is then seen running from the captured Infusorium into the body of the *Acineta*. The chyme-particles form at first a slender row, but afterwards collect in a drop. The body of the *Acineta* then becomes opaque from the collection of the drops." (Mic. Dict., p. 11.) Next, as to the contractile vesicle, I would refer those who may wish to study this important subject to Pritchard's Infusoria, p. 312, 4th edition; the Micrographic Dictionary, p. 418, and, necessarily, to Kent's Infusoria, p. 69. Lastly, as to the place to be assigned to *Podophrya* in classificatory systems, chapter vi, of Kent's work, and his remarks in chapter ix (on the Class Tentaculifera: Huxley), will be found useful; though I would also suggest a reference to the articles in the Micrographic Dictionary on *Rhizopoda*, *Radiolaria*, *Acinetina*, *Actinophryina*, and *Podophrya*.

Dr. Lustig, an Italian physiologist, has found in the liver of muscels two kinds of micro-organisms—one harmless, the other very deadly. In the stomach of small animals the latter caused death in 24 hours.

Elementary Histological Studies of the Cray-fish—XIII.

BY HENRY LESLIE OSBORN,

HAMLIN, MINN.

CHAPTER V.—THE EYE.—(*Concluded.*)

4. The Stalk.

1. *The Epidermis.*—A little in front of the basilar membrane a great thickening of the epidermis may be seen suddenly to take place. Here the ordinary calcareous shelly matter of the general surface commences and it forms the coating of the stalk. It, with the cornea, is shed when the peculiar process of moulting or shedding takes place and a new epidermis takes its place, secreted from the layer next beneath.

2. *The Hypodermis.*—This is the living tissue of the skin, that from which the *epidermis* is produced. It presents no features which require our attention.

3. *The Optic Nerve.*—The centre of the stalk is occupied by two kinds of tissue—connective tissue, an inert body used here and everywhere as a skeleton or framework to support the delicate active tissue, the nerve-bundle. This in the lower portion of the stalk is composed of fine parallel fibres, the nerve-fibres, extremely fine bodies traversing the body from the anterior chamber of the eye to the brain. These threads are too delicate and easily injured to show very well in preparations.

4. *The ganglion cells.*—Along the nerve trunk, at various places, and particularly the border, pear-shaped bodies may be discovered. If these are carefully examined under a high power they are seen to be very granular and well stained and to contain a round body or nucleus, less stained but containing numerous very deeply stained particles. These masses of cells may show cell outlines only indistinctly or may show them more clearly as in Fig. 3. (Plate in February number.) In Fig. 2 one of these cells is shown and bits of nerve fibres.

5. Near the basilar membrane nerve-fibre matter, as at 1 and 4, seems to be interrupted by finely granular matter not arranged as through most of the length of the nerve.

6. *Muscles.*—Outside the optic nerve, between it and the hypodermis, may be seen ribbands of striped muscular tissue.

5. **The Interpretation of the observations.**—The physiologist is always upon dangerous ground when he undertakes to interpret from the appearances of sections to the anatomy of organs and then to their mode of working. Some of the facts in the structure of the eye we can readily reconstruct from our sections: the cylindrical stalk and hemispherical anterior chamber, the central nerve and the muscles, the uses of these parts to the muscles for producing the motions of the eye, which we notice so quickly on observing the living creature. But the nervous parts are more puzzling. The basilar membrane is probably a connective tissue substance of somewhat more compact nature than that below, to help keep in place the rods; the ganglion cells of the nerve are connected with the work of transmitting nerve impulses when once they are started in the nerves.

The diagram, Fig. 5, gives from Patten* a view of the eye as under-

* American Journal of Morphology, vol. i, p. 92.

stood by him, and we can read from our Figures 4 and 6 as is done by the referencing in the plate. According to the results of his studies a single nerve fibre passes up through the centre of the crystalline rod, which is composed of four bodies or rods placed together so as to surround the axial nerve. The outer end of the rod comes close against the corneal facet, which, like the rod, is square across. The lower part of the rod is composed of parts of varying density, and these give the peculiar appearance to the pedicle. The rod is surrounded by two sets of pigment bearing cells, one of which surrounds the base or pedicle, and the other the crystalline cone. The former are called retinulæ. In Figure 4 they appear to be very considerably shrunken. According to Patten the pigment is collected in only part of a cell which runs up a thin thread to the corneal hypodermis. In a row outside the eight retinulæ stand four pigment cell embracing the corneal hypodermis. These are shown in Figure 6. These, according to Patten, are collocations of pigment in the outer portion of very fine threads which run the entire distance from the corneal hypodermis to the basilar membrane. In Huxley's account (Vide Cray-fish, p. 119) the parts seem to compare with Fig. 1, as follows:

Outer dark zone=pigment cells; outer white zone=space between pigment cells and retinulæ; middle dark zone=retinulæ; striated spindles=pedicles; crystalline cones=crystalline cones.

While it is possible in a vague and general way to assign uses for some of the parts of this very complex apparatus, it is not easy to be specific. We may say that the corneal facets by their convexity act as lenses and intensify the action of the rays of light by causing more of them to act at once. The crystalline cone by some means comes between the light stimuli and the nerve, which latter without it would not be roused to activity by so weak a stimulation; but how does the rod do that? Perhaps the outer pigment cells prevent the passage of light from cone to cone, an event which we can easily see would greatly interfere with the localization necessary to distinct vision, but there is no evidence that the cray-fish has distinct vision. Perhaps the inner pigment cells are the seat of chemical changes which act as stimuli to the crystalline rods. If so, why do the nerves run to the summits of the cones as they seem to do from the most careful studies? It is not possible to positively say exactly what part each of these structures plays in the cray-fish vision.

We may, however, notice in general that this complicated system of parts connected with the end of the sensory nerve is correlated with other structures of various nature which have the common quality of being apparatuses for the treatment of excitations as of light or sound, which if left to operate upon a bare nerve would be too feeble to affect it. Such are known as sensory end organs; ears and touch organs, and taste organs, as well as eyes, are constructed so as to utilize this principle.

Conclusion.—Since this paper will conclude the series on the cray-fish, it is proper that before leaving the subject a few closing remarks be made. The method of treatment in the series has been rambling but not incoherent, for, as stated in the outset, the intention has been to illustrate the method of histological study rather than to make a systematic course in histology. The comparative simplicity of some

of the organs chosen for the early studies make them especially valuable and convenient for the beginner in histology. Our normal vision unites so much acquired perception with the direct sensation that we do not realize how much more we think than we really see. The microscope requires the beginner to enter a realm where a new series of acquired perceptions must be learned, and hence the value of as simple objects as possible at the outset.

We have examined cells like the green gland, liver, and intestine cells which were secretive in function; the intestinal muscle, motor in function; have studied the ovary with the peculiar egg-cell, the eye with the peculiarities of a sense organ. Muscle and nerve histology are, however, virtually not entered upon by the course. A systematic course ought to include them. The original plan included studies upon material by means of teasing from fresh material, but these studies must be deferred. In place of them we hope soon to present a new course of systematic studies upon mammalian histology. The studies will all of them be as simple as possible, and within the grasp of elementary workers.

EXPLANATION OF THE PLATE IN FEBRUARY NUMBER.

FIG. 1. Longitudinal section of the entire eye and stalk of a small cray-fish.

FIG. 2. Ganglionic matter from optic ganglion.

FIG. 3. Polar nerve cells from the optic ganglion.

FIG. 4. Crystalline cone (from Fig. 1).

FIG. 5. Ideal plan of end organ of optic nerve with accessories (from Patten).

FIG. 6. Actual section from end of optic nerve.

References by letters, etc., as follows:

Ax. n. Axial nerve fibre of crystalline rod.

Bac. Bacillus.

B. m. Basilar membrane.

c. c. Corneal cuticle.

c. h. Corneal hypodermis.

Cr. c. Crystalline cone.

cu. Cuticle.

G. c. Ganglion cell.

Gn. Optic nerve ganglion.

h. Hypodermis.

n. Nucleus of polar ganglion cell.

n. f. Optic nerve fibres.

n. l. Nucleolus of polar ganglion cell.

nn. Naked (?) nucleus.

o. Optic nerve.

Ped. Pedicle.

Pig. Pigment cell.

Ret. Retinula.

Sp. Narrowed spindle of cone.

1, 2, 3, 4. Portions of Optic nerve ganglion.

Hints on Mounting Objects in Farrant's Medium.

By C. M. VORCE,

CLEVELAND, OHIO.

Attention is being turned again to this old but too much neglected medium, the preparation of which on all the published formulæ is attended with much trouble and vexation. The chief difficulty is in filtering the viscous mass, for, notwithstanding the caution always given against stirring the mass to mix it thoroughly, in my own experience the bubbles formed in stirring have uniformly disappeared on long standing in a warm room. Air bubbles in the completed mount, however, exhibit all the obstinacy with which they have been credited when the mass is prepared on the formula commonly given, viz: two parts each by weight of gum acacia and distilled water, and one part of glycerin. The gum is dissolved in the water, the glycerin added, the mass filtered and a little camphor added to prevent mould. This makes a quite viscous mass which quickly dries around the edge of the cover, but from which air bubbles cannot be driven out nor poked out if once imprisoned under the cover.

For such objects as are usually mounted in pure glycerin a much thinner preparation of Farrant's medium is very convenient, and is made by simply increasing the proportion of glycerin to gum. An-

other useful medium, which dries readily but shrinks more than the others, is made by taking by weight 6 parts gum, 4 parts white sugar, 16 parts water, and 6 parts glycerin, prepared as described. A still further modification is made by taking 8 parts gum, 4 parts white sugar, 2 parts gelatine, 20 parts water and 12 parts glycerin. Dissolve the gelatine first, then add the gum and sugar, and lastly, the glycerin. This mass never dries completely hard, but only to a tough, leathery consistence. In all cases a little gum camphor, phenol, clove oil, or thymol should be added to the completed mass to prevent fungoid growth.

In the preparation of Farrant's medium on any formula, much time and annoyance may be saved by making the watery solution of gum, etc., much thinner than it is required to be, and *after filtration* evaporating it to the consistence desired and then adding the glycerin. I always add to the water in the beginning an ounce or so of a weak solution of chloral hydrate, and add gum thymol to the finished mass, a piece the size of a large pin head will do for an ounce of medium.

In mounting in any of these gum media, much trouble is saved by first macerating the object in some of the thin medium for a longer or shorter time according to its nature—longer for dense objects than for thin ones—and then arranging the object on the slip in some of the thin medium, allowing most of the water to evaporate (protected from dust), and then adding the thick medium and applying the cover, using a light spring clip to retain it in place. Air bubbles will not be included by this method.

If a surplus of the medium was used so that much has escaped around the cover, this excess should be cleaned away within 24 hours after the cover was placed, while it is still soft and *tough*. If the cleaning is delayed until the mass outside the cover is *hard*, the cover will often be moved or pulled out of position by the removal of the outer mass. As soon as the partially cleaned slide has become quite dry, the slip should be placed on a turntable, and the slide cleaned *close up to the cover*, using a knife blade or chisel-point to cut away the gum, and a moist rag or folded blotter to finish. Then add successive finishing rings of some resinous cement. Objects thus mounted will prove as durable as balsam mounts; there will be no shrinking or distortion of soft parts as often occurs with objects in glycerin; the most delicate and colorless of structural details are well shown, and the objects photograph extremely well.

Air bubbles need not be included in the mount, but if unfortunately present they may be removed by placing the slide in a beaker or glass vessel in which it can lie flat, putting in distilled water to cover the slide, and after standing a few minutes place the vessel on a sand bath, when the bubbles will soon emerge from under the cover and rise to the surface of the water, the slide is then to be carefully removed, wiped, and some of the thick medium spun round outside the edge of the cover, which will, in drying, fill the space under the cover without admitting any air. This is much better than to remove the cover or to try to poke out the bubbles, as the removal or displacement of the cover is very liable to tangle up and destroy the object.

Short Notes in Practical Biology.—Amœba.

By VIDA A. LATHAM, F. R. M. S.,

UNIVERSITY OF MICHIGAN.

In this paper will be given a few short and concise hints to students who may be interested in this pleasant study, as the summer will afford a good time for material. I have often found that students who, if possible, *can* stay indoors will try to get out for a walk when some slight inducement be given them or there is an object to be found. Not only does this render a walk pleasant, but it improves one's health and spirits, and, what is more, it cultivates observation and patience.

Definition.—Biology is the study of living things. $\beta\iota\omicron\varsigma$ =life, $\lambda\omicron\gamma\omicron\varsigma$ =science. Without pausing to discuss the exact meaning of the word "life," we agree that biology is the study of those forms of matter that are by common consent called living.

Plan of Work.—Nothing should be more strongly impressed upon the young student than the necessity of system in his work. There should be a place for every newly-acquired fact, whether it be gained by reading, from a lecture, or from the observation of the student himself. He should accustom himself to say as each acquisition is made, "that fact belongs to such a division of my plan, fits in under such and such a head." The adoption of such a plan aids in the following ways: (1) By fixing the fact more firmly in the mind, for the very effort to think where the fact is to be located concentrates attention more fully upon it and renders it more easily remembered; (2) by rendering the student more able to recall any special fact that may be required; by enabling him in an examination to reproduce his knowledge with much greater readiness. Asked for the life-history of a hydra, he has not to rack his brain in frenzied fashion in order to collect a number of isolated facts, but goes steadily through his plan placing truths under their respective heads, and finds at the end that nothing of importance has been omitted. I use the following outline, which may be altered to suit requirements:

(*a*) Structure, (*b*) digestion, (*c*) absorption, (*d*) circulation, (*e*) respiration, (*f*) secretion, (*g*) nervous system, (*h*) sense organs, (*i*) motor organs, (*k*) reproduction, (*l*) development, (*m*) classification.

Practical Work.—Every plant or animal must be seen, examined, dissected, and drawn.

Amœba—a Protozoon ($\alpha\mu\epsilon\tau\epsilon\beta\iota\omega$ =I change)—is an animal which consists of only one cell, the equivalent of a single cell of any of the tissues of a higher animal.

a. STRUCTURE.

I. *Occurrence.*—Amœba may be found in sea water and in fresh, stagnant water, in mud, in damp earth. They can be obtained by exposing a piece of raw meat covered with a little water to the sunlight until all the water has nearly evaporated. They *may* then be found in the small quantity of water left, or by mincing very small portions of the surface of the meat with water. When a small quantity of the material containing Amœba is introduced into a glass aquarium and some fresh water added a thin film usually appears on the surface of the water. This film is usually composed of small organisms, some of which are likely to be Amœba. Take with a pipette a small portion of the film, allow a drop to fall on a glass slide. Lay a narrow strip

of moistened writing paper near to the drop, apply a cover glass so that one edge rests on the paper. I have written *may* because *Amœbæ* are very uncertain beings, and one may go for a long time without meeting with any, and at other times have a rich supply. When these fail the student, the white blood corpuscles will do very well as a substitute, and they can always be obtained without much difficulty. It is possible that some *Amœbæ* at least are only stages in the life-history of other organisms.

II. *Size*.—This varies—the average diameter being 5 m.m. But it must be remembered that the different diameters of an *Amœba* are not always the same length. It may be at times much broader or longer in one direction than in another.

III. *General Structure*.—It consists of an irregular mass of protoplasm, but the protoplasm is to some extent differentiated, for nearer the centre of the *Amœba* it is more granular and fluid than near the circumference; hence, we call the inner, more granular, more fluid part, the endosarc ($\epsilon\nu\delta\omicron\nu$ =within, $\sigma\upsilon\mu\tilde{\nu}$ =flesh), the outer, less granular and more solid part, the ectosarc ($\epsilon\nu\tau\tau\omicron\nu$ =without). Yet, *Amœba* is without a distinct wall or membrane. Its ectosarc is only a filmy, rather more condensed part of the protoplasm of which the *Amœba* is made up. Within the endosarc is a more condensed part of the protoplasm, the nucleus or endoplast. At times within this the student may recognize a rounded granule, the nucleolus or endoplastule (*ula*=a diminutive ending).

IV. *Forms of Amœbæ*.—Some *Amœbæ* have shell-like coverings. At times they become surrounded by a sac not unlike the gelatinous investment seen in the still or zooglœa stage of bacteria. Then they are said to be encysted. Lastly, another special form of this organism is occasionally seen, in which the distinction between ecto- and endosarc is but little marked, and the granular structure is not so evident (*Amœba radiosæ*).

b. DIGESTION.

The food of the *Amœba* is mostly vegetable. Low, minute forms of algæ, water plants low in the scale of vegetable life, are the staple comestible. These are taken in by a remarkable mechanism. If a particle of food is near an *Amœba*, that part of the body of the latter which is nearest to the former is protruded as a pseudopodium. This touches the food particle which adheres to it, and as the pseudopodium shortens and is withdrawn to the body of the *Amœba*, once again the food goes with it, and is slowly drawn into the endosarc. There is no mouth. There is not even a defined region that is to serve always as the temporary mouth. Any part of the body may be pushed out and may seize food. This latter, once within the endosarc, passes slowly through the body of protoplasm, growing smaller and smaller, and, after awhile, such portion of it as is not used by the *Amœba* is extended at an indefinite point on the general surface of the body. It will be noticed that here is an advance on the ingestion of food by bacteria, for, in these last, all the surface is concerned; but in the *Amœba* only a part of the surface is concerned in the taking in of any special food piece. This part may be at any region. There is a clear advance in differentiation. *Amœba* gets its organic food-stuff ready made. The tiny vegetable things it eats have beforehand fashioned out of mineral

things an organic food-stuff, to be devoured in its turn by our Amœba. Now the bacteria can make their protoplasm out of mineral matter. Whether we, therefore, consider the nature of the food, or the manner of taking it into the body, Amœbæ present a very marked advance upon bacteria.

c. ABSORPTION.

Again, here is a slight advance. In bacteria this function is blended with that of digestion. But here, after the food has been digested, and whilst it is passing through the protoplasm, or endosarc of the Amœba, the endosarc that immediately surrounds the food particle as it goes on its way must absorb nutritious parts and transmit them to the distant regions of the protoplasm. Thus, even here, far down in the animal kingdom occurs a simple rudimentary but distinct act of absorption.

e. RESPIRATION.

All that applies as to the breathing of bacterium is found in Amœba. The respiratory organs are the whole body surface. No special part is yet devoted to the function of breathing. By the whole surface, O is taken in and C O₂ given out. And here it will be well to pause for a moment and call the attention of the student to a great principle. The lower we descend in our study of living things the more do we find every function performed indifferently by every part. Nothing is specialized. The whole body of cells breathes, reproduces. But as we ascend in our study, certain parts of the body take to themselves certain definite functions, and the higher we ascend the more complex is this "physiological division of labor."

But whilst bacterium only breathes by its general surface Amœba has a special organ for respiration. If the Amœba be carefully watched for awhile in the ectosarc region, a contraction and expansion occurring consecutively will be seen, as if a round window were opening and shutting in steady succession. Now there is a clear round space in the ectosarc, and now the space is lessening and lessening until it becomes a mere speck, and at last has disappeared altogether. Presently, at exactly the same spot, the mere speck will reappear and gradually enlarge until it is a clear round space once more. This space contracting and expanding is called the *contractile vesicle*. As it contracts, it would seem as if lines radiated from it into the surrounding sarcode or protoplasm. This much is certain. That which follows is not so assured. But probably this system of a central space and of canals possibly radiating thence into the protoplasm around is full of water that has air dissolved in it; and probably the system communicates with the exterior so that the water can be changed. These probabilities are based on the knowledge of certain facts known in connection with kindred structures in higher animals. If, then, we have here a pulsating central vesicle with radiating spaces passing thence, and if the whole system contains water holding air in solution, it is possible that thus oxygen is given up to the living active protoplasm into the midst of which the water is pumped, and that the carbon dioxide, that is the chief product of its waste, is removed thence. It is on these grounds that the contractile vesicle is regarded as respiratory. Sometimes this structure appears to consist of two or more vesicles that contract as the canals radiating from them expand.

i. MOTOR ORGANS.

Pseudopodia act as motor organs, for if one of them is protruded from some region of the body of the *Amœba*, it may be fixed at its distal end, *i. e.*, at the end remote from the *Amœban* body, and then the whole of the rest of that body can be drawn up to the fixed part. Thus a crude sort of locomotion may be effected. The pseudopodia are at first wholly of ectosarc. After they have been extended for a little while the endosarc flows into the extension of the outer protoplasm. It is from the numerous changes of form resulting from these extrusions and retractions that the *Amœba* takes its name of "Proteus Animalcule," as Proteus was the shepherd of Neptune, and, much hunted, unfortunate that he was, found it necessary to assume manifold shapes for purposes of disguise. In some *Amœbæ* the pseudopodia are confined to one region of the body of the *Amœba*:

k. REPRODUCTION.

Only agamogenesis is known positively. The special form of a sexual reproduction that appears to be customary is fission or splitting. One *Amœba* is divided into two or more small pieces. Sometimes this division is preceded by encystation, and the *Amœba* first surrounds itself with a gelatinous envelope and then splits up.

l. DEVELOPMENT.

As this act produces at once a being of the same nature as the parent form nothing can be said under this head.

m. CLASSIFICATION.

As *Amœba* feeds on organic things, it belongs to the kingdom ANIMALIA. As it is not made up of two or more cells, it belongs to the sub-kingdom PROTOZOA ($\pi\rho\omega\tau\omicron\varsigma$ = first, $\zeta\omega\omicron\nu$ = animal). As it has pseudopodia, it is of the class RHIZOPODA ($\rho\iota\zeta\alpha$ = root, $\pi\omega\nu\varsigma$ = foot). As its pseudopodium is broad, it is a member of the order LOBOSA. Genus *Amœba*.

PRACTICAL WORK AND SUMMARY.

A. Observe: 1. That the body consists of—(a) A central mass of granular protoplasm (endosarc) which extends into some of the pseudopodia, and usually contains a nucleus, a contractile vacuole, and food particles. (b). A thin, almost transparent, outer film (ectosarc) which contains few granules. 2. The change in form, appearance and disappearance of pseudopodia, and the movements of the granules. Note that the pseudopodia seems at first to consist only of ectosarc, but that as some of them increase in size the granular endosarc flows into them, and further that a pseudopodium may throw out new processes, and then advance, dragging, and ultimately completely absorbing the body and processes behind it.

B. Draw an *Amœba* at intervals of one or two minutes to show the changes of form, and indicate by arrows the directions of the currents of the granules.

C. Examine: 1. The food particles, note they usually lie at first in a small quantity of water (food vacuole), and the food may consist of minute plants or animals, and that in addition to food there are often grains of sand and other substances. Study the process of ingestion of food particles and the expulsion of the non-nutritious particles, and note that they enter or escape from any part of surface. 2. The con-

tractile vacuole, if visible, and watch its pulsations. 3. The nucleus which may be made more distinct by adding a drop of acetic acid (1%) to the preparation, or staining with magenta. The magenta stain is made by dissolving .6 gm. crystallized magenta (rosein) in 1 litre water. Add 6 cc. absolute alcohol.

D. Add to one of the drawings the nucleus, the contractile vacuole, also the food vacuoles, and any foreign substances which may be present.

E. Look for encysted *Amœbæ* and for the *Amœbæ* in process of division by transverse fission.

F. Feed with indigo or carmine, or other finely powdered pigment, and note that food is taken in at all parts of the surface.

Staining Nuclei of Protozoa.—Fix on a slide by means of a drop of alcohol drawn under the cover. Then draw in water, then saturated solution of picro-carmine, and then, after a few minutes, glacial acetic acid. Glycerin being then added, a permanent mount is made. Instead of alcohol, exposure for one minute to the vapor of a 1% solution of O_2O_4 may be used for fixing; but the action of the picro-carmine must be prolonged. I have seen and used it for steutor, kondylostoma, spirostomum, etc., also for protophyta, volvœina, fungi, etc. The particular object is to demonstrate the nuclei.

Staining with Methylen-Blue.—(Certes, *Ibid.*, S2, 2d seri., p. 464.) This stains living protoplasm. Place a drop of alcoholic solution on a slide and allow to evaporate. When evaporation is nearly complete, add a drop of the liquid containing the organisms. As soon as the staining is complete (which is very quick) the drop must be caused to flow away from the spot where the crystals are deposited, and may be covered and examined.

Mounting Amœbæ.—I use a 2% solution of chromic acid, and allow it to act for 2 or 3 minutes, and follow by successive drops of water, 70% alcohol, 90% alcohol, and water. Then stain preparation for 1½ to 2 hours in a moist chamber with a drop of Weigert's picro-carmine. Wash out with 70% alcohol, follow with 90%, then absolute alcohol, clove oil, and balsam.

Bibliography.—Huxley & Martin's Biology. Marshall & Hurst's Practical Zoölogy. Sedgwick & Wilson's Biology. McAlpine's Biological Atlas. J. B. Howe's Biological Atlas. *Am. Monthly Micros. Journal*, vol. 9, p. 91.

ANN ARBOR, MICH., June 16, 1889.

Portable Microscope.—Dr. Ludwig Klein, of Freiburg, Germany, has devised a portable microscope for use in field collecting of algæ or other microscopic material. Much good material is lost, and much poor material is saved, because of the difficulty of microscopic examination on the spot; the laboratory microscopes being obviously unfit for field work. His instrument is a collar carrying a tube into which any objective can be screwed, a stage and a sub-stage mirror, all fastened through a device for clamping them to an ordinary walking stick. The stand without objective or oculars costs 25 marks, or about \$5.00.

Paste.—A good paste for paper on glass or metal is made by dissolving ½ oz. of gum tragacanth and 2 ozs. of gum acacia in 4 ozs. of water, straining, and adding 2 ozs. of glycerin containing 7 grains of thymol as a preservative. Then make up to a pint with water.—H.

The American Society of Microscopists.

BY DR. WM. J. LEWIS, PRESIDENT.

The American Society of Microscopists will hold its twelfth annual meeting in Buffalo, N. Y., beginning Tuesday morning, August 20, 1889, and continuing four days. From the correspondence received by the officers of the organization, a large attendance is already assured. The time set is the week preceding the meeting of the American Association, which will be held in Toronto, Ontario, thereby giving those who are members of both organizations an opportunity to attend the meetings with no loss of time, and at a minimum expense, Toronto being accessible by both rail and water and but a few hours distant from Buffalo.

We are pleased to announce that all outstanding bills of the society have been paid, and it is hoped that the Treasurer's report will soon show a credit cash balance. The Spencer-Tolles fund, already amounting to over two hundred dollars, is safely invested and yielding an income of seven per cent. It is hoped this memorial fund will be largely augmented at our next meeting.

Special arrangements have been made for the display of instruments by dealers, and a large exhibition is guaranteed. This feature offers an opportunity to those members living at a distance from our large cities to become familiar with the comparative merits of European and American stands and the distinctive features of each. The regular sessions will be held in the Buffalo Library Building, which place has also been designated for headquarters.

Those members of the society who expect to present papers, and have not yet notified the Secretary, are requested to communicate with him at once, sending the title, and if possible a brief abstract of their articles, in order that the programme may be arranged in advance. It is also asked that such papers be completed before the close of the meeting, together with drawings for illustration when necessary, that they may be left with the Secretary in order to facilitate the prompt publication of the next volume of proceedings.

It is urgently requested that members bring their microscopes with them for use during the sessions and at the *soirée*. Arrangements have been made for the storage of instruments on the check system in the fire-proof Library Building, in charge of a competent person, where they may be obtained any time between the hours of 7 A. M. and 12 P. M.

The local committee on hotel accommodation announce that reduced rates will be given to members at the new fire-proof Hotel Iroquois. Rates at the Tift House and the Genesee are from three to five dollars per day, according to location of room. Arrangements have also been made whereby members may be accommodated in a few large and well-conducted boarding-houses, where good board and pleasant rooms may be obtained for one dollar per day, with extra accommodations at a slightly advanced rate. Those wishing to take advantage of the special terms offered are requested to communicate with the Secretary of the Hotel Committee, Dr. Louis A. Bull, care the Buffalo Library Building, stating the price they are willing to pay. A circular giving detailed arrangements will be shortly issued by the local committee.

HARTFORD, CONN., *June 27, 1889.*

BIOLOGICAL NOTES.*

Electric Light in Marine Collecting.—The Liverpool Marine Biology Committee, during the month of April last, repeated the experiments of last year, with some variations, to determine the effect of a powerful electric light upon the animals that are taken by various forms of collecting apparatus. After dark two arc lights of 2000 candle power each were suspended over the deck of the steamer used by the Committee and incandescent lights of 50 candle power were fastened in the mouths of the nets that were to be used for collection below the surface. Both the surface and deeper collections showed a much larger proportion of crustaceans than in collections made in the same place the previous day. Cumacea were particularly abundant in these collections, though almost entirely wanting in collections made during the day. The reports do not state whether or not collections were made at similar times without the electric lights.

Experiment Station Work.—The *American Naturalist* for March contains a summary of recent reports of the various experiment stations as regards botanical investigations. We give those of special interest to our readers, and the station and number of the bulletin in which they are found:

“The Structure of the Potato Tuber,” Indiana, No. 15 (Prof. J. C. Arthur).

“A Popular Account of the Organs for the Fertilization of Plants, with Special Reference to the Artificial Pollination of Cultivated Plants,” Minnesota, July, 1888.

“Fungi which Kill Insects,” Minnesota, No. 4 (Otto Lugger).

“Chinch-bug Diseases (*Empusa* sp. and *Micrococcus insectorum*),” Iowa, November (C. P. Gillette).

“Some Injurious Fungi” (Apple Blight, Potato Rot, Grape Rot, and Ergot), do. (Mr. Crozier).

“Club Root,” from Worthington Smith’s “Diseases of Field and Garden Crops,” and

“Sorghum Blight” (*Bacillus sorghi*, Burrill), Kansas, December (Kulst).

“Frosted and Rusted Wheat,” Minnesota, January (Otto I. Lugger).

“Spotting of Peaches” (*Cladosporium carpophilum*, Thuem) and cucumbers (*Cladosporium cucumerinum*, E. & A.), Indiana, January (Prof. J. C. Arthur).

A Plea for Candor.—The discussions which are going on among medical practitioners, regarding the cause of contagious diseases, is even now interesting, and will form one of the curious chapters in the history of the progress of biological knowledge, to which scientific men of the next decade will turn with amusement. The spirit of the discussion even now has a savor of the past. Why should a new theory of the cause of any great evil or calamity be presented or rejected in a spirit of pugilism? If facts well known and thoroughly established by numerous and crucial experiments lead those men who are conversant with the rapid progress of biological knowledge to suppose that a much

*This department is conducted by Prof. J. H. Pillsbury.

broader and more general conclusions can be drawn relative to diseases not yet proved to be due to the same agents, why may we not expect their theories to be presented with moderation and due respect for those who do not accept them? On the other hand, why should men who are, by their own unconscious confession, ignorant of the enormous strides that have been made in the knowledge of the cause of many contagious diseases, antagonize in a spirit of bitterness the conclusions of those who have viewed these diseases from a different standpoint from their own. This fact is worthy of consideration, and by all who do not care to advertise themselves as either quacks or fogies is beyond controversy. A new era in the study of contagious diseases has dawned upon us. Active and impulsive minds make facts mean more than truth war-rants, and conservative minds will adhere to notions long since exploded. But in a case where so much is involved as in the knowledge and treatment of disease, and especially of such diseases as are liable to prove great calamities, the combined wisdom of all intelligent scientific men ought to conduce to results that shall bring blessing to afflicted men.

—o—

Asymmetry in the Human Embryo.—Mr. J. A. Ryder cites M. C. Phisalix* as having discovered that the human embryo in its very early stages lacks perfect symmetry, the left side being larger than the right, especially in the region of the cerebral vesicles, and asking if this is peculiar to man, and bears any relation to the functional predominance of the right side over the left in the adult.

—o—

Rusts.—Mr. H. L. Bolley contributes to the June number of the *Botanical Gazette* an article on the sub-epidermal rusts, *Puccinia coronata*, Cda., and *P. rubigo-vera*, D. C., and their behavior on different hosts.

—o—

The Cause of Yellow Fever.—The March number of the *Sanitarian* copies from the *Memphis Medical Monthly* an article by E. H. Andrews, M. D., entitled "Local Conditions and Yellow Fever," in which he attempts to show from the discussion of the circumstances attending the outbreak of the fever at Canton, Grenada, Memphis, and Jackson, Miss., at periods from 1855 to 1888, that the disease must have been due to local conditions, and not to imported germs. These circumstances are such as afford exceedingly favorable conditions for the development of such germs if once introduced, and do not prove that they may not have been introduced from without.

The means of introduction of germs of bacteria, or even the bacteria themselves, in appreciable quantities are so numerous that it is absurd to suppose that every possibility is excluded, even when there seems to be not strong probability that such circumstances have occurred.

—o—

Tuberculosis from Cows.—A committee of the Dominion Parliament has concluded its labors and, having decided that infection is communicated to man through the flesh and milk of cows, will recommend precautionary legislation.

* Etude d'un embryo humain de 10 millimetres.

MEDICAL MICROSCOPY.*

The *Annals of Gynecology* for June contains some excellent photomicrographs of normal and diseased mucous membrane of the Fallopian tube. The formation of glandular pockets, penetrating into the muscular tissue in chronic salpingitis, is well shown. Other photographs are promised for July. Considering the importance now assigned to chronic salpingitis, anything that throws light upon its histology is welcome.

—o—
Development of the Crystalline Lens.—The *Brooklyn Medical Journal* for June contains a paper with the above title by Dr. Richmond Lennox. The various stages in the embryonic development of the lens are clearly described in the text, and following are 34 figures illustrating sections (highly magnified) of the eye of the chick, calf, and child from the time of formation of the medullary groove on the second day of incubation to the time of full development. We call this fine work. The merit of the paper is that it makes plain to the student of embryology the development of this organ, and the plates are really artistic. Incidentally the theory of the formation of congenital cataract is explained.

—o—
The same journal also contains a lecture by Dr. Sternberg on "Disinfection," and a paper by Geo. T. Kemp, Ph. D., on "Bacillus Tuberculosis and Diathesis in Pulmonary Phthisis." The latter is an answer to Dr. Hull's article in the number for October, 1888, and insists upon the importance of diathesis and environment in the production of phthisis. Altogether the June number is very valuable.

—o—
Motor Centre for the Larynx.—Dr. D. B. Delavan is still working at the problem of a "Cortical Motor Centre for the Human Larynx." In the *N. Y. Medical Journal* for June 22, 1889, he reports an interesting case bearing upon this point. The patient had hemiplegia in 1877. All the symptoms of paralysis gradually disappeared, except that the abductor laryngeal muscles of the left side remained paralyzed until death, which occurred from other disease in 1888. A careful post-mortem, with microscopic examination of brain and medulla, was made. The principal lesion discovered was a softened tract in the left side of the medulla about the root strands of the vagus nerve, and involving the ventral vagus nucleus. The case, therefore, seems to confirm the motor character of this nucleus, and to leave the question of a cortical motor centre for the larynx still open. A parallel case, with identical lesion, is referred to, reported in *Archiv für Psychiatrie*, 1888, p. 314.

—o—
Scalp Diseases.—A frequent cause of the falling out of hair is the number of diseases of the hair and scalp which are positively known to be contagious, the germs from which they spring having been fully defined under the microscope.

* This department is conducted by F. Blanchard, M. D.

Mercury, Cyanide, and Oxy-cyanide.—These two mercury salts bid fair to come into marked prominence now; and recent experiences point especially to the Oxy-cyanide as being destined to supplant the Corrosive Sublimate. According to Chibret, it is exhibited in solution of 1 : 1500, and is tolerated far better than the bi-chloride. Also for the disinfection of surgical instruments it shows a superiority to the sublimate, in not attacking the metal, when used in solutions of same strength as the sublimate. In the disinfection of bacterialized Peptone-fluid, it exhibited *six times the bactericidal force* of the Bi-chloride; that is, a solution of Mercury Oxy-cyanide of 1 in 12,000 acted equally to one of Mercury Bi-chloride of 1 in 2,000.—*Merck's Bulletin*.

Pasteur Institute.—This building, in Paris, was commenced in May, 1887, and has cost \$600,000. Dr. Roux directs the department of micro-biology. In the immense work-room are seven tables with tops of enamelled lava. Each table is large enough for two students to occupy themselves with microscopical studies.

Infected Books.—The circulating libraries of Dresden have experimented upon the communication of infectious diseases by books. Soiled leaves of books were rubbed first with dry fingers and then with wet ones and the result microscopically examined. Few or no microbes were found on the dry finger, but many on the wet finger. Those microbes found were not infectious, but why might not infectious germs be transmitted in this manner?

Microscopic Examination of Liver and Kidneys for the Germ of Yellow Fever.—Both smear-preparations and sections are marked by the presence of a most plentiful representation of an ovoid germ with distinct belted appearance and sharply-colored pole ends, the normal length being twice as long as wide. Some individuals are three or four times longer than wide, this increase in length being entirely due to an increased amount of the afore-mentioned uncolored substance. In some instances two, three, or four of either of the above-described forms are to be seen attached together, forming short chains. Such a short chain is at other times composed of both these of forms united together, there being more of one and sometimes more of the other in the same.

The organisms appeared, as this variety always does, in the sections of organs, some of them end on, when they looked like cocci; beside these would be others lying horizontally, which presented their complete form, the colored pole-end and clear centre being distinctly visible; in many localities they were united in pairs, while many of the liver cells contained large numbers of them. Here and there one would find a capillary embolus made of nothing else; here they frequently grew in filaments of considerable length, large clusters of such being present; occasionally single filaments were to be seen in capillaries which the section had cut horizontal to their course, but in general, except in the embolisms, they were seen in pairs or groups of three members. Capillary embolisms were more frequent in the kidney than in the liver.

No other micro-organisms were present, notwithstanding numerous sections of the same tissues were subjected to very many tinctions used in this work.—*Frank S. Billings in The Times and Register, June 1, 1889.*

BACTERIOLOGY.*

Staining Reagents.—The stains employed in bacteriological studies, with, perhaps, a few exceptions, are the aniline dyes introduced by Weigert. Flügge ("Handbuch der Hygiene," Pt. I, Fermente und Microparasites, p. 287), on the authority of Ehrlich, classified the aniline colors into two distinct groups, each of which has very distinct chemical and physiological characteristics, the acid and the basic dyes.

In the first group the coloring matter acts as an acid in combining with bases to form salts, although it does not necessarily give an acid reaction, nor is it necessarily in the form of a free acid. Among the more important are eosin, picric acid, aniline black, and purpurin.

To the second group, the basic dyes, belong by far the greater number of those which are used in staining bacteria. These are principally fuchsin, methyl violet, methylene blue, Bismarck brown, and gentian violet. These basic colors are sold as salts and not as free bases, whilst fuchsin, for example, may be obtained as an acid salt, as chloride, or acetate of rosaniline.

With these nucleus and germ-tinting reagents both nuclei and bacteria can be stained red, brown, blue, or violet, according to the stain employed, for, as a rule, micro-organisms react to staining fluids very much as do the nuclei of cells. This holds good in so far that most nuclear stains will impart a similar tint to the micro-organism as they do to the nuclei themselves. Beyond this, however, it is found that the micro-organisms hold the coloring matter more tenaciously than do the cell nuclei, and that the nuclei may be decolorized by the use of certain reagents, such as acetic, nitric, or hydrochloric acid.

The first experiments on staining germs were made with carmine and hæmatoxylin, and Koch and others were successful in staining not only the bodies of bacteria, but also, in certain cases, in demonstrating the flagella. These reagents are now, however, superseded by the aniline colors, principally the basic series.

Weigert's gentian violet and picro-carmine method demonstrates the affinity of the basic aniline colors. The sections of tissue containing bacteria are first placed in gentian violet (saturated alcoholic solution of gentian violet, 11 cc., aniline water, 100 cc., absolute alcohol, 10 cc.) for several minutes, then washed in alcohol, transferred to water, and afterwards to Weigert's solution of picro-carmine for half an hour.

They are further washed, first in water, then in alcohol, are clarified with clove oil and mounted in balsam. By this method the nuclei are stained red and the bacteria violet; the carmine has replaced the gentian violet in the nuclei, but has had no effect upon the violet taken up by the bacteria. In a similar manner a solution of iodine and iodide of potassium does not remove the basic colors from certain micro-organisms, but it rapidly decolorizes nuclei and other tissues. It is upon this fact that Gram's method is founded.

Weigert's Picro-carmine.†—Add aqua ammonia, 4 grams, to carmine, 2 grams, and allow it to stand for twenty-four hours in a damp place, and then add 200 grams of picric acid. Allow the whole to re-

* Conducted by V. A. Moore.

† Dolley; Technology of Bacteria Investigation, p. 251.

main for twenty-four hours longer, until all is dissolved that will dissolve. Filter, and to the filtrate add a small quantity of acetic acid, until it becomes turbid. After twenty-four hours more there is a precipitate, and the filtered fluid also remains turbid. Now add ammonia, drop by drop, and allow the solution each time to remain for twenty-four hours, until at length, in the course of a few days, it remains entirely clear. If the neutral solution stains too yellow, add a little acetic acid; if too red, a little ammonia.

EDITORIAL.

The American Society of Microscopists will meet this year at Buffalo, N. Y., holding a four days' session, August 20-23 inclusive. In another column will be found the President's official announcement. We hope our friends will at once decide to go and make vacation arrangements accordingly.

Special Creation.—"If each of the half million of species of animals and plants which now live, and each of the millions of kinds which have become extinct, has been the subject of a 'special creation,' then special creation is but a name given in our ignorance to the law by which species are produced," says Professor Jordan.* If the law is not correctly expressed by the Darwinian theory, let the objector state it more correctly. But this criticism of special creation might be still more plainly put, somewhat as follows:

A species exists only upon paper—not in nature. What does exist in nature is a group of forms nearly alike, and not differing from each other beyond a given amount, and which, merely for convenience, we describe on paper as one species. A group which one naturalist calls one species may be divided by another naturalist into two or more species. Certain forms are so like to two different species as to make it questionable to which of the two they belong. Varieties are therefore spoken of. The claim of "special creation," which cannot well apply to species, might more properly be claimed for varieties. But what has been alleged above of species applies in less degree to varieties. From this it follows that individuals alone exist in nature with such fixedness as to permit the claim of special creation, and to them its claim would better be transferred. But the law of production of individuals is well understood, and if it suits anyone better to denominate that law "special creation" than to call it "evolution," good and well. A rose by any other name would smell as sweet. What's in a name?

Mrs. Louisa Reed Stowell, who is so well known to all microscopists, has been appointed as an assistant to the Botanist in the Department of Agriculture. This will add another to the group of working microscopists in Washington, and, we hope, to the friends of this JOURNAL. We extend to her a cordial greeting and best wishes for success in her new field of labor. Our Washington Microscopical Society has never yet had a lady's name on its rolls. Now is a good time to make the innovation.

* Darwinism.—A brief account of the Darwinian Theory of the Origin of Species. By David Starr Jordan, Ph. D., M. D. A. B. Gehman & Co. Chicago, Ill., 1888.

Our Artist.—We beg to introduce the young man who has made the drawings from which the frontispiece in the present number, as well as that in the April number, was photo-engraved—Mr. Robert W. Smiley—the son of the publisher. Mr. Robert, who is quite recently from school, takes much interest in our illustrations, and promises some good work hereafter. He has owned and used one of Crouch's Histological Microscopes since he was 15 years old, and to those who fear to put a valuable instrument into a boy's hand we may say that it is still uninjured and practically as good as new.

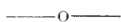

Our Correspondence.—We are constantly getting letters that contain items of more than passing interest. The writers do not prepare the letters with the view to their being published, but we trust that they will in no case object to our inviting the microscopical world to a participation in their good thoughts. The extracts to be found in this number are a fair sample, and have been called to present the most matter in the smallest space. In future those who do not want their letters so treated can protect them by the heading "Confidential." On the other hand, if something in your letter which is as good as what we do print gets overlooked, do not feel slighted, because space is lacking at times and opportunity at others.

To those who do not always get their replies to business letters by return mail, or each number on time, we ought to explain that this periodical has to be managed in such spare moments as we can snatch from our regular and other occupations by which latter we earn our daily bread. In other words, the JOURNAL does not pay such profits as to permit one to devote his life to it. When we go out of town its correspondence has to await our return, and we sometimes get an accumulation ahead that requires time to clear away, and we are going out of town in August, if possible. Patience then, friends, or a doubling of the subscription price for clerk-hire, whichever you prefer! The more the business grows the more are we taxed to keep up with it, and yet the happier are we.

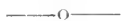

Unreasonable Requests.—We are continually passing by requests of this sort with such replies as time will permit us to make. A dealer in microscopical goods, whose patience had become almost exhausted, recently showed us a letter which ran as follows:

"You say the instrument magnifies 100 diameters. You will send me a magnified representation of some very small object; for instance, a small drop of blood, showing plainly the corpuscles, or a very fine hair. I send you one from my head, which I consider about as fine as Mother Nature makes."

The curious thing is that people who ask such favors cannot possibly be convinced that their requests are in any degree improper.

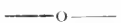

The Army Medical Museum, at Washington, D. C., contains 141 microscopes, 10,416 microscopical specimens illustrating almost every field of microscopical work. Many were made 20 years ago. Dr. Gray is in charge of this section. There are also many cultures of bacteria.

EXTRACTS FROM CORRESPONDENCE.

White's Botanical Sections. By E. C. Hoyt, Detroit, Mich.

FRIEND SMILEY: Although directly antagonistic to my advertisement and desire to dispose of a few surplus slides, I am too good a friend of the cause to refrain from saying that you have done more to make yourself popular in selling these prepared sections than you realize. They are simply grand, and anyone is foolish to buy prepared mounts in the botanical line at over 10 cents each. I have spent hours advertising these preparations for love of the cause.

The Journal for June: Postal Club Reports. By S. Lockwood, Freehold, N. J.

Permit me to say that the current number is admirable. I am glad that in the race of competition the JOURNAL shows such good wind. I hope the racy sketches on the Postal Club by Queen Mab will be kept up, and not the least interesting is the simple record you are in this way giving of the modest notables who have gone to the waiting land.

Instantaneous Changes of Field. By Wm. Lighton, Leavenworth, Kans.

I have made quite a valuable discovery lately in connection with wide-angle homogeneous immersion lenses. By means of a very simple piece of apparatus instantaneous changes from dark field to light field and back again are obtained with the largest numerical aperture possible, and works equally well with dry lenses of any power and aperture. The effects obtained with it are wonderful, and are obtained without altering any adjustment of the microscope.

Would you like a drawing and description of it for the JOURNAL? [*Yes!*—EDITOR.] It is quite likely Messrs. Watson & Sons, of London, will take it in hand.

The H. R. Spencer Optical Company. By H. R. Spencer, Cleveland, Ohio.

We take pleasure in announcing that the firm of H. R. Spencer & Co. is dissolved by mutual consent, and the business is reincorporated as the "H. R. Spencer Optical Company, of Cleveland, O." It is in reality a material expansion of the business so long established. It is our intention to supply a most complete line of microscope objectives for general work, as well as those adapted to special lines of research, and any inquiry or application for advice relating thereto will be cheerfully answered. Continuing the manufacture of the celebrated microscopic objectives, we would announce our greatly increased facilities for the manufacture of telescope objectives from the formulæ devised and worked out by the late C. A. Spencer and Herbert R. Spencer, the results of which have received such high commendation from astronomers and opticians.

Information for Scientists about to Visit the Paris Exposition. By J. W. Queen & Co., Philadelphia, Pa.

We have representatives in Paris who have had the experience of many years in the selection and purchasing of scientific apparatus of every

description for college use. In consequence of this, it may be a convenience to microscopists when in Paris this summer to be supplied with letters of introduction. By means of such letters, those professors who intend purchasing instruments will have the assistance of competent persons, who are well acquainted with all the prominent makers, their apparatus, and prices. Thus much valuable time may be saved that might otherwise be spent in hunting up dealers and making bargains with them—a rather unsatisfactory operation, especially to those not thoroughly conversant with the French language. Furthermore, it is often a great inconvenience and annoyance, after apparatus may have been purchased satisfactorily, to attend to the details of shipping and passing through the U. S. custom house “free of duty.” Messrs. Queen will relieve purchasers entirely of all this care, so that they need have nothing to do but select the apparatus. Another advantage of this arrangement is that there need be no expenditure on the part of colleges at the time of ordering microscopes, etc., but, instead, they will send invoices when the goods are shipped from Philadelphia, adding to the maker’s prices only the cost of importation. Apparatus so ordered will be forwarded in weekly shipments as soon as a few pieces are ready, thus saving much time. More time is required to make some pieces than others, and when they are all held for one large shipment in order to reduce freight charges the delay is often very annoying.

MICROSCOPICAL SOCIETIES.

MICROSCOPICAL SOCIETY OF WASHINGTON, D. C.

May 14, 1889.—The fifth annual soirée was held at the High School building. Dr. G. N. Acker, the President of the Society, delivered the annual address, after which the members of the Society and their friends were entertained with the following exhibits:

By Dr. G. N. Acker, with Zeiss and Hartnack; section of human lung, double injection, section of human skin.

By Dr. E. A. Balloch, with Zentmayer’s Histological; Ova of *Trichocephalus Dispar* in liver of rat.

By Dr. I. W. Blackburn, with Zentmayer; Actinomycosis, and Actinomyces in human pus, which is a disease of the lower animals communicable to man. Caused by the Ray fungus.

By Prof. E. S. Burgess, with B. & L.’s models and specials; leaf of Saxifrage, *Saxifrage virginicensis* of Michaux (the different parts were shown successively under five instruments), epidermis of thin, flat cells with lace-like walls, Stomata or breathing pores (showing two elastic guard-cells to open or close the aperture), Palisade-cells filled with chlorophyll veins (which give the green color to the leaf), vein of the leaf (showing the fibrous tissue and duct to convey air, strengthened by spiral fibres), protoplasm within an inner cell.

By Dr. C. T. Caldwell, with B. & L.’s Universal and Student; Barbadoes Polycystina, book mite.

By Mr. F. T. Chapman, with B. & L.’s Professional; electric spark through metal filings.

By Dr. A. B. Coolidge, with B. & L.’s Universal (Binocular); bouquet of butterfly scales.

By Dr. H. A. Dobson, with B. & L.'s Student; honey bee (the various parts).

By Mr. H. H. Doubleday, with Crouch Binocular, and Zentmayer; So diatoms arranged, Salicine (polarized light).

By Prof. R. Foster, with Crouch Binocular; circulation of blood in external gills of tadpole.

By Dr. R. A. Foster; section of human brain.

By Dr. E. A. Gibbs, with Beck's Ideal and Acme No. 3; action of the heart in an embryo snake, transverse section of intestine (showing villi).

By Prof. R. Hitchcock, with Schrauer and Bulloch's Binocular; microscopic pond life, circulation of blood in young fish.

By Dr. D. S. Lamb, with B. & L.'s Harvard and Beck's Economic; embryo hand showing serial sections (one two-thousandth inch thick), the Lord's Prayer, written by Mr. Webb.

By Dr. J. M. Lamb, with B. & L.'s Universal; transverse section of spinal cord. Dr. Lamb also illustrated the method of cutting serial sections embedded in paraffin.

By Mr. V. A. Moore, with Zentmayer's Binocular; cultures of micro-organisms, colony of bacilli.

By Dr. Collins Marshall, with Acme No. 3; type-plate of diatoms, being the siliceous coating of aquatic plants.

By Dr. S. J. Radcliffe, with Beck's Popular Binocular; voluntary muscle (injected, showing the striæ and distribution of the capillary system), stomach of frog (injected, showing the villi and glandular apparatus).

By Dr. Robert Reyburn, with Queen's Household and Beck's Popular; iodo-sulphate of quinine by polarized light, ova of *Lymnœa Stroganalis*, eggs of water snail (showing internal organs and circulation of blood).

By Dr. H. A. Robbins, with Reichert; Arytenoid cartilage, photo-micrograph (Uncle Tom and little Eva).

By Dr. W. H. Seaman, with Zentmayer's Large and Beck's Large (best); Bryozoa (the calcareous shells of small marine animals), "Rolling Stones" (quartz sand), with polariscope.

By Mr. A. N. Skinner, with Zentmayer's Histological; circulation of blood in the web of frog's foot.

By Mr. C. W. Smiley, with Crouch's Histological; Hydrozoa.

By Dr. Thomas Taylor, with Acme, Zeiss, and Gundlach; stomata of tea leaf, crystals of human fat by polarized light, transverse section of leg of mouse. Dr. Taylor exhibited also his new freezing microtome, and demonstrated both section-cutting and photo-micrography.

By Mr. Clinton Townsend, with B. and L.'s Physician; Vorticellæ or bell animalcules (a curious infusoria, which obtains its food by making whirlpool-like currents by means of vibrating ciliae).

By Dr. L. D. Wilson, with B. and L.'s Physician; section of kidney from cat.

By Mr. F. B. Wright, marine algæ (in fruit).

By Dr. G. B. Young, with B. and L.'s Universal; Foraminifera (arranged).

The yearly soirées which many microscopical societies are in the habit of giving for the benefit of the public cannot be too highly com-

intended. That people generally are beginning to appreciate the importance of the microscope was fully demonstrated by the large attendance at this exhibition, and, although many people are most attracted by the popular displays and by specimens illuminated by polarized light, and though there are some of the guests who cannot refrain from fingering the apparatus, notwithstanding the sign, "Please do not touch the microscopes," yet, after all, they perform a vast deal of good in helping to educate and elevate the public taste.—R. W. S.

NOTICES OF BOOKS.

Two Great Retreats. Grote and Ségur. 12°, 318 pp., two maps. Ginn & Co. Boston. (Price, 60 cents.)

Designed for use in the school-room, as well as for general reading, and to present standard literature in a form both instructive and interesting to young readers, this well-known firm has, for the past few years, been issuing a series of books entitled "Classics for Children." The volume before us is one of these.

Xenophon's Anabasis, or the retreat of the Ten Thousand Greeks, as narrated by Grote in his history, is given entire with some slight changes, in order to better adapt the book for school use. The second great retreat is that of Napoleon from Moscow, it being an abridgment of Count Ségur's narrative.

Considering the motives which actuated both Cyrus and Napoleon, namely, a desire to acquire despotic rule, their invasions were failures; yet, from a military standpoint, they were of intense interest, and will continue to attract notice because of the great suffering endured.

No more thrilling recitals of soldierly effort and disaster could be selected. The character of Xenophon stands out in marked contrast to that of Napoleon when confronted with defeat.

A short sketch of Cyrus the Younger, the originator of the attempt to overthrow the Persian Empire, is included, as is also a brief review of Napoleon's career.

Numerous notes are given at the bottom of many pages for the purpose of eliminating the obscurity from certain passages.—R. W. S.

English, Past and Present. By Richard Chenevix Trench, D. D., Archbishop of Dublin. The Humboldt Pub. Co., 28 Lafayette Place, New York.

This is another standard work added to the Humboldt Library Series—a work that has had a sale second only to "The Study of Words" by the same distinguished author. Twenty editions of the latter and thirteen of the former are the best evidences of the popularity of the works. The English language is spoken in almost every country of the globe, and seems destined to be the universal language of the next century. It was the language used at the late conference in Berlin, supplanting French, until now the language of diplomacy. A most interesting study, therefore, is the history of the English language, past and present.

Force and Energy; a Theory of Dynamics. By Grant Allen. Number 106, Humboldt Library of Science. Published by Humboldt Publishing Company, 24 East 4th street, New York.

This is a work in two parts enclosed within one cover. The first

part advances a theory of transcendental dynamics, which, in the last part, is applied to the creation of the universe. The author defines force and energy as the two manifestations of power; the first, tending to initiate aggregative motion, finding its expression in gravitation, adhesion, chemical affinity, and imperfectly comprehended electrical affinity, and the second showing its vitality in the separative powers classified as molar, molecular, chemical, and electrical modes or manifestations of motion. The illustrations of the operations of these antagonistic powers in aggregating the universe into more or less solid globes on the one hand, and in hurling these globes through their orbits on the other, are very instructive; but it is not suggestive of comfort for some far distant posterity to know that Mr. Grant Allen believes that the aggregating forces are continually proving too strong for the separative energies, and that the satellites are being continually drawn into the planets, the planets into the suns, and the suns themselves into some invisible and unknown centre of the universe.

Practical Microscopy. By Geo. E. Davis. London, 1889. 8°, pp. 436, 310 figures, 1 plate.

This is a revised edition of the author's earlier work, and seeks to furnish full information about the instrument, its use, mounting, etc. The colored frontispiece shows double-stained sections of several kinds of wood—clematis, dog rose, eucalyptus, gout weed, black pepper.

Virginia Summer Resorts on the Norfolk & Western R.R. Published by the Company. 12°, pp. 44.

This very neat pamphlet describes and illustrates a large number of resorts. It is apparently for free distribution upon application to W. B. Beville, General Passenger Agent, Norfolk, Va. Visitors to the Blue Ridge will find it useful.

SUBSCRIBERS' NOTICES.

[These notices will be given six insertions in this column at 25 cents per line or fraction thereof.]
FOR EXCHANGE.—Slides of selected diatoms. D. B. WARD, Poughkeepsie, N. Y.

WANTED.—Unmounted microscopical material, also micrographic dictionary. Will exchange or buy. CHARLES VON EIFF, 124 Clinton Place, New York City.

WANTED.—A clean copy of Rev. William Smith's British Diatoms, and Schmidt's Atlas of the Diatomaceæ. JAMES B. SHEARER, Bay City, Mich.

OFFERED.—Diatomaceous Earth from Utah (Desert) for Histological Mounts. PROF. ORSON HOWARD, Salt Lake City, Utah.

CORRESPONDENCE invited with a view to the exchange of either mounted or unmounted Oribatida (British) for American species. E. BOSTOCK, Stone, Staffordshire.

WANTED.—Specimens of rocks for slicing and grinding into sections; also bones and teeth of different animals, diatoms *in situ* on algae, diatomaceous and polycystinous earths, ocean soundings, etc., etc. Liberal exchange in microscopic slides or cash.

ARTHUR J. DOHERTY, 63 Burlington St., Manchester, Eng.

TO EXCHANGE.—Native gold, silver, copper, lead, zinc, and other beautiful cabinet specimens, polished ornaments and sections of petrified wood—Chalcedony—and native turquoise, agate, amethyst, rubies, etc.; also Indian ornaments, curios, arrows, blankets, pottery, etc.; pelts of wild animals, species of native cactus, and a good second-hand "Burt's Solar Compass" complete. Any or all of the above are offered in exchange for new, or good second-hand, objectives, condensers, polarizers, stand, or other microscopical apparatus. W. N. SHERMAN, M. D., Kingman, Arizona.

OFFERED.—Zeiss' New Catalogue (in German) forwarded for 10 cents in stamps. F. J. EMMERICH & SONS, 43 Barclay St., New York City.

WANTED.—Any works on Microscopy not already in my Library. H. M. WHELPLEY, F. R. M. S., St. Louis, Mo.

WANTED.—(In exchange for slides.) "Microscopical Bulletin," Vol. I, No. 5, August, 1884, and Vol. II, No. 1, February, 1885. M. S. WIARD, New Britain, Conn.

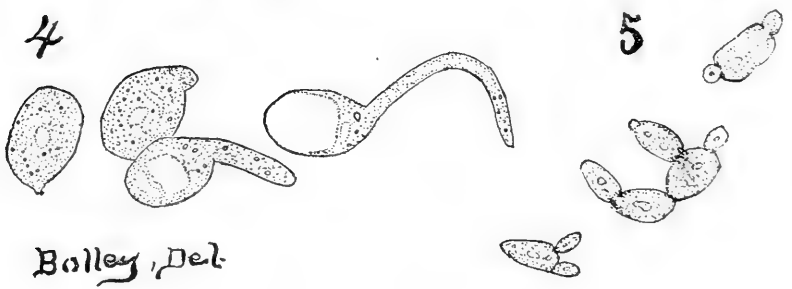
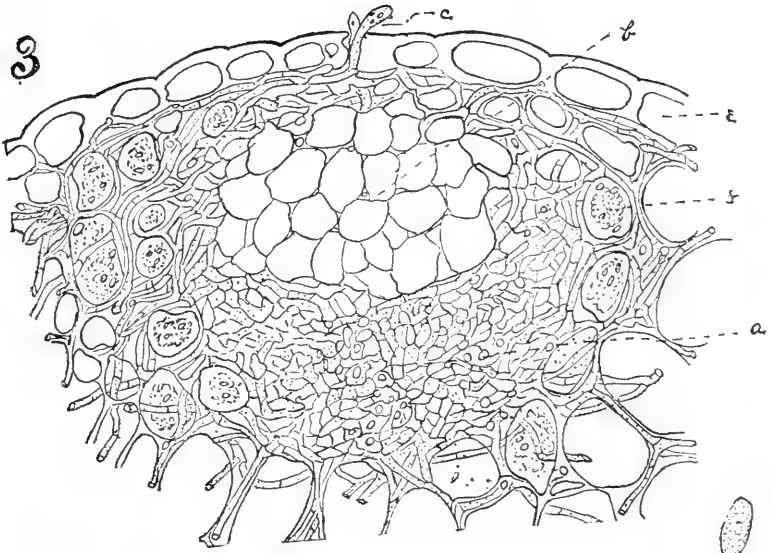
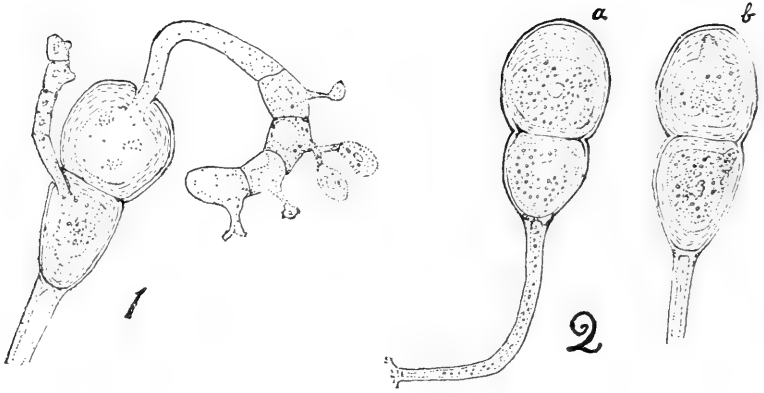

Bolley, Det.

SPORES OF PLANT RUSTS.

THE AMERICAN MONTHLY MICROSCOPICAL JOURNAL.

VOL. X.

AUGUST, 1889.

No. 8.

All communications for this Journal, whether relating to business or to editorial matters, and all books, pamphlets, exchanges, etc., should be addressed to American Monthly Microscopical Journal, Box 630, Washington, D. C.

European subscriptions may be sent directly to the above address accompanied by International Postal Order for \$1.15 per annum, or they may be sent to Messrs. Trübner & Co., 57 Ludgate Hill, London, or to Mr. W. P. Collins, 157 Great Portland street, London, accompanied by the yearly price of five shillings.

The Heterœcismal Puccinia.

By HENRY L. BOLLEY,
LAFAYETTE, IND.

Of the various orders of the fungi, the Uredineæ, or what are commonly known as the rust parasites, are of present interest to the scientist, in that, in their as yet comparatively unknown life-history, development, and relations to other life, many facts lie still unearthed, and to the agriculturist and horticulturist because the destructive capabilities of these pests are becoming more and more a matter of financial importance.

Upon passing through fields of ripening wheat or other of the small grains, one may often be not a little surprised to find that his clothes have become quite thickly besprinkled by a yellowish-brown dust which has fallen from the plants. This is an aggregation of the spores of one of the special forms of what the farmer designates as rust. Whether he regards it as a distinct thing in itself, or as simply a diseased condition of the plant tissues arising from the evil effects of bad drainage, want of proper light, or what not, none feels to a greater extent than he its destructive effects upon the yield of the crop. The rusts of the agriculturists, however, are but representatives of a great order, embracing more than twelve hundred species,* of which it will be the province of this paper to give an outline of the structural development and life-history of but a few species belonging to the division of the Heterœ-

EXPLANATION OF PLATE.

Fig. 1. Germinating teleutospore of *Puccinia Bolleyana*, Sacc., *med.*, showing promycelium and sporidia. Germinated April 15, 1889. $\times 600$.

Fig. 2. Teleutospores of *P. Bolleyana*: *a*, typical form; *b*, beginning of germination, showing erosion of cell-wall. $\times 600$.

Fig. 3. Vertical median section of a young fruit of *Æcidium Berberidis*: *a*, spore bed or stroma, just preceding the appearance of the basidia; *b*,

spongy parenchyma enclosed by mycelium; *c*, hyphæ protruding from stoma, bearing spermatia on their sides; *e*, epidermis of host; *f*, parenchymatous cell containing disorganized protoplasm. $\times 240$.

Fig. 4. Sporidia of *P. Bolleyana*, showing various stages of germination. $\times 1360$.

Fig. 5. Germinating spermatia of *Æcidium hepaticarum*, grown April 18, 1889. $\times 1360$.

*Saccardo, *Sylloge fungorum*, vol. vii, 1888.

cismal Pucciniæ. Because of their complete development, however, the general characteristics will be found to be closely common to those of the whole order.

Biology and Classification.—The Uredineæ comprise an order of parasitic fungi which infest the living tissues of the higher plants, being with few exceptions confined to the phanerogams, attacking the most succulent parts. All the species are highly parasitic, each growing upon host plants specially suited to its particular development, without which providers of nourishment they cannot exist. Wherever flowering plants are found some forms of the uredines may be found associated with them, the fruit forming definite spots upon the host, the parasite living upon but not destroying the underlying tissues. In this particular these fungi show their high position in the scale of parasitism. Unlike the lower parasites, the semi-saprophytes, such as *Cladosporium*, which may live upon the decaying substratum, the death of the parasite invariably follows that of the host tissues.

The plant body is composed of a variously branching, interlacing, and coalescing network of hyphæ, ramifying and often fusing with the tissues of the supporting plant. The vegetative hyphæ possess essentially the same form throughout all the different genera, but in the formation of the fruit the plants display a wide range of polymorphism, producing in certain species as many as four spore forms, in appearance and surroundings apparently wholly distinct.

The sexuality of the fungi has been a study pursued with much diligence by mycologists, and in their attempt at the determination of relationships the *Æcidiomycetes* have in no manner been slighted. Yet, though De Bary * directed attention to the subject in regard to this order over thirty-five years ago, no one has successfully demonstrated the presence of a sexual process in the formation of any of the spore forms. But the weight of argument seems to be with De Bary in considering the *æcidium* the homologue of the sporocarp of the other *Ascomycetes*; † and Geo. Masee, ‡ of England, affirms that in the case of *Æcidium ranunculacearum* he has actually witnessed the development of an oogonium and antheridium which immediately precedes the development of the *æcidium*.

The production of exceedingly dissimilar spore forms under widely varying and unexpected conditions, the numerous inexplicable anomalies connected with the development of the individual species, such as the ability to perpetuate the species by means of only one spore form, as in the *Leptopucciniæ*, and the apparent absence of any sexual process, have given rise to complications which may in a manner explain our present meager knowledge of the proper relationship of the order.

The accompanying phylogenetic diagram, as condensed from De Bary by Ward, § is given here as representing the most probable situation of the order in relation to the other fungi as fixed by our present knowledge:

* Die Brandpilze, 1853.

† Morphology and Biology of Fungi, sec. lxxix.

‡ Annals of Botany, vol. ii, p. 47.

§ "On Sexuality of the Fungi," *Quart. Jour. Mic. Sci.*, new series, vol. xxiv, p. 294.

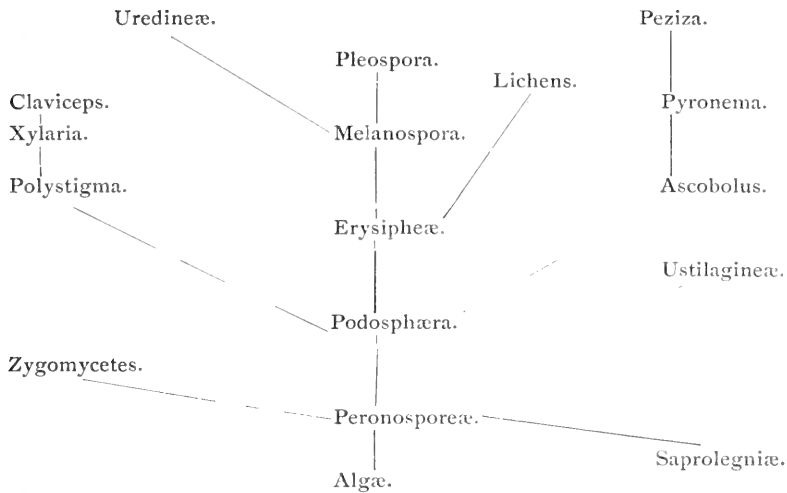

The internal systematization of the order is based principally upon 1st, structure of the teleutospores; 2d, peculiarities of species or groups of species in regard to life-history. On the first depends the grouping of the genera, on the latter that of the species. According to structure of teleutospores a genus may fall under one of four divisions:

1st. *Amerosporæ*, *Sacc. & De Toni*. Teleutospores unilocular, as in *Uromyces*.

2d. *Didymosporæ*, *Sacc. & De Toni*. Teleutospores bilocular, as in *Puccinia*.

3d. *Phragmosporæ*, *Sacc. & De Toni*. Teleutospores 3-pluriseptate, as in *Phragmidium*.

4th. *Dictyosporæ*, *Sacc. & De Toni*. Teleutospores variously septate, transversely, longitudinally, or obliquely, as in *Triphragmium*.

Considering the teleutospore as the ultimum of the spore series and its germination, the development of a promycelium and sporidia, as the beginning, these divisions are subdivided upon the basis of the number, relative position, and nature of the intervening spore forms between the sporidium and the teleutospore. This gives rise in the *Pucciniæ* to the following divisions, which are subdivided according to various slight variations in the spore form of the species.

1. *Eupuccinia*, *Schræter*: Spermogonia, æcidia, uredo- and teleutospores developed upon a living host plant, teleutospores germinating only after a period of rest.

a. *Autopuccinia*, *De Bary*: Spermogonia, æcidia, uredo- and teleutospores formed upon the same host.

b. *Heteropuccinia*, *Schræter*: Teleutospores and uredospores upon one host; æcidia and spermogonia upon another of a different genus.

2. *Brachypuccinia*, *Schræter*: Æcidia wanting.

3. *Hemipuccinia*, *Schræter*: Æcidia and spermogonia wanting.

4. *Pucciniopsis*, *Schræter*: Uredo wanting.

5. *Micropuccinia*, *Schröter*: Only teleutospores known; germinating after rest.

6. *Leptopuccinia*, *Schröter*: Only teleutospores known; germinating at once.

In so far as they are co-extensive with *Puccinia* the other genera of the order are classified upon the same basis.

Heterœcism.—The life-history of the *Heteropucciniæ*, so far as authentically known, is by natural characteristics of development, consequent upon an alternation of generations, divided into three distinct periods, each one of which forms a complete fruiting stage, with spores which, upon germination, develop directly into the vegetative tissues of the fungus—*i. e.*, into the mycelial filaments which penetrate the tissues of the supporting plant. These stages, considered in the order of their development from the teleutospore sporidium, are known as the æcidium, the uredo, and the teleutospore forms of the fungus, the first two stages corresponding respectively to the genera *Æcidium* and *Uredo*. These genera are still retained by systematists, and embrace such æcidia and uredo forms as have not as yet been identified with a teleutospore form, which, when a full life-history has been determined, takes precedence of the other spore forms, according to most authors, giving the name to the species.

Most species of the uredines complete their whole life-history upon one host, each spore-form as it germinates being able to send the resulting hyphæ into the tissues of the host upon which the spores were first formed, as in the *Autopuccinia*. Even if one or more of the spore-forms are absent, as in the *Leptopuccinia*, we may be moderately sure that the development is complete, for the sporidia which are abscised from the promycelium of the germinating teleutospores immediately develop the vegetative hyphæ within the tissues of the same host which bore the mother spores.* However, this is not the case in those species which attack the grasses and other glumaceous plants. In every case only the last two stages will be found upon these plants, while the æcidia, with which are associated the spermogonia, when known, are always found upon some non-glumaceous host. This is heterœcism as applied to *Uredineæ*.

That such a change of host plants may occur during the development of a single species is no longer questioned. Since the affirmation of the same by De Bary in 1865, with regard to *Puccinia graminis*, the common wheat rust, his results obtained by means of artificial cultures have been confirmed time and again by experimental botanists until the *Heteropucciniæ* of which the life-history for at least one series of hosts is accurately known to number over twenty species,† among which are included many species most destructive to the various cereals and grasses. The simple fact of the heterœcious nature of these parasites is not now of so great interest to the mycologist in itself as the question why it exists. Plowright‡ suggests that these species are heterœcious because the hosts upon which the uredo and teleutospores are developed, the grasses and sedges, possess silicious cuticles, which the sporidia, perhaps, are not able to penetrate. Yet it may be said, in

* De Bary, *Morphology and Biology of the Fungi*, p. 284.

† See comparative table of æcidia and teleutospore species in Plowright's "British *Uredineæ* and *Ustilagineæ*," p. 56.

‡ L. c., p. 57.

opposition to this idea, that at the time of the germination of the teleutospores, the stomata of the delicate spring growth of these plants present every facility for the entrance of the sporidia which are of much less diameter than those openings. It seems much more probable that the change of hosts is brought about by requirements of the fungus not dependent upon such slight mechanical hinderances, but upon inherent wants of the parasite not to be satisfied by one of its hosts alone. If ease of entrance into the host is all that determines heterœcism, there would be slight cause for the fungi quitting their æcidium hosts to attack the Gramineæ, for those plants as a rule are possessed of non-silicious cuticles. That the last stages appear upon the grasses is, we think, not so much a matter of choice as of necessity.

Mycelium.—This term applies in common to the vegetative portion of all the spore forms. Usually it is essentially a network of anastomosing tubular filaments variously septated and branched, having a diameter of from 2 to 6 μ . In the formation of the stroma or bed from which the spores arise, however, the hyphæ often become closely united by fusion* so as to form what may fitly be termed a false tissue. The hyphal walls are hyaline and are quite delicate while young. As they grow older the walls thicken and the granular protoplasm with which they are at first filled disappears as the spores are formed.

As in most uredines, the mycelium is localized, the results of one infection being confined to a quite limited area, as may be determined by single artificial infections on carefully isolated plants. In the case of the æcidium of *Puccinia graminis* on the leaf of barberry (fig. 6 a)

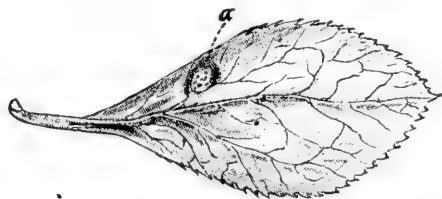

FIG. 6.—Inferior side of barberry leaf, showing at (a) an æcidium spot arising from single infection. Natural size. Original.

it will be found that the result of one infection affects but a slight area of the leaf. On the Gramineæ, however, the localization is much less marked. In these hosts the leaves, sheaths, and often large portions of the haulm, may be ramified throughout, the fruiting pustules appearing over the whole diseased area.

When a hypha, say one from a germinating uredospore, penetrates the tissues of the host, branches are given off in every direction, which continue to branch in a monopodial manner. The result is a complete ramification of the parenchymatous tissues of the host in the immediate region of infection, the hyphæ being at first principally confined to the intercellular spaces. They apply themselves closely to the cell walls and create passage-ways through and around the cells by a process of solution. As the fungus develops the branching becomes more profuse, and, in the vicinity of forming fruit—*i. e.*, pustules or sori—the host

* See paper on "Sub-epidermal Rusts," *Bot. Gaz.*, 1889, p. 139.

tissues are gradually eaten away, so that only a fungal stroma remains, which is closely fused with the surrounding tissues. In no case, except perhaps in that of the acidium, is there any apparent disorganization of the functions and arrangement of the sub-epidermal host tissues other than that which arises from a complete or partial appropriation by the parasite. Parasitism is complete, the attachment of fungus to the host is that of living connection. This ability of fusing with the host tissues, and thus being able to draw direct nourishment therefrom, may perhaps in part account for the lack of true haustoria. Various authors* have spoken of and figured certain branch-like protuberances, which penetrate the cells, as haustoria. In the species I have studied the young mycelia present many such appearances, but I take it that they are simply young hyphal branches which have penetrated the cell-walls. During the earlier growth they may be found in various lengths and forms, but in older stages the cells will be found to be penetrated by many not short branches (haustoria), but continuous filaments, the former being apparently wholly absent. The ability of these parasites to gradually unite with and dispose of host tissues by solution is probably connected with a power of secreting an unorganized ferment.† H. Marshall Ward‡ has succeeded in the case of a species of *Botrytis* which attacks the lily in separating such a ferment, which is described as having a macerating effect upon plant tissues. He also ascribes the anastomosing of the hyphæ with the consequent solution of the adjoining walls to the same agency. The same power evidently accompanies the growing hyphæ of the uredines, yet to a perhaps less obvious degree.

Spermogonia and Æcidia.—In the spring, upon the germination of the teleutospores and the formation of sporidia, the yearly life-cycle begins by an infection of the non-glumaceous host by means of the sporidia. These are small protoplasmic bodies which are abscised from the promycelium of the germinating teleutospores (fig. 4). Though I have made successful cultures by placing the germinating sporidia of *Puccinia graminis* upon the leaves of the barberry, I have searched in vain to ascertain the method of entrance of the germ tube into the leaf tissues. De Bary,§ the only one who claims to have seen the process, has figured the same as piercing directly through the cuticle. However, in another species, the infection was noted as taking place by way of the stomata,|| and it is, I believe, not improbable that such would most often occur in this case.

In the case of a barberry bush, upon which I experimented, that had been carefully isolated by being placed in a green-house before it began to open its leaf buds, the spermogonia appeared as yellow spots upon the upper sides of the infected leaves in fourteen days after the application of the sporidia.

Vertical cross-sections of the leaf passing through these bodies show them to be pyriform structures, with their rounded bases sunken slightly in the sub-epidermal tissues of the host, and their apices protruding through the ruptured epidermis. This may, perhaps, be considered as

* Bagnis, "Obs. Vita et Morphol. Funghi Uredinei;" quoted from Plowright, *l. c.*, p. 4.

† See Vines' Plant Physiology, p. 191.

‡ Annals of Botany, vol. ii, p. 319.

§ Morphology and Biology of the Fungi, p. 280, fig. 128 c.

|| *l. c.*, p. 284.

the characteristic situation of these bodies, but in some species, as *Æcidium hepaticarum*, they are only sub-cuticular. The outer portions or periphery of the bodies are composed of many erect, closely-pressed, bristle-like filaments, paraphyses, which arise from the stroma or mass of miscellaneous tangled hyphæ below. Inside this wall of paraphyses and lining the cavity is what may be fitly termed a hymenial layer, from which arise filaments, short, thick sterigmata, which bear the spermata.

The most noticeable feature connected with the composition of these bodies is the variation in the hyphæ as compared to the other spore-forms. While the ordinary hyphæ from which the branches arise to form the body range from 3 to 6 μ in diameter, the paraphyses seldom exceed 3 μ , and the sterigmata and the filaments which form the stroma are even smaller. The spermata are abstricted in conidia, form series from the apices of the sterigmata, which stand at right angles to the hymenial layer, so that the centre or cavity of the flask-like spermogone is early filled with the small round or oval bodies, which finally ooze out at the apex in a mucilaginous conglomerate. These bodies when placed in a weak solution of honey or sugar pass through a budding germination not unlike the multiplicative process to be seen in the yeast plant, *Saccharomyces cerevisæ* (fig. 5). As to the true nature and purpose of these bodies in the economy of the fungus nothing is known. Some, reasoning by analogy, hold that they represent the male element in reproduction, while some are inclined to consider them as a simple conidial spore form, the complete life of which is not as yet known.

Soon after the formation of the spermogones the neighboring hyphæ begin to form interlacing masses deeper down in the plant tissues, which are the beginnings of new fruit, the *æcidia*. By this time the diseased portion of the lamina of the leaf has become much thickened, cushioned under the spermogones, due to some stimulating effect of the parasite causing an abnormal development of the mesophyll tissues. The hyphæ have also become much closer branched, more septate, and a yellow oleaginous granular matter appears in considerable quantities in the protoplasm. This may also be seen in large quantities in the paraphyses of the spermogones, and seems finally to constitute a principal element in the contents of the *æcidiospores*.

In *Æcidium hepaticarum* on *Hepatica triloba*, just previous to the appearance of the basidia from which the spores are abstricted, the *æcidium*, by sectioning, is found to be a solid ball of clearly interwoven and united filaments (fig. 7). When the sphere has enlarged until its most exterior surface is about in contact with the epidermis, the young basidia appear as small thick branches arising from a point in the ball slightly below the median line (fig. 7, *d*). The outermost ones correspond in position to a row of paraphyses, and, uniting, form the enclosing wall of the fruit, the peridium, which upon the rupture of the epidermis turns back, forming a cup-like opening from which the spores, which have already been abstricted from the internally situated basidia, may escape. This course of development is essentially true for the *æcidium* of *Puccinia graminis*, excepting only that portion of the description which applies to the formation of the *æcidium* just previous to the appearance of the basidia. In this case there is at first formed an aggregation of mycelia, which constitutes the stroma or spore-bed from which the basidia arise. On the sides this mass of filaments ex-

tends towards the epidermis so as to enclose a mass of the newly-formed spongy host tissue (fig. 3). In either case, however, as the basidia ex-

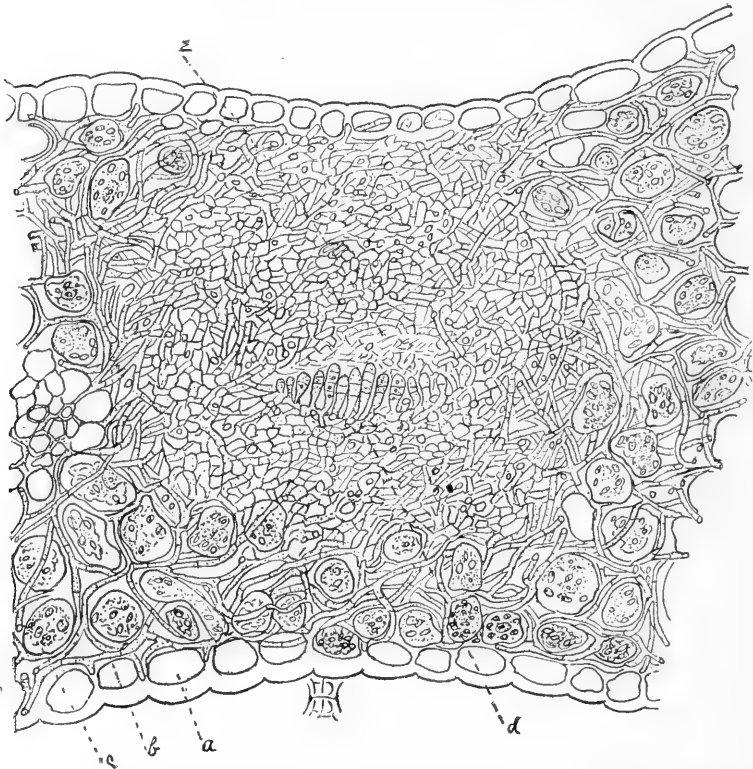

FIG. 7.—Young aecidium fruit of *Aecidium hepaticarum* in vertical median section, showing the manner in which the basidia arise: (a) epidermis of host; (b) a vegetative hypha; (c) an isolated hypodermal cell; (d) a young basidium; (e) a portion of the hyphal network in solution. $\times 200$. Original.

tend, the tissues above them, fungus or host, are gradually dissolved away, so that when mature only the fruit remains within the peridium.

Uredospores (Stylospores).—The next spore formation in the general order of development is that of uredo or summer spores, which develop upon the glumaceous hosts after an infection by the aecidiospores. The filaments collect in a circular, disk-like mat lying just beneath the epidermis from which the basidia arise at right angles to the substratum. The development of the spores is characteristic of conidia forms. The basidia become filled with the granular protoplasm common to the hyphae and the apices become swollen so as to form a somewhat rounded body, the young spore. For a time this is essentially hyaline, with the exception of a small protoplasmic collection in the central region, which now contains a quantity of yellow oleaginous matter, also to be found in the neighboring hyphae. This central body gradually enlarges until the whole cell finally becomes filled. By this time the spore is being abstricted from the pedicel, and a new wall, the endospore, forms

on the inside of the terminal part of the old expanded filament, which latter now becomes the exospore. In many species, as of *Puccinia graminis*, this outer layer of the double wall becomes minutely echinulate, the markings being essentially of the same nature as those which occur upon many pollen grains and upon the spores of some of the *Ustilagineæ*. When the spores are mature they either fall off or are pushed off by other spores arising from the spore-bed below. They are now prepared under favorable circumstances to germinate immediately, and, as they may be blown about freely by the winds, this accounts for the rapid spread of the disease among the cereals at this red-rust stage in the development of the fungus.

Teleutospores.—These constitute the last form of the spore series, and as a rule do not germinate until the spring following their formation, hence they may be considered as the resting spores, the ones intended to propagate the new life-cycle which has its beginning in their germination.

The manner in which they are formed from the vegetative hyphæ does not essentially differ from that of the uredospores. Often they arise from one and the same spore-bed or stroma, as in *Puccinia graminis*, but appearing later in point of time. In those cases in which the teleutospores do not rupture the epidermis* they are developed upon new spore-beds. *Puccinia coronata* may be considered as typical of this class. For the want of fresh young material in others the development of the teleutospores was studied most closely in this species, which doubtless is essentially the same as that exhibited by other species.

Just previous to the formation of a new sorus, or pustule, several ordinary filaments meet and coalesce in an intercellular space lying just beneath the epidermis, and become densely protoplasmic. This is the beginning of the stroma or spore-bed. The spores first appear as very short, thick protuberances upon the hyphæ which form the upper layer of the stroma. These gradually distend into thin-walled, sack-like bodies, pressing firmly against the surrounding tissues. The body of the spore is early cut off from the filament by a cross septum. From the first the young spores are well filled with a finely granular protoplasm, and contain near the central region a much denser body which I take to be a nucleus. When the young spore has attained nearly normal proportions, a horizontal septum is thrown across slightly below the middle, dividing the mother cell. At the period of maturity the two simple cells have each acquired a thick reddish-brown wall apparently of two distinct layers, while the old wall of the mother cell which still envelops both has become apparently cutinized.

In regard to the so-called germ pores, I think they are at least of doubtful existence. The process of germination, so far as I have been able to trace it in a number of species, consists not in the passing of the germ-tube through an already formed germinal canal.† but by the erosion (fig. 2, *b*) of the wall from within.‡ The protoplasmic contents still inclosed in the endosperm gradually dissolves or erodes a passage through the exospore, then expands to form the promycelium, into the

* For further information regarding these sub-epidermal forms, the nature of the stroma, and a consideration of the effect of tension upon the spore form, see "Sub-epidermal Rusts," *Bot. Gaz.*, 1889, p. 139.

† De Bary, *Morphology and Biology of the Fungi*, p. 101; Plowright, *British Uredineæ and Ustila gineæ*, p. 39.

‡ Ward, *Annals of Botany*, vol. ii, p. 220.

distal end of which the contents of the cell finally collect. After several characteristic nutations the protoplasmic portion of the body becomes from two to four septate. From each of these cell divisions short sterigmata arise (fig. 1), into which the contents of the cells are emptied, and from each of which is abscised one or more sporidia, which are prepared to produce a germ-tube immediately after abstriction from the promycelium (fig. 4).

Reproduction.—Present knowledge does not allow of a definite assertion regarding the presence or absence of a sexual process. Certainly no one has made a satisfactory demonstration of sexual organs in any of the Uredineæ. Of the various spore forms the uredospores are of such an obvious conidial nature that none will account that stage as other than asexual. The formation of the teleutospores seems not to be different, although the fruit as a whole presents many points morphologically analogous to that of other Ascomycetes, so that a sexual process has been advocated for this point in the development,* yet the whole unfolding, from the beginning of the young spore-bed to the perfection of the fruit, shows nothing characteristic of a sexual process.

Morphological appearance, development, connection with the spermogonia, and various other points have combined to place the sexual process, if any such exists, with the *æcidium* fruit, but fact is wanting. Mr. Geo. Masee, of England, has indeed figured the development of an oogonium and antheridium, which he affirms he witnessed in *Æcidium ranunculacearum*, but the indefiniteness of his paper and the diagrammatic nature of his principal drawings make the value of the whole somewhat doubtful. His figure 4,† at least, does not represent the manner in which the basidia first appear in most species. A longitudinal vertical median section of the body, which he represents in fig. 4, would show the young basidia to arise from an arched base corresponding to the contour of the oogonium, so that the medially-situated basidia must arise from a higher point on the young spore-bed than the more externally situated ones. In other words, he shows that the young spore-bed is convex instead of concave, and that the basidia which are to abstrict the *æcidiospores* first arise, not from the individual hyphæ of the bed, but from a globular body, a condition which I have been unable to verify.

In those cases in which I have sectioned the young *Æcidium* fruit at a stage of development just previous to the appearance of the basidia, the stroma was found to consist not of a stalked body, as represented in his figure, but of a mass of interlaced hyphæ consisting of branches and extensions of the ordinary hyphæ (fig. 7).

In both *Æcidium berberidis* and *Æcidium hepaticarum*, which I have studied carefully, the sphere of interwoven hyphæ attain to nearly the normal proportions of the *Æcidium* before the basidia make their appearance. Vertical longitudinal median sections of the young fruit at this time showed that each basidium arises as a bud-like branch from individual hyphæ, which lie nearly on a horizontal line with the base of other basidia of the same fruit or cup (fig. 7, *d*). In regard to the order of development, the basidia do not differ from that displayed in the formation of the young teleutospores, the older growths being

* Bessey, Text-book of Botany, pp. 314-317.

† L. c., plate iv.

found in the centre of the bed. The æcidiospores are abstricted in the manner common to conidia, the basidia being septate almost as soon as microscopically visible.

In many æcidia, *Æcidium berberidis* especially, it is quite common to find apparently ordinary filaments (fig. 3, *c*) protruding from the stomata, which are situated above the æcidium fruit, as it forms beneath the epidermis. Many spermatia may often be seen adhering closely to these bodies. If a sexual process is still to be sought these occurrences deserve close attention. There may, perhaps, be a general hyphal fecundation through these organs. I am inclined, however, to consider the extension of the hyphæ through the stomatal openings as merely accidental.

H. Marshall Ward, in his paper "On the sexuality of the fungi," makes the statement that "it is probable that the sexuality of the higher fungi has disappeared, because its purpose has been equally well or better attained otherwise than by means of sexual organs;" that is, for some reason they have become apogamous,* an asexual spore formation has displaced a sexual process while the fruit still retains in general a sexual form. This I think to be true of the uredines; though the fruit may be morphologically analogous to the sexually-produced fruit of other Ascomycetes, the spores are asexually produced.

So far as is known, the sexual process is chiefly one for re-invigoration, that the life of the species may be continued unimpaired. While in the great majority of plants this is accomplished by the formation of a new plant body by the union of two more or less specialized masses of protoplasm, constituting the sexual process, it seems that some, because of certain favored conditions, are able to do away with this special method, being able to draw sufficient nourishment from their more excellent food supply. In the parasite the source of energy is the nourishment obtained from the host, and the better the connection between the parasite and its host the less liable is the protoplasm of the former to suffer vitiation for want of nutrient matter.

In the Uredineæ the union of the host and parasite is almost perfect,† and in those species in which the whole development is upon one host it is probable that the wants of the fungus are adequately met. That some species are heterœcious upon particular but diverse host species is, we think, but indicative of the fact that the combination best complies with the nutritive needs of the parasite not to be fulfilled by one host alone.

Bibliography.—The full bibliography of the subject is much too extensive to be listed here, but the following books and papers are mentioned as having been specially valuable in the preparation of this article:

Burrill, Parasitic Fungi of Illinois. *Bull. Ill. St. Lab.*, ii, 1885, pp. 141-255.

De Bary, Morphology and Biology of the Fungi, Mycetozoa and Bacteria, 1887.

Dietel, Morphologie und Biologie der Uredineen.

Farlow, Gymnosporangia or Cedar Apples of the United States, 1880.

Massee, On the Presence of Sexual Organs in *Æcidium*. *Annals of Botany*, ii, 1888, pp. 47-51.

* Vines, Plant Physiology, p. 626; De Bary, Morphology and Biology of the Fungi, p. 123.

† Sub-epidermal Rusts, *l. c.*

- Mueller, Die Rostpilze der Rosa und Rubusarten. Inaug. Diss., 1886.
 Parker, On the morphology of *Ravenelia glandulæformis*. Proc. Amer. Acad. Sci., xxii, 1886, pp. 205-219.
 Plowright, Heterœcism. *Gard. Chron.*, xix, p. 824; British Uredineæ and Ustilagineæ, 1889.
 Saccardo, Sylloge Fungorum, vii, 1888.
 Sorauer, Pflanzenkrankheiten, ii, 2d ed., 1886.
 Von Thuemen. *Melampsora salicina*, der Weidenrost. 1879.
 Ward, On the Sexuality of the Fungi. *Quart. Jour. Micr. Sci.*, xxiv, n. ser., pp. 262-310. Life History of *Hemileia vastatrix*. *Jour. Linn. Soc.*, xix, 1882, pp. 299-335.
 Winter, Rabenhorst's Kryptogamen Flora, Pilze, i, 1881-7, pp. 131-270.
 PURDUE UNIVERSITY, June 1, 1889.

Magnification in Photo-micrographs.

By W. J. SIMMONS,

CALCUTTA, INDIA.

A friend of mine, Mr. Walter Osmond, who photographs a good deal with the microscope, inquires how he should fix the magnification of his objects, as shown in his pictures. Using a $\frac{1}{4}$ -inch objective and an ocular, which together give 300 diameters, with the eye-glass at 10 inches from the paper, he gets a field as nearly as possible 6 inches in diameter. Employing the same eye-piece and objective in his camera, he gets a disc in his photos at 2.9 inches. He fixes the magnification in the photo at 145 diameters by the following simple rule-of-three sum: $6 : 2.9 :: 300 : 145$. Similarly, with a 2-inch objective and a powerful ocular, which together give 55 diameters at the standard height of 10 inches, he fixes the magnification of his photos at $26\frac{1}{2}$, thus: $6 : 2.9 :: 55 : 26.583$. Is this correct? You will observe I distinguish in this note between the "magnifying power" of an objective and "magnification," implying by the latter term mere enlargement; and confining the former "magnifying power" to that particular degree of enlargement which is obtained when an image is projected by any kind of microscopic camera, on a plane horizontal surface parallel to the body of the microscope, and distant exactly 10 inches from the centre of the eye-glass of the ocular. I would also add that such rough measurement as can be made by opening both eyes and comparing an object with a rule laid at the stage serves to show that Mr. Osmond's method is correct.

An Enterprising Druggist.—Mr. G. A. Waltenspoil, of Jackson, Cal., keeps a microscope in the store for examining drugs. Frequently, when he mounts an interesting object, he places the microscope on the counter for anyone who comes in to examine. This practice tends to attract customers, turns attention to his store, and educates the public. He commenced with a lense magnifying only twenty-five diameters, but now uses one hundred and fifty diameters, and frequently makes examinations for physicians.

On the Gustatory Organs of *Erethizow Dorsatus*.

By FREDERICK TUCKERMAN,

AMHERST, MASS.

Quite recently I received a fresh tongue of this species. I placed the organ for a few days in a mixture of Müller's fluid and alcohol, and afterwards transferred it to ordinary spirit, where the hardening was completed.

General Description of the Tongue.—The tongue is 76 mm. long, 19 mm. wide, and 16 mm. in thickness. It is free from the frænum for 32 mm. The fore part of the organ is compressed laterally, and terminates in a more or less pointed apex. The posterior dorsal region is somewhat roughened by verrucose elevations, and is impressed anteriorly by a slight mesial groove from the gustatory area backwards. Near the base is a median ridge with a shallow groove on either side. The fungiform papillæ are normal in structure, but few in number. There are a few large ones, disposed in lineal series, above the line of junction of the upper surface and sides. At the posterior part of the papillate surface are two circumvallate papillæ situated one on either side of the median line. The two papillæ are 16 mm. from the base of the tongue, and equi-distant from its lateral margins and from each other. Placed between them are two small slit-like apertures, which may have at some period contained bulb-bearing ridges. The papillæ foliatae lie well down on the sides of the tongue, their posterior limits being some 4 mm. anterior to the circumvallate gustatory area.

The Circumvallate Papillæ.—These papillæ are about 1.45 mm. in breadth, and 0.60 in height. They bear on their upper part a great number of secondary papillæ overlaying, which is a thin stratum of stratified pavement epithelium. Serous glands are plentiful both within the bodies of the papillæ and around their base. Their ducts open into the trench, especially at its deeper part. The taste-bulbs, which are far from numerous, are disposed in a somewhat irregular belt around the base of the papilla. They average about 0.054 mm. in length, and 0.024 mm. in breadth.

The Papillæ Foliatae.—The foliate papillæ are about 7 mm. in length. Each papilla consists of fifteen or sixteen fairly symmetrical folds, and each fold bears at its upper part two or more secondary papillæ, the spaces between which are filled to a common level with epithelium. The furrows separating the folds or ridges are narrow, and 0.45 mm. in depth. Serous glands are abundant about the base of the folds, and their ducts usually open at the bottom of the furrows. The taste-bulbs are not numerous, and are very irregular in their disposition. They average 0.048 mm. in length, and 0.027 mm. in breadth.

In the fungi form papillæ the taste-bulbs seem to be relatively more numerous than in the gustatory areas proper of the tongue. They are situated at the upper part of the papilla, and are usually placed obliquely to its long axis, with their apices directed upwards and outwards. The basal end of the bulbs generally touches the mucosa. In transverse sections of these papillæ the component cells of the bulbs could frequently be distinguished without difficulty, and in one bulb I counted twenty distinct cells. More than half of the cells were grouped about the axis of the bulb, and were doubtless sensory in function.

Selecting a Microscope.

By G. S. WOOLMAN,

NEW YORK.

There is a simple instrument which, with its three lenses combined, has a power of thirty-three diameters, which sells for \$3.50. With it can be seen many of the larger animalculæ in pond water, the scales from a butterfly's wing, pollen-grains from plants, and thousands of other objects not visible to the naked eye. From \$3.50 the prices for microscopes range up to \$350 and \$400. There are many different styles and grades, a very common mistake made by persons attempting to select a microscope is to judge of the excellence of an instrument by the amount of its magnifying power. No object should be viewed with a power greater than that required to show its structure, and if that can be done with thirty diameters it is, to say the least, unnecessary to use one hundred. This is especially the case with low-priced instruments, where the apertures of the objectives are small and the connections not so exact as in the higher grades, rendering them more liable to give false impressions of objects. Moreover, it is absolutely impossible to view opaque objects satisfactorily by the reflected light of cheap compound microscopes. For those who wish to dissect flowers and insects for examination a simple instrument is better.

In selecting a microscope the essential points to be observed are that the lenses show objects clear and well-defined, that the stand be of good material and workmanship, and that there be no lateral movement in the adjustments of the focus. Further, that the focus be instantly changeable when desired, and that it have a joint for inclination. As to the different kinds of microscopes. The simplest, of course, is the single glass, such as is used by watchmakers and engravers, and the common pocket glass with from one to three lenses. The simplest microscope with a stand is the one mentioned above for \$3.50; with its three lenses combined it has a magnifying power of 33 diameters. It packs in a box that acts as a base for the upright brass stem. With it comes an animalculæ cage, a pair of brass forceps, a watch-glass, two plain glass slips, and a prepared object. The school microscope is similar, but works easier, and is better adapted for school purposes. Of the compound microscopes, one sells for \$2.50, which is the simplest. It is of polished brass with one piece and one object-glass, magnifying, when combined, about 40 diameters (or 1,600 times), the power being calculated by squaring the diameter.

A powerful instrument for household use, with its two object-glasses, magnifies from 30 to 100 diameters, and ranges in price according to size and quality from \$5 to \$12. For ordinary use, an amateur microscopist can buy an instrument for from \$23 to \$30 which will answer his every purpose. Such a microscope will have a stage with adjustable spring clips, a revolving diaphragm with four apertures beneath the stage, and a concave reflecting mirror for use under or above the stage. It can magnify 165 diameters, and, with the addition of a one-fifth object-glass, this can be increased to 350 diameters. For students in histology and vegetable anatomy there are instruments that range in price from \$50 to \$400, and when one of the cheapest is furnished with condenser, polariscope, camera lucida, spot lens, zoophyte trough, live box, and forceps, it is complete for almost any investigation.

Methods of Mounting Infusoria.

BY PROF. C. W. HARGITT,

OXFORD, OHIO.

Of the many accomplishments of microscopy, its subjects and methods, not the least of its value consists in the fact that a very large portion of the work may, by mountings and photography, be rendered as permanent as the cabinet of the mineralogist. An exception is sometimes urged, however, concerning that large class of the utmost interest to the microscopist, viz., the Infusoria. This is especially true of the more delicate and perishable forms, such as the paramœcia, vorticellæ, etc., some of which are rare and difficult to obtain. Specially is this true of the critical moment when they are most needed, as every teacher of zoölogy can testify. While the peculiar beauty and interest which attaches to the observation of the *living* forms may be wanting in them in the motionless state of the mounted specimen, yet a world of interest is exhibited in the silent form which cannot be aroused by any figure however well executed, and that simply in the fact that it is the thing itself. But, further, the motionless form on the slide is often far more instructive than the same form living. If properly killed, so that it retains the natural features, and properly stained, far more of its structure may be seen than is possible in life.

There can be no doubt, therefore, that a successful method by which these results may be had will be welcomed by not only the teacher, to whom it is a very boon, but also by the curiosity hunter of microscopical gems. That it is no easy problem goes without saying. The very delicacy of many forms, and their extreme sensitiveness to stimuli of unfavorable sorts, renders their killing and preparation in any successful way very difficult. I have recently had some success in this line that has been a surprise to many besides myself, and a brief detail of the method may help others to similar results. I am aware that other methods have been proposed by other workers from time to time, and I do not presume that I am the first or only one by any means who has been able to secure reasonably good results in this line of work. That the method used by me is, however, a success when carefully followed, I can fully affirm. Neither am I disposed to claim originality for the method, except in some of the details of its application. It was first suggested to me by Dr. E. B. Wilson, though since modified to suit special cases.

The first requisite is to "catch the hare." Assuming that the material to be experimented upon is possessed in abundance, whether of paramœcia or vorticellæ, or hydroids, or even Amœbæ, it is only necessary to expose in a shallow dish or watch-glass some of the water, as free as possible from sediment or débris, preparatory to killing, which is a matter of the greatest importance. Before attempting this it is well to get rid of as much of the water as possible without endangering the normal activity of the animals. It is by some suggested to be done by leaving to slow evaporation. I have found this rather risky, as many are likely to perish. My method has been to draw off the surface very gently with small pipette, and then further reduce the excess of water by a syphon of thread which draws it off by capillarity. Next comes the process of killing, which must be done absolutely instantaneously, and at the same time without injury to the most delicate organism. The

killing must be instantaneous in order to have the animal in an expanded state, without which it would be practically worthless. This may be done by any of several reagents, among the most successful of which, in my own experience, have been corrosive sublimate, saturated solution in water; Lang's fluid, which is essentially the same, with addition of small per cent. of acetic acid; osmic acid; picric acid. I have named them in the order of my preference. In the second they must be left but a few moments, as the acid disorganizes the structure. The same may be said also of the latter two. After killing it is only necessary to harden the protoplasm by the ordinary method of alcohol of increasing strength, then to stain them with borax carmine, or other if preferred; then complete the process by dehydration with absolute alcohol; finally, to render transparent with oil of cloves or other appropriate reagent, and mount in balsam.

It should be noted that great care is necessary in transferring from one medium to another that the specimens are not lost. This I have avoided by using the thread syphon and working with great patience. I have by this method secured beautifully stained *Amœbæ* naturally expanded and exhibiting almost every phase of their life-history. I have also fine specimens of paramœcia and hydroid medusæ, etc. *Vorticella* I was not able to get *fully* expanded, though otherwise excellent.

While the method is somewhat tedious, it is not more so than kindred methods of preparing diatoms and such like organisms, and will in results repay richly, I think, anyone who will take the pains to give a few trials.

I should have noted also that the final mounting may be done with equal success in glycerin or glycerin jelly. In a word, after the process of preparation the mounting may be done by any of the ordinary methods.

MIAMI UNIVERSITY, July 10, '89.

The Bidwell Cabinet.

By W. D. BIDWELL, M. D.,

LEAVENWORTH, KAN.

During a recent attempt to provide for the storing of microscopic slides, I became convinced that none of the cabinets I had seen were as simple and convenient as could be made, and accordingly I devised the Bidwell Cabinet. No attempt will be made to patent it, and I freely allow all persons to make them for their own use, if, indeed, they have not used them already. Prof. Lighton informs us, however, that he has seen every style yet made, but none like this. The drawers contain 12 slides each, and are made of a single piece of seasoned black walnut $7\frac{1}{2}$ inches by 8 inches and $\frac{3}{8}$ of an inch thick.

The compartments are made with a one-inch chisel, making six cuts $\frac{1}{4}$ inch apart and $\frac{1}{4}$ inch from the side on each side and then cuts corresponding to these three inches toward the middle of the drawer. Then a piece is easily chipped out between each pair of cuts, leaving 12 drawers, which easily hold the slides, separated down the centre by a ridge $\frac{3}{4}$ to 1 inch wide. Taking a single cut with a gouge out of this ridge opposite each trough makes a convenient place to slip in the

finger-nail to raise a slide. Then the drawers are complete, strong, and firm, and very easily and cheaply made. Cut a shoulder on each side of the drawer, make a plain box of walnut with each side grooved to fit the shoulder of the drawer, and a cabinet is made which will take less than half the time or expense to make of any other, and when done the slides are firmly held, each in its own compartment, and available for inspection or removal, and no danger of removing the cover-glass or label by hasty removal or the motion incident to carrying.

Publications of the Agricultural Experiment Stations.

BY PROF. C. H. FERNALD,

AMHERST, MASS.

Your editorial on "Agricultural Experiment Stations," in the May number, is so sensible and timely that I write to express my appreciation of it. My own work in entomology has hitherto been of a technical character, and has been read only by the scientific entomologists, who have given me my due share of praise, but what I publish in the bulletins of the experiment station here, I am convinced, must be what the farmer can read and profit by. There will of course be many scientific facts discovered of too technical a character for the class of people for whom these stations were established. Shall we publish these technical things in the bulletins, and thus oblige the farmers to hunt through what to them would be chaff to find a few kernels of wheat? For my own part I incline to the impression that we ought to prepare the bulletins for the class they were designed for, and send our purely scientific discoveries to the appropriate scientific journals.

If, however, any of this scientific work can be of profit to the farmers when popularized, this should be done, and the popular papers given to the farmers through the bulletin, while the technical paper should go to the scientific journal.

The demand upon me thus far from the farmers in this State is mainly for information about insects so common and well known that it almost seems superfluous to write about them, yet this is the information they demand and most need just at present. The fact is, these stations to do the greatest good must be public educators, and I have no doubt but that many of the bulletins will, in answer to this demand, present much elementary work for some time to come.

Report upon the Postal Club Boxes—VIII.

BY QUEEN MAB.

Box bb. The fascinations of truth surpass the interest of fiction, and objects, which, in the ordinary mind, excite only disgust, to the trained perceptions and keener vision of the microscopist, become invested with exceeding beauty. The life-history of even the lowest forms of life is more marvelous than any fairy tale. Popularly speaking nothing can be more unattractive than the tape-worm, yet in the last instalment of Cole Studies received, it is shown to be an object of great interest. *Tænia mediocannellata* is one of the commonest tape-worms that infest the human intestines, and its form is that of a many-jointed flat

band, sometimes attaining a length of 16 feet, a breadth of a quarter of an inch in its broadest part, and a thickness of nearly $\frac{1}{8}$ of an inch. The so-called head of the parasite is circular, not exceeding $\frac{1}{16}$ of an inch in diameter, and is succeeded by a still narrower portion, the so-called neck, from which the body enlarges to its posterior extremity, which is its broadest part. Near the head, which is provided with suckers by which the tape-worm attaches itself to the interior of the intestines of its host, the joints or proglottides are short but gradually increase in length until at the posterior extremity they attain a length of $\frac{1}{2}$ inch. Except as to its reproductive system the structure of this tape-worm is simple. A digestive cavity is not required, since its nourishment like that of some of the low vegetable parasites is derived by exterior absorption.

Tænia mediocannellata is hermaphrodite and its reproductive system is complicated and highly developed. Every proglottis is the same as each of the other proglottides at the same age, for the youngest proglottis is that nearest the head, while the oldest is the posterior, the relative age of the intermediate ones being determined by their position in the series. Here as in many forms of vegetable life Nature prevents self-fertilization in that the male and female organs of a proglottis mature at different periods. In the mature proglottis the egg-cavity has developed to such an extent as almost to exclude all the other organs. This proglottis is practically a bag full of mature eggs waiting to be detached and requiring only suitable conditions to develop. The detached proglottis passes from the body of its host with the feces. In some species the detached proglottis maintains an independent life for some days, but in all it sooner or later decays, freeing the eggs. During the life of a tape-worm there is a continued dropping off of ripened segments and a formation of new ones by budding from the head.

Should the tape-worm be called an individual, or, like the Bryozoa, a colony of individuals? Each proglottis is complete in itself and identical with all the others except as to age. *Tænia mediocannellata* contains about 1200 segments, each capable of developing 30,000 eggs. Seldom are more than 80 segments simultaneously filled with ripened eggs, but if the whole 1200 matured at once an aggregate of not less than 30,000,000 of eggs would be produced. The discharged egg of the tape-worm contains in the interior of a capsule a little rounded embryo with three pairs of horny hooklets at one end.

Like the fluke the tape-worm requires to pass the intermediate stages of its development in the body of some other animal than its final host. In this species that intermediate host is the ox, while in another species, *T. solium*, it is the pig. With its filth-indulging propensities it is easy to see how the eggs of the tape-worm may enter the body of the pig with its food, but as regards the fastidious ox it is less apparent. In whatever mode the transference is accomplished into the alimentary canal of the ox, the egg-case is dissolved and the liberated embryo bores its way by means of its hooks through the tissues of its host and becomes encysted in the muscles. When this beef is eaten by a human being, the encysted embryo fixes itself by means of its suckers—already present—and becomes the head of a tape-worm, the chain of proglottides being produced by budding from its posterior end.

NOTES.

In a Watch Factory.—Steel screws are made so minute that it takes 180,000 of them to weigh a pound, and although simply steel, they are worth many times their weight in gold. The naked eye will scarcely recognize them as screws at all; but under a lense they assume the perfect symmetry of little solid screws with rounded, slotted heads, and good, sharp, shapely threads. The jewels, too, are cut from the precious stones, generally garnets, and so small that one would hardly find it if dropped. Yet each piece must be as definitely shaped as if it weighed a pound. And not only so, but into the end of each a hole is bored to receive a moving journal or trunnion. On the accuracy of these largely depends the perfection of the watch, and here the thousandth of an inch variation from correct dimensions would be like Mercurio's wound. It might just as well be "so deep as a well, nor so wide as a church door," if it is to vary at all.

Ferns.—Willard A. Stowell, 222 Second st., Trenton, N. J., has in preparation a catalogue of North American ferns, including Mexico, Central America, and the West Indies. There are many catalogues of ferns north of Mexico, but none include the whole continent of North America. He will esteem it a great favor to receive any notes or communications in regard to the ferns of Mexico and Central America, and will be glad to exchange botanical specimens of the eastern United States for ferns of the southwest.

Thin Sections of Timber.—Mr. R. B. Hough, of Lowville, N. Y., proposed at the Cleveland meeting of the A. A. A. S. a new method of exhibiting and studying the structure of timber. He employs frames made of card-board, holding three samples of the wood, each being about 2 inches wide and 5 inches long, and from $\frac{1}{80}$ -inch to $\frac{1}{200}$ -inch thick. These exhibit the wood in three relations; one slice being transverse across the grain, another radially running from the outside towards the heart, and a third is a tangential section. The first and second show both the sap-wood and the heart. They also reveal the grain and the structure of the wood in a most beautiful manner. These various frames are arranged in book form for the purpose of study and examination. They retain all the characteristics of the wood, and are easily recognized, while the effect of the light shining through them is to show the peculiarities of the grain even more emphatically than would be the case if one were looking at a mass of the wood.

The Microscope in the Cronin Mystery.—In the early morning of May 5th a trunk was found near Lake View, Ill., with one end thrust into a ditch. Captain Villiers and a detachment of officers leaped into the patrol-wagon and made a furious run to the lonely spot where the trunk stood. When they got there they found a large crowd of gaping men and boys who had trampled the grass in every direction. The trunk was taken to the station-house. The first thing Captain Villiers did was to make a careful investigation of the trunk. He found enough evidence to satisfy him that a grown person had been murdered, thrust into the trunk, and then carted to the spot between the two cemeteries.

The trunk had been locked after the body had been placed in it, and

the cotton had been packed about the wounds in order to stanch the flow of blood and thus insure greater safety in its transmission from place to place.

Captain Villiers picked the cotton out and placed it upon his table. Captain Villiers used to be a doctor, and his examination of the cotton led him to believe that the murder must have been committed some time after midnight. Some of the absorbent material was still soft with blood, and there was a pool of fresh blood in one corner of the trunk.

Careful examination of the cotton revealed other things to the officer. He found a lock of dark brown hair, which was almost as fine as a woman's, but not so glossy. This was the only possible tangible clew as to the identity of the victim. The lock of hair was placed under a microscope. It was found to be filled with blood and particles of cotton. The lock looked as though it had been chopped off with a blunt instrument. It had not been pulled out of the scalp, but the hairs were all of uneven length, and looked as though they might have come off the cranium near the forehead. The inside of the cover was bespattered with blood. Some of the life fluid had trickled down the exterior of the trunk, presumably when the body was dragged out upon the ground. There were no marks on the trunk, and aside from the lock of hair there was absolutely nothing left for the officers to hold for identification.

Investigating the effect of remedies by the Microscope.—A new method of research, says Dr. Schneidemühl, has been proposed by Prof. Ellenberger and Dr. Baum who, by means of the microscope, study the effect of drugs on organs. The remedies or drugs were administered to animals, and these having been killed their livers were sectioned in order to find out if the liver cells showed the regular dark granulation of rest, or if on account of increased activity they showed only faint granulation at their periphery. The hepatic activity was found to be stimulated by pilocarpin, muscarin, aloe, salicylate of soda, benzoate of soda, while atropin, sulphate of magnesia, acetate of lead, hydro-chlorate of ammonia, and calomel were inhibitory.—*Journal R. M. S.*, page 1060.

Naphthol alpha.—This drug is reported by Maximowitsch as an antiseptic of extraordinary efficiency in hindering the development of pathogenic micro-organisms. In solutions containing from 1 to 2½ parts of the drug in 10,000 of liquid, it intercepts the propagation of the *Typhoid* and the *Tuberclose bacilli*; while it is reported to be 700 times less active in specific physiological effect on the human organism than Mercury Bin-iodide. As to its anti-zymotic effect—1 part of alpha-naphthol to 10,000 of glucose-solution prevents the latter from passing into alcoholic fermentation.—*Merck's Bulletin*, vol. i, p. 52.

Miss Ella M. Drury, of Natick, Mass., has been in charge of the department of microscopy at the Martha's Vineyard Summer Institute. She teaches the use of turn-table and cell-making; balsam, dry and fluid mounts; caustic potash preparations, staining and double staining of ferns, sections, and animal tissues; section cutting of both vegetable and animal materials. Dishes, bottles, microscope, microtome, all media, reagents, and materials are furnished. The laboratory is open from 8 A. M. to 6 P. M. The five-weeks' term closes August 10th.

MICROSCOPICAL SOCIETIES.

SAN FRANCISCO, CAL.—C. P. BATES, *Secy.*

May 8, 1889.—Among the visitors present were A. W. Craig and W. E. Brainbridge. The latter gentleman gave a good description and exhibited samples of a remarkable find located by him in Ventura county, near the head of the Sespe river. It consists of what is called "gem sand," which, when examined with a power of about fifty diameters, is seen to consist largely of garnets, zirconite, and what parties to whom the material was submitted in the Eastern States pronounced to be diamonds. The gems, to be sure, are small, appearing only the size of a rape seed when magnified fifty diameters, but the presence of such quantities of minute stones surely indicates the existence of larger members of the same family. Mr. Brainbridge remarked that he had no doubt thrown away numbers of the larger stones, thinking them loose quartz crystals, as he was only panning out the sand to find gold or large garnets.

Professor Hanks, who has made a close study of the gem, stated that the small stones said to be diamonds had all the characteristics of the California diamond. The metal platinum is also present in this sand, but whether in quantity sufficient to make it of commercial importance has not yet been ascertained. The zirconite occurs in square prisms with pyramidal terminations, and the stones are of a light-brown color and very transparent. Altogether, the discovery of Mr. Brainbridge is a remarkable one, and its future investigation will be watched with great interest. It might be mentioned that the sand, of which samples were shown, extends over a space of one-half to three-quarters of a mile wide by several miles in length.

Mr. Wickson exhibited a peculiar entomological phenomenon—the common aphid attacked by the "Fly cholera," or, *Empusa muscæ*. The gentleman explained how the fungus spores lodge on or become attached to the body of a fly, immediately commence growing, and penetrate through the skin. Once inside, the spore rapidly increases by self-division, in the manner of yeast cells. The first stages of the disease is indicated by the restlessness of the attacked flies; they soon, however, become weak and slow in their motions. Having securely fastened themselves with their broad tongues to the object upon which they happened to be when attacked by the last stages of the disease, a succession of spasmodic tremors pass through their wings and legs and they stiffen themselves out to fly no more. The abdomen of the victim of this disease, previously already swollen, becomes more and more distended, and a fatty, whitish substance pushes through the softer membranes between the chitinous rings or segments. Soon after a whitish halo of spores is formed around the dead body, readily seen if the fly happens to have fastened to the glass of mirror or window-pane. These spores gradually cover the whole insect with a white dust, and they appear in ever-increasing numbers as the body of the victim dries up, until at last its whole interior is empty and only a shell remains. From an examination of the affected aphid there appeared no reason to doubt but what the fungus developed and ran its course the same as in the fly, their bodies being distended and surrounded with the white halo

of filaments bearing ripe spores ready to be thrown off and carry on their work of inoculation.

It was suggested that here might be found a remedy for these annoying pests by systematically inoculating *Aphis colonias* when existing epidemically, and Mr. Wickson stated that such a course had been spoken of, but could not say that it had ever been carried out. Unfortunately, the more destructive of the fruit and grain pests do not seem to be seriously attacked by this fungus, although the chinch bug has an inveterate enemy in an allied fungus termed *Entomophthora*, which also carries off the larvæ of certain butterflies.

The donations to the library were current numbers of the monthly journal of the Royal Microscopical Society, and a copy of the annual report of the Alameda Board of Health, donated by Dr. Rhiel. Samples of the Redondo beach diatomaceous earth have been forwarded to various kindred societies at home and abroad, and the Corresponding Secretary stated that a sample of the interesting gem sand would be sent to the Royal Microscopical Society.

—o—

LEAVENWORTH MICROSCOPICAL SOCIETY.

June 4, 1889.—One of the great pleasures of the evening, at the residence of Prof. Lighton, was a visit to the Society by Dr. Theo. G. Stanley, of Kansas City, Mo.

This gentleman brought with him a complete series of slides of his own preparation, illustrating the growth and development of the tooth. Very many of the slides were worth their weight in gold, and were described by Dr. Stanley in such a full and complete manner as to place the Society under great obligations to him.

Prof. Lighton exhibited a fine collection of teeth of his own preparation, containing several specimens of recent and fossil shark's teeth, teeth of the snail, tooth of the horse, and human teeth. One of the sections of human teeth was cut to a thickness of only one twenty-four-hundredth of an inch thick, *mounted in styrax*, exhibiting in a highly interesting manner the union of enamel and dentine.

Dr. Bidwell exhibited some very fine sections of human teeth and some highly interesting vegetable sections.

—o—

SAN FRANCISCO, CAL.—C. P. BATES, Secy.

June 12, 1889.—The semi-monthly meeting was held at its rooms, President Payzant in the chair. A. H. Breckenfeld, the Vice-President, was present for the first time since recovering from his severe illness, and exhibited some fine specimens of *Melacerta ringens*, a tube-building rotifer, belonging to the family of wheel animalcules. This variety is considered the most beautiful of the species, and builds for its protection an ingenious tube, which it forms of round pellets that are elaborated in the interior of the animalcule, and securely gummed together with a secretion derived from the same source. This rotifer, when feeding, extends itself partly from its tube and by means of several rows of cilia produces a rapid rotary motion, one set of cilia drawing a current of water containing food to its mouth, while another row ejects the *débris* by a current produced in an opposite direction. The tube and occupant are highly transparent and viewed by dark-ground illumination never fails to excite astonishment and wonder at the sagacity

displayed by nature in protecting these minute organisms from their enemies and furnishing them with such elaborate means for obtaining their subsistence. Mr. Breckenfeld also exhibited a slide of *Ecidium* or "cluster cup fungus," found infesting the scanty vegetation on Signal Peak, Yosemite Valley, some seven thousand feet above sea level.

Dr. E. G. Clark exhibited some interesting slides of cinnabar ore in Chalcedony showing free mercury, a rare thing in the natural state; also a beautiful mounting of crystallized gold, displaying the peculiar fern-leaved disposition of the crystals produced by the galvanic current.

The most notable feature of the evening was the exhibition by Charles C. Riedy of his collection of old and rare works of the early writers on microscopy. To the student and all interested in micrographical literature this was an opportunity seldom offered to examine many volumes published by the pioneers in this branch of science, that are now very scarce. Mr. Riedy is devoted to the study of the Infusoria, and to facilitate his inquiries in that direction the present collection has been slowly accumulated, though not without great difficulty and perseverance, many of his orders for special works having been several years in the hands of European book-dealers before they were obtained. The different volumes cover the entire field of microscopical research from its very beginning, and contain a complete *résumé* of the evolution of optical science, together with the progress of mechanics as applied to the microscope. Many of the editions, in fact a majority of them, contain a high grade of illustrations, considering the date when they were executed, while some are embellished with fine-line copper-plate engraving that would do credit to our own day. The oldest publications, belonging to the fifteenth and sixteenth centuries, are all bound in heavy parchment, and mostly written in the scholarly language of the time—Latin. The printing is remarkably good and legible, there being no perceptible fading of ink or paper. The authors represented were Adams, Baker, Baster, Bonanni, Descartes, Ellis, Eichhorn, Gleichen, Götze, Grew, Hill, Hooke, Joblot, Ledermüller, Leeuwenhoek, Martin, Needham, Power, Redi, Schäffer, Glabber, Smith, Spallanzani, Schott, Swammerdam, Trembley. Notable among these are Descartes' works, with numerous wood-cuts, small quarto, Amsterdam, 1650. This work contains an illustration of Descartes' gigantic microscope, eight feet high.

In the collection is Powers' "Experimental Philosophy, in Three Books, containing New Experiments, Microscopical, Mercurial, Magnetical." London, 1664. This last work is the earliest volume on the microscope in the English language.

Before adjourning a unanimous vote of thanks was tendered Mr. Riedy for his interesting exhibition of what is certainly the most unique collection of rare microscopical literature in the United States.

NOTICES OF BOOKS.

The Psychic Life of Micro-organisms. By Alfred Binet. Translated from the French by Thomas McCormack, with a preface by the author. Chicago, 1889. The Open Court Publishing Company. (Price, 75 cents.)

M. Alfred Binet, the collaborator of Ribot and Féré, and one of the

most eminent representatives of the French School of Psychology, has presented in the above work the most important results of recent investigations into the world of micro-organisms. The data of this department of natural science lie scattered for the most part in isolated reports and publications, and no attempt has hitherto been made to collate and present them in a systematized form. Especial use has been made of the investigations of *Balbani*, *Claparède* and *Lachmann*, *Maupas*, *Ribot*, *Engelmann*, *Pouchet*, *Weber*, *Pfeffer*, *Kent*, *Dujardin*, *Gruber*, *Nussbaum*, *Bütschli*, *Lieberkühn*. The cuts, eighteen in number, are illustrative of the movements, nutrition, digestion, nuclear phenomena, and fecundation of proto-organisms. The most interesting chapters are those on fecundation, which demonstrate the same instincts and vital powers to exist in spermatozoids as are found in animals of higher organization.

M. Binet's researches and conclusions show "that psychological phenomena begin among the very lowest classes of beings; they are met with in every form of life from the simplest cell to the most complicated organism." The author contests the theory of Romanes, who assigns the first appearance of the various psychical and mental faculties to different stages or periods in the scale of zoölogical development. To M. Binet there is an aggregate of properties which exclusively pertain to living matter, the existence of which is seen in the lowest forms of life as well as in the highest.

SUBSCRIBERS' NOTICES.

[These notices will be given six insertions in this column at 25 cents per line or fraction thereof.]
FOR EXCHANGE.—Slides of selected diatoms. D. B. WARD, Poughkeepsie, N. Y.

WANTED.—Unmounted microscopical material, also micrographic dictionary. Will exchange or buy.
CHARLES VON EIFF, 124 Clinton Place, New York City.

WANTED.—A clean copy of Rev. William Smith's British Diatoms, and Schmidt's Atlas of the Diatomaceæ.
JAMES B. SHEARER, Bay City, Mich.

OFFERED.—Diatomaceous Earth from Utah (Desert) for Histological Mounts.
PROF. ORSON HOWARD, Salt Lake City, Utah.

CORRESPONDENCE invited with a view to the exchange of either mounted or unmounted Oribatida (British) for American species.
E. BOSTOCK, Stone, Staffordshire.

WANTED.—Specimens of rocks for slicing and grinding into sections; also bones and teeth of different animals, diatoms *in situ* on algae, diatomaceous and polycystinous earths, ocean soundings, etc., etc. Liberal exchange in microscopic slides or cash.
ARTHUR J. DOHERTY, 63 Burlington St., Manchester, Eng.

TO EXCHANGE.—Native gold, silver, copper, lead, zinc, and other beautiful cabinet specimens, polished ornaments and sections of petrified wood—Chalcedony—and native turquoise, agate, amethyst, rubies, etc.; also Indian ornaments, curios, arrows, blankets, pottery, etc.; pelts of wild animals, species of native cactus, and a good second-hand "Burt's Solar Compass" complete. Any or all of the above are offered in exchange for new, or good second-hand, objectives, condensers, polarizers, stand, or other microscopical apparatus.
W. N. SHERMAN, M. D., Kingman, Arizona.

OFFERED.—Zeiss' New Catalogue (in German) forwarded for 10 cents in stamps.
F. J. EMMERICH & SONS, 43 Barclay St., New York City.

WANTED.—Any works on Microscopy not already in my Library.
H. M. WHELPLEY, F. R. M. S., St. Louis, Mo.

WANTED.—(In exchange for slides.) "Microscopical Bulletin," Vol. I, No. 5, August, 1884, and Vol. II, No. 1, February, 1885.
M. S. WIARD, New Britain, Conn.

Labels in exchange for slides.
EUGENE PINCKNEY, Dixon, Ill.

First-class Histological Slides for other good mounts; Histological and Pathological material cut on shares.
S. G. SHANKS, M. D., 547 Clinton Ave., Albany, N. Y.

WANTED.—A set of Proceedings of the American Society of Microscopists. State price of set or of single volumes, kind of binding, etc. Also, any other microscopical periodicals.
P. O. BOX 630, Washington, D. C.

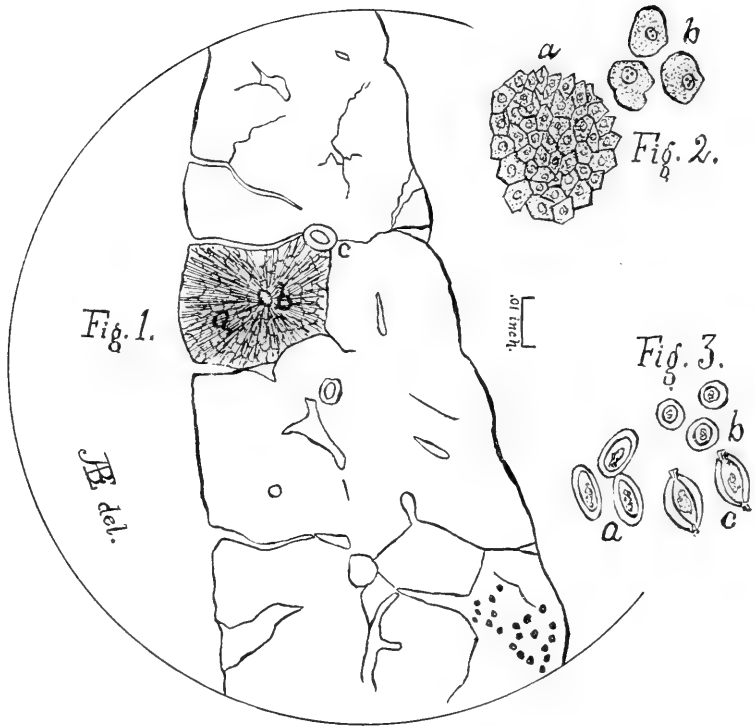

SECTION OF LIVER CONTAINING EGGS OF A WORM.

THE AMERICAN MONTHLY MICROSCOPICAL JOURNAL.

VOL. X.

SEPTEMBER, 1889.

No. 9.

All communications for this Journal, whether relating to business or to editorial matters, and all books, pamphlets, exchanges, etc., should be addressed to American Monthly Microscopical Journal, Box 630, Washington, D. C.

European subscriptions may be sent directly to the above address accompanied by International Postal Order for \$1.15 per annum, or they may be sent to Messrs. Trübner & Co., 57 Ludgate Hill, London, or to Mr. W. P. Collins, 157 Great Portland street, London, accompanied by the yearly price of five shillings.

Ova of *Trichocephalus Dispar* in the Liver of Rat.

WITH ONE PLATE.

By EDWARD A. BALLOCH, M. D.,

WASHINGTON, D. C.

In calling attention to the subject indicated in the title of this paper, I have been guided by the idea that one slide carefully and exhaustively studied is often of more benefit than a more ambitious attempt to cover a larger field at the expense of thoroughness. Keeping this idea in view let us now study the slide before us, which is one that has often afforded me pleasure and profit. I propose to take it up as if it were not labelled and as if we were studying it for the first time.

First, then, as to the macroscopic appearances. Holding the slide to the light we see it to be a section about one-half inch long by one-eighth inch broad, with an outline like the Italian letter "s." We also see that it is intersected by numerous fissures and that different parts of the section have different colors. Now, let us place it on the stage of the microscope and examine it, using first the lower powers. All the naked-eye details are now seen to be intensified.

The whole section is seen to be bounded by a limiting membrane, prolongations from which also line the numerous fissures. From this we argue that we have to do with a section of a complete organ or structure. But what organ or what structure is it? Let us try to determine.

We see that the section is divided into a number of subdivisions of an irregular polygonal shape, some of which are quite distinct, while others seem to be fused with neighboring subdivisions.

The one marked *a* (Fig. 1) seems to be the most typical. Let us examine it. It is of a pentagonal outline and separated from contiguous subdivisions by well-marked fissures. In its centre is seen an opening and with care we are able to make out a delicate lining membrane.

The opening, therefore, is not adventitious. This opening is seen at *b*. At the junction of our subdivision with the neighboring ones we see another opening, *c*, with more distinct lining membrane.

The contents of the subdivision seem, with a low power, to be of a granular nature, separated, or rather penetrated, by fine channels which converge from all parts of the lobule to meet at a common centre at *b*.

In one part of the field we see what seems to be a mass of black dots, in no way resembling the other parts of the structure and which have not taken the stain.

We will now use the higher power and endeavor to make out more closely the nature of the structure we are studying.

What, with the low power, seemed to be a mass of granular matter is now seen to be composed of pentagonal cells, with large nuclei and one or more nucleoli. (Fig. 2, *a* and *b*.) Each cell is separated from its neighbors by the fine channels before referred to. The fissures are seen to be composed of connective tissue. The opening at *c* (Fig. 1) is seen to have a *tunica adventitia* of connective tissue and a lining membrane composed apparently of a single layer of epithelial cells. It is clearly separable from the surrounding tissue.

At *b* the lining membrane is very delicate and the epithelial cells crowd closely around it, making it appear that in some places the lining membrane is merely the walls of the epithelial cells themselves. We are warranted, from these details, in pronouncing the opening at *b* to be a vein and the one at *c* a duct. In other parts of the structure, in the connective tissue between the subdivisions, we see the well-known appearance of an artery cut across and accompanied by a vein and a duct, the artery being the smallest of the three. Let us now sum up.

We have a whole organ, divided into irregular, generally pentagonal lobules, composed of polygonal epithelial cells, each with its nucleus and one or more nucleoli, the cells being separated from each other by fine inter-cellular channels. Each lobule has a central vein, and in the inter-lobular connective tissue are found artery, vein, and duct.

This appearance is characteristic of but one organ, viz., that which we call the liver.

We can safely say, then, that we have to do with the section of a liver, and since the section is that of a whole organ, the liver must be that of a small animal.

A rough guess at the weight of this liver would put it at one-fourth of an ounce, and, assuming the proportion of the weight of the liver to that of the whole body as one to forty, we might infer that the weight of the animal from which this liver came was about ten ounces. If it be a fact, as Klein states (*Elements of Histology*), that in man, carnivorous animals, and rodents the lobules of the liver are more confused and less distinct than in other animals, we should be justified in assuming this to be the liver of a small carnivorous animal or of a rodent. This brings us to the end of our facts concerning the main portion of our section. Deduction will carry us no further, I think.

But there was another part of our slide which, under the low power, seemed a mass of black dots, and which has a different color from the remainder of the tissue. What of this? Let us apply the same methods of investigation to this as to the rest of the section and from the facts observed reach our conclusions.

We notice four distinct appearances :

1st. Oval bodies with an outer and an inner membrane, the inner being the sharper and apparently the thicker. In the centre of this body is a mass of granular material, irregular in outline and of a shrunken appearance, occupying fully one-half the central cavity. The granular material has taken the stain ; the rest of the body has not. (Fig. 3, *a*.)

2d. Round bodies having the same diameter as those first noticed, the same outer and inner walls and the same central granular mass. (Fig. 3, *b*.)

Clearly these are the bodies first noticed, cut through their short diameter.

3d. Opaque, black bodies, having the same size and shape as our first ones. An outer, but not an inner, membrane can be made out. They reflect light, but do not polarize.

We are warranted, I think, in the assumption that we have to deal with the same bodies as before, but bodies which have undergone a degeneration, most probably the calcareous one.

4th. In some of the bodies we notice on one end, and in some on both ends, short prolongations of the outer membrane which by focusing are seen to be tubular. With the power used I cannot say whether they do or do not communicate with the central cavity. (Fig. 3, *c*.) Apparently they do. I am also uncertain as to whether or not the inner membrane lines these prolongations. With the one-fifth I cannot see that it does, and as I do not propose to go further than the facts observed will warrant me, I shall leave this for future study with higher powers.

Looking over these four groups we see that they are but variations of the same body. We also see that in this body there is no trace of circulatory or nervous systems, no breathing or digestive apparatus. It is evidently a cell, and it is equally evident that it is a parasite, as it differs entirely from what we have seen to be the normal structure of the liver.

I am not aware of any vegetable parasite which possesses the power of living and developing in a like situation, and this cell evidently has lived and developed since it and its companions have replaced a considerable amount of liver-tissue. We may assume, then, that we are dealing with an animal cell. I will not stop here to enumerate the characteristic qualities of the ovum. They are known to you all. I will merely say that in shape and structure our unknown body fulfils the requirements of an ovum in that it is oval, has an outer and inner membrane, inclosing granular contents. We are dealing, therefore, with ova. We know that the ova most likely to be found in the liver are those of the intestinal worms. Let us, therefore, examine the intestinal parasites and their ova and see if we can find anything answering to what we have seen. And here we must leave our microscope and accept facts observed and noted by others. Any helminthologist would go at once to Leuckart and Cobbold. Let us follow his example.

Among the Nematode worms of the family Filaridæ we find one, *Trichocephalus dispar*, the ova of which are described as having a longitudinal diameter of from $\frac{1}{340}$ inch to $\frac{1}{320}$ inch and having at each end a protrusion in the form of a papilla. Embryos are scarcely or never seen. Some authors describe and figure the protuberance as composed

of the inner and others as composed of the outer membrane. So far as I have observed in this specimen, the papilla is composed of the outer membrane, but I hope to investigate this point further and with higher powers. The ova develop slowly, and at the end of several months at the earliest and often not for a year and a half or more a worm-shaped embryo may be found. They have great power of resisting the influence of external surroundings and may be dried or frozen without losing vitality, though their development may be arrested. They are probably introduced into the body by means of food or water.

So far as the description of the ovum above given goes, it applies perfectly to our specimen, and as I can find no other ovum having this peculiar projection on each end, we may ascribe our ova to *T. dispar*. Therefore from our study of this slide we conclude that we have to do with the liver of some small carnivorous animal or rodent, several lobules of which have been replaced by the ova of *Trichocephalus dispar*, a nematode worm of the family FILARIDÆ.

This completes our study. It has been my endeavor to show what may be done with a medium grade instrument, without extra appliances, and with ordinary powers ($1\frac{1}{2}$ inch to $\frac{1}{8}$ inch), and to show that any slide, carefully studied, will amply repay the time spent upon it. If I have succeeded in demonstrating this I am abundantly satisfied.

DISCUSSION OF PAPER.

At the meeting of the Washington Microscopical Society, when this paper was presented, Mr. Smiley said: I am pleased with the manner in which the subject has been treated. By taking one step at a time and giving reasons for each step a subject may be thoroughly explained. This is the method adopted by Dr. James, of St. Louis, in his work on Microscopy, by means of which a beginner may take up microscopy and find every step carefully and progressively explained.

Dr. Acker said: This method is the one used by Virchow in his teaching. As to this worm I have seen it commonly in Germany, but I have searched for it carefully in every *post-mortem* examination made by me at the Children's Hospital in this city, but without success. It is commonly found in the calcæum.

Dr. Balloch said: I was led to treat this slide in this way by my own experience with text-books, which most commonly tell you that a thing is so, but do not say why it is so.

Mr. Duff showed a fine photograph of *Trichocephalus dispar*, encapsuled in the liver of a spitz mouse, which was made by Dr. Gray, of the Army Medical Museum. The ova were magnified 350 diameters and showed the same structure and general appearance as those in Dr. Balloch's specimen.

Ginn & Co's Catalogue and Announcements.—Under the various headings of Old and Middle, English Elementary and Higher English, Latin, Greek, Mathematics, Natural Science, Music, History, Philosophy, Modern Languages, Sanskrit and Avestan, Political Science, Geography, and Miscellaneous are given a large number of titles, brief statements relating to the main features and contents of the present editions and the price of all college and high-school books published by this firm. Students will find its pages worth a careful perusal.

Forensic Microscopy, or the Microscope in its Legal Relations.*

By W. J. LEWIS, M. D.,

HARTFORD, CONN.

The occasion which brings us together at this the Twelfth Annual Meeting of our National Organization is one of unusual interest. Ours is a society composed of persons representing every department of natural science, diligent seekers after truths, penetrating more and more as the years roll on the innermost secrets of nature and lifting the shrouding veil of mystery from the dogmas of old; its members engaged in special pursuits, apparently widely separated, into which, partly from taste, partly from environment, we have as individuals been led, yet united in the one distinctive field of requiring the aid of that king of instruments, the microscope, in our varied and multitudinous investigations.

Coming from widely-separated parts of a great country, we meet once a year to glean from one another the experiences of a twelvemonth; to acquire in a few days, through such interchange of ideas and thought, a practical knowledge which might otherwise necessitate years of unaided individual work to encompass. It is surprising that the need of such an organization should ever have been questioned; surprising, too, that its necessity was not sooner appreciated.

No instrument yet devised by the ingenuity of man equals the microscope in its universal application to research in the broad domain of science, and this evening I purpose to call your attention, in a brief way, to some of its special relations to jurisprudence.

Taking advantage of that subtle power of the human mind to ignore space, let us for a moment glance into the past, that we may better appreciate the present status of science; briefly review some of its victories over superstition and ignorance and recall to mind those who, having gone before, have laid much of the foundation for that edifice wherein rapidly-increasing knowledge is enlightening its devoted students.

Medical jurisprudence, to which science the microscope, in its legal relations, is most closely allied, dates from the early part of the seventeenth century, when the first treatise on forensic medicine appeared, a work written by Zacchias, then one of the Pope's physicians. In it he devoted chapters to prophecy, miracle, sorcery, torture, and kindred subjects. Suffice it to say, this once able work by the father of legal medicine is no longer cited as an authority. The new-born science, receiving little encouragement in Italy, was soon transplanted to Germany, where it was carefully nurtured under government protection until the favorable legislation of 1532 made it obligatory on courts to take the evidence of medical men in all cases involving medico-legal questions. From that time, aided by subsequent legislation, until the present Germany has held her supremacy in forensic medicine. The work of Zacchias was superseded as early as 1730 by the justly-celebrated productions of Albertus, Valentina, and Teichmeyer.

France, in about 1600, enacted laws similar to those then in vogue in Germany, and made considerable progress in the science until 1692,

* Annual address before the American Society of Microscopists, read at the Buffalo meeting, August 24, 1889.

when medico-legal offices became hereditary and corrupt, and remained so until the French Revolution. Since 1803 France has required of her medical experts, who, by the way, are appointed by the court, and not as in this country retained by counsel, to be graduates in medicine and also to pass a rigid examination on medical jurisprudence, in which study they are presumed to have had special training.

No direct application of the microscope to questions of law or of legal medicine was made until about 1835, since which time it has been used repeatedly in convicting the guilty and acquitting the innocent. No longer are we obliged to resort to expedients taught by Albertus in 1726, such as that the victim's wounds would open and bleed afresh in the presence of the murderer, or the time-honored custom of watching the effect upon a suspected criminal as he touched the dead body of his supposed victim—the latter test having been used until well into the present century.

As the greatest advances made in placing medicine as a science on a proper foundation date from the application of the microscope to physiological investigations, it is not strange we should find it at the present time occupying a large and important field in medico-legal research.

At first, the microscope in its legal relations was confined to a few questions in criminal law. With the improvements in modern lenses, with the new and perfected means of determining minute measurements, with the adaptation of the spectroscope and other accessories, it has assumed such importance in both criminal and civil law as to justify the coining of the term, Forensic Microscopy. Although the microscope has for a number of years played an important part in many noted criminal cases, its proper relation to law, and especially to medical jurisprudence, is little understood. By many its powers are overestimated, while others underrate its value, or even cast aside as worthless all testimony relating to the results obtained through its use.

It is an unfortunate though existing condition which permits a person to testify as an expert in branches where he has but little more knowledge than his hearers. Partly from this cause discredit has been thrown upon the whole field of expert testimony in this country. Physicians as a class are noted for never agreeing with one another, especially when called upon to testify as witnesses. It is proverbial that an equal number of medical experts may be obtained to express themselves on opposing sides. This, however, relates purely to their opinions or their respective interpretation of facts. Such disagreement is not confined to the medical profession, but invades all branches of expert testimony. In cases involving questions of mechanics and physics it is of frequent occurrence for expert machinists, electricians, and others, to express exactly opposite opinions, and a notable example of this may be found in the voluminous testimony recently taken in the State of New York on the question of executing criminals by electricity.

Where, however, two or more persons, expert in the use of the microscope, are called upon to testify, there should be no disagreement as to the results of any examination they may make. Thus, for example, in the examination of a stain, if blood corpuscles are found, that should be determined equally well by each. If measured, their measurements should correspond exactly. There should be no difference on

these matters of fact, though their opinions as to how the blood came there, how long it has been there, or like questions, may be honestly opposed.

In the broad field of chemistry and toxicology the microscope is not only an important means by which to determine the composition of fluids and solids, but is frequently used to corroborate ordinary tests made in the chemical laboratory.

It is not many years since that deaths from poisoning were surrounded by a fear and dread scarcely appreciable at the present day. Then, the action of poisons and their means of detection were unknown. So great an atmosphere of suspicion and dread surrounded a sudden and inexplicable death that the grossest legal abuses prevailed. Severe punishments were inflicted upon persons suspected of having committed murder by poisoning, and those convicted in England were for a long period broiled alive, and in France, burned at the stake even so late as 1791. With modern methods of investigation a knowledge of poisons has been obtained, and methods introduced for their detection have become so perfect as to render the fear of discovery greater than the fearful and indescribable dread once experienced of being the victim of a mysterious death.

With a special form of the modern microscope made for chemical work so arranged that the objective is below the stage, where it is protected from the corrosive action of reagents, qualitative chemical analysis of minute quantities may be conducted with ease and accuracy, the reactions and crystalline deposits of different chemical combinations being observed through the instrument. Although the inverted microscope has been known for some years in the forms issued by M. Nachet, it has been used but little on account of its limited scope and unsatisfactory definition as compared with the usual upright model. Through the combined skill and ingenuity of one of the members of this Society, Mr. Edward Bausch, the instrument has been greatly modified and improved and introduced in the form of a combined inverted and vertical microscope. The practical application of the present model extends the field it was intended to occupy, and renders easy micro-chemical investigations heretofore impossible, or requiring the most delicate and tedious manipulation.

The greatest advance made in modern legal chemistry was through the brilliant achievements of Bunsen and Kirchhoff in 1859, by which we are enabled, through the means of the spectroscope, to identify with unerring accuracy not only the elementary forms of matter but many compounds, and in quantities so minute as to be beyond the reach of all other known methods of analysis. With the great activity characteristic of modern science, no sooner was the wonderful capacity of the spectroscope appreciated than efforts were made to devise a combination whereby it could be utilized in microscopical research. Largely to the efforts of Mr. H. C. Sorby this was accomplished and the micro-spectroscope introduced, through which new and important discoveries have since been made, especially in the field of forensic microscopy. The first notable improvement in micro-spectroscopes was a modification by Zeiss, of Jena, who devised an arrangement whereby the direct vision prism may be turned one side, and the slit opened, thus enabling the object under inspection to be accurately focused.

A variety of scales have been used for mapping out and measuring the absorption bands, the best being that in the Zeiss instrument referred to, where the scale is ruled to read in wave lengths. In determining the exact location of the absorption bands it is essential that the eye should be kept in a fixed position, as the least motion on the part of the observer alters the apparent relation of the bands to the bright lines of the scale, sufficient to confound, for example, a spectrum of blood with that of some other red fluid. Prof. Moses C. White, of Yale College, a member of this Society, who has had a long and varied experience in the use of the microscope in medico-legal cases, a few years since devised and perfected a micro-spectroscope which entirely overcomes the requirement of holding the eye steadily, and renders the practical utility of this feature of the instrument equal to its theoretical value.

All the best forms of modern micro-spectroscopes are provided with an arrangement whereby the spectrum of a known solution may be examined in direct comparison with the one under observation. The great delicacy of this instrument, and the importance of its application in legal examinations, can hardly be overestimated. Mr. Sorby and others have claimed they were able to reveal the presence of a single blood corpuscle by its spectrum, and their observations are confirmed by Prof. Theodore G. Wormley, of the University of Pennsylvania. The delicacy of the test may be better understood when we remember that the estimated weight of a human-blood corpuscle is about one five-hundred-millionth of a grain.

By the aid of these instruments, and through discoveries already made, the foundation has been laid for a branch of investigation in criminal cases which will at no distant day be better understood. I refer to the critical and systematic study of dyes and other substances used in the manufacture of textile fabrics. It frequently happens that wool, cotton, and other fibres are found on murderous weapons submitted to experts for examination. These often contain artificial coloring matter, which may or may not correspond to similar fibres in the clothing worn by the victim or the accused. In an examination of a suspected blood stain, involving the question of crime, the micro-spectroscope may be used to corroborate other tests. While it enables us to discriminate between the coloring principles of blood and other fluids, it does not assist in distinguishing between the blood of different animals.

Considerable attention has been given of late to the microscopical examination of handwriting, both in criminal and civil cases. Differing from the views of most writers on the subject, I consider the instrument of no aid in forming an opinion as to the author of a given specimen of penmanship, its value being confined to the determination of alterations and changes made in the original. The slightest derangement in the fibres on the finished surface of the paper cannot be restored by the most skilful forgers. It is impossible to make an erasure of either pencil, pen and ink, or printed lines, which the microscope will not detect.

One of the commonest methods employed in imitating handwriting is to first take a pencil sketch or tracing, which is afterwards inked and the pencil marks erased. No matter how delicately this erasure is performed, under the proper lens the surface of the paper will disclose

when this method has been employed. Not only can the abraded surface be easily distinguished, but particles of graphite are almost invariably found. When the original has been obliterated by bleaching with chemicals sometimes used for that purpose, the consequent stain removed and other words substituted, the microscope furnishes a sure and ready means of detection.

A material change in a legal instrument may sometimes be accomplished by the addition of a few strokes of the pen here and there, which would escape observation by the most critical eye, yet, when viewed through a glass of adequate power their true character might be revealed.

Prof. Albert McCalla, in his presidential address delivered before this Society at its Chicago meeting, says, "The microscope is an unerring detective." To illustrate the truth of this statement and to show the numerous and unexpected roads through which legal microscopy leads one, I would call attention to an interesting case coming under my observation several years since.

A burglary had been committed. Prior to the discovery of the crime two men were arrested by the police as suspicious characters. When the theft was reported, suspicion immediately fell upon the prisoners, though nothing could be found upon their persons to connect them with the deed. As a last resort their shoes were submitted, to ascertain if a microscopical examination could possibly reveal the desired clue. These shoes, though by no means microscopic themselves, furnished sufficient material for the most enthusiastic scientist. Those who have ever examined similar articles, which have been occupied for months in collecting specimens, can appreciate the food for scientific thought thus accumulated. Mingled with a vast assortment of debris, between the soles and uppers were found little patches of wheat flour. It was then learned that entrance had been effected through a pantry window, and the men in their operations had upset a pan of flour standing on a shelf near by. Although when first charged with the offence they had denied all knowledge of it, yet, when the result of the microscopical examination was made known, they confessed their guilt.

Another instance in which a crime was detected and demonstrated solely by the aid of the microscope is worth citing: Two elderly maiden sisters lived in a small frame-house in a country village. One night their dwelling was discovered to be on fire. An alarm was immediately raised and neighbors collected, who used every effort to subdue the flames, but without avail. The entire house, with its contents, was consumed. A search among the ruins revealed the charred parts of all that remained of the former occupants. The origin of the fire was a mystery. An investigation was ordered to ascertain, if possible, not only its cause, but also to determine whether the sisters were burned to death, or whether murdered and the house burned to conceal the crime. Not enough remained of the bodies to throw any light upon the subject. Their hair, which was long and heavy, was found intact. This was embedded in a puttatious, brownish-colored mass, which I found upon microscopical examination to be composed entirely of blood, which had coagulated and been partially dried by the intense heat, yet had retained sufficient moisture to preserve the hair and pieces of clothing found in the same place. Of course, such an outpouring of blood must have

occurred prior to death, and could not have been caused by the fire, the action of heat being to coagulate and stop its flow. Owing to the quantity of blood found with the long hair of the head, the natural inference was that the larger vessels of the neck were cut, and the bodies afterwards burned.

The attention of an expert, called to make a microscopical examination in a case involving a question of crime, is generally directed towards determining the nature and source of the material under observation. This is frequently of animal origin. At the very outset we are met by the stubborn fact that no histological tissue is sufficiently characteristic of the particular animal from which it is derived to enable us to determine its absolute source in all cases, and this is not strange when we consider the theory of evolution generally accepted by scientists of the present day. Indeed, we could hardly expect to find a morphological tissue which has not its counterpart in microscopic animal or vegetable life. One form naturally blends into another in the development of species, an absolute line of demarcation in histological elements being beyond the power of the microscope to determine with our present knowledge. Lawyers, ever mindful of their clients' interests when the evidence is against them, cling to this loop-hole with great tenacity.

The examination of a supposed weapon should be conducted with the greatest care, and full notes taken of every process in the operation. The weapon itself should be described, with the measurements and notes of all spots or marks which might in any way bear upon the case, and their relation one to another. It is also frequently advisable to make photographs for record and future reference. A thorough search should be made for any hairs, fibres, or other substances, which, if found, should be carefully removed for further investigation, their exact position having been previously noted, and the specimens properly marked to prevent confusion and future complications. Careful investigation of filaments thus obtained, and which are unfortunately frequently overlooked, will oftentimes reveal valuable information otherwise escaping observation.

Little of value has been written on the subject of hair in its medico-legal relations. Although nearly all treatises upon medical jurisprudence, both in the English and foreign languages, mention the subject, they are largely copied one from the other, and based upon comparatively little original research. While we may not be able to positively determine the source of a given hair or fibre by examination alone, yet, when taken in connection with other information, doubt may sometimes be removed and conclusive evidence established.

In a recent case occurring in Connecticut a man was found on his barn floor mortally wounded. He remained unconscious until his death. The injuries were a fracture of the skull and several lacerated wounds of the scalp, some extending beyond the hair-line well onto the forehead. A murder was suspected and a young man arrested for the crime. A piece of scantling some three feet long, covered with blood at one end, was supposed to have been the instrument used by the assailant. On an examination of the weapon, I found, among other things, a number of minute downy hairs imbedded in the blood. During the subsequent trial, the defence set up was that the man had fallen

from a hay-mow, striking his head upon the stick in question, thus producing the injuries. Distinct spots of blood indicative of blows were found on different sides of the club, and the defence, in trying to make this evidence conform to their theory, raised the question of the origin of these minute hairs. The testimony was to the effect that they came from the forehead of the deceased. This opinion was not, however, based solely upon a microscopical examination of the hairs, but in connection with other testimony previously introduced, the query being, substantially, what evidence was there to show that these minute hairs had any connection with the case, assuming the blood to have been from deceased.

The examination showed the hairs to have been torn out by violence, inasmuch as many of them still retained the bulb and bits of lacerated tissue, and the cortex more or less torn. They were found fixed upon splinters of wood in locations some inches apart, and also on different faces of the scantling. There being no similar hairs on any portion of the scalp where the wounds occurred, except the forehead, where they are plentiful, it is obvious they must have come from the latter location. The hairs were embedded in groups too widely separated to conform to the theory that they were produced by a fall or one blow, when considered together with the surgical relation of the wounds. A strong effort was made to throw doubt on the value of this testimony and confuse the jury, on the ground that the hairs of some animals measured the same in diameter as these referred to, and that it was, therefore, impossible to discriminate between them microscopically. On this account it was claimed that the hairs might easily have been from another source, the one on which the greatest stress was laid being the fine downy hairs from a mouse. Any person familiar with the microscopical appearance of hair from rodents will appreciate the absurdity of claiming a resemblance between those and the human hair in question.

In opinion-evidence relating to hair, and the same may be said of nearly all other animal tissue, the truth can often be better reached by exclusion than by an attempt to designate the particular animal or person from which it is derived. Microscopical differences between the hairs of various animals are, as a rule, far easier to determine than in the case of blood, the optical image being generally so characteristic as to sanction, at least, the exclusion of many sources without further investigation. Micrometry is of little value in diagnosing a particular hair, so far as its diameter is concerned, though of aid in ascertaining the relative portions of medulla and cortex.

The cortical substance of hair is constructed of large horny cells of varying thickness, which requires considerable force or pressure to damage. Hairs torn out by violence, especially with blunt instruments, are frequently found indented or lacerated. The bulb is also usually torn out with the shaft. The fact, however, that hair is found with its bulb intact is not conclusive proof that it was removed by violence, for numerous instances occur in which the hair falls out by natural process or disease.

Of all legal problems submitted to the microscope for solution, none has excited more interest, more painstaking original study, or more animated discussion than the determination and differential diagnosis of blood in criminal cases. Much of the literature on the subject, writ-

ten but a score of years since, is now of little value, and tends to confuse rather than enlighten one seeking to obtain reliable information.

Not many years ago it was claimed by some that human blood could be distinguished from that of all animals by hæmin crystals, and experts have so testified. This is now used only as a corroborative test in determining the substance to be blood. The physical appearance of a blood stain varies with its age and the material upon which it is found. Blood which has dried upon a polished or smooth surface, such as steel, glass, varnished wood, and such textile fabrics as silk or satins, rapidly assumes a dark brown color. When it happens that the stains are on mahogany or walnut furniture, they are sometimes very difficult to detect by daylight, though easily distinguished by the dim reflected light of a candle. On white pine and other soft woods it retains its bright red appearance for a considerable period.

The first step in the examination of a suspected stain is to ascertain whether it is blood or not; and if blood, next to determine, if possible, its source. These two problems can best be solved by aid of the microscope and micro-spectroscope. For the purpose of diagnosing the kind of blood, the microscope alone is available. The prevailing opinion among experts is that the finding of corpuscles is the only reliable evidence which should be admitted in criminal cases. Blood corpuscles are not liable to be confounded with any other known object by a person familiar with their appearance, yet careless mistakes have occurred. In Ohio I was once called upon to make an examination of a stain for the purpose of corroborating evidence already introduced to the effect that it was blood. All ordinary methods failed to reveal blood corpuscles, and other tests proved conclusively that it was another substance. On examining the slides prepared by the witness who had previously testified with his own instrument, I was surprised to find that what he had mistaken for blood corpuscles were nothing but spots left from condensed moisture on the lower lens of his eyepiece, he never having had the object itself in focus during his investigation. Such a blunder could not happen to one familiar with microscopical manipulation, as a mere turning of the eye-piece, which is generally done from habit, would have exposed the error.

The red corpuscle of human blood is a small, circular, non-nucleated, biconcave disc. The same form and appearance exist in most of the mammalia, the only means of distinguishing between the two being their difference in size. The red corpuscle in man averages about $\frac{1}{3200}$ of an inch in diameter. Race, habit, and environment seem to have no effect on the size or appearance of these discs. The late Dr. J. G. Richardson, of Philadelphia, during the Centennial Exhibition held in that city in 1876, examined and measured one hundred corpuscles from each of fourteen persons of different nationalities, and found their average diameter to be $\frac{1}{324}$ of an inch. Selected corpuscles may measure more and others less, and for this reason it is impossible to determine with absolute certainty human blood from that of some animals.

Unfortunately, in the dog, one of our most common domestic pets, the corpuscles so closely resemble those of man that it is difficult to distinguish between them. Out of two hundred corpuscles from the blood of a man and an equal number from a dog, Dr. J. P. Treadwell

found that of those measuring $\frac{1}{3200}$ of an inch, forty-six were from the man and six from the dog; of those measuring $\frac{1}{3300}$ of an inch, thirty-seven were from the man and seventeen from the dog; of those measuring $\frac{1}{3400}$ of an inch, fourteen were from the man and twenty-three from the dog. It will thus be seen that, although the average human blood corpuscle is slightly larger than that of a dog, the variations in size overlap in measurement so as to make it unsafe to express a positive opinion, where the question is confined to that of human or dog's blood. The blood from the guinea pig is still more difficult to determine in comparison with that of man.

From careful measurements of the red corpuscles in a given specimen, if found to average the same as those in man, a positive opinion may be expressed that the blood did not come from the sheep, ox, horse, pig, or goat; the corpuscles in these animals being so much smaller as to render the distinction easy.

In the famous Hayden trial held in New Haven in 1879, the late Col. J. G. Woodward, M. D., when testifying on the question of blood stains, stated that in measuring twenty corpuscles from one dog, forty from another, and fifty from a third, he found their diameters greater than the recognized average in human blood. On cross-examination by the State he, however, admitted that he had selected only the largest corpuscles for measurement. Subsequently, Dr. Woodward continued his investigations and published the measurements made of red corpuscles in dog's blood, selecting, as in the Hayden trial, only the largest. This unfortunately renders his data valueless for reference as to averages.

The blood corpuscles of all birds and reptiles are elliptical in shape and nucleated. This distinguishes them at once from the blood of a man without recourse to micrometry.

Numerous cases have been recorded where blood stains have been found on clubs alleged to have been used in murderous assaults, where it was claimed as a defence that the stick had been used for killing pigeons or chickens, and where the microscope demonstrated beyond the question of a doubt that the blood could not have come from such source.

An interesting case in my own experience is worth relating in this connection: Two winters ago in the far northwest, a merchant, prominent in the community in which he resided, left his home one evening for the ostensible purpose of visiting his store to transact some unfinished business. Not returning home when expected, his friends became alarmed and went to look for him. On reaching his store they were startled to see everything in confusion; furniture broken and strewn about the office; the safe door open; money drawer on the floor and empty, save for a few small coin; blood spattered here and there, and everything indicating a severe struggle, murder, and robbery. Spatters of blood were traced outside into the deep snow which covered the ground; foot-steps were crowded here and there, and the trail bore indications of a bleeding body having been dragged to the river not far distant, and a hole large enough to admit it chopped through the ice to the swift current below. It would be hard to conceive a stronger case of circumstantial evidence.

The man had a large sum of insurance on his life, and a prompt investigation by the insurance companies solved the mystery. A micro-

scopical examination of the blood showed that it could not have been that of a man, for the corpuscles were elliptical in shape. A few days later the supposed deceased was captured and arrested in a city about five hundred miles distant from the scene of his disappearance. He confessed to having concocted and carried out the plot unaided; that the blood was spattered about by cutting off the heads of two chickens, which were then tied to a board and dragged through the snow to the river, where they were pushed into the hole previously cut through the ice.

A witness is sometimes asked to give his opinion as to the probable age of a blood stain. It is generally easy to recognize a fresh specimen, though in stains but a few days old the physical appearance is frequently the same as those of months or years standing. The question of solubility has been carefully investigated for the purpose of throwing additional light on the subject. In a stain which has been dried but a few hours the blood corpuscles are more easily restored to their original state than in an old one, but the information thus derived is not always to be depended upon. The most trustworthy information to be obtained on this subject is by ascertaining the chemical changes which have taken place in the coloring matter; *i. e.*, whether it is in the form of hæmoglobin, methemoglobin, or hæmatin. By this method one may be able to approximate the age of a given stain within certain limits, but the greatest possible caution should be used in expressing an unqualified opinion derived from any source within our present knowledge.

One of the unfortunate conditions of present scientific literature is the different systems and unreliable standards which have been taken as a basis of measurement. Most of our modern scientists have adopted the decimal or French metric system, though a few still adhere to the English inch. In our country the English system is in common use by the masses. In the field of forensic microscopy it is necessary, therefore, that all measurements should be taken and expressed in fractions of an inch. Although it is impossible for the average juror, with his peculiar qualifications, to comprehend the fraction $\frac{1}{32000}$ of an inch, yet it sounds familiar, while to express the same measurement in the terms mikron or millimetre would cause confusion and convey no idea of the size thus expressed.

A centimetre scale, ruled upon a polished metal surface by the United States Bureau of Weights and Measures for this Society, was adopted as its standard of microscopic measurements, after a long series of recorded investigations, requiring months of careful observation to determine its errors. Thus the Society has rendered available a standard of known value which may be used within certain restrictions by scientists throughout the country for the purpose of ascertaining, by comparison, the deviations of their own micrometers from the true measure. In making corrections of micrometers ruled in the fractions of an inch it is still necessary to compare them with one of the very few standards in this country, and these difficult of access, or to make the necessary mathematical deductions required in a comparison with the standard centimetre referred to. One of the most convenient and accurate methods in recording microscopical observations, necessary not only in legal but in all other cases, is by photo-micrography. Though photographic prints are rarely admitted in evidence, they may sometimes be used ad-

vantageously for the purpose of illustration and explanation. Occasionally, original negatives are accepted in evidence, apparently under the general but mistaken belief that they could not be materially altered without more or less marring of the plate in such a manner as would render the change obvious to a casual observer.

Of late years much has been said in favor of cheap and simple microscopes, and the large complicated instruments have been severely condemned. One of the strong points in favor of the continental instruments is their simplicity. Nevertheless, the fact remains that the fewer accessories with which a microscope is provided, and therefore the simpler its construction, the more limited is its field of usefulness. Certainly in the department of legal microscopy the most perfect instruments and appliances known are a necessity if the work is to be properly executed.

The microscope itself, where only one is employed, should have all the requisite scales, and a mechanical stage provided with index for finding objects is a necessity. The cobweb eye-piece micrometer should be provided not only with the usual index and lines for measuring but also a graduated scale for determining the angles of crystals. Polarizing apparatus with selenites is frequently required. A spectroscopic attachment is also essential. Where possible, it is more convenient to use different instruments for certain processes of an examination. Such, for example, as the inverted microscope used in the chemical analyses already referred to. Not only should a complete photomicrographic apparatus be accessible, but also cameras and lenses for ordinary photographing and copying, together with a fully-equipped dark room for the development and treatment of plates.

Thus equipped, and with the requisite skill, the modern microscopist may become a true *amicus curiæ* in the best sense of that much-abused term. It is true that an industrious and exhaustive search by all the means at our command may sometimes produce only negative results, yet, in other instances, there will be revelations which shall change the whole theory of a plea in civil actions, while, in criminal causes, they may become a terror to the guilty or a joy to the innocent. Much is illusive in all methods of scientific research, yet it has been found that microscopy can sometimes

"Hold the eel of science by the tail"

when every other method of investigation has wholly failed. Especially is this true of forensic microscopy, and the time has fully come when counsel and client, courts and juries, must and will give heed to its disclosures.

Slides Received.

We return thanks to the donor for the following interesting slide:
Native silver, from "Queen Bee" mine, opaque. This is a beautiful slide both in object and finish. A $\frac{3}{4}$ or 1-inch objective and a two-inch ocular shows it best. Prepared by W. N. Sherman, M. D., Kingman, Ariz.

Mr. C. L. Whittle is preparing an account of the results of microscopic observation on the contact phenomena of trap and sandstone near Meriden, Conn. The Museum of Comparative Zoölogy at Cambridge has published a bulletin on the geological aspect of the faults in the triassic formation at that point.

BIOLOGICAL NOTES.*

Mildew upon Cucumbers.—Prof. B. D. Halsted reports in the *Botanical Gazette* finding a species of *Peronospora* upon the leaves of cucumber vines bearing fruit. The species is not the same as that found upon another species of cucurbitaceæ. He suggests the importance of being on the lookout for this destructive disease. Should it be found to attack squashes and melons as well, the danger would be more serious. It may be hoped that since this species is not the same as is found on *Sicyos angulatus* the new species may not attack the other cultivated cucurbitaceæ.

—o—

Peculiar conjugation of Spirogyra.—Mr. C. B. Atwell, of Evanston, Ill., in the same number, reports a peculiar phase of conjugation of *Spirogyra longata* in which the protoplasm of one cell conjugates with two adjacent cells of another filament, resulting in what he calls a "phase of polygamy." The zygospores thus formed are of unequal size. The two cases of such conjugation figured are from two adjacent cells of one filament with long cells to four adjacent cells of a filament with much shorter cells. The conjugating processes from the two pairs of short cells are in contiguous ends of cells. It is known that some species of *spirogyra* occasionally show the conjugation of two adjacent cells in the same filament. May not this be an instance bearing relation to ordinary monœcious and the normal mode of conjugation? If the two processes from adjacent cells had touched one another they would perhaps have formed monœcious union. This suggests the interesting question which, so far as we know, has not yet been answered, What determines the location of the conjugating cells? It is very rare that a process does not find a mate to meet it. Such an instance as this may indicate the fortuity of this meeting.

—o—

Water Analysis.—Dr. Charles Smart, U. S. A., contributes to the *Sanitarian* a valuable paper upon this subject, in which he treats in his careful and able style the various problems which enter into any really valuable test of water that is to be used for drinking purposes. The discussion of the methods of determining the presence of albuminoid matter, and particularly the determination of urea, is made practical by the citation of instances in which the reliability of the results is proved in subsequent revelations of sewer contamination. The methods of microscopical examination are also well represented and emphasized, and the bearing of the presence of various forms of organic matter upon the purity of the water is discussed. It seems to us, however, that Dr. Smart has not stated the importance of this part of the analysis with sufficient emphasis for the instruction of those who suppose that the chemical tests are the more critical and important. For all questions of general purity and ordinary contamination of drinking water we must of course rely upon chemical analysis, but there are certainly instances in which these tests reveal such slight impurities that the chemist would not be warranted in pronouncing the water even dangerous when the presence of small numbers of disease germs, which only a careful ex-

* This Department is conducted by Prof. J. H. PILLSBURY.

amination with the microscope by an expert would discover, renders its use terribly hazardous. While employed by the Board of Health of the city of Springfield, Mass., some years since, to examine samples of water which were considered suspicious, a quantity of water, of which we knew nothing at the time save the sample number, was examined, and revealed so small an amount of impurities when subjected to chemical tests that we should not have condemned it for use. On examining it with the microscope, however, we found a small quantity of sedimentary particles of organic matter, about which swarms of suspicious bacteria were moving. As this was before the introduction of culture tests in connection with water examination, we carried the examination no further, but reported the water as suspicious, and advised the prohibition of its use. A few days later we learned from the Health Office that five cases of typhoid fever had occurred among those using the water. The use of the water was discontinued, and all trouble ceased. Other cases of a similar but less marked nature came to our notice, indicating with clearness the importance of critical microscopic examination of all waters presented for analysis.

The presence of even small quantities of nitrogenous material, and especially of urea, indicating the presence of sewage even in small proportions, reveals the possibility of sudden and unannounced hazard, and so reckless is the use of well-water not only in country villages, but even in small cities, that only the most rigid restrictions can avoid the most terrible results. We have only to recall the wells that any one who has lived in a village or small city can remember in order to realize how little hard sense and what a fearful amount of ignorance and indifference prevails. What seems to us a marvel is that so few cases of serious disease occur when so many are utterly reckless in the use of water from wells which must inevitably catch large amounts of surface drainage, if not of more serious drainage from cess-pools.

MEDICAL MICROSCOPY.*

A Cure for Elephantiasis.—It is now generally held that elephantiasis has for its exciting cause, in many cases at least, a parasite, *Filaria sanguinis hominis*. Dr. Thomas, of Ceylon, thinks he has found its proper parasiticide in sulphide of calcium administered internally. For elephantiasis in the adult he gives a grain of the drug twice a day after eating for a month, then increases the dose to a grain and a half, and if the drug is well borne, to two grains twice daily. No bad symptoms ensued. Cases of less than six months' standing were cured in one or two months.



How to Look for Tubercle Bacilli in Sputum.†—Ehrlich's method, somewhat modified, is as follows:

Press a little of the suspected sputum between two cover-glasses so as to get a very thin layer. Dry the cover-glasses separately, either by

* This Department is conducted by F. BLANCHARD, M. D.

† Translated from Kunze's *Grundriss der Praktischen Medicin*. Appendix to Von Ziemssen on "Pulmonary Tuberculosis."

moving them through the air or holding over a flame, or by passing a few times through the flame. This fixes and dries the preparation. Place some drops of aniline oil in a reagent glass half filled with water, shake and filter into a watch-glass. Add several drops of an alcoholic solution of fuchsin or methyl violet to the contents of the watch-glass till they are markedly colored. Warm this mixture till it begins to steam. Place the cover-glass with the dried sputum face downwards on the warm liquid and let it float from three to five minutes. Remove and rinse in alcohol, acidulated with nitric or hydrochloric acid, until very slight traces of color remain; then rinse in ordinary alcohol (70 or 80 per cent.) Dry the cover-glass as before by holding above a flame, clean it where necessary, add a little pure glycerine, and set under the microscope. An enlargement of 400 diameters will show the bacilli if present.—*College and Clinical Record, July, 1889.*

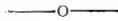

Early Diagnosis of Morbid Growths.—It is often desirable to make a microscopic examination of a tumor before its removal. For excising a portion of the tumor sufficient for this purpose, Dr. J. Collins Warren uses a small canula (diameter 2 to 5 millimetres) sharpened at one end. The instrument is used by gently rotating it between the fingers. When it has penetrated the tumor to the desired depth, it is withdrawn a short distance and then entered obliquely, so as to cut off the column of tissue. The instrument has been used satisfactorily in over one hundred cases.

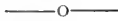

The "Corn-stalk Disease" in Cattle.—In the August number of the *Buffalo Med. and Surg. Jour.*, Dr. Frank S. Billings continues his record of observations upon the micro-organisms found in cattle affected with this disease.

Drawings of this disease germ, in its different stages of development, are given. It is described as "intermediate between micrococci and bacilli," belonging in the same group with the germ of the swine-plague and the Southern cattle-plague. Another paper will appear in the Sept. number, when, perhaps, a fuller notice will be given.

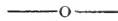

The Relation of the Tubercle Bacillus to the Early Diagnosis and Prognosis of Phthisis.—For sound common sense we commend Dr. J. W. Roosevelt's paper on this topic (*Jour. Am. Med. Assn.*)

His conclusions are as follows:

1. The bacillus tuberculosis is of great positive, but little negative, value in diagnosis.
2. In prognosis the bacillus is of little value.
3. Finding the bacillus sometimes renders a diagnosis certain which would otherwise be doubtful.

He protests against the so-called antiseptic treatment of phthisis since no safe specific bacillary poison has yet been discovered, and it is much easier to kill the complex body-cell than the more simply organized bacillus.

BACTERIOLOGY.*

The Basic Aniline Colors.†—These colors are soluble in water, and for the most part in one or all of the decolorizing agents. In use, a weak, watery solution colors at first the intercellular substance and the cell body, while the nuclei remain unstained. Through the subsequent treatment with alcohol, glycerine, or acetic acid, an inversion of the staining takes place, by which the elements previously colored become colorless while the previously colorless nuclei are stained. In the use of the stronger solutions the staining follows (without any discernible inversion) directly and quickly; and, in general, its intensity is in proportion to the concentration of the solution. In a quite concentrated watery solution overstaining may occur, which can be reduced to the proper degree by subsequent decolorization.

If the dyes are dissolved in the decolorizing agents—such as absolute alcohol, acetic acid, or thick glycerine—they stain slightly or not at all. Instead of using some decolorizing agent subsequently to reduce the intensity of the staining to a proper degree in preparations which have been overstained in watery solutions, in many cases a solution of the dye-stuff in a mixture of water with alcohol (Herrmann), glycerine (Schaefer), or acetic acid (Ehrlich), may be used.

The basic aniline-dyes are used in the following solutions:

1. Concentrated watery solutions. These are either used directly or after dilution to the desired degree with distilled water. The solutions are prepared with distilled water (which has been previously boiled), so that an excess of the coloring-matter remains undissolved. They must *always be filtered* before using. Only a small quantity of these watery solutions should be made at a time.

2. Concentrated alcoholic solutions. The solution of an excess of the coloring material is brought about in the best way by absolute alcohol, or, in want of this, by the officinal 90 per cent. spirit of the Pharmacopœia.

In general, one can calculate about 20 to 25 grammes of the dye-stuff to 100 grammes of the spirit or alcohol. These solutions are kept prepared, and are not used directly for staining, but are mixed with a certain amount of distilled or aniline water. In place of concentrated watery solutions the alcoholic solutions can be used if five or six drops are added to a small watch-glass of distilled water. This mixture is often designated as the dilute alcoholic solution.

From the watery or alcoholic solutions of the basic aniline colors the various staining fluids are prepared. The preparations that are more commonly employed in staining bacteria are *Koch-Ehrlich's* solution of methyl-violet or fuchsin (described in the April number of this *Journal*), and the alkaline methylene blue solution.

—o—

Alkaline Methylene Blue.—The alkaline preparation of methylene blue is undoubtedly the staining fluid most universally employed in staining micro-organisms. With it bacteria are very satisfactorily stained either in cover-glass preparations made directly from animal tissues.

* Conducted by V. A. MOORE.

† Hueppe. Die Methoden der Bakterien-Forschung, p. 52.

cultures, or other germ containing material, or in sections of animal tissues that have previously been hardened in alcohol.

There are two preparations, the weak (Koch's) and the strong (Löffler's). The weak solution is prepared as follows: Concentrated alcoholic solution of methylene blue, 1 c.cm., 10% solution of potassium hydrate, 2 c.cm., distilled water, 200 c.cm.

The strong solution is the one to which special reference is made. It is prepared by taking concentrated alcoholic solution of methylene blue, 30 c.cm., 1% solution of potassium hydrate, 1 c.cm., distilled water, 99 c.cm.

Cover-glass preparations are sufficiently stained in this solution in from 1 to 5 minutes, and sections in from 3 to 20 minutes, according to the tissue. Epithelial cells, nuclei, granules of granular corpuscles and white blood corpuscles are stained as readily as the germs themselves, while connective tissue fibres are very slightly stained, and the red blood corpuscles are not stained at all with this agent; thus, in a section of stomach or intestine stained with it the mucous membrane, together with the bacteria, will be stained a deep blue color, while the sub-mucosa and muscular coat will be very feebly tinted.

If the preparations should, at any time, be overstained, they can be readily decolorized by a momentary immersion in a weak ($\frac{1}{2}$ of 1%) solution of acetic acid. Methylene blue is much less liable to over-stain preparations than other basic aniline dyes, and it is consequently to be used if, for any reason, decolorizing agents should not be employed.

The technique in the use of this stain is very simple, and differs in no way from that of ordinary staining fluids. After staining, sections should be washed in weak alcohol, then transferred to stronger, and, finally, cleared in turpentine, xylol, or cedar oil, and mounted in balsam. Cover-glass preparations are washed in water, and allowed to dry in the air until completely desiccated, when they are also ready for mounting.

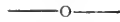

Gram's Method of Staining.—Among the different staining methods employed in studying micro-organisms the one introduced by Dr. Gram is very useful. In his method the bacteria are stained a deep blue while the surrounding tissue is colorless. The technique of the method is, according to Friedländer,* as follows:

The stain employed is Ehrlich's solution of gentian or methyl-violet in aniline water. This is prepared by shaking pulverized gentian or methyl-violet with aniline water and allowing it to stand for 24 hours, when it is filtered and the clear filtrate is then ready for use. The same result will be obtained if 5 cc. of a saturated alcoholic solution of the stain be added to 100 c.cm. of aniline water.

The sections, previously hardened in alcohol, are placed in a watch-glass containing 2 to 3 c.cm. of the staining fluid and allowed to remain in it for from 3 to 5 minutes. They are then transferred, by means of a section lifter, to a second watch-glass containing a solution of iodine in iodide of potassium (iodine, 1 gram, iodide of potassium, 2 grams, distilled water, 300 c.cm. The iodide of potassium is dissolved in the water and the iodine added.) They are allowed to remain in this for

* *Microscopische Technik*, p. 49.

about 5 minutes when the sections will have a dark brown, almost black color. The sections are now transferred to a third watch-glass containing absolute alcohol, which will dissolve out the coloring matter from the tissues of the section. The time required for the discolorization varies from a few minutes to several hours, according to the thickness of the section and the intensity of the stain. The time may be shortened by transferring the sections to fresh alcohol when that in which it becomes highly colored. When the sections become colorless, or very nearly so, they are to be cleared in turpentine, cedar oil, or xylol, and mounted in balsam.

A very satisfactory double stain may be obtained by staining the sections in an aqueous solution of Bismarck brown after they have been decolorized in the alcohol. In this case it is better to transfer them from the absolute to 95 per cent. and then to 70 per cent. alcohol before transferring them to the staining solution. After the sections are stained in this solution they should be washed in weak alcohol, dehydrated in stronger spirits, and finally cleared and mounted as in the first case. By this method the bacteria will remain a dark blue, almost black color, while the surrounding tissue will be stained a yellowish-brown color. By this method one is able to determine whether the micro-organisms are within or without the cell nuclei; in fact, to determine their location within the tissue.

There are many bacteria that will not retain the blue stain when treated by this method. This fact renders the method of value in differentiating between certain micro-organisms.

Cover-glass preparations can be treated in the same manner as sections with equally as good results.

EDITORIAL.

Exchanges.—We have no idea of letting people use our columns for advertising, for subscribers' notices, nor for any other purpose, unless they deal squarely by their correspondents. Once in a great while some one says he has had correspondence about exchanges, has done his part and has failed to receive the slides agreed upon. Whenever any subscriber feels that he is being maltreated in this way, let him first state his grievance in a *registered* letter to the offending party. If that person receipts for the letter and fails to give satisfaction, then refer the correspondence and all facts to us. When the person offering to exchange is proven to us to be using our columns in order to get and not give slides, etc., we shall show him up to the world just as any other microscopic object needs to be treated, and make him pay dearly for his slides obtained under false representations. To simply drop his advertisement or notice is too tame. The microscopist is bound to use the scalpel, sunlight, and Abbe condenser on extremely minute specimens. *Verbum sap.*

—o—

Corrections.—Some rather annoying errors crept into the August number. On the cover, in the contents, correct folicle to follicle. On page 180 and page 187 correct lense to lens. On page 181 correct title of Prof. Tuckerman's article to *Erethizon dorsatus*, the common porcupine. On the same page circumvallate is misspelled twice. On page 190 change *Melacerta* to *Melicerta*.

MICROSCOPICAL SOCIETIES.

VERMONT MICROSCOPICAL ASSOCIATION.—C. SMITH BOYNTON,
M. D., *Secy.*

June 21, 1889.—The tremendous strides which microscopical science has taken the past few years has resulted in discoveries of the greatest possible good to the public. The truth of the germ theory—that disease and death are caused by micro-organisms—is dependent wholly upon microscopic investigation, and the best minds in the land are constantly working upon this great subject.

To encourage these workers and stimulate new discoveries a prize of \$250 for each discovery of a new disease germ will be given by the Wells & Richardson Co., the well-known chemists, and will be paid to the first discoverer of a new disease germ. The wonderful discovery by Prof. Koch of the cholera germ, as the cause of cholera, stimulated great research throughout the world, and it is believed this liberal prize, offered by a house of such standing, will greatly assist in the detection of micro-organisms that are the direct cause of disease and death. All who are interested in the subject and the conditions of this prize should write to the secretary of the Association at Burlington, Vt.

—o—
SAN FRANCISCO, CAL.—C. P. BATES, *Secy.*

June 26, 1889.—President Payzant occupied the chair, with a large attendance of members. Frank L. James, M. D., and Prof. H. M. Whelpley, of St. Louis, were present as visitors; also, M. R. Roberts, of San Francisco, and L. M. King, of Santa Rosa. The President announced the death of F. L. Howard.

Dr. James gave an interesting account of a phenomenal class of crystals produced from salicine by the extreme cold method as discovered by him several years ago, and exhibited with the polariscope a series of slides which were pronounced by all to be most beautiful. The process depends on bringing a saturated solution of salicine made with distilled water in contact with cold below the freezing point, and the explanation is, that the rapid congelation of the water interferes with the usual arrangement of the crystals, producing the wonderful series before alluded to, which are entirely unlike any forms resulting from crystallization at the ordinary temperature. The proper manner of making white zinc cement and permanent oxydized enamels for ringing slides formed a portion of his interesting address.

H. M. Whelpley, of the St. Louis Microscopical Club, addressed the Society on the subject of the microscope in its relation to pharmacy, pointing out the rapid progress being made in the detection of adulterations, and the interest manifested generally among pharmacutists in studying the character and acquiring a correct knowledge of the crude constituents of the *materia medica*.

Pond life was illustrated by numerous specimens of *Ceratium longicornis*, and the beautiful little organism, *Artemia salina*, or brine shrimp. Entomology was represented by prepared slides of the larva of several varieties of the Papilio family.

Professor Hanks presented for examination a venerable edition of a work on Pharmaceutics, published by Robert Lowell in 1661. Mr. Riedy donated a copy of Trembley's work on fresh water Polypes, an exceedingly rare and valuable book, published in 1744.

NOTICES OF BOOKS.

The Psychology of Attention. By Th. Ribot. Humboldt Publishing Co., 28 Lafayette Place. Paper, price 15 cents.

The same distinguished author has already enriched the literature of psychology with three very remarkable works on "The Diseases of the Will," "The Diseases of the Memory," and "The Diseases of Personality." Like them, the present work is a study of very recondite problems of psychology—the nature and workings of the mind of man—presented in language understandable by every intelligent reader. In the series to which it belongs are found illustrations of abnormal psychic states more striking than the "double personality" portrayed in "Dr. Jekyll and Mr. Hyde."

Chemical lecture notes taken from Prof. C. O. Curtman's lectures at the St. Louis College of Pharmacy. By H. M. Whelpley, Professor of Microscopy, etc. St. Louis, 1888. 12°, pp. 211.

This is a second edition in which are added notes on the metals, increasing the size about 70 pages. These notes were published primarily for pharmaceutical and medical students, but are very useful for reference to those who want an epitome of present knowledge on this subject. Like a dictionary, they contain an immense array of facts and would be about equally dry reading for a winter evening. The table of chemical elements is very valuable, the number of elements reported being 77, of which Germanium, discovered in 1886, is the latest. The illustrations are by Dr. Whelpley, the printing and binding accurate and neat. This hand-book makes a very desirable reference book for a druggist's laboratory. Dr. Whelpley is one of our leading authorities in microscopy.

Plato's Protagoras. By James A. Towle. 12°, 179 pp. Ginn & Co., Boston. (Price, \$1.25.)

The Protagoras is perhaps the liveliest of Plato's dialogues. In but few dialogues is the dramatic form so skilfully maintained without being overborne by the philosophical development. Throughout the entire dialogue the pictures of real life are vivaciously drawn. In the frequent changing of the scenes, and the repeated participation of the bystanders, the variety in the treatment of the theme is very marked.

Noticeable, too, is the number of vividly elaborated characters; the ever genial Socrates, eager for a contest, in which he readily downs his opponents, always holding the respect and admiration of the disdainful Protagoras. Prodicus, overloaded with synonymic wisdom. Hippias, imposing and pretentious. The tranquil Critias and the impetuous Alcibiades. An introduction containing the life of Protagoras and topics of special interest to the student are also included. At the back of the book an appendix, together with Greek and English indexes, is given. The lines of the text are numbered for easy reference, and at the foot of the text, occupying nearly half of the page, full and complete notes are given.

This volume belongs to the "College Series of Greek Authors." In appearance it makes a very neat and attractive book.

The Urine, The Common Poisons, and the Milk. By J. W. Holland, M. D. 3d ed. 84 pp. 33 figures. P. Blackiston, Son & Co., Philadelphia. (Price, \$1.)

We are glad to note that the syllabus is rapidly gaining ground in nearly all well-established schools and colleges. It has long been held by the best authorities on Biology, Chemistry, and Physics that the way to gain the greatest knowledge of any of these subjects is not by learning bookish theories but by practical analysis in the laboratory.

The text of the present syllabus is brief, and at the same time it contains all that is really necessary for the mastery of urinary analysis. There are three main divisions of study mapped out, namely: The Examination of Morbid Urine, the Examination for Common Poisons, and the Examination and Study of Milk. Each of these comprehends a score or more of topics. The plan of study is progressive, but at the same time the subjects are treated in a manner which enables the student to begin with either of the main divisions. The illustrations, many of which are of microscopic views, are a good feature of the book. Leaves are left blank for calculations, memoranda, and additional notes which the student may wish to preserve. The text is printed in two sizes of type; the more important matter is in larger type, for the convenience of those whose course of study is limited by lack of time, while for those students who wish to gain a more thorough knowledge, many explanations and quantitative processes are given in the smaller type. Every physician should find this a very useful compendium.—R. W. S.

SUBSCRIBERS' NOTICES.

[These notices will be given six insertions in this column at 25 cents per line or fraction thereof.
FOR EXCHANGE.—Slides of selected diatoms. D. B. WARD, Poughkeepsie, N. Y.

WANTED.—Unmounted microscopical material, also micrographic dictionary. Will exchange or buy. CHARLES VON EIFF, 124 Clinton Place, New York City.

WANTED.—A clean copy of Rev. William Smith's British Diatoms, and Schmidt's Atlas of the Diatomaceæ. JAMES B. SHEARER, Bay City, Mich.

OFFERED.—Diatomaceous Earth from Utah (Desert) for Histological Mounts. PROF. ORSON HOWARD, Salt Lake City, Utah.

CORRESPONDENCE invited with a view to the exchange of either mounted or unmounted Oribatida (British) for American species. E. BOSTOCK, Stone, Staffordshire.

TO EXCHANGE.—Native gold, silver, copper, lead, zinc, and other beautiful cabinet specimens, polished ornaments and sections of petrified wood—Chalcedony—and native turquoise, agate, amethyst, rubies, etc.; also Indian ornaments, curios, arrows, blankets, pottery, etc.; pelts of wild animals, species of native cactus, and a good second-hand "Burt's Solar Compass" complete. Any or all of the above are offered in exchange for new, or good second-hand, objectives, condensers, polarizers, stand, or other microscopical apparatus. W. N. SHERMAN, M. D., Kingman, Arizona.

OFFERED.—Zeiss' New Catalogue (in German) forwarded for 10 cents in stamps. F. J. EMMERICH & SONS, 43 Barclay St., New York City.

WANTED.—Any works on Microscopy not already in my Library. H. M. WHELPLEY, F. R. M. S., St. Louis, Mo.

WANTED.—(In exchange for slides.) "Microscopical Bulletin," Vol. I, No. 5, August, 1884. M. S. WIARD, New Britain, Conn.

Labels in exchange for slides. EUGENE PINCKNEY, Dixon, Ill.

First-class Histological Slides for other good mounts; Histological and Pathological material cut on shares. S. G. SHANKS, M. D., 547 Clinton Ave., Albany, N. Y.

OFFERED.—Griffith & Henfry Micrographic Dictionary to be sold; also Hogas Microscope. J. P. WINTINGHAM, 36 Pine St., N. Y.

WANTED.—A clean copy of Wollé's Fresh-Water Algae of the United States (2 vols.); also good second-hand Grunow Camera-Lucida, and a self-centering Turn-table. JOS. P. THOMPSON, P. O. Box 1383, Portland, Me.

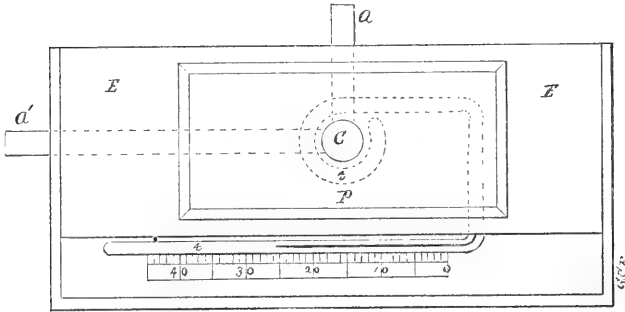
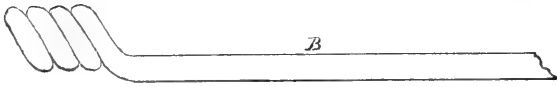

FIG. 1.

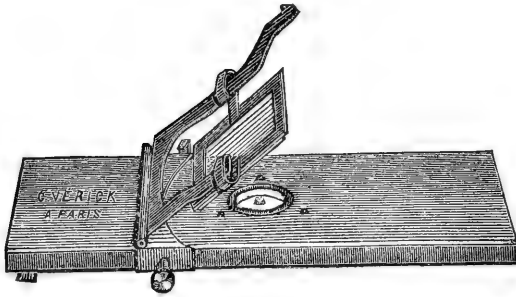

FIG. 3.

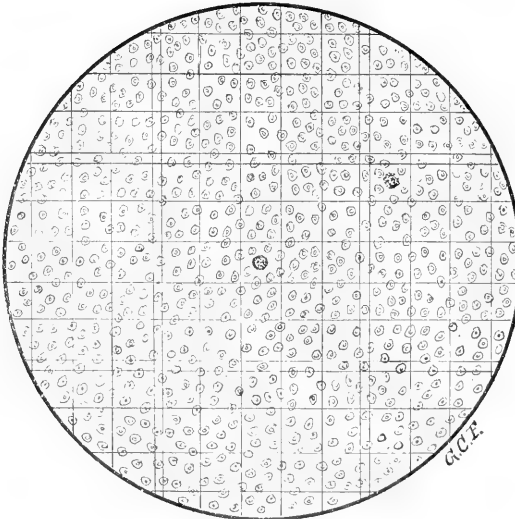

FIG. 4.

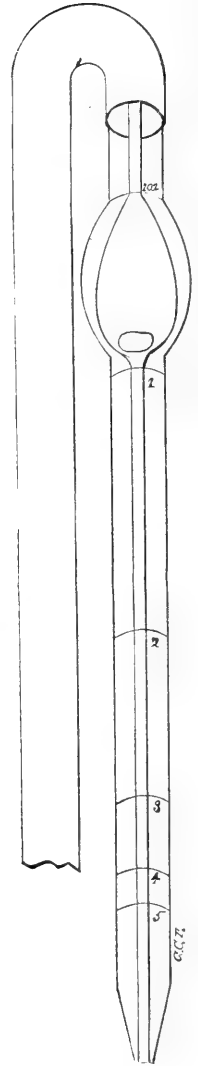

FIG. 2.

APPARATUS FOR EXAMINING BLOOD.

THE AMERICAN MONTHLY MICROSCOPICAL JOURNAL.

VOL. X.

OCTOBER, 1889.

No. 10.

All communications for this Journal, whether relating to business or to editorial matters, and all books, pamphlets, exchanges, etc., should be addressed to American Monthly Microscopical Journal, Box 630, Washington, D. C.

European subscriptions may be sent directly to the above address accompanied by International Postal Order for \$1.15 per annum, or they may be sent to Messrs. Trübner & Co., 57 Ludgate Hill, London, or to Mr. W. P. Collins, 157 Great Portland street, London, accompanied by the yearly price of five shillings.

Histological Technique of the Blood.

By GEORGE C. FREEBORN, M. D.,

INSTRUCTOR IN NORMAL HISTOLOGY IN THE COLLEGE OF PHYSICIANS AND SURGEONS, N. Y.

Fresh Blood.—To obtain human blood for examination, the finger is wrapped around in a spiral manner with a piece of string from its proximal to its distal end. This produces a congestion of the fingertip, and on making a slight puncture with a needle at the edge of the nail a drop of blood will flow out. This is wiped off and the new drop that appears is to be used. This is transferred quickly to the centre of a slide covered with a cover-glass and the edge of the cover painted around with a ring of vaseline or oil to prevent evaporation.

In animals (dog, cat, rabbit, etc.) the blood can be obtained from a slight puncture made in one of the veins of the ear; in the frog by cutting off the tip of one of the toes, or by opening up the thorax and cutting off the apex of the heart. The blood in the first method is always mixed with more or less lymph.

For studying the changes in the red cells, due to the concentration of the plasma by evaporation, the ring of vaseline or oil around the cover-glass is omitted. Then, on examination near the edge of the cover, the changes in the red cells will soon be seen.

The application of fluid reagents is best made by the method of irrigation. A bit of filter-paper is brought in contact with one edge of the cover-glass and a drop of the reagent with the edge on the opposite side. As the fluid is sucked up by the filter-paper the reagent runs in on the opposite side. Volatile reagents are applied in the following manner: Place a drop of the reagent in the bottom of a cell on a slide and invert a cover-glass containing a thin layer of blood over the cell.

EXPLANATION OF PLATE.

FIG. 1. Stricker's hot stage and gas chamber.

FIG. 2. Potain's mixer.

FIG. 3. Malassez's blood-cell counter.

FIG. 4. Field of Malassez's blood-cell counter.

For the application of gases a gas-chamber must be employed. Such a piece of apparatus is shown in Fig. 1. This is known as Stricker's hot-stage and gas-chamber. It consists of a rectangular piece of ebonite, *e e*, fixed to a brass plate that rests on the stage of the microscope. On the upper surface of the ebonite is a brass plate, *P*, with an opening in its centre, *c*, leading into a brass tube closed below with a piece of glass. A cover-glass, upon which a thin layer of blood has been spread, is inverted over the opening, *c*. The tube, *a*, is connected with the gas generator by a rubber tube, upon which a spring clip is placed for regulating the flow of the gas. The gas enters the chamber, *c*, through this tube and escapes through the tube, *a*.

In using this apparatus as a warm-stage, the copper wire, *B*, is placed on the tube, *a'*. Heat is applied to the wire by means of a Bunsen's burner or alcohol lamp. The temperature of plate *P*, upon which the slide is placed, is regulated by the distance of the flame from the stage. The thermometer, *t*, indicates the temperature.

The white cells can be studied in the fresh condition in the same manner as described above for the red cells. In studying the amœboid movements of the white cells of the mammalia it is necessary that the temperature of the preparation should be kept at the body temperature of the animal [37 C.], while in the cold-blooded animals the movements take place at the ordinary room temperature. In order to keep the preparation of the mammalian blood at the proper temperature, the warm-stage, Fig. 1, is used. The preparation is made in the same manner as for studying fresh blood. As the movements of the cells is very slow it is difficult to perceive the changes in form, but if an active cell is selected and sketches made of it at intervals of two minutes, one will soon see that its form as well as its position has changed.

Blood Placques.—Various solutions are recommended for studying the blood plaques in the fresh state. Bizzozero uses a $\frac{3}{4}\%$ solution of sodium chloride, to which one part of methyl-violet is added for every 5,000 parts of salt solution; Hayem uses his modification of Pacini's fluid; Zimmermann, a solution of sodium sulphate; Afanassiew, normal salt solution to which 0.5% of dried pepsin and 1 to 1,000 of methyl-violet are added, with a few drops of carbolic acid to prevent decomposition; Osler, Pacini's fluid or a 1% solution of osmic acid. In all cases the blood must pass directly into the preserving fluid.

The method of examination is as follows: A drop of the fluid is placed upon the finger tip, and the latter pricked with a clean needle, so that a drop of blood passes into the fluid, which is then placed on a slide and covered. The drop of blood must be small, and must be quickly disseminated through the fluid with the point of the needle. The preparation is to be examined with a power of about 500.

For studying the plaques in the circulation, the mesentery or omentum of a small animal—young rabbit, white rat, or guinea pig—may be used. On account of the rapidity of the circulation in the larger vessels, it is difficult to make out the plaques; but if a small transparent vessel, in which the current is moderately slow, be selected, then the plaques will be seen in the still layer mingled with the white cells. If the current becomes very slow, the plaques have a tendency to collect along the periphery with the white cells.

The plaques may also be studied in the vessels of a recently-killed

animal. A new-born rat is killed by breaking up the medulla, and thin pieces of the mucoid connective tissue are removed and spread out in a thin layer on a slide, a few drops of normal salt solution added, and then covered.

Permanent preparations of the plaques may be made as follows: A thin layer of blood is spread quickly on a cover-glass, which is then dropped in a one per cent. solution of osmic acid. Kemp places a drop of blood on a cover-glass, moves it about rapidly, and then washes off the blood with salt solution. The plaques adhere to the cover, the cells being washed away. The cover is then placed in a 1% solution of osmic acid. After the covers have been removed from the osmic acid they are allowed to dry in the air, and then mounted by inverting them on a drop of balsam on a slide. For staining the plaques, dilute solutions of methyl-violet, gentian-violet, or fuchsin may be used. On a cover-glass preparation are placed a few drops of the staining solution, which is allowed to remain for 2 to 5 minutes, then it is gently washed off with distilled water. The cover is then dried and mounted as above. The plaques, as well as the white cells, are stained.

Fibrin.—A large drop of blood is placed on a slide and covered. It is then placed under a bell-jar with a dish of water, thus forming a moist chamber. At the end of an hour the slide is removed and placed in a dish of water; the cover-glass is carefully removed under water, taking care not to disturb the film of blood. The slide is allowed to remain in the water for several minutes until the coloring matter is dissolved out. Then remove the slide, absorb the surplus water with filter-paper, taking care not to disturb the film of fibrin. Then add a few drops of fuchsin [sat. alcoholic sol. of fuchsin 1 part, alcohol 3 parts, water 10 parts], and put on a cover-glass. This fluid stains red the filaments of fibrin and the nuclei of any of the white cells that may remain in the clot, at the same time rendering any of the red cells colorless. This preparation cannot be preserved permanently.

Blood Crystals.—Hæmoglobin crystallizes very slowly from human blood, while in some of the lower animals, especially the rodents, the crystals form rapidly.

Hoppe-Seyler recommends the following process for obtaining hæmoglobin crystals from blood: Defibrinated blood is mixed with 10 volumes of a 10 per cent. solution of sodium chloride and allowed to stand two days. Then the upper layer of fluid is drawn off with a pipette and the thick layer of cells washed by decantation. They are then shaken up with an equal volume of ether, which dissolves the cells. The ether is then removed and the lake-colored fluid filtered. The filtrate is shaken up with $\frac{1}{4}$ its volume of alcohol at 0° C., and the mixture allowed to stand two to three days in the cold, when numerous crystals of hæmoglobin will have separated; these are filtered out, dried between filter-paper, and mounted in thick balsam.

Von Stein places a thin layer of defibrinated blood on a slide, and when it begins to dry at the edges covers it with a drop of thick balsam. As long as the odor of balsam remains the preparation remains uncovered; when this has disappeared the balsam is removed with a knife, wet with ether, turpentine, or oil of cloves; a cover-glass is then put on, and a ring of balsam or asphalt painted around its edge. Von Stein has kept slides prepared in this manner for ten years.

Crystals of hæmin are prepared from dried blood. A small bit of dried blood is placed on a slide, two or three drops of hydric acetate and a few crystals of sodium chloride added and the slide heated over a flame until bubbles of gas are given off. Allow the slide to cool, when the crystal of hæmin will form. The excess of the fluid is then carefully absorbed with filter-paper, a drop of glycerine added and a cover-glass put on and cemented with asphalt.

Hæmatoidin crystals are found in old blood extravasations. A bit of an old apoplectic clot, an extravasation in the subcutaneous tissue, or the clot from the *corpus luteum* is teased up in a drop of glycerine, covered and cemented.

Permanent Preparations.—The two principal reagents that are now used for the permanent preservation of blood cells are mercuric chloride and osmic acid. The action of these reagents is not absolutely perfect; more or less of the red cells show slight changes.

Mercuric chloride is used in the form of Pacini's* or Hayem's† solutions. A drop of the solution is placed on the finger-tip and the latter pricked through; the drop of fluid and the drop of blood that flows out is disseminated through the preservative with the point of the needle, transferred to a slide, covered, and the cover immediately cemented. Or 1 to 3 drops of blood are allowed to drop into a small glass cylinder containing from 10 to 15 c.c. of the preservative. The cylinder is then shaken so as to disseminate the cells through the fluid, and then allowed to stand for 12 hours to allow the cells to settle. The cells are then removed with a pipette and mounted in a drop of the preserving fluid. The latter method is best for the blood of animals.

Osmic acid is used in the strength of 1%. The method of procedure is the same as the second method described above. After the cells have been fixed with the osmic acid [after remaining in the acid for 12 hours] the osmic acid solution is poured off and the cells washed several times with distilled water, and then hardened in 80% alcohol. They can be preserved in this for any length of time, a few being taken up with a pipette and mounted in glycerine.

Gage's Method for Amphibian Blood.—Three to four drops of fresh blood are allowed to fall into 10 c.c. of normal salt solution, contained in a tall glass cylinder. Agitate thoroughly, and mix with 100 c.c. of a saturated aqueous solution of picric acid with constant stirring. Allow the blood cells to settle, and pour off as much of the supernatant fluid as possible, add an equal amount of normal salt solution, continue this until the salt solution is only slightly tinged yellow. Then add 10 c.c. of a mixture of 5 parts of carmine and 95 parts of picro-carmine for staining. This will require about 15 hours. Then pour off as much of the staining fluid as possible, and add 10 c.c. of acid glycerine [glycerine 100 c.c., hydric acetate or formic acid 1 c.c.] The cells may be kept in this mixture indefinitely. For mounting, remove a drop with a pipette, place it on a slide cover, and cement the cover immediately.

* Pacini's Fluids. A. Mercuric chloride, 1 gm., sodium chloride, 4 gms., distilled water, 200 c.c. B. Mercuric chloride, 1 gm., sodium chloride, 2 gms., distilled water, 200 c.c. The solution A is for the blood of warm-blooded animals, B for the cold-blooded.

† Hayem's Fluids. A. Distilled water, 200 c.c., sodium chloride, 1 gm., sodium sulphate, 5 gms., mercuric chloride, 0.5 gms. B. Distilled water, 200 c.c., sodium chloride, 1 gm., sodium sulphate, 5 gms., mercuric chloride, 0.5 gms., glycerine [28 B.], 10 gms.

Biondi's Method.—I have already described this method in vol. ix. p. 112, of this *Journal*.

Cover-glass Preparations.—The blood should be spread on a cover-glass in as thin a layer as possible. To do this, place a clean cover-glass on a piece of filter-paper on the table, then put a small drop of blood on the cover near one edge. Then bring the edge of a slide in contact with the drop of blood, and with slight pressure draw the slide quickly across the cover-glass. By this means the blood is spread out in such a thin layer that it dries before the cells change their form. Preparations made in this manner, as soon as they are thoroughly dry, may be mounted in balsam by inverting the cover-glass on a drop of the same placed in the centre of a slide, and allowing the cover to settle by its own weight.

If the above preparations are to be submitted to the action of any aqueous reagent, they must be fixed or the film will be washed off by the subsequent manipulations. The fixing coagulates the albumen and makes the film very adherent. The fixing is done by submitting the cover-glass preparation to the action of osmic acid. It is immersed in a 1% solution, and allowed to remain for 5 to 10 minutes, or it may be inverted over the mouth of a bottle containing a solution of osmic acid. The preparations are then washed well in water and dried in the air. In place of osmic acid, dilute solutions of chromic acid, mercuric chloride, or alcohol may be used.

Staining.—Cover-glass preparations that have been fixed may be stained with any of the usual staining reagents used in dilute solutions. A few drops of the stain are placed on the prepared side of the cover and allowed to act for about one quarter of an hour. The stain is then washed off with water, the cover-glass allowed to dry in the air, and then it is mounted in balsam.

For the white cells and nucleated red cells, double staining gives beautiful pictures. The cover-glass preparation is first stained with a nuclei stain and then with a contrast stain.

Blood-cell Counting.—To collect the blood for counting, a puncture is made in the end of the finger and the required amount of blood sucked up into the mixer (Fig. 2). The mixer is so constructed that the capillary tube is exactly one one-hundredth the capacity of the bulb. Before counting the blood is always diluted in a known proportion. The dilutions used are generally 1 to 100 or 1 to 200. For diluting the blood a $\frac{3}{4}$ % solution of sodium chloride is used by Thoma; Malassez uses a mixture of 1 part of a solution of gum arabic, of the sp. gr. 1.020, and 2 parts of a solution of sodium sulphate and sodium chloride, in equal parts, and having a sp. gr. of 1.020. The method of dilution is as follows: The blood is sucked up into the mixer to a fixed mark. The point of the mixer is then wiped, and it is then filled to the mark (101) with the dilutant. The end of the mixer is then closed with the finger and the mixer carefully shaken, the glass bead in the bulb aiding in distributing the cells. The fluid in the capillary tube is allowed to run out and only that portion of the mixture contained in the bulb is used for the counting.

If the mixer has been filled to the mark 1 with blood and then afterwards the dilutant added until the contents reach the mark 101, the bulb will then contain a mixture of 1 part blood to 99 parts of the dilu-

tant; the contents of the capillary tube up to the mark 1 do not enter the mixture. In this case the proportion of the blood to the dilutant will be 1 : 100; if the mixer be only filled to the mark 2 with blood then the proportion will be 1 : 200. After use the mixer is washed out with caustic potash, then well with water, and finally dried by drawing a current of air through it.

For counting the cells various instruments have been devised. Two of the latest forms, those of Thoma and Malassez, give very exact results. Malassez's counter, Fig. 3, consists of a thick nickel slide, in the centre of which is a circular groove enclosing a glass cylinder 1 cm. in diameter. On the outside of the groove, equidistant from each other, are three pointed screws, which project exactly $\frac{1}{5}$ of a millimetre above the surface of the slide. In the centre of the slide limited by the groove are drawn the squares in which the blood cells are counted (Fig. 4). These have a side of $\frac{1}{20}$ of a millimetre, and are arranged in groups of twenty, each group having a length of $\frac{1}{4}$ of a millimetre and a width of $\frac{1}{5}$ of a millimetre, and an area, therefore, of $\frac{1}{5} \times \frac{1}{4} = \frac{1}{20}$ of a square millimetre. Each group is separated from the adjoining groups by double lines. The cover-glass, which is ground perfectly flat, is attached, by moistening the edges slightly with saliva, to a frame fixed to the sides of the slide (Fig. 3). The frame is then lowered until it comes in contact with the screw points, thus spreading out the drop of blood, previously placed on the surface of the glass cylinder, in a perfectly horizontal layer $\frac{1}{5}$ of a millimetre in thickness. To prevent evaporation a drop of water is allowed to run under the cover-glass and fill the vacant space between its edge and the groove in the surface of the slide. The slide is now placed on the microscope, and with a power of 200 the red cells lying within a group of twenty squares are counted. As these squares have an area of $\frac{1}{20}$ of a square millimetre, and the thickness of the layer of fluid is $\frac{1}{5}$ of a millimetre, therefore the quantity covering the group of twenty squares will equal $\frac{1}{20} \times \frac{1}{5} = \frac{1}{100}$ of a cubic millimetre. The number of cells counted, therefore, has to be multiplied by 100, and then again by the number representing the dilution, and the product will be the number of cells in a cubic millimetre of undiluted blood. For example, the mixture used has a dilution of 1 to 200, and the number of cells found in $\frac{1}{100}$ of a cubic millimetre equals 250; then $250 \times 100 \times 200 = 5,000,000$. Thus, to the number of cells counted add 0000, if the dilution be 1 to 100; if the dilution be greater, multiply the number of cells counted by the figure representing the dilution before adding the 0000.

For counting the white cells the number found in ten of the rectangles of twenty squares must be taken. If in a dilution of 1 to 100 the number of cells counted be, for example, 30; then as the volume of the mixture equals $\frac{1}{20} \times \frac{1}{5} \times 10 = \frac{1}{10}$ of a cubic millimetre, therefore the number of white cells counted must be multiplied by 10 and then by 100, and the product will be the number of cells in a cubic millimetre of undiluted blood.

[To be continued.]

Dr. P. I. Leonard lectures once a week upon pathology and microscopy in the Ensworth Medical College, St. Joseph, Mo. He pays especial attention to the technique of microscopical work upon normal and morbid tissues.

The 12th Annual Meeting of the American Society of Microscopists.

BY ROBERT W. SMILEY,

WASHINGTON, D. C.

Buffalo, the beautiful "Queen City of the Lakes," has for the second time extended its hospitality to this Society. Owing to the efforts of Doctors Lee H. Smith, George E. Fell, Lucien Howe, and other members of the local committee, arrangements had been made to extend to the visiting microscopists a most hearty welcome. On Monday evening, August 19, the Executive Committee met with the local committee, when the latter announced that an excursion would be given at such time as might be agreed upon, several feasible trips being submitted. The Hotel Iroquois, because of its convenient location, was selected as the headquarters.

TUESDAY MORNING.

The opening session was held at the lecture room of the Society of Natural Sciences in the Buffalo Library Building, Tuesday, August 20, at 10.30 A. M. Dr. Lee H. Smith, president of the Buffalo Microscopical Society, after calling the meeting to order, introduced the Rt. Rev. A. Cleveland Coxe, who delivered an invocation.

Hon. David F. Day, president of the Society of Natural Sciences of Buffalo, was then called upon to deliver an address of welcome on behalf of the local microscopical club and the citizens generally. President Day dwelt upon the advantages of Buffalo as a meeting place, upon the hospitality of the people, and in the following words welcomed the visitors on behalf of the various societies :

"There are in the Microscopical Club of Buffalo some whose reputation as men of science has extended beyond the seas, and whom you will remember as among those who have heretofore taken an ample and honorable part in the labors which have distinguished your Society. They have looked forward to your coming again to this city with the greatest pleasure ; and they early resolved that during your sojourn here nothing essential to your happiness and within their power to provide should be wanting. They now place at your disposal their apartments in this temple, dedicated to science, letters, history, and the fine arts ; and they invite you, most cordially invite you, to make use of all the property of the Club as shall best contribute to the purposes which have brought you here.

"More than this : at their request the Buffalo Society of Natural Sciences to-day throws open wide its doors, and bids you enter and possess whatever is here which will minister in any degree to your pleasure or convenience during your stay among us.

"At the like request, the Buffalo Library offers to your use, while you are here, its rooms for study and discussion, its library of 60,000 volumes and the priceless treasures which belong to it, and in which your cultivated and æsthetic taste may find enjoyment. Our Historical Society, another one of the occupants of this majestic building, gladly responding to the same call, asks you to make whatever use you can, while you are our guests, of their books, papers, and collections, 'rich with the spoils of time.' The Buffalo Academy of Fine Arts, also a tenant of this edifice, not to be excelled in liberality by its sister societies, asks you to give such attention as may be within your power to its

collection of paintings and objects of art. In the name, then, of all these associations, distinct in organization, but one in the exalted purpose of elevating the minds of men, I bid you a most cordial welcome here."

Dr. Wm. J. Lewis, president of the American Society of Microscopists, made an appropriate response, in which he said that ten years ago the Society—then an infant—first met in Buffalo. He spoke of the encouraging progress made since that time, and concluded by thanking the citizens for their kind welcome.

A recess was then taken, after which the Executive Committee reported favorably upon the following applicants, and they were elected members: Dr. W. C. Krauss, Dr. F. W. Brayton, F. S. Marsh, Ph. G., H. L. Gifford, F. A. Perry, and George Bahrenburg. The minutes of the previous meeting were adopted.

Dr. Smith announced that arrangements had been made for dealers and manufacturers of microscopes to exhibit their goods. The excursion for the Convention on Friday, he said, would be a trip on the lake and around Grand Island.

The first paper was then read by Prof. T. J. Burrill, of Champaign, Ill., on "A Microscopic Stand." Prof. Burrill said that one using a special instrument would naturally have definite ideas about it; that one could note the general form and qualities of a microscope in a few minutes, but to determine its advantages he must work with it. He then proceeded to give what, in his view, were the desirable features for a microscope stand. A good instrument should be had to begin with; that an excellent microscope need not be expensive, although he insisted that expense should not be a consideration. If anybody was to have a good instrument, let it be the student, by all means. Discussion followed, in which Professors Hyatt, Rogers, Kellicott, and Dr. Fell participated.

TUESDAY AFTERNOON.

The first paper was by Prof. W. A. Rogers, on "A New Method of Determining Temperature from the Reading of Thermometers." The following abstract shows the technicality and principal points of the professor's theme:

"The justification of a paper on the measurement of temperature as a microscopic communication does not need to be made before those who have had occasion to make use of a standard measure of length in scientific investigations. In the hands of the physician the thermometer is quite as much an instrument of precision as the microscope. In fact, the one is a necessary supplement to the other. The numberless ways in which the thermometer plays an important part in connection with microscopic studies amply justify every sincere attempt to discover just how far the mercurial thermometer may be relied upon in the measurement of temperature.

"It has long been known that the mercurial range of a thermometer is subject to pulsatory movements, but I am not aware that the nature of these pulsations has ever been investigated. Thus far they have been supposed to be small in amount and irregular in character. It is the purpose of this paper to show that these pulsations are always to be found in thermometers; that they are of sufficient magnitude to demand attention; that they occur at fixed and regular intervals in the same thermometers; that the cycle of changes indicated by a mercurial

column during one of these pulsatory movements may be represented by a curve, whose amplitude is constant for all temperatures with which we have ordinarily to deal; that the form and amplitude of this curve are the same, whether the cycle of changes is completed within a few minutes or in several hours; and, finally, that in accordance with the facts of observation here pointed out, the uncertainty in the indications of a mercurial thermometer is much greater in the case of slow changes of temperature than in moderately rapid changes.

“Referring only to the particular thermometers under investigation, it is safe to say that random readings of a thermometer are in no case reliable indications of the real temperature; but if continuous readings are taken at short and equal intervals of time until a cycle of changes has been completed, the mean of the indications will indicate a close approximation to the real temperature. This constitutes what I have called a new method of obtaining the temperature from the readings of mercurial thermometers. Briefly, it may be called the method of reading by cycles.

“The systematic character of the deviations of one thermometer from another is best shown by the comparison of the difference between the readings at equal and regular intervals of time.

“The advantages of the new method are obvious. If we wish to determine the relation between a given thermometer and a standard whose errors are known, we have only to make continuous comparisons under a moderately rapid change of temperature at various intervals of time, and then take the mean of the differences for each completed cycle. In the case of my own standard, in which the period of the cycle is $\frac{24}{100}$ of a degree, there would be in a rise or fall of 10 degrees, occupying perhaps three hours, over 40 well-determined points at which the relation between the two thermometers could be established; a result which would require several weeks of random observations made in the usual manner.”

In the discussion which followed Dr. Taylor said that while in Germany he had noted cases where the glass of thermometers had been left seven years to allow shrinking before the instrument was completed. Other remarks were made suggesting that the variation of the glass had much to do with the difference of degrees.

Professor Rogers, in answering the discussion, pointed out the liability to err in comparing thermometer readings. Professor Kellicott, Doctors Lewis and Fell, and Mr. J. A. Miller, also discussed the theme.

The next paper was by Professor S. A. and Mrs. Susannah Gage, on “Staining and Permanent Preservation of Histological Elements, isolated by means of Nitric Acid or Caustic Potash.”

The third paper of the afternoon was on “Microscopic Growth of the Normal and Diseased Eye,” by Dr. Lucien Howe, of Buffalo. The doctor, who is one of the best authorities on all questions relating to the eye, said that the outer coating of the eye was a common resting place for bacteria, many of which are injurious and others that are harmless. He exhibited cultures, and also a patient suffering from eye trouble.

In the discussion which followed Dr. Taylor said it would be well to appoint a committee to make investigations to ascertain whether or not the bacillus in the human eye is similar to the bacillus in cases of pink-

eye and other diseases of the eye in the lower animals. Dr. Howe stated that this was unnecessary, as the views advanced were not original, but were well known to oculists.

The last paper of the afternoon was by Professor D. S. Kellicott, on "A New Rotifer—*Cephalosiphon furcella*," which he had discovered in a creek near Columbus, Ohio.

This paper evoking no discussion, Dr. Fell remarked that the exhibition to be given Thursday evening would be by invitation.

Dr. Park invited all members interested in Biology to visit his private collection.

TUESDAY EVENING.

The evening session was very brief and consisted only in the reading of the Presidential address by Dr. Wm. J. Lewis, on "Forensic Microscopy; or, The Microscope in its Legal Relations." (This paper was published in full in the *Journal* for September.)

WEDNESDAY MORNING.

Professor Kellicott officiated as secretary in the absence of Professor Burrill. Three applicants were elected to membership.

An amendment to the By-Laws was adopted providing that delinquent members in arrears for three years be dropped from the rolls, with the privilege of reinstatement upon payment of all back dues.

The first paper was by Professor Rogers, on "A Practical Method of securing copies of the Standard Centimetre, designated Scale A," in which he urged that the original plate be given into the custody of the Buffalo Society for safe keeping. The plate, now in the care of the American Society, has been in the course of preparation nearly ten years and has been the subject of much careful study. The matter was referred to the Executive Committee.

Dr. R. H. Ward moved that the Committee on Micrometry be authorized to accept Prof. Ewell's offer of standard plates for the use of local societies. An amendment was offered by Prof. Seaman to the effect that the committee secure from Prof. Ewell and Mr. Fasoldt a dozen plates each, have them compared and issued to local societies. This was adopted. Dr. Fell spoke favorably of this motion, saying that the microscopists had been a long time trying to get standard micrometers, and that if this matter was settled the Society had every reason to be satisfied with the results of the present Convention.

The second paper was by Dr. Geo. E. Fell, on "A Simple and Efficient Deposit Glass."

The paper by Dr. Frank L. James, of St. Louis, on "The Behavior and Appearance of Tempered Steel under Honing," was read only by title.

Before adjourning, the discussion of Prof. Burrill's paper was taken up. Mr. G. S. Woolman said that the beginner could not afford to buy Prof. Burrill's ideal microscope; that, personally, he favored making the microscope as small and complete as possible. Furthermore, he proceeded to say, the American manufacturers are trying to improve the students' microscopes, and that he remembered when a good microscope cost \$75, while now one could be had for \$25.

Dr. Taylor endorsed Mr. Woolman's remarks. Dr. L. D. McIntosh said that, by making a cheap stand, complicated apparatus could readily

be added when required. Prof. Seaman was of the opinion that the largest demand on the microscope was for professional use. He said that the introduction of bacteriology required sub-stage accessories, and that a stage so low that it could not take an Abbe condenser was unsuitable for higher original investigation. If the student has a stand with facilities for taking accessories he has a stand which will last him throughout his whole career of advanced work.

Dr. Taylor declared that Prof. Seaman was not practical; it was best for young students to buy small instruments, and then, as they become more expert, to cast aside the cheap for the more expensive ones.

WEDNESDAY AFTERNOON.

"The Brown-Sequard Method of Treatment." by Dr. Geo. E. Fell, was the first paper of the afternoon session. The point which Dr. Fell endeavored most to impress upon his hearers was the great care necessary in preparing the Elixir. While of the opinion that death could be caused by injecting impure fluid, and that when left for several hours it became dangerous, he also said that when fresh the material was not more harmful than pure water. The doctor cited several cases where patients suffering from consumption, rheumatism, etc., had been temporarily benefited. He was of the opinion that these cases were not representative because of the abnormal conditions, which were not advantageous. Brown-Sequard had claimed that the fluid was for such as were in old age, not in disease. Dr. Fell said he had injected from 1 to 2 drams, and found that the patients (with the exception of one who died through natural causes) were in about the same condition that they were previous to the treatment; from which fact he concluded that his injections were in too small quantities to cause permanent good. He stated that he had examined the fluid two hours after preparation, but as the liquid had been kept under antiseptic conditions he found no bacteria.

Dr. Howe agreed with Dr. Fell, that in handling Brown-Sequard's fluid, as in the investigation of bacteriological disease, great care should be taken. He also thought that the mental condition of the patient should be carefully considered.

Dr. James said if any other man than Brown-Sequard had fathered this thing, it would have been dismissed as an evidence of second childhood. After the first mysterious reports, it was learned that Dr. Brown-Sequard did not claim to have found an elixir of life, but the means of introducing into the aged a living principle which would partially stop the advance of decrepitude. The matter had again demonstrated the gullibility of human nature.

Dr. Smith said that the gentlemen who had investigated the treatment of the elixir should be thanked for the study they had made to determine the benefit, if any.

An invitation was received from the Convention of Florists, also in session at Buffalo, to attend the Floral Exhibition at Music Hall.

An interesting paper by Dr. Thomas Taylor, on "Detection of Adulteration in Tea," was then read. The doctor treated of the various methods of adulterating the materials and color in tea. In making his preliminary investigations in tea-leaf dissections, Dr. Taylor discovered peculiarly formed isolated cells, polarizing bodies, seemingly having no connection whatever with the general structure of the leaf. The presence of "stone" cells in tea leaves formed an important factor to start

from. Many of the adulterants are so easily detected and the punishment of the offender so certain that the question seems to have resolved simply into the consideration of relative cost. It is to prevent this organized system of robbery on the part of irresponsible persons that Congress has devised means to protect the buyer of food stuffs. Most of the teas shipped from Japan to the United States are now artificially colored. Formerly this was not the case. Japan teas, which are naturally of a blackish-green color, are now made to resemble the bluish-gray of teas shipped from China as "green teas." The materials used to produce these unnatural shades are not very pernicious, being nothing worse than indigo and gypsum. They certainly add nothing to the value of tea leaves for drinking purposes, while they do add considerably to their cost. There is nothing to be said in favor of the practice except that dealers in America prefer teas of that description. Their doing so is probably explained by the fact that in teas so colored coarse leaves may pass without detection. The adulteration will continue as long as consumers in America buy tea only in accordance with the appearance of the leaf, regardless of its drawing qualities. To the Japanese the colored article is an abomination. The American demand for the uncolored teas known as "basket fired" has latterly increased, and it would be as advantageous to the consumer in the United States as it would gratify most shippers in Japan if this inclination to return to honest uncolored teas were to become general, for it would certainly result in greater discrimination in the picking and preparation of the leaf in Japan. It would afford customers better teas at lower prices, would restrict the supply to good teas only, and revive the favor which Japan teas formerly enjoyed in the American market, as compared with the highly-colored teas of China.

The paper was accompanied by a series of beautiful plates of Dr. Taylor's own preparation, as follows :

Plate I.—1. Epidermal cells and Stomata. 2 and 3. Columnar or Palisade cells and chlorophyll cells. 4. A "Stone" cell. 5. Loose cells. 6. Vascular bundles. 7. Stomata.

Plate II. Cell structure of tea leaf between the epidermal layers.

Plate III. Sclerenchyma or "Stone" cells of the tea leaf.

Plate IV. 1. Cross section of camellia leaf. 2. Cross section of tea leaf. 3. Stomata in leaf of the *Camellia japonica*.

Plate V. Tea leaf, black currant.

Plate VI. Distinguishing serrations of leaves, sometimes mixed with tea leaves, *e. g.*, willow, hawthorn, sloe, etc.

Plate VII. Distinguishing serrations of the leaves, sometimes mixed with tea leaves, *e. g.*, black currants, ash, beech, etc.

Plate VIII. Leaves mixed with tea to adulterate. 1, willow leaf; 2, Ilex or Paraguay tea; 3, ash; 4, black currant; 5, camellia; 6, sloe; 7, beech.

Mr. W. Drescher exhibited a new biological microscope, by Bausch & Lomb, which followed Hartnack's model.

Mr. M. S. Wiard read a paper on "The Busy Man's Amateur Microscopical Laboratory."

Dr. Lewis said he had received some beautiful diatomaceous earth and petrified wood, which he would distribute at the working session.

WEDNESDAY EVENING.

The members were entertained in the evening at the elegant residence of Dr. Lucien Howe, on Delaware avenue. The most social spirit prevailed. About nine o'clock the guests were requested to pass into the dining-hall, where they remained until a late hour indulging themselves to their hearts' content with the luxuries so kindly furnished by their genial host. When felicity was at the height the gentlemen were suddenly surprised by the entrance of the lady members, who, it seems, though not caring for the cigars, could not resist the chance to see how the sterner members were enjoying themselves. The following toasts were offered:

By Dr. Lewis, on the American Society.

Dr. James, although past thirty, still a hopeless bachelor, was acknowledged as the only fit person to propose the health of the ladies; reluctantly he complied to this request in language both soulful and pathetic.

By Prof. Kellicott, on the Past of the Society.

By Dr. Seaman, on the Future of the Society.

The most noteworthy feature of the evening was the kind remembrance of members who were unable to be present.

Dr. Howe spoke feelingly of his relations with Dr. Bernard Persh, a man who, like Goldsmith's village preacher, was dear to all who knew him; one more skilled to help those struggling to aid mankind than to step in and claim the honors himself.

Dr. Taylor related his own dealings with Dr. Persh, whose death he mourned as a brother's.

Rev. Francis Wolle, who has done more in the study of Fresh-water Algæ and the Desmids of the United States, and that without the aid of the Government, than any other living man, was also kindly remembered.

Dr. Louis Bull mustered a quartette, which rendered excellent music. Toasts were also offered by Dr. Howe, Prof. Ward, and others.

Dr. Howe's "Commers" was one of the many pleasing features which will make the visiting scientists long remember their stay in Buffalo.

THURSDAY MORNING.

At the opening of the session Doctors Fell and Smith made announcements relating to the soirée and the excursion.

Dr. Lewis said that the time had arrived for electing a committee to ballot for president. He appointed Dr. Blackham to act as teller.

The following gentlemen were elected as a nominating committee, to report nominations for officers: Prof. T. J. Burrill, Dr. Frank L. James, Prof. D. S. Kellicott, C. C. Mellor, Dr. R. H. Ward, William H. Walmsley, and W. A. E. Drescher.

Upon the recommendation of the Executive Committee, Dr. F. W. Ross, Mrs. C. B. Lewis, and Messrs. F. Selleck, E. D. Hall, A. J. Gawne, and H. S. Brode were elected members.

The first paper read was on "The Best Technique for Photo-microscopy with High Powers," by George W. Rafter, and a very animated discussion followed, Dr. Detmers, Prof. Burrill, Dr. Taylor, Dr. Mercer, and Dr. Blackham participating.

Prof. Kellicott briefly described a new collecting net, designed by Prof. C. S. Fellows, of Minneapolis.

The third paper, by Dr. H. N. Lyon, on "Notes of the Histology of *Attacuscecropia*," was read by title only.

Dr. George E. Blackham presented a paper on "Measurements of the Amplifying Power of Objectives and Oculars in the Compound Microscope," and with its discussion the forenoon session closed.

THURSDAY AFTERNOON.—WORKING SESSION.

The afternoon session was devoted to the demonstration of practical microscopic work, as follows:

By L. D. McIntosh, M. D.: Use of Solar Microscope and Stereopticon Combination. Among the objects projected on the screen were histological sections from cat, including the intestine, brain, liver, and kidney, larva of mosquito, section of human tooth showing dentine and bone, section of human embryo foot showing ossification, Rinnbock's slides of arranged diatoms (published in the November number of this Journal, vol. ix, 1888, facing page 199), lightning flashes, blood corpuscles, bacteria, etc.

By R. H. Ward, M. D., F. R. M. S.: Methods of Micrometry.

By George W. Rafter: Use of Professional Photo-micrographic Camera, and an improved method of making a microscopical examination of water.

By A. M. Ewing, M. D.: The Working of a New Ether-freezing Microtome, showing the freezing of a section of cancer. The microtome exhibited by Mr. Ewing is a modification of that invented by Mr. Wingrave, of London. By its comparative simplicity and cheapness it possesses many advantages over the more expensive freezing microtomes.

By A. C. Chester, M. D.: Working of a Machine for Making Tin Cells used in exhibitor's method of dry mounting.

By George A. Bausch: General Construction of the Microscope.

By Prof. J. D. Hyatt: Methods of Cutting Rock Sections.

By R. R. Lansing, M. D., and R. N. Lansing, M. D.: Paraffine Method of Imbedding; Section Cutting and Mounting; Mounting *Bacillus tuberculosus* in balsam.

By George E. Blackham, M. D., F. R. M. S.: Determination of the angular aperture and working distance of objectives.

By Edward S. Nott: Method of cleaning and mounting diatoms.

By Roswell Park, M. D., and W. H. Bergtold, M. D.: Preparation of culture media; cultivation of bacteria; making Esmarch's tubes. Their exhibit of 72 tubes, cultures of bacillus of anthrax, Asiatic cholera, scarlet fever, swine plague, bacillus typhoid fever, chicken cholera, and many other well known diseases of man, the lower animals, and plants, was one of the principal features of the working session. A glass jar was shown which contained the bacillus of water, yeast, etc., growing on sterilized pieces of potato, bread, etc. Specimens of red, black, violet, etc., from water were also shown. The method of photographing microscopic objects by electric light proved highly interesting, a miniature incandescent light being used.

By Lucien Howe, M. D.: Preparation of nutrient gelatine for bacteria; culture of bacteria taken from the eye; staining of bacteria. The doctor described the various stages of preparing gelatine for the

cultivation of bacteria, which was as follows: 1, boiling of ingredients; 2, filtration; 3, sterilization by moist air; 4, sterilization by heated air.

By S. Y. Howell, M. D., and A. L. Benedict, M. D.: Staining of *Bacillus tuberculosis*; Thoma and Zeiss' apparatus for counting blood corpuscles.

By W. J. Kent: Process of placing gold fish under the microscope for observing the circulation of the blood.

By C. L. Pond and C. A. Svensson: Microtome.

By R. N. Reynolds, M. D.: Histological preparations under microscope.

By H. S. Brode: Making paper boxes for imbedding paraffine.

Specimens of a fresh-water sponge found by Mr. Mills in "18-mile Creek" in October, 1882, and also in St. John's River, Fla., in 1885, were also exhibited.

The working session, which proved to be a valuable feature of the Buffalo meeting, was under the direction of Stephen Y. Howell, M. D., who, by his close attention and ardent labors, insured the most successful one yet held by the Society.

THURSDAY EVENING.—THE SOIRÉE.

The notable feature of the meeting of the microscopists was the microscopic exhibit given for the benefit of the general public. In previous years these exhibitions have usually been held in large halls, desirable because of their facilities for the easy handling of crowds, but this time it was deemed proper to hold it in the Library building, where the various handsome rooms and scientific and art collections would substantially add to its attractiveness. The Library Association generously gave the use of the entire structure, the other organizations interested consenting. So that as well as seeing the microscopic display the visitors might examine the treasures of the Art Gallery, the Society of Natural Sciences, and the Historical Society. Furthermore, citizens owning microscopes were asked to contribute them for the occasion, and the response was such that when evening came nearly 250 instruments were ready for use.

At 8 o'clock the microscopical soirée was in successful progress. The illuminated building presented a fine appearance from without. Inside it was filled with light and life. The tables supporting microscopes were in the main room in the basement, in the Library rooms, and the rooms of the Historical Society. In the Art Gallery, Dr. Lee H. Smith entertained the visitors with his talking and whistling phonograph. On the library floor music was furnished throughout the evening.

Most of the objects chosen for exhibition were those which would best serve to engage and please the average visitor's attention rather than those of the most particular scientific interest. Among them were exquisite crystals of precious stones and metals, alloys, disease growths, animal tissues, forms of vegetable and shell life, hair, the parasites of various creatures, anatomical and physiological specimens, bacteria, trichinæ, micro-photographs, etc.

Dr. George E. Fell, chairman of the Exhibition Committee, and other members of that committee, have every reason to congratulate them-

selves upon the soirée of 1889, which was in every particular all that could have been desired.

A few of the principal exhibits were as follows:

By C. E. Alling, F. R. M. S., with B. & L.'s Concentric: Section of toe-nail of elephant from Jumbo, stained.

By Miss Mary A. Booth, with Griffith Club: Hairs of larvæ of *Trogoderma ornata*.

By Mr. G. R. Bausch, with B. & L.'s Concentric: Cornea of eye of water beetle.

By Mr. S. W. Baker, with Collins' (Binocular): Transverse section of *Pinus strobus* (Pine Needle), double stained.

By Dr. Geo. E. Blackham, with Folles-Blackham: *Trichina spiralis* (encysted).

By Dr. L. A. Bull, with Schraner: *Cimex lecticularis*.

By Bausch & Lomb, with their own microscopes: *Trichina spiralis* in human muscle, diatoms, circulation of blood in tail of fish, diamond beetle, proboscis of butterfly, rolling stones, butterfly scales arranged in form of bouquet, and platino cyanide of magnesium.

By Prof. Albert H. Chester, with Schraner (Binocular): Green garnet.

By Mr. E. L. Cheeseman: Crystal alloy of gold and silver.

By Dr. Lucien Howe, with Beck's (Binocular): Vegetable growth from human ear and eye.

By Mr. J. D. Hyatt, with Zentmayer: Multiple images in compound eye of beetle.

By Dr. Geo. E. Fell, with B. & L.'s Concentric: Pond life.

By Dr. S. Y. Howell, with Zentmayer: Malarial pigmentation of brain tissue, diphtheritic inoculation of cornea of guinea pig, *Bacillus megaterium*, *Actinomycosis bovis*, sea-weed, stem of an endogen, mouth, eye, and foot of fly, tongue and sting of bee, spider, foot of spider, flea, wing of butterfly.

By Dr. C. Jackson, with Zeiss: Insect in human skin; with Zentmayer, bacillus of typhoid fever.

By Dr. F. L. James, with B. & L.'s Universal: Crystallized salacine.

By Prof. D. S. Kellicott, with Zentmayer: Floscules from the Niagara.

By Mr. F. W. Kuhne: Pond life.

By Dr. W. J. Lewis: Insect eggs on leaf.

By Mr. C. G. Milnor, with Universal (Binocular): Lung of Pittsburg iron-worker.

By Dr. L. D. McIntosh: Tooth of dog, lip and lung of cat, oxyhydrogen microscope, section human tooth, human skin (injected), human lung, human liver (injected), sciatic nerve, *abies excelsa*, antenna of moth, saw fly, wood ant, larvæ of mosquito.

By Mr. C. C. Mellor, with Acme and B. & L.'s models: Crystals sulphate of morphia, leg of diamond bee, adontophore of octous.

By Mr. E. S. Nott, with Crouch (Binocular): Arranged diatoms.

By Dr. Lee H. Smith, with B. & L.'s microscopes: Hamburg canal water, Niagara river water, Park Lake water, circulation of blood in salamander.

By Dr. Thomas Taylor, with Acme: Stone cells of the tea leaf.

By Dr. R. H. Ward: Section of grain of Indian corn showing embryo plant.

By Dr. E. Wende, with B. & L.'s microscopes: Flea, earth mite, parasite of sand martin, parasite of mole, and a species of *Actinocyclus*, *Heliopelta*, *Cyperus*, *Lycopodium*, and *Dendrobium*.

By Mr. G. S. Woolman, with Beck, Acme, and Zeiss: Section of young squirrel, head of mosquito, salacine, proboscis of blow-fly, hair formation in scalp.

It had been intended to send out invitations, but by an oversight the proper direction of some 1,200 of these was neglected, so all comers were admitted. Had it been thoroughly known that the admission would thus be entirely free to everybody, the throng undoubtedly would have been large beyond all possibility of comfort. As it was, a great number of people were present during the evening.

FRIDAY MORNING.

Dr. James presented the report of the Auditing Committee, stating that all bills against the Society had been paid, and there was yet in the treasury \$26.63, not including the receipts of the present meeting.

Dr. Ward presented the reports of the Committee on Standard Micrometry and on the Faslolt plate.

Dr. Seaman presented the report of the Committee on Periodicals and Publications.

An individual report from Dr. Detmers created some discussion, in which Dr. Fell, Dr. Blackham, and others participated. Eventually a motion to discharge the committee was carried.

Dr. Blackham, from the Committee on Constitution and By-Laws, reported progress. Somebody remarked that this committee should be discharged, because they had reported nothing more than progress for years. The committee was continued.

The Committee on Poisonous Meats and Dairy Products was discharged.

Dr. Mosgrove tendered his resignation as Treasurer, which was accepted, and C. C. Mellor was elected Treasurer for the remainder of the unexpired term—one year.

The Nominating Committee presented the names of the following gentlemen for officers of the American Society, and they were duly elected: President, Dr. George E. Fell, Buffalo, N. Y.; Vice-Presidents, Prof. W. H. Seaman, Washington, D. C.; F. W. Kuhne, Fort Wayne, Ind.; Executive Committee, W. P. Manton, Detroit, Mich.; Dr. F. L. James, St. Louis, Mo.; W. H. Walmsley, Philadelphia, Pa., Prof. Burrill holding over as Secretary.

Dr. Howe offered as a motion that the exact name of every object to be exhibited at any soirée of the Society be first submitted to a suitable committee before exhibition. This motion was referred to the Executive Committee.

A paper by Dr. Fell on "Examination of Legal Documents by the Microscope" was read by title only.

Dr. C. Q. Jackson read an interesting paper on "Bacteria in Ice." He said it might, like water, appear clear, and yet swarm with bacteria. There was almost, though not quite, as much danger as before freezing. He set forth that although numbers of bacteria were killed by freezing.

many others were unaffected by the low temperature. As in other spheres of animal life, the struggle for existence went on, with the survival of the fittest. Ice sometimes contained the bacilli of typhoid fever. It might be nothing short of a congealed emulsion of bacteria with which we could inoculate ourselves. He urged the necessity of safeguards against the pollution of the water by sewage, etc. This was a duty in which everybody was interested. Snow ice generally contained a great deal of bacteria. Any ice not entirely clear should not be allowed to come into contact with food. Absolute safety could only be obtained by making ice by the artificial freezing process. Dr. Jackson said he did not wish to be understood as wishing to introduce anything sensational, or to make a crusade against the ice companies.

A paper by Dr. Fell on "The Value of the Microscope in the Diagnosis of Tuberculosis" was read by title, after which the Society adjourned for dinner and an excursion down the river.

MANUFACTURERS' EXHIBITION.

Fine exhibits of microscopes, objectives, accessories, microtomes, mounting instruments and materials, lenses of all descriptions, cabinets for slides, microscopical literature, and mounted objects were made by the following well-known dealers in microscopical supplies:

By *Mr. G. S. Woolman*, of New York: 7 microscopes, object boxes, and many slides illustrating nearly all branches of microscopical mounting, many of which were of a rare character. Noteworthy among them were the histological and dental, many of which were beautifully stained; others that required polarized light. The sections of rocks attracted attention, particularly the slides of characteristic eruptive rocks. In speaking of Mr. Woolman's collection of slides a prominent member of the Society said that some of them were the finest he had ever seen.

By *Messrs. Bausch & Lomb*, of Rochester: Microscopes of their own make, together with all microscopical supplies, objectives, microtomes, books, &c.

By *Miss M. A. Booth*, of Longmeadow, Mass., with Griffith stand: 250 slides of recent and fossil diatoms, foraminifera, seeds, opaque objects, etc.

By *Messrs. J. W. Queen & Co.*, of Philadelphia: Microscopes (Acme)—calling especial attention to the easy movement of the coarse adjustment. Slides of anatomical sections and of general interest, books and accessories. One slide of *Lepidocyrtus curvicollis*, showing the projections on the surface, was exhibited.

By *Dr. L. D. McIntosh*, of Chicago: 5 microscopes, microscopic attachment for use with solar or artificial light for projecting or photographing objects, solar stereopticons, slides, etc.

By *The Educational Supply Co.*, of Boston: Zeiss' microscopes, accessories, Thomas' and Minot's microtomes, mounting instruments and materials.

FRIDAY AFTERNOON.—THE EXCURSION.

At 2.30 o'clock the "Huntress" steamed out of Buffalo river with the microscopic party, including many ladies.

First the boat made a circuit of the new Government breakwater, that the visitors might see Buffalo's big outer harbor. Then heading down the river a call was made at Ferry street, where many of the scientists

stopping in that vicinity came on board. After that no other stop was made until 5 o'clock, when the steamer was made fast at the dock in front of the McComb Hotel, where refreshments were to be served.

While lunch was still in progress speeches were made by Hon. David F. Day, President Lewis, Dr. Lee H. Smith, Dr. Geo. E. Blackham, Prof. W. H. Seaman, and Dr. W. C. Barrett.

Dr. Lewis then called upon Dr. Geo. E. Fell, the new president of the American Society of Microscopists. Dr. Fell told how he first became interested in microscopic work, and made some statements relative to the history of the organization. Having studied with the late Peter Emslie, he followed the profession of civil engineering for some years, then devoting his attention to medicine, in which he had always had a deep interest.

At the conclusion of Dr. Fell's remarks the Society was declared adjourned *sine die*. The time and place for next year's meeting will be determined by the Executive Committee and hereafter announced.

On the return trip up the river a meeting of the Executive Committee was held, at which it was voted to accept with pleasure the offer of the Buffalo Society of Microscopists to take charge of the American Society's collection of plates and other property, and issue them to local societies on the order of proper authorities.

The members who attended the Buffalo gathering united in pronouncing the meeting one of the best it has ever held.

The list of members registered during the Convention is as follows:

- | | |
|---------------------------------------|---|
| William J. Lewis, Hartford, Conn. | C. G. Milnor, Pittsburg, Pa. |
| T. J. Burrill, Champaign, Ill. | Mrs. F. S. Pease, Buffalo, N. Y. |
| Frank L. James, St. Louis, Mo. | George W. Rafter, Rochester, N. Y. |
| Lee H. Smith, Buffalo, N. Y. | Samuel Calvin, Iowa City, Iowa. |
| Louis A. Bull, Buffalo, N. Y. | J. J. Garretson, Buffalo, N. Y. |
| S. Y. Howell, Buffalo, N. Y. | H. J. Detmers, Columbus, Ohio. |
| S. M. Mosgrove, Urbana, Ohio. | Miss F. Detmers, Columbus, Ohio. |
| R. H. Ward, Troy, N. Y. | Martin S. Wiard, New Britain, Conn. |
| J. D. Hyatt, New York, N. Y. | Albert H. Chester, Hamilton College,
N. Y. |
| William A. Rogers, Waterville, Me. | R. N. Reynolds, Detroit, Mich. |
| D. S. Kellicott, Columbus, Ohio. | C. D. Zimmermann, Buffalo, N. Y. |
| George E. Fell, Buffalo, N. Y. | George F. Danforth, Jamestown, N. Y. |
| Charles C. Mellor, Pittsburg, Pa. | Wm. H. Seaman, Washington, D. C. |
| G. S. Woolman, New York, N. Y. | Mrs. J. C. Eddy, Cleveland, Ohio. |
| Mary A. Booth, Longmeadow, Mass. | John A. Miller, Buffalo, N. Y. |
| Thomas Taylor, Washington, D. C. | E. L. Cheeseman, Knowlesville, N. Y. |
| L. D. McIntosh, Chicago, Ill. | Fred. S. Marsh, Jamestown, N. Y. |
| Ada M. Kenyon, Buffalo, N. Y. | Herman L. Gifford, Jamestown, N. Y. |
| Edward S. Nott, Hamburg, N. Y. | M. Francis, College Station, Texas. |
| W. J. Prentice, Allegheny City, Pa. | Dr. Mary A. Sprink, Indianapolis, Ind. |
| Frank F. Colwell, Urbana, Ohio. | H. H. Turner, Rochester, N. Y. |
| J. J. B. Hatfield, Indianapolis, Ind. | George E. Blackham, Dunkirk, N. Y. |
| Charles Weil, Buffalo, N. Y. | Dr. A. Waterhouse, Jamestown, N. Y. |
| F. W. Kuhne, Fort Wayne, Ind. | S. W. Baker, Jamestown, N. Y. |
| H. S. Brode, Champaign, Ill. | Willis R. Whitney, Jamestown, N. Y. |
| Roswell Park, Buffalo, N. Y. | J. T. Waid, Ridgway, Pa. |
| H. Bausch, Rochester, N. Y. | Charles E. West, Brooklyn, N. Y. |
| Lucien Howe, Buffalo, N. Y. | William Schnur, Warren, Pa. |
| A. M. Hayward, Susquehanna, Pa. | Frank W. Ross, Elmira, N. Y. |
| Frederick G. Perry, Boston, Mass. | J. E. Line, Rochester, N. Y. |
| W. Drescher, Rochester, N. Y. | A. T. Gawne, Sandusky, N. Y. |
| Edward Pennock, Philadelphia, Pa. | M. A. Veeder, Lyons, N. Y. |
| W. H. Walmsley, Philadelphia, Pa. | |

NOTES ON TECHNIQUE.

Detection of Blood-Stains.—Since Professor G. G. Stokes and others first called attention to the peculiar absorption spectrum yielded by blood, the spectroscope has been often employed to detect blood-stains. The latest essays in this direction are alluded to in Dr. Cranstoun Charles' excellent *Annual Report on Medical Chemistry*. He tells us Linossier finds that the most sensitive spectroscopic reaction of blood is that given by reduced hæmatin.

The blood-stain is dissolved in water and examined for the spectrum of oxyhæmoglobin. A drop of freshly prepared hyposulphite of soda is now added, when the spectrum of hæmoglobin appears at once; finally, a couple of drops of a concentrated solution of soda are added, which decomposes the hæmoglobin into globulin and reduced hæmatin, the spectrum of the latter consisting of two absorption bands situated between D and b, the left one lying midway between D and E, and being well marked; indeed, this intense band is the only one to be distinctly observed in dilute solutions, and it ought to disappear if the solution is heated to 50° C., without stirring or agitation, and reappear on cooling; it ought further to disappear when shaken in the air, and reappear on the addition of a drop of hyposulphite of soda. This test applies even to putrid blood. Should the blood-stain have become insoluble in water, we are directed to dissolve it in ammonia, and reduce by adding one or two drops of a solution of ferrous sulphate and tartaric acid.—*The Dosimetric Medical Review, July, 1889.*

American Objectives.—Dr. Pelletan, editor of the *Journal de Micrographie*, says: "Doctor Detmers reaffirms that the best German objectives are in no way superior to the best efforts of the American opticians. I have said in a former article how thoroughly tenable I hold this assertion to be, and declared that I agreed in it completely. I believe that I was first to declare (a long time ago) that poor Robert B. Tolles, so unhappy in his too short career, so long misunderstood in his own country and ignored abroad, was the greatest optician in the world, and I am prepared now to prove that he has never yet been surpassed. I therefore desire to associate myself with Dr. Detmers in the words in which he closes his communication."

To the above Dr. W. J. Lewis adds his views:

"Strong words these, but while agreeing with Dr. Pelletan (and Dr. Detmers) in all that he can say concerning the excellence of the work of Tolles, I believe that the elder Spencer, who soon followed his friend Tolles to the Silent Land, was as good as Tolles. I believe further that his son Herbert Spencer is second to no living optician; that Gundlach has produced and is producing objectives the excellencies of which cannot be duplicated in Europe to-day, and that for certain grades of objectives those of Bausch & Lomb are absolutely incomparable. American opticians have absolutely nothing to fear in competitive contests so far as excellence of work goes with any in the world. I have no patience, therefore, with Americans who are sending abroad for microscopes and objectives. They can get better at home for the same expenditure of money."—*St. Louis Medical and Surgical Journal, July, 1889.*

EDITORIAL.

The American Society of Microscopists.—We are glad to see that this Society, after having had very small meetings for a period of years, has at length experienced a very successful meeting. This, however, was due to the indomitable energy of Dr. Lewis, and of the Buffalo people, headed by Dr. Geo. E. Fell and Dr. Lee H. Smith. The present advantage will be utilized or not according to the arrangements made for the future meetings. The leading members of this Society are, to a considerable extent, members also of the American Association for the Advancement of Science. Of course it is well known that some of them constituted, at one time, an important part of the Microscopical section of that Association.

It came to be felt, and was doubtless true, that a national society of Microscopists could command more influence than the section of a general Association. Our volumes of Proceedings are much superior to what such a section could present, and being published separately are more available to microscopists the world over, and they ought at least to appear more promptly. The officers of our Society doubtless secure greater prominence than officers of a section. Our soirées and working sections have become very useful. At least 250 microscopes were used at Buffalo. There are people who join our Society from an interest in microscopy who would not pay the higher dues of the American Association and to whom that Association might not like to accord the rank of fellowship, which is a qualification to holding office.

On the other hand, it has been noticed, at least in the past two years, that, with the organizations meeting in different cities, there has come a loss of time to those wishing to attend both. The Buffalo meeting closed four days before the Toronto meeting began, thus producing a waste of time to those who had come from a distance. This, in turn, caused some of them to cut short the Toronto meeting. But the Columbus meeting overlapped the Cleveland meeting so as to deprive us from attending both on Tuesday, and several hours travel had to intervene.

We think that the Microscopical Society should either hold its meetings at entirely different times and places from the American Association, and thus avoid even the appearance of parasitism, or else it should boldly assemble at the same place with the American Association, and make its meetings come as close upon the other as possible without much detriment to either. The American Association always closes on Tuesday, with an important evening session, but its morning and afternoon sessions of Tuesday are usually rather unimportant. Without discourtesy, the microscopists could meet Tuesday morning or afternoon, and continue during Wednesday, Thursday, and Friday.

A good many auxiliary clubs and societies are springing up about the Association. The Entomological and Botanical Clubs are within the Association. The Agricultural and Geological Societies are independent. An independent chemical society is about being organized.

The American Association of Scientists is, perhaps, destined to become a confederation of societies, and the microscopists should certainly stand in as close relations as the geologists, the chemists, the agriculturists, and the botanists.

A seemingly disintegrating tendency has been felt by the American Association caused by the pronounced advantages securable in separate organizations, but these advantages we believe may be secured without serious injury to the parent association, if wise counsels prevail.

Let, then, the American Society of Microscopists arrange to begin its next meeting at Indianapolis on the Tuesday in August which marks the close of the American Association, and if this proves impracticable then come as near to it as possible, both in time and place.

EXTRACTS FROM CORRESPONDENCE.

Modified Crystals of Cupric Sulphate. By Wm. N. Hastings, Rochester, N. H.

The following method has proved quite successful in producing, among other beautiful forms, the vortical rosettes figured by Carpenter in "The Microscope and its Revelations."

A drop of saturated aqueous solution of sulphate of copper is placed upon the slide and rubbed with the finger until a thin but perfect film adheres to the surface. Evaporate over the lamp. No crystals should then be visible. Allow it to cool and breathe upon it. Examine with low power. Further breathing will further modify the crystals. The amount of moisture and thickness of the film will determine the forms produced.

Dissolving Apparatus. By Dr. H. P. Nottage, Boston, Mass.

I have invented an efficient and simple apparatus for producing a dissolving view with a single lantern, and am making application for letters-patent. This machine produces an entirely new and novel effect, and dissolves a picture just as efficiently as an expensive double lantern dissolving apparatus. In all previous inventions for use with a single lantern the screen is left in darkness while the picture is being changed, but with this apparatus it is covered with light all the time.

Sections for Practice in Staining. By W. G. Crosby, Canandaigua, N. Y.

I would suggest that a series of vegetable and wood sections be prepared by some one suitable for the delightful pastime of double and single staining by amateurs who have no microtome, and whose time does not permit them to seek out and prepare the material. I am confident such preparations would meet a ready sale. Perhaps such sections may even now be procured, but I do not know where. If so, my pupils and the members of our society would like the information.

MICROSCOPICAL SOCIETIES.

ST. LOUIS CLUB OF MICROSCOPISTS.

Tuesday evening, August 6.—The name of C. C. Faris was proposed for membership.

J. B. Whinery made a report on the examination of powdered acacia. Out of seven samples, one was found with starch. He will do further work on the same subject. A member said that rice starch has been

reported as an adulterant of powdered acacia, and that, owing to the minuteness of the grains of this starch, it would not be noticed with low powers.

H. M. Whelpley exhibited specimens of both white and yellow dextrin, mounted in balsam and in glycerine. He dwelt on the fact that the starch grains in dextrin are not all destroyed, as many suppose, and that they can be readily detected in a powder adulterated with dextrin. However, the microscope would show it as starch and not as dextrin. Another point was that the white dextrin is made from potato starch, while the yellow grade comes from corn starch. The same member had a specimen of powdered senega which had been mixed with starch.

Frank Davis reported that all the senega he had examined was free from starch. He pointed out the similarity existing between powdered senega and powdered fenugreek seed.

—o—

LEAVENWORTH MICROSCOPICAL SOCIETY.

Aug. 7, 1889.—Prof. Lighton exhibited his apparatus for combining oblique with direct illumination, and some fine effects were obtained in the examination of diatoms and bugs. Dr. Bidwell showed a *Cimex lectularius* and *Phthirus pubis*. The nits of the latter were also shown, and one of them was mounted with the hair to which it was clinging. A one-eighth-inch dry objective of Müller's, Germany, a recent acquisition of Dr. Bidwell's, was also exhibited and compared with other objectives.

NOTICES OF BOOKS.

Hypnotism: Its History and Development. By Fredrik Bjornstrom, M. D. The Humboldt Publishing Co., New York. 8°, pp. 126. Paper, 30c.

Last August over one hundred and fifty "Savants of incontestable authority" met in Paris to discuss the progress and development of the mysterious agency known as "HYPNOTISM," and as a result of their deliberations the subject has entered the domain of study, and evidently has come to stay. The author of the present work is well qualified to write on the subject, and has covered its history, effects, morality, uses, abuses, and bibliography.

Homer's Iliad, Books I-III, with Vocabulary. By Thomas D. Seymour. 12°. Ginn & Co., Boston. Price, \$1.35.

Students of the classics who are seeking an introduction to the Iliad will not fail to find in Prof. Seymour's edition of Homer a very interesting and profitable medium. The text here given is that of *Homeri Ilias edidit Gulielmus Dindorf: editio quinta correctior quam curavit C. Hentze.* Leipzig, 1884.

An introduction, simplified and enlarged from "Introduction to the Language and Verse of Homer," by the same editor, is included, treating of the various Homeric peculiarities of poetry and dialect. The story of the Iliad is also given, being a condensation of the twenty-four books. A commentary, adapted to the use of schools, occupies

138 pages and is full of interesting material, which adds greatly to the usefulness of the volume.

A feature to be highly commended is the vocabulary, which covers over a hundred pages and contains numerous illustrations.

It needs only to be added that mechanically this book follows the plan of Allen & Greenough's Latin Classics, being both neat and durable.

Practical Latin Composition. By Wm. C. Collar, A. M. 12°, 268 pp. Ginn & Co., Boston. Price, \$1.10.

This is a new departure in Latin composition. It contains fifty pages of extracts from Nepos, Cæsar, and Cicero, which the student is supposed to make himself thorough with before attempting Latin composition. By means of a series of annotated exercises he reproduces the story, but in slightly varied Latin sentences, which successively illustrate the various grammatical constructions. The Latin text is so closely reproduced that no English-Latin vocabulary is necessary. I should think that the new method would be very successful.

Microscope Catalogue. By Bausch & Lomb Optical Co., Rochester. 8°, pp. 112.

This is their twelfth and best edition. Among the new features are a new biological microscope, the biological objectives which have been constructed for the short tube, and intended principally for histological work, and various new accessories, such as condenser, mounts, etc.

SUBSCRIBERS' NOTICES.

[These notices will be given six insertions in this column at 25 cents per line or fraction thereof.
FOR EXCHANGE.—Slides of selected diatoms. D. B. WARD, Poughkeepsie, N. Y.

WANTED.—Unmounted microscopical material, also micrographic dictionary. Will exchange or buy. CHARLES VON EIFF, 124 Clinton Place, New York City.

WANTED.—A clean copy of Rev. William Smith's British Diatoms, and Schmidt's Atlas of the Diatomaceæ. JAMES B. SHEARER, Bay City, Mich.

OFFERED.—Diatomaceous Earth from Utah (Desert) for Histological Mounts. PROF. ORSON HOWARD, Salt Lake City, Utah.

CORRESPONDENCE invited with a view to the exchange of either mounted or unmounted Oribatida (British) for American species. E. BOSTOCK, Stone, Staffordshire.

TO EXCHANGE.—Native gold, silver, copper, lead, zinc, and other beautiful cabinet specimens, polished ornaments and sections of petrified wood—Chalcedony—and native turquoise, agate, amethyst, rubies, etc.; also Indian ornaments, curios, arrows, blankets, pottery, etc.; pelts of wild animals, species of native cactus, and a good second-hand "Burt's Solar Compass" complete. Any or all of the above are offered in exchange for new, or good second-hand, objectives, condensers, polarizers, stand, or other microscopical apparatus. W. N. SHERMAN, M. D., Kingman, Arizona.

OFFERED.—Zeiss' New Catalogue (in German) forwarded for 10 cents in stamps. F. J. EMMERICH & SONS, 43 Barclay St., New York City.

WANTED.—Any works on Microscopy not already in my Library. H. M. WHELPLEY, F. R. M. S., St. Louis, Mo.

WANTED.—(In exchange for slides.) "Microscopical Bulletin," Vol. I, No. 5, August, 1884. M. S. WIARD, New Britain, Conn.

Labels in exchange for slides. EUGENE PINCKNEY, Dixon, Ill.

First-class Histological Slides for other good mounts; Histological and Pathological material cut on shares. S. G. SHANKS, M. D., 547 Clinton Ave., Albany, N. Y.

OFFERED.—Griffith & Henfy Micrographic Dictionary to be sold; also Hogas Microscope. J. P. WINTINGHAM, 36 Pine St., N. Y.

WANTED.—A clean copy of Wolle's Fresh-Water Algae of the United States (2 vols.); also good second-hand Grunow Camera-Lucida, and a self-centering Turn-table. JOS. P. THOMPSON, P. O. Box 1383, Portland, Me.

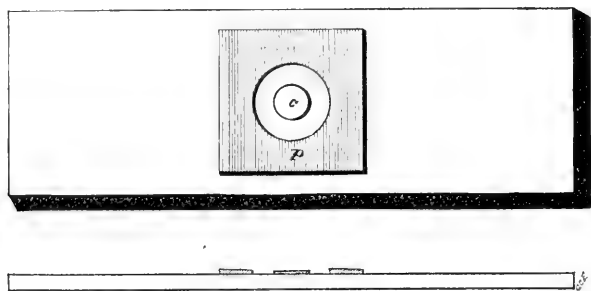

FIG. 5.

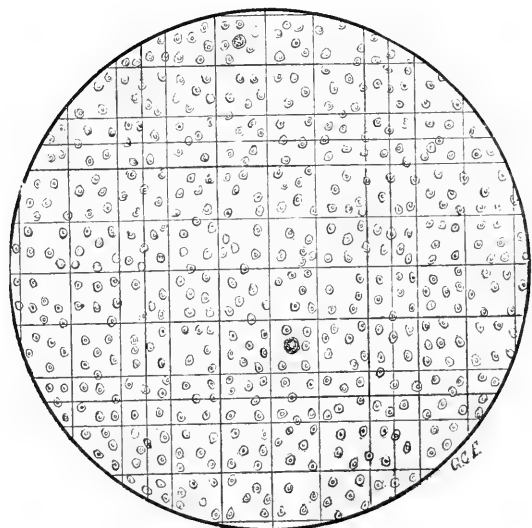

FIG. 6.

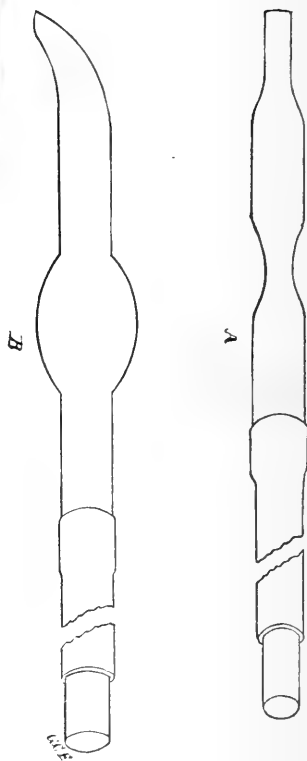

FIG. 8.

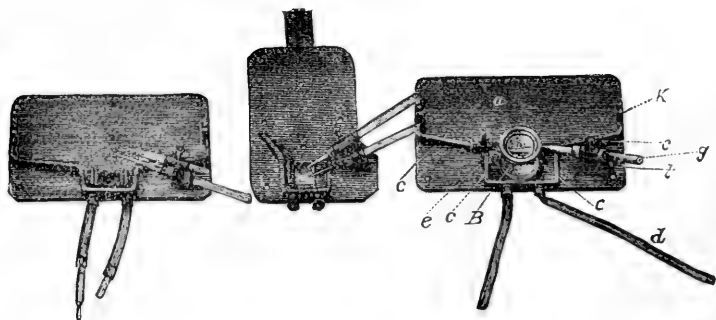

FIG. 7.

APPARATUS FOR EXAMINING BLOOD.

THE AMERICAN MONTHLY MICROSCOPICAL JOURNAL.

VOL. X.

NOVEMBER, 1889.

No. 11.

All communications for this Journal, whether relating to business or to editorial matters, and all books, pamphlets, exchanges, etc., should be addressed to American Monthly Microscopical Journal, Box 630, Washington, D. C.

European subscriptions may be sent directly to the above address accompanied by International Postal Order for \$1.15 per annum, or they may be sent to Messrs. Trübner & Co., 57 Ludgate Hill, London, or to Mr. W. P. Collins, 157 Great Portland street, London, accompanied by the yearly price of five shillings.

Histological Technique of the Blood.

By GEORGE C. FREEBORN, M. D.,

INSTRUCTOR IN NORMAL HISTOLOGY IN THE COLLEGE OF PHYSICIANS AND SURGEONS, N. Y.

[Continued from page 222.]

Thoma's blood-cell counter, Fig. 5, consists of a glass slide on the centre of which is cemented a square glass plate, P, having a circular opening 11 millimetres in diameter. In the centre of this chamber a circular glass plate, *c*, is cemented to the slide. This plate has a diameter of 5 millimetres, and on its free surface is engraved a grating 1 millimetre square, which is divided into 400 equal squares, Fig. 6. These squares are, by an additional system of double lines, divided into 25 groups of 16 squares each. The surface of the plate, P, is ground down so that the distance between the upper surface of *c* and the under surface of a cover-glass placed on P shall be exactly 1-10th of a millimetre. The cover-glass should be ground perfectly flat, and should be about 0.35 mm. thick.

A small drop of the diluted blood from the mixer is placed in the middle of the plate, *c*, (Fig. 6), and quickly covered. The drop should be of such a size that after being covered its edges will come to the edge of the central plate. The edge of the cover-glass is leaned against the chamber wall and slowly lowered until it comes in contact with the drop of blood, then it is allowed to drop quickly and is pressed gently on the walls of the chamber. The cover-glass is only to be handled with forceps. The preparation is now allowed to rest for a few moments so that the blood-cells can settle, and is then placed on the microscope and examined with a power of 30 to 70 to see—

EXPLANATION OF PLATE.

FIG. 5. Thoma's blood-cell counter.

FIG. 6. Field of Thoma's blood-cell counter.

FIG. 7. Thoma's Frog-plates.

FIG. 8. Inflation canulae.

1. That the cells are evenly distributed through the film.

2. That no air-bubbles or foreign matter is enclosed in the film.

If these conditions are fulfilled, the counting is to be made with a power of two hundred. The counting is to be made in a systematic manner.

The surface of one of the squares equals 1-400 of a square millimetre; the thickness of the film of blood is 1-10 of a millimetre; therefore, the cubic contents of one of the squares is $1-400 \times 1-10 = 1-4000$ of a cubic millimetre. If the dilution of the blood be represented by the proportion $1 : a$, and if in n squares there be found z cells, then, as the cubic contents of a square equals $\frac{1}{4000}$ of a cubic millimetre, the cubic contents of n squares equals $\frac{n}{4000}$ of a cubic millimetre; one cubic millimetre of diluted blood will contain $\frac{4000z}{n}$ cells, and a cubic millimetre of undiluted blood $\frac{4000az}{n}$ cells.

Having found in a dilution of blood of 1 to 200, 1215 cells in 150 squares we have $\frac{4000 \times 200 \times 1215}{150} = 6,480,000$ red cells in a cubic millimetre of undiluted blood.

For counting the white cells a dilution of the blood in the proportion of 1:10 is used, and a $\frac{3}{4}\%$ solution of hydric acetate employed for diluting in place of the 3% solution of sodium chloride. This solution destroys the red cells, leaving the white cells unaltered. The method of counting is the same as for the red cells.

Circulation of the Blood.—For studying the circulation of the blood the frog is the animal most commonly used. In order that the animal shall be perfectly quiet during the observation it is paralyzed with curara. A slight nick is made in the skin over the posterior portion of the head with a pair of scissors, and two or three drops of an aqueous solution of curara, 1 to 1200, are then injected into the dorsal lymph sac by means of a slender glass pipette introduced through the above nick. The exact amount of the solution to be used depends upon the quality of the curara and the size of the frog, and can only be determined by experiment. As a general rule, it is better to administer small doses at intervals of an hour until the animal becomes paralyzed. The action of the curara is to suspend all voluntary motion, while the vegetative functions continue, the necessary amount of oxygen being supplied by the cutaneous respiration.

On account of the thickness of the web of the frog's foot and of the presence of numerous pigmented connective tissue-cells, this portion of the animal has been abandoned for viewing the circulation, and in its place we make use of the thin mesentery, bladder, or lung.

An improvement has also been made on the old-fashioned frog plates. The most convenient forms now in use are those devised by Prof. Thoma of Dorpat, which are shown in Fig. 7. The centre plate is for the tongue; that on the left for the mesentery; that on the right for the bladder and lung. These plates consist of a bed-plate, *a*, of sheet brass, covered with a thin sheet of hard rubber. At *B* is an opening, which in the tongue-plate is rectangular, in the others, circular. These openings are covered with pieces of thick white glass, on which the organ to be

examined is placed. At a short distance from this glass plate runs the brass rim, *c, c, c*, seven millimetres high, which, by a proper inclination, conveys the irrigating fluid as it flows off the organ to the tubes, *d, d*, to which are attached rubber tubes leading to a vessel for receiving the waste fluid. The supports, *t*, are for holding the irrigating canulæ, *g*. They are pivoted to the plate, and move around a perpendicular axis. To the upper end is attached a short brass tube, split along its upper surface, which is tightened by a small thumb-screw. This is connected with the support by a hinged joint, allowing it to move on a horizontal axis. In this tube is placed the irrigating canula, *g*. One end of these canulæ is drawn out into capillary tubes, and various curves given them in order to meet the requirements of the various organs used. The tongue and mesentery plates are provided with two of the above-described supports. This is to allow of the use of two canulæ, one for irrigating the under and the other the upper surface of the organ. At *e* is a perpendicular rod for supporting the ring for holding the cover-glass. At each side of the plates [in the tongue-plate it is at the end] is a notched support, *k*, for holding the rubber tube attached to the canulæ introduced into the various organs for inflation, etc. Between the rim, *c, c, c*, and the glass plate, *B*, bits of cork are wedged for pinning out the organs.

For examining the circulation in the mesentery, male frogs are to be used so that the examiner may not be embarrassed with the ovaries. An incision is made through the skin on the side of the animal, from the pelvis nearly to the axilla. After all hemorrhage has ceased, the abdominal cavity is opened into by an incision from 10 to 20 millimetres in length. The animal is then placed on the frog-plate, and a coil of intestine is carefully drawn out with a pair of forceps over the glass plate so that it will fall upon the bits of cork, to which it is pinned, leaving the mesentery spread out on the glass plate.

The bladder requires care in its preparation on account of the thinness of its wall. A glass canula, *B*, Fig. 8, is filled with a $\frac{3}{4}\%$ solution of sodium chloride, and the rubber tube attached to the straight end is closed by inserting a bit of glass rod. The canula is now inserted into the cloaca, and the curved end directed forward into the bladder; it is held in place by a thread passed through the skin over the sacrum and tied around the canula. An incision, similar to that for the mesentery, is made in the side of the animal. The glass rod is removed from the end of the rubber tube, the latter raised slightly, so as the fluid will flow into the bladder, distending it. The animal is now placed on the frog-plate, and by gentle manipulation with the handle of a scalpel the bladder is brought upon the glass plate and further distended if necessary; the glass rod is now replaced in the end of the rubber tube and the latter fixed in the support, *k*, Fig. 7.

The lung is prepared for examination by inserting the canula, *A*, Fig. 8, into the glottis of the frog. It is held in position by a thread passed through the skin of the nose and tied around the constriction of the canula. An incision carried well into the axilla is made through the skin on the side of the animal, care being taken not to wound any of the large vessels. The thoracic cavity is then opened by an incision carried well down the side of the animal. The animal is now placed on the frog-plate and the lung distended by gently blowing through the

rubber tube and the inserting a bit of grass rod into its end to prevent the escape of the air. Then by gentle manipulation the distended lung is brought upon the plate, B, Fig. 7. The ring containing a cover-glass is then carefully lowered on the lung so as to produce a flat surface.

The frog-plate containing the animal prepared by one of the above

methods is then placed on the stage of the microscope. Sometimes it is found upon examination that a stasis has occurred in the blood current. This may be due to the shock of the operation or it may be caused by the abdominal walls compressing the organ. If this trouble be due to the first cause the circulation will soon be renewed; if to the latter, which may be determined after a lapse of a few minutes, it must be removed by enlarging the abdominal wound so as to relieve the pressure.

If the time of the observation is to be short, fifteen to twenty minutes, it will only

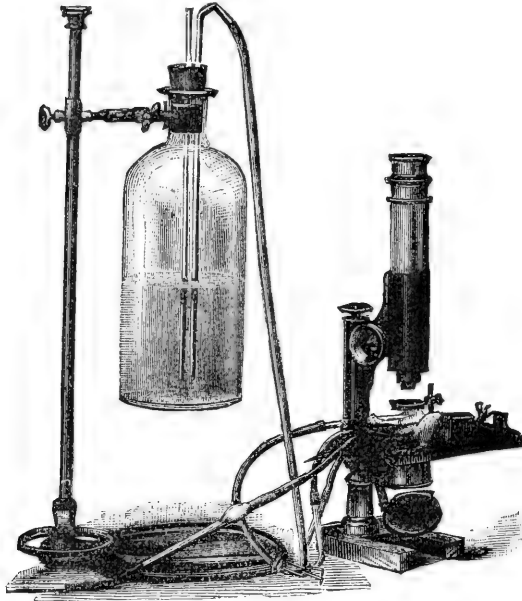

FIG. 9.—Frog-plate and Irrigating Apparatus.

be necessary to wet the exposed organ, from time to time, with normal salt solution. If this time is exceeded, then the animal is to be covered with a piece of filter-paper wet with the salt solution and the organ is irrigated with the same solution. The apparatus for irrigation is shown in Fig. 9. It consists of a litre bottle attached to a ring-stand, the bottle being about half filled with normal salt solution and its mouth closed with a rubber cork through which two glass tubes pass. To the curved tube is attached a long piece of rubber tubing, which is connected with the irrigating canula, *g*, Fig. 7; the straight tube is for regulating the pressure in the bottle, which may be varied by raising or lowering the tube. The flow of the irrigating fluid from the end of the canula should be by drops at short intervals, and is regulated by the pressure in the bottle, the size of the opening in the points of the canula, and if necessary by a screw clip placed on the rubber supply tube, the screw clip allowing the lumen of the tube to be regulated at will. By the use of this apparatus observations may be continued for hours if the animal is kept paralyzed by the administration of fresh doses of the curara.

Prof. Thoma has also devised a piece of apparatus for studying the

circulation in the mesentery of warm-blooded animals. This apparatus is shown in Fig. 10. It consists of a stout iron stand, with a wooden top $10 \times 19\frac{1}{2}$ inches, which forms the stage. The standard of the microscope is fitted to the frame and is held by a pin which enables one to remove it when necessary. On the wooden base-plate is a section of wood of the same size as the lower one. It is unattached, and can be moved about as desired. To maintain an approximate equilibrium, a cord and weight are attached to the front corners, the cords passing

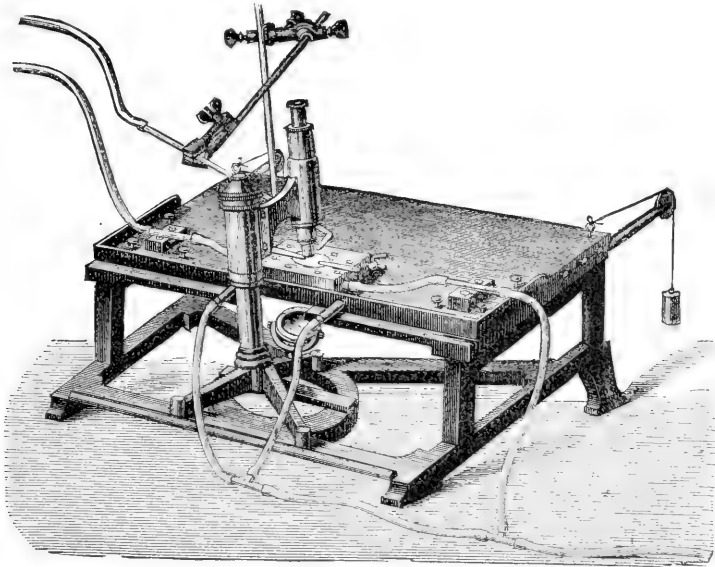

FIG. 10.—Thoma's Apparatus for Studying the Circulation in the Mesentery of Warm-blooded Animals.

over pulleys fastened to the lower plate. The lower plate has a horse-shoe opening and the upper a circular opening just below the body tube of the microscope. Over the opening in the upper plate is fixed the hot stage. This is a brass box $4\frac{1}{2} \times 2\frac{1}{2} \times 1$ inches with a circular opening for illumination, closed at the top and bottom by glass plates. Water at the proper temperature is conveyed into the box by the tube on the left, the waste being conveyed away by the tube on the right. A small cock on the right of the box allows the escape of air bubbles. The irrigating canula is supported by rod and clamp so arranged that the stream of fluid can be directed on the object. The stage having an inclination of 20° the waste fluid flows to the back of the stage and is directed toward the two "sewer tubes" by the raised ledge. For heating the water supply to the hot-stage the apparatus described by Schafer may be used.

King's Cements.—These cements and finishes are having an extensive sale, and are universally acceptable because they honestly answer all the purposes for which microscopical cements are needed. The red

“Lac. Cell and Finish” is especially adapted to deep cells, and the Transparent Cements and Zinc White to thin ones, as well as to finishing. It is no objection to them that they make very neat and handsome work. Dr. King will be glad to send sample bottles post free on receipt of advertised prices.

The Examination of Nostoc.

By H. N. CONSER,

NEW BERLIN, PA.

With the pond ooze collected in the search for desmids, one frequently, and almost certainly at this season, finds small, bright green gelatinous masses of a millimetre or less in diameter. This is a plant which is worthy of examination. Placing one of these on a slide and examining with low power, it appears to be a capsule of jelly filled with short green threads. This capsule is relatively thick and of considerable firmness, so that it needs to be picked apart with needles before the mass can be spread out for examination with higher power. This done, the threads which lie in curved and twisted forms resolve into beaded filaments. The cells composing these little rosaries will, on closer examination, be found filled with numerous fine grains, and many of them in a state of division. The larger cells at intervals are of a different kind. The protoplasm in these is homogeneous, nor are they capable of multiplication. These are the heterocysts or terminal cells, so called because the filament is usually terminated by such. It will be seen, too, that these heterocysts differ from the other cells in having thicker walls and being of yellowish brown color. Now run a little picric acid solution in under the cover-glass. The protoplasm will be fixed, and the granules become more distinct. Notice further the little hook on each side of the heterocyst where it joins the line of vegetative cells. Having washed out the picric acid well, apply methyl-green, which is so useful in detecting the nuclei of vegetable cells, and see that all except the heterocysts are distinctly and evenly colored by it. A nucleus cannot here be spoken of. The nuclear substance is, however, present, but in fine grains, evenly distributed. The division of the cells is such as found in other plants of like structure of cell—by constriction of the cell-wall, which latter, growing as a partition between the two halves, separates them into two united though functionally separate individuals.

The plant just considered is *Noctus ciniflorum*, belonging, with *Oscillaria*, to the few Schizophytes with other than colorless protoplasm. In this case the protoplasm is a bluish green, which gives to the order the name Cyanophyceæ. The nostocs are not without interest. This one often appears in great masses by sandy roadsides or garden walks in late autumn after a rain. Many people believe it to fall from the sky, being otherwise unable to account for its sudden appearance. In dry weather it shrinks to a brown film, but retaining its vitality expands with the next shower to begin anew its rapid multiplication. Other nostocs are interesting for their symbiotic relation to higher plants, constantly occurring in *Blasia*, one of the liverworts, in the *Azolla coroliniana*, and many others.

How to Draw Microscopic Objects.

By W. J. SIMMONS.

CALCUTTA, INDIA.

Objects may be viewed under the microscope in two ways. They may be looked at as one looks at the colored patterns formed in a kaleidoscope, or they may be observed scientifically. From an educational and practical point of view, perhaps, the surest way to learn how to observe an object as distinguished from merely "looking at" it, is to sit down and draw it. If this view of the matter be correct, it is obvious that the subjects dealt with in this paper lie at the very threshold of every real microscopist's training.

The subject of micrometric measuring should be dealt with by itself; the need for a knowledge of the method of ascertaining the size of minute objects—knowledge only to be acquired by actual and continued practice—is constantly cropping up in study and in work. Kent's Manual; Leidy's Monograph on Rhizopods; Pritchard's Infusoria (which includes Desmids, Diatoms, and Rotifers); Crookshank's Bacteriology; Wolle's book on Algæ; the Micrographic Dictionary, indeed, every standard work, constantly refers to size as a special feature in micro-organisms. Huxley's Practical Biology repeatedly requires the observer to draw and measure the organisms to which his attention is directed. In all these facts I find justification or specially dealing with what, to those who are familiar with them, and know their scientific value, may seem very elementary matters, to be safely relegated to the private study and perseverance of individuals.

Two or three who have discussed the point with me appear to hold that it is better to photograph objects than to draw them; and undoubtedly for certain purposes photography is invaluable. Perhaps it will avoid misconceptions later on if I at once say that for myself I agree with the learned President of the Asiatic Society in regarding photography as "the recording pencil of science in all its branches." You will, however, admit that it is indiscriminately faithful; it perpetuates details, such as dirt and extraneous matters, which may well be left out of a drawing accurate enough for all practical purposes. Photography does not compel you to look into and study your object, as distinguished from its picture, so thoroughly as you must do when you sit to draw it. Experience proves that, by drawing an object, one acquires a clearer and more lasting impression of its details than is likely to be obtained by photographing it. Again, photography involves the expenditure of more time and more money than many can spare. You will find, too, as a fact, that owing to the great simplicity of the adjustments required for drawing, a man is far more likely to utilize his skill as a draughtsman than he is to employ his skill as a photographer. The materials required for drawing occupy less space, are far less numerous, and require less provision to be made for them than the *impedimenta* of the photo-micrographic artist; and therefore, though I do not overlook the advantages in these respects of the dry-plate process, the ability to draw your objects is a handier accomplishment when travelling than the ability to photograph them. You must not infer from all this that I depreciate photo-micrography; far from it, but I consider it should run in double harness with drawing. It is useful to enable you or your

engraver to correct the inaccuracies of your drawings, and to complete them in respect to their details; but as a discipline for accurate observation, which is the first qualification of a microscopist, photo-micrography is inferior to drawing, and cannot be regarded as a substitute for it. I would therefore urge you to endeavor to draw as many objects as you conveniently can, the records you will thus secure are of far more practical value than many wordy descriptions.

In order to draw and measure microscopic objects, and to determine the magnifying power of a microscope, you need the following accessories:

(1) A camera lucida or some form of reflector. I use Beale's. (2) A stage micrometer, ruled to $\frac{1}{1000}$ ths and $\frac{1}{10000}$ ths of an inch. Many prefer the millimetre scale divided into 100ths and 1000ths; and there is much to commend this standard, which is meeting with increasing favor amongst microscopists, and indeed generally in all branches of science. (3) A foot rule with a scale divided into tenths of an inch; (4) and a pair of fine-pointed compasses.

The form of camera selected is not of much moment, and to some extent will depend on the nature of the work to be done. Objects, *e. g.*, in fluids which have to be drawn with the stage in the horizontal position will need a vertical camera, *i. e.*, a special form which can be used with the microscope in a perfectly upright position. The opticians offer several forms of this accessory. Mounted objects, however, and indeed many in fluids, with ordinary care and patience, are usually drawn with the body of the microscope laid in the horizontal. Which ever form of camera you select, be prepared to persevere in its use. Beale's neutral-tinted glass, which costs six or eight shillings, is a small disc of glass fitted in a light frame in which it is fixed at an angle of 45° to the axis of the microscope. The principle of its construction is a simple application of the law of reflection—that the angle of incidence is equal to the angle of reflection.

The micrometer is a slip of glass with a scale ruled on it, giving divisions sufficiently fine to be available for ascertaining the very minute dimensions of microscopic objects. Micrometers ruled to the millimetre scale are procurable. It will be sufficient if we confine ourselves to the English scale for 100ths and 1000ths of an inch. The micrometer may be laid on the stage like an ordinary object-slide, or it may be applied to the eye-piece, which, in the latter case, has to be specially adapted for its reception. I shall deal exclusively with the simpler stage-micrometer, which involves no alterations, and only costs 4s. 6d. If you know how to use this, with Beale's neutral-tinted glass, you can accurately measure all the objects you see, and you can without difficulty extend your accomplishments to the eye-piece micrometer and more expensive cameras later on. The foot rule and compasses need no special description.

The method of using the accessories I have just referred to will be most easily learned if I put a microscope in position for drawing. The instrument is placed horizontally, the objective focussed, and the light adjusted, the latter being an operation the best results of which can only be acquired by practice, and in daylight; the reflector is now substituted for the cap, and so turned as to admit of the image formed in it being projected, if I may so term it, on the table. If the light has

been properly adjusted you will see both the image and the point of your pencil, and you will have no difficulty in following the outlines of the object. You will find the whole process of drawing an object under the microscope becomes as simple as the tracing of a picture on a child's transparent slate. The shading and details can be readily filled in after you have sketched all the outlines. A curious reversal of the image takes place with Beale's reflector which is shown in *Science-Gossip* for 1883, p. 265. The effect of this for low powers can be corrected by turning the slide over on the stage. For high powers, the thickness of glass slides is too great, and the working distance of the lens too short, to admit of this device being resorted to, but by the time you have got to draw under high powers, you will have made sufficient advancement to be able to disregard the reversal of image which is inseparable from Beale's camera, and which is no doubt confusing to beginners.

It is scarcely necessary to say that these devices merely enable you to sketch rapidly, and with perfect accuracy, the relative proportions of an object, and to draw it to scale. A man who can draw will always turn out better finished sketches than a man who can't; but however much individual skill and tastes may differ, the great aim in microscopical drawing is, after all, simple accuracy, and this must be the chief study. "I take it," says a writer on the subject, "that the first requisite of a microscopical drawing is exactness and truth. Beauty is a secondary thing." (*Science-Gossip*, 1884, p. 18.) "No other branch of art," says another writer, "can be approached with a keener or deeper sense of the absolute necessity of close and conscientious observation. The fact must never be ignored that a few rapid lines from direct observation produced on the spur of the moment possess an interest of a most appreciable character. This acquirement is not beyond the capability of the meanest tyro, soon discovered and realized when he cultivates the habit of having a drawing block, pen, and pencil as adjuncts to his instrument." (*Science-Gossip*, 1883, p. 266.) I would only add that your proficiency as a draughtsman will entirely depend on your own perseverance, and on continued practice. There is no "royal road" to the acquirement of the art whose claims I urge on your attention; you must make your minds up to mount to success on failures beaten under foot.

Passing on now to micrometry—the measuring of microscopic objects—let me tell you Leeuwenhoek, the father of microscopical research, worked in this branch of our subject—a proof of the early recognition of its importance. His micrometric scales were grains of glass-grinders' sand, and hair from his own beard. He speaks of animalcules which were some thousand degrees less than a grain of such sand as he used. He also tells us that he had a plate of copper, with many lines engraved on it, dividing it into a number of small equal parts. Determining how many of these parts were covered by the diameter of a hair, he next compared the hair with the minute vessels, probably tracheæ, which he measured with the result, so he says, that the diameter of a hair was 450 times greater than that of the vessels measured by him. Such measurements are vague; but though our own precise methods are vastly in advance of Leeuwenhoek's, we must never forget that he did a great deal of really good work with the inferior appliances at his disposal—

an encouragement, I take it, to all who may be in earnest, but who for some reason are unfavorably situated. Let us now see how work is done with the appliances that the development of science which has occurred since Leeuwenhoek's age, has placed at our own disposal.

Retaining your microscope in the horizontal position used in drawing, substitute your micrometer for the object on the stage. Focus your microscope till the lines on the scale show clear and sharp, and then project them on the paper as you would any ordinary object. If your sketch is on the table, you can at once determine the exact size of the various parts of the object delineated by projecting the magnified scale on the drawing. Or you may reverse the process—and it is convenient to do so—by very carefully drawing the divisions of the magnified scale on an ink-ruled straight line on a card, which card you keep, noting on it the objective and eye-piece used, and the exact tube-length employed, in the delineation of your magnified scale. Using the same eye-piece and objective, and the same tube-length, you project the object itself on the card, and you can thus measure off the dimensions of its various parts with perfect accuracy on your ink-drawn scale. If your micrometer is ruled with a diagonal you can measure fractional parts, though this can always be determined with accuracy without a diagonal, *e. g.*, if the diameter of a diatom is one-half of the 1,000th of an inch it is equal to 1-2,000," and so on.

These remarks lead appropriately to the consideration of the third branch of my subject—how to ascertain the magnifying power of your microscope, for you must do this for yourself, and not accept off hand the tables of magnification given in the catalogues. To set about it, sketch the $\frac{1}{100}$ inch, or take your compasses and measure its image as you see it projected on paper, and then lay off the space so measured on a foot rule divided to a scale of *tenths* of an inch. If you find the $\frac{1}{100}$ " thus magnified is exactly = 1 inch, your microscope is obviously magnifying 100 diameters, because the $\frac{1}{100}$ of an inch is contained 100 times in one inch; if it is equal to 2 inches your microscope is magnifying 200 diameters; if to $\frac{5}{10}$ " it is magnifying 50 diameters; if to $\frac{2}{3}$ " it is magnifying 60 diameters. Briefly, the number of times the fraction of an inch, or metre, goes into the greatest diameter of the magnified image is equal to the number of diameters the microscope magnifies. If you wish to determine the power of your objective alone, I would refer you to the formula given in the last edition of Davis's *Practical Microscopy*.

The distance at which you place your eye-piece from the paper when ascertaining the magnifying power of a microscope, or in drawing objects, is sufficiently important to warrant a detailed notice. Three or four who have spoken to me on this subject have maintained that the distance should be a variable one, some urging that (1) the paper should be as far from the eye-piece as the eye-piece is from the stage; while others consider it should be (2) at such a distance as will secure the projection of a field exactly equal to the visual field, or (3) of an image exactly equal in *apparent size* to the image of the object as seen when looked at *through* the microscope. To those who adopt the first view, which is practically identical with the third, I would point out that the distance between the eye-glass and the stage varies with every change in the eye-piece or in the tube-length; that it is not identical in the case

of any two microscopes, and that it is a factor to which others have no reference. Moreover, all who wear spectacles for "long sight" know that the focus, and, therefore, the distance between the eye-glass and the stage, depends slightly on whether the observer wears or dispenses with his spectacles. And I would remind those who attach special importance to the diameter of the field that this feature is dependent not on tube length, nor on the power of the objective, nor of the combination of eye-piece and objective, but simply on one particular lens in the ocular, *viz.*, on the field glass, so called because it determines the dimensions of the field. As to the *apparent size* of the object. I shall show directly on what this depends; that it is a constant for a given combination (of eye-piece and objective) and a given tube-length; and that the *apparent size* itself bears no relation to the distance of projection. *i. e.*, to the space between eye-glass and paper.

The desirability of having a fixed rather than a varying distance as a standard is obvious: though the *magnification* of the sketch of object may be increased in proportion to its distance from the eye-piece, the *magnifying power* of the microscope will not vary. The apparent size of the image depends not on the nearness or remoteness of the paper; but, as in ordinary vision, it has to be measured by the angle which the thing seen, or image, subtends at the eye, and this angle remains constant whatever may be the distance of the paper. To give a concrete example. Using an Economic $\frac{1}{2}$ -inch on my "Star" stand, the draw-tube closed, and the A eye-piece at three feet from the table, the $\frac{1}{100}$ inch is projected by Beale's reflector to an extent which measures so nearly 3" that we may fix it at 3"; at 2 feet it occupies a space of 2"; at 1 foot of 1"; at 10" of a trifle over $\frac{8}{10}$ "; at 6" of half an inch; at 3" of one-quarter of an inch. You will already see a law underlying these measurements with which we need not trouble ourselves in a practical paper; though I shall show you directly how to apply it for enlarging and reducing drawings. At the surface of the reflector itself, the projected image of $\frac{1}{100}$ "—indeed every object viewed—as may be shown by diagram, almost occupies the immeasurable space of a mere vanishing point, be the power of the objective what it may. During all these variations of distance the *apparent size* of the magnified $\frac{1}{100}$ " remains the same. Why? Because the angle it subtends at the eye does not vary, though you may vary the distance of projection. It is obvious from this that it is necessary to fix on a standard distance, which will be of practical value to observers all the world over; it is equally obvious that the varying standards we have discussed in the preceding paragraph may safely be rejected. The question is, what standard should be substituted for them? Ten inches has been adopted in preference to any more arbitrary distance, by analogy to the average focal length of the human eye, which is ten inches. This standard of distance is preferable in practical microscopy to any variable standard dependent on the sight of the individual observer; or the distance at a given time of the eye-glass of a given ocular, from the stage of a given microscope; or the field-determining power of a given field-glass.

If, however, you desire for any reason to use varying standards of height, then you ought in every case to draw a micrometric scale alongside of each object you sketch, projecting that scale carefully for each

observation. It is sometimes desirable to use a long standard distance, *e. g.*, in drawing objects under the microscope for illustrating a paper or a lecture. Another instance in which you may with advantage place your ocular about two feet above the table is in measuring minute objects, such as blood corpuscles, or the cells of the yeast-plant, with a 1-6" objective, or one of Zeiss's D's. Here, by projecting a large image, you can obtain more reliable average measurements than if the standard of 10" were adhered to. You may, on the other hand, wish to have your sketch on a smaller scale than is to be secured by drawings at the standard distance of 10 inches. Small sketches are sometimes desirable in publishing illustrations. All you have to do is to bring your eye-piece nearer to your paper until you attain the required dimensions. You can in this way apply the law I referred to, and make your sketches exactly double or treble, or exactly half or a quarter of the size secured at the standard distance. An engraver can, of course, enlarge or reduce a drawing, but by adopting the methods I describe, you avoid all errors in proportion of parts which might be introduced in an enlarged or reduced sketch, for you draw direct from the object itself. The inconvenience of being always able to secure the precise distance of 10" is easily disposed of by getting a stand, which will cost you only a few annas, and last forever. Cut a cube of teak, or other heavy wood, to a height which, added to the distance of the centre of your eye-glass from the table when the tube is placed in the horizontal position used in drawing, will give a total of ten inches from eye-piece to paper. It would be a move in the right direction if microscope makers put their instruments up in cases which could be utilized as stands for securing the 10-inch distance in drawing and micrometry. You will find the block I have described come in handily for many purposes when you have it made; one that I have, of a special pattern, does duty for a drawing stand, a dissecting microscope, and an apparatus for hardening balsam in balsam mounts. Moreover, by always having such a block beside you, you will make more measurements and draw more of your objects than you would if you had to find the standard height for each sitting.

You will find it convenient to make a table giving the magnifying power of each of your objectives with each ocular, and for different fixed tube-lengths. You are thus enabled, without constantly referring to the micrometer, to specify (as you always should) the magnifying power employed in your different sketches; it should be noted beside the sketch thus, $\times 150$, which means that the sketch has been drawn with a power of 150 diameters. In this connection I may tell you that in noting or speaking of the magnifying power of a microscope you should always refer to the *number of diameters* it magnifies. More meaning is conveyed when you say a microscope magnifies 100 diameters than when you vaguely say it magnifies 10,000 times. You cannot expect people to work out sums in square root whenever you tell them your microscope magnifies so many times.

Again, there are two terms in microscopy which should be carefully defined in our own minds, and which should be carefully employed: I refer to the terms *magnification*, or amplification, and *magnifying power*. By *magnification*, or amplification, is meant the relation between the real size of an object and of its image when projected by any

form of camera, placed at any distance from the table. By *magnifying power* is meant that special degree of magnification, and no other, which is secured when the camera is placed at the standard distance of ten inches from the paper. If the term "magnifying power" be thus restricted in its use there can be no doubt as to what is meant when it is employed, and therefore no room for discussion on the subject.

Let me urge you to draw all your objects, at any rate all those whose beauty or novelty may strike you. The illustrations thus made often help you to identify an object long after it is drawn, and to keep a reliable record of your work. You will find it useful to make a short note of the locality and date from and on which your object was obtained. There is a freshness and accuracy in such memoranda which compensate for the little additional trouble incidental to making them. As an auxiliary to work I am convinced that "the pencil is being unwisely neglected;" and when the relative advantages of drawing *vs.* photograph are dispassionately compared, every microscopist will admit that, for the busy worker, the sketch on paper is, after all, in the present state of development of photo-micrography, the more convenient and the more economical of the two. Moreover, the most serviceable field for photography lies at the extremes of the table of amplification, with very low (20 to 70 diam.) and with very high powers (500 to 1,500 diam.), and the field for general work except on special subjects, lies in powers ranging from, say, 100 to 450 diameters.

As the references to the subjects treated in this paper are widely scattered, I subjoin a list of a few articles culled from the journals to which I have had access, and from which I have derived assistance, as well in actual work as in the preparation of this paper. I omit such treatises as Carpenter on *The Microscope*, Beale's *How to work with the Microscope*, Davis' *Practical Microscopy*, Hogg's popular book, etc., because, though they all contain valuable information on the subject, they are readily available to most of us.

(1) *American Monthly Microscopical Journal*: Vol. II, 75, 175; III, 134, 158; V, 21, 207; VIII, 215; IX, 103, 106.

(2) *Science Gossip*: Vol. II, p. 113; V, 87; VI, 230; XIV, 175; XV, 62; XVI, 183; XVIII, 1, 39, 49, 74, 97, 230; XIX, 66, 193, 265; XX, 17, 41; XXIII, 163.

Uses of the Microscope in Medicine.*

By W. D. BIDWELL, M. D.,

LEAVENWORTH, KANSAS.

It is only within the past few years that the microscope has formed a part of a physician's armamentarium, and even now a large proportion are without it and unaware of the many purposes for which it may be employed. We may therefore run over briefly what may be accomplished over and above the results of former microscopic work by the use of the instrument. To give methods of preparation of the various substances here mentioned, or even to describe their appearances, would occupy too much space in this article.

With the microscope we are able to count the number of corpuscles in a given quantity of blood, and determine the proportion of red to

* Read before the Leavenworth Microscopical Society, Aug. 20, 1889.

white, and while the value of such information is not fully determined, yet it is generally conceded that the red globules are in excess where the circulation is retarded, whereas their number is decreased in prolonged fevers, in cachectic conditions generally, and after hemorrhages. Their size, also, is subject to considerable variation, being increased in chlorosis while in cancer it is diminished. The white corpuscles are relatively increased in number after hemorrhages and in diseased processes of the lymph glands.

The parasites of the blood are not often sought for in general practice, but in certain cases the bacilli of anthrax, and of malaria, the *filaria sanguinis hominis*, and the spirillum of relapsing fever may be observed.

Often it is only by the microscope revealing bone-cells in pus that it is possible to decide whether an abscess is connected with bone or not. Glycerine or a weak solution of potash will clear up the pus for such examination. Epithelial cells from the kidneys or urinary passages may indicate the source of pus from a sinus, or the connection of a fistulous opening with the stomach or intestine may be shown by the character of the cells or by food mixed with pus. *Echinococcus* cysts may be diagnosed from the presence of hooklets, suckers, or other portions of the parasite mixed with pus.

Actinomycosis is detected by discovering portions of the fungus in scrapings from the surface of a suspected growth.

Differential diagnoses as to the nature of abscesses can also be made, the micrococcus *pyogenes tenuis* indicating benign abscesses, and the streptococcus *pyogenes* indicating slow inflammatory processes affecting the lymphatics, while in cases of rapid suppuration the staphylococcus predominates. It has been hoped that microscopic examination would detect a micro-organism peculiar to diphtheria, but so far the appearance of croupous and diphtheritic patches is identical.

From the examination of sputum assistance is obtained in the diagnosis of tuberculosis, catarrhal, or suppurative conditions of the lungs, thrush (*oidium albicans*), actinomycosis, and other diseases. Hemorrhages of the stomach, cancer of this organ, and dyspepsia, also exhibit their individual characteristics to the microscope.

In the *fœces* we may find almost any animal or vegetable substance, and it is only by a preponderance of one over others that much information can be derived from this source. The presence of mucus in the discharges suggests a diseased condition, but does not help in differentiating unless it occurs with blood, as in dysentery, or in casts of the intestines, as in pseudo-membranous enteritis. Ova of the various parasites inhabiting the intestines are frequently found in passages from the bowels.

In the substance of the muscles may be found the trichinæ spirales, while on the surface of the skin the microscope enables us to study the *acarus scabiei* or itch insect, showing that the itching is due to the young parasites, often numbering as high as forty in a single burrow, as they follow the crevices in the skin, till finally they perforate it. Herpes tonsurans is shown to be due to a fungus growth, as is also sycosis and favus.

But it is when we come to urinary examination that we approach the most frequent use of the microscope in clinical medicine. The pres-

ence of epithelium, blood, casts, and crystals of varying shape and composition, enables us to decide between a healthy condition of the kidneys, bladder, and urethra, and the various forms of inflammation to which they are subject. It would be tedious and a useless repetition to mention here the character of urinary sediments in acute and chronic Bright's disease, in cystitis, gonorrhœa, calculus, spermatorrhœa, and the like, but the value attaching to these examinations is made evident by the requirement of all first-class insurance companies that microscopical examination be made of the urine in every application for insurance for a large amount or where there is any reason for suspecting disease of the urinary or generative organs.

With all the uses to which the microscope is now put, we are but in the infancy of its employment. The thousands of experiments that are being made relative to cholera, yellow fever, typhoid fever, and many other diseases, will necessarily result in better means of diagnosis and treatment, and the microscope, the great instrument of precision, will eventually be more valuable to and more universally employed by the medical profession than any other instrument in his equipment.

MEDICAL MICROSCOPY.*

Bacteria and Disease.—The following provisional table is intended to show the present status of bacteriological investigation with reference to the causation of some of the more important diseases.

1. *Diseases whose bacterial cause is determined with comparative certainty:*

Anthrax, caused by *Bacillus anthracis*.

Aphtha, caused by *Oidium albicans*.

Cholera, caused by *Comma bacillus*.

Erysipelas, caused by *Streptococcus erysipelatosus*.

Gonorrhœa, caused by the *Gonococcus*.

Leprosy, caused by the *Lepra bacillus*.

Malarial fever, caused by *Bacillus malarie*.

Meningitis (Epidemic cerebro-spinal), caused by *Diplococcus lanceolatus*.

Pertussis, caused by a *Bacillus*.

Pneumonia, caused by *Diplococcus pneumoniae*.

Purpura, caused by *Monas hæmorrhagica*.

Pyæmia, caused by *Streptococcus pyogenes*.

Relapsing fever, caused by a *Spirilla*.

Tetanus, caused by a "pin-head" *Bacillus*.

Tuberculosis, caused by the tubercle *Bacillus*.

Typhoid fever, caused by *Bacillus typhosus*.

Typhus fever, caused by a *Bacillus*.

2. *Diseases probably bacterial, but whose exciting cause has not been certainly determined:*

Carcinoma, Dengue, Diphtheria, Dysentery, Gangrene, Glanders, Measles, Parotitis, Rabies, Rheumatism, Rôtheln, Scarletina, Syphilis, Yellow Fever.

* This department is conducted by F. Blanchard, M. D.

It is probable that all catarrhal diseases, such as Bronchitis, Conjunctivitis, Diarrhœa, etc., are of bacterial origin, and that various bacteria are engaged as causative factors in different varieties of these several diseases. These have been isolated with varying degrees of certainty.

With regard to Diphtheria, it is probable that two or more diseases are included under this name, and that more than one bacterium is capable of inducing the formation of pseudo-membrane.

— 0 —

A Hitherto Undescribed Disease of the Ovary.—The leading article in the *New York Medical Journal* for September 28, 1889, is from the pen of Dr. Mary A. Dixon Jones, of Brooklyn. Therein she describes a disease of the ovary, thus far unrecognized by morbid histologists. This disease, or tumour, can hardly be said to have an established name. In the title of the paper it is spoken of as “Endothelioma, changing to Angeioma and Hæmatoma.”

The name Kirsoma has been proposed on account of the peculiar convolutions that are manifested. She gives the clinical history of twelve cases in which she removed the ovaries on account of this disease, the diagnosis having been confirmed by subsequent microscopic examination. These cases all were operated upon, mainly at the Woman's Hospital, in Brooklyn, during 1887 and 1888. It would seem, therefore, that the disease is not unfrequent; but has hitherto been called by other names—alveolar sarcoma, for example.

The symptoms of the disease are:—a special and characteristic pain in the region of the ovaries, at times severe, sharp, and lancinating; a peculiar pale or cachectic look, like the pallor of the consumptive; and marked emaciation. The symptoms are so marked that a diagnosis can usually be made with confidence.

Sterility is an almost invariable result, from the fact that the neoplasm usually encroaches upon and destroys the ova, and, indeed, in time the whole normal structure of the ovary.

The cachexia developed is compared to that of carcinoma, and the author suggests that the growth *may* be malignant.

Microscopical sections of an ovary affected with this disease, submitted to Prudden, of New York, and to Waldeyer, of Berlin, were pronounced carcinoma.

But the author asserts that the growth is “*a new formation of blood-vessels and blood-corpuscles.*”

If we understand rightly her theory of the morbid change, it is as follows:—beginning in the walls of menstrual follicles, there is a retrograde metamorphosis of connective tissue elements whereby they take on their embryonal condition, causing the reëappearance of medullary corpuscles—the bodies described by Theodore Schwann, in 1839, as blood cells, and by C. Heitzman, in 1872, as hæmatoblasts. These corpuscles rapidly proliferate, and may destroy and occupy the place of all the normal structures of the ovary, the medullary corpuscles becoming blood-corpuscles, and these, by fusion of their hæmatoblastic substance, forming the walls of new blood-vessels.

There is no apparent augmentation of the volume of the diseased ovary. Sometimes it is really diminished in size.

The paper is illustrated by ten well-drawn cuts showing sections of “endotheliomata” at various stages, magnified $\times 25, 100, 300,$ and $600.$

BIOLOGICAL NOTES.*

The Bacillus of Glanders is destroyed by an exposure for five minutes to a five per cent. solution of carbolic acid or a $\frac{1}{500}$ per cent. solution of corrosive sublimate. Every article used around horses having the disease should be disinfected with one of these germicides or exposed to boiling water or steam at a temperature of 212° F. for half an hour.

Home Health.—While the death of thousands all over the land from typhoid fever is fresh in the minds of those who are spared, why not take measures to abolish the closets and filth-pools around our country and village homes, substituting for them hygienic earth-closets and disinfected cesspools, which can be made by any one "handy with tools" at a trifling expense, and thus save the lives of thousands another summer.

Typhus bacilli in water.—Several cases of typhoid fever have recently occurred in a town in the province of Baden, Germany, and it came to light that three of the patients first affected procured their drinking water from the same well. The water was then examined, the strictest precautions being used to prevent infection from other sources. In three days the cultures were found to have developed, on an average, one hundred and forty thousand colonies to the cubic centimetre. Ten tests had been made, but only in one of these was there found a single colony of typhoid bacilli.

Purity of Wells.—Dr. Carl Fronkel has undertaken to test the comparative purity of tube-wells and the ordinary or open wells. He reports in *Zeitschrift für Hygiene*, as the result of his experiments, that tube-wells are almost entirely free from such organisms as come from surface impurities, but that certain micro-organisms are found to grow upon the surface of the tubes. The destruction of these organisms can be secured by brushing the inside of the tubes and immediately pumping out the disturbed water or by use of a concentrated solution of carbolic acid and sulphuric acid for a day or two, followed by a thorough pumping of the well before the water is used. The ordinary well is much more liable to contamination from sources of impurity, and disinfection is impossible. This shows the great advantage of tube-wells over the ordinary sort for purposes of drink supply.

Dr. Brown-Sequard's new discovery.—The newspaper reports of the interesting and important discovery of Dr. Brown-Sequard are at once amusing and exasperating. One would suppose that he had discovered a substance which he has called and believes to be a veritable "elixir of life," whereas this is not the case, this name and idea both being the fictions of the reporters. What he claims to have discovered is that when the fluid expressed from certain glands of young animals is injected into the blood of men who have become worn out from age or other causes they had their vigor suddenly and greatly increased. These results have been confirmed also by M. Variot. And now some ignoramus tries the experiment in a crude way upon some crank who is foolish enough to ask it. Death is the result, and Dr. Brown-Sequard is berated for it all. Notwithstanding the criminal dabbling on the part of tyros, this promises to be one of the most interesting biological discoveries of this marvellous age.

* This department is conducted by Prof. J. H. Pillsbury.

English Approval.—*Nature*, for July 18, has a very complimentary notice of the organization and work of the Marine Biological Laboratory at Woods Holl, in which American biologists are cordially congratulated upon the inauguration of so ideal a scheme as this is considered to be.

Nucleus Division.—Mr. Douglas H. Campbell contributes to the *Botanical Gazette* for August a brief article describing an easy method of observing this interesting process in the pollen mother cells of *Allium canadense* and *Podophyllum peltatum*. "Young buds must be used, in *Allium* about 2 mm. in length; in *Podophyllum*, buds were gathered as soon as the plants appeared above ground. In the former case the young anthers were crushed carefully in a drop of acetic acid and water ($\frac{1}{2}$ acetic acid and $\frac{1}{2}$ distilled water). With *Podophyllum*, cross-sections of the whole bud were made, and the sections of the anthers teased out in the same solution as in the case of the *Allium*. The pollen mother cells are at once recognizable by their thick colorless walls, and it is easy to tell with a low power whether or not the desired division stages are present. If this is the case they may be stained with acetic methyl-green, or, better, gentian-violet. In preparing the latter the best results were had by first mixing two parts of distilled water and one of acetic acid. To this mixture a sufficient quantity of saturated alcoholic solution of gentian-violet is added to give it a deep violet color. If a small drop of this mixture is now added to the preparation containing the pollen cells, the nuclei will be almost instantly colored a deep blue-purple, while the protoplasm remains colorless and uncontracted. The coloring fluid may now be carefully removed with blotting-paper, * * * and the preparation mounted in dilute glycerine, which must be added very gradually to prevent contraction of the protoplasm."

A New Yeast.—Dr. W. Zopf, of Berlin, is reported to have discovered a new species of *Saccharomyces*, to which he has given the specific name *hansenii*, in honor of the distinguished botanist, Dr. Hansen, of the Erlangen Botanical Institute. This yeast differs from the common yeast *S. cerevisiæ* in that it produces oxalic acid instead of alcohol from the sugars of fruits, vegetables, and milk. It is said to produce ascospores similar to *S. cerevisiæ* but in smaller numbers.

Artificial Silk.—Visitors at the Paris Exposition report an exhibit of rare interest illustrating the progressive spirit of modern invention and the value of scientific discovery to practical industry. This is nothing less than the process of making artificial silk. The process consists in reducing ordinary cellulose, as wood fibre or cotton, to pyroxyline by treating it with sulphuric and nitric acids. This product, dissolved in a mixture of alcohol and ether, is familiarly known as collodion. The process of manufacture of the fibre consists in forcing this liquid solution through very fine tubes into water, which hardens it at once, forming a flexible fibre. In order to render this uninflammable, it is treated by a secret process, after which it is colored any color desired and woven into fabric. This silk is said to compare favorably with natural silk both in brilliancy and durability. The numerous diseases which have rendered silk culture so difficult will greatly increase the importance of this enterprise if it should prove practicable.

BACTERIOLOGY.*

Kühne's Methylene-Blue Method of Staining Bacteria.—This method is especially recommended for staining bacteria in sections of animal tissues, although it is equally applicable to cover-glass preparations made from fresh tissues. The usual differences in the method of staining cover-glass preparations and sections are to be observed.

The advantages to be derived from this method are found in its being applicable to all known forms of bacteria. It eliminates the use of special stains for certain micro-organisms where only their presence is to be demonstrated. It possesses superior powers of differentiations between bacteria and the tissue elements. The method as given by Dr. Kühne† is essentially as follows:

The sections which have been cut by the ordinary method (although Dr. Kühne recommends the freezing microtome for this purpose) are transferred directly from alcohol to a watch-glass containing carbol-methylene-blue (1). The sections should remain in this staining fluid for about one-half hour. Some bacteria, such as the bacillus of leprosy, requiring a longer time, one to two hours. If the sections remain in the staining fluid for a much longer period the differentiation between the germs and tissue elements becomes more difficult.

After staining for the desired length of time, the exact period of which will have to be determined by test experiments for the different germs and tissues, the sections are rinsed in clear water and then placed in acidulated water (2) until they become a pale blue. They are then washed in a weak, watery solution of carbonate of lithium (3) and again placed in clear water. This part of the procedure is very important, and to insure good results should be performed with much care. The time that the sections should remain in the decolorizing agents varies with their thickness, histological structure, and the intensity of the stain, making it impossible to give any definite rule to be followed. The degree of decolorization can be very nearly determined at any moment by moving the sections about in the fluid by means of a glass rod. If the section is very thin or if there are other reasons why it should take up very little of the stain a momentary immersion in the acidulated water is sufficient. In all cases where the staining process is completed the sections should have a pale blue color, for if darker the over-stained corpuscles and cell nuclei of the tissue would obscure the bacteria. In cases where it is feared that too much color has been removed in the acid a drop of a saturated watery solution of methylene-blue should be added to the lithium water.

After the sections have remained in the water for some minutes they are dehydrated in absolute alcohol in which, in difficult cases, a little methylene-blue may be dissolved, and then transferred to a watch-glass containing methylene-blue aniline oil (4). The sections can be dehydrated in the alcohol without injury to the stained bacteria. The sections are now transferred to pure aniline oil, in which they are rinsed, and then placed in some essential oil, as turpentine, where they

* This Department is conducted by V. A. Moore.

† Kühne, *Praktische Anleitung zum mikroskopischen Nachweis der Bakterien im tierischen Gewebe*, p. 15.

should remain for two minutes. In order that the sections should be perfectly cleared they are transferred from the turpentine to xylol, from which they are mounted in balsam. It is recommended that the sections should pass successively through two xylol baths in order to secure absolute elimination of the aniline oil. The xylol may be used for a considerable number of sections.

Dr. Kühne employs a glass rod for transferring the sections from one solution to another instead of the ordinary spatula or section lifter. The end of a small glass rod is immersed in the fluid containing the section, which is allowed to fold itself over the rod, and in this position it is lifted from the fluid. The end of the rod is then gently immersed in the second liquid, where the section unfolds itself from the rod and floats upon the surface. In this way the danger of tearing them is diminished and the time required for their transfer from solution to solution is much shortened. This is an important consideration where a large number of sections are to be stained.

(1) *Carbol-methylene-blue*.—This is prepared by grinding in a mortar 1.5 grams of methylene-blue with 10 c.c. of absolute alcohol until dissolved; 100 c.c. of 5% carbolic acid is gradually added and thoroughly mixed with the alcoholic solution. The resulting liquid is preserved in a well-stoppered bottle until used. When only a small quantity is to be employed it is better to prepare only a half, or a quarter even, of the above quantity, as its staining power is diminished by long standing. It should always be *filtered* before using.

(2) *Weak acidulated water*.—To 500 c.c. of distilled water add 10 drops of nitric acid.

(3) *Lithium water*.—To 10 c.c. of distilled water add from 6 to 8 drops of a saturated watery solution of carbonate of lithium. The saturated solution may be used as a decolorizing agent in sections with over-stained nuclei.

(4) *Methylene-blue aniline oil*.—About one-half gram of methylene-blue is ground in a mortar with 10 c.c. of pure aniline oil. When the oil is saturated with the coloring matter the entire mass is poured unfiltered into a vial, where the undissolved coloring matter will settle, leaving the saturated supernatant oil clear. To a watch-glass of pure aniline oil add a few drops of the saturated methylene-blue oil until the degree of colorization desired is obtained.

—o—

Kühne's Modification of the Koch-Ehrlich Method of Staining Tubercle Bacilli.*—The sections of tissue containing the bacilli are stained for ten minutes in carbol-fuchsin (5) decolorized in a 30% solution of nitric acid and then washed in 60% alcohol until they have a rose color. From the alcohol they are transferred to a glass containing a considerable quantity of water to remove any of the acid that might have remained in the section. The sections are now dehydrated in absolute alcohol for three minutes, then placed in a solution of methyl-green aniline oil (6), diluted one-half with pure aniline oil, and allowed to remain in it for from five to ten minutes. From this they are placed for two minutes in some essential oil, from which they

* *Ibid.*, p. 30.

are carried successively through two baths of xylol and mounted in balsam. The tissue elements are stained in the methyl-green aniline oil, but the intensity of the stain cannot be determined until after the sections have passed through the essential oil and xylol. If the tissues are then found to be too feebly stained, they may be transferred back to the methyl-green aniline oil for some minutes until the desired intensity is obtained.

By this method the tissue elements are clearly differentiated from the sharply and delicately stained bacilli. If an after stain of methylene-blue is desired the sections may be transferred from the alcohol to a weak solution of alkaline methylene-blue. After staining in this for from five to ten minutes they are rinsed in weak, dehydrated in strong alcohol, cleared, and mounted in the usual way.

(5) *Carbol-fuchsin*.—Fuchsin 1 gram, absolute alcohol 10 c.c., 5% solution of carbolic acid 100 c.c.

(6) *Methylene-green aniline oil*.—This is prepared in the same manner as the methylene-blue aniline oil by substituting the methyl-green for the methylene-blue.

EDITORIAL.

The Microscope.—Our esteemed contemporary, which, being nearly as old as this periodical, is doubtless known to all our readers, after being ably conducted for a number of years by Dr. Manton and others, of Detroit, has migrated to the East in search of wise men. It was not necessary to find but one to take charge of its columns, when such a man as Dr. Alfred C. Stokes is at hand. He, too, needs no introduction to any microscopist in the United States or Europe. Many times he has favored us with his contributions, and if he does not continue to do so we may, perhaps, extract some of his writings from his new journal. The Doctor's "Microscopy for Beginners," which was published two years ago, has had a large sale and is on our shelves for constant reference. The transactions of the Trenton Natural History Society have been greatly enriched by the Doctor's contributions. He has an easy flow of language, is not disposed to conceal his knowledge from common people, and has a large sympathy for amateurs. We welcome him most heartily and sincerely to the editorial ranks, and bespeak for him that kindness which the microscopical readers have always shown to ourselves.

Two Energetic Microscopists.—There are two men who are prominent in our branch of science whose career we watch with much interest. Their names are Dr. W. J. Lewis, of Hartford, Conn., and Dr. Frank L. James, of St. Louis, Mo. The former has been president of the American Society, and the latter deserves to be made president next year. It is rare that so young men attain such prominence, and it argues in this instance many years of contribution to this science, if their lives are spared, as we hope will be the case.

Perhaps the above is a sufficient apology for the remarkable error we made in the October number, page 236 (14th line from bottom), where some able remarks are credited to the former, whereas they should have been reported as by the latter, viz: by Dr. James. Will our readers please note the correction?

OBITUARY NOTICES.

F. S. Newcomer, M. D., of Indianapolis, Ind., died September 13, at Lake Bluff, Ill. Dr. Newcomer was a noble man, loved and respected most by those who knew him best. He was a charter member of the American Society of Microscopists, and also a member of the Royal Microscopical Society of London. Many valuable and beautiful specimens of his handiwork have been contributed to the cause of science. He leaves a wife and three children.

Benjamin Braman, of New York, died January 20, 1889, after a long illness. In 1879 he became a member of the New York Microscopical Society, and during 1883 and 1884 served as its president. In 1884 and 1885 he edited its *Journal*. Prof. Braman paid especial attention to mental philosophy and the science of perspective, ancient literature, and botanical physiology, and, although performing no original work, he was instrumental in disseminating much valuable knowledge through the medium of his lectures. His life was pure and unselfish, child-like in its reverence for matters of faith and religion, and presented an example which was as effective in the promotion of good among his fellows as were his intellectual labors successful in imparting knowledge. The *Journal of the New York Microscopical Society* for July, 1889, contains an excellent likeness of Prof. Benjamin Braman.

NOTICES OF BOOKS.

Myers' General History. By P. V. N. Myers, President of Belmont College. Ginn & Co., Boston. 8°, pp. 759.

This book is based upon the author's *Ancient History and Medieval and Modern History*. The difficult task which the author set for himself, of compressing the fourteen hundred or more pages comprising the two text-books mentioned into a single volume of about seven hundred pages has been accomplished without serious impairment either of the interest or of the easy flow of the narration. The greatest care has been taken to verify every statement and to give the latest results of discovery and criticism.

Most general historians have based their opening chapters upon what they could find in Genesis. This author has shown his ability to write ancient history from a scholar's standpoint, and hence does not come to the Hebrews until page 63. He frankly says we do not know when man came into possession of the earth. The same good sense is displayed all through.

The book is designed simply for class-room use and presupposes a knowledge of American History. Hence the history of our own and sister nations of the western hemisphere is omitted. The book is consequently a history of European and Eastern nations from the earliest to the present time. That ground is well covered, and we take no exception to the limitation in a text-book prepared for the use above indicated. But we think the title, "General History," better be reserved for a resumé of the history of the whole world, *including the Western continent*. We hardly want to concede that a History of European and Eastern Nations is a "General History."

The book is provided with thirty colored maps, nearly two hundred sketch-maps, and woodcuts, drawn from the most authentic sources. The illustrations are extremely valuable.

Elements of Histology. By E. Klein, M. D. 12mo. 368 pp. 194 illustrations. Lea Brothers & Co., Phila.

During the present year a new and enlarged edition of this standard work has been issued, making it by far the best hand-book of histology extant. The constant advance in our knowledge of this science has permitted important additions to the volume. Some of these relate to the division of the nucleus, the termination of nerves in the epithelium and epidermis, as well as the absorption of chyle by the mucus membrane of the small intestine. Rollett's views on the structure of striped muscular tissues are adopted. Nearly all the organs of the body have received attention, and their structure not only described but figured.

The illustrations alone in this volume should awaken the highest enthusiasm in microscopical circles. Every one of the one hundred and ninety-four figures is clear, distinct, properly described, and artistically drawn. But especial mention must be made of the new photo-micrographs taken by Mr. Andrew Pringle, and illustrative of the following topics: Section of the adipose layer of the skin showing fat cells ($\times 40$); intermediate cartilage of femur of a fœtus; section of medulla oblongata ($\times 150$); section of tooth of a guinea-pig ($\times 150$); early development of a tooth; the tongue of a cat with blood vessels injected; papilla foliata of a rabbit, showing taste buds ($\times 40$); section through taste organ; section through trachea of a fœtus ($\times 40$); net-work of capillary blood-vessels surrounding the alveoli of lung.

The type is new and clean, the paper of good quality, the binding in a red cloth to correspond with the stained and polished edges. A good index closes the volume.

Annual of the Universal Medical Sciences. Edited by Charles E. Sajous. F. A. Davis, publisher, Philadelphia, New York, and London. Five vols. 8vo. 1889. \$15.

This is the second issue of the *Annual*, the first having been published for the year 1888. It is essentially a report of yearly progress in all matters relating to medicine or sanitation throughout the world. The subject-matter is divided into nearly seventy departments, each with its editors, corresponding editors, and collaborators.

The work is a success. It evinces great energy and executive ability on the part of its projectors, and, although much might have been omitted, the details are fairly well worked out, and the live physician can hardly afford to do without it, unless he already has a full list of medical journals.

Under the head of Etiology of Disease, bacteriological notes, of course, occupy much space, the article by Ernst, of Boston, on this subject, being clear, rational, and valuable. He attributes recent rapid advancement of bacteriological knowledge to the general use of (1) aniline dyes, (2) homogeneous immersion lenses and substage illumination, and (3) solid culture media. Methods are given for preparing culture media, and for photographing test-tube cultures. He protests against the rapid methods of staining the bacillus of tuberculosis, and

has a word for those who sneer at the limited "practical" results of bacteriological studies. The whole essay is conservatively progressive.

The article on Histology is by Dr. Manton, of Detroit. Some fine plates are reproduced from Mertsching's Histology of the Hair and from Poljakoff's "New Fat-forming Medium"; also three excellent drawings from Kultschitzky's researches upon the smooth muscular fibres in the mucosa of small intestine.

The chief defect in the *Annual*, viz., the disjointed character of the various articles, is hardly avoidable in a compilation from so many sources, the reference list containing the names of 1234 periodicals, pamphlets, monographs, etc. The triple index is, by itself, an immense labor, occupying 101 pages of the fifth volume.

Catalogue of Microscopes and Accessories. By James W. Queen & Co., Philadelphia, 8°, pp. 108.

This is the seventy-first edition of Catalogue B, and is well illustrated. The most important features are the additional kinds of Acme microscopes. There appear also many accessories of late origin, together with cuts of slides, unmounted objects, books, etc. It is worth a careful perusal.

SUBSCRIBERS' NOTICES.

[These notices will be given six insertions in this column at 25 cents per line or fraction thereof.
FOR EXCHANGE.—Slides of selected diatoms. D. B. WARD, Poughkeepsie, N. Y.

WANTED.—Unmounted microscopical material, also micrographic dictionary. Will exchange or buy. CHARLES VON EIFF, 124 Clinton Place, New York City.

WANTED.—A clean copy of Rev. William Smith's British Diatoms, and Schmidt's Atlas of the Diatomaceæ. JAMES B. SHEARER, Bay City, Mich.

OFFERED.—Diatomaceous Earth from Utah (Desert) for Histological Mounts. PROF. ORSON HOWARD, Salt Lake City, Utah.

CORRESPONDENCE invited with a view to the exchange of either mounted or unmounted Oribatida (British) for American species. E. BOSTOCK, Stone, Staffordshire.

TO EXCHANGE.—Native gold, silver, copper, lead, zinc, and other beautiful cabinet specimens, polished ornaments and sections of petrified wood—Chalcedony—and native turquoise, agate, amethyst, rubies, etc.; also Indian ornaments, curios, arrows, blankets, pottery, etc.; pelts of wild animals, species of native cactus, and a good second-hand "Burt's Solar Compass" complete. Any or all of the above are offered in exchange for new, or good second-hand, objectives, condensers, polarizers, stand, or other microscopical apparatus. W. N. SHERMAN, M. D., Kingman, Arizona.

OFFERED.—Zeiss' New Catalogue (in German) forwarded for 10 cents in stamps. F. J. EMMERICH & SONS, 43 Barclay St., New York City.

WANTED.—Any works on Microscopy not already in my Library. H. M. WHELPLEY, F. R. M. S., St. Louis, Mo.

WANTED.—(In exchange for slides.) "Microscopical Bulletin," Vol. I. No. 5, August, 1884. M. S. WIARD, New Britain, Conn.

Labels in exchange for slides. EUGENE PINCKNEY, Dixon, Ill.

First-class Histological Slides for other good mounts; Histological and Pathological material cut on shares. S. G. SHANKS, M. D., 547 Clinton Ave., Albany, N. Y.

OFFERED.—Griffith & Henfy Micrographic Dictionary to be sold; also Hogg's Microscope. J. P. WINTINGHAM, 36 Pine St., N. Y.

WANTED.—A clean copy of Wolle's Fresh-Water Algae of the United States (2 vols.); also good second-hand Grunow Camera-Lucida, and a self-centering Turn-table. JOS. P. THOMPSON, P. O. Box 1383, Portland, Me.



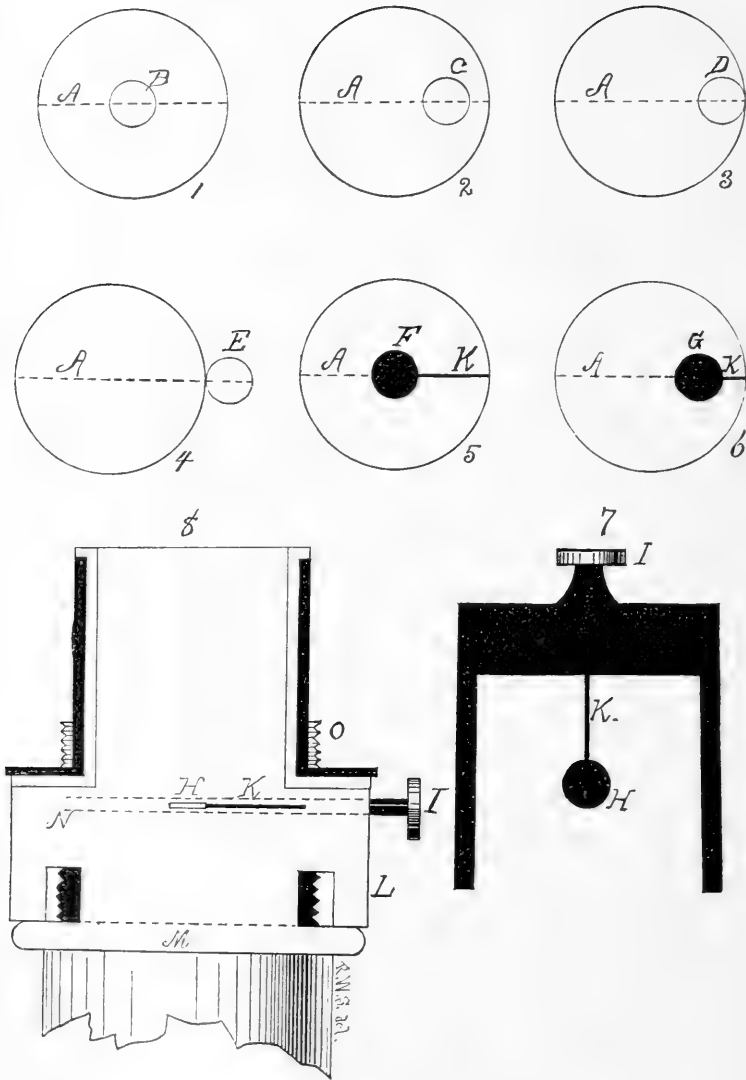

LIGHTON'S DARK-FIELD STOP.

THE AMERICAN MONTHLY MICROSCOPICAL JOURNAL.

VOL. X.

DECEMBER, 1889.

No. 12.

All communications for this Journal, whether relating to business or to editorial matters, and all books, pamphlets, exchanges, etc., should be addressed to American Monthly Microscopical Journal, Box 630, Washington, D. C.

European subscriptions may be sent directly to the above address accompanied by International Postal Order for \$1.15 per annum, or they may be sent to Messrs. Trübner & Co., 57 Ludgate Hill, London, or to Mr. W. P. Collins, 157 Great Portland street, London, accompanied by the yearly price of five shillings.

A Dark-Field Stop.

By WILLIAM LIGHTON.

LEAVENWORTH, KAN.

[WITH FRONTISPIECE.]

Dark-field illumination, when using lenses of high power, and especially homogeneous immersion lenses, has been long desired and is at last accomplished.

After arranging the mirror so as to obtain central light and removing the eye-piece, on looking down the tube the mirror appears a bright figure in the centre of the back lens of the objective (see Fig. 1, B). Let the large circles (Figs. 1 to 6) represent the back lens of an oil immersion or dry objective of large aperture. On swinging the mirror from right to left its image in the lens will pass from left to right, as indicated in figures 2 and 3. Light from the mirror in this position is known as oblique light. If, when using a dry objective, the mirror is swung so far to the left that its image cannot be taken up by the objective, dark-field illumination is obtained (see Fig. 4, E).

When homogeneous-immersion objectives of large numerical aperture are used dark-field illumination by the mirror alone is impossible, because such lenses receive light from all points beneath the stage.

The following method produces a dark field with the mirror in any position from central to extremely oblique:

A metal frame is used as a carrier for the dark-field stop H (Fig. 7), which is also of metal, and which is joined to the carrier by a fine steel wire, K. The carrier slides in a square nose-piece, L (Fig. 8), between the objective and the body tube of the microscope, as shown at the double-dotted line N (Fig. 8). The nose-piece should have a revolving fitting, as shown in the sectional view. The handle of sliding carrier is at I (Figs. 7 and 8). The stop H (Fig. 7) *must be of the*

same size as the image of the mirror in the objective used, and is for the purpose of intercepting this image in the objective. M is the objective and O is the standard screw for body-tube (Fig. 8).

It will easily be seen that by moving the stop the image of the mirror can be intercepted at any point from the centre to the extreme edge of the objective. The *best* effects are obtained when the stop is placed a little beyond the centre, as at C (Fig. 2).

The motions indicated can all be reversed by means of the revolving fitting of the nose-piece. Changes from dark field to bright, and the reverse, can be instantly made by sliding the carrier in its fittings.

The effects obtained by the use of this piece of apparatus with homogeneous-immersion lenses are very remarkable. The internal organs of infusoria are shown with a precision and beauty never equalled. Bacteria in fluids are seen as brilliant points of light. Vast numbers that are above and below the focus, and which could not be seen in a bright field, are brought into view. The trachea of mosquito larvæ can easily be traced as beautiful thread-like lines throughout their entire length.

In examining stained human muscle containing trichina, and using a $\frac{1}{3}$ dry objective with bright field, great care is required to see the parasite in its cyst, but on a dark field produced by the use of the stop the worm will be seen as a brilliant coil and can be plainly traced from tip to tip.

Carmine Staining for Nervous Tissues.

By GEORGE A. PIERSOL, M. D.,

PHILADELPHIA.

Present methods of imbedding and sectioning render staining en masse desirable in all cases where practicable, to which end borax-carmine, alum-carmine, and Delafield's hæmatoxylin are our most reliable and valuable reagents; of these, borax-carmine is undoubtedly the most widely employed, and, owing to its great power of penetration, certainty, stability, and uniformity of action, this preference is well deserved. Notwithstanding the admirable differentiation and crisp pictures obtainable by properly used borax-carmine, which for many cases leave little to be desired, the exhibition of the ganglion cells of the central nervous system is usually far from satisfactory, little more than the nucleus, or at best the bodies of the cells, being well brought out: a conspicuous example of this short-coming of the ordinary carmine or hæmatoxylin stains is seen in the large ganglion cells of the cerebellum. Any method of offering a ready means of securing the satisfactory display of these elements, while staining en masse, must be of interest to the histologist. Now more than a year ago, my friend, Dr. O. Schultze, of Würzburg, Germany, called my attention to the results of some experiments which he had made with sodium carminate; the beauty with which the nerve cells of all parts of the central nervous system were shown at once aroused my interest in the method, which during the past year I have further tested in the Histological Laboratory of the University of Pennsylvania with very gratifying results.

Sodium carminate (carminsaures Natron) appears to have been introduced in the dry powdered form, in 1882, by Maschke*, of Breslau; formerly the salt was obtainable only in that city, but later it found its place on the list of Dr. G. Grübler, of Leipzig, from whom my recent supplies were obtained.

The peculiarity of the method followed by Dr. Schultze consisted not in the employment of this particular carmine salt (for Gierke had used it quite extensively in his experiments), but in the avoidance of all washing or soaking in water or weak alcohol before staining by transferring the tissue *directly* from Müller's fluid into the stain, where it remained until sufficiently colored, when it was washed out in alcohol of gradually increasing strength. The uncertainty of satisfactory results, which attended Schultze's first trials, disappeared with the precaution of leaving the tissue at least two months in the Müller before staining, a prolonged stay in the fluid doing no harm, providing care be taken to renew it on the appearance of turbidity.

My own experience teaches that tissues preserved in and transferred directly from Erlicki's fluid, or from ammonium bichromate, stain equally as well as those from the Müller—probably any of the bichromate solutions will answer. The block of tissue to be stained is placed in say 20 to 25 cc. of a freshly prepared one per cent. aqueous solution of the sodium carbonate, and allowed to remain until deeply colored throughout, which, with the strength of stain indicated, and with 1 cu. cm. blocks of tissue, usually requires 48 hours; as the solution tends to decompose after a few days, the addition of a crystal of thymol is desirable. After staining, the tissue is washed in 70 alcohol until all excess of color has been discharged (18 to 24 hours), after which it is ready for the stronger alcohols necessary for imbedding.

The excellent results obtained by this use of the sodium carminate naturally suggested the trial of the closely allied ammonia carmine under similar conditions; the latter substance Schultze found to work very well with Müller's fluid, the staining being brilliant and well differentiated. My use of the ammonia carmine has been, likewise, highly satisfactory, and additional tissues from Erlicki's fluid are found to stain especially well. The solution employed is composed of carmine, 2 grm.; strong aqua ammonia, 5 grm.; distilled water, 50 cc. The solution should be lightly covered and allowed to stand until all the ammonia has escaped; for use it is diluted with an equal volume of water. The tissues are transferred directly from either the Müller or Erlicki into this quite strong solution, and are thoroughly stained in twenty-four hours; borax-carmine and alum-carmine gave failures under similar conditions; likewise, the results here described are not to be obtained when the tissue has been subjected to the prolonged action of water or alcohol.

Comparison of these carmine stains shows that in general their results are about equal; the ammonia salt stains, however, rather more rapidly, with better penetration, and yields the more brilliant tint, but gives a less crisp differentiation of axis-cylinders and cell processes than is seen in successful stainings with the sodium carminate. The precipitation which sometimes takes place with the latter solution I have never seen with the ammonia stain.

*Gierke: Färberei zu mikroskopischen Zwecken; Zeitschrift für wissenschaft. Mikroskopie, Bd. I, 1884.

The noteworthy features, then, of these carmine stains for nervous tissues are the surpassing beauty and clearness with which the nerve cells—especially their processes—and axis-cylinders are shown, in addition to which the neuroglia cells and fibres are often deeply colored. The merits of these stains are illustrated nowhere more strikingly than in sections of successfully prepared cerebellum, in which the cells of Purkinje with their splendid branched processes form a picture in telling contrast with the exhibition of these elements as usually seen in carmine or hæmatoxylin preparations. The cells of the cerebral cortex form another instance of the value of the method, the long delicate processes being traceable to their finest ramifications as deeply stained red lines on a colorless ground.

While sections of spinal cord so stained are very beautiful, the excellence of the results obtainable by alum-hæmatoxylin and other dyes renders the preparations by the method described less conspicuous; the white matter in such specimens, however, is often especially well shown. The nuclei of the neuroglia cells in the cords of young subjects are especially prominent. The value of the sodium carminate stain in demonstrating the areas of degeneration has been established.

Another, and by no means unimportant, merit of these stains lies in their especial adaptation to photography: employed in connection with the green glass ray-filter described in a former number of this journal*, they possess that degree of actinic contrast most favorable to secure crisp and vigorous negatives. What the Weigert's stain accomplishes for the medullated nerve fibres these carmine stainings do for the processes of the nerve cells and axis-cylinders; the advantages of a ready process of double staining uniting the merits of both are evident. The recently published acid-hæmatoxylin method of Kultschitzky† apparently offers the means of securing such double stains, but so far my attempts to unite the two, while producing beautiful pictures, have failed to furnish preparations in which the features of the Weigert method were sufficiently pronounced; however, subsequent experiments may prove more satisfactory.

UNIVERSITY OF PENNSYLVANIA, Sept. 2, 1889

Cuccati's Soluble Carmine.—Dr. Grovarini Cuccati describes, in the *Zeitschrift für Wissenschaftliche Mikroskopie*, a carmine solution which he uses in connection with a cold saturated solution of ammonium picrate in staining microscopical preparations. The carmine solution is prepared by dissolving 20 grains of sodium carbonate in 100 cubic centimetres of water, adding thereto 5 grains of Grüber's pulverized carmine, mixing well, and bringing to a boil. When ebullition has been effected the capule is removed from the fire and 30 grams of absolute alcohol added. After cooling, the solution is filtered and immediately mixed with 300 grains of water previously acidulated with 8 cubic centimetres of acetic acid, and, finally, 2 grains of chloral hydrate are added and dissolved in the mixture. The ammonium picrate solution is made by first moistening picric acid with sufficient ammonia to make a thin paste, and adding sufficient cold distilled water to nearly, but not quite, dissolve the mixture. In staining, equal parts of the two solutions are used.—*National Druggist.*

* Vol. VII, July, 1886.

† Kultschitzky: Ueber eine neue Methode der Hæmatoxylin Färbung; Anatomisch. Anzeiger, Bd. IV, No. 7, 1883.

On the Microscopical Examination of Urinary Sediment.*

By WILLIAM BUCKINGHAM CANFIELD, M. D.

LECTURER ON NORMAL HISTOLOGY, UNIVERSITY OF MARYLAND.

Physicians now generally recognize the fact that an examination of the urine forms an important part in making the diagnosis of any disease. In many cases negative results may satisfy, as excluding certain diseases. It is a matter of common occurrence that one physician not being successful in the treatment of a case, a consultant or another physician is tried, who, carefully examining the urine, a thing which the first adviser had failed to do, finds enough to throw considerable light on the malady and its treatment. In urinary analysis, an examination both chemical and microscopical should be made in all doubtful cases. The former is a matter not difficult for the majority of physicians, and there are few physicians who cannot make the ordinary tests for albumen, sugar, etc. The microscopical examination, however, is a matter not so simple. There are plenty of practitioners who cannot make a microscopical examination of the urinary sediment in a manner satisfactory to themselves. This part of the subject, although old and often discussed, may be repeated with advantage, even at the risk of uttering remarks well known and trite to many.

First, as to the technique. The patient or attendant should be impressed every time with the importance of saving clean specimens of urine. The bottles and vessels in which the urine is collected and preserved should be scrupulously cleansed and dried. The urine obtained should be passed in the morning on rising and in the afternoon, so that two different samples may be examined. This is necessary, among other reasons, because the urine may be free from albumen in the morning and loaded in the afternoon. These specimens should be examined as soon as possible after receiving them, and in case of keeping them, they should be preserved in a cool place, and some such substance as salicylic acid may be added, which will not affect the examination.

Difficulties present themselves when the urine contains very much or very little sediment. When very little, it is the general custom to let it stand for twenty-four hours in a cool place in a conical glass, so that the sediment may drop to the bottom of the vessel. Casts when not abundant may remain suspended for a longer time in the urine, and owing to their lightness they may stick to the sloping sides of the glass and thus escape detection. Sometimes better results may be obtained by letting the urine stand in a cylindrical glass for twenty-four hours and then drawing up the bottom layer of fluid with a pipette and examining it. I have turned the bottle upside down for one day and then examined the sediment which had collected on the cork, but this is not usually satisfactory. For the microscope it is well to have a thick slide with a concavity ground in it.

When there is much sediment it is not easy to separate the important from the unimportant matters. In this case it is better to let the urine stand in a cool place in a conical glass for six or twelve hours, and then pipette off the supernatant fluid and let that stand in a second glass. Casts will be found in the second glass, and in the first, pus, blood, epithelium, and inorganic matter.

* Report of Section on Microscopy, Micro-Chemistry, and Spectral Analysis.

There is a great difference between the urine of the male and female as regards sediment. Urine from the female generally contains large flakes of epithelium from the vagina, blood corpuscles, etc. This excess of sediment may be excluded by having the urine drawn off with a clean catheter, or by directing the patient to syringe out the vagina and genitals with warm water before urinating.

Red blood corpuscles are of no clinical significance unless present in large numbers. They may occasionally be mistaken for air or oil globules. Stray leucocytes are rarely absent, and are only to be considered when they are present in large numbers, as from a cystitis or rupture of some abscess in the genito-urinary-renal tract. Bladder epithelium, and in the female, vaginal epithelium, is always present. Some of the bladder and vaginal cells so strongly resemble each other that they at times cannot be distinguished, and indeed vaginal epithelial cells have been described as being present in the male urine occasionally. Again, some cells from the bladder so much resemble epithelium from the ureter or renal pelvis that I always have trouble in distinguishing them. Renal epithelium, when it has not undergone fatty or other degeneration, is not difficult to recognize.

The principal object of the microscopical examination of the urine is to see if casts are present or absent. Although they are found in some of the acute diseases, and at times without sufficient explanation, still their continued presence cannot fail to be alarming. They should be looked for whether albumen be present or not. Albumen is often absent at the time of the microscopical examination, it having appeared at an earlier stage of the disease. Albuminuria without casts is said to be more common than it really is, and the majority of investigators agree in believing that they were present but could not be found. This was deduced from autopsies. In an interesting case* of cyclic or physiological albuminuria, I have never been able to find casts although I look at intervals.

I generally draw off a little of the sediment with a pipette, and drop it on a hollow slide, and examine it with a low power. The sediment may be then seen floating about. Most books warn against taking up too much fluid on the slide; I find this an advantage. I take up a large drop on an ordinary slide, and as the fluid runs along the slide, an opportunity is offered to review the sediment as it passes by, taking care, of course, that it does not get on the stage of the microscope. If casts are found, then another drop may be taken, and, before putting on a cover-glass, a small bit of broken cover-glass or a hair is put by the preparation and then covered. This prevents the casts from being crushed. I generally prefer to examine first without a cover-glass, because it is rarely necessary to use such a high power that the objective comes near the preparation. Some writers suggest that when there is much sediment to roll the cover glass backward and forward with two fingers. I have done that several times and succeeded in making casts when there were none there. When a cover-glass is used, as little liquid as possible should be taken up, and as this lessens the chance of finding them if few are present, it is not always advisable. Staining is generally superfluous, but if desirable.

* See author's article on "Cyclic Albuminuria," in the Philadelphia Medical News, July 30, 1887.

it is better to drop a little staining fluid in the urine, as staining under the cover-glass causes the sediment to fly across the field at an alarming rate of speed and settle on the outside of the glass. This may be prevented by allowing the casts to dry on the slide and then staining; but this is apt to change their appearance and is not advisable. The best way is to stain them before the cover-glass is put on.

“Tube casts, or urinary cylinders, form by far the most important pathological constituent of urinary sediment. They are so called because they are supposed to be moulds of the uriniferous tubules of the kidney. After being thus moulded, they shrink and are carried out with the urine. They are supposed to be formed by a coagulable substance in the blood, or by some morbid change of the renal epithelium. According to their appearance and composition, casts have received different names. If the mould of coagulated fibrin pass out with the urine without blood or cell, it is called a hyaline or waxy cast. According as epithelium, blood, fat drops, or granular matter [the two last from degenerated epithelium] are adherent to the moulds of fibrin, the casts are called respectively epithelial, blood, fat, or granular casts. These casts vary in diameter [from $\frac{1}{2500}$ to $\frac{1}{500}$ of an inch] according to the part of the tubule from which they come. Hyaline casts are generally smaller than those to which epithelium, blood, etc., are attached. Mucous casts have also been described. Amorphous sediment and small crystals may adhere to casts, and they also sometimes arrange themselves in a cylindrical form and deceive the inexperienced. Casts of the urates and of bacteria may be mentioned. In cleaning slides and cover-glasses, bits of linen threads are often left on the glass and may be mistaken for hyaline casts.” (Practical Notes on Urinary Analysis.) Occasionally bladder or vaginal epithelium becomes rolled up and looks very much like casts. It is almost superfluous to say that, as the finding of casts is generally of grave significance, a decision should not be reached by one examination, but many slides should be prepared. The laity soon knows the gravity of casts in the urine, and let a man once be rejected by a life insurance company, it is a serious shock to him. Therefore not without careful examination and consideration should a decision be made in this most important subject.

Cement for Glass.—A thin coat of “diamond cement” laid on each surface of the glass, pressed together and left for two days, answers admirably. Melt the cement by immersing bottle in hot water, and put very little on—the less the better.—*English Mechanic*. October 25, 1889.

Close Shaving.—Through a microscope, a face which has been treated to this process resembles a piece of raw beef. To make the face perfectly smooth requires not only the removal of the hair, but also a portion of the cuticle; and a close shave means the removal of a layer of skin all around. The blood-vessels thus exposed are not visible to the unaided eye, but under the microscope each little quivering mouth holding a minute blood drop protests against such treatment. The nerve tips are also uncovered and the pores are left unprotected, which makes the skin tender and unhealthy. This sudden exposure of the inner layer of the skin renders a person liable to have colds, hoarseness, and sore throat.—*Medical Classics*.

Griffith's Fine Adjustment.

By E. H. GRIFFITH.

FAIRPORT, N. Y.

In Fig. 1 Nos. (1) (2) (3) represent the milled head, pinion-axis, and pinion of the ordinary method of coarse adjustment. The milled head (1) is countersunk on its inner side, and the small wheel (4) is made to exactly fit the countersunk space, the inner surface of (1) and of the wheel (4) being perfectly smooth and flat. Attached to (4) is the socket and pinion (7), all of which are perfectly fitted over the pinion-axis (2) between the pinion (7) and milled head (1). A leather washer (5) is made to rest closely against the inner surfaces of (1) and (4). It is held in position by another washer of metal (6) which, by means of two screws passing through it and (5) is made fast to the milled head. A small tension wheel (10) has a screw passing through both washers, also binding them to (1), and when desired, locking the coarse-adjustment by making the whole combination practically one

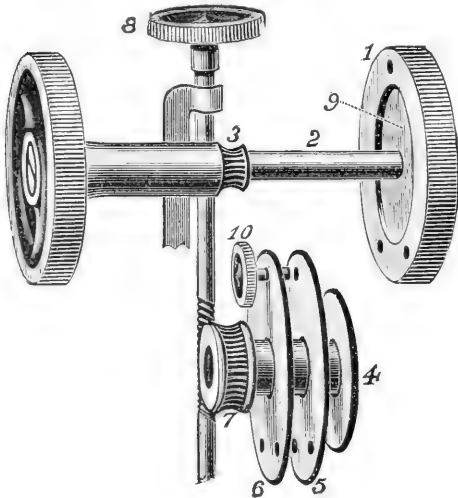

FIG. 1.

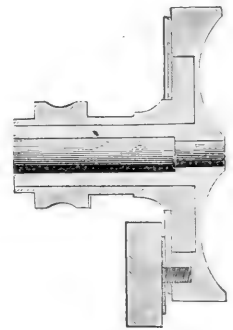

FIG. 2.

wheel. When the coarse-adjustment is used, the spindle (8) holds (7), (6), (5), (4), so that they cannot revolve with the pinion. When the micrometer adjustment is required the friction of the leather washer makes the whole combination practically one wheel, which is turned by means of the milled head (8), giving the entire range of the coarse-adjustment for the fine adjustment. Both adjustments are always ready for use when the tension wheel is properly set, except when the coarse-adjustment is purposely locked to prevent accidents. All wear is taken up by the spring. Fig. 2 shows the entire combination in position.

In this combination of the two adjustments into one, but one groove is required, greatly lessening the danger of lateral motion as in other microscopes where two or more grooves are needed. The one groove being close to the tube is another safeguard.

The long range of the fine adjustment is of great value, and the same is claimed for the locking device. The mechanism is so simple that it cannot well get out of order, and should any accident happen, any jeweller could easily repair it.

Staining and Mounting Zoosperms.*

By R. N. REYNOLDS,

DETROIT, MICH.

In mounting this material it is necessary first to cause the containing fluid to mix with water. A weak aqueous solution of bichromate of potash is the only drug which, without destroying the objects, will cause the fresh specimens to do this; but when the fresh material is subjected to the action of potash solution, the objects die with their tails coiled. To prevent this coiling let the specimen die at the ordinary temperature of the atmosphere, which will usually take about thirty-five hours, though the weaker ones die in five or six hours. When dead the specimens will be found swarming with bacteria, to avoid which keep them at a temperature something below that of the human body. Cold water preserves them while moderately hot water kills the greater part of them.

When mixed with water they may be stained any desirable color; or by using red first, followed by green, the bodies appear red and the tails green. When the stains have taken effect a plug of absorbent cotton may be placed in the neck of a funnel, and the specimens filtered through it. If the plug be tight enough, so that the water will not stream but only drop, thousands of the objects will pass through, but tens of thousands remain in the cotton. This plug is then taken out and the water squeezed from it. Place a slide on the turn-table, dip an artist's small brush into the fluid squeezed from the plug, and while the turn-table is in motion bring the point of the brush to the centre of the slide. A small round deposit will be left, which should be dried. Next with white zinc cement, make a ring about half an inch in diameter on the slide, allow this to dry for a couple of days and then slightly moisten the ring with the same cement, lay on a cover-glass, and you have a permanent mount.

Ventilating and Albino Bees.—Detection of Adulterated Honey.

By JOHN ASPINWALL,

BARRYTOWN-ON-HUDSON, N. Y.

Ventilating Bees.—Referring to the April number of this periodical, page 89, under heading, "Biological Notes," it may be stated positively that bees *do* ventilate in every hive in America on a hot day. This is an old-established fact, and this is the proof: They stand near and in the entrance of the hive fanning, violently, and always headed one way, viz., inwards. The hotter it is, the more bees participate in this work. They never head outward. This fanning causes quite a perceptible current.

* Abstracted from *The Microscope*, 1886, pp. 196-7, by request.

Detection of Adulterated Honey.—The amount of pollen contained and the presence of crystals is not a sure test for adulteration. Pure granulated honey is made up more than half of crystals. I send you a slide of honey not yet granulated, in which little pollen is seen but many crystals. This is absolutely genuine honey, taken from the comb ten minutes before mounting.

Albino Bees.—The so-called Albino hive bee has four very light-colored segments of abdomen, but the rest of the body is black, or a very dark brown, as in the ordinary Italian bee. The first queen of this variety was a "sport" from the pure Italian, and was bred by the Rev. H. A. King in Ohio over fifteen years ago.

NOVEMBER 2, 1889.

Microscopic Examination of Paper.—Mr. Herzberg, who has charge of the examinations of paper at Charlottenburg, has just published a very exhaustive work upon the subject, with numerous reproductions of microscopic preparations. He brings especially into prominence the peculiarities of certain fibres for rendering them easily distinguished.

The author uses a solution of iodine for recognizing the various fibres, which, according to their origin, assume various colors: (1) Wood-wool and jute are colored yellow; (2) straw, "cellulose," and alfa do not change; (3) cotton, flax, and hemp are colored brown.

For disintegrating the paper Mr. Herzberg does not employ the processes in common use. Mechanical appliances, either needles or a mortar, do not remove the size, starch, and weighing substances which in part conceal the structure of the fibres and render the examination of them difficult. He recommends that a small quantity of the paper to be examined be submitted to ebullition for a quarter of an hour in a 1 to 2 per cent. solution of soda. In this way the foreign substances are got rid of and the fibres set free. The presence of wood-wool will be ascertained, during the boiling, by the paper becoming yellow.

After this treatment the whole is poured upon a brass strainer with fine meshes and is washed with pure water. The washed residuum is reduced to a homogeneous paste in a porcelain mortar.

In the case of colored paper the coloring matter must be removed if the boiling does not effect the removal. To this end, hydrochloric acid, chloride of lime, etc. is used according to the chemical nature of the coloring matter. When the paper is not sized nothing but water is used for the boiling. If the presence of wool in the paper is suspected an alcoholic solution, instead of an alkaline one, is used, as the latter would dissolve the wool.

The solution of iodine in iodide of potassium may be more or less concentrated. The color produced varies in depth according to the concentration. The author generally uses the following formula:

Iodine,	18 grains.
Iodide of potassium,	30 grains.
Water,	5 drachms.

For spreading the paste upon the object-holder of the microscope he employs two platinum needles. The object-holder is placed upon a white ground, so that the fibres will stand in relief more prominently. The paste is covered with a glass, and the excess of water is removed

with blotting-paper. For the determination of the fibres a magnifying power of 300 diameters is best adapted, but, for ascertaining the relative proportion of the fibres, one of 120 diameters, that permits of taking in a wider surface, is preferable.—*Gutenberg Journal*.

BIOLOGICAL NOTES.

By Prof. J. H. PILLSBURY.

NORTHAMPTON, MASS.

Strength of Wood.—Certain tests made at the car-shops of the Northern Pacific Railroad at Tacoma, Wash., show that a bar of wood 2 x 4 inches and four feet long, resting on supports three feet nine inches apart, broke under the following strains, viz., yellow fir, six years exposed to the weather, 3,062 pounds; new soft yellow fir of fine grain, 3,062 pounds; old and hard yellow fir with coarse grain, 4,320 pounds; new fir from the butt of the trees, and of coarse grain, 3,635 pounds; Michigan oak, 2,428 pounds. Is not this contrary to the usual reputation of oak wood?

—o—

Annual Rings of Trees.—Prof. Hartwig is quoted as authority for the statement that trees cut three or four feet from the ground often show a larger number of rings of annual growth than when cut at the usual distance from the ground, the deposit of tissue failing to be made in the latter region.

—o—

Grape-Vine Diseases.—The culture of the grape in Algeria, according to the report of the consul-general to the foreign office of the British government, is beset with great difficulties. Beside the phylloxera, the alise, and such parasites as oidium, anthrachosis, peronospora, and chlorosis have caused a loss of nearly one-third of the crop.

—o—

Autumn Colors.—In addition to the chlorophyll of plants, there is generally present in their cells a small quantity of certain other coloring matters as xanthophyll, erythrophyll (yellow and red coloring matter), both of which are derived from chlorophyll by the chemical forces of the plant, but which are in so small proportions as to be more or less completely covered up by the presence of the chlorophyll. If for any cause these are increased in quantity they give their peculiar color to the leaves, as is the case with foliage plants. In the normal growth of the plant, especially of perennial plants like our forest trees, the early summer is the period of rapid growth. Later in the season the cells formed in the early summer become hardened into wood and active growth ceases. At this time the portion of the chlorophyll is changed to xanthophyll and erythrophyll and a portion withdrawn to other parts of the plant. This leaves the bright colors in sole possession of the cells and gives the peculiar tints to the autumnal leaves. These changes are affected by the variations of the season. When the season is very dry the nutrition of the plant is interfered with and the growth ceases at an abnormally early date, and the colors make their appearance earlier than usual, but are less brilliant. Early frosts destroy the life of the leaf and

prevent the brilliancy of the colors. A great degree of moisture seems also to produce early changes. During the past very wet season in New England the leaves of maples in wet grounds showed bright colors as early as the middle of August. A medium amount of moisture and late frost seem to be favorable to the greatest brilliancy of the leaves. The colors of flowers and fruits are due to similar changes in which other coloring matter of a slightly different chemical composition is produced. The chlorophyll of the green flower or fruit is changed into a special coloring matter. This in the case of yellow flowers is anthoxanthin; of white flowers, antholeucin; of blue flowers, anthocyanin, etc. These changes are produced as the fruit matures or the flower opens. Violet and purple tints are probably due to the action of acids in the cells upon their coloring matters.

The fall of the leaves is due to the peculiar structure of the leaf petiole. A layer of rather large cells at the union of the petiole with the stem of the plant is deprived of some of its nourishment whereby its walls remain thin, and the protoplasm becomes at length dried or killed by frost when the cells shrivel and break, and the leaf having nothing to support it falls from the stem.

Micro-photographs.

Definition.—Micro-photographs are pictures produced by photographing large objects or views down to size so small as to require to be examined under the microscope. Photo-micrographs, on the contrary, are pictures of very small objects made by magnification through the microscope, and when thus enlarged may be examined with the naked eye. Micro-photographs are small photographs—smaller than the objects. Photo-micrographs are large photographs—larger than the objects.

Illustration.—It is quite common to see at soirées the Lord's Prayer under the microscope. The micro-photograph is mounted on a slide for this purpose. At the recent inauguration of President Harrison boys sold thousands of watch-charms consisting of micro-photographs of Harrison, Morton, and the White House, mounted in little ivory telescopes. The deception was so fine that an intelligent friend—a college graduate—hunted the side of a room carefully over to find the pictures on the wall towards which he had pointed the watch-charm, little believing that they were contained in the $\frac{1}{16}$ inch aperture through which the light had reached his eye.

Process.—The operations of micro-photography are thus described in a recent number of the *English Mechanic*:

The process is simple, but it requires much practice to get good effects. All you have to do is either to substitute a microscope (minus the eye-piece) for the lens in the camera, or to make a little camera to suit $\frac{1}{4}$ -plates, divided into four, as recommended by Dr. Maddox Brown, and fix on a microscope instead of the eye-piece. The first method is most commonly adopted. The camera is fixed on a kitchen-table, the microscope is turned down to a horizontal position, the joining of the eye-piece end of the microscope to the camera must be perfectly light-tight. Use a large condenser to throw the light of a paraffin lamp at a proper angle through the object to be photographed, and through the

object-glass of the microscope on to the focusing screw (and subsequently the dry-plate) in the camera. For high-power work a sub-stage condenser will be required, but at first a 1-inch objective will be high enough while experience is being acquired by the beginner.

EDITORIAL.

A New Piece of Apparatus.—Dr. Lighton has for some time been experimenting upon dark-field illumination, and has realized his highest expectations in the piece of apparatus described in this number. With characteristic liberality he at once makes his invention public and gives its use to the fraternity. He explains his method of getting such illumination when using lenses of high power and wide aperture. He also has drawn the sketches from which the frontispiece is worked up. Dr. Lighton is one of the most enthusiastic microscopists in the West.

Royston-Pigott, M. D., the eminent microscopist, died on September 14th, at Eastbourne. It will be remembered that he did much work in the improvement of microscopic objectives. It was in recognition of this that in 1873 he was elected Fellow of the Royal Microscopical Society.

Slides Received.—We return thanks to the donor for the following interesting slide:

Honey (genuine), showing crystals. Mounted shortly after the material was taken from the hive. Prepared by John Aspinwall, Barrytown, N. Y.

NOTES.

A Simple Formula for Finding the Magnifying Power of a Compound Microscope.—Let M = magnifying power, A = the equivalent focus of the eye-piece, B = the equivalent focus of the objective, O = the optical tube length (measured from the anterior principal focus of the eye-piece to the posterior principal focus of the objective) and D the distance for distinct vision; then $M = \frac{D O}{A B}$.—

Edward M. Nelson, in *English Mechanic*, Oct. 25, 1889.

Amplification Required to Show Tubercle Bacilli.—When properly stained and prepared, the bacillus tuberculi can be readily recognized with a good "one-fifth" objective and a "two-inch" eye-piece, normal tube length, or, roughly speaking, an amplification of 250 diameters. We do not think that it could be done much below this amplification, though the sharpness of vision of the observer, his acquaintance with the object, and the excellence of his objective would be important factors in settling the question. A one-quarter objective with a two-inch eye-piece, normal tube length, gives an approximate amplification of 200 diameters.

To be seen and diagnosed for certain, the bacillus tuberculi, in urine or water, must be prepared for examination by following the well-known

technique in such cases (fixing, staining, bleaching, and mounting). No person who has any regard for his reputation as a microscopist would undertake to diagnose for certain bacilli of tubercle from other similar forms existing in water, urine, or any other medium whatever, whether with a magnification of 200 or 2,000 diameters. The property of taking certain aniline stains, and retaining them so firmly that even nitric acid diluted with only three volumes of water or alcohol will not bleach them, is one peculiar to the tubercle bacillus, and shared, as far as we know, by the bacillus of leprosy only. This test, along with isolation and pure culture, alone makes the recognition of bacillus tuberculi certain.

For search of tubercle bacilli and study of the same, we have found a one-tenth homogeneous immersion objective with a two-inch eye-piece (approximately 500 diameters) the most satisfactory and least tiring to the eye. A good one-eighth, however, with the same eye-piece, should be quite sufficient.—*National Druggist*.

QUERIES.

Putting the Maker's Name on Objectives.

In reply to the question of a subscriber as to the custom both at home and abroad with reference to putting maker's names on objectives, we have the following statements from several of our leading dealers:

1. By the Bausch & Lomb Optical Company.

All reputable makers of objectives both in this country and abroad have their names engraved on objectives, which is a guarantee for the quality of the lens. There are some microscope objectives made in England and France which are sold with the cheap imported microscopes brought into this market by importers of optical instruments which bear no inscription as to who the maker is.

2. By W. H. Bulloch, Chicago, Ill.

I do not know of any maker of first or second-class objectives in this country or abroad, who does not put his name either on the objectives or box. Any person who makes any pretention to microscopy will not usually purchase an objective unless the maker's name is on it. It is said that a workman is known by his tools; and so far as I have had any experience with those who use the microscope, if they cannot give the maker's name of the objectives or instrument, they are unworthy of being known as microscopists.

3. By G. S. Woolman, New York City.

The custom in the United States is to put the maker's name either on the objective itself or on the box. Occasionally on the low-priced lenses the name is omitted. The French objectives quite often reach this country without name. The German custom is the same as the United States. A buyer can rely upon obtaining the make required if he orders from any reliable house here. The English first-class makers do the same as the United States. There are, however, a number of very fair English objectives made that do not have names upon them.

4. By James W. Queen & Co., Philadelphia.

Custom varies very much among the different makers. The principal makers in this country generally place their names upon the ob-

jectives. Some of the foreign makers also do this, but it appears to be the more general custom abroad to place the name only upon the box, although this is by no means the invariable rule. The continental makers usually engrave the number only (which is an arbitrary one, as No. 3, No. 5, etc.), upon the objective in the case of the cheaper lenses; but in the case of higher priced lenses, as oil-immersion lenses, adjustable water immersions, etc., the maker's name may also, perhaps now does most generally, appear.

5. By Fr. J. Emmerich, Sr., New York City.

Most of the makers in Europe, as far as our experience goes, do not put their names on their make, as we have had quite a number of Hartaack's, Gundlach's, Varick's, and other makers, and never found their names on their objectives. It may be, however, that on particular occasions, or upon requests, these makers would not refuse to have their names put on, and we think, in the interest of buyers and investigators, it would be desirable to have them do it, as we would have more confidence in a lens bearing the name of its maker than in one without it, because the latter would not dare to put his name on a bad or objectionable article if he cares for his reputation. I am of opinion that all makers should follow the example of Mr. Carl Zeiss, of Jena, whose name is distinctly engraved on every one of the objectives he produces, as from the way they are manufactured under the supervision of Professor Abbé, there cannot possibly be an inferior article produced or delivered from his workshop. I may, however, add that every buyer should look out that he gets really the genuine article, and would caution him to beware of counterfeits.

MICROSCOPICAL SOCIETIES.

MICROSCOPICAL SOCIETY OF WASHINGTON, D. C.—L. M. Mooers,
Sec'y.

October 8, 1889.—The annual election of officers was as follows:—President, Dr. E. A. Balloch; Vice-President, Dr. A. N. Skinner; Cor. Secy., Dr. J. M. Lamb; Rec. Secy., Mr. L. M. Mooers; Treasurer, Mr. J. M. Yznaga; Curator, Dr. W. H. Seaman.

Dr. Seaman gave an account of the twelfth annual meeting of the American Society of Microscopists at Buffalo; also a description of some of the methods of lens-making employed by the Bausch & Lomb Optical Company.

October 22, 1889.—A paper was read by Dr. Thos. Taylor on "Tea, and its Adulterations." The paper was finely illustrated with photographs and colored camera-lucida drawings. Prof. Hitchcock gave an interesting description of native cultivation and preparation of tea. The President announced the following committees:—Essays, Mr. V. A. Moore, Dr. Seaman, and Dr. Lamb; Membership, Doctors Reyburn and Gibbs, and Mr. Doubleday.

TORREY BOTANICAL CLUB.

Wednesday, October 23.—Professor Schrenk exhibited microscopical preparations of cross sections of the leaves of the Witch Hazel.

Hamamelis Virginica, showing peculiar structures called "osteoscleroid cells," found at the extremities of the fibro-vascular bundles, and situated vertically to the leaf-surfaces, after reaching to the epidermis. He concluded that they are functionally strengthening elements. They are very abundant in the leaves growing in the shade, and wanting in those of firmer texture exposed to the sun light.



BROOKLYN MEDICAL MICROSCOPICAL SOCIETY.

September 4, 1889.—The twenty-fifth meeting was held at the Hoagland Laboratory. The President, Dr. C. Heitzmann, read a paper on "The Intimate Structure of the Derma of the Skin." Dr. J. H. Mennen read a paper on "Silver Images in Inflamed Cornea."

Dr. Heitzmann said that, in reviewing the literature of this topic, the essayist comes to the conclusion that a thorough knowledge of the structure of the derma is as yet lacking. This tissue becomes intelligible only through the knowledge of tendon, in which the bundles run in a strictly parallel course, whereas in the derma, as in aponeuroses, the bundles are interlacing. Transverse sections of the bundles show interstices filled with medullary and delicate fibrous connective tissue; they are rich in blood-vessels and nerves, and may be termed interstices of the first order. Smaller groups of bundles are separated from one another by groups of the second order, likewise holding smaller blood-vessels. Between the larger bundles we find protoplasmic formations, all interconnected, and thus producing a network, strikingly similar to that of a myxomatous connective tissue. These are the interstices of the third order. The bundles themselves are split up, though incompletely, into smaller ones by interstices of the fourth order, holding thin layers of nucleated protoplasm, or elastic fibres. The reticulum of protoplasm is continuous throughout the derma. In longitudinal sections of bundles only the protoplasmic bodies, but no lateral offshoots and no net-like arrangement thereof, can be seen. Dr. Heitzmann then described the papillary layer of the derma, which shows difference in structure according to age. In the new-born the papillæ are mainly protoplasmic in nature; made up of delicate fibres in the middle aged; and in old age of a coarse fibrous tissue, freely intermixed with hydropic protoplasmic bodies, thus causing the appearance of a myxo-fibrous structure. All the bundles are traversed by an extremely delicate reticulum of living matter, that can be brought to view by treatment with alcohol, or by treatment with solutions of gold chloride. The same reticulum is visible in specimens hardened in solutions of chromic acid, immediately after mounting in glycerine. As soon as the glycerine soaks into the tissue the reticulum disappears. These details can only be studied in specimens mounted in glycerine, not in Canada balsam.

October 2, 1889.—Dr. G. T. Kemp was elected a member, and Dr. A. R. Robertson was proposed. A publication committee to decide on the suitability of papers for publication was appointed, consisting of the president, the secretary, and of Dr. Van Cott.

After the transaction of the regular business, an address was given by the president on the "History of the Development of Enamel," which was discussed by Drs. Eccles, Van Cott, and Heitzmann. (From *Brooklyn Medical Journal*, Nov., 1889.)

NOTICES OF BOOKS.

Christianity and Agnosticism. Papers by Henry Wace, D.D., Prof. Thomas H. Huxley, the Bishop of Peterborough, W. H. Mallock, and Mrs. Humphrey Ward. The Humboldt Publishing Co., 28 Lafayette Place, N. Y.

The series of papers comprised in this work have been contributed mainly to the *Nineteenth Century*. Both sides write with vigor, and the adherents of each will probably think their champions have the better of the discussion. The book will probably have quite a sale. Price, thirty cents.

Plant Organization: structure and morphology of plants by the written method. By R. H. Ward, M. D., Troy, N. Y. 8° (wide), pp. 24.

The well-known manager of the Postal Microscopical Club and our much-esteemed friend, Dr. Ward, has devised a scheme to extend the study of plants to a grade of teaching not heretofore attempted, and after some trial of it by successful teachers with their classes, he ventures to submit it to the public. The writer once contemplated much the same system of botanical study.

He proposes a thorough and exhaustive study of a few plants rather than hasty identification of many. In this plan, of course, the microscope plays its part, magnified sketches of hairs, glands, pollen, epidermis, etc., being called for. Outline drawing constitutes another part of the course.

In two pages of illustrations are combined about 250 cuts, illustrating all kinds of roots, stems, leaves, flowers, and fruits. Into 16 pages are condensed a synopsis of plant organization in which are included all necessary descriptive terms with the definition of each.

Upon this subject the doctor speaks wisely and boldly, but may not secure universal approval, because there are those who still seem to desire to surround scientific knowledge with mysticism. Doctor Ward has no such nonsense about him. In the preface he says:

The commonly accepted *classification* and *phraseology* have been revised, and important changes made throughout, always in the direction, as far as seemed practicable at present, of discarding the artificial and mechanical theories of the past, and the erroneous and misleading terms and descriptions based upon them, and of the substitution of explanations and terms treating the plant as a living being, not *built* but *grown*. Surely the time has come to cease teaching students to say that organs are "*inserted*" where they have themselves grown; or that they are "*wanting*," when really absent because not wanted.

Without disparaging the usefulness of *technical terms* as a means of precision to thorough students of a science, it has long seemed evident to the author that the memorizing, by whatever method, of the very numerous unfamiliar terms used by botanical authors, was a serious waste of time to that very large class of short-course students who neither expect nor desire to become botanists. For the benefit of such persons the words italicized, as believed to be suitable for their purposes, are either common English words, or those of obvious meaning on account of their familiar roots, or the very few technicalities which seem absolutely essential and which, from their fewness and the associ-

ations by which they are introduced, may easily become familiar. On the other hand, the usual technical terms are added [in square brackets] for glossarial purposes, for the assistance of classical scholars, or for the use of such other students as may feel the need of them, or be advised by their teachers to employ them.

—o—

The **National Magazine** is a new publication devoted to correspondence teaching and University extension, and is the organ of the new National University of Chicago. The first number contains articles entitled "Correspondence Teaching; Its Advantages," by Rev. J. C. Quinn, A. M., Ph. D.; "Hints on Collecting and Preserving Specimens of Natural History," by Prof. G. H. French, A. M.; "Lectures on English Literature," "The Reading Circle," and the Announcement of the University, giving a list of thirty-five non-resident, professors representing, among others, such institutions as the University of Virginia, Tulane, Boston, Madison and Lehigh Universities, who agree to teach pupils at home by correspondence and grant them the usual degrees on examination.

SUBSCRIBERS' NOTICES.

[These notices will be given six insertions in this column at 25 cents per line or fraction thereof.
FOR EXCHANGE.—Slides of selected diatoms. D. B. WARD, Poughkeepsie, N. Y.

WANTED.—Unmounted microscopical material, also micrographic dictionary. Will exchange or buy.
CHARLES VON EIFF, 124 Clinton Place, New York City.

WANTED.—A clean copy of Rev. William Smith's British Diatoms, and Schmidt's Atlas of the Diatomaceæ.
JAMES B. SHEARER, Bay City, Mich.

OFFERED.—Diatomaceous Earth from Utah (Desert) for Histological Mounts.
PROF. ORSON HOWARD, Salt Lake City, Utah.

CORRESPONDENCE invited with a view to the exchange of either mounted or unmounted Oribatida (British) for American species.
E. BOSTOCK, Stone, Staffordshire.

TO EXCHANGE.—Native gold, silver, copper, lead, zinc, and other beautiful cabinet specimens, polished ornaments and sections of petrified wood—Chalcedony—and native turquoise, agate, amethyst, rubies, etc.; also Indian ornaments, curios, arrows, blankets, pottery, etc.; pelts of wild animals, species of native cactus, and a good second-hand "Burt's Solar Compass" complete. Any or all of the above are offered in exchange for new, or good second-hand, objectives, condensers, polarizers, stand, or other microscopical apparatus.
W. N. SHERMAN, M. D., Kingman, Arizona.

WANTED.—Any works on Microscopy not already in my Library.
H. M. WHELPLEY, F. R. M. S., St. Louis, Mo.

WANTED.—(In exchange for slides.) "Microscopical Bulletin," Vol. I, No. 5, August, 1884.
M. S. WIARD, New Britain, Conn.

Labels in exchange for slides.
EUGENE PINCKNEY, Dixon, Ill.

First-class Histological Slides for other good mounts; Histological and Pathological material cut on shares.
S. G. SHANKS, M. D., 547 Clinton Ave., Albany, N. Y.

OFFERED.—Griffith & Fenfry Micrographic Dictionary to be sold; also Hogg's Microscope.
J. P. WINTINGHAM, 36 Pine St., N. Y.

WANTED.—A clean copy of Wolle's Fresh-Water Algae of the United States (2 vols.); also good second-hand Grunow Camera-Lucida, and a self-centering Turn-table.
JOS. P. THOMPSON, P. O. Box 1383, Portland, Me.

FOR SALE CHEAP.—New Gundlach $\frac{1}{16}$ homogeneous-immersion objective, for $\frac{2}{10}$ glycerine or water objective.

J. M. ADAMS, Watertown, N. Y.

THE AMERICAN MONTHLY MICROSCOPICAL JOURNAL.

INDEX.

	PAGE.		PAGE.
Abbe condenser	55	Bidwell, W. D., land title settled	60
Actinomycosis, C. T. Caldwell	101	— microscope in medicine	253
Adjustment, Griffith's fine	272	Binding	17
Agricultural Experiment Stations,		Biological notes	11, 16, 39, 67, 89, 113,
.	114, 117, 185	133, 157, 208, 257, 275
Air, deteriorated	113	Biology, practical, V. A. Latham	151
Alterations in manuscripts	126	Black rot of the grape	39
American Society of Microscopists,		Blanchard, F., notes	13, 69, 112, 159,
.	156, 162, 223, 237	209, 255
Amœba, V. A. Latham	151	Blood, circulation of	242
Amphibian eggs, to treat	11	— crystals	219
Aniline colors	211	— fresh	217
Animals, contagious diseases in	97	— plaques	218
Anisol red	31	— stains detected	236
Annual rings of trees	275	— technique of, G. C. Freeborn,	217, 241
Apochromatic test	123	Blood-cell counting	22
Apochromatics, Romyn Hitchcock	49	Bolley, H. L., Pucciniæ	169
Apparatus, new	277	Bolton, B. M., bacteria	5
— notes on	83	— bacteriology	105
Army Medical Museum	163	Bone, making sections	10
Aspinwall, J., ventilating bees	273	Botanical laboratories	89, 114
Asymmetry in human embryo	158	— preparations of Walter White	110
Athylin blue	31	Braman, Benjamin	262
Autumn colors	275	Brass polishing	49
Azo-blue	30, 32	Brown-Sequard's discovery	257
Bacillus lepræ, growth of	135	— treatment, G. E. Fell	227
— pyocyaneus	13	Bud sectioning, Henry Shimer	136
— tuberculosis on potato, cultiva-		Bulloch, W. H.	278
tion of	42	Cabinet, The Bidwell	184
Bacteria and disease	255	Caldwell, C. T., Actinomycosis	101
— and tobacco smoke	132	Cancer, emperor's	14
— cultivation of, R. A. Foster	124	— diagnosis of	143
— character of, B. M. Bolton	5	Candor, a plea for	157
— disease producing	100	Canfield, W. B., urinary sediment	269
— influence upon digestion	70	Carbolic acid, F. T. Chapman	127
— in ice, C. Q. Jackson	233	Carmine stains for nerve tissue	66
— relation to fever	117	Carter, F. B., desmids	35, 73
— staining	259	Cell-wall, relations of	90
Bacteriology	16, 41, 91, 135,	Cement for glass	271
.	161, 211, 259	— King's	245
— value of, B. M. Bolton	105	Cestodes in marine fishes	89
Balloch, E. A., trichocephalus dispar	193	Chaney, Jr., L. W., the cray-fish	86
Bausch & Lomb	278	Chapman, F. T., carbolic acid	127
Bees, albino	143, 273	Chlorophyll-bearing cells	113
— ventilating	89, 273	Cholera and drinking water	114
Benzo-Azurin	80	Chrysophenin	80
Benzol	65	Clover rust	11
Benzopurpurin	79, 80	Cockroach, new organ in	89
Bibliography	17, 23, 47	Codfish, red, C. W. Smiley	128
Bidwell, W. D., cabinet	184		

	PAGE.		PAGE.
Color of flowers and fruits	11	Glycerine mounts	65
Condenser, substage	55	Gosse, Philip Henry	92
Congo, red	31	Government publications	43
Conser, H. N., nostoc	246	Gram's method of staining	212
Consumption	67	Grape-vine diseases	275
Contagious diseases, James Law	97	Griffith, E. H., fine adjustment	272
Corn-stalk disease	210	Haplodiscus piger, Weldon	12
Corrections	213	Hargitt, C. W., infusoria	183
Correspondence	163	Heterœcismal puccinæ, Bolley	169
Cover glasses	65	Hickory, sectioning, Henry Shimer,	104, 136
Cray-fish, H. L. Osborn	25, 147	Histological sections	10
— L. W. Chaney, Jr.	86	— studies, Osborn	25, 147
Cronin mystery	187	— Technique, Freeborn	217, 241
Crystal ponceau	31, 32	Histology, elements of	263
— violet	30, 31, 32	Hitchcock, Romyn, apochromatics	49
Crystalline lens	159	— at home	44
Cucumis, soluble carmine	268	— on Zeiss apparatus	123
Cucumbers, mildew upon	208	Hoagland laboratory	4
Cupric sulphate	238	Home health	257
Cyanide	160	Honey, Aspinwall	273
Dark-Field stop, W. Lighton	265	— genuine	88
Deltapurpurin	80	Hydrophobia	67
Dentine, structure of	112	Infected books	160
Desmids, collecting	77	Information for scientists	164
— life history, F. B. Carter	35, 73	Infusoria, mounting, Hargitt	183
— preserving and mounting	78	Instantaneous change of field	164
Detmers, H. J., microscopes	53	Jackson, C. Q., bacteria	233
Diatoms, W. A. Terry	81	James, F. L., mounting	61
Diphtheria, bacillus of	14	Kissing the Bible	44
— etiology of	112	Kühne's methylene-blue	259
Disease, bacteria and	255	— staining tubercle bacilli	260
— of the ovary	256	Larynx, motor center	159
— of swine	90	Latham, V. A., amœba	151
Dissolving apparatus	238	Law, J., contagious diseases	97
Dodder, common	89	Leonard, Dr. P. I	222
Drawing objects, W. J. Simmons	247	Leprosy, bacillus of	135
Druggist, enterprising	180	Lewis, W. J., convention	156
Drury, Ella M.	188	— forensic microscopy	197
Editorial	16, 43, 70, 117, 162, 213, 237, 261, 277	Libriform tissue	11
Eggs of an eel, F. Mather	15	Lichens and their hosts	90
Electric light	157	Lighton, W., dark-field stop	265
Elephantiasis, a cure for	209	Lustig, Dr	146
Emmerich, Sr., Fr. J	279	Macrospores, development of	113
Erethizon dorsatus, F. Tuckerman	181	Magnifying power, finding	277
Exchanges	24, 72, 213	Manual of vertebrates	94
Experiment station work	157	Manuscript alterations	126
Extracts from correspondence	164, 238	Marine laboratory	134
Farrant's medium, C. M. Vorce	149	Mather, F., eel eggs	15
Fell, Geo. E., on elixir	227	Medical microscopy	13, 17, 69, 112, 159, 209, 255
Fernald, C. H., experiment stations	185	Medicine, microscope in, Bidwell	253
Ferns	187	Menstrual organ	69
Fibrin	219	Mercury	160
Finger-prints	89	Mesozoic mammalia	12
Forensic microscopy, W. J. Lewis	197	Metanil yellow	30, 31, 32
Foster, R. A., study of bacteria	124	Methods, new, Freeborn	9, 30, 66, 79
Freeborn, G. C., the blood	217, 241	— application of	9
— new methods	9, 30, 66, 79	Methyl green	30, 32
Fungi, British	133	Methylene blue	211, 259
Gelatine, nutritive	41	Microbes, influence of	69
Germs, yellow fever	40	— in the stomach	133
Ginn & Co.	143, 196	— in snow	134
Girdling a tree	113	Micrococcus tetragonus	15
Glanders, bacillus of	257	Micro-organisms, psychic life of	191
— spores of	42		

	PAGE.
Micro-organisms, staining	84
Micro-photographs	276
Microscope, American, Detmer's	53
— discovery of	143
— examining paper by	143, 274
— in the Cronin mystery	187
— in a land title	60
— investigating the effect of remedies by	188
— in medicine, Bidwell	253
— portable	155
— selecting, Woolman	182
— The	261
Microscopic objects, drawing, Simmons	247
Microscopical notes, Whelpley	65
MICROSCOPICAL SOCIETIES:	
Brooklyn Medical	280
Essex Co., N. J.	18, 45, 93
Illinois State	94
Iron City, Pa.	19, 71
Leavenworth, Kans.	46, 190, 239
Manchester, England	71
New York	93
Pathological Club	137
St. Louis Club	238
San Francisco	45, 71, 138, 189, 190, 214
Torrey Botanical Club	21, 279
Troy Scientific	94
Vermont	214
Washington	21, 46, 119, 165, 279
Microscopists, energetic	261
Microscopy, forensic, W. J. Lewis	197
— competition in	70
Microtome, the King	83
Mills, Henry	88
Moore, V. A.	41, 91, 135, 161, 211, 259
Mould, H. L. Osborn	1
Mounting, F. T. Chapman	127
— infusoria, C. W. Hargitt	183
— medium, C. M. Vorce	149
— philosophy of, F. L. James	61
Morbid growths	210
Mosquito, organs of	11
Moss, a new	90
Motions of diatoms, W. A. Terry	81
Naphthol alpha	188
National magazine	282
Natural History Society	118
Nervous influence on cell life	143
Newcomer, F. S.	262
Nostoc, H. N. Conser	246
Notes	143, 187, 277
NOTICES OF BOOKS:	
Annual of Medical Sciences	263
Catalogue of Queen & Co.	264
Chemical lecture notes	215
Christianity and agnosticism	281
College Botany	142
Dissection of the Dog	22
Elements of Histology	263
English Past and Present	167
Etiology of Diphtheria	140
Force and Energy	142, 167
God and Man	142

NOTICES OF BOOKS—[Continued.]

	PAGE.
Home of Shakespeare	22
Homer's Iliad	239
Homer's Odyssey	120
Hypnotism	239
Manual of Vertebrates	94
Merck's Index	94
Microscope Catalogue	240
Myers' General History	262
Plant Organization	281
Plato's Protagoras	215
Practical Latin Composition	240
Practical Microscopy	168
Preferable Climate for Phthisis	141
Proceedings of the American Society	47
Psychic Life of Micro-organisms	191
Psychology of Attention	215
Rhetorical Analysis	141
The Educator	96
Traité de Microscopie	140
Two Great Retreats	167
Ultimate Finance	96
Urine	216
Virginia Summer Resorts	168
Vocabulary to Homer's Iliad	141
Nucina, a new stain	66
Nucleus division	258
Obituary notice	262
Objectives, American	236
— putting names on	278
Osborn, H. L., cray-fish	25, 147
— examination of mould	1
Oscillaria, motions of, Terry	81
Ovary, diseases of	256
Oxy-cyanide	160
Paper, examination of	274
Paste	155
Pasteur Institute	160
Penicillium	1
Peripatus	113
Photo-micrographic apparatus	121
Photo-micrographs, W. J. Simmons	180
Picro-carmin, Weigert's	161
Piersol, G. A., carmine staining	266
Pillsbury, J. H., notes	11, 39, 67, 89, 113, 133, 157, 208, 257, 275
Podophrya, W. J. Simmons	145
Pollen mother cells	133
Postal club boxes	7, 33, 63, 85, 115, 131, 164, 185
Prize essay	14
Prologue to the year 1889	16
Purity of wells	257
Queen Mab	7, 33, 63, 85, 115, 131, 185
Queen & Co.	84, 279
Queries	118, 278
Rabbit pest	134
Rana, blastopore of	12
Respiration of fish	67
Reynolds, R. N., staining	273
Rhizopods	114
Rhodanin	80
Rogers, W. A., determining temperature	224

	PAGE.		PAGE.
Rotifera	133	Taylor, Thomas, tea	227
Royston-Pigott, M. D.	277	Tea, adulteration of	227
Rusts	158	Technique	17, 236
Safranin	30, 32	Teeth, sectioning	10
Scalp diseases	159	Temperature, W. A. Rogers	224
Scientific publications	43	Terry on diatoms and ocellaria	81
Sections for staining	238	Trachoma	69
— of timber	187	Trichinosis	13, 69
Shaving close	271	Trichocephalus dispar	193
Shimer, Henry, sectioning	104, 136	Tubercle bacilli, amplification	277
Silk, artificial	258	— in sputum	209
Simmons, W. J., how to draw	247	— in phthisis	210
— photo-micrographs	180	— staining	260
— podophyra	145	Tuberculosis from cows	158
Slides received	143, 207, 277	— transmission of	14
Smiley, C. W., botanical sections	110	Tuckerman, F., gustatory organs	181
— editorial	16, 43, 117, 162, 213, 237, 261, 277	Typhoid fever	39
— red codfish	128	Typhus bacilli in water	257
Smiley, Robert W.	163	Umbelliferae, North American	133
— convention of microscopists	223	Universal medical sciences	263
Soda, carminate of	31	Unreasonable requests	163
Special creation	162	Urinary sediment, W. B. Canfield	269
Spencer Optical Co	164	Vorce, C. M., Farrant's medium	149
Spirogyra, conjugation of	208	Watch factory	187
Staining zoöspores, Reynolds	273	Water analysis	208
— bacteria, Kühne	259	— supplies	90, 114
— with turpentine	29	Wax cell	136
— carmine, G. A. Piersol	266	Weigert's picro-carmin	161
— cover glass preparations	221	Whelpley, H. M., laboratory notes	65
— fluid, new	40	White, Walter, sections by	110, 164
— Gram's	212	Whittle, C. L	207
— microscopical	30	Wood, strength of	275
— re-agents	161	Woolman, G. S	278
— tubercle bacilli	91, 260	— selecting microscopes	182
— double	30	Wounds, healing of	40
Stowell, Mrs. L.	162	Yeast, a new	258
Subscribers' notices	96, 120, 144, 168, 192, 216, 240, 264, 282	Yellow fever	39, 133
Subscriptions	17	— cause of	158
Swine, diseases of	114	— germs of	40, 160
Taylor, J. E	118	Zeiss's catalogue	84
		— photo-micrographic apparatus	121
		Zoöspores, staining	273

QH
201
A35
v.10

The American monthly
microscopical journal

Biological
& Medical
Serials

PLEASE DO NOT REMOVE
CARDS OR SLIPS FROM THIS POCKET

UNIVERSITY OF TORONTO LIBRARY

STORAGE

