

**American
Wire Rope**

American Steel & Wire Company.

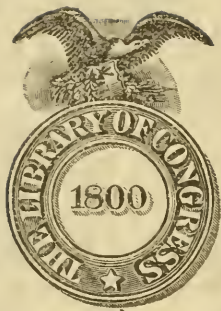

Class TS1787

Book A66
copy 2

**American
Wire Rope**

American Steel & Wire Company

Sales Offices

CHICAGO	72 West Adams Street
NEW YORK	30 Church Street
WORCESTER	94 Grove Street
BOSTON	120 Franklin Street
CLEVELAND	Western Reserve Building
PITTSBURGH	Frick Building
BUFFALO	337 Washington Street
DETROIT	Foot of First Street
CINCINNATI	Union Trust Building
OKLAHOMA CITY	State National Bank Building
ST. LOUIS	Third National Bank Building
ST. PAUL-MINNEAPOLIS	Pioneer Building, St. Paul
DENVER	First National Bank Building
SALT LAKE CITY	Walker Bank Building

United States Steel Products Company

EXPORT DEPARTMENT: NEW YORK	30 Church Street
PACIFIC COAST DEPART.: SAN FRANCISCO	Rialto Building
PORTLAND, Sixth and Alder Streets	
SEATTLE, 4th Ave. So. & Conn. St.	
LOS ANGELES, Jackson & Cent. Aves.	

Warehouses

For the convenience of our customers, we have established warehouses at different points throughout the country from which quick shipment may be made, as follows:

BALTIMORE	KANSAS CITY, MO.	RICHMOND, IND.
BUFFALO	LOS ANGELES	SALT LAKE CITY
CEDAR RAPIDS	LOUISVILLE	SAN FRANCISCO
CHICAGO	MEMPHIS	SAVANNAH
CLEVELAND	NEW HAVEN, CONN.	SEATTLE
COUNCIL BLUFFS	NEW ORLEANS	ST. LOUIS
DENVER	NEW YORK	ST. PAUL
DES MOINES	PHILADELPHIA	TRENTON, N. J.
DETROIT	PITTSBURGH	WICHITA
FARGO	PORTLAND, ORE.	WORCESTER, MASS

American Wire Rope

Catalogue and Hand Book

American Steel & Wire Company

TSITIT
1913
SCOTT

Issued January 1, 1913

TSITIT
1913
SCOTT

TSITIT
1913
SCOTT

Contents

Hand Book Section

	Page
Chapter I. Standard Methods and Facilities for Testing Wire Rope.	10
Chapter II. Materials Composing Wire Rope and their Physical Characteristics.	11-13
Chapter III. Standard Types of Wire Rope Construction —The Strand and Various Combinations of Wires—"One-Size Wire"; "Warrington" and "Seale Type" Construction. Composition of the Various Classes of Rope—"Haulage," "Hoisting," "Extra Flexible," "Special Flexible," "Running Rope," etc. Abbreviated notation for describing Rope. The Structural advantages of different kinds of Rope, their susceptibility to abrasion, flexibility, strength, etc. Smooth and Flat Ropes, Regular and Lang's Lay.	14-26
Chapter IV. Variety of Uses for Wire Rope of the various types. Examples showing the scope of Wire Rope adaptability.	27-28
Chapter V. Mechanical Theory of Wire Rope. Stresses in Rope from :—(1) Dead and Live Loads, (2) Bending, (3) Impact, on starting and stopping, (4) Slopes, (5) Spans. The maximum stress for Machinery in relation to the strength of the rope. The power derivable from multiple sheave blocks. Mathematical formulæ and stress tables and graphical diagrams. Stresses in guys, and tables and diagrams for guy factors. Factors of safety advisable for various conditions of service. Sizes and kinds of rope for various stresses.	29-66
Chapter VI. Practical Hints and Suggestions. Gauging the diameter. Sheaves and Drums, Grooves, Overwinding, Alignment; "Lead" from Sheave to Drum; Wear of Sheaves and Drums. Disadvantages of High Speed, Reverse Bending and Sudden Stresses. Proper Handling of Wire Rope. Strength of Galvanized Ropes. Lubrication, Power Transmission and effect of Heat on Wire Rope.	67-70
Chapter VII. Instructions for Ordering Wire Rope. List of Items of Information that should accompany orders. Illustrative Sketches.	71
Chapter VIII. Typical Applications of Wire Rope in Practice: Aeroplanes, Cableways, Tramways, Cable Roads, Clam Shell and Orange Peel Buckets, Cranes, Derricks, Elevators of various kinds, Excavating Machinery, Dredges, Ferries, Guying, Loading and Unloading Machinery, Lumbering, Mining Machinery, Suspension Bridges, Stump Pulling, Towing and Oil Well Drilling.	72-118

Catalogue Section

Page

Chapter IX. Lists of Prices, Sizes, Strengths and Proper Diameters of Drums or Sheaves for Round and Flattened Strand Ropes, arranged in the order of their flexibility, commencing with the Least Flexible and running to the Most Flexible; in the following grades, viz.: (1) Iron, (2) Crucible Cast Steel, (3) Extra Strong Crucible Cast Steel, (4) Plow Steel and (5) Monitor or Improved Plow Steel; and for the following purposes, viz.: Transmission, Haulage or Standing Rope, Hoisting, Tiller or Hand Rope, Galvanized Rigging or Guy Rope, Running Rope, Hawsers and Mooring Lines, Deep Sea Towing Hawsers, Bridge Cables, Sash Cord, Aeroplane Strands, Galvanized or Tinned Flexible Aeroplane or Motor Boat Cord, Mast Arm or Arc Light Rope, Sawing Strand for Sawing Sandstone, Clothes Lines, Special Strands for "Messenger" work, Catenary Construction and Lightning Arresters, etc. Round and Interlocked Tramway Strands and Flat Rope. Table of estimated average number of coils of hollow cable clothes line per barrel, packed. Description of Flat Rope, of method of repairing it. Description and prices of American Steel and Wire Shield Filler for lubricating purposes.	119-199
Chapter X. Lists of Prices and Descriptions of Special Equipment and Accessories—Fittings and Methods of Attachment. Methods of joining two Ropes, Thimbles, Clips, Clamps, open and closed Sockets, Regular and Bridge Type, Single and Sister Hooks, Swivels applied to Sockets, Thimbles and Hooks.	200-215
Locomotive Switching, Wrecking and Ballast Unloader Rope with Single and Double Fittings.	216-219
Turnbuckles, Iron Guy Shackles, Heavy Wire Rope Blocks, Sheaves, Accessories, Endless and Special Slings and Pulling in Cables.	220-229
Directions for Splicing, with Illustrations.	230-233
Tables of Power Transmitted, Weights of Materials Handled, Comparison of Strength of Wire Rope versus Manila Rope, Numbers, Dimensions and Capacities of Reels, etc.	234-238
Glossary of Terms used in the Wire Rope Industry.	239-243
Index.	243-247

The Properties of Wire Rope

THE trend of all Evolution is in the direction of greater adaptability of means to ends, and before entering upon the detailed discussions of the modern wire rope in all its variety of applications it is eminently proper to investigate somewhat briefly its true inwardness as a mechanical device. By wire rope is here meant the rope of twisted wire, the successor of the twisted hemp rope, as distinct from the wrapped cable of straight parallel wires often used in suspension bridges. It is by no means as simple a contrivance as it appears, and a brief study of its construction and functions will throw a penetrating light upon how and why it has been responsible for the growth of several enormous industries.

Adaptability in an engineering sense means economy and safety. The wire rope excels in economy for many purposes because of its long life under heavy duty, and because of its superiority in strength per unit of size and weight it is for many uses the only available appliance that has yet been developed. Compared with its hempen predecessor it has the following peculiarities:

- (1) Enormously greater strength for the same diameter.
- (2) Much greater strength for the same weight.
- (3) Equal strength whether wet or dry, which is decidedly not the case with a hemp rope.

(4) Constancy of length under all weather conditions.

(5) Uniformity of strength throughout its length and throughout its life when properly used and cared for.

(6) Greater certainty with which its strength can be computed.

(7) Greater indestructibility.

(8) Far greater variety in types of construction for different uses.

(9) Approximately the same flexibility for the same strength.

(10) Less softness for hand work.

(11) Greater rigidity under stress, and smaller range of elasticity.

(12) Lower cost per unit of strength.

The above list is not supposed to be complete, but it is believed to be fairly representative of all actual working facts. It is apparent that except under certain conditions governing (9), (10) and (11), the wire is a better material for the purpose than hemp.

A hemp rope is composed of three, or sometimes four, strands, each of which is formed by twisting together a comparatively large number of filaments or fibres. These filaments may be single threads of hemp or of yarn spun from a number of these threads or fibres. Since the original threads will seldom average more than three feet long, and often a good deal less than this, it is evident that the strand depends for its continuity of strength upon the binding action of the several helical

fibres under tension in the manner illustrated below. The action of fibres in a strand is identical with that of strands in a rope.

Consider (Fig. 1) in section three circular strands, of equal length, whose centers are A, B and C, and which are laid parallel with each other untwisted and under no tension. Let their common length be denoted by L. Assume now that one end of the rope is fixed, and that the other end is rotated one complete revolution, still without tension. Then the axis of each strand will take the shape of a helix of which the radius of rotation is R, and the pitch is P, somewhat less than L. The length of the axis of each strand is $L = \sqrt{4\pi^2 R^2 + P^2}$ (Fig. 2).

Now apply to the rope a vertical tensile force 3T acting parallel to its axis, and which must act through each strand; and prevent the rope from untwisting by the force H, acting horizontally in each strand. These horizontal forces at each end of the rope form horizontal couples acting against each other and resisted by radial stresses N in the strands. The stress H may be compared to the tension in a band around a water tank resisting the radial forces of the water.

Let $F = \Sigma N$, represent the entire sum of the radial forces in one circumference. Then the radial force per unit of circumference will be $\frac{F}{2\pi R}$, and the forces perpendicular to any diameter will amount

to $\frac{F}{\pi}$ which equals 2H. Therefore $F = 2\pi H$, and the radial force per unit length of a strand = $\frac{2\pi H}{\sqrt{4\pi^2 R^2 + P^2}}$. $3V = T$, and $V^2 + H^2 = S^2$. Note that V must always be less than S, which accounts for the fact that in any rope the strength of the whole is less than the sum of the strengths of the strands. $\frac{H}{V} = \tan \phi = \frac{2\pi R}{P}$. If the angle of friction of the material composing the strands be less than ϕ , then the strands will tend to slide upon each other.

We are now in position to understand many of the observed facts about twisted rope of all kinds. In the hemp rope, the strands are made from yarns that are themselves composed of parallel fibres of short length. It is manifest that the fibres would immediately pull apart upon subjecting the rope to tension were they not crowded together by the forces H. If H is sufficient as compared with V to securely bind the fibres together, their tensile strength will be fully developed. Otherwise when brought under strain they would slide upon each other, and cause the rope to "pull out" without the actual breaking of the fibres. Wetting the hemp fibres will decrease their angle of friction, from which it follows that a hemp rope which is properly designed when dry to develop the proper friction to keep it from pulling out may have as much as thirty per

cent. less strength when wet. The smaller the pitch of the rope the smaller the value of V in proportion to S , and consequently the weaker the hemp rope per unit of diameter. It is therefore evident that if the hemp rope be not twisted enough the elements of it will pull apart, while if twisted too much it will yield in tension under less than its normal load.

In the above discussion we assumed an external couple equal to $3 R H$ at each end of the rope to prevent untwisting, assuming absence of friction between the strands. As a matter of fact this couple $3 R H$ is just what is provided by the friction in the rope itself. It is very much reduced in practice by laying up the alternate layers of yarn and strands in opposite directions, the twist of one layer acting from left to right, while the adjacent ones act from right to left.

The radial components of H tend to draw each strand into the axis of the hemp rope. Therefore, there is a limit to the number of strands that can be arranged around each other in stable equilibrium without a core. Thus three strands, in hemp rope practice, as we all know, make a stable structure, no one strand having a tendency to crowd between the other two, while four strands theoretically would tend to work into three in stable position with the fourth on the outside. Successful four-strand hemp ropes are on the market, the above-mentioned diffi-

culty having been overcome of late years by making the strands of special shape and winding with great care. Thus a much smoother hemp rope is obtained, which, with a longer pitch, should be correspondingly stronger than a three-strand hemp rope.

When a well made hemp rope is stretched beyond its strength, the friction from the H forces is so great as sometimes to cause enough heat to make the rope smoke; the fibres and strands approach each other with a reduction in the value of R , and the generation of internal heat amounting to the applied energy. If A represents the length of the rope before stretching, and B its length just before yielding, then the amount of heat energy developed is $(A - B) \frac{T}{2}$. The action of a hawser used in warping a large vessel into dock against or across a strong tide strikingly exemplifies these facts.

As a rope comes under stress, being more or less elastic it stretches and the pitch increases proportionately. The angle O therefore increases and the ratio of V to H increases, and it thus, up to its elastic limit, becomes more capable of resisting a given load the more it is stretched. Now the pitch of the fibres in the strands of hemp rope is greater than that of the strands in the rope in proportion to their respective diameters. Therefore when stretched the yarns would reach their ultimate stress sooner than the strands, were not

these latter given an initial stress by supplementary twisting during the process of manufacture. There is always some danger—in the older hand made ropes there was great danger—that the inner strands may actually break while the outer ones remain intact, thus leading to the gradual destruction of the hidden part of the rope which is not subject to inspection, and therefore without giving warning of the loss of strength.

The main characteristic of a hemp rope is its flexibility, which is incidental to its twisted structure. The fibres, yarns and strands not being parallel to the axis of the rope, when the latter is bent around a block or sheave the elements composing it are partially free to roll upon each other, thus adjusting themselves more or less to changes in the direction of the axis, and being subject to far less tension and compression in bending than would be the case were they laid up parallel to the axis. They are, however, subject to some direct tension because they are not entirely free to roll, and it is this tension coupled with torsion and rubbing together in the rolling process that destroys any rope—either hemp or wire—going over a small sheave faster than one going over a large one. By the nature of this problem it is evident at first sight that a mathematical investigation covering all the factors, particularly those of rolling and torsion in the individual wires, would be very elaborate and complicated and

would cover ground upon which we have but little experimental data, so it has not yet been attempted, but it is equally clear that the flexibility is very dependent upon the arrangement of the elements in the rope. Flexibility in a wire rope is increased by the insertion of hemp centers, etc.

When a wire rope is not under stress the individual wires are pressed together only by the initial stress caused by the twist, and adjacent wires touch each other only at the helical loci of their common tangent points. When a heavy load is applied the wires are crowded together, generating a considerable amount of pressure between adjacent wires, and consequently compressing each other and the hemp centers if there are any. Hence, besides an elongation due to longitudinal strain, there is a lengthening caused by the change of pitch due to the lessening of the mean diameter of the rope through the H forces described above. The unit strain for the same unit stress is therefore a good deal greater than in the case of a steel bar or wire. If λ be the strain in the length P, and T be the tension on a steel area a, neglecting the strength of the hemp centers, which cannot be considered on account of the vast difference between the Modulus of Elasticity of hemp and that of steel, then $\frac{\lambda}{P}$ is the unit strain and $\frac{T}{a}$ is the unit stress. Therefore E, the

Modulus of the rope, will be $\frac{T}{a}$ divided by $\frac{\lambda}{P} = \frac{PT}{a\lambda}$. The quantity λ is the only one that will be materially affected by the twisting of the wires, since a is the cross sectional area of the metal. We see that λ will be much larger for a rope than for a bar or chain, and therefore E will be correspondingly smaller. It is apparent from the above that no one value of E will do for all kinds of wire rope; the more the twist and the larger the proportion of hemp in the rope, the larger will be the value of λ and the smaller that of E . For practical purposes of ordinary computation a compromise value for the different classes of wire rope has been determined as a fair average for general experience. See Chapter V. Section 2.

Still another fact is apparent from a consideration of the last named formula. As the wires get stretched and crowded more and more into what may be called a permanent position, there will be less and less movement of the wires about each other upon the application of tension to the rope. Therefore as the rope grows older in use the value of E may be expected to increase unless the permanent set of the wires is interfered with by the bending of the rope around sheaves or drums. In general, then, when used on very large drums or sheaves the value of E tends to increase, while on small drums the opposite will be the case. Reduction in the value of

E may also be caused by gradual deterioration of the hemp centers, in wire ropes used for long periods.

In modern construction and mining work ropes of great length are very generally used, and the weight of the rope itself is a considerable item in the total load that the upper end of it has to carry. The upper end, then, must undergo a heavier stress than the lower end. The lower end, however, is subject to more severe impact stresses than the upper, since before raising a load, be it a bucket or skip or mine car, there is a slack to be taken up. This slack comes out with a jerk when the rope becomes taut, and develops an impact stress that is difficult to estimate. The jerk or impact is absorbed by the elasticity of the rope more and more in proportion as the impact wave travels away from the impact point. Therefore it is minimum at the top. We thus have the heaviest load stresses at the top and the heaviest impact stresses at the lower end, and for this reason it is the two ends rather than the middle that should be examined periodically for deterioration. Of the two the lower end is more dangerous than the upper, because the upper end is usually wound on a drum in a nice, warm, dry engine house, while the lower end is generally exposed to wet, hard knocks, twists and various other abuses. See Chapter V. Section 3.

In a solid bar of steel, such as a chord member in a bridge, the "straining" or elongation and

shortening of the material is accompanied by molecular motion of its particles. In a rope, besides this molecular motion of the particles, there is a molar motion of the units, fibres or wires, comprising the structure itself. The loss of power incidental to this molar motion can be very largely reduced by the use of internal lubrication, which is a comparatively recent development in wire rope practice. The consequent reduction of internal friction makes for a high mechanical efficiency of tackle, and eliminates a great deal of destructive effect of intermittent stresses on the rope itself. This is applicable to straight ropes that do not carry a quiescent load, but more particularly to all ropes that run over sheaves and drums. External lubrication, also, is valuable where the rope is subject to corrosive action or mechanical attrition.

Hemp rope deteriorates with age and with use. Wire rope deteriorates with use, but not with age when properly cared for, and the rate of deterioration depends, among other things, on the following factors:

- (1) Character of the metal.
- (2) Arrangement of the wires.
- (3) Ratio of the stresses to the strength.
- (4) Ratio of the maximum to the minimum stress.
- (5) Diameter of sheaves and drums.
- (6) Corrosive and abrasive external effects.
- (7) Quality of lubrication, internal and external.

To guard against deterioration frequent inspections and occasional tests of the rope are important, particularly when the rope is used for handling men. In different European countries there are well defined rules for testing and inspecting and in this country many of the States have laws intended to guard against breakages in service. The practice here has not yet been satisfactorily standardized as between the different States. Although in a wire rope the pitch of the inside strands is not the same as that of the outside ones, the outside wires are more likely to break than the others on account of the greater bending stresses of drums, etc. The binding action of the twist, that in a wire rope is not accompanied by initial torsion, is such as to equalize and distribute the strain on all the wires between the center and the circumference in a way that is analogous to the action of the reinforcing steel in a concrete beam. As a corollary to the above, external inspection of a wire rope is much more to be depended upon than outside inspection of a hemp one. If the visible wires are sound it is altogether probable that the inside ones are, too. This fact should not, however, be taken as an excuse to neglect regular and careful tests.

A long rope, such as a mine hoisting cable, is subject to vibrations which become intensified at the load end, with the effect of causing a more rapid fatigue of the

metal at the point of attachment to the car or skip than elsewhere. We therefore recommend cutting a few feet off of this end periodically and refastening the rope as before.

By using in combination the qualities of flexibility and tensile strength, all the various contrivances of sheaves, pulleys and drums are applied for the transmission and multiplication of power. When a rope is bent against its own resistance, work is performed on it, and this work necessarily reduces the efficiency of the tackle. In ordinary manila tackle with blocks

of good quality, the mechanical efficiency of a six-ply rig, for example, is likely to be between seventy and eighty per cent. of the theoretical figure, the remaining power being dissipated in the friction of the blocks and the work done by bending and stretching the rope.

An important factor in the consideration of ropes is the efficiency of the various forms of knots and splices. For manila rope the following results were obtained in tests at the Massachusetts Institute of Technology, viz.:

Efficiency of Knot	KIND OF KNOT
90%	Eye splice over iron thimble.
80%	Short splice in the rope.
65%	Timber hitch, round turn, half hitch.
60%	Bowling slip knot, clove hitch.
50%	Square knot, weaver's knot, sheet bend.
45%	Flemish loop, overhand knot.

These percentages are in terms of the full strength of the rope.

The mechanical applications of rope may be divided into the following classes:

I. Static, such as guys, bridge cables, shrouds, etc.

II. Kinetic, such as power transmission lines, running ropes, tackles, etc.

In the static class there will be no bending stresses, except such as are incidental to the anchorages and splices. These by various mechanical contrivances are now capable of a very large percentage

of efficiency, in contrast to the knot factors of hemp rope mentioned elsewhere in this chapter. For static use flexibility is no object, and the most satisfactory types of rope for this purpose are therefore the dense ones of few wires and long pitch, thus giving the smallest cost and greatest durability for the required strength. A form of static rope is that used for cableway main cables, wherein the rope acts as a monorail besides acting in static tension, and suffers attrition of the outer wires. Special twisting of the outer strands and

such construction as the interlocking wire rope are peculiarly adapted for such a purpose, since they combine economy of cost and weight with a comparatively smooth wearing surface. The span of the main cable in cableways often controls the kind of material that must be used in the wires of the cable. If the spans are reasonably short the stresses in the cable from its own weight are small as compared with those from the load, and an ordinary steel wire of low price is suitable. Where the spans are long, however, and where, from the topography of the ground, the amount of allowable sag is limited, the stresses from the weight of the cable become very important and wire of a higher tensile strength and higher price must be used. A careful study of all the conditions, as well as an intimate knowledge of the various classes of rope on the market, is necessary in order to select the most economical one for the purpose. See page 53.

For kinetic uses a rope of considerable flexibility is necessary. Mine hoists, for deep working, generally have drums of fairly large diameter, and the load carried by the rope is very considerable, besides which the weight of the rope, when the car is at the bottom, is a large item. Therefore, for this purpose a strong high tension material is necessary, together with moderate flexibility. For use with derricks, cableway falls, elevators and hoists, where the loads are comparatively light, and where the

rope must run over sheaves of small diameter, flexibility becomes more important and high tensile strength per unit of weight less so. Hence for these purposes we need the hoisting ropes of small and numerous wires. There is a very large variety to choose from in selecting a rope for a specific purpose, and there can be only one kind that will be satisfactory for a particular purpose. Therefore, before ordering any rope, the object that it is intended to fulfill as well as the characteristics of the rope should be thoroughly considered. When in doubt as to which of two ropes to select, it is better to take the chance of erring on the side of too much flexibility than on that of too little. The necessary strength will control the diameter, which can be taken from the tables in this volume. The effect of wear on a hoisting rope is most important. When used on a derrick such as in the construction of a bridge or high building, frequently the fall rope is used in a three-ply combination of sheaves, and where the fall rope is long the rope becomes twisted upon itself by the revolution of the load. The raising and lowering of the load under these conditions, causing the ropes to rub each other while twisting about each other, is highly destructive of the rope.

In the foregoing pages the principal characteristics of the wire rope, and its antecedent, the hemp rope, have been given, and it is believed that a perusal of them

will place the reader in possession of so many of the general facts and conditions of the rope problem, as may be necessary to a good general conception of it. A great deal more of general discussion might be written. There is already an extensive literature on wire rope, and as a mechanical device it represents a large field of investigation not yet covered by the mathematician, the testing expert and the metallurgist. The effects of tension, torsion and attrition acting simultaneously, complicated by temperature changes and the results of corrosion, lubrication and, at times, electrolysis, offer problems at once fascinating and elusive. The fact that many of them are still un-

solved, however, does not detract from the certainty that as produced in the mills of to-day, the wire rope is an appliance that is wonderfully well adapted to a multitude of uses, manifest and undiscovered, with a composition and a structure that can be varied almost endlessly to meet given conditions. It can be made with very great accuracy and reliability under proper service, and not least of its virtues is the fact that for the quantity of goods delivered it is far and away the most economical tool to be had for its purposes. The field of its use and its adaptability to various purposes have grown by leaps and bounds, and were never growing so fast as to-day.

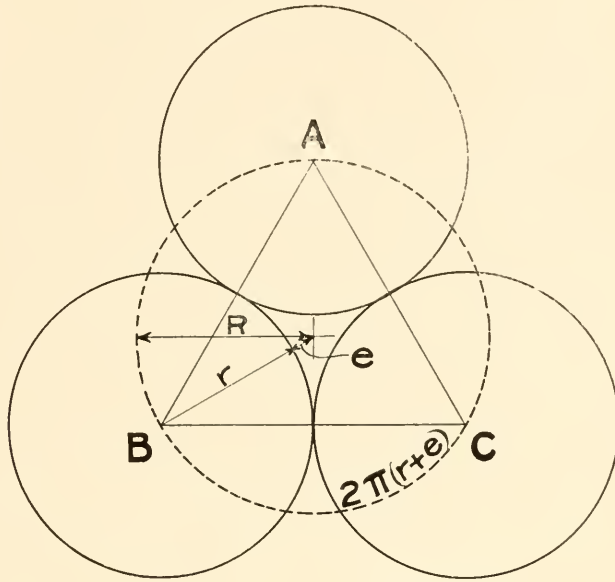

Fig. 1.

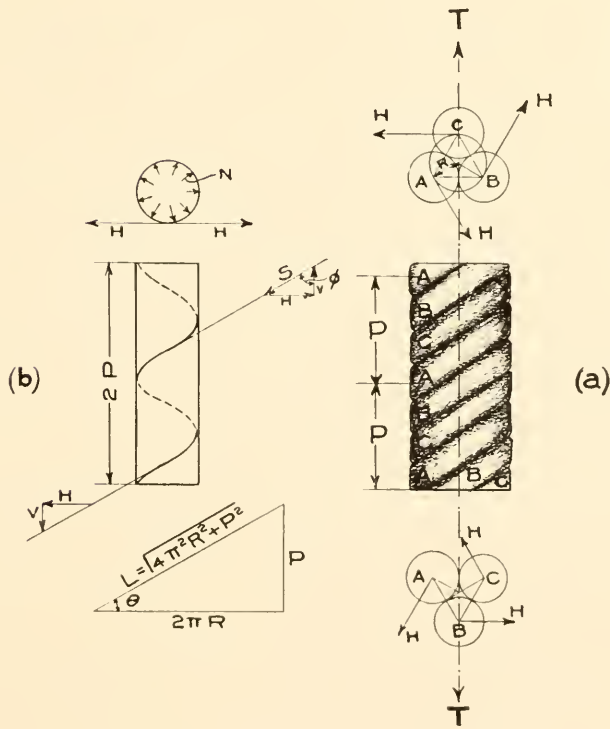

Fig. 2.

Chapter I

Standard Breaking Strengths of Wire Rope

The demand for accurate information regarding wire rope has led the various manufacturers of the United States to adopt standard figures for the strength of all sizes and qualities of rope. It was formerly the practice of most manufacturers and nearly all users of wire ropes to test the individual wires and to consider their combined strength as the strength of the finished rope. Strengths thus obtained were greater than actual strengths obtained by breaking the ropes as a whole. It was on this account that the standard strengths now given in this catalogue were adopted, all figures representing actual breaks. In no case was the intrinsic strength of the ropes reduced, but more accurate and scientific data are shown in the line of progress. With some constructions and qualities of rope, the strength given represents 95 per cent of the total strength of the wires taken singly, but in other cases with different constructions it may run down to 80 per cent or even less. The question which interests the user is whether a rope will stand when new the strain given in the tables, and we can state positively that our ropes will meet the strengths given herein if properly tested.

Method of Testing American Wire Rope

The testing of a wire rope is not a difficult matter, but it must be properly done or it is valueless. All finished wire used in our wire rope is given a rigid test on both ends of each coil to determine its strength, toughness and uniformity. No coil of wire that fails to meet the rigid tests is used in American wire rope. We have not only the latest and best methods of wire testing, but we have the most improved machinery capable of testing to rupture any wire rope shown in this catalogue. Tests are constantly being made of finished ropes to assure their adherence to the standard strengths given in the tables.

The strengths given are correct only for our standard product of the construction shown, it being obvious that any variation or modification of the standards would somewhat alter the strength of the rope. We have figures for these modified constructions and qualities and can furnish them when required.

These testing facilities are complete from a machine for the smallest wire to one for the largest rope listed herein, so that customers may rely absolutely on the information given.

Chapter II

Material in Wire Rope

Wire ropes are made almost exclusively from iron or steel and there have been applied to the various grades of strength of materials certain names which have clung to them until they can hardly be dispensed with. To many perhaps these terms have been more or less misleading or confusing. It is our intention to set this subject briefly before the trade so that there may be a clear understanding of the various trade names used in this catalogue.

The materials used in the wire ropes as described in the succeeding pages are grouped into five main divisions as follows :

1. *Iron.*
2. *Crucible Cast Steel*
3. *Extra Strong Crucible Cast Steel*
4. *Plow Steel*
5. *Monitor, or Improved Plow Steel and Tico Special*
6. *Hemp Centers.*

First: IRON—This material was used almost entirely in the early days of rope manufacture and is employed to a limited extent at the present day, although by no means so extensively, owing to the development of the stronger and tougher steels. Iron is a very pure material containing very small amounts of phosphorus, sulphur and carbon. The physical characteristics of iron are softness, ductility and low tensile strength, being approximately 85,000 pounds per square inch in the drawn wire entering into ropes. This applies to the iron transmission and hoisting rope illustrated on pages 121 and 127. Purchasers of our bright iron rope are assured that it contains the best material that can be produced.

Second: CRUCIBLE CAST STEEL—This brand of steel derived its name from the early method of making carbon steel which could be hardened. This was formerly made in small crucibles capable of being operated by hand and containing from 50 to 100 pounds of steel each. This steel was then cast into small ingots or bars. The same grade of steel for rope is now universally made, both in Europe and America by the Siemens-Martin open hearth furnace, which differs from the original crucible principally in size and amount which can be made at one time. With the old crucible process, each small ingot was of different chemical composition, but with the open hearth furnace, the larger units of steel are of the same chemical composition and each batch from the Siemens-Martin furnace will make a number of large castings or ingots.

When drawn into wire and properly treated, our crucible open hearth steel* will have a tensile strength from 150,000 to 200,000 pounds per square inch of sectional area, depending upon the size of finished wire and the properties required.

Third: EXTRA STRONG CRUCIBLE CAST STEEL—This, as its name indicates, is a stronger grade of crucible open hearth steel of somewhat different chemical composition, the strength of which runs from 180,000 to 220,000 pounds per square inch of sectional area, depending upon the size of finished wire and properties required.

Fourth: PLOW STEEL—This name originated in England many years ago, and was applied to a strong grade of crucible steel wire which was used in the construction of very strong ropes employed to operate gangs of plows.

The name of “plow steel,” as applied to rope, means a high grade open hearth steel of a tensile strength in the wire of 200,000 to 260,000 pounds per square inch of sectional area, depending upon the size of the finished wire and the properties required. The name, although somewhat vague and unsatisfactory, has been associated with the trade for a long time.

Fifth: MONITOR, OR IMPROVED PLOW STEEL AND TICO SPECIAL—We have adopted the trade names of “Monitor” and “Tico Special” for the strongest grades of wire rope which we produce. These are made of very carefully selected open hearth steel wire having a tensile strength from 220,000 to 280,000 pounds per square inch of sectional area, depending upon the size of the finished wire used in the rope. These are the toughest materials of high strength that have yet been produced. They have a large and constantly growing field of use.

Sixth: Hemp centers are usually employed in wire ropes to form an elastic cushion for the strands of the rope to rest upon. These are selected with great care and only the finest and most uniform fiber is used.

The merits of these various grades of materials may be summarized briefly.

Iron This is a low tensile strength material, very soft and ductile, but the heaviest in proportion to its strength and consequently of only limited usefulness.

Crucible Cast Steel This is a medium tensile strength material, tough and pliable, of moderate cost and general utility. It weighs only about one-half as much as iron for the same strength and its lightness makes it very efficient. It is harder than iron and better resists external wear.

*The term open hearth steel must not be confused with crucible open hearth steel, as the latter applies only to the higher grade of material of crucible quality, whereas the former may mean any grade of steel produced by the open hearth furnace.

Extra Strong Crucible Cast Steel This is a grade midway between crucible steel and plow steel in tensile strength, and is a very serviceable material, tough, pliable, a little lighter for the same strength than crucible steel, and about two and a half times the strength of iron.

Plow Steel This is next to the strongest material used in wire rope, combining lightness and great strength. It is tough, but somewhat stiffer than crucible steel, and possesses very nearly three times the strength of iron.

Monitor, or Improved Plow Steel This is a little stiffer in the same diameter than the preceding kinds, but strength for strength equally flexible. It is very useful where great strength, lightness and abrasive resisting qualities are required. It is the toughest steel of its strength that can be produced, and is fully three times as strong as iron.

Tico Special Steel This special grade of steel wire is used in the manufacture of Tico special ropes, which possess the highest degree of resilience and strength possible without sacrificing the inherent elasticity of the material. For list prices, see Monitor rope.

The manufacture of these various grades of steel is an art in itself, which has been perfected after a half of a century of effort to its present high standard by the American Steel & Wire Company. Consumers may be assured that the materials used to-day in rope manufacture are more reliable than at any time in the past. The selection of ingredients going into the production of our rope steels is more carefully and scientifically handled and the resulting product more uniform than has hitherto been deemed possible.

It will be found that the materials entering into American wire rope contain the smallest possible amounts of phosphorus and sulphur, the deleterious effects of which are well known. Every heat of rope steel made is carefully analyzed and checked, and only such as conforms to our rigid chemical tests is ever used for wire rope. The same watchful supervision is given every process in the manufacture of the wire for the finished rope. The steel must be cast into ingots, rolled into billets, re-rolled from billets to small bars and then into rods before it reaches the wire-drawing stage. These rods must then be cleaned, drawn, given successive heat treatments and further drawing until the wire has been brought to the finished point. If at any of these stages the material shows mechanical defects, however slight, it is rejected, and every coil of the finished wire is given further exacting tests, all to determine its quality, which is the keynote in the production of American wire rope.

Chapter III

Constructions

In the development and application of wire rope there have been devised many constructions, some good and some bad, but in course of time odd combinations of wires have been discarded and certain types have become standard. These standard constructions constitute the greater percentage of the wire rope ordinarily used in commercial work to-day.

Wire rope as now produced consists of a group of strands the wires of which are twisted together symmetrically according to a definite geometrical arrangement. A group of strands is correspondingly laid symmetrically around a center core or neutral axis.

Strands

The fundamental unit in rope construction is the strand, and a short explanation of this is necessary to place the subject logically before rope users. To begin with, a vast number of geometrical combinations of wires are possible, but for ordinary work the practice is to use one wire in the center of the strand, surrounding this with a layer of six wires, then successively with layers of twelve, eighteen, twenty-four and thirty wires, etc., this construction being known as concentric strand.

1 + 6 + 12 + 18 + 24 + 30



1	+	6	+	12	+	18	+	24	+	30
1		7		19		37		61		91
Wire		Wires		Wires		Wires		Wires		Wires

The addition of one layer of six wires around a center wire produces a strand for a haulage rope. A supplementary layer of twelve wires makes a nineteen-wire strand for a hoisting rope. This strand in turn may be covered by a third layer of eighteen wires, making a thirty-seven-wire strand that is used in a special flexible hoisting rope. In connection with illustrations of strands of uniform diameter it is evident that the greater the number of wires in the strand, the more flexible will be the rope constructed therefrom.

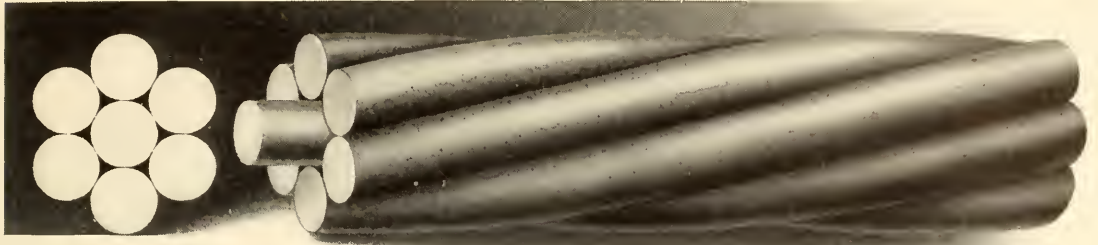

7 Wire Strand



19 Wire Strand

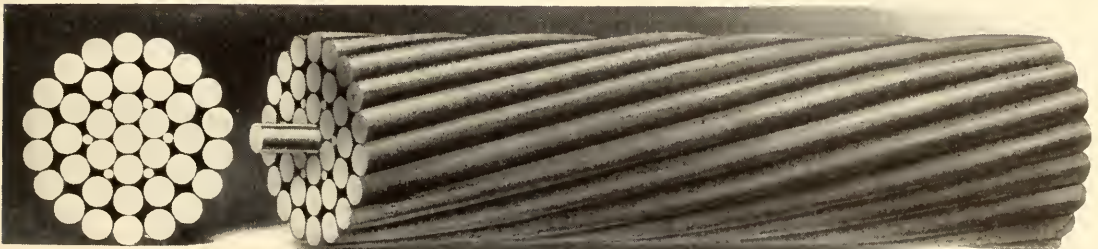

37 Wire Strand

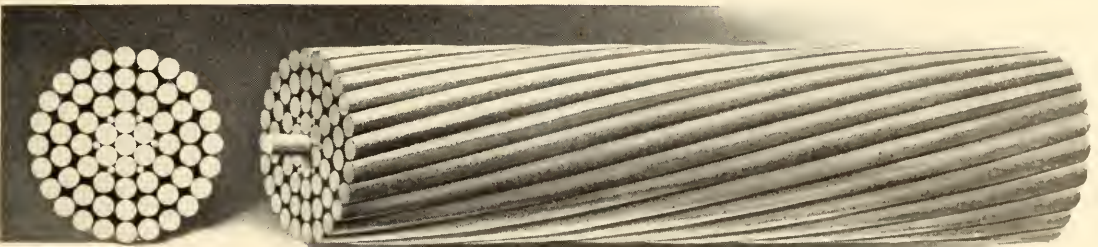

61 Wire Strand

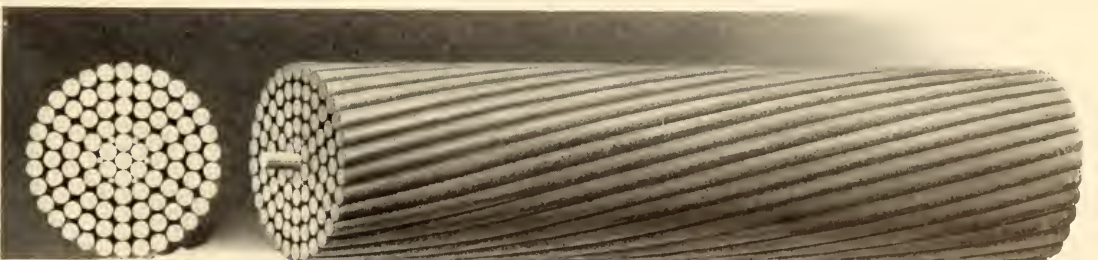

91 Wire Strand

In the making of standard hoisting ropes, i. e., of six strands of nineteen wires each, certain desirable features result from a slight modification of the strands and wires :

1. Common *one-size-wire* construction, nineteen wires all of one size, is the simplest hoisting rope strand made.
2. *Three-size-wire* construction, sometimes called "Warrington" construction, consists of seven inside wires of uniform diameter surrounded by twelve wires which are alternately large and small. This combination increases the metallic area and strength by approximately ten per cent. Experience has demonstrated the advantages of this construction for general hoisting purposes and has led to its adoption in the manufacture of standard steel hoisting ropes.
3. *Seale* construction, in which the center wire is large, the next layer of nine wires small and the outer layer of nine wires large. These strands produce a rope somewhat stiffer than the first two mentioned. See further reference to Seale construction.

It is possible to make strands using two, three, four or five wires in place of one center wire, and to cover these wires with successive layers of wires, but these constructions are rarely used and have little commercial value. There are a few cases where odd constructions are advisable, and we shall be glad to give our customers any information necessary upon application.

The types of concentric strand shown in the preceding illustrations are compact, present a uniform external surface to take wear and give a wide range of flexibility.

Rope

A number of strands, usually six, are laid together around a hemp center to form a completed rope. In the order of their flexibility from coarse to fine constructions they are

- 6 strands, 7 wires each, known as "*haulage rope*"
- 6 strands, 19 wires each, known as hoisting rope, "*Seale type*"
- 6 strands, 19 wires each, known as "*hoisting rope*"
- 6 strands, 37 wires each, known as "*special flexible*"
- 8 strands, 19 wires each, known as "*extra flexible rope*"
- 6 strands, 12 wires each, known as "*running rope*"
- 6 ropes, 6 strands, 7 wires each, known as "*tiller or hand rope.*"

In describing a rope construction it is customary to use the following abbreviated notation, e. g. 6 x 7, which means six strands of seven wires each, the number of strands coming and the first number of wires last.

Haulage, Transmission and Standing Rope Construction



The coarsest rope, i. e., the 6 x 7 construction, is a relatively stiff rope with large wires capable of resisting external wear or abrasion, but it is the least flexible type shown and its use is limited to conditions where abrasion is excessive and bending around sheaves is a minor feature. See chapter on "Practical Applications," page 72.

Seale Construction

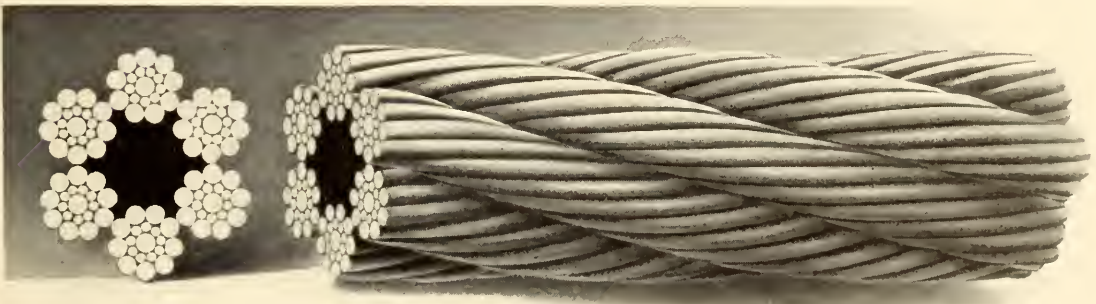

The next rope in point of flexibility is the 6 x 12 with one hemp core (each strand composed of three wires covered by nine wires), or better still the 6 x 19 Seale type. The use of the 6 x 12 construction is not recommended, as it makes a poor rope structurally, and the 6 x 19 Seale type is not only identical so far as external surface of the strand goes, but is properly constructed internally. The name "Seale type construction" is applied to a rope each strand of which is composed of one large center wire surrounded by nine small

wires and then by nine large wires, making a perfect mechanical construction. The Seale type is suited to a limited number of applications and is sold at the same price as the regular 6 x 19 construction.

Hoisting Rope Construction

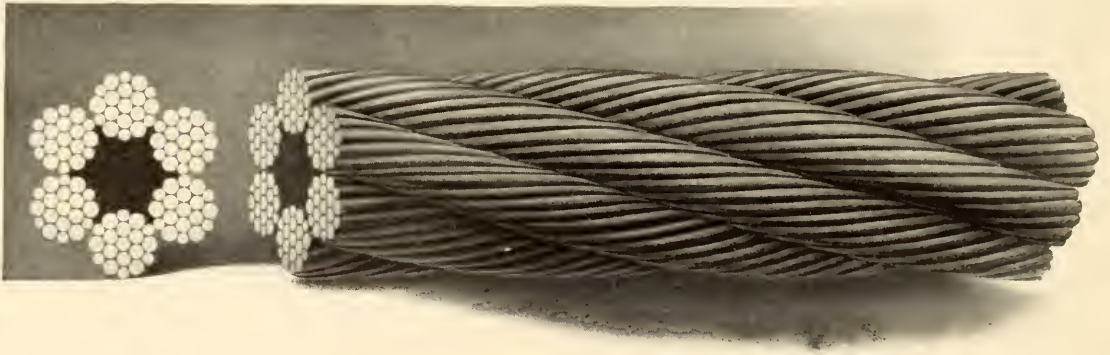

The next step toward flexibility is the 6 x 19 construction, known universally as hoisting rope, due to its application to general hoisting purposes. The wires are smaller than in the 6 x 7 haulage rope and are less able to resist abrasion, but can be more easily bent around sheaves and drums.

Special Flexible Hoisting Rope Construction

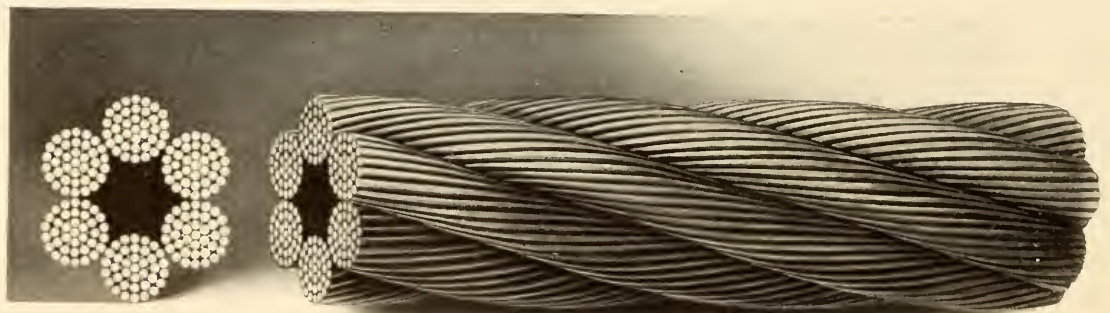

The 6 x 37 special flexible rope is composed of still smaller wires than the 6 x 19, possesses great flexibility and may be bent round fairly small sheaves, but it should not be subjected to much external wear, particularly in the smaller sizes, as the wires will be worn off too quickly.

Extra Flexible Hoisting Rope



The 8 x 19 extra flexible rope has more flexibility than the 6 x 19, being composed of two additional strands, and may be used over smaller sheaves than the latter. It is about as flexible as the 6 x 37 construction but not as strong, owing to its larger hemp center.

Running Rigging Construction and Mooring Hawsers



The 6 x 12 running rope is a modification of the 6 x 19 construction, being identical so far as external appearance goes, having a hemp core in each strand or seven in all. This type of construction is more flexible than the 6 x 19 but only about two-thirds as strong.

Tiller Rope Construction



The 6 x 6 x 7 tiller rope construction makes an exceedingly flexible rope, and is capable of bending around very small sheaves. It is the most flexible standard rope on the market to-day. Being composed of very fine wires it will stand less surface wear than any type mentioned and the load should be light.

Special Constructions

In addition to the preceding constructions there are a number of special constructions which have been developed to meet unusual conditions. The particular qualifications of each are referred to in the following pages.

Non-spinning Rope, 18 Strands 7 Wires



This is a special construction of hoisting rope designed to prevent the rotating of a free load on the end of a single line. It is the only type of rope that really does accomplish this and is excellent for the purpose for which it is designed.

Flattened Strand Ropes, Hoisting and Haulage



Type A

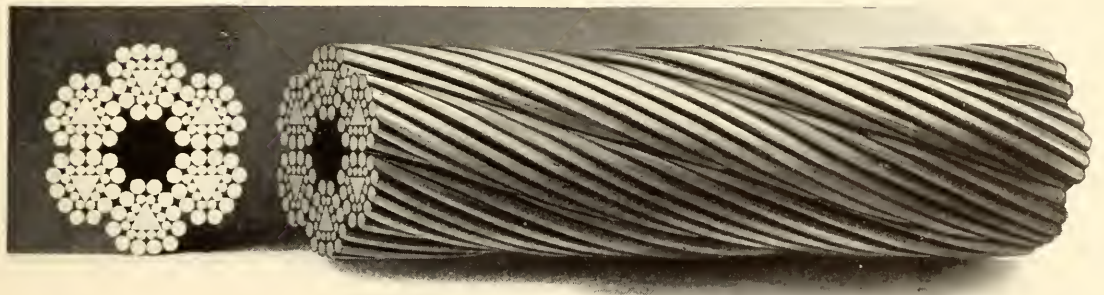

Type B



Type C



Type D

**Type E**

These five styles of flattened strand have been designed to secure greater wearing surface and at the same time to retain as much flexibility as possible. It will be easily seen from an examination of the illustrations that these ropes more nearly approach a solid bar so far as external surface is concerned than is possible in the case of any style of rope made of round strands. In fact, flattened strand ropes possess about 150 per cent more wearing surface than the ordinary round strand rope. This is a distinct advantage for some wire rope applications where external wear on the wires results in a considerable decrease in strength as well as shorter life of the rope.

Types C (5 x 9), D (6 x 8), and E (5 x 11) correspond in general to the 6 x 7 round rope, and types A (5 x 28) and B (6 x 25) to the 6 x 19 construction in the general line of flexibility and usage. Their further uses are explained in detail under the various lists, pages 145 to 154.

Steel Clad Hoisting Rope

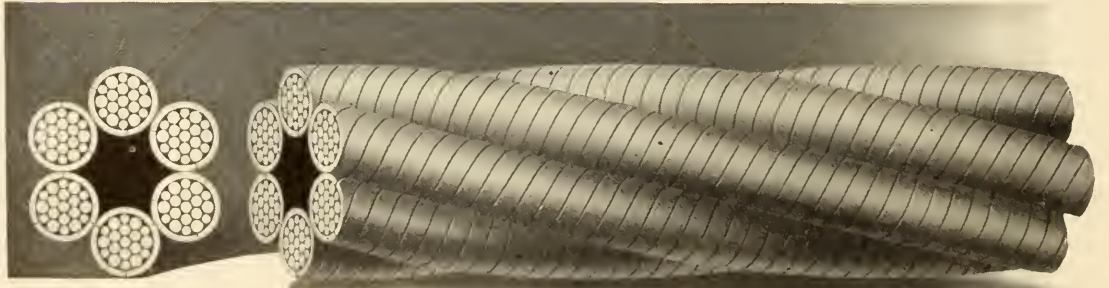

This kind of hoisting rope has each strand spirally served with flat steel strips, which give considerable additional wearing surface over the ordinary type. In fact, when the flat strips of a steel clad rope have worn through, there still remains a complete hoisting rope with unimpaired strength. Where ropes wear out quickly, this feature is a distinct advantage.

Flat Rope

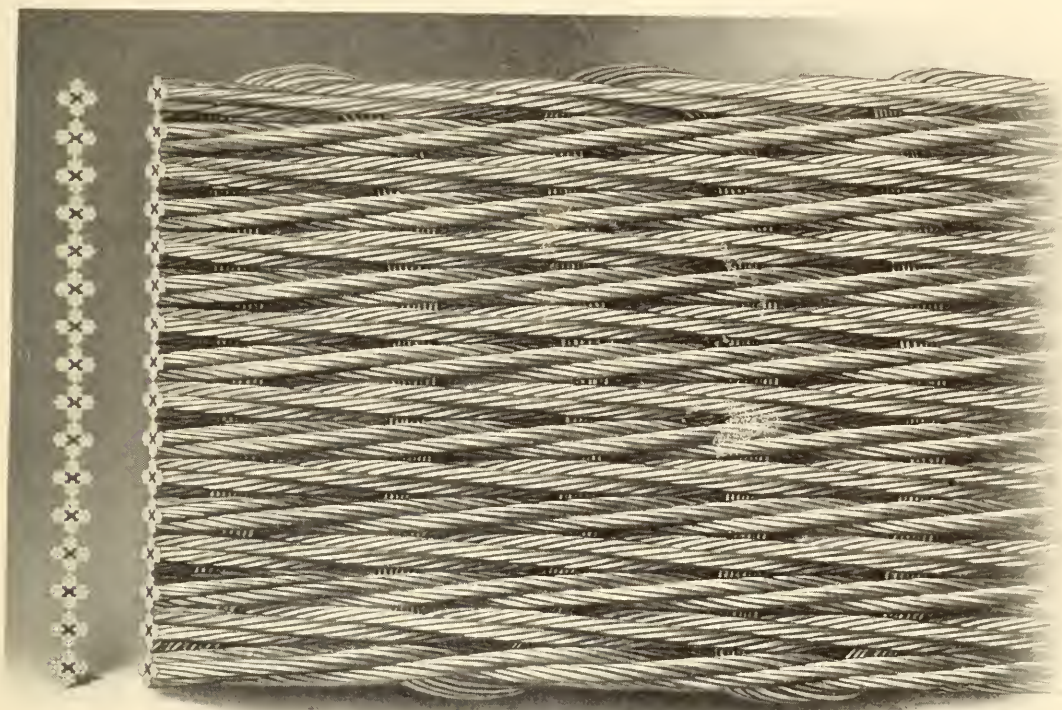

This rope corresponds to a flat wire or ribbon and might be likened to a flat clock spring in this respect, that it will wind upon itself in a very narrow space. Some conditions are eminently suited to this type of construction, which can be made in any reasonable width, thickness or length. Further information regarding uses will be found on page 194.

Round Track Cable for Aerial Tramways



Locked Wire Cable

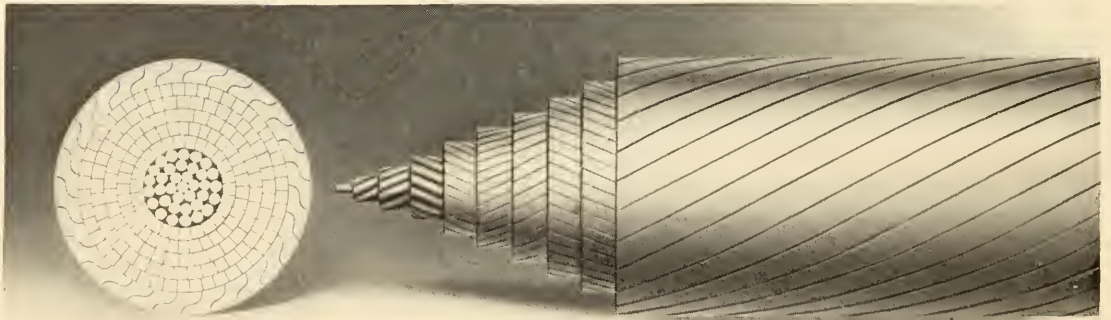

For cable spans or cableways there have been devised two special cables which present fairly smooth surfaces for wheels to run upon. The better is the interlocked type, as it presents the smoother external surface. See also pages 190-191 for further details.

A point that should be noted in the foregoing discussion of wire rope constructions is that in going from a coarser to the next finer construction, or with each increase in flexibility, there is a corresponding decrease in the size of the wires and consequently in the wear resisting qualities. This should be borne carefully in mind in the selection of the type of wire rope to be used for a given application. In this connection a further discussion of this subject is found in the chapter on "How to Calculate Wire Rope Problems," on pages 30-66.

Wire Rope Lays

There are two general methods of laying up rope: the common type known as Regular lay, and the other as Lang's lay.

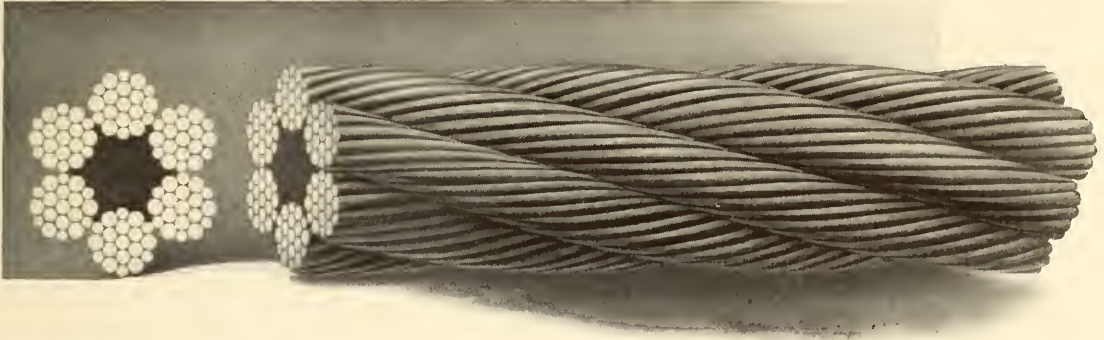

Regular lay, right hand rope, 6 x 19

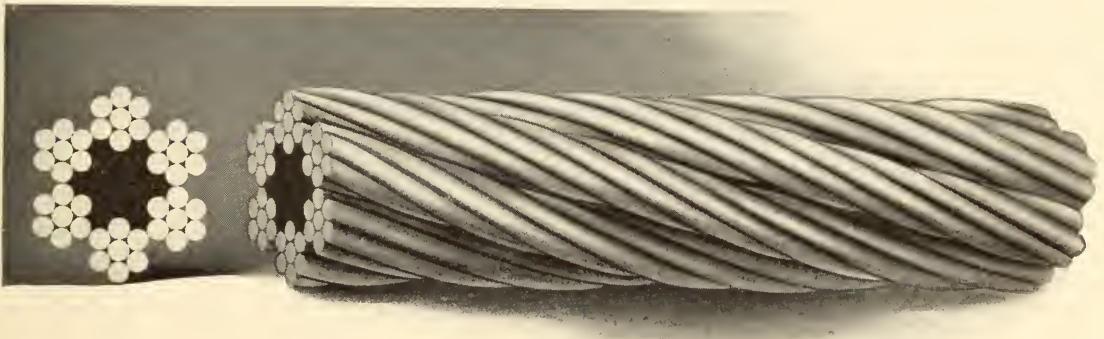

Lang's lay, 6 x 7

In the *Regular lay*, the wires of the strands are twisted in one direction and the strands laid into the rope in the opposite direction, giving the appearance shown in the first illustration. Most of the rope used in America is made in this manner, and it has become standard for general work.

In the *Lang's lay* rope both the wires in the strands and the strands in the rope are twisted in the same direction, giving the peculiar appearance noted in the second cut. *Lang's lay* rope is more easily untwisted than Regular lay and it is more difficult to tuck the strands securely in a splice, but it is especially adapted to resist external wear and grip action. *Lang's lay* rope should not be used without first consulting with us as to its adaptability. No universal rule can be given regarding its application, other than that its use is limited as compared with the standard *Regular lay*.

It will be noted that all flattened strand ropes are made *Lang's lay*. See illustrations on preceding pages 21 and 22.



Regular lay, right hand rope



Regular lay, left hand rope

Rope is usually made right lay, which is standard for all our rope as well as that of all other manufacturers in the United States. Right lay rope corresponds to a right hand threaded screw of long pitch and left lay to a left hand threaded screw of long pitch. The use of left lay rope is limited and confined to rope used in pairs on elevators and similar places where the tendency of left lay rope to untwist in one direction is offset by the tendency of the right lay rope to untwist in the opposite direction. The majority of oil well drilling ropes are also made left lay.



**Reverse lay rope, also known
as right and left lay rope**

This consists of a rope in which the alternate strands are made Regular and Lang's lay. In the case of a six-strand hoisting rope, as shown, there are three strands regular lay and three strands Lang's lay. Not many ropes are made in this way, but this description would be incomplete without reference to it.

Chapter IV

Range of Application

The use of wire rope for mechanical purposes has increased very largely in the past few years, so that it has almost completely superseded the older methods employing manila rope and steel or iron chain.

The scope of application has become universal, involving the selection or at times the designing of a special rope to meet the conditions imposed. It sometimes necessitates a radical departure from the ordinary forms of construction. With the facilities and plants at our command, we can try out rope for every class of service and give our customers not an experiment, but a proven rope. We make a complete line of wire rope for every practical purpose to which a wire rope can be applied. Some of the principal uses to which wire rope may be put are as follows:

Haulage rope for mines, docks, etc.

Hoisting rope for elevators of all kinds, mines, coal hoists, ore hoists, conveyors, derricks, stump pullers, steam shovels, dredges, logging, ballast, unloaders, etc.

Special flexible and *extra flexible rope* for cranes, counterweights, ammunition hoists, dredges and kindred uses.

Flattened strand rope of all kinds for all purposes.

Track cable for aerial cableways, both ordinary and locked types.

All the foregoing ropes except the interlocked track strand are made in all strengths of material, viz.:

Iron.

Crucible Cast Steel.

Extra Strong Crucible Cast Steel.

Plow Steel and *Monitor* grades and may be furnished galvanized if necessary.

The following additional ropes are also made:

Extra Galvanized Standing Rope for derricks, ships' rigging, etc.

Extra Galvanized Hoisting and Running Rope for mooring and messenger lines, cargo hoists, ships' rigging, etc.

Extra Galvanized Hawsers for mooring and towing.

Galvanized Cables for suspension bridges.

Wire Sash Cord, annealed, galvanized or tinned, iron or copper.

Galvanized Mast Arm or *Arc Light Rope.*

Galvanized and *Extra Galvanized Strand* in all sizes.

Special Ropes of every size, construction or quality made to order on short notice. If it is rope or stranded wire we make it.

All sizes of copper cable and strand for all electrical purposes. Also fittings of all kinds for attaching to wire rope.

In the general definition of wire rope is included practically everything that is twisted into strands or ropes. Even wire sash cord $\frac{1}{16}$ inch in diameter is a rope just as truly as a large dredge rope $2\frac{3}{4}$ inches diameter and a small tiller or hand rope as much as a large mine hoisting rope. A small aeroplane stay strand differs from a large bridge cable only in size; both are stranded products. It is difficult to give all the various uses to which wire rope can be put, but from very small to very large sizes they cover a wide range of utility. Almost any special type of construction may be made if required by the conditions of use.

It will be seen from the foregoing summary that wire rope in its various sizes is adaptable to the most delicate mechanisms, as well as to the handling of the heaviest and largest machinery. Its adaptability is one of its strongest merits.

See also chapter on practical wire rope installations pages 72 to 118.

Chapter V

How to Calculate Wire Rope Problems

Chapter V

How to Decide Size, Quality and Construction of Wire Rope

In discussing this important question, around which hinges the successful use of wire rope, we will consider it under two general headings.

A.—STRESSES.

B.—SIZES AND QUALITY OF ROPE TO MEET THE STRESSES.

Under Stresses, the following detail sections will be taken up in the order given :

	Page
1. <i>Dead and live loads</i>	30
2. <i>Bending stresses</i>	31
3. <i>Stresses due to shocks of starting and stopping</i>	47
4. <i>Stresses of inclines and slopes</i>	49
5. <i>Stresses in spans</i>	53
6. <i>Stress limitations of machinery</i>	58
7. <i>Multiple sheave blocks</i>	58
8. <i>Wire rope guys</i>	60
9. <i>Factors of safety</i>	64

The above nine sections constitute the principal factors requiring consideration in wire rope operations.

A.—Stresses

Section 1

Dead and Live Loads Wire rope applications divide themselves into two general classes, one in which the load is stationary and the other in which it is movable or fluctuating. It is a comparatively easy matter to estimate the stresses in a rope when the loads are what might be termed dead loads, such as occur in guy ropes and similar uses. On the other hand, a live load immediately brings us to a point where a number of factors must be carefully considered. The principal factor of course is the changing of motion of the load. All loads are dead loads until they begin to move and then they become live loads. The effect of a live load at times is not very greatly different from that of a dead load, provided the stress induced is uniform, but there are many cases where the load is started and stopped quickly and such cases result in a series of stresses due to shocks of starting and stopping. Stresses due to shocks of starting and stopping will be considered under Section 3, of this chapter.

Section 2

Bending Stress on Wire Rope The subject of this section is not a new one by any means, but it has been regarded by many wire rope users as of no practical importance. This view of the case is erroneous, and we shall endeavor to show that it is not only important, but neglect of consideration often leads to very poorly designed apparatus and subsequently high maintenance charges, discouraging both to the user as well as to the builder. The user often finds his maintenance charges excessive, and it is difficult at times for him to understand clearly that his rope conditions are at fault.

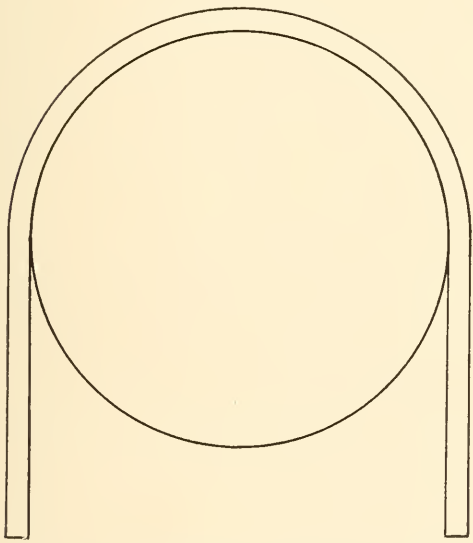

SOLID BAR BENT AROUND DRUM

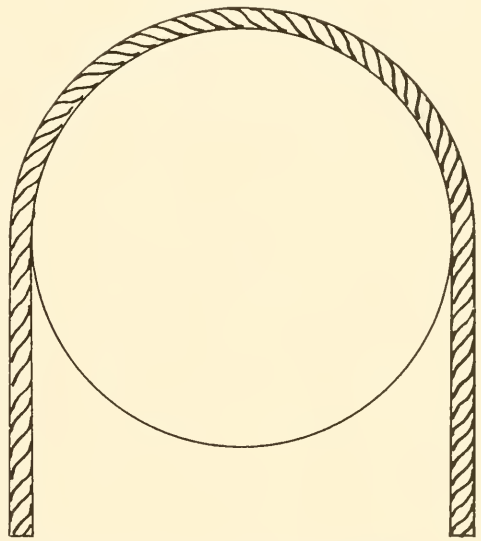

ROPE BENT AROUND DRUM

The bending stress in a wire rope, as we define it, is the stress which is produced in the metal composing it when the rope is bent around a sheave or drum of any diameter. Unlike ordinary stresses it does not appeal to the eye of the rope user in the same way that a live or dead load does, but it exists to a greater or lesser degree in all wire rope applications. It takes its toll, whether it is recognized or not, and while it is not possible to eradicate it entirely, still when its value is known its deleterious action can be reduced to a minimum, provided sheaves and drums are made proper size. It is serious to neglect consideration of any of the stresses effecting a rope, no matter how produced, because the success or failure of such appliances centers around these points.

It is not surprising perhaps that many rope users and even some engineers have avoided this subject, because it is a fact that a good deal of the information now extant upon the subject contains just enough of truth to

be deceiving. This is because after an elaborate mathematical process one wrong assumption has been made which nullifies completely the results obtained. In the present chapter we have availed ourselves of data gleaned from practical experiments, covering a considerable period of time, and numerous tests, so that the information given may be taken at face value.

If we attempt to bend a bar of iron or steel one inch in diameter around a sheave or drum three feet in diameter we would find that the material had been stressed beyond the elastic limit, or, in other words, it had stretched permanently. On the other hand, if a wire rope one inch in diameter were taken in the same way it would be found that it not only bent more easily but that it had little, if any, permanent set. The rope, however, has been stressed, although to a lesser degree. In fact, if it were a 6 x 19 rope it would have a stress of 20,000 pounds per square inch, or multiplying by the area of the wire in the rope, we have 3.72 tons. The stress in the iron bar would be approximately 800,000 pounds per square inch, according to standard formulæ. This figure looks absurd, but it shows about forty times as much stress in the round bar as in a hoisting rope of the same diameter bent around sheaves of identical diameter.

Of course, long before the stress reached 800,000 pounds per square inch in the round bar, the material composing the bar would have begun to stretch as it would in the case of steel when the stress reached about 30,000 pounds per square inch. If it were possible to make material with an elastic limit of 800,000 pounds, the round bar would have that stress when bent around a 3-foot sheave.

The formula usually used for calculating the stress in a solid bar bent around a sheave is given in most books on mechanics as follows :

$$(1) \quad S = E \frac{d}{D}$$

where S = stress per square inch in material due to bending

E = Youngs modulus = 29,000,000 for steel

d = diameter of bar

D = diameter of bend

It has been the practice of some engineers to calculate the bending stress on a rope by means of the above formula (1) modifying it by taking

d = diameter of wire in the rope.

This would be correct if a wire rope were composed of straight wires, but it is decidedly incorrect because of the fact that the wires of a rope are twisted, and the stress very much different. This is the principal point of the entire problem.

The twisting of the wires spirally in a rope has the effect of reducing the stress materially over that in a round bar.

The keynote of the problem lies in taking the right modulus of elasticity, this fact being apparent when this subject is investigated, and it is this practical point which has been the stumbling block to many theoretical calculators. We have determined by careful tests that the modulus of elasticity for ordinary wire ropes with a hemp center does not exceed 12,000,000 pounds when the rope is new, and we have used this figure in the calculation of the tables given on the following pages. The formula used to make these calculations is

$$S = E_R \frac{d}{D}$$

where E_R = modulus of elasticity of the whole rope value = 12,000,000 pounds for six-strand ropes

d = diameter of wire in the rope

D = diameter of sheave to center of the rope or neutral axis

S = stress per square inch in wires of rope due to bending around sheave of diameter D

The values obtained which have been tabulated on the following pages are reasonable, accurate and applicable to the calculation of all rope problems. They show the stress in a wire rope from the smallest to the largest practicable sheave that is used for any work, and we ask the careful consideration of them by all rope users.

For the purpose of getting a line of uniform stress in a wire rope we have drawn zigzag diagonal lines which show the stresses in tons for a uniform stress per square inch, which will be valuable in indicating whether the sheaves and drums in a wire rope system are properly proportioned.

In general the bending stress should be kept at as low a value as possible. This varies with the class of work or nature of application; values that would be considered high in mine work would be low for some classes of machinery, because in the latter case it may be necessary to sacrifice the life of the rope for the sake of greater economy in other respects. We do not believe in sacrificing the rope service until other means of successful solution of a problem have been carefully considered, because in the long run such propositions are usually expensive and unsatisfactory to the owner, and oftentimes present a difficulty that at best can only be partially solved by the rope manufacturer.

It would hardly be advisable to use as large sheaves on a hand crane or machine operated only intermittently as on an apparatus that is constantly working. The effect of the bending stress is shown usually in the decreased life of a rope.

The practical application of the following tables is best shown by an example solved in accordance with this rule:

1. Divide the breaking strength of the rope as given under the tables of strength by the factor of safety which it is desired to use. From this quantity deduct the bending stress for the diameter of rope and size of sheave or drum under consideration, and the result will be the proper working load.

e. g. What load will a $\frac{5}{8}$ -rope carry with a factor of safety of 5 over a 3-foot sheave?

Catalogue strength of $\frac{5}{8}$ plow	=	15.5 tons (6 x 19 Rope)
Divide by 5	=	3.1 tons
Deduct bending stress	=	0.91 ton
Proper working load	=	<u>2.19 tons</u>

which means that the working load is 2.19 tons after considering the bending stress. It must be noted in particular that the bending stress must not be deducted from the total strength of the rope, but only after the factor of safety has been applied.

The total load on the rope is 3.1 tons, of which 2.19 tons is useful load and 0.91 ton is non-utilizable load or bending stress.

It is only necessary to consider in any problem the minimum size of sheave because the maximum stress is produced by the smallest sheave, and the passing over more than one sheave does not alter the bending stress, although the greater the number of sheaves the greater will be the surface wear upon the rope. It is also true that the fewer the sheaves used in any wire rope system the longer the rope will last.

Bending Stress for Different Sizes of Sheaves and Drums

For 6 x 7 Rope in Net Tons

Diam. of Rope in Inches	Diameter of Sheave or Drum in Feet and Inches									
	15'-0"	14'-0"	13'-0"	12'-0"	11'-0"	10'-0"	9'-6"	9'-0"	8'-6"	8'-0"
1½	5.04	5.40	5.82	6.30	6.87	7.56	7.96	8.40	8.89	9.45
1⅜	3.88	4.16	4.48	4.85	5.29	5.82	6.13	6.47	6.85	7.27
1¼	2.91	3.12	3.36	3.64	3.97	4.37	4.69	4.86	5.14	5.46
1⅓	2.09	2.24	2.42	2.62	2.86	3.14	3.31	3.49	3.69	3.92
1	1.49	1.60	1.72	1.87	2.04	2.24	2.36	2.49	2.64	2.80
¾	1.03	1.11	1.19	1.29	1.41	1.55	1.63	1.72	1.82	1.94
⅔	0.63	0.67	0.72	0.78	0.85	0.94	0.99	1.04	1.11	1.18
⅝	0.37	0.39	0.42	0.46	0.50	0.55	0.58	0.61	0.65	0.69
⅞	0.26	0.28	0.30	0.33	0.36	0.39	0.41	0.43	0.46	0.49
9/16	0.19	0.20	0.22	0.23	0.25	0.28	0.29	0.31	0.33	0.35
½	0.13	0.14	0.15	0.16	0.18	0.19	0.20	0.21	0.23	0.24
7/16	0.08	0.09	0.09	0.10	0.11	0.12	0.13	0.13	0.14	0.15
3/8	0.04	0.05	0.05	0.06	0.06	0.07	0.07	0.08	0.08	0.09
5/16	0.03	0.04	0.04	0.04	0.04	0.05	0.05	0.06	0.06	0.06

For 6 x 7 Rope in Net Tons

Diam. of Rope in Inches	Diameter of Sheave or Drum in Feet and Inches									
	7'-6"	7'-0"	6'-6"	6'-0"	5'-6"	5'-0"	4'-6"	4'-0"	3'-6"	3'-3"
1½	10.08	10.80	11.64	12.60	13.74	15.12	16.80	18.90		
1⅜	7.76	8.32	8.96	9.70	10.58	11.64	13.94	14.54		
1¼	5.82	6.24	6.72	7.28	7.94	8.74	9.72	10.92		
1⅓	4.18	4.48	4.84	5.24	5.72	6.28	6.98	7.84	8.96	
1	2.98	3.20	3.44	3.74	4.08	4.48	4.98	5.60	6.40	6.88
¾	2.06	2.22	2.38	2.58	2.82	3.10	3.44	3.88	4.49	4.76
⅔	1.26	1.34	1.44	1.56	1.70	1.88	2.08	2.36	2.68	2.88
⅝	0.74	0.78	0.84	0.92	1.00	1.10	1.22	1.38	1.56	1.68
9/16	0.52	0.56	0.66	0.66	0.72	0.78	0.86	0.98	1.12	1.20
½	0.38	0.40	0.43	0.46	0.50	0.56	0.62	0.70	0.80	0.86
7/16	0.26	0.28	0.30	0.32	0.36	0.38	0.43	0.48	0.56	0.60
3/8	0.16	0.17	0.18	0.20	0.22	0.24	0.26	0.30	0.34	0.36
5/16	0.09	0.10	0.10	0.12	0.12	0.14	0.16	0.18	0.20	0.21
9/32	0.06	0.07	0.08	0.08	0.09	0.10	0.11	0.12	0.14	0.15

**Bending Stress for Different Sizes of Sheaves and Drums
For 6 x 7 Rope in Net Tons**

Diam. of Rope in Inches	Diameter of Sheave or Drum in Feet and Inches								
	3'-0"	2'-9"	2'-6"	2'-3"	2'-0"	1'-9"	1'-6"	1'-3"	1'-0"
1 1/2									
1 3/8									
1 1/4									
1 1/8									
1	7.48								
7/8	5.16	5.64	6.20						
3/4	3.12	3.40	3.76	4.16	4.72				
5/8	1.84	2.00	2.20	2.44	2.76	3.12			
9/16	1.32	1.44	1.56	1.72	1.96	2.24	2.64		
1/2	0.92	1.00	1.12	1.24	1.40	1.60	1.84		
7/16	0.64	0.70	0.76	0.86	0.96	1.12	1.28		
3/8	0.40	0.43	0.47	0.52	0.59	0.68	0.79		
5/16	0.23	0.24	0.28	0.31	0.35	0.39	0.47		
9/32	0.16	0.18	0.20	0.22	0.24	0.28	0.33		

Bending Stress for Different Sizes of Sheaves and Drums For 6 x 19 Rope in Net Tons

Diam. of Rope in Inches	Diameter of Sheave or Drum in Feet and Inches									
	20'-0"	18'-0"	16'-0"	15'-0"	14'-0"	13'-0"	12'-0"	11'-0"	10'-0"	9'-6"
2¾	11.63	12.92	14.54	15.51	16.47	17.89	19.39	21.15	23.26	24.50
2½	8.74	9.71	10.92	11.65	12.48	13.45	14.57	15.89	17.48	18.40
2¼	6.37	7.08	7.96	8.49	9.10	9.81	10.61	11.58	12.74	13.41
2	4.48	4.98	5.60	5.97	6.40	6.89	7.47	8.15	8.96	9.43
1¾	3.00	3.33	3.74	3.99	4.28	4.61	4.99	5.45	5.99	6.31
1⅝	2.40	2.67	3.00	3.20	3.43	3.69	4.00	4.36	4.80	5.05
1½	1.88	2.09	2.36	2.51	2.69	2.90	3.14	3.43	3.77	3.97
1⅜	1.46	1.62	1.82	1.94	2.08	2.24	2.42	2.65	2.91	3.06
1¼	1.09	1.21	1.36	1.45	1.56	1.68	1.82	1.98	2.18	2.30
1⅓	0.80	0.88	0.99	1.06	1.14	1.22	1.33	1.45	1.59	1.68
1	0.56	0.62	0.70	0.75	0.80	0.86	0.93	1.01	1.12	1.18
¾	0.37	0.42	0.47	0.50	0.54	0.58	0.63	0.68	0.75	0.79
¾						0.37	0.40	0.43	0.47	0.50
⅝						0.21	0.23	0.25	0.27	0.29
⅘								0.19	0.20	0.21
½								0.13	0.14	0.15
⅞										
¾										
⅝										
⅘										
½										

For 6 x 19 Rope in Net Tons

Diam. of Rope in Inches	Diameter of Sheave or Drum in Feet and Inches									
	9'-0"	8'-6"	8'-0"	7'-6"	7'-0"	6'-6"	6'-0"	5'-6"	5'-0"	4'-6"
2¾	25.84	27.36	29.08	31.02	32.94	35.78	38.78	42.29	46.52	
2½	19.48	20.56	21.84	23.30	24.96	26.90	29.14	31.78	34.96	
2¼	14.16	14.99	15.92	16.98	18.20	19.62	21.22	23.16	25.48	28.32
2	9.96	10.55	11.20	11.94	12.80	13.78	14.94	16.29	17.92	19.92
1¾	6.66	7.05	7.48	7.98	8.56	9.22	9.98	10.88	11.98	13.32
1⅝	5.34	5.65	6.00	6.40	6.86	7.38	8.00	8.73	9.60	10.68
1½	4.18	4.44	4.72	5.02	5.38	5.80	6.28	6.85	7.54	8.36
1⅜	3.24	3.42	3.64	3.88	4.16	4.48	4.84	5.29	5.82	6.48
1¼	2.42	2.56	2.72	2.90	3.12	3.36	3.64	3.96	4.36	4.84
1⅓	1.76	1.87	1.98	2.12	2.28	2.44	2.66	2.89	3.18	3.52
1	1.24	1.32	1.40	1.50	1.60	1.72	1.86	2.04	2.24	2.48
¾	0.84	0.88	0.94	1.00	1.08	1.16	1.26	1.36	1.50	1.68
¾	0.52	0.55	0.59	0.63	0.67	0.74	0.80	0.85	0.94	1.04
⅝	0.30	0.32	0.34	0.36	0.39	0.42	0.46	0.49	0.54	0.60
⅘	0.22	0.23	0.24	0.26	0.28	0.30	0.33	0.36	0.40	0.44
½	0.16	0.16	0.17	0.19	0.20	0.21	0.23	0.25	0.28	0.32
⅞		0.11	0.12	0.13	0.13	0.14	0.15	0.16	0.18	0.21
¾				0.08	0.08	0.09	0.10	0.11	0.12	0.13
⅝						0.05	0.06	0.06	0.07	0.08
⅘							0.03	0.03	0.04	0.04

Bending Stress for Different Sizes of Sheaves and Drums For 6 x 19 Rope in Net Tons

Diam. of Rope in Inches	Diameter of Sheave or Drum in Feet and Inches									
	4'-0"	3'-9"	3'-6"	3'-3"	3'-0"	2'-9"	2'-6"	2'-3"	2'-0"	1'-9"
2 3/4										
2 1/2										
2 1/4	31.84	33.96								
2	22.40	23.88	25.60							
1 3/4	14.96	15.96	17.12	18.44	19.96	21.76	23.96			
1 5/8	12.00	12.80	13.72	14.76	16.00	17.46	19.20			
1 1/2	9.44	10.02	10.76	11.60	12.56	13.70	15.08	16.72		
1 3/8	7.28	7.76	8.32	8.96	9.68	10.58	11.64	12.96	14.56	
1 1/4	5.44	5.80	6.24	6.72	7.28	7.92	8.72	9.68	10.88	12.48
1 1/8	3.96	4.24	4.56	4.88	5.32	5.78	6.36	7.04	7.92	9.12
1	2.80	3.00	3.20	3.44	3.72	4.08	4.48	4.96	5.60	6.40
7/8	1.88	2.00	2.16	2.32	2.52	2.72	3.00	3.36	3.76	4.32
3/4	1.18	1.26	1.34	1.48	1.60	1.70	1.88	2.08	2.36	2.68
5/8	0.68	0.72	0.78	0.84	0.91	0.98	1.08	1.20	1.36	1.56
9/16	0.48	0.52	0.56	0.60	0.66	0.72	0.80	0.88	0.96	1.12
1/2	0.34	0.38	0.40	0.42	0.46	0.50	0.56	0.62	0.68	0.80
7/16	0.24	0.26	0.27	0.28	0.30	0.32	0.36	0.42	0.47	0.54
3/8	0.15	0.16	0.17	0.18	0.20	0.22	0.24	0.26	0.30	0.33
5/16	0.09	0.10	0.10	0.11	0.12	0.13	0.14	0.15	0.17	0.19
1/4	0.05	0.05	0.05	0.06	0.06	0.07	0.07	0.08	0.09	0.10

For 6 x 19 Rope in Net Tons

Diam. of Rope in Inches	Diameter of Sheave or Drum in Feet and Inches									
	1'-6"	1'-3"	1'-0"	0'-9"						
2 3/4										
2 1/2										
2 1/4										
2										
1 3/4										
1 5/8										
1 1/2										
1 3/8										
1 1/4										
1 1/8	10.64									
1	7.44	8.96								
7/8	5.04	6.00	7.52							
3/4	3.20	3.76	4.72							
5/8	1.82	2.16	2.72							
9/16	1.32	1.60	1.82							
1/2	0.93	1.12	1.36							
7/16	0.63	0.72	0.94							
3/8	0.40	0.48	0.60							
5/16	0.23	0.28	0.34							
1/4	0.12	0.14	0.17							

Bending Stress for Different Sizes of Sheaves and Drums For 6 x 37 Rope in Net Tons

Diam. of Rope in Inches	Diameter of Sheave or Drum in Feet and Inches									
	14'-0"	13'-0"	12'-0"	11'-0"	10'-0"	9'-0"	8'-0"	7'-6"	7'-0"	6'-6"
2¾	11.11	11.97	12.96	14.15	15.56	17.40	19.45	20.75	22.22	23.94
2½	8.35	8.99	9.74	10.63	11.69	12.99	14.61	15.60	16.70	17.98
2¼	6.09	6.55	7.10	7.75	8.52	9.47	10.65	11.36	12.18	13.10
2	4.29	4.62	5.00	5.45	6.00	6.67	7.50	8.00	8.58	9.24
1¾	2.89	3.11	3.38	3.68	4.05	4.50	5.06	5.40	5.78	6.22
1½	2.29	2.47	2.68	2.92	3.21	3.57	4.01	4.28	4.58	4.94
1½	1.80	1.98	2.10	2.29	2.52	2.80	3.15	3.36	3.60	3.96
1¾	1.39	1.49	1.62	1.77	1.94	2.18	2.43	2.59	2.78	2.98
1¼	1.04	1.12	1.22	1.33	1.46	1.62	1.83	1.95	2.08	2.24
1⅝	0.76	0.82	0.88	0.97	1.06	1.18	1.33	1.42	1.52	1.64
1	0.54	0.58	0.63	0.68	0.75	0.83	0.94	1.00	1.04	1.16
¾	0.38	0.39	0.42	0.46	0.51	0.56	0.63	0.68	0.72	0.78
¾	0.23	0.25	0.26	0.29	0.31	0.35	0.39	0.42	0.46	0.50
⅝		0.14	0.15	0.17	0.18	0.20	0.23	0.24	0.26	0.28
⅞				0.12	0.13	0.15	0.17	0.18	0.19	0.20
½										
⅞										
¾										

For 6 x 37 Rope in Net Tons

Diam. of Rope in Inches	Diameter of Sheave or Drum in Feet and Inches									
	6'-0"	5'-6"	5'-0"	4'-6"	4'-0"	3'-9"	3'-6"	3'-3"	3'-0"	2'-9"
2¾	25.92	28.30	31.12	34.80	38.90	41.50				
2½	19.48	21.26	23.38	25.98	29.22	31.20	33.40	35.96		
2¼	14.20	15.50	17.04	18.94	21.30	22.72	24.36	26.20		
2	10.00	10.90	12.00	13.34	15.00	16.00	17.16	18.48	20.00	21.80
1¾	6.76	7.36	8.10	9.00	10.12	10.80	11.56	12.44	13.52	14.72
1½	5.36	5.84	6.42	7.14	8.02	8.56	9.16	9.88	10.72	11.68
1½	4.20	4.58	5.04	5.60	6.30	6.72	7.20	7.92	8.40	9.16
1¾	3.24	3.54	3.89	4.36	4.86	5.18	5.56	5.96	6.48	7.08
1¼	2.44	2.66	2.92	3.24	3.66	3.90	4.16	4.48	4.88	5.32
1⅝	1.76	1.94	2.13	2.36	2.66	2.84	3.04	3.28	3.54	3.88
1	1.26	1.36	1.50	1.66	1.88	2.00	2.08	2.32	2.52	2.72
¾	0.84	0.92	1.01	1.12	1.26	1.36	1.44	1.56	1.68	1.84
¾	0.52	0.58	0.63	0.70	0.78	0.84	0.92	1.00	1.04	1.16
⅝	0.30	0.33	0.36	0.40	0.44	0.48	0.52	0.56	0.61	0.68
⅞	0.22	0.24	0.27	0.30	0.33	0.36	0.38	0.41	0.44	0.48
½					0.23	0.25	0.26	0.29	0.31	0.34
⅞									0.21	0.23
¾									0.13	0.14

Bending Stress for Different Sizes of Sheaves and Drums For 6 x 37 Rope in Net Tons

Diam. of Rope in Inches	Diameter of Sheave or Drum in Feet and Inches							
	2'-6"	2'-3"	2'-0"	1'-9"	1'-6"	1'-3"	1'-0"	0'-9"
2 3/4								
2 1/2								
2 1/4								
2	24.00							
1 3/4	16.20	18.00	20.24					
1 5/8	12.84	14.28	16.04	18.32				
1 1/2	10.08	11.20	12.60	14.40				
1 3/8	7.78	8.72	9.72	11.12	12.96			
1 1/4	5.84	6.48	7.32	8.32	9.76	11.68		
1 1/8	4.26	4.72	5.32	6.06	7.08	8.52		
1	3.00	3.32	3.76	4.16	5.04	6.00	7.52	
7/8	2.02	2.24	2.52	3.08	3.36	4.04	5.04	
3/4	1.26	1.40	1.56	1.84	2.08	2.52	3.12	
5/8	0.73	0.80	0.92	1.04	1.22	1.40	1.84	
9/16	0.54	0.60	0.66	0.76	0.88	1.08	1.32	
1/2	0.38	0.41	0.46	0.52	0.62	0.76	0.92	
7/16	0.25	0.28	0.31	0.39	0.42	0.50	0.62	
3/8	0.16	0.17	0.19	0.23	0.26	0.32	0.38	

Bending Stress for Different Sizes of Sheaves and Drums

For 8 x 19 Rope in Net Tons

Diam. of Rope in Inches	Diameter of Sheave or Drum in Feet and Inches								
	7'-0"	6'-0"	5'-0"	4'-6"	4'-0"	3'-9"	3'-6"	3'-3"	3'-0"
1½	3.29	3.84	4.61	5.12	5.76	6.15	6.58	7.10	7.68
1⅜	2.54	2.96	3.55	3.94	4.44	4.73	5.08	5.47	5.92
1¼	1.91	2.22	2.67	2.96	3.34	3.56	3.82	4.11	4.44
1⅓	1.39	1.62	1.94	2.15	2.43	2.59	2.78	2.99	3.24
1	0.98	1.14	1.37	1.52	1.71	1.83	1.96	2.12	2.28
¾	0.65	0.76	0.91	1.01	1.14	1.21	1.30	1.40	1.52
¾	0.41	0.48	0.58	0.64	0.72	0.77	0.82	0.89	0.96
⅝	0.24	0.28	0.33	0.36	0.42	0.45	0.48	0.51	0.56
⅜	0.17	0.20	0.24	0.27	0.30	0.32	0.34	0.37	0.40
½	0.12	0.14	0.17	0.19	0.21	0.23	0.24	0.26	0.28
⅞				0.13	0.14	0.15	0.16	0.17	0.19
¾								0.11	0.12
⅝									
⅜									

For 8 x 19 Rope in Net Tons

Diam. of Rope in Inches	Diameter of Sheave or Drum in Feet and Inches								
	2'-9"	2'-6"	2'-3"	2'-0"	1'-9"	1'-6"	1'-3"	1'-0"	0'-9"
1½	8.38	9.22							
1⅜	6.45	7.10	7.88	8.88					
1¼	4.86	5.34	5.92	6.68	7.64				
1⅓	3.53	3.88	4.30	4.86	5.56	6.48	7.76		
1	2.49	2.74	3.04	3.42	3.92	4.56	5.38		
¾	1.65	1.82	2.02	2.28	2.60	3.04	3.64	4.56	
¾	1.05	1.16	1.28	1.44	1.64	1.92	2.32	2.88	
⅝	0.60	0.66	0.72	0.84	0.96	1.12	1.32	1.68	2.24
⅜	0.44	0.48	0.54	0.66	0.68	0.80	0.97	1.20	1.60
½	0.31	0.34	0.38	0.43	0.48	0.56	0.68	0.86	1.12
⅞	0.20	0.23	0.26	0.28	0.32	0.38	0.44	0.56	0.76
¾	0.13	0.14	0.16	0.18	0.21	0.24	0.29	0.36	0.48
⅝					0.12	0.14	0.14	0.21	0.28
⅜							0.09	0.15	0.20

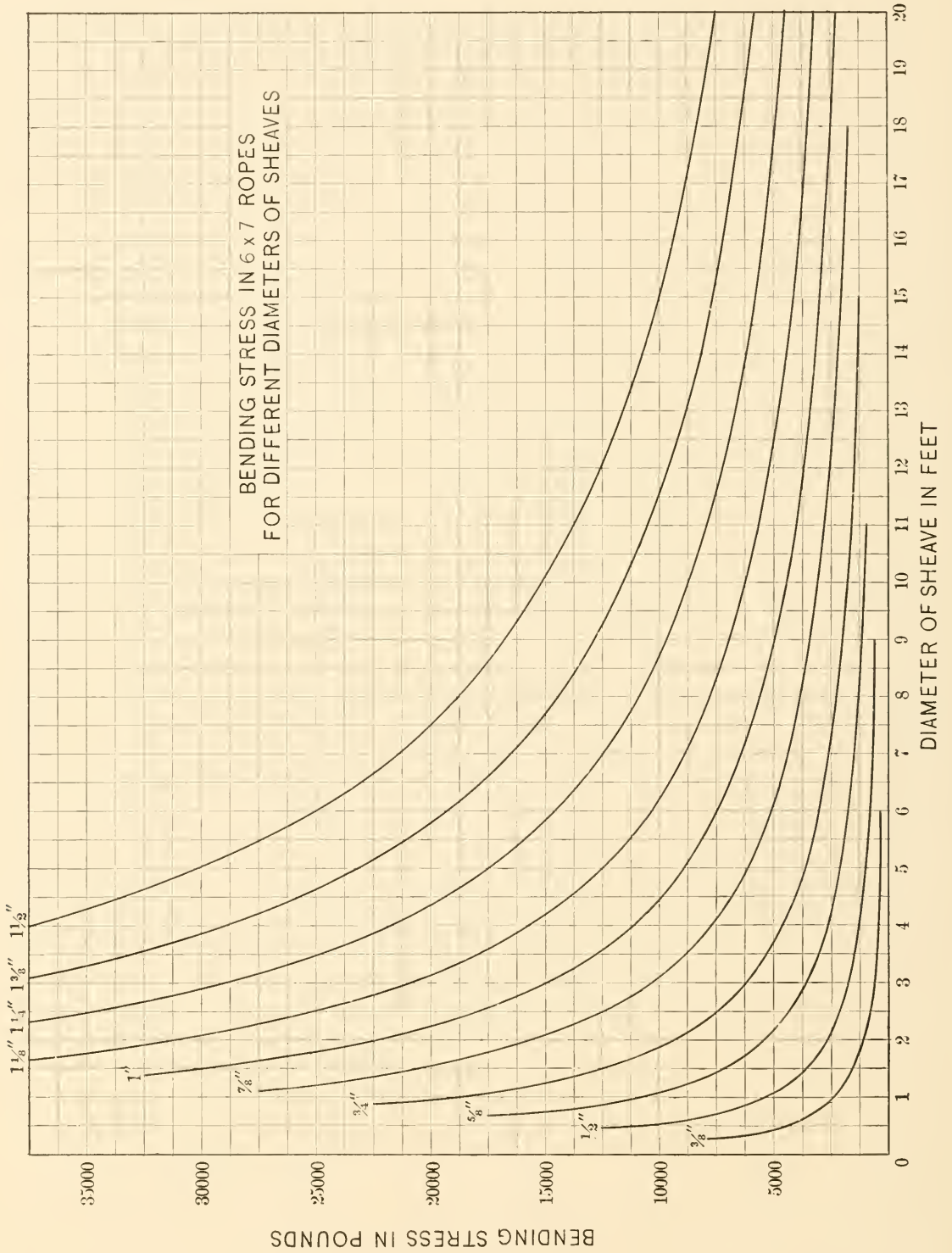

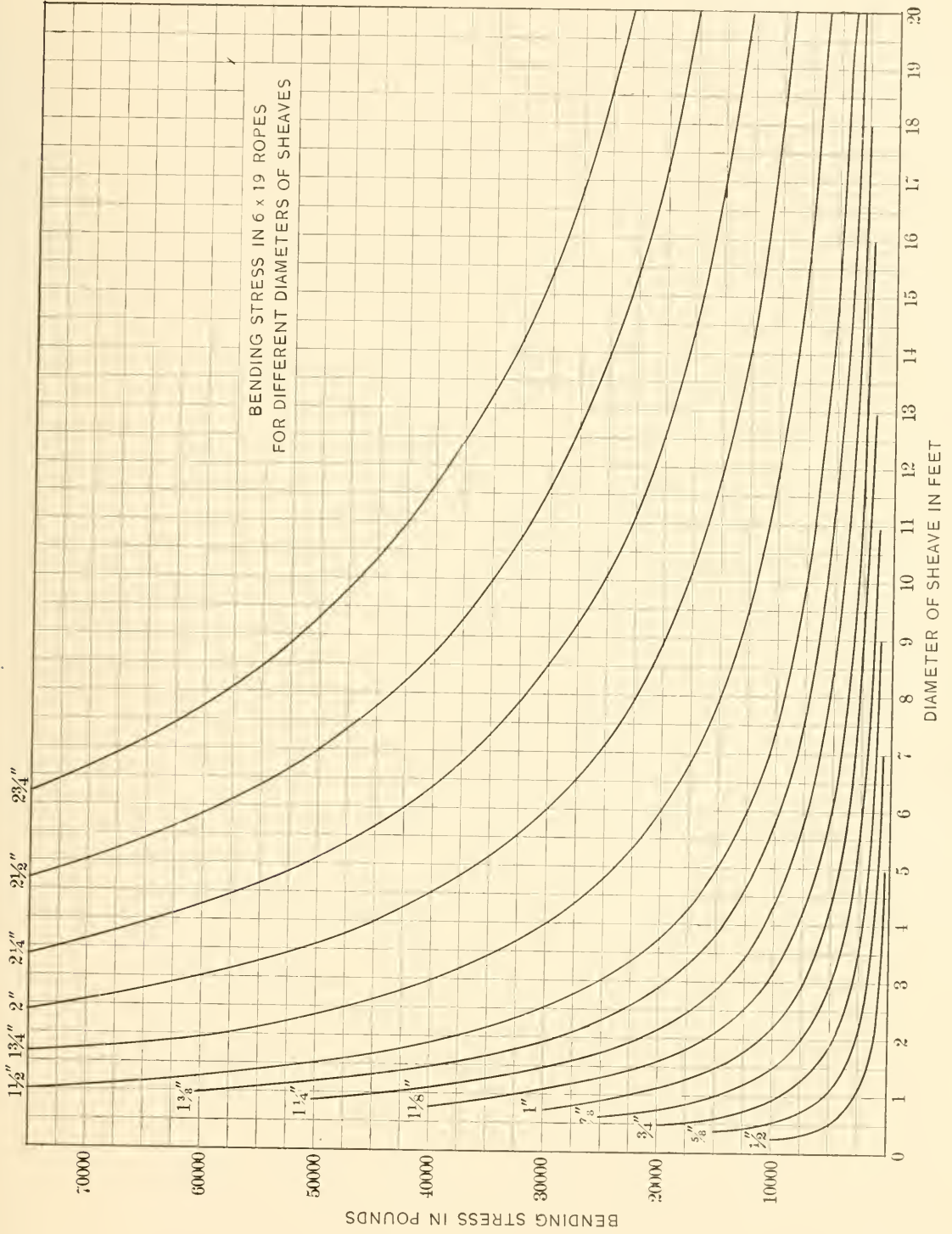

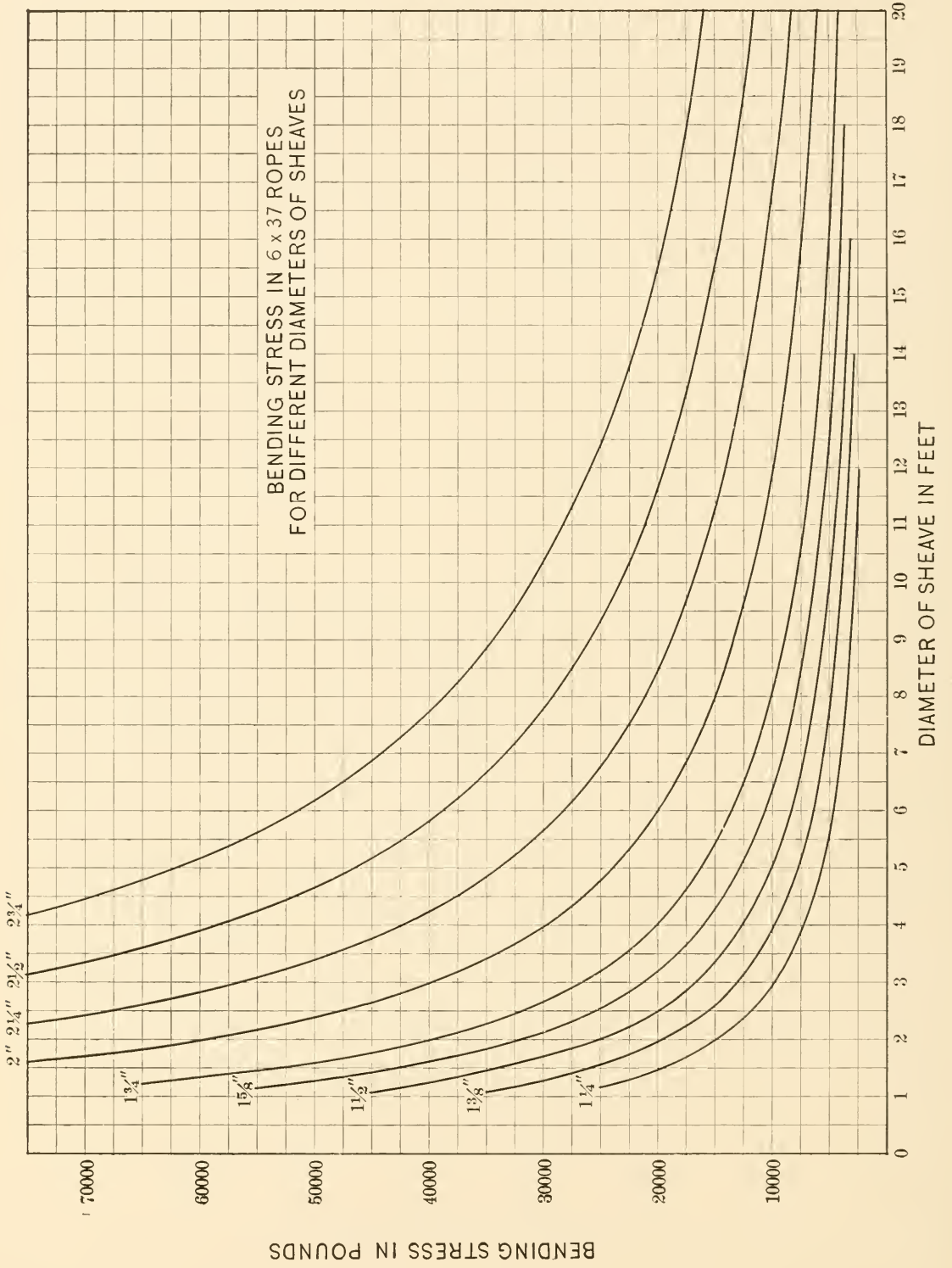

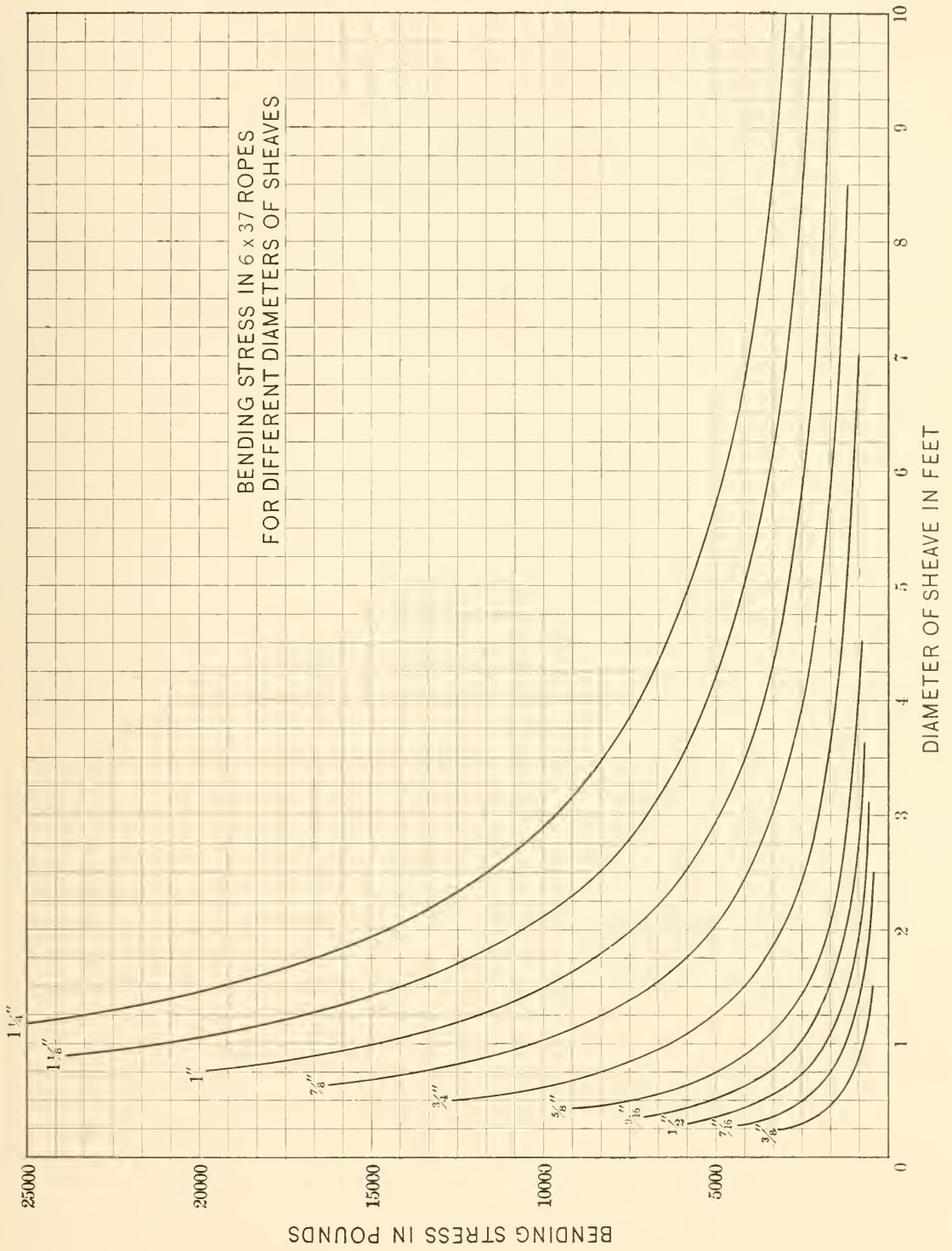

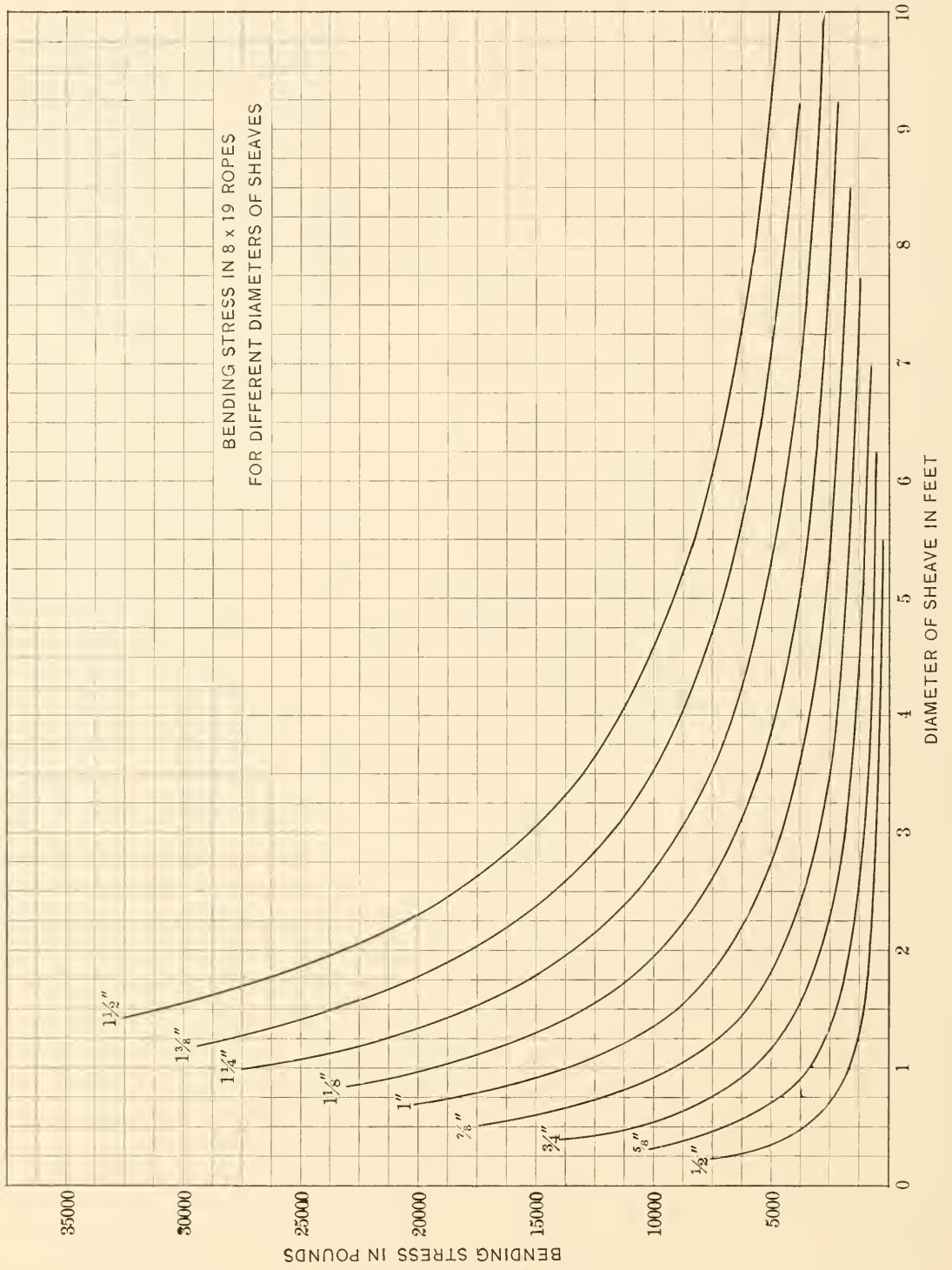

Section 3

Stresses Due to Fluctuation of Load in Starting and Stopping

The amount of stress upon a rope, the velocity of which changes frequently, is a factor dependent entirely upon the rapidity with which the change of velocity is made. A problem will make this perfectly clear. Let us consider a rope that is to lift a load vertically, starting from rest and to reach a certain speed within a given time.

Let t = the time of acceleration.

W = the weight to be lifted (mine cage, ore or similar proposition).

w = the weight of the rope per foot in pounds.

E_r = the modulus of elasticity of the rope.

a = the acceleration or retardation of the load in feet per second.

S = the space in which the acceleration or retardation is made.

V = the velocity of the load in feet per second.

K = the kinetic energy of the load.

k = the kinetic energy of the moving rope.

K_t = the total kinetic energy.

l = the length of rope hanging vertically.

g = the force of gravity.

$K_t = K + k$.

$K_t = C (W + wl)$.

When C equals a constant by which the load is increased due to kinetic energy, C being a factor representing the increase of the total load.

$$\text{Therefore, } K_t = \frac{WV^2 + wlV^2}{2g} = \frac{V^2}{2g} (W + wl)$$

but $V^2 = 2 a S$

substituting we have $C (W + wl) = \frac{aS}{g} (W + wl)$ or $a = \frac{Cg}{S}$

$a^2 t^2 = 2g C$. If t is equal to 1, $a = \sqrt{2g C}$

or $a = 8.02 \sqrt{C}$

In order to facilitate estimating the stresses, the following table has been calculated using the above formulæ. In the first column are values of C ranging from 0 to 5.00, while in the second column are the corresponding accelerations (a) in feet per second, squared. The third column shows the corresponding velocities (v) in feet per second, and these values will also represent the distance in feet (S) the load would travel during one second. The fourth column shows the total stress factor, and the fifth the safety factor corresponding to the acceleration (a) upon the basis of a factor of safety of 10 with a quiet load.

Stresses of Acceleration and Retardation

C	a Feet per Second ²	S Feet per Second	C + 1 Total Stress Factor	Safety Factor 10 for Quiet Load
0.	0.	0.	1.00	10.00
0.10	2.54	1.27	1.10	9.09
0.20	3.59	1.79	1.20	8.34
0.25	4.01	2.01	1.25	8.00
0.30	4.39	2.20	1.30	7.70
0.40	5.07	2.54	1.40	7.15
0.50	5.67	2.84	1.50	6.67
0.60	6.21	3.11	1.60	6.25
0.70	6.71	3.36	1.70	5.88
0.75	6.94	3.47	1.75	5.72
0.80	7.17	3.58	1.80	5.66
0.90	7.61	3.81	1.90	5.27
1.00	8.02	4.01	2.00	5.00
1.25	8.97	4.48	2.25	4.44
1.50	9.82	4.91	2.50	4.00
1.75	10.61	5.31	2.75	3.64
2.00	11.34	5.67	3.00	3.33
2.50	12.68	6.34	3.50	2.86
3.00	13.89	6.94	4.00	2.50
3.50	15.00	7.50	4.50	2.22
4.00	16.04	8.02	5.00	2.00
4.50	17.01	8.50	5.50	1.82
5.00	17.93	8.96	6.00	1.67

For example: With the value of C equal to 1, which corresponds to a change of kinetic energy equal to the load during the first second, the load could receive an acceleration of 8.02 feet per second² or would have moved a distance of 4.01 feet, doubling the stress on the rope over that of the corresponding dead load: in other words, if the factor of safety were 10 with a quiet load, it would be 5 with the load accelerated 8.02 feet in the first second. It will thus be seen that it is very necessary that the acceleration at the start be gradual, in order to be sure that the stress is not unduly increased, because it may readily be seen that if the acceleration is sufficiently high, the rope would be in danger of being snapped off. This is particularly true of shorter lengths of rope.

While it is not impossible to break a long mining rope by a sudden starting of the engine, it is not as likely to occur in a long rope as it is in a shorter mining rope, owing to another factor which enters into the problem. This factor is the extension or permanent elasticity of a wire rope or the amount of stretch for different applications of load. For instance, with the value of C equal to 1, the following table shows the amount of extension which partly compensates for the stress on a rope at starting.

Length Rope Feet	Extension Crucible Steel Feet	Extension Plow Steel Feet	Length Rope Feet	Extension Crucible Steel Feet	Extension Plow Steel Feet
500	0.833	1.000	3000	5.000	6.000
1000	1.667	2.000	3500	5.833	7.000
1500	2.500	3.000	4000	6.667	8.000
2000	3.333	4.000	4500	7.500	9.000
2500	4.167	5.000			

This extension varies directly as the length of the rope. It will be noted from this table that taking a rope, say 2,500 feet long, if it were to be stressed to a value of C equal to 1 corresponding to an acceleration of 8.02 feet per second, the value of C would really not be as great as 1, owing to the fact that the stretch in the rope of 4.16 feet would be almost exactly equal to the space traversed in the first second or the value of C would be only .50. If, however, the value of C were increased, the factor of safety of course would be cut down correspondingly.

Section 4

Inclined Planes Many wire rope applications require that a wire rope operate on a slope or incline where the stress on the rope is a variable quantity due to the angle of the plane. The stress on a wire rope so employed is of course a function of the angle of inclination, the value of which can be accurately determined. A diagram and development of formula for making this calculation is given below.

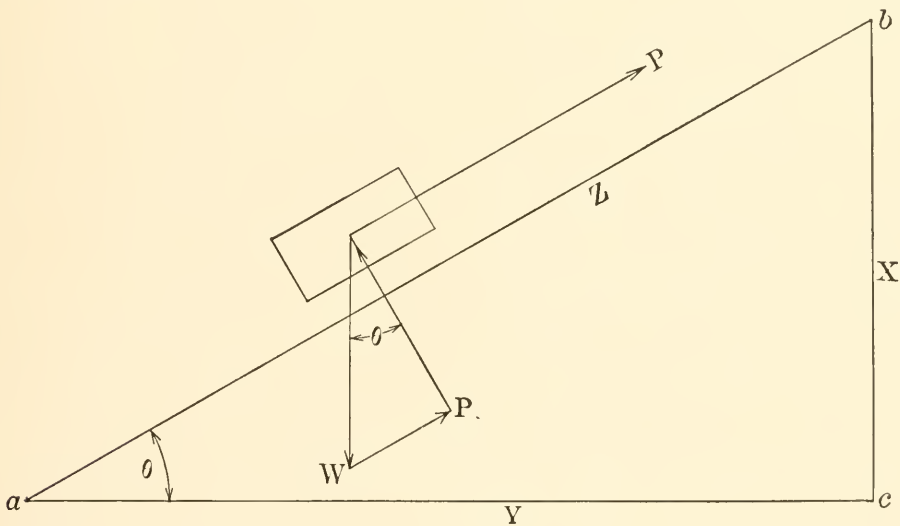

Let θ = the angle of inclination.

$X = bc$ = the height of the plane measured vertically.

$Y = ac$ = the length of the incline measured horizontally.

$Z = ab$ = the length of the incline measured along the slope.

P_1 = the pull on the wire rope due to load neglecting friction.

P_2 = the pull on the wire rope due to its own weight on the incline.

F = the friction factor which is a function of W .

W = weight resting on the incline.

P = the pull on the wire rope, friction and weight of rope included.

$P = P_1 + F + P_2$.

$P_1 = W \sin \theta = \frac{WX}{Z}$ where W , X and Z are known.

The friction F of the cars on the incline operates normally to the line ab and is therefore a function of $\cos \theta$. The maximum friction is for a value $\cos \theta = 1$ or on a dead level, and the minimum for $\cos \theta = 0$ or 90° vertical. It is the starting friction which is the greater and if we take a value of 2% or $\frac{1}{50}$ for this quantity we have

$$(1) \quad F = \frac{W \cos \theta}{50}$$

$$\text{Therefore } P = P_1 + F + P_2 = W \sin \theta + \frac{W \cos \theta}{50} + P_2 = W \left(\sin \theta + \frac{\cos \theta}{50} \right) + P_2$$

Take the weight of the rope into account

Let w = weight per foot of the rope

l = length of rope on the incline.

$$(2) \quad \text{Therefore } P_2 = wl \left(\sin \theta + \frac{\cos \theta}{50} \right)$$

$$(3) \quad P = P_1 + F + P_2 = (W + wl) \left(\sin \theta + \frac{\cos \theta}{50} \right)$$

$$\text{Let } C = \left(\sin \theta + \frac{\cos \theta}{50} \right)$$

$$(4) \quad \text{Then } P = (W + wl) C$$

For short inclines an approximate value of P may be obtained by neglecting the weight of the rope or

$$(5) \quad P = C W$$

The values of $C = \left(\sin \theta + \frac{\cos \theta}{50} \right)$ have been plotted in a curve from which it will be easy to pick the constant by which the load is to be multiplied to get the pull on the rope.

For a good many places the length of the incline makes it imperative that the weight of the rope be considered, and it is better to allow for this by using formula (3) or (4).

For obtaining the number of degrees on an incline we advise the use of a degree rule which is similar to a carpenter's two-foot rule containing a spirit level and a degree graduation. In case a rule of this kind is not at hand, the degree of inclination may be determined by measuring the vertical elevation in 100 feet of distance along the incline, and from curve on page 51 the degree can be found at once.

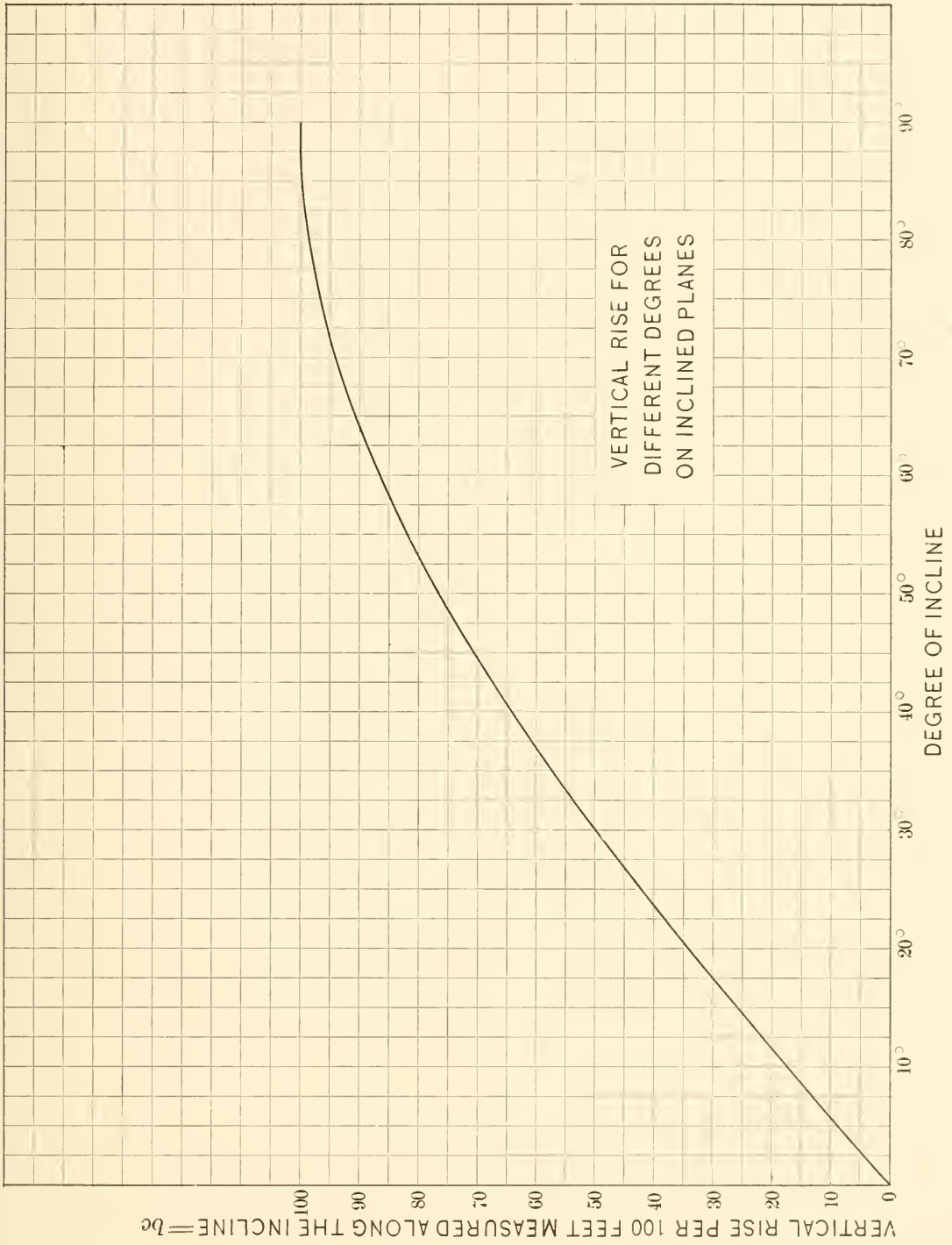

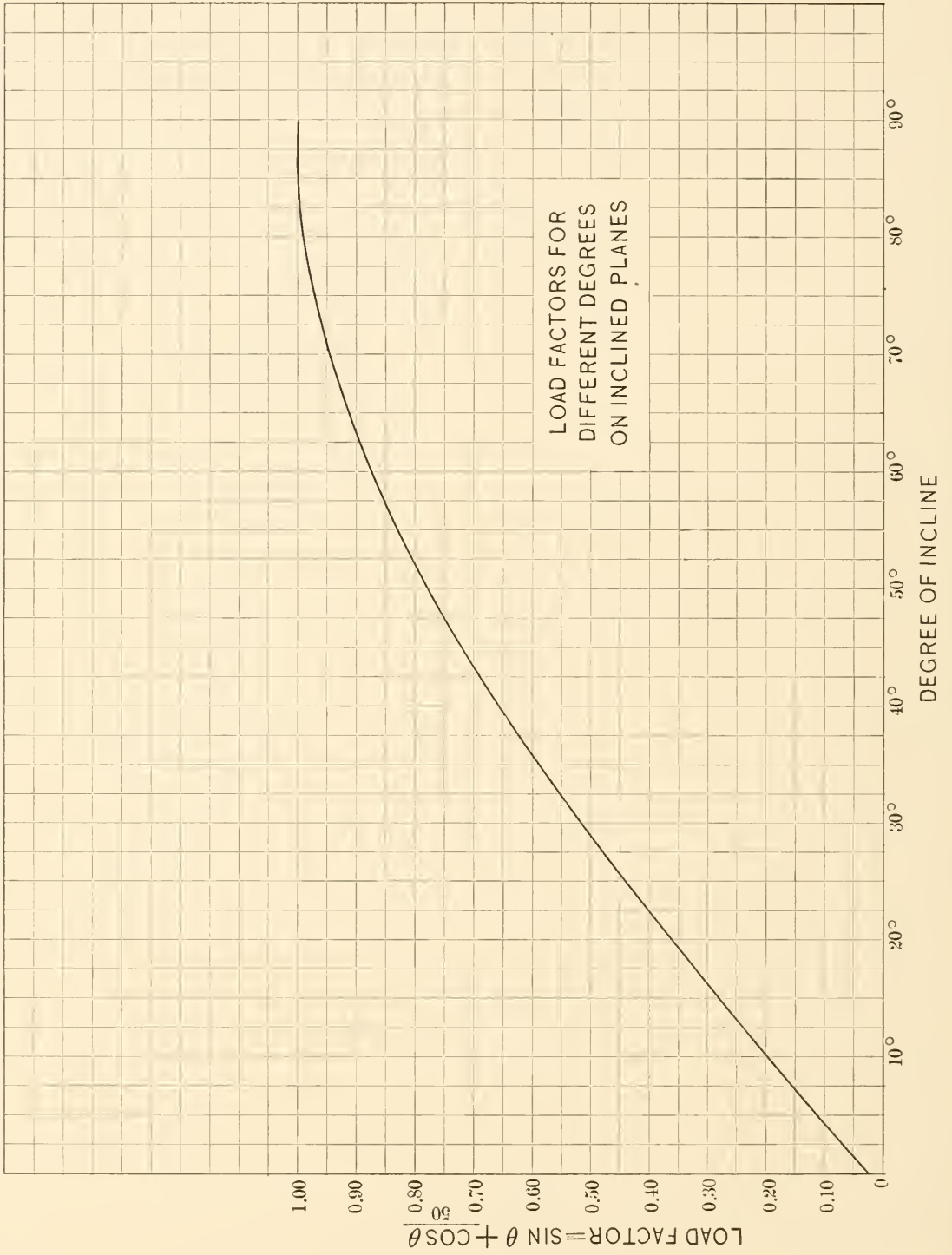

Having found the degree of inclination, the curve on page 52 will give the load factor or $C = \left(\sin \theta + \frac{\cos \theta}{50} \right)$ from which by formula (4) page 50, the stress on the rope P is readily calculated.

EXAMPLE: A load of 50 tons is to be pulled up an incline of 20 feet per 100 feet of slope. The total length of the slope is 2000 feet. Required the size of rope necessary to handle the load if Plow Steel Rope 6 x 19 is to be used, and factor of safety of 6.

1. Get the approximate diameter of the rope by using formula (5) page 50.

For 20-foot rise per 100 feet of slope the degree of inclination = $11\frac{1}{2}$. (See page 51), and the load factor $C = 0.22$. (See page 52.)

Hence the approximate value of $P = 0.22 \times 50 = 11$ tons.

This means a rope with a strength in excess of 66 tons.

A $1\frac{1}{4}$ -inch rope has a strength of 58 tons, and a $1\frac{3}{8}$ -inch rope a strength of 72 tons. Let us take the $1\frac{3}{8}$ -inch rope which weighs 3 pounds per foot. $P = C (W + wl)$ $C = 0.22$ $W = 100,000$ pounds $w = 3$ pounds $l = 2000$ feet $P = 0.22 (100,000 + 6000) = 23,320$ pounds = 11.66 tons.

This shows that the $1\frac{3}{8}$ -inch rope is the right rope to be used. In this case the weight of the rope added about 6 per cent. to the load.

Section 5

Stresses in Spans The subject of this chapter is one on which a book might easily be written if we were to include all the data and statistical information available, but it would be difficult for the general reader to pick from such a mass of information the parts that would apply to the particular case under consideration.

There are times, however, when a rope user wants to know quickly whether he can accomplish certain results with a cable suspended horizontally in the air between two towers or supports and it is for such purposes that the information contained in these pages is given.

The stress or tension on a cable suspended between two points is entirely different from that of any other type of rope application and is usually much greater than the suspended load. It is very necessary to recognize this fact because a rope sometimes breaks if the user has not made proper calculations of the stresses.

It is usually required that a cable span shall have as small a sag or center deflection as possible, which is of course the condition of maximum tension on a cable span.

To show what some of the stresses present in a cable span are, it is necessary to only mention that all of the following factors must be considered carefully in important calculations:

1. *Weight or load to be supported by cable span*
2. *Position of load and whether position is stationary or movable*
3. *Weight of supporting cable*
4. *Stress due to fluctuations in temperature*
5. *Ice load*
6. *Wind load*
7. *Modulus of elasticity of cable used in span*
8. *Are both points of span support on a level?*
9. *Height of towers above any given datum line if points of support are on different levels*
10. *Length of span*
11. *Amount of deflection or dip in center of span*
12. *Length of cable hanging between supports*

Other minor factors may need to be considered. In the case of large installations it is well to have the advice of the manufacturer so that all the various points may be given careful consideration.

The formula for calculating the stress in the case of a span with level supports is as follows:

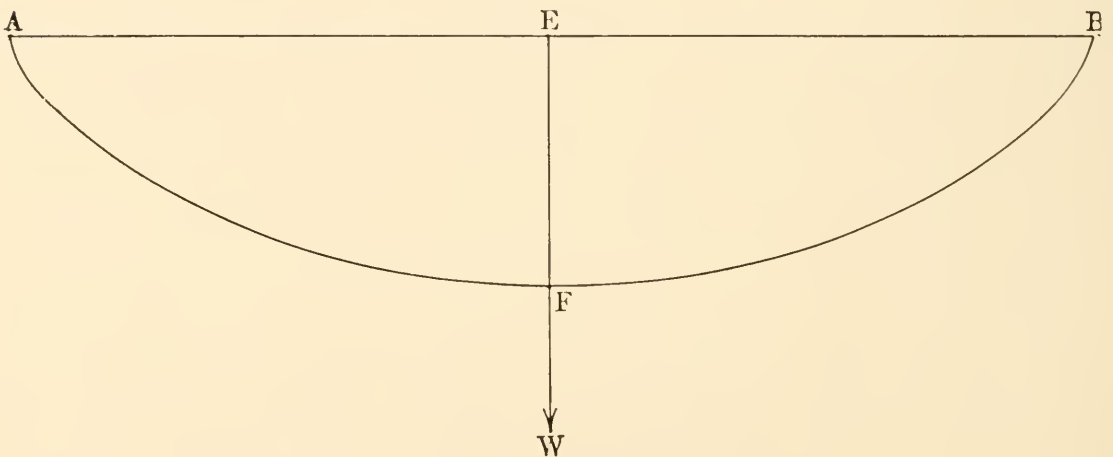

Let L = the total span in feet = AB

D = the deflection in feet = EF

W = the dead load at point F

w = weight per foot of the cable

S = tension in the cable at F

X = AE , the position of load W with reference to point A .

For the deflection due to weight of rope alone we have

$$(1) \quad S_1 = \frac{wL^2}{8D} \text{ at the center of the span}$$

This formula (1) is applicable to all cases of uniformly distributed load such as a wire rope or large guy strand used for supporting a lead telephone or power cable, or a bare copper high tension feeder cable, at frequent intervals. The value of w must be taken however as the total weight per foot of both suspended and supported cables.

The stress due to the weight alone is

$$(2) \quad S_2 = \frac{WL}{4D} \text{ at the center of the span}$$

$$(3) \quad S = S_1 + S_2 = \frac{wL^2 + 2WL}{8D} = \frac{L(wL + 2W)}{8D}$$

From the formula (3) we can get the stress on any cable due to load and weight of cable.

In order to facilitate these calculations we have devised curves for calculating the strain, which are found on the following pages. In using these curves it should be borne in mind that they represent the distributed load. If the load is in the center it is *necessary to multiply it by 2*.

e. g. 1000 pounds in the center of a 100 span
is = 2000 pounds distributed load or 20 pounds per foot

The curves are calculated on one pound per foot distributed load, so it is necessary to multiply the stress obtained from the curves by the distributed load per foot.

EXAMPLE: What stress is produced in a 1-inch rope weighing 1.6 pounds per foot on a 500-foot span with a deflection of 20 feet and a distributed load of 1000 pounds? From the curve, page 56.

A 500-foot span and 20-foot deflection gives a stress of 1562.5 pounds.

$$\text{Distributed load per foot} = 1.6 + \frac{1000}{500} = 3.6 \text{ pounds}$$

$$1562.5 \times 3.6 \text{ pounds} = 5625 \text{ pounds tension}$$

The maximum stress on a cable span is at the supporting points A and B when the load is suspended in the center.

Tension at A or B = tension in center + the tension due to weight of rope wL and load W times the deflection D .

$$(4) \quad T = S + D(wL + W)$$

The length of cable hanging between supports can be determined from the single curve for various ratios of sag to span, shown on page 56.

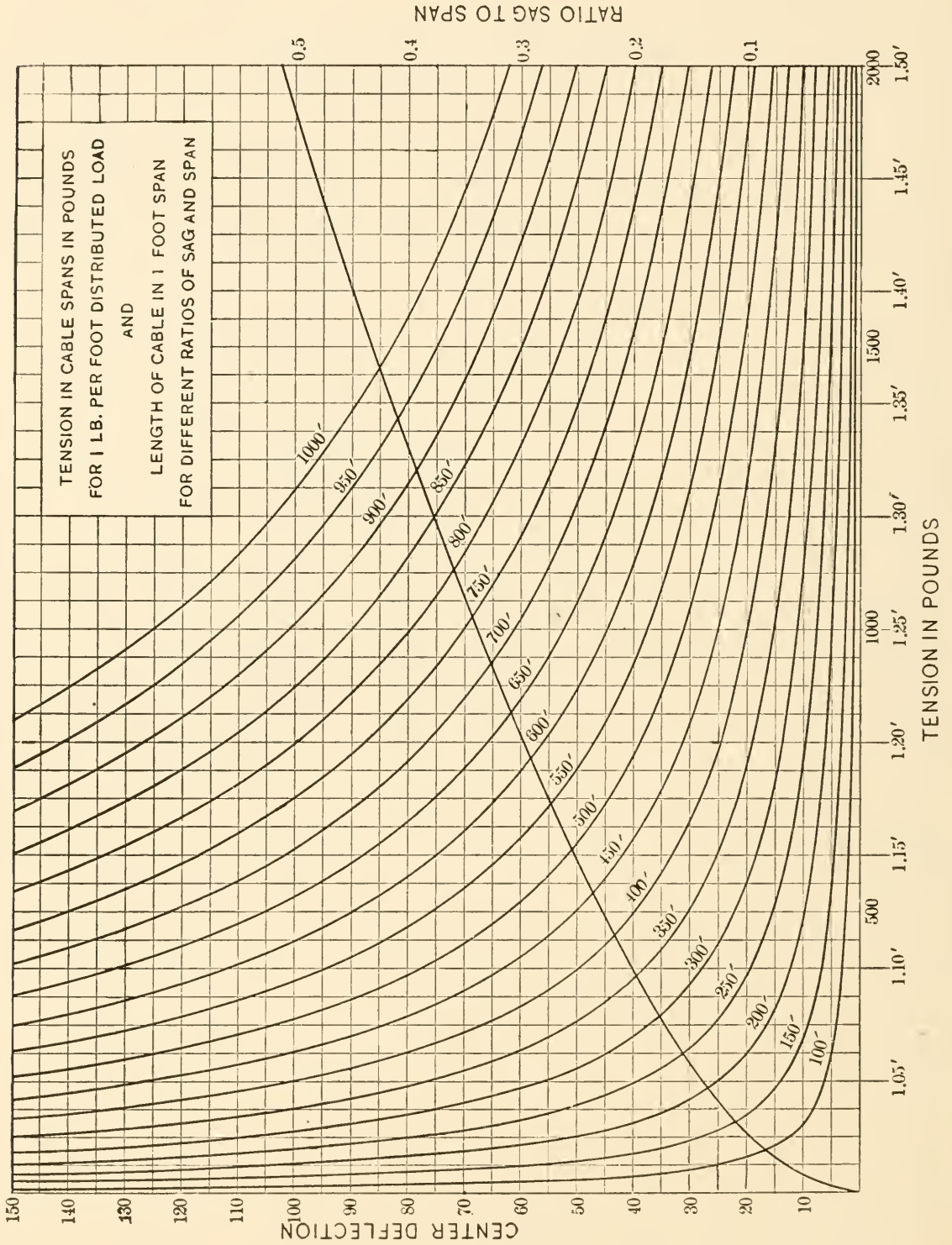

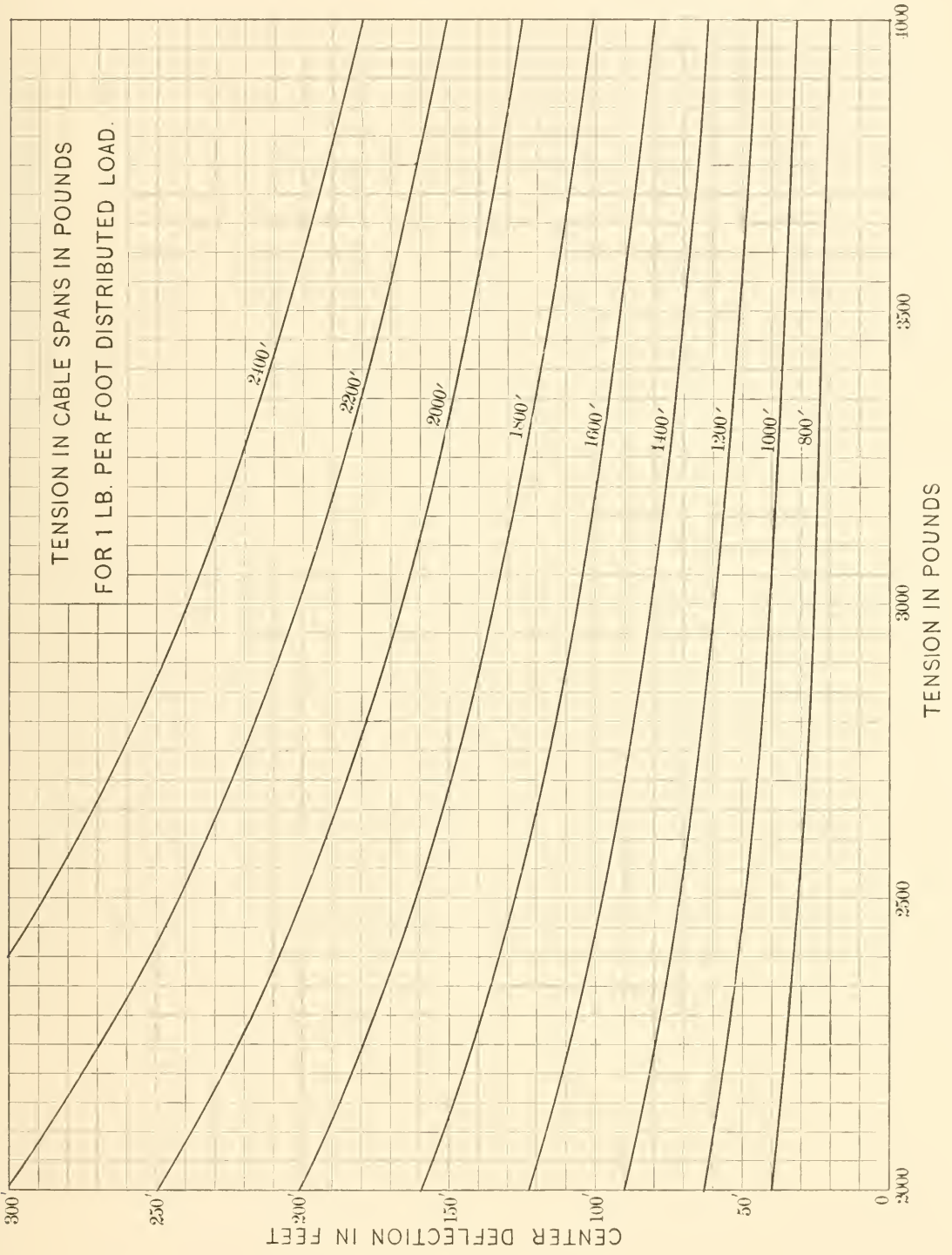

Section 6

Stress Limitations of Machinery In connection with the use of wire rope a very important factor, namely, the power of the machinery, should be carefully considered. It is a well known fact that on many machines the pull which the engine drums are capable of exerting is very close to the strength of the rope, which is put on. This is considered bad practice because it permits overstraining of the rope and very often results in breaking it which may entail considerable damage. Users as well as designers of machinery should always ascertain the pull on a wire rope when full power is on, and if this approaches the strength of the rope, provision should be made in case of a steam engine or boiler to reduce the steam pressure or throttle the steam, and in the case of an electric motor to provide an automatic cut-out capable of regulating the maximum pull. Some unsuccessful applications of wire rope have had their trouble traced to this cause which may exist on a small or large piece of apparatus. A wire rope has a certain definite ultimate strength when new, but this should never be approached if good results are to be obtained.

Section 7

Multiple Sheave Blocks In a direct single line hoist, as shown by Fig. 1, with a sheave of good diameter, the stress upon the rope equals the load hoisted. By using a triple block with a double block, as in Fig. 5, the five parts of the rope carry the load so that the stress upon each part is only one-fifth of the load. In brief, to ascertain the stress on the hoisting rope, divide the maximum load by the number of ropes, or by the number of parts of the same rope, carrying the hoisting hook and load, and add the bending stress to get the total stress on the rope. For bending stress, see Section 2, page 31.

Five-part Line

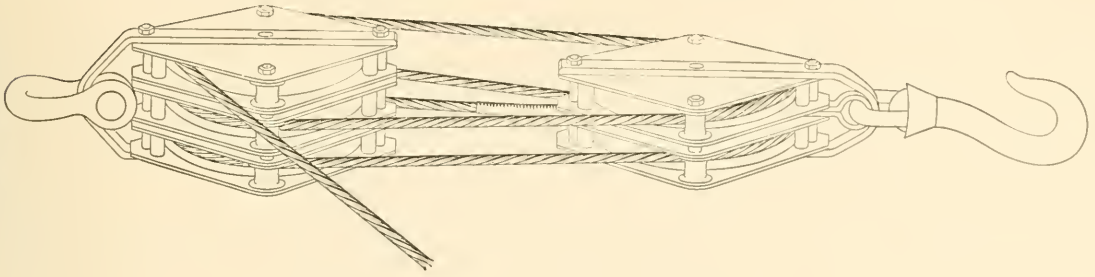

Fig. 5
Stress on Rope is one-fifth the Load

Four-part Line

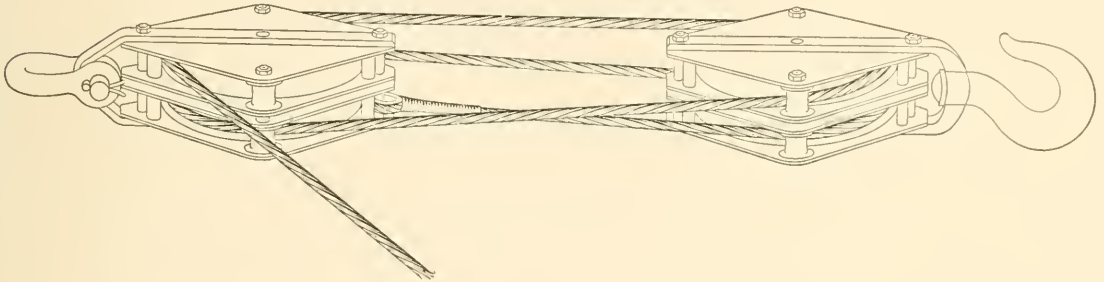

Fig. 4
Stress on Rope is one-fourth the Load

Three-part Line

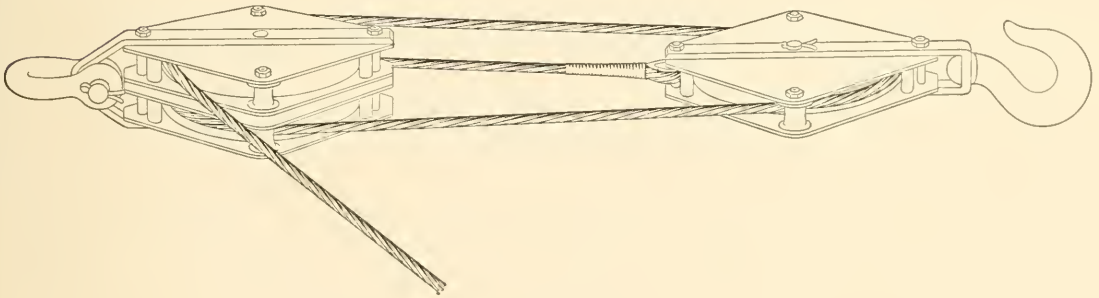

Fig. 3
Stress on Rope is one-third the Load

Two-part Line

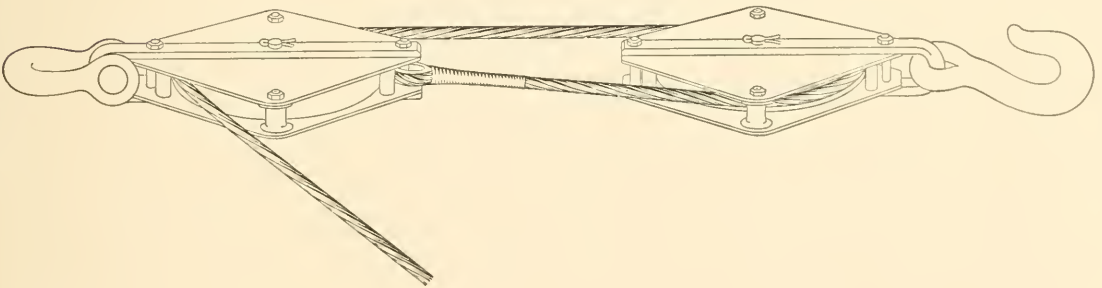

Fig. 2
Stress on Rope is one-half the Load

One-part Line

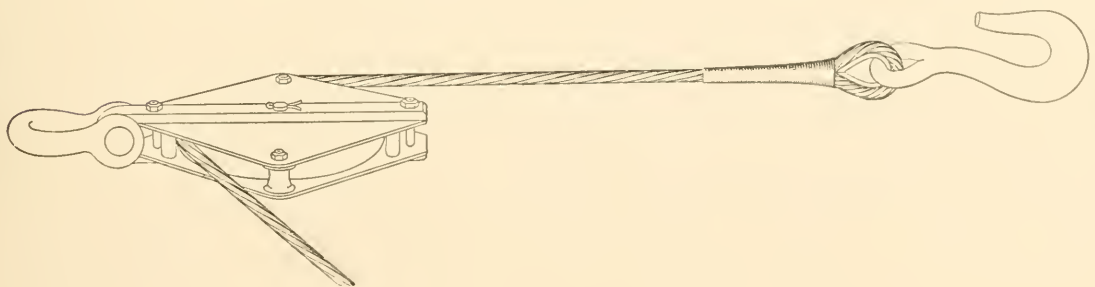

Fig. 1
Full Load on Rope

Section 8

Wire Rope for Guys Many devices employing wire rope must be held in place by guy lines or ropes and since the action of these ropes is different from that of ropes under a straight pull, it is necessary to calculate the stresses in them very carefully. In order to do this a table has been devised which shows the relation between the number of guys upon a derrick or similar piece of machinery and the equivalent effective number of guys acting for any position of the load. This latter quantity is known as the guy factor.

Reference to curve on page 63 shows the maximum and minimum values which the guy factor represents. If it is desired to find the number of guys working on a derrick, for example, all we have to do is to refer either to the table or to the curve and we will get directly the quantities involved. For example, on a derrick with 11 guys, the minimum value of the guy factor is 3.494 or, in other words, for any position of the load the derrick guys have a strength equal to 3.494 times the strength of one guy. Maximum values have been given but these should not be used in calculations. They have been given simply to show that there is a variable effective number of guys acting for different positions of the load.

Reference to the diagram, page 63, and the table page 61, will show conclusively that it is best always to use an odd number of guys in guying a piece of apparatus of any size. This is because the maximum and minimum values of the guy factor are very close together for an odd number of guys, whereas with an even number of guys there is a much lower minimum value. For example, a derrick employing 6 guys has a guy factor of 1.732. The addition of one guy or increasing the guys by $\frac{1}{6}$ will increase the value of the guy factor to 2.248, an increase of 30 per cent. In the interest of economy it is always advisable, therefore, to use a large number of guys. It is further very essential that the guys be spaced evenly so that the angle between each pair of guys is the same as that between every other pair. See page 98.

Another point that should be taken into consideration on guys is the angle that they make with the horizontal. It is apparent that when a guy pulls on the mast of a derrick that it will not give its full strength unless it pulls absolutely in a horizontal line. Whenever it pulls at an angle, the pull will be somewhat less than the total strength of the guy. Reference to curve on page 62 will show the value of the guy pull for various angles of the guy rope with the horizontal. The smaller the angle Θ of the guy of the horizontal the more effective the guy, but for practical purposes this angle may come up to about 26 degrees and still have at least 90 per cent of the strength of the guy. In figuring the strength of the guys, it is first necessary to get the guy factor by reference to curve on page 63 or the table on page 61, then refer to curve on page 62 and get the per cent of the guy acting and multiply this

decimal by the guy factor. The result obtained is the amount of pull in a horizontal line or perpendicular to the mast of a derrick, which pull will act to support a load. This pull must be multiplied by a factor of safety of not less than 4 and preferably 5 for all loads to be lifted.

Values of Guy Factors and Positions of Maximum and Minimum Values for Guy Ropes Equally Spaced

No. Guys	Min. Values Guy Factor	Corresponding Line of Action of Force	Max. Values Guy Factor	Corresponding Line of Action of Force
3	0.866	30° from 1 guy	1.000	Opposite 1 guy or half way between 2 guys
4	1.000	Opposite 1 guy	1.414	Half way between 2 guys
5	1.538	18° from 1 guy	1.618	Opposite 1 guy or half way between 2 guys
6	1.732	30° from 1 guy	2.000	Opposite 1 guy
7	2.193	12° 51' from 1 guy	2.248	Opposite 1 guy or half way between 2 guys
8	2.414	Opposite 1 guy	2.611	Half way between 2 guys
9	2.835	10° from 1 guy	2.879	Opposite 1 guy or half way between 2 guys
10	3.078	18° from 1 guy	3.236	Opposite 1 guy
11	3.494	8° 11' from 1 guy	3.514	Opposite 1 guy or half way between 2 guys
12	3.732	Opposite 1 guy	3.864	Half way between 2 guys
13	4.120	6° 55' from 1 guy	4.150	Opposite 1 guy or half way between 2 guys
14	4.381	12° 51' from 1 guy	4.494	Opposite 1 guy
15	4.757	6° from 1 guy	4.783	Opposite 1 guy or half way between 2 guys
16	5.027	Opposite 1 guy	5.126	Half way between two guys
17	5.399	5° 18' from 1 guy	5.422	Opposite 1 guy or half way between 2 guys
18	5.671	10° from 1 guy	5.758	Opposite 1 guy
19	6.046	4° 44' from 1 guy	6.054	Opposite 1 guy or half way between 2 guys
20	6.314	Opposite 1 guy	6.392	Half way between 2 guys

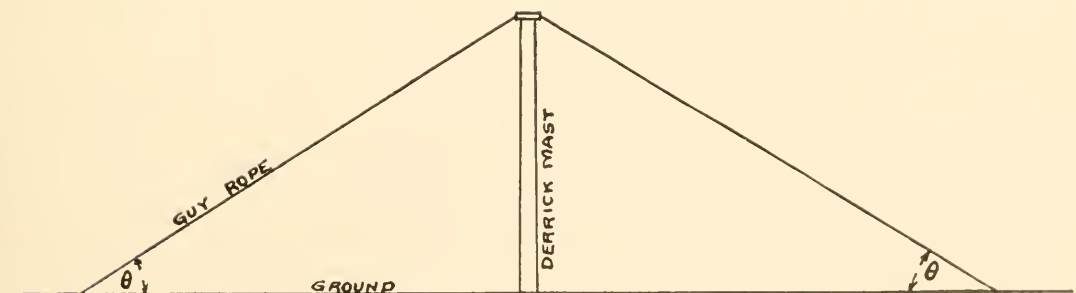

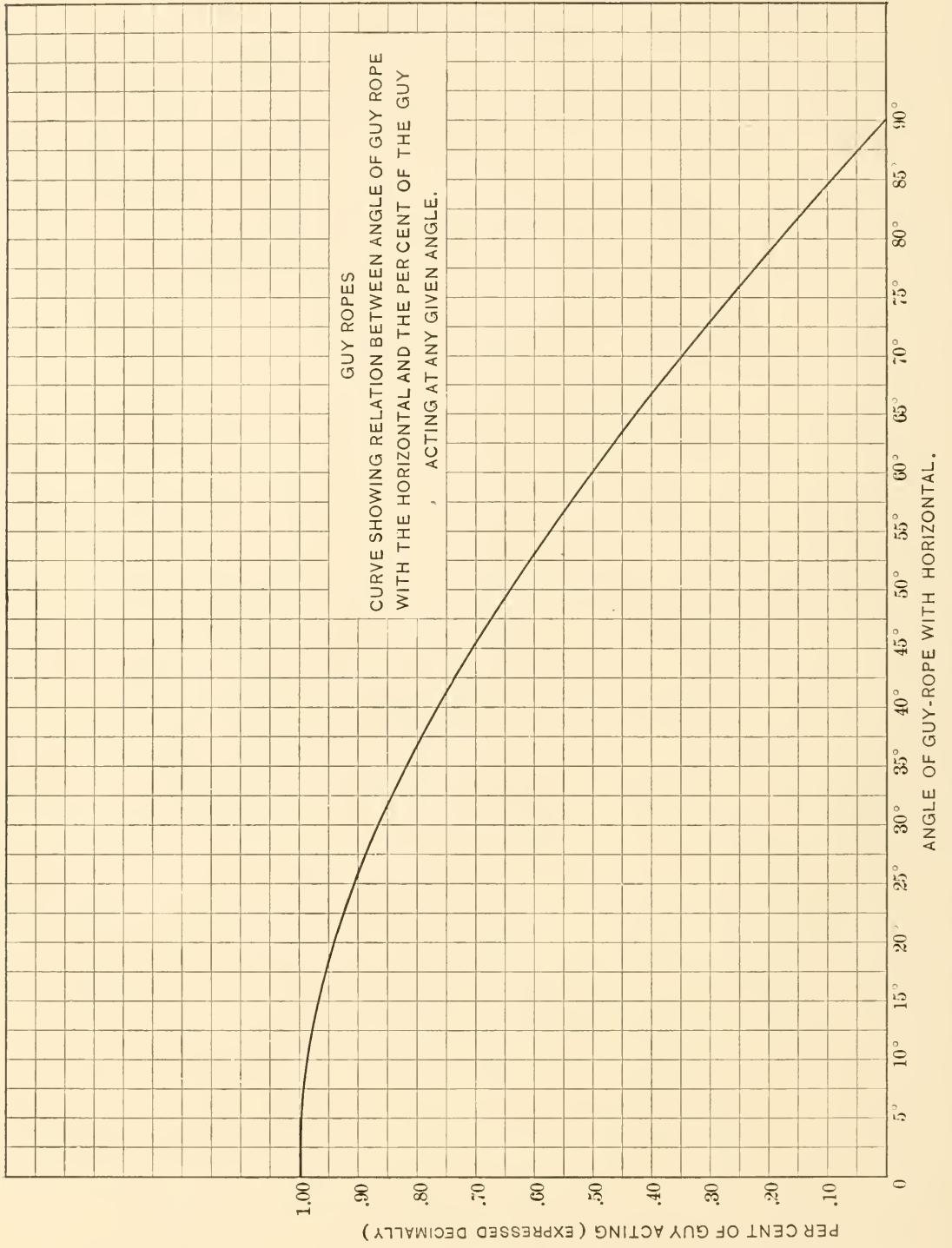

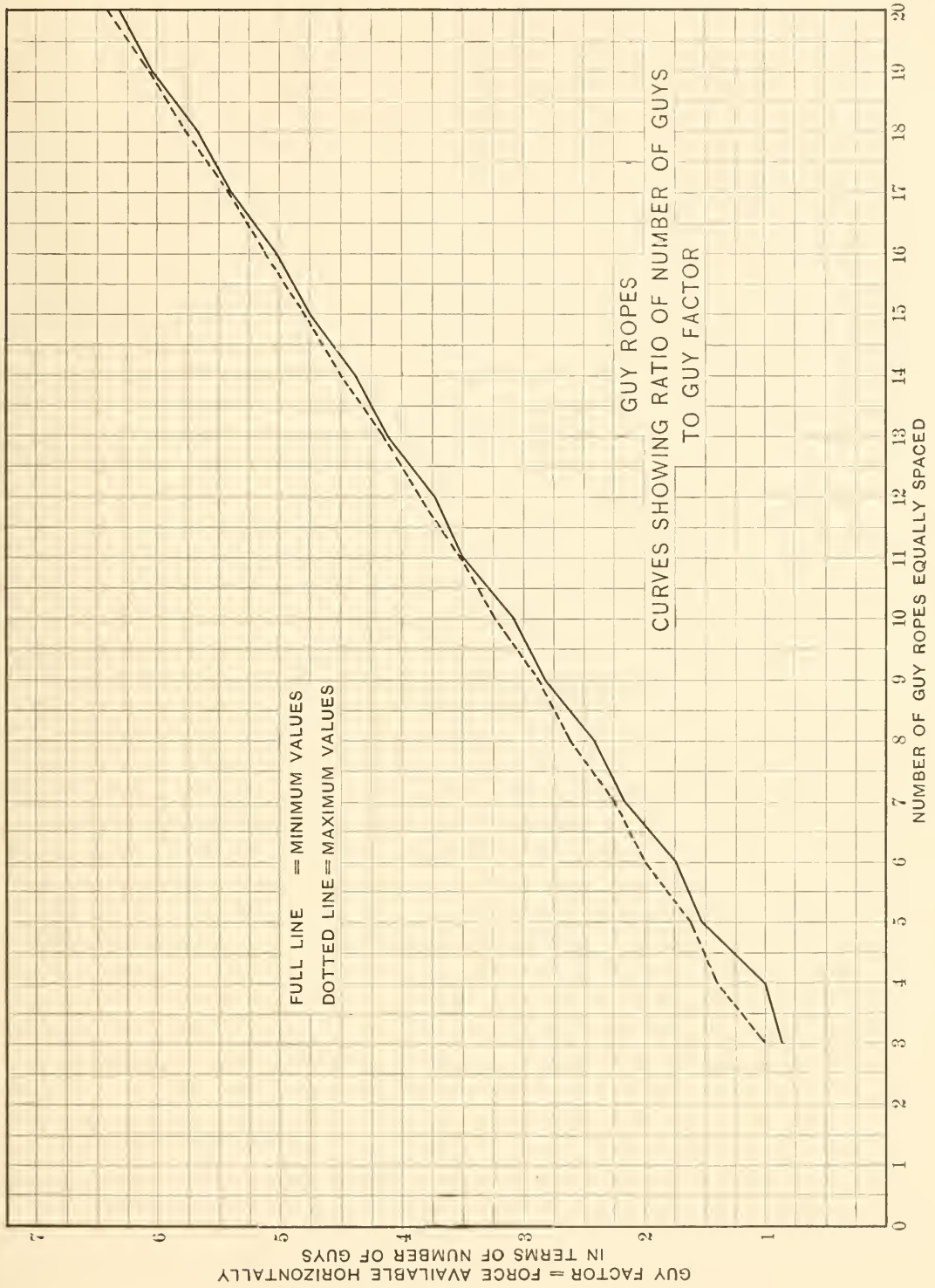

Section 9

Factors of Safety In the previous sections many of the principal forms of stresses that are commonly present in wire rope applications have been considered. Not all of them are present in any one case, but the factor of safety must always be considered. The proper selection of this factor is of vital importance, for on it depends to a great extent the successful operation of any mechanism employing wire rope.

While it is not possible to give exact figures which should be employed for the many uses of wire rope, still certain general principles can be evolved which will indicate very approximately the figures that should be used. It is the practice of some users of wire rope to use a large factor of safety and figure on only dead load, whereas the load is probably a live one and the rope is bent around fairly small sheaves. In a case of this kind a large factor of safety may allow for the increased stress, but at best it is an unsatisfactory way to treat the subject. It is much better to determine what the stresses are and then apply a simple factor of safety.

In the eight preceding sections we have considered the principal stresses to which a wire rope is subjected, and if these stresses are calculated wherever any of them occur and the result added to the already known load upon the rope, it will facilitate the use of an ordinary factor of safety. The figures given in the catalogue are for a factor of safety of approximately 5, neglecting the bending stress. This amounts to a net factor of safety of between 4 and $4\frac{1}{2}$ when this is considered with the sheaves given in the table. We would not recommend a factor of safety much lower than these figures for any class of work, and for a good many places the factor of safety ought to be larger. For example: It is the practice on elevators to have the wire rope calculated on a factor of safety of from 5 to 10, and similar practice is found in many mining propositions where the rope is not very long, the reason for which has already been explained in Section 3 of this chapter. Where ropes are very long, as sometimes occurs in mining practice, the weight of the rope itself is sufficiently great to deduct considerably from the strength of the rope. When this is the case the factor of safety is sometimes cut down as low as $4\frac{1}{2}$, because it is not possible to get quite as large a factor of safety as might otherwise be desired. For slow speed the factor of safety may be somewhat less than for high speed.

For example: A derrick frequently works on what would be considered in other places a very low factor of safety, and the reason for it is that the load is steady and the speed slow enough so that there is no added strain on the rope other than that due to the load and the bending stress over the sheaves. In fast operating machinery, however, such as ore and coal handling clam shell buckets, the factors of safety employed are usually greater, and some run up as high as ten. It is generally conceded the greater the factor

of safety the longer the rope will last and the safer it is. Particular pains must be taken to avoid having too large a factor of safety.

For example: The factor of safety such as 25 is altogether too large and the result is somewhat like using a 1-inch rope where a $\frac{5}{8}$ -inch would do. In other words, a rope could not give its best results under such light loading as a factor of safety of 25 would indicate. Every device using wire rope has of course to be considered on its own merits, as regards the selection of a factor of safety. On ballast unloader rope, such as is used for plowing material from flat cars by means of a plow and a wire cable, it frequently happens that the strain on the rope may run up to nearly one-half its breaking strength. This is because it is not possible to use a large drum and a larger rope and handle it economically, but such heavy loading in a case like this, where there is no risk to life, should not be taken as a precedent for heavy loading under other conditions where it is possible to use a sufficiently heavy rope. Derrick guy ropes are frequently strained severely when an exceptionally heavy stone is lifted, but it is never safe to strain them on the heaviest possible lift to over one-third of the breaking strength of the guys. It is probably true that the greater number of applications requiring the quick handling of loads employ a factor of safety ranging from 5 to 10.

B—Size and Quality of Rope to Meet the Stresses

Having carefully considered the various stresses found in a wire rope and calculated them in accordance with the nine preceding sections, the question naturally arises—what size of rope should be used for a given condition? This cannot be answered off hand, but there are factors entering into the problem which can be briefly generalized. In the first place, Section 2 must be carefully considered on all problems, and an unusually high bending stress in a rope is an indication that its life will be rather short. If on the other hand the bending stress is not excessive, the service obtained should be fairly good. Rope users should refer to the tables of bending stresses for the construction which they propose to use and see what this amounts to before definitely deciding upon any construction. In case of doubt as to which construction should be used our engineers are always ready to consider the problem and give the customer the benefit of our experience.

In general, it might be noted that in a rope of a given strength we could use on hoisting rope say 1-inch crucible steel or a $\frac{7}{8}$ -inch plow steel and get almost exactly the same factor of safety. In a case where the sheaves must of necessity be small, the $\frac{7}{8}$ -inch plow steel probably would be preferable to the 1-inch crucible steel, referring of course to the same construction.

The figures given in the lists for proper working loads should be used for rough calculation only, because the factor of safety should be carefully

considered as outlined in Section 8 of this chapter and the proper factor of safety selected for the work at hand.

The relative strengths of the various materials in a wire rope are given in Chapter II, dealing with materials. This is also shown by the various strengths given in Chapter IX.

Sections 1, 2, 3 and 8 will enter into consideration of practically every common wire rope problem. The remaining Sections 4, 5, 6 and 7 enter into the consideration of special rope problems. See page 30.

Chapter VI

Suggestions to Rope Users

The success or failure of a wire rope installation often hinges upon practical points which are sometimes overlooked. Such being the case there have been compiled a number of suggestions gathered from our long experience which are offered to the trade not as a final word but as an indication of what should be avoided and what may be beneficial to wire rope service.

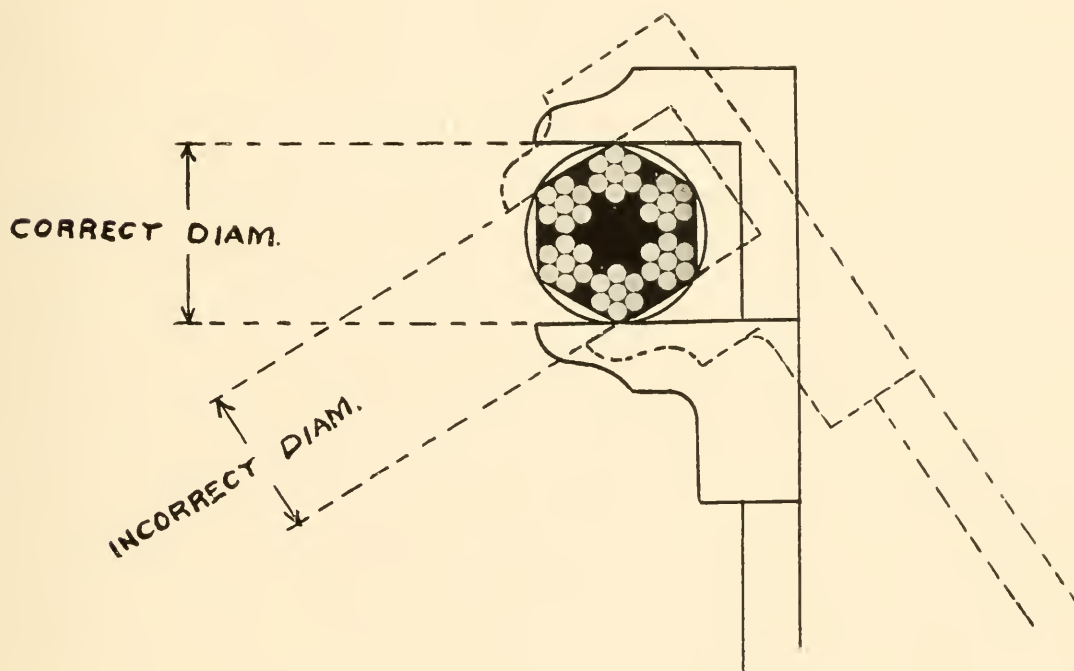

How to Gauge Wire Rope The diameter of a wire rope is the diameter of the circle which will just enclose all the strands. Care should be taken in gauging a wire rope to take the greatest and not the smallest diametrical dimension, as shown above.

Sheaves and Drums Most wire rope applications use sheaves over which the rope runs and drums upon which it winds. These are indispensable units and the use of as large drums and sheaves as practicable is strongly recommended. Particularly attention is called to the section descriptive of bending stresses of rope found in the chapter on "Wire Rope Stresses," page 31. The effect of too small sheaves and drums will readily be seen by making a calculation in accordance with the information given therein. Drums should be lagged if possible, and wherever feasible the use of a grooved drum on hoisting machinery is recommended as better than

a flat drum without grooves. It is important to have the grooves on drums spaced so that there is ample clearance between the successive windings. For example: A drum for a $\frac{3}{4}$ -inch rope should be arranged so that the grooves are not nearer than, say $\frac{7}{8}$ of an inch on centers. This will prevent undue crowding or rubbing of one part or wrap of a rope against another. The grooves of sheaves and drums should be made smooth in order not to cut the wires of the rope which winds upon it. They also should be made of a slightly larger radius than the rope which is to run on them so that the rope will not wedge nor pinch.

Overwinding It is also important wherever possible to have the drum large enough or wide enough so that the wire rope may wind upon it in one layer.

The term overwinding has been applied to cases where wire rope has to wind two or more layers deep on a drum. This is a very bad condition and one that should be carefully avoided, because the wire rope will mash and jam more or less and will not last nearly as long. It may be a little more expensive to provide a larger drum and may necessitate a change in the gearing of the machinery, but for the best working conditions and lowest cost of operation overwinding must be avoided.

Alignment of Sheaves and Drums The best possible alignment of sheaves and drums should be obtained, otherwise there will be undue wear on the side of the sheaves and drums as well as on the rope. In general the lead sheaves over which the rope runs from the drum should be lined up with the center of the drum, or if the drum is not entirely filled it should be in line with the center of that portion of drum on which the rope is wound.

Leads It is necessary to have the proper amount of space between the lead sheave and the drum in order to avoid too sharp an angle: We recommend an angle not exceeding $1^{\circ} 30'$ between the line from the center of sheave to center of drum and the line from the center of sheave to the outer side of drum.

Renewal of Sheaves The upkeep of a piece of machinery is essential in order to secure the best wire rope service. If sheaves become badly scored or worn, a new rope will not work properly and many careful users of wire rope insist on changing the sheaves or turning out the grooves before a new rope is put on. This insures best conditions for rope service. For mine hoisting in particular the best practice is to make the large sheaves and drums with liners which can be taken out and renewed when they wear out or whenever a new rope is installed.

Speed of Wire Rope A high velocity on a wire rope means that the rope will not last as long as if only a medium velocity were employed. Of course a high velocity means that more work is accomplished in a given time, but it is better to have the load increased and the rope slightly larger with the speed correspondingly slower to get the best results as far as tonnage handled.

Reversed Bending By this term we refer to that sort of bending in which a wire rope is first bent around one sheave in one direction and at some other section the same rope is passed around another sheave with a bend diametrically opposite. This is an exceedingly severe condition of rope service and its use should be avoided wherever possible. There is no known way in which a wire rope may be worn out more rapidly by bending than by the use of the reversed bend. We have practically demonstrated that this is one of the severest conditions that wire rope has to meet. In many places by a little study or a slight change in design this feature can be avoided. It is of sufficient importance that many users of rope change their machinery over to get around it on account of the vastly increased service which they obtain from a rope where this condition is absent. Reverse bending cannot be too strongly condemned. There is a very limited number of cases where this reversed bending cannot be avoided, and at such times the rope has to be sacrificed, but knowing the bad effects resulting from such reversed bending, it is desired to sound a note of warning that should be heeded by all.

Handling of Wire Rope It is not probable that any one would intentionally mishandle a piece of wire rope in installing it, but we feel that a word of caution should be given. In the first place a wire rope does not handle like a manila rope, in that structurally it differs. It must not be coiled or uncoiled like a hemp rope. If it is received in a coil it should be unrolled on the ground like a hoop and straightened out before attempting to pass it around the sheaves on machinery. If it is received upon a reel, the reel should be mounted upon jacks or a shaft so that it will turn and the rope be properly unwound.

Sudden Stresses It is very essential to avoid sudden stresses or jerks on a wire rope because this increases the load to a great extent, as will be noted by reference to Chapter V, Section 3, page 47. A simple experiment will demonstrate the effect of this. A piece of twine fairly strong may be easily snapped by a quick pull.

Galvanized Rope This is not used for general hoisting or general purposes because the zinc wears off rapidly from running over sheaves and drums. Galvanized ropes are about 10 per cent less in

strength than ungalvanized ropes. The strengths for galvanized ropes not shown in this catalogue can be furnished upon application.

Protection of Wire Rope A wire rope that runs out of doors should be protected as far as possible from the weather by the application of some suitable lubricant. We manufacture a lubricant which is an especially heavy compound for coating wire rope. It will adhere as tenaciously as any compound that we know of and has been successfully used for this purpose. All ropes, whether for inside or outside work, should be given some lubrication to keep them pliable. If this lubrication is omitted, internal as well as external rust may set in, stiffening the rope and causing it to give poor service. See page 199.

Working Loads These have been carefully considered in Chapter V, Section 9, but a good rule to follow is that these should not exceed one-fifth of the ultimate breaking stress of the rope. On a guy rope this is sometimes exceeded, but it never should be in mines or elevators where human life is at stake.

Wire Rope Transmission There are not a great many applications requiring an endless wire rope for transmitting power. Such applications, however, require pulleys lined with wood, leather or rubber in order to ensure the most successful operation. See page 234.

Rope Exposed to Heat A few conditions exist where rope is exposed to intense heat and at such places a soft iron wire center is usually substituted, and sometimes asbestos. The latter, however, rapidly disintegrates under constant bending, and we therefore do not recommend its use. For either of these special centers add 10 per cent to the list price of rope with hemp center.

Chapter VII

How to Order Wire Rope

Use the exact terms given in catalogue describing the rope required, stating length, size, diameter (or circumference), quality, number of strands, number of wires in the strand, and whether hemp center or wire center is wanted, also whether bright or galvanized is desired, e. g., 750 feet long, 1½ inches in diameter, plow steel hoisting rope, six strands, nineteen wires, hemp center, one piece.

If rope is to be equipped with thimbles, sockets, hooks, links, loops or other fittings, state the length from the pull of thimble, socket, hook, link, loop, etc., to end of the rope. Where fittings are to be put on each end, be sure and state the length from pull to pull of fittings.

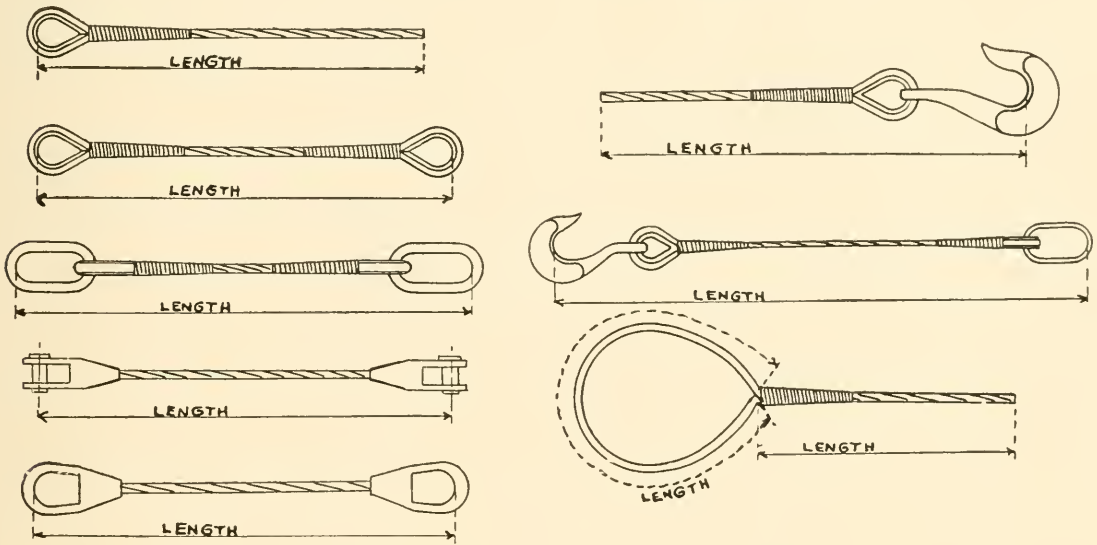

If in doubt as to the material to be used, the conditions under which the rope operates should be given or a sample of rope that is satisfactory submitted so that the proper quality and construction may be furnished.

If possible, submit a rough sketch with the order, or inquiry showing the size and relative position of the sheaves, together with the figures of maximum load in pounds. This greatly facilitates a complete understanding of the requirements which the rope must fill. See page 72.

When ordering rope for elevators, state whether hoisting, counterweight, or hand or valve or safety rope is wanted, also whether right or left lay is desired. The ropes used for these purposes all differ and are not interchangeable.

For convenience in installing elevator hoisting or counterweight ropes when used in pairs or two-part lines, we will, at no extra expense, wind the rope upon a reel with the length of rope doubled in the middle so that the loop will come off the reel first or last as desired.

Further information is contained in Chapter VIII on practical applications of wire rope, pages 72-118.

Chapter VIII

Practical Wire Rope Applications

The vast number of devices employing wire rope as a flexible medium for utilizing mechanical or electric power in the handling of various commercial problems, would require a large work if each were to be but briefly described. The leading principles involved can, however, be shown by a few typical illustrations selected from the many that are available. The following seventeen divisions have been chosen for illustration :

	Page
1. <i>Aeroplanes</i>	73
2. <i>Cableways and tramways</i>	74
3. <i>Cable roads</i>	77
4. <i>Clam shell buckets</i>	79
5. <i>Cranes</i>	81
6. <i>Derricks</i>	83
7. <i>Elevators—hydraulic, electric and power driven</i>	85
8. <i>Excavating machinery, including dredges, steam shovels, etc.</i>	92
9. <i>Ferries</i>	96
10. <i>Guying for derricks, ships, etc.</i>	97
11. <i>Loading and unloading machinery</i>	102
12. <i>Lumbering, including skidding and loading</i>	104
13. <i>Mining rope arrangements</i>	107
14. <i>Oil well drilling</i>	114
15. <i>Suspension bridges</i>	116
16. <i>Stump pulling</i>	117
17. <i>Towing devices</i>	118

In order to more clearly show the rope action, the working parts of the machinery involved alone have been depicted in most cases, all details that would obstruct the clearness of the diagrams having been omitted.

Wire rope for any of the purposes detailed in this chapter, as well as many others, can be supplied, but in case customers have machinery of the types shown herein, it will facilitate a clear understanding if reference is made in correspondence to the type of the machinery that is being used, provided it is illustrated herein. Machinery shown represents commercial machinery of leading machine builders in the United States.

Division 1

Aeroplanes One of the latest comers into the field of wire rope users is the aeroplane, and for its use special kinds have been devised known as aeroplane stay strand and flexible rudder steering cord (page 183).

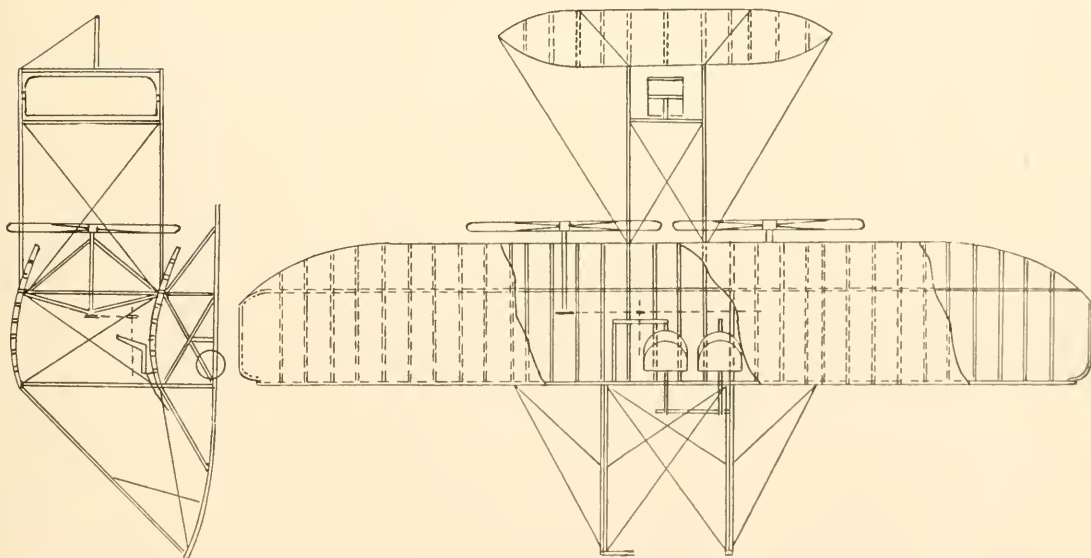
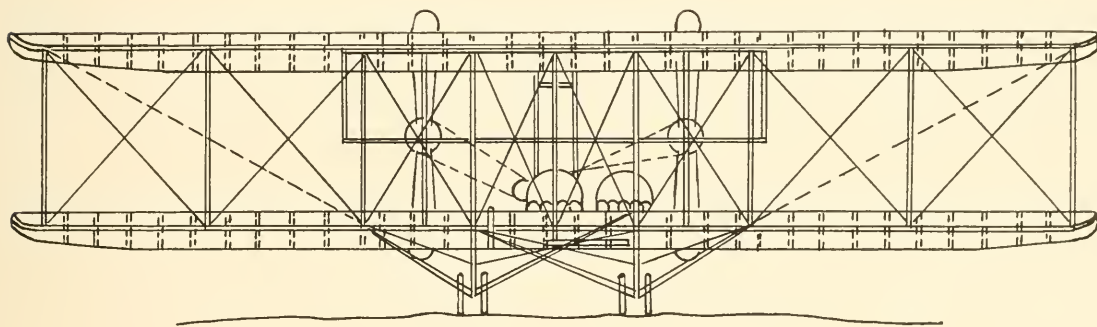

Division 2

Cableways and Tramways

Cableways consist of one or more large stationary track cables stretched between suitable towers with auxiliary smaller ropes for moving the mechanism. The principal use of cableways is for conveying large loads for a limited distance between the two main towers, also for excavating, dam building, canal work, logging, deep pit quarrying, and the conveying of any bulk material where natural obstructions interfere with any other method of operation. It is preferable to use for the

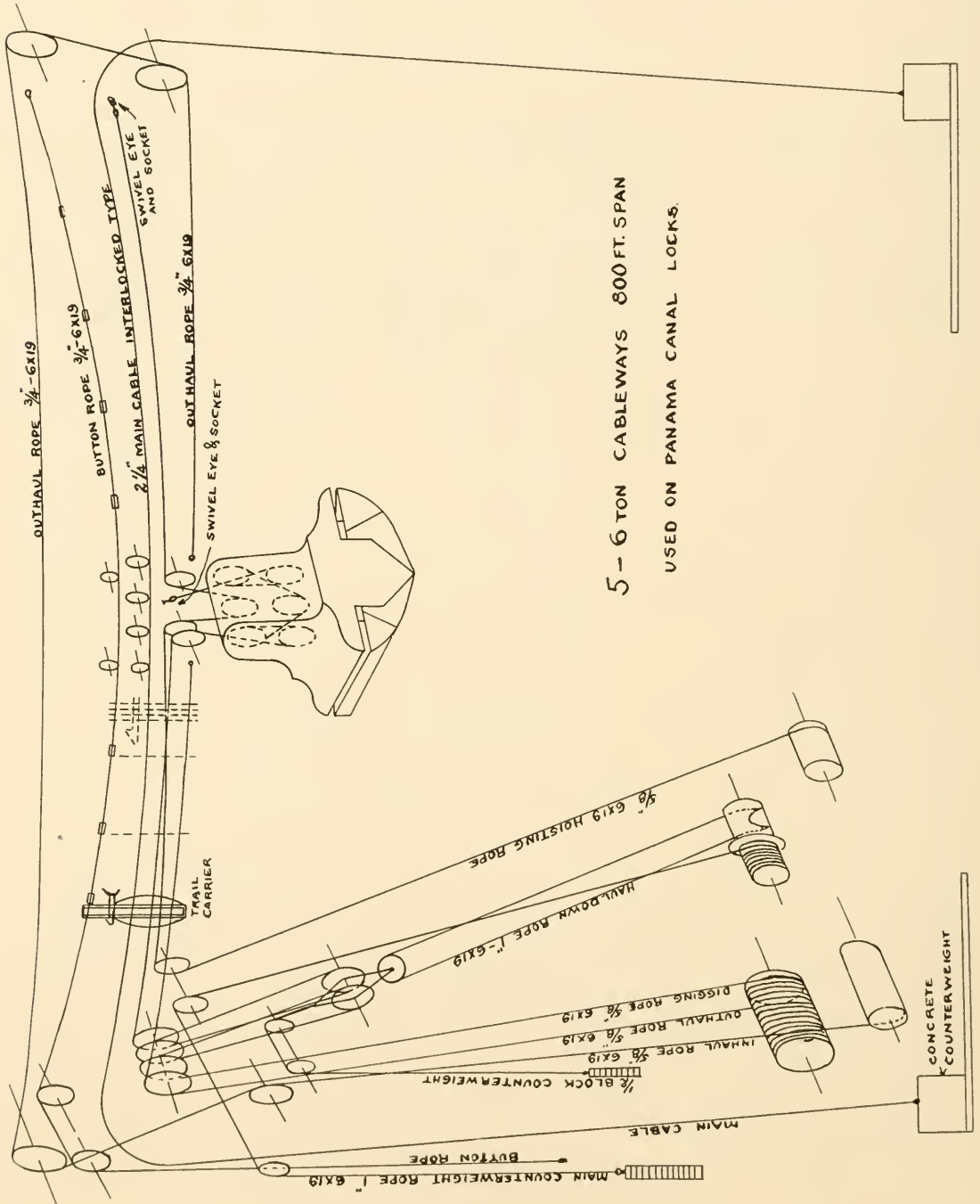

main cables the locked wire track cable shown on pages 24 and 191, especially if the cableway is for constant operation, as the efficiency will be greater than the round wire cable described on page 190. The first cost of the locked wire type is of course greater than that of the round wire cable, but the increased life of the former makes it cheaper in the long run.

The two types of cableways shown below are among the latest types and are facsimiles of the thirteen now being used at the Panama Canal, building the locks at Gatun. Each uses a two and one-quarter-inch locked wire track cable for the main cable.

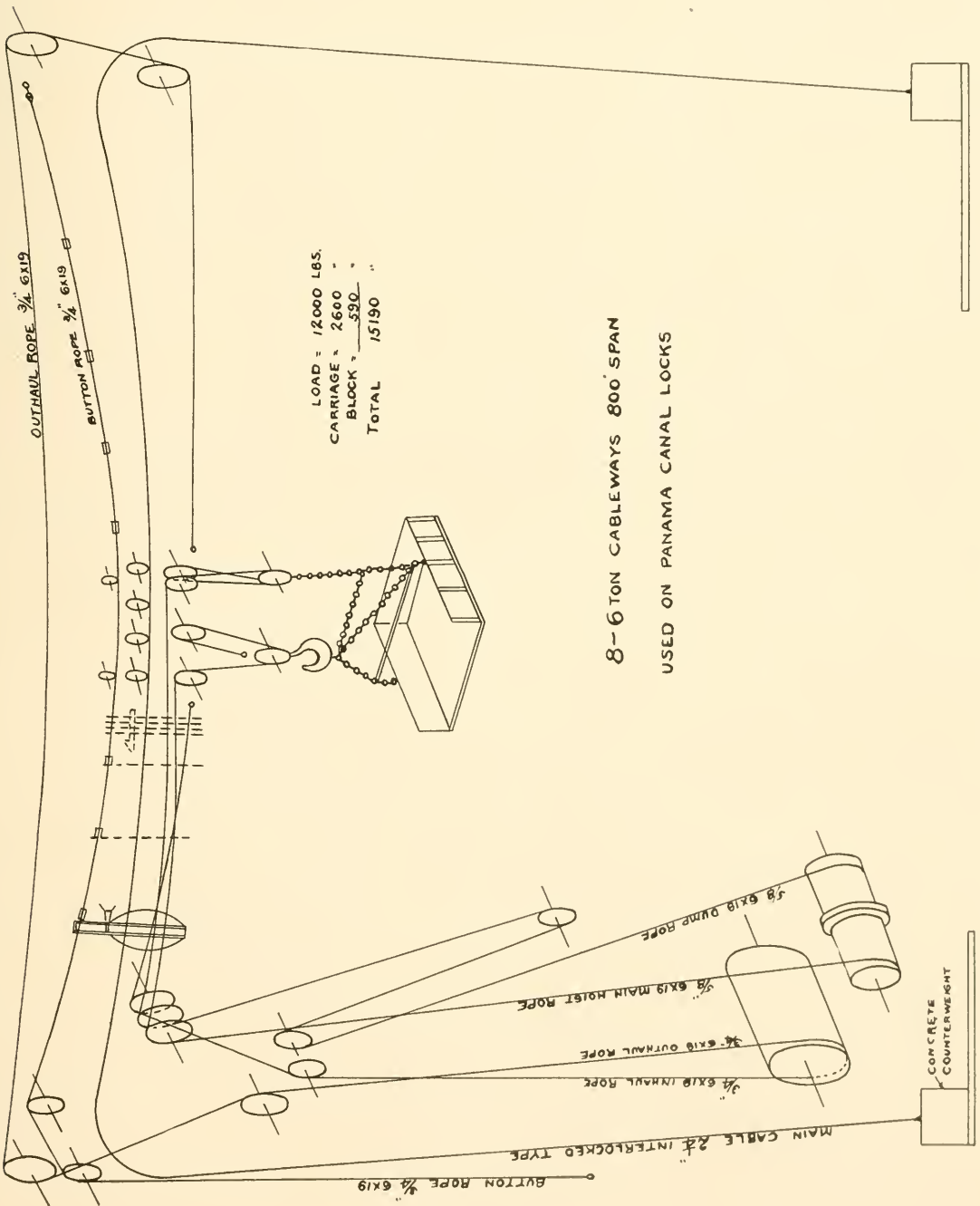

As usually constructed, cableways may be used to handle a single load at any point between the towers and discharge at any other point between them, either into cars or to a spoil bank.

Aerial Tramways are recognized in contradistinction to cableways in the fact that, as ordinarily constructed, they are designed to move a number of lighter loads in a continuous circuit over comparatively long distances. The materials are carried in receptacles (buckets usually) suspended from carriages on stationary track cables of the Locked Coil construction (see page 190) supported at varying elevations above the ground.

The loaded carriers travel along a line of track cable in one direction, and the empty carriers in returning along a similar parallel track cable, these cables being of sizes corresponding to the weights they have to support. Motion is imparted to the carriers by a comparatively light endless rope commonly known as the traction rope, by means of large sheaves at either end, one for driving, and the other, which is usually mounted on a slide actuated by a counterweight, for maintaining the requisite tension in this rope. The application of tension, however, may be at either terminal station as desired. The carriers are despatched at definite intervals, determined by the individual loads, the amount of material to be transported in a given time, and the speed. For further particulars parties are referred to our separate publication entitled "Aerial Tramways," which fully describes and illustrates the various equipments of this kind that we manufacture.

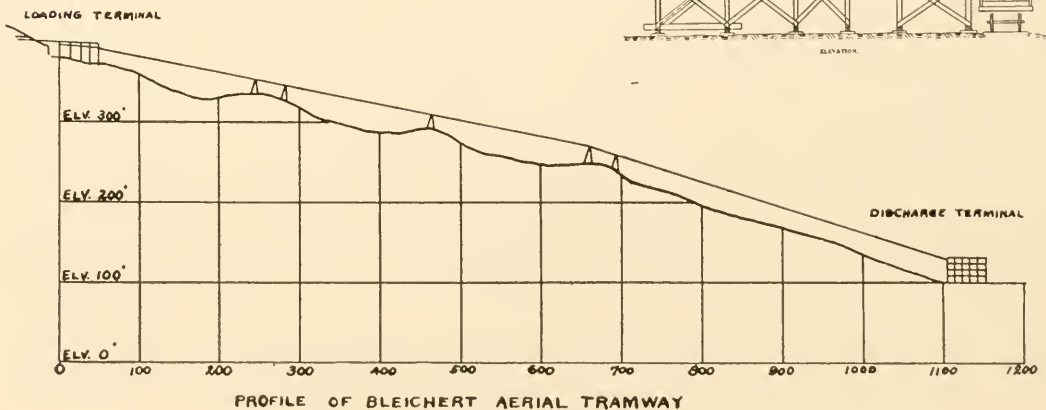
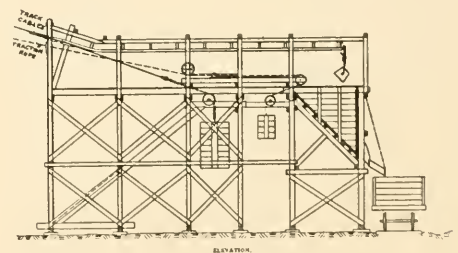
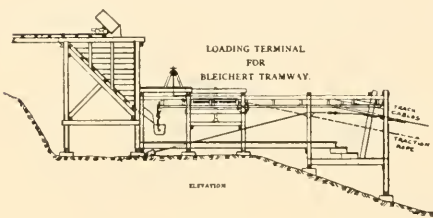
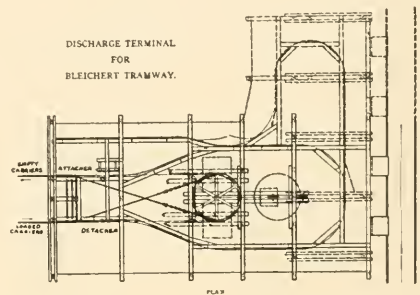
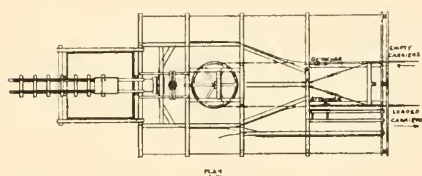

Division 3

Cable Roads Before the introduction of electric power for street railways, cable roads were very largely used. They are still used for very steep inclines, and also on industrial narrow gage roads.

The illustrations which follow show a large broad gage industrial cable road, also two narrow gage industrial roads used on docks for handling coal and iron ore. Also an illustration of an incline railway running up a mountain.

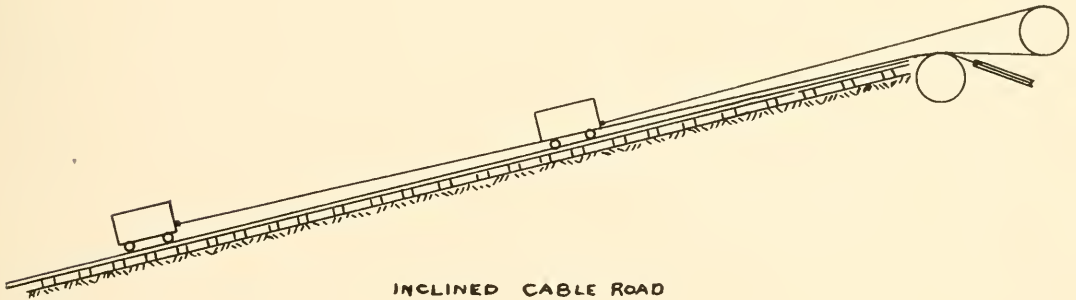
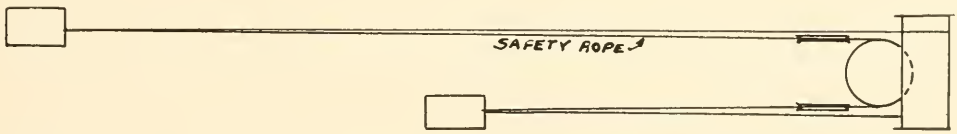

INCLINED CABLE ROAD

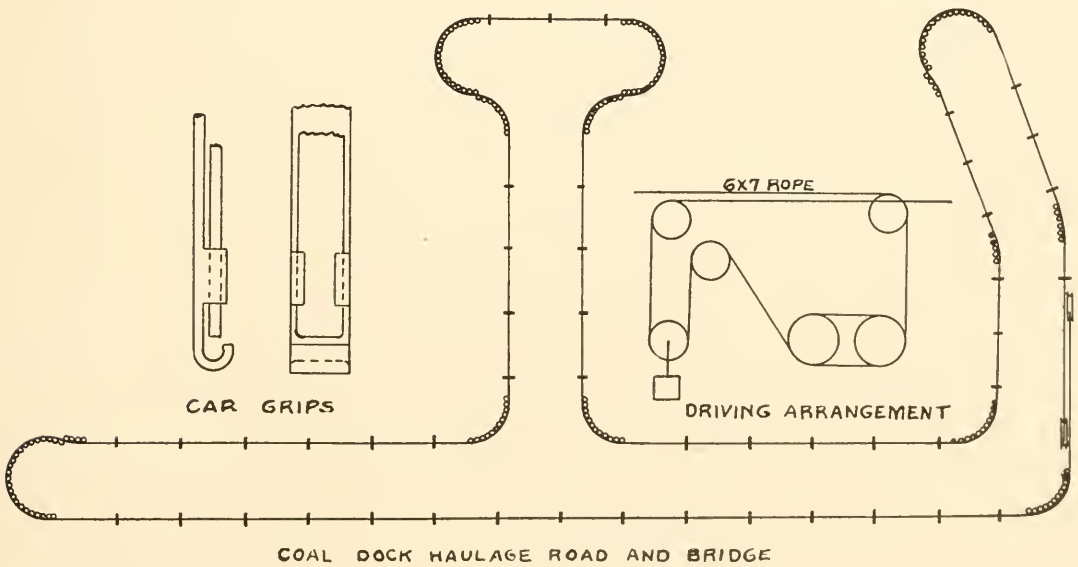

COAL DOCK HAULAGE ROAD AND BRIDGE

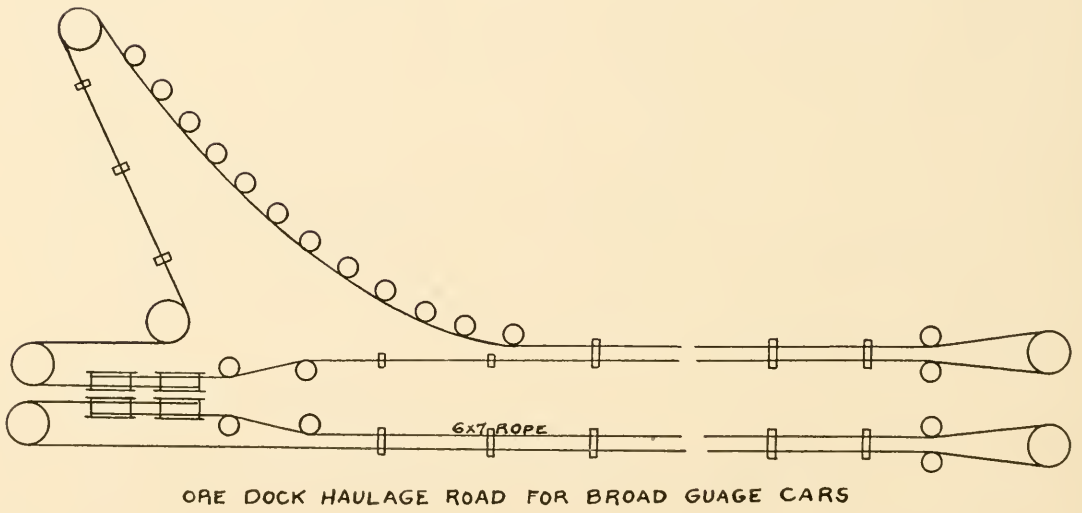
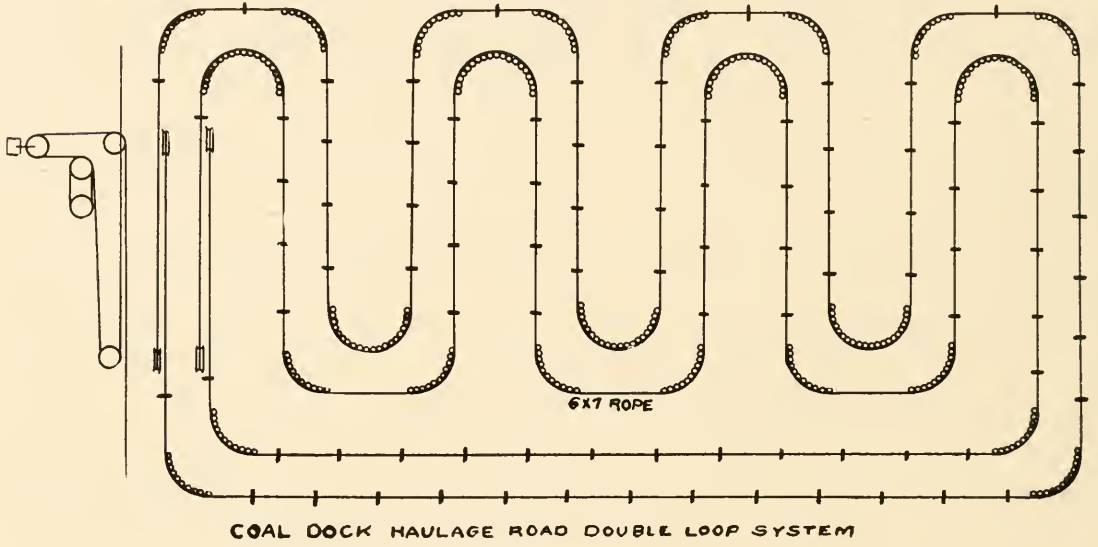

Division 4

Clam Shell Buckets These consist of two scoops pivoted together and operated by two sets of ropes known respectively as the holding rope and the opening or closing rope. The former is attached to the top of the bucket by means of a thimble or socket spliced into the end of the rope, while the opening or closing rope passes down into the bucket and around several sheaves variously arranged to give a heavy force to close the two jaws of the bucket. The various types of bucket differ in the methods of working the opening and holding ropes. Various sizes are in use at different points varying from one ton up to twenty tons capacity. As a general proposition the bucket usually weighs nearly as much as the load it carries, the weight being necessary to give sufficient strength as well as digging power.

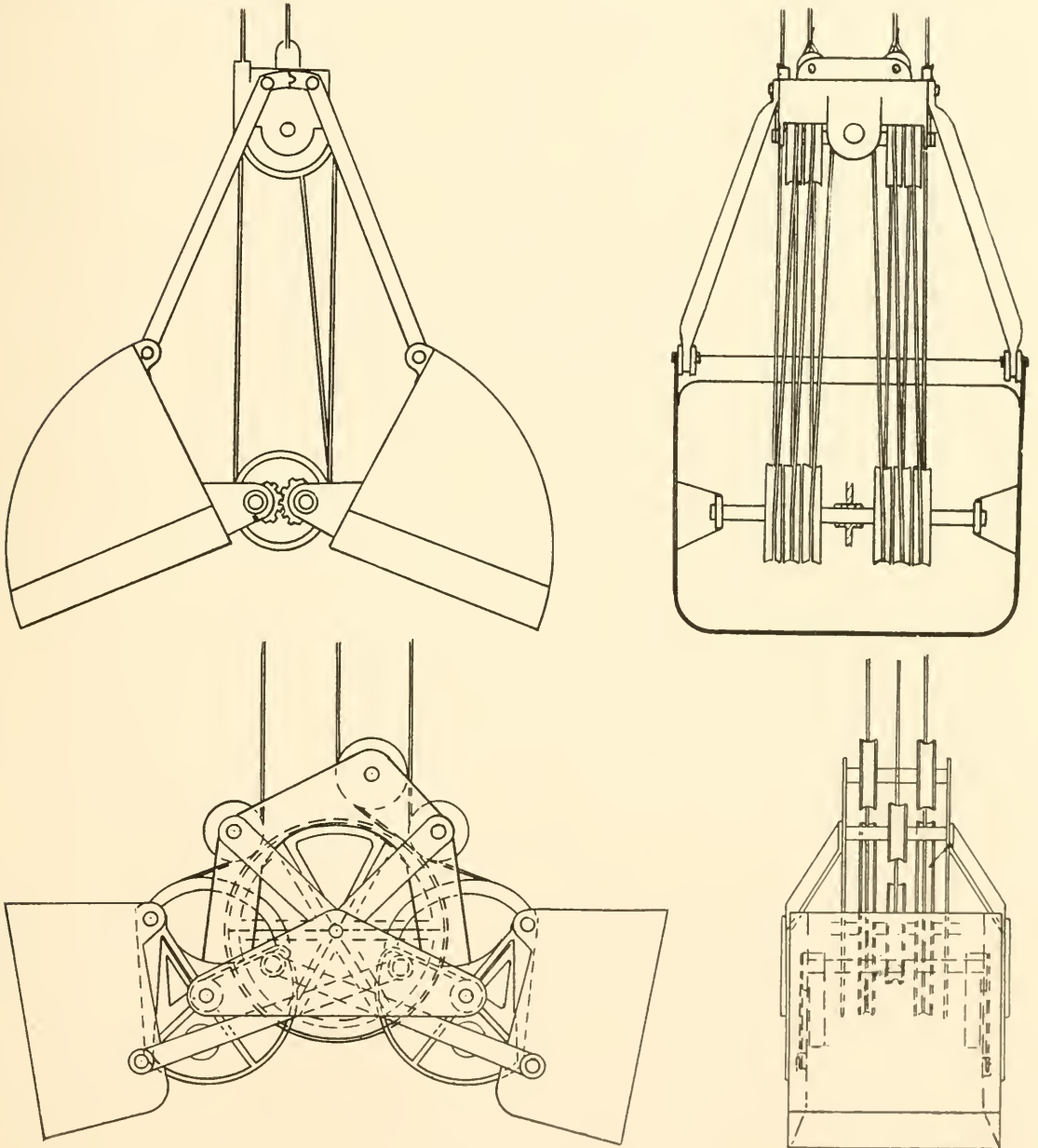

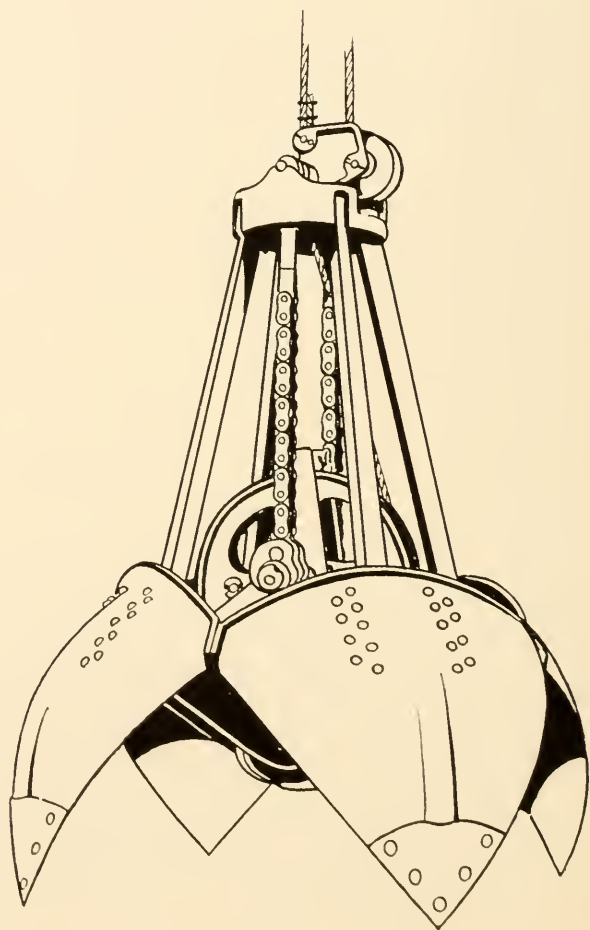
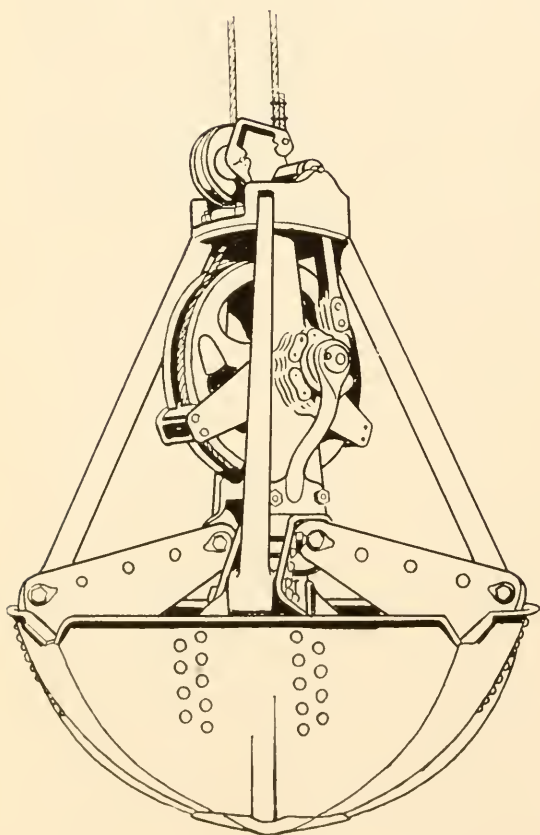
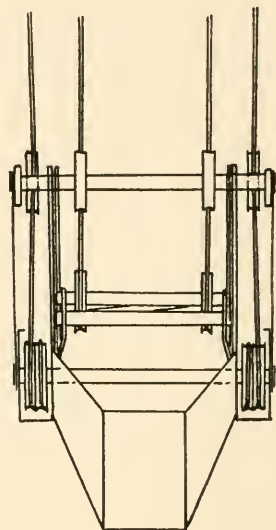
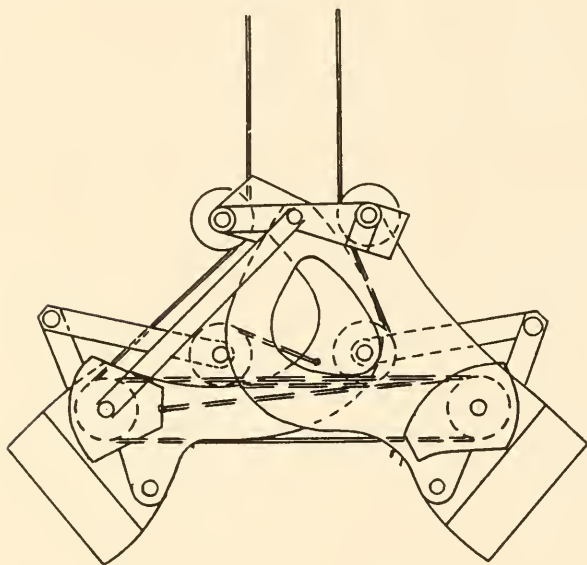

Division 5

Cranes For handling large objects in buildings, warehouses, shops, etc., electric overhead traveling cranes are largely used. Their operation is simple, consisting of a drum electrically driven and a wire rope tackle block of sufficient number of parts and suitable size of rope to handle the required loads with proper safety factor. For steel mills and hot metal cranes, foundries, as well as for crane service in general, the 6 x 37 rope illustrated on pages 141 and 142 will be found particularly useful.

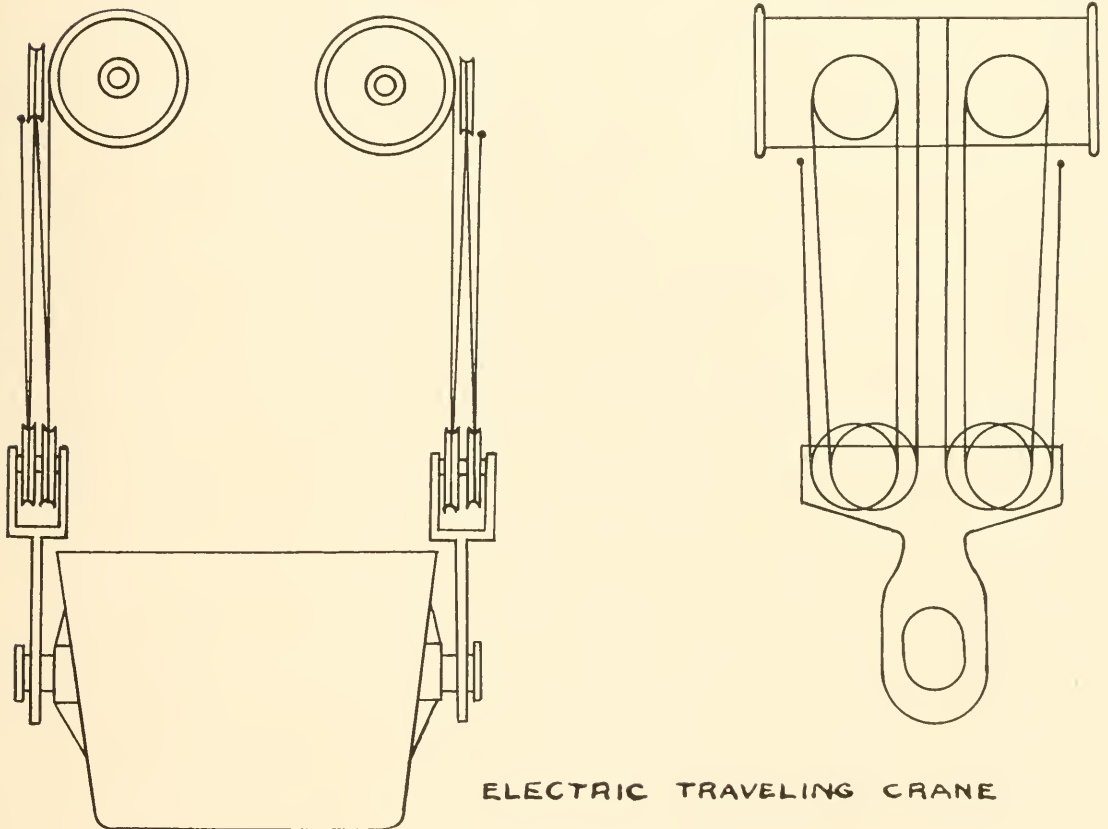

ELECTRIC TRAVELING CRANE

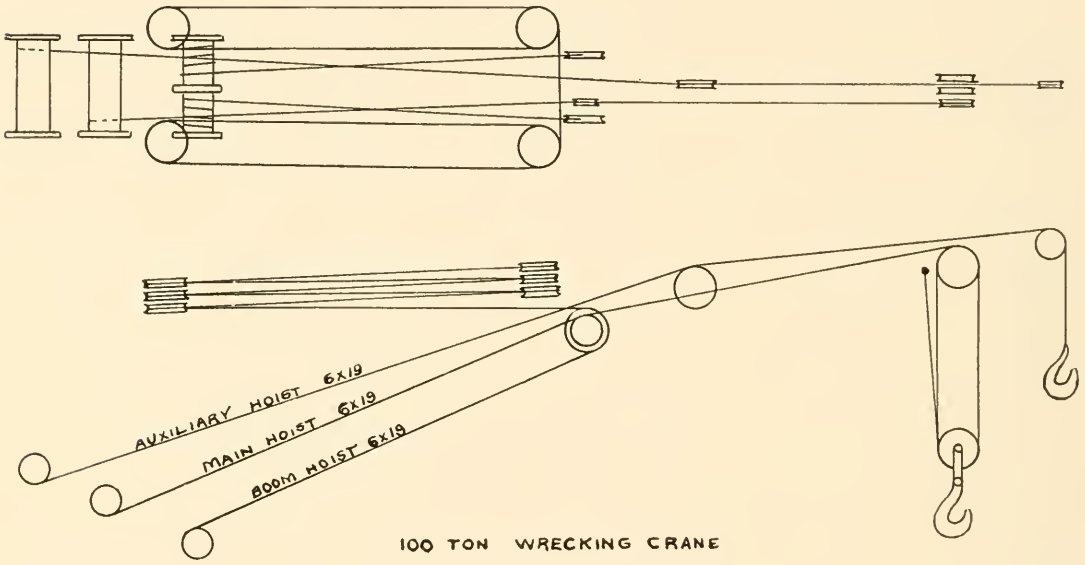

100 TON WRECKING CRANE

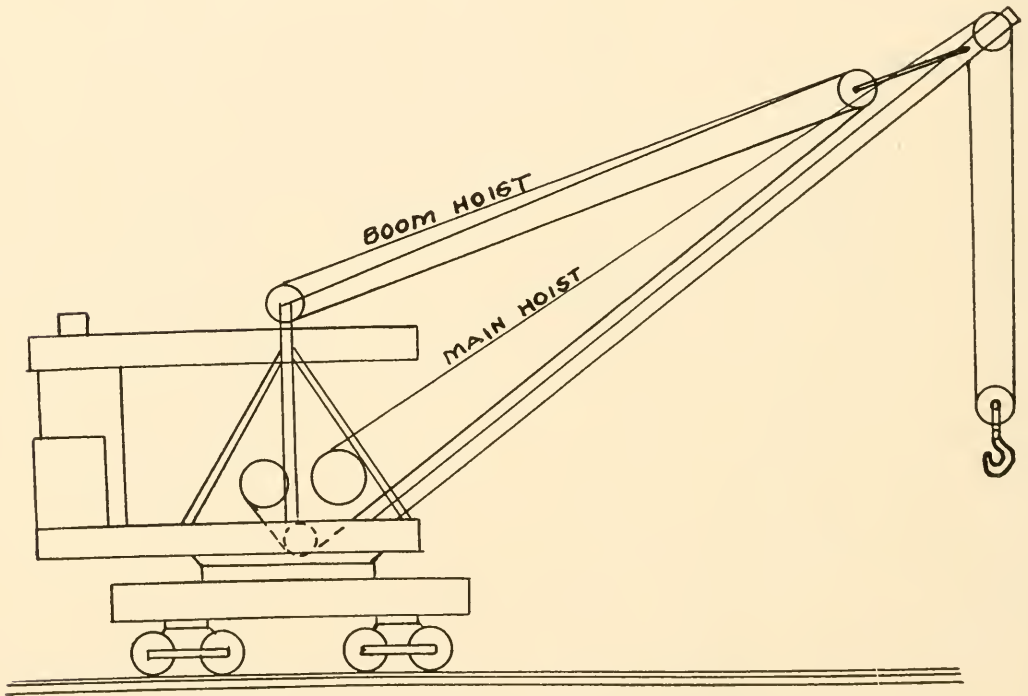

LOCOMOTIVE CRANE

Division 6

American Patent Non-spinning Hoisting Ropes on Back-haul Quarry Derricks

The back-haul derrick derives its name from the fact that the great lifting purchase is obtained by means of multiple back-haul blocks, or tackle, moving up and down the back of the mast. The pulling line from the tackle blocks runs through the derrick step to the hoisting engine. For the large single hoisting line, American Non-spinning Rope is now universally employed, having a socket and hook, or socket and shackle, at one end, the other end being attached by four or five Crosby clips to the lower tackle block on the back of the

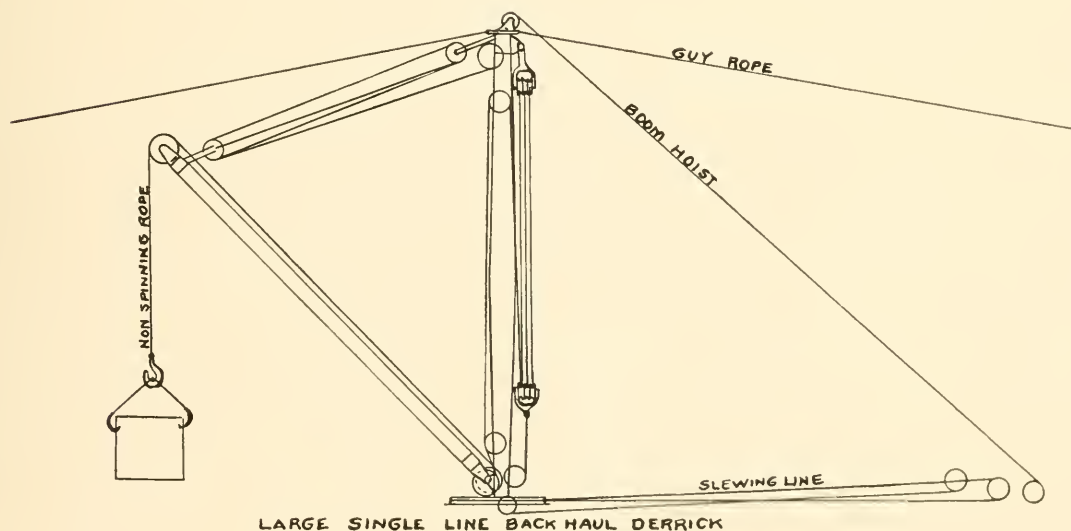

mast. This lower block is made heavy so as to overhaul the slack line when the engine drum is released. From 25 to 50 tons may be lifted with a single line, and by doubling the line through the shaft at the hoisting hook, from 50 to 100 ton loads are handled with a medium size hoisting engine. The boom line runs out at the top of the mast direct to the engine. The bull wheel at the base of the mast is connected with the engine slewing drum by two wire lines which enable the engineer to swing the boom with its load in either direction.

The special feature of this derrick is the single hoisting line which possesses the following advantages: No heavy sheave block is required at the hoisting hook. The socket and hook, or socket and shackle, on the end of the single

line, are easily carried about the quarry in order to reach and drag in blocks beyond the radius of the boom. The boom may be raised or lowered or swung in either direction while hoisting or lowering the load.

In lifting heavy loads with a single line, hoisting rope of the ordinary construction permits the load to revolve. This spinning of the free load suspended by a single line could only be prevented by attaching to the granite blocks a tag line held by one or two men while the blocks are being hoisted and swung into place. By the adoption of American Non-spinning Rope on these single line derricks, heavy loads may be raised into the desired position without the use of a tag line, because the free load does not rotate.

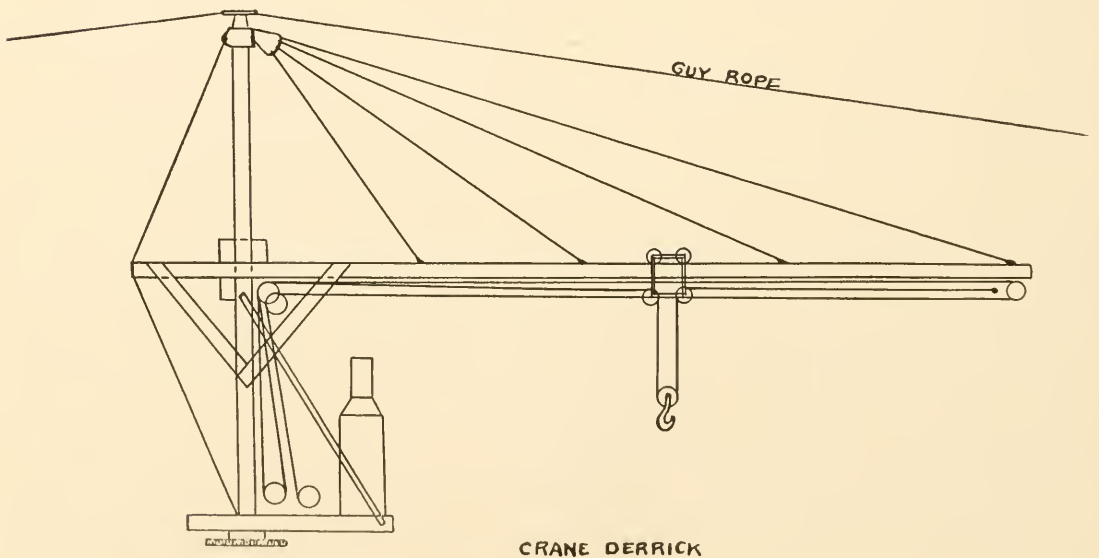
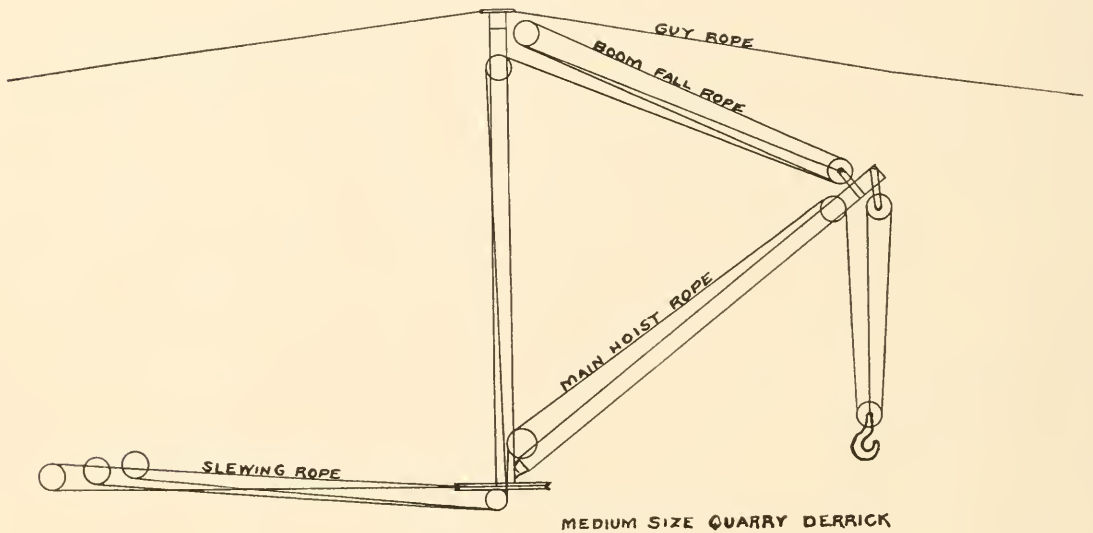

Division 7

Elevators An elevator is a lifting mechanism consisting of a cage or car propelled by suitable power, operated to raise or lower passengers or freight.

The proper operation of these elevators necessitates a medium by means of which the power for raising or lowering the car may be applied. In the early days of elevators, chain was sometimes used, but it was found to be unreliable and so wire rope has taken its place. The reason is of course the liability of breakage due to defective welds in the various links of the chain, which liability increases with the length of chain used, and also the crystallization of the links of the chain from constant strain and bending. A wire rope composed of a large number of wires, each tested individually and then manufactured, possesses the reliability so necessary for transmitting and controlling mechanism of an elevator.

In order to place the matter clearly before the reader we have divided elevators into three classes as follows:

1. Hydraulic
 - a. *Direct plunger type.*
 - b. *Side plunger type.*
 - c. *Horizontal plunger type.*
2. Electrically driven
 - a. *Electric geared elevator.*
 - b. *Electric traction elevator.*
3. Worm geared elevators
 - a. *Electric.*
 - b. *Belt driven.*

a. Hydraulic Elevators of the direct plunger type employ counterweight ropes, valve or hand rope (sometimes called shipper rope), and safety stop ropes.

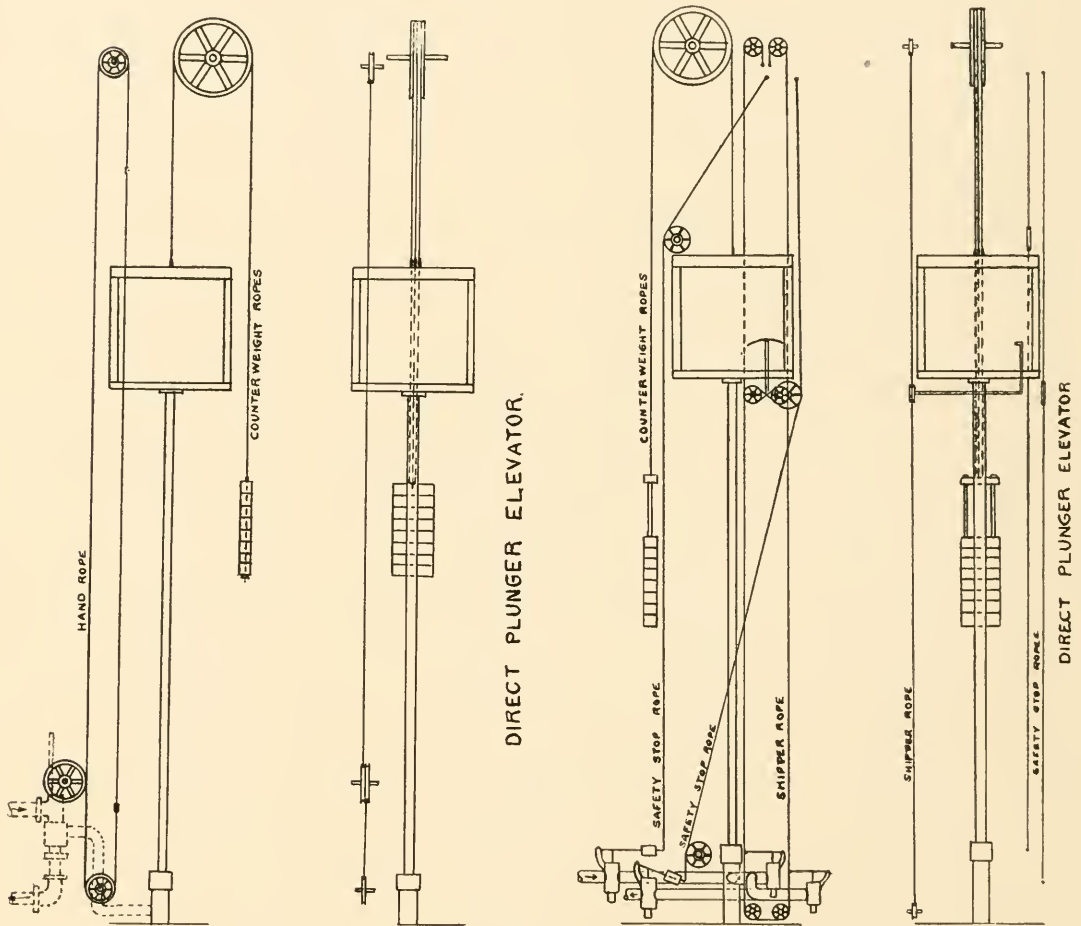

b. Side Plunger Elevators depend upon the plunger for counterweight and usually have a regulating rope to control the speed of the cage in case of accident or excessive speed. The other ropes are the main hoisting ropes and the valve or hand rope.

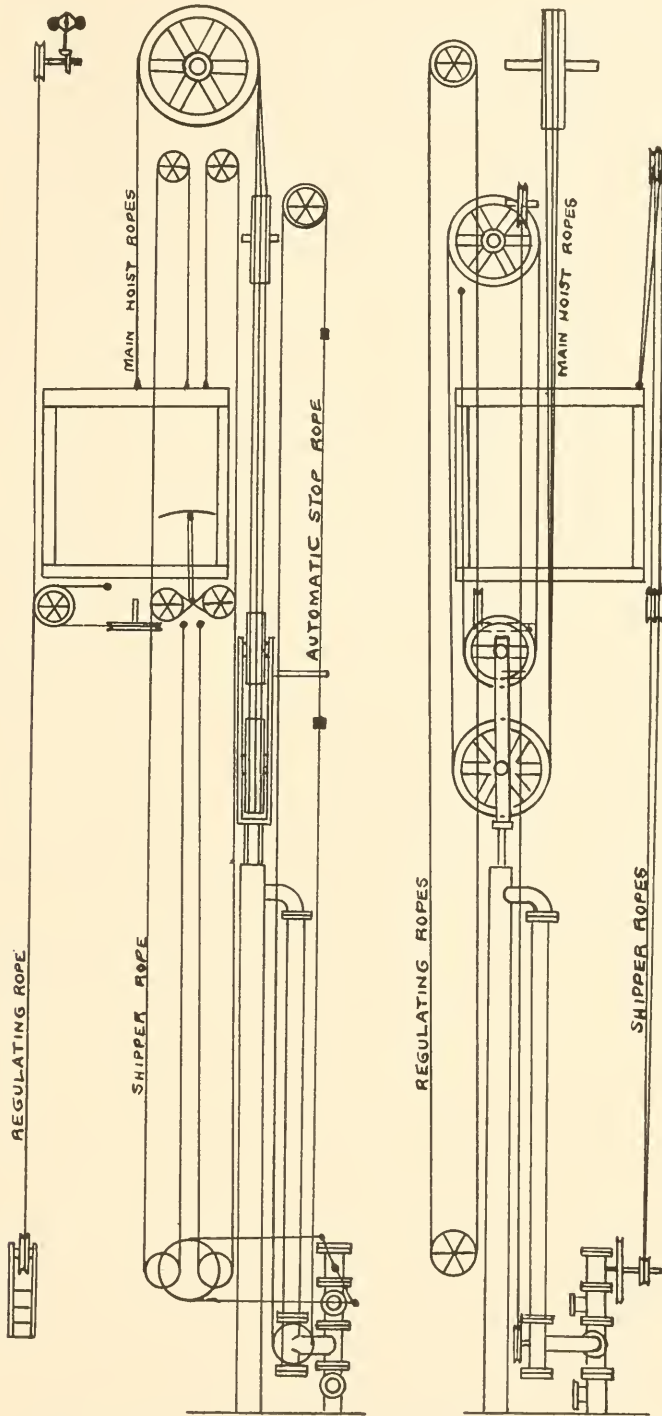

SIDE PLUNGER ELEVATOR

c. Horizontal Plunger Elevators require counterweight ropes, main hoisting ropes, hand or valve ropes and regulating ropes.

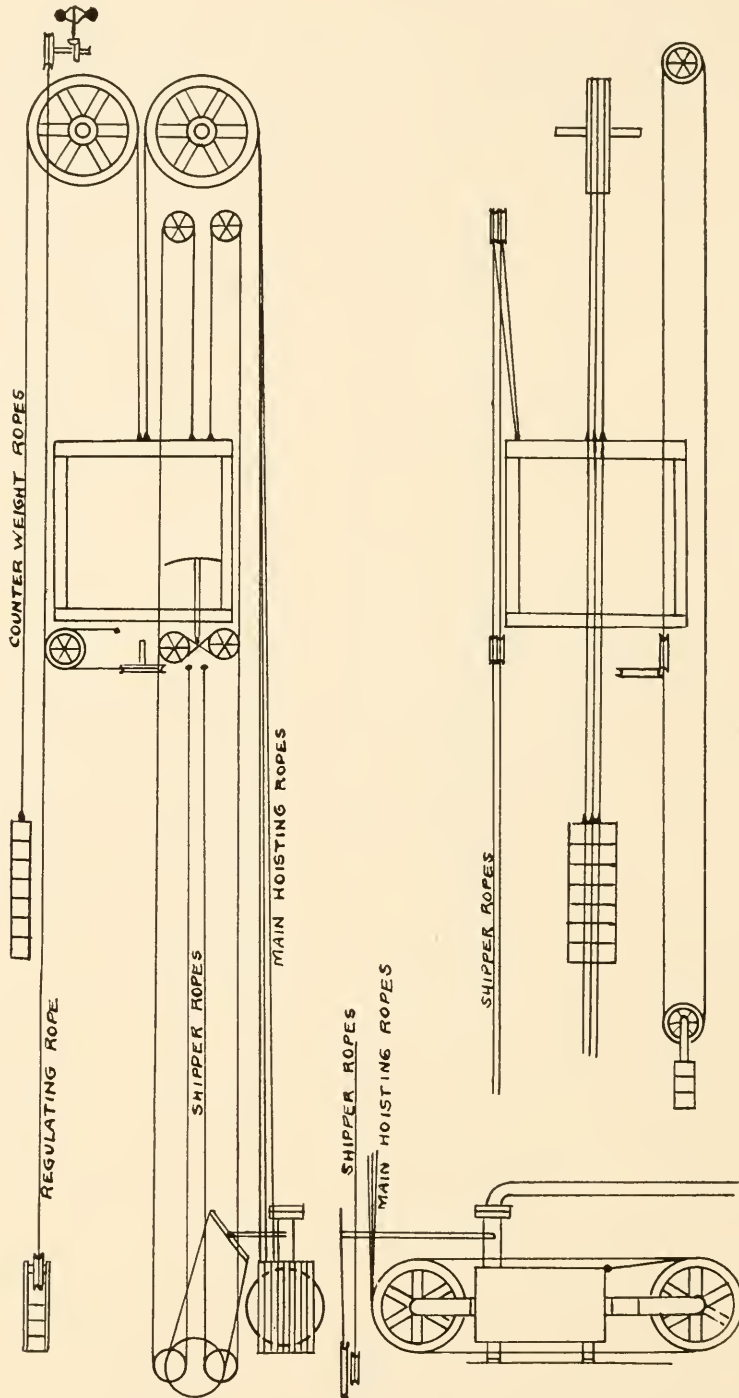

HORIZONTAL PLUNGER ELEVATOR

Valve ropes are largely operated by means of a shifter lever situated in the elevator car, although if the speed is not too great they may be operated by hand.

Direct hydraulic elevators have been successfully used on buildings up to twenty-one stories.

2. Electrically Driven Elevators

a. The electrically geared elevators have various methods of operation, but the two principal ones are to place the elevator drums either in the basement or the attic of a building. With the drum in the attic two sets of ropes are used, the main hoisting ropes and counterweight ropes. Both are attached to the same drum and as one set of ropes wind on the other set wind off.

With drums located in the basement there are three sets of ropes known as main hoisting ropes, car counterweight ropes and drum counterweight ropes.

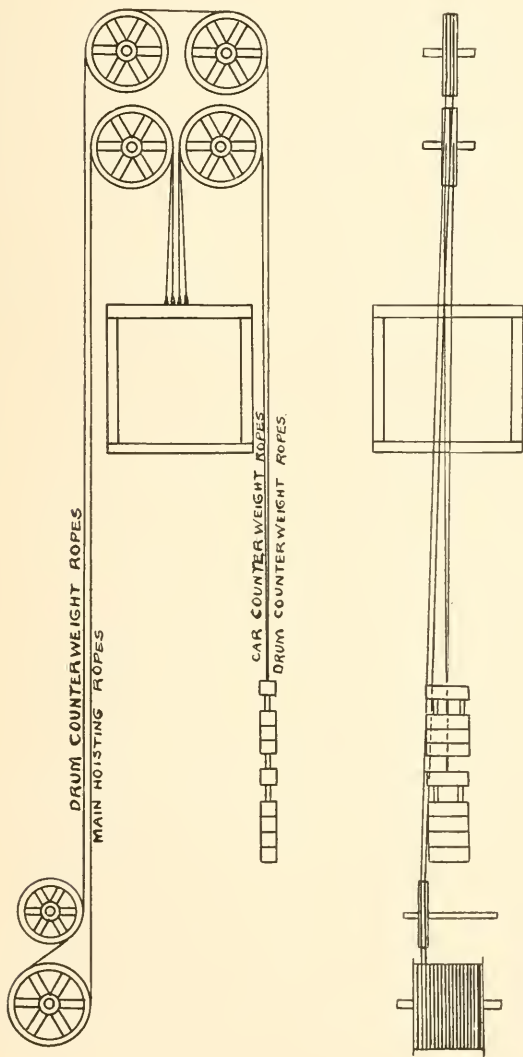

ELECTRIC ELEVATOR

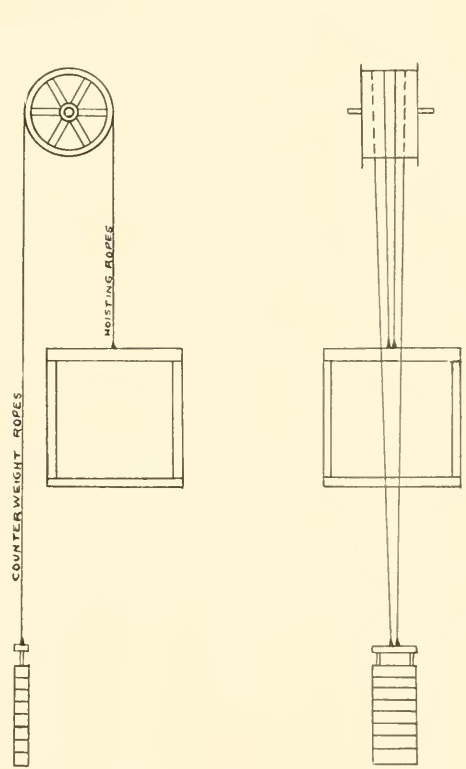

ELECTRIC OR BELT DRIVEN ELEVATOR

3. Worm Geared Elevators These are used principally in factories where power is already available and are belted and worm geared to insure safety and moderate speed. These elevators require main hoisting ropes, car counterweight ropes and hand rope or shifter rope.

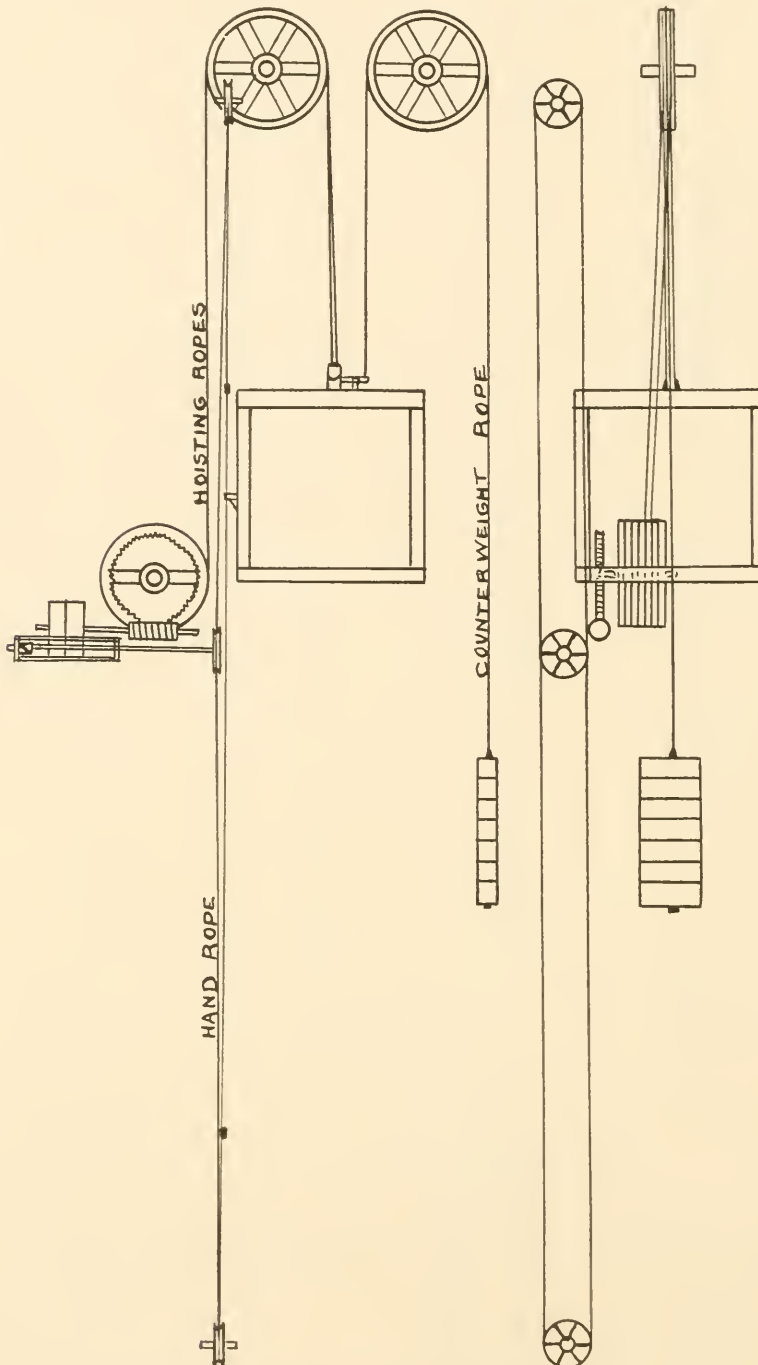

WORM GEARED ELEVATOR

b. Electric Traction Elevators use the same set of ropes for both hoisting and counterweight purposes, there being two drums around which each rope passes from the car to the counterweight. This type of elevator has been used on some very tall buildings.

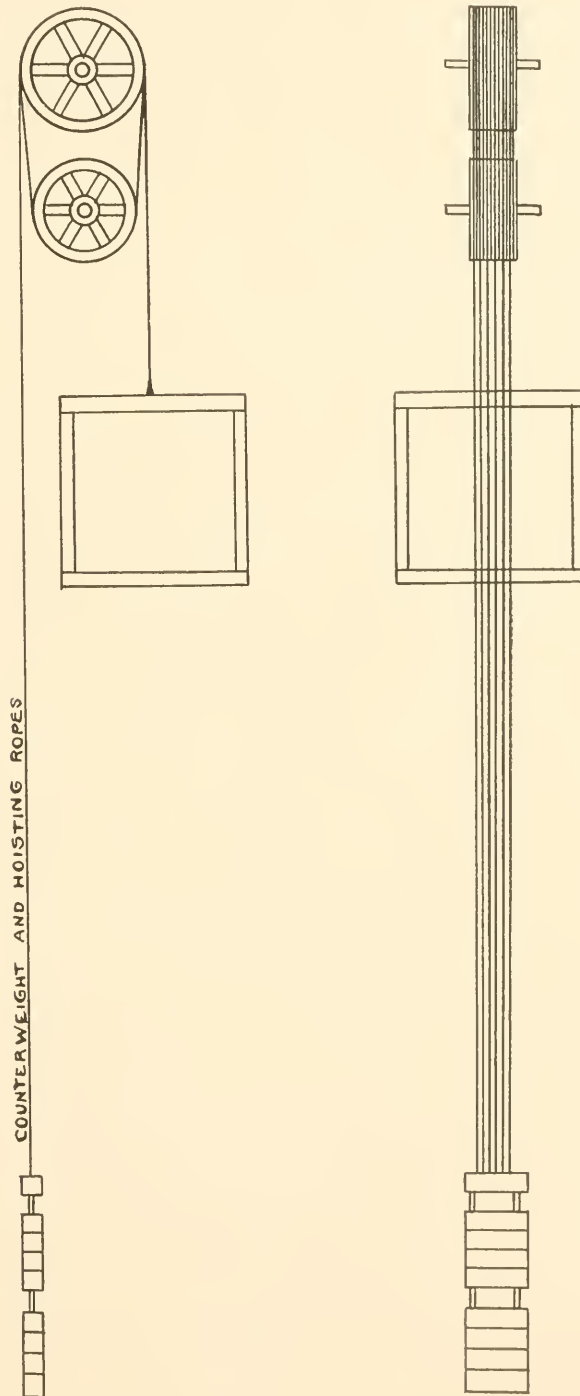

ELECTRIC TRACTION ELEVATOR

Division 8

Excavating Machinery, including Steam Shovels, Dipper
and Suction Dredges

For dry land excavation, for railroad, canal or irrigation work, steam shovels are largely used. A good many of the most modern shovels use rope exclusively for digging in place of chain which was formerly considered indispensable for shovel work. Almost all shovels, however, use wire rope for swinging cables. Some of the principal types are shown diagrammatically below.

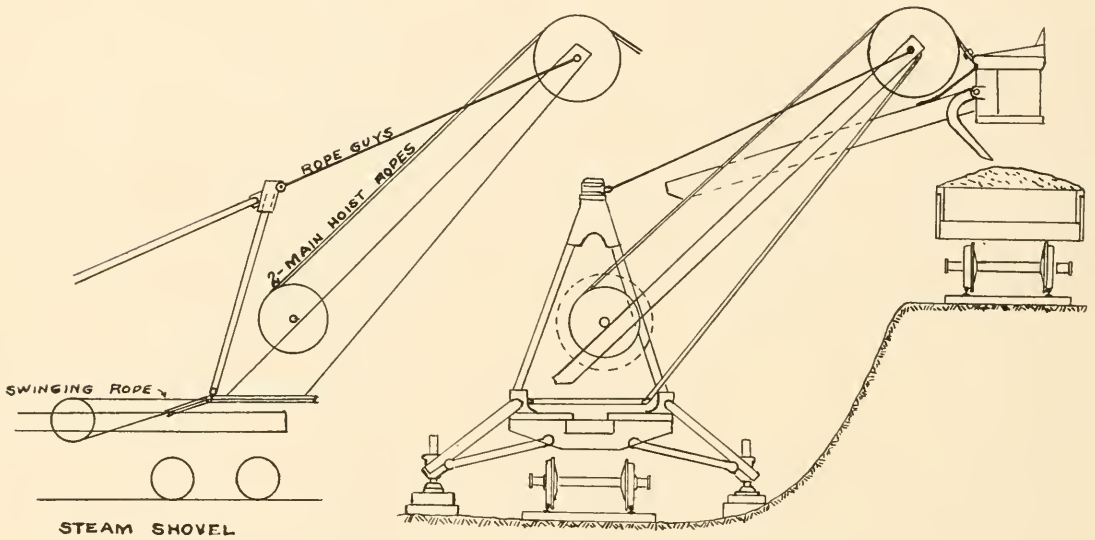

For excavating under water dredging is almost universally resorted to, and either the dipper or the suction type of dredge used. The dipper dredge resembles the steam shovel except that it is a component part of a boat, whereas the steam shovel operates from a railroad car platform. Various sizes of dippers are used, depending upon the size of the dredge boat, three-quarter yard up to twelve yards being the commercial range. The smaller sizes of dredges are mostly used for drainage, ditching and dock construction, while the larger sizes are employed in digging deep channels in lakes and harbors. Ropes used are of three kinds, main hoisting cable, swinging cable and spud cables.

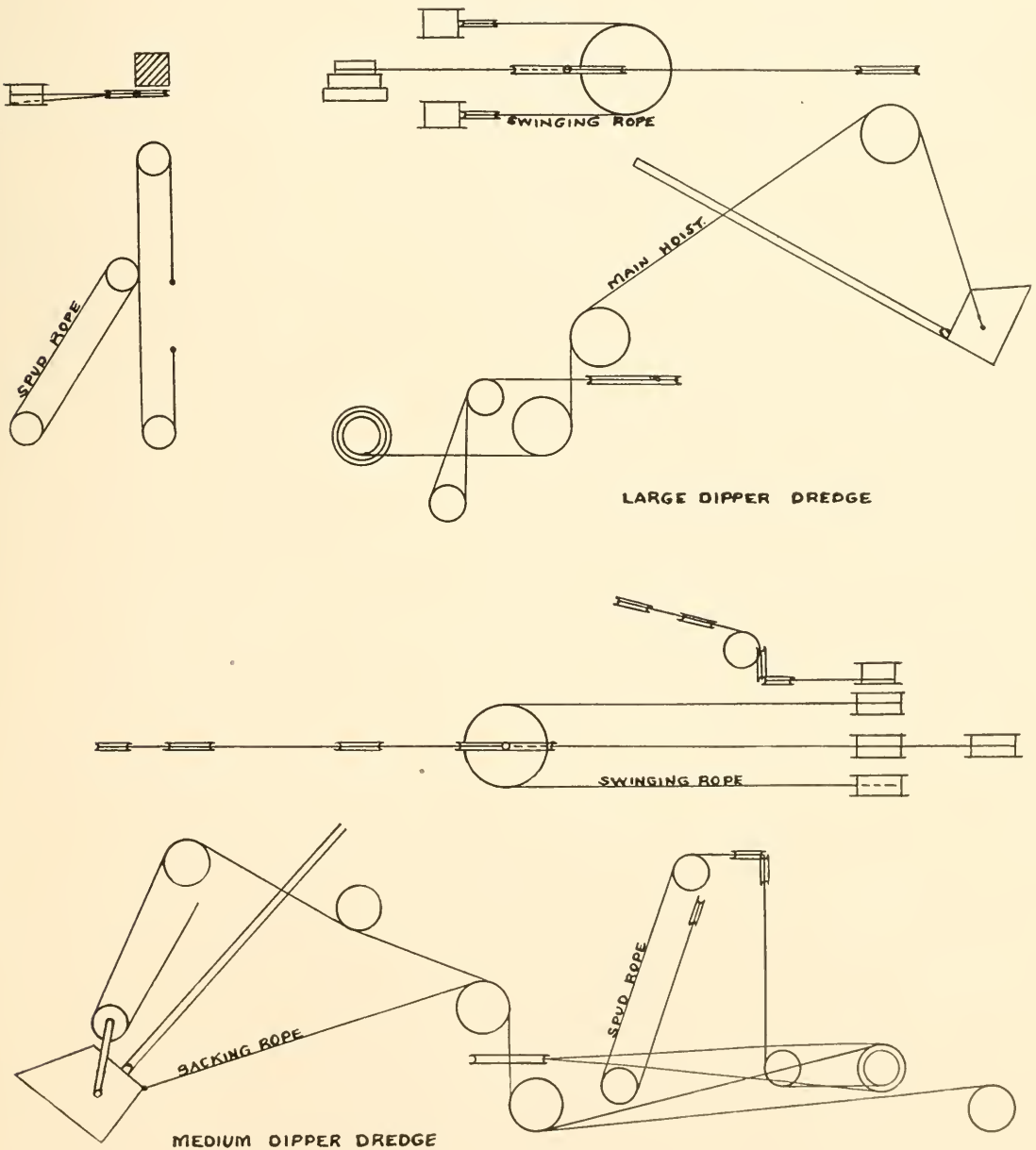

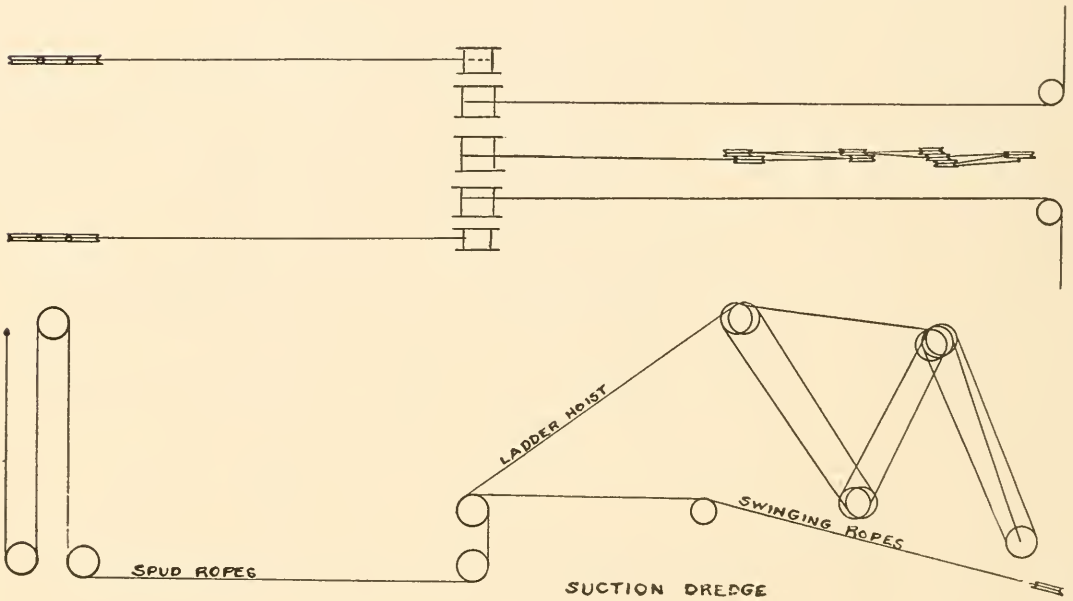
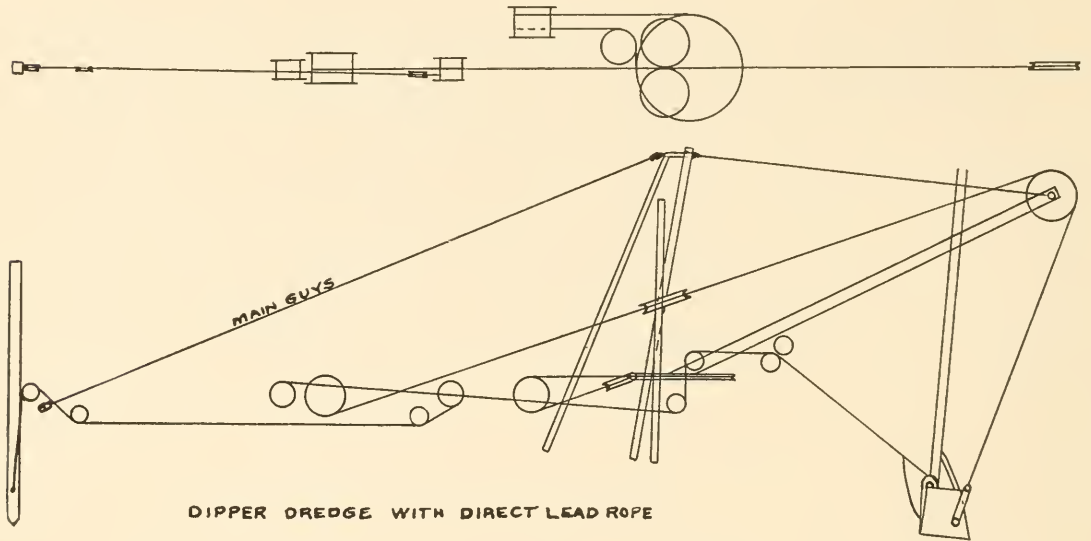

Large dredges use two or three parts of medium sized rope or one part of a very large rope frequently made with a wire center to get additional strength. Small dredges for canal work employ bank spuds, but large dredges employ steel-capped timber spuds.

Suction dredges consist of a rotary cutter and hydraulic suction pump through which the excavated material passes. The rotary cutter is mounted

on a ladder which can be lowered or raised as required by the ladder hoist ropes. One pair of swinging cables attached to anchors and around the ladder sheaves and winding on separate drums swing the dredge back and forth while the spuds keep the cutter from backing off. Suction dredges are employed for digging wide channels and the excavated material is carried on pontoons through a discharge pipe to suitable dumping ground.

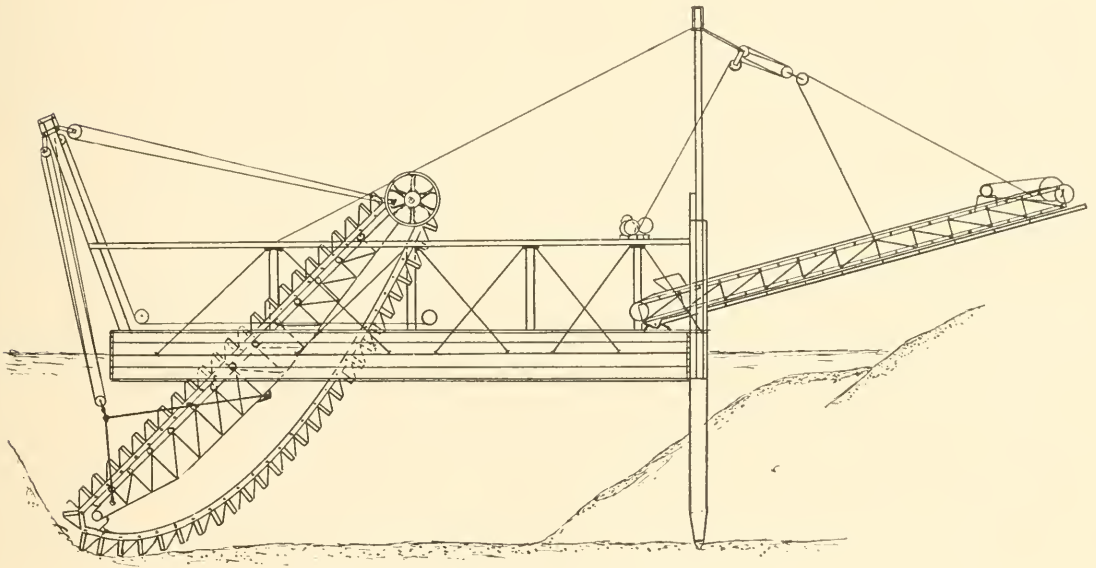

Bucket Ladder Dredge with Conveyor

Division 9

Wire Rope Ferries These are operated by means of an overhead cable and a ferry traveler running upon the same. A tackle block is arranged forward and aft, and the boat is carried across the stream by means of the current, the boat being reversed or carried at an angle to the current, which acts as the propelling medium in a manner similar to that shown in the sketch below.

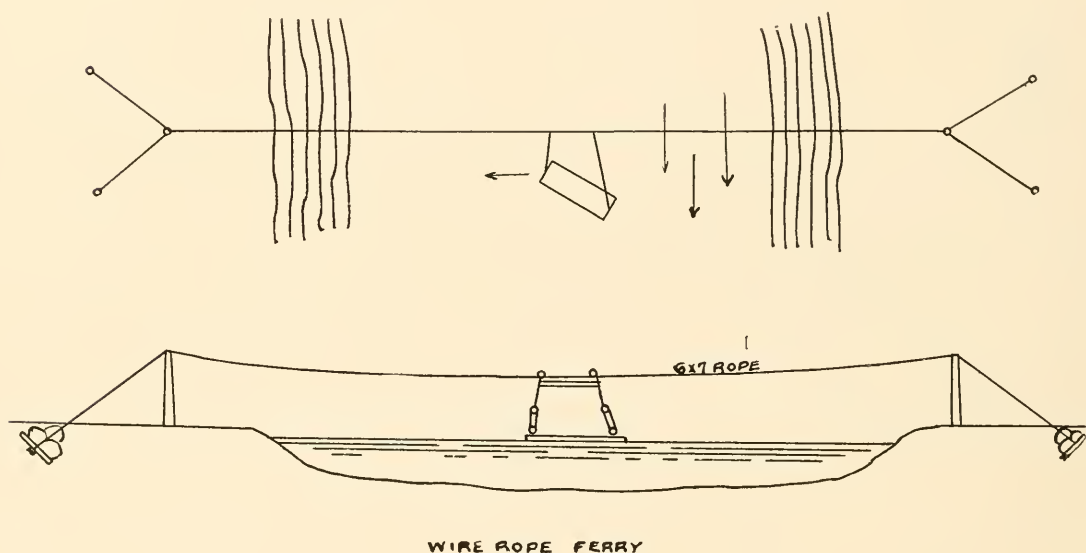

Division 10

Guying for Derricks, Ships Rigging, Stacks, Etc.

Galvanized ropes are employed almost exclusively for this class of work on account of their durability. The stresses on guy ropes at various angles are fully described in Chapter V, Section 8, pages 60 to 63. Wherever possible guy ropes should be equally spaced all around the derrick, smokestack or mast which it is desired to guy because in most cases the strain on the guys due to the load will come at some time with equal effect on all the guy ropes. In quarries the derrick guy ropes are sometimes passed around trees and fastened with Crosby clips, or an eye bolt is made fast to a part of the rock in the quarry and the guy rope made fast by means of Crosby clips and thimble or a shackle.

Where derricks have to be moved occasionally, or guys moved for any reason, the guy ropes may be made up in sections with thimbles spliced in each end of each piece. These are generally 50 or 100-foot lengths, so that they can be lengthened or shortened at will. Such a fastening is illustrated below.

When it is necessary to guy very securely, double guys are used, e. g., instead of twelve separate guys, six pairs may be used with fairly good results.

In order to take up slack in guy ropes, galvanized iron turnbuckles such as shown on pages 220 and 221 are used. Separate turnbuckles are required on each of the guys requiring to be tightened.



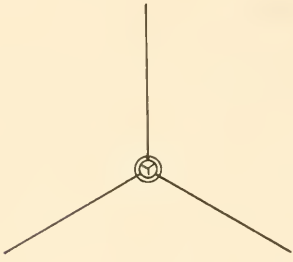

3 GUYS

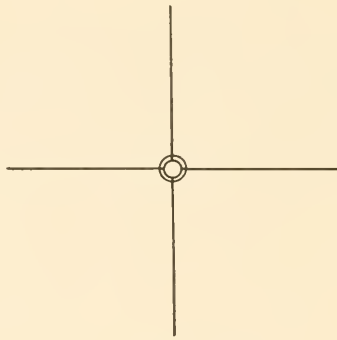

4 GUYS

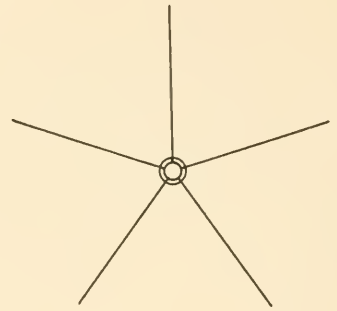

5 GUYS

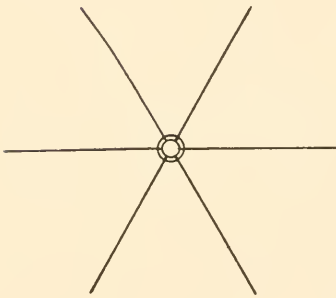

6 GUYS

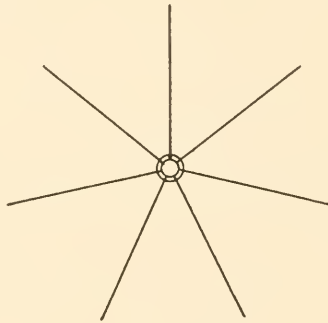

7 GUYS

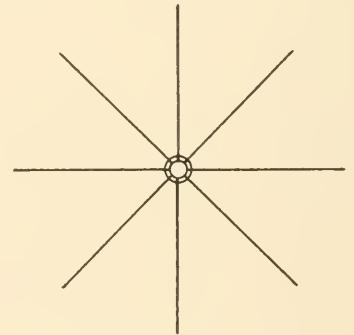

8 GUYS

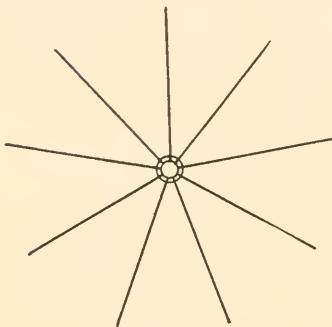

9 GUYS

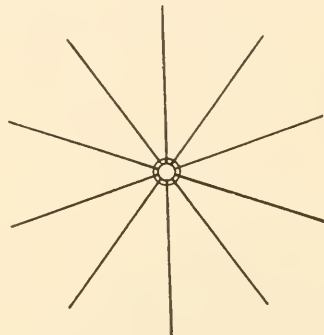

10 GUYS

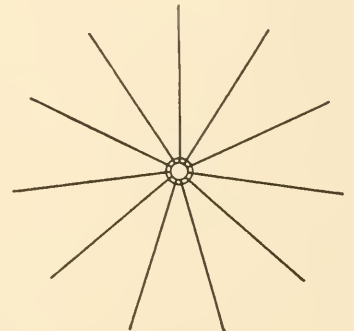

11 GUYS

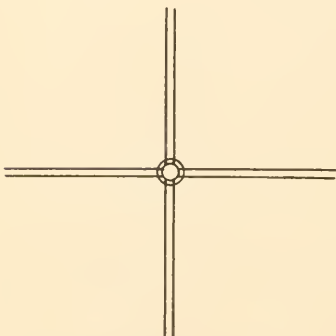

4 PAIR GUYS

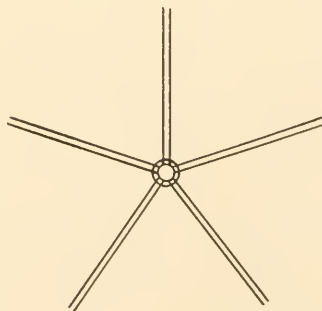

5 PAIR GUYS

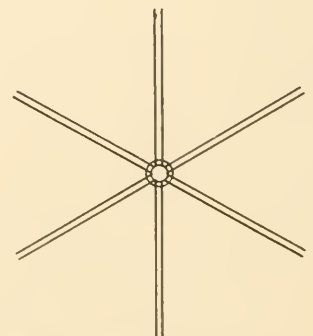

6 PAIR GUYS

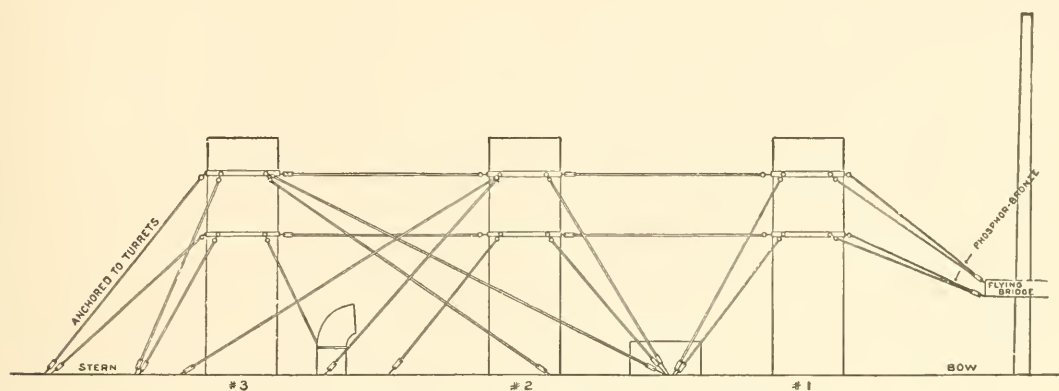

Plan of Smokestack Guys of U. S. Battleship Connecticut
All guys of galvanized iron, 6 strands, 7 wires each, 2 1/2 inches circumference, 15,000 pounds strength

Guys on Battleship Connecticut

The stacks of the Connecticut are guyed with galvanized iron guy rope composed of six strands of seven wires each about a hemp center, having a strength of nine tons. On the top of the stacks and at the midway anchorages they are fastened to the stacks by means of heavy galvanized shackles, and upon the deck, turret and flying bridge anchorages, they are fastened by means of turnbuckles. The guys running between the stacks are similarly anchored, turnbuckles being inserted on the bowsides of the second and third stacks. The guy ropes attached to the flying bridge are made of phosphor bronze, because the use of steel or iron rope would affect the magnetic instruments in the chart room just below them. The turnbuckles attaching them to the flying bridge are also made of phosphor bronze.

The tables, page 101, show how largely wire rope has displaced manila rope for yacht rigging. The advantages possessed by an American galvanized plow steel wire rope over manila rope may be given briefly as follows :

It does not shrink nor stretch as does all manila rope.

Has seven times the strength of the same size of manila rope.

Is one-third the diameter of manila rope of the same strength.

Is 50 per cent lighter than manila rope of the same strength.

Being made of heavily galvanized wires, it does not rust nor rot, but is good for many years of hard service.

Guys on Sailing Yacht

**Specifications of the Wire Rope and Manila Rope
Employed in the Equipment of the
Yacht "Taormina"**

Designed and Built by Geo. Lawley & Son, Boston

American Wire Rope Used

The Sails

- | | | |
|------------------|----------------------|--------------------------|
| A. Mainsail | D. Jib | G. Foregaff-topsail |
| B. Foresail | E. Jib topsail | H. Main gaff-topsail |
| C. Fore-staysail | F. Small jib topsail | I. Main topmast-staysail |

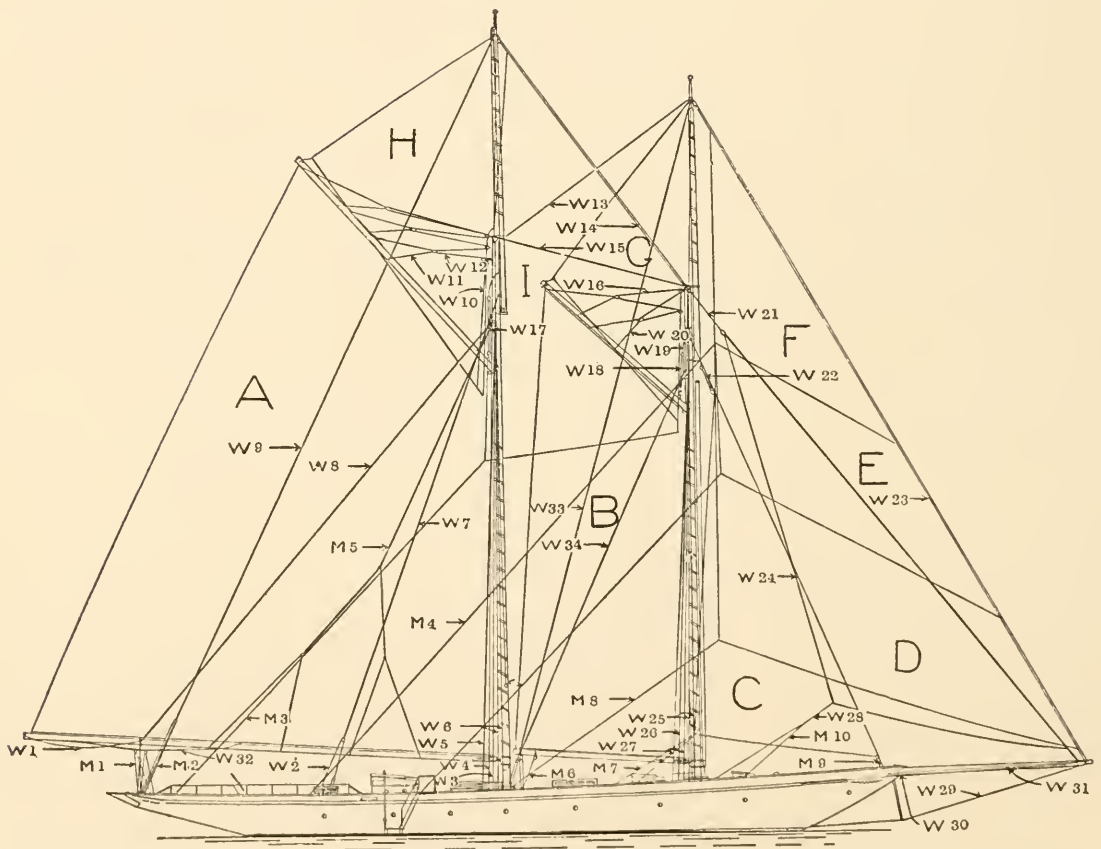

Sail and Rigging Plan of Yacht

The Crucible Wire Rope Rigging

Galvanized Plow Steel Hoisting Rope, six strands, nineteen wires each, one hemp center.

Flexible for running through blocks.

	Circumference in Inches	Diameter in Inches		Circumference in Inches	Diameter in Inches
W 1	1 $\frac{1}{8}$	$\frac{3}{8}$	W 18	1 $\frac{1}{4}$	$\frac{7}{16}$
W 2	1 $\frac{1}{2}$	$\frac{1}{2}$	W 20	1 $\frac{1}{4}$	$\frac{7}{16}$
W 8	1 $\frac{1}{2}$	$\frac{1}{2}$	W 21	1 $\frac{1}{4}$	$\frac{7}{16}$
W 11	1 $\frac{3}{8}$	$\frac{15}{32}$	W 22	1 $\frac{1}{4}$	$\frac{7}{16}$
W 12	1 $\frac{1}{4}$	$\frac{7}{16}$	W 28	1 $\frac{1}{2}$	$\frac{1}{2}$
W 16	1 $\frac{1}{4}$	$\frac{7}{16}$	W 32	1 $\frac{1}{2}$	$\frac{1}{2}$
W 17	1 $\frac{1}{4}$	$\frac{7}{16}$			

Galvanized Plow Steel Standing Rope, six strands, seven wires each, one hemp center.

For standing shrouds or straight hauls only. Not for running through blocks.

	Circumference in Inches	Diameter in Inches		Circumference in Inches	Diameter in Inches
W 3	2	$\frac{5}{8}$	W 19	1 $\frac{3}{4}$	$\frac{9}{16}$
W 4	1 $\frac{1}{2}$	$\frac{1}{2}$	W 23	1 $\frac{1}{2}$	$\frac{1}{2}$
W 5	2	$\frac{5}{8}$	W 24	2 $\frac{1}{4}$	$\frac{3}{4}$
W 6	1 $\frac{3}{4}$	$\frac{9}{16}$	W 25	1 $\frac{3}{4}$	$\frac{9}{16}$
W 7	1 $\frac{3}{4}$	$\frac{9}{16}$	W 26	1 $\frac{1}{2}$	$\frac{1}{2}$
W 9	1 $\frac{1}{4}$	$\frac{7}{16}$	W 27	2	$\frac{5}{8}$
W 10	2	$\frac{5}{8}$	W 29	3	1
W 13	1 $\frac{1}{2}$	$\frac{1}{2}$	W 30	1 $\frac{1}{4}$	$\frac{7}{16}$
W 14	1 $\frac{1}{2}$	$\frac{1}{2}$	W 31	1 $\frac{3}{4}$	$\frac{9}{16}$
W 15	1 $\frac{3}{4}$	$\frac{9}{16}$			

The Manila Rope Rigging

Four strands, long fibre.

	Circumference in Inches	Diameter in Inches		Circumference in Inches	Diameter in Inches
M 1	2 $\frac{1}{2}$	$\frac{13}{16}$	M 6	2 $\frac{1}{4}$	$\frac{3}{4}$
M 2	1 $\frac{3}{4}$	$\frac{9}{16}$	M 7	2 $\frac{1}{4}$	$\frac{3}{4}$
M 3	1 $\frac{3}{4}$	$\frac{9}{16}$	M 8	1 $\frac{3}{4}$	$\frac{9}{16}$
M 4	1 $\frac{3}{4}$	$\frac{9}{16}$	M 9	1 $\frac{3}{4}$	$\frac{9}{16}$
M 5	1 $\frac{1}{4}$	$\frac{7}{16}$	M 10	2 $\frac{1}{4}$	$\frac{3}{4}$

The use of manila rope is confined to the sheets and lower purchases on halyards and backstays. The topmast backstay W 9, is of wire with a manila purchase near the deck for greater convenience in handling and fastening to the deck cleats. The upper parts of halyards are of wire, but the lengths leading on to the deck are of manila.

Division 11

Loading and Unloading Machinery

For the handling of bulk materials such as iron ore, coal, etc., from vessels to cars, there have been designed in recent years very efficient hoists employing some kind of clam shell bucket. For unloading iron ore from vessels we have ore conveyors or ore bridges, and for unloading coal, the coal tower. The various ore handling machines are usually named from their makers, and Brown hoists, Hewlett machines, fast hoists, etc., are familiar names to many rope users. The diagrams shown below illustrate some of the types in common use.

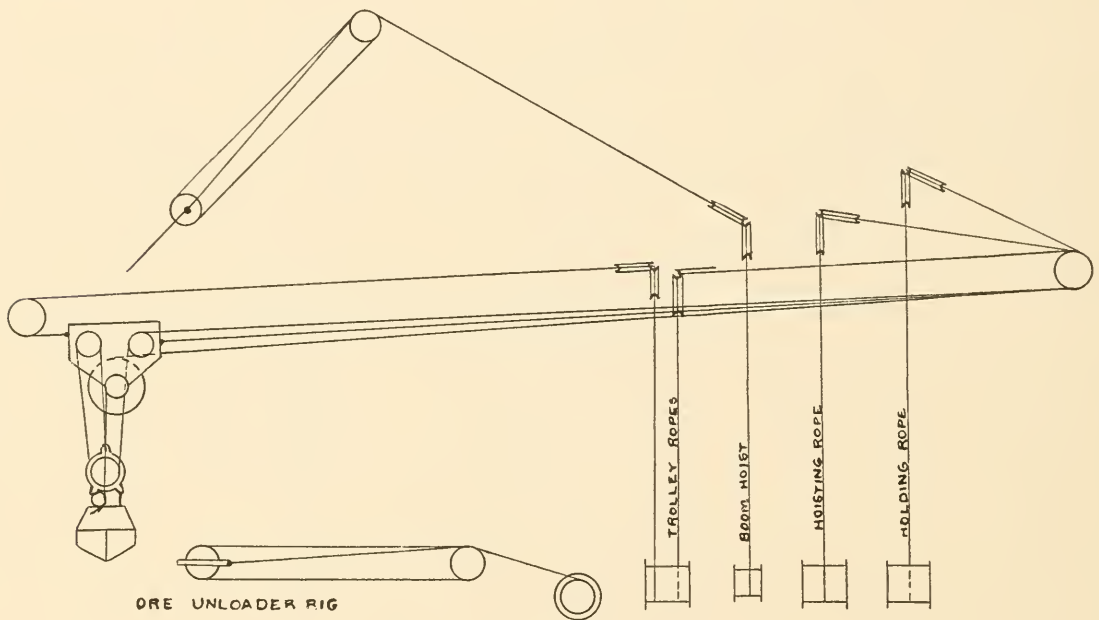

ORE UNLOADER RIG

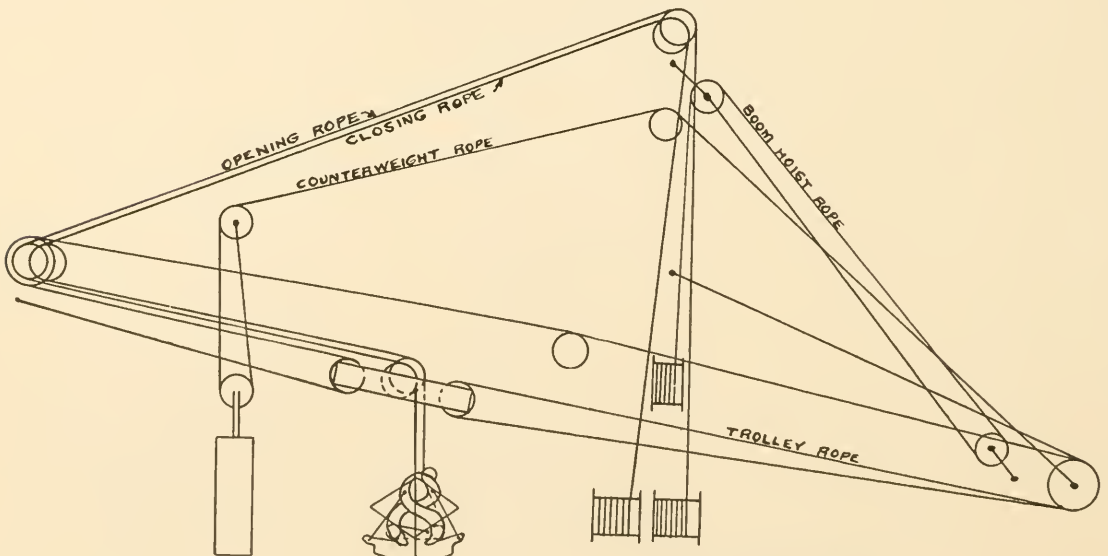

ORE UNLOADER RIG

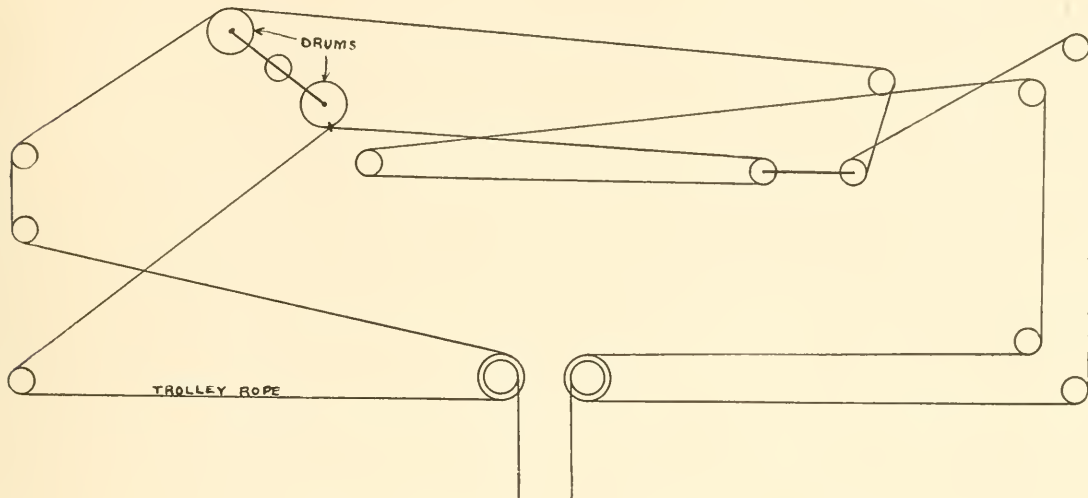

CRE UNLOADER RIG

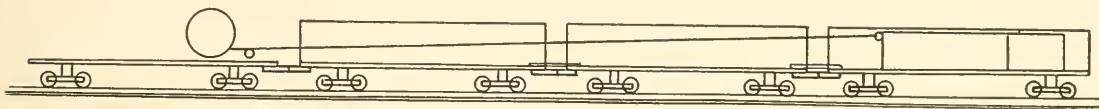

BALLAST UNLOADER AND TRAIN.

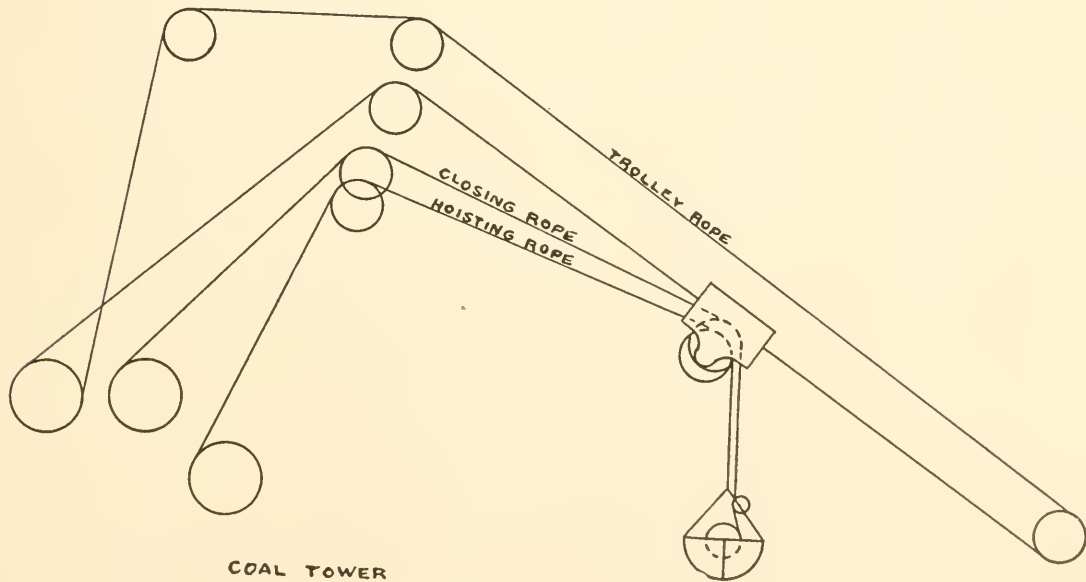

COAL TOWER

Division 12

Lumbering, including Skidding and Loading

The great lumbering industry depends for its successful operation to a marked degree on getting the logs to the mill with the least possible expense. To facilitate this, there have been devised skidding machines of different kinds, loaders and pull boats.

Where the ground is swampy, overhead cableway skidders are largely used, but where the ground is firm a portable skidding machine with one or two booms is usually employed for medium sized timber. For very large timber, however, it is customary to mount a large engine, boiler and geared drum on a heavy log platform and pull the logs in by main force. The type of machinery is thus adapted to the character of the work, and it is also true that the kinds of wire rope employed for these several uses have been designed to meet as far as possible the character of the machinery and the kind of work to be performed. In no other industrial work is wire rope worked under such constantly heavy loads, and it is not surprising that under such conditions that sometimes a strand breaks or the rope parts. Logs frequently foul with roots, stumps and other logs, and much skill is required of operators of skidding machines to get out the logs promptly without unduly overstraining the rope. Where timber is located along a navigable stream, pull boats are frequently used which pull logs for several miles out of the woods.

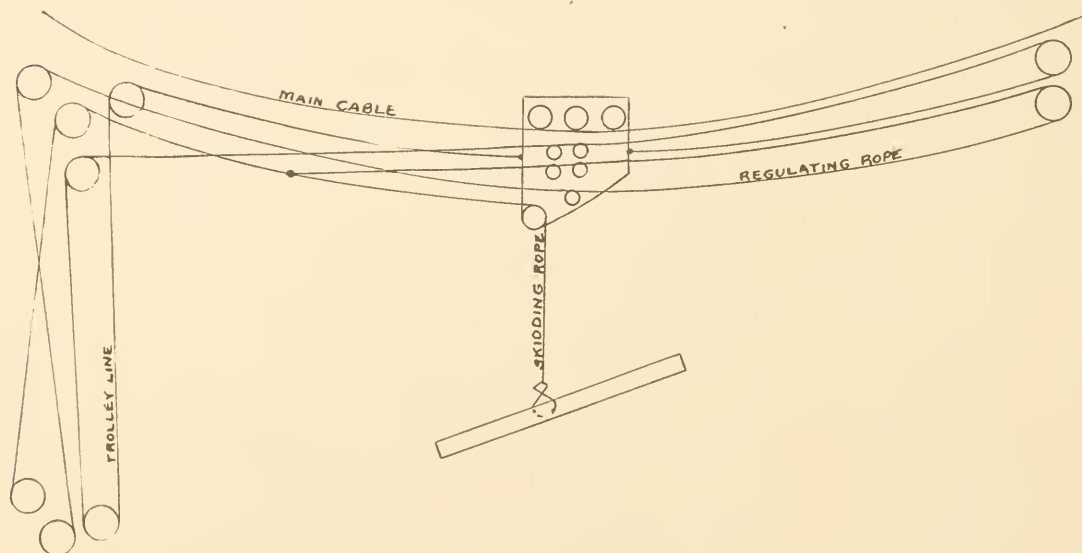

OVERHEAD LOG SKIDDER

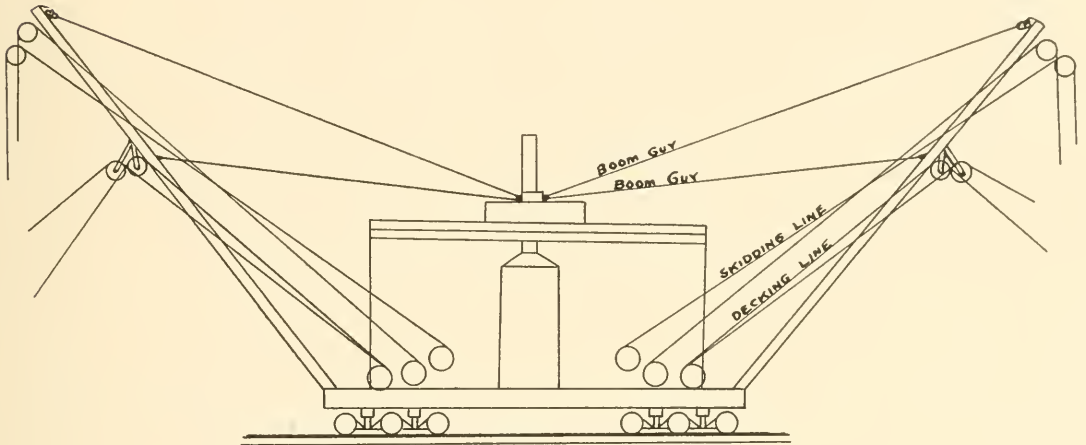

4 LINE SKIDDER WITH DECKING LINES

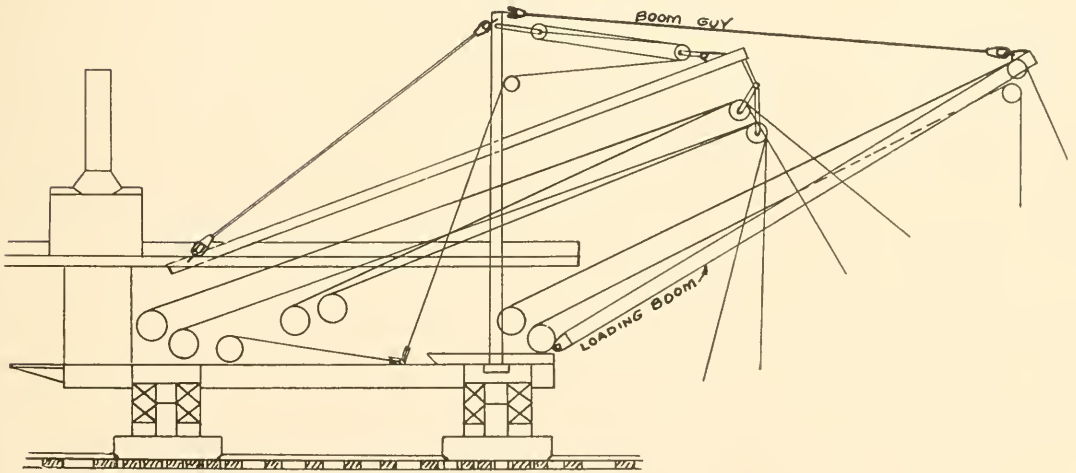

COMBINED SKIDDER AND LOADER

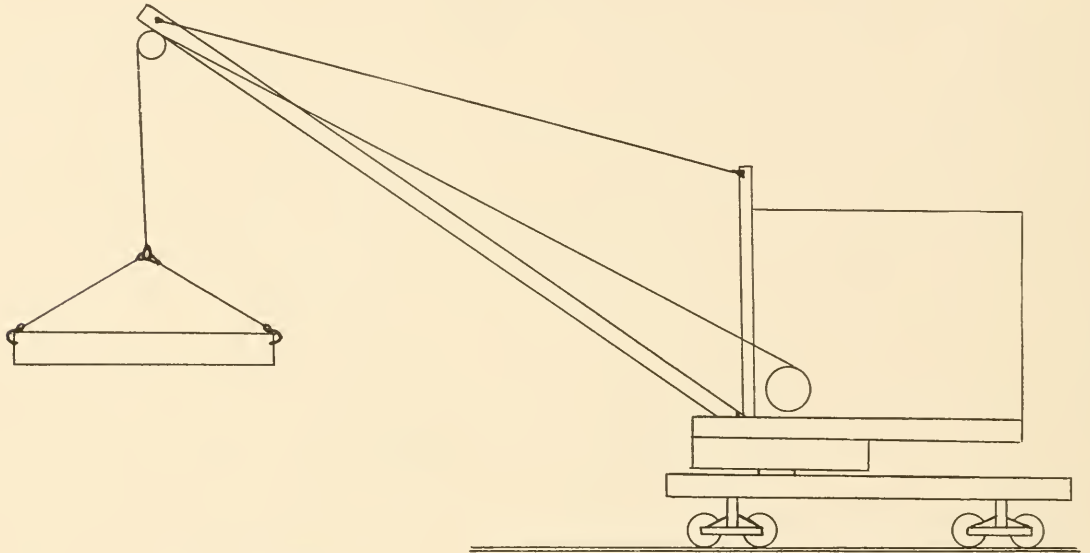

LOG LOADER

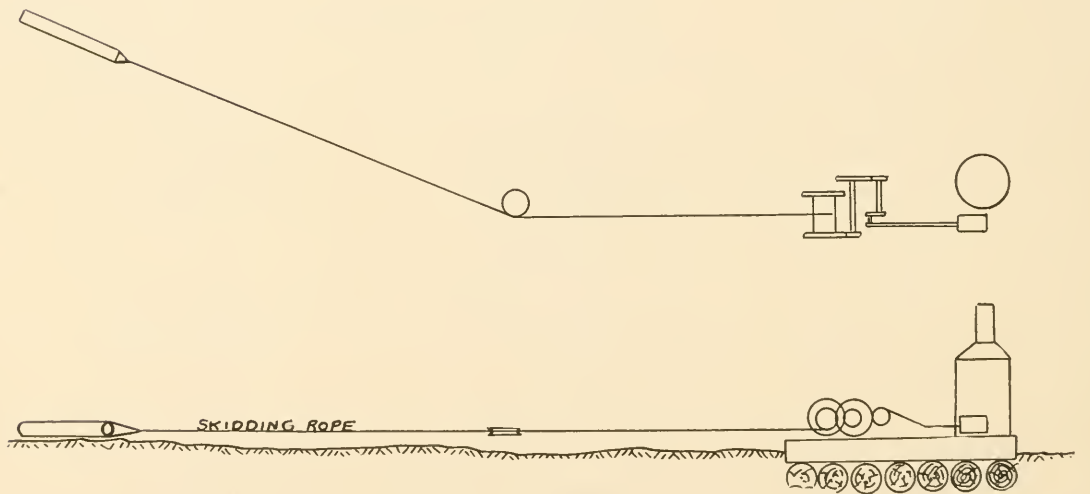

HEAVY GROUND SKIDDER AND YARDER

Division 13

Mining Rope Arrangements For vertical shaft work it is customary to use almost universally the 6x19 construction rope of one of the grades shown on pages 129-131 of this handbook. The cages are usually arranged in pairs so that as one is lowered the other is raised, this being known as the balanced hoist system. Two types of hoisting drums are in common use, the flat drum and the conical drum, the latter being designed to give a slower starting speed when the cage is lifted from the bottom of the mine.

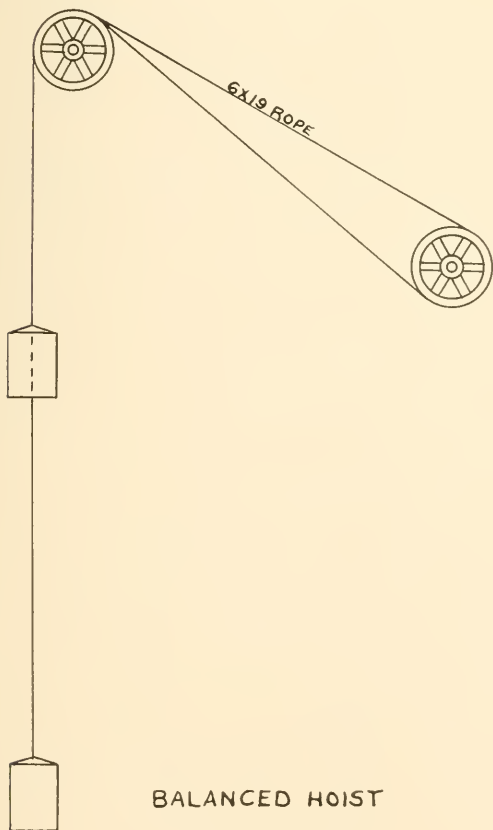
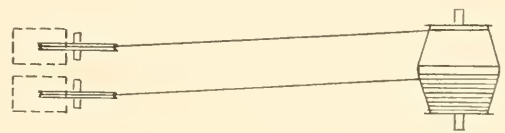
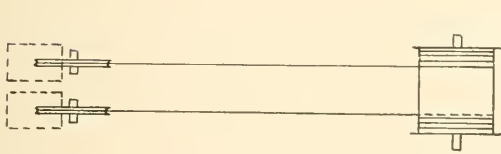

BALANCED HOIST
FLAT DRUMS

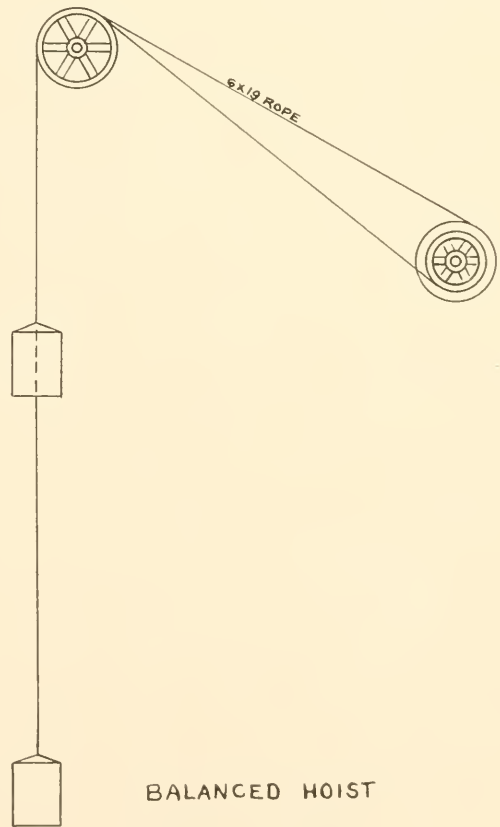

BALANCED HOIST
CONICAL DRUMS

The simplest arrangement is for the ropes to pass directly from the drum to two head sheaves carried on a wooden or steel tower, each sheave lined with the center of that part of the drum on which the rope has to wind. It is customary with either the flat or conical drum to attach one rope to the under side of the drum and the other rope to the top of the drum, leaving several turns on the drum when the cage is resting on the bottom of the mine shaft. The names "underwind" and "overwind" are applied to these two ropes.

Conical drums are used more frequently on shorter mine ropes, but unless the smaller end has nearly as large a diameter as would be used for a flat drum, the rope service may not be much better than with a flat drum. It is a debatable point as to which type of drum is the better.

We recommend wherever possible that installations of mine hoist ropes be made with as few bends as possible in a similar manner to the two preceding diagrams. In case a shaft has to be changed or if the engine room cannot be located, so as to carry the rope in the manner indicated, a turn sheave may be used with suitable lead and intermediate supporting sheaves to carry the rope.

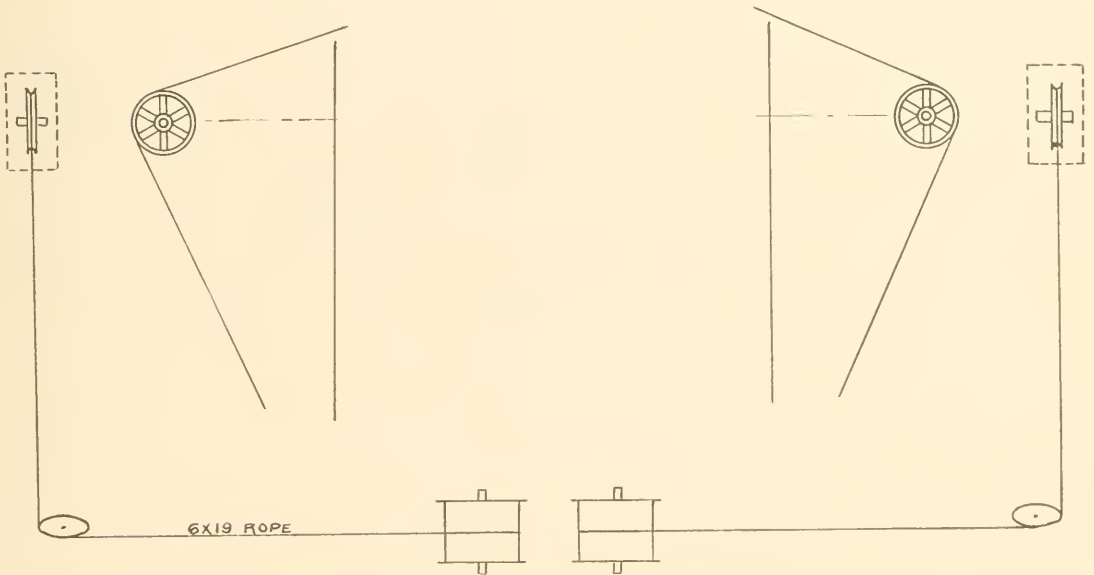
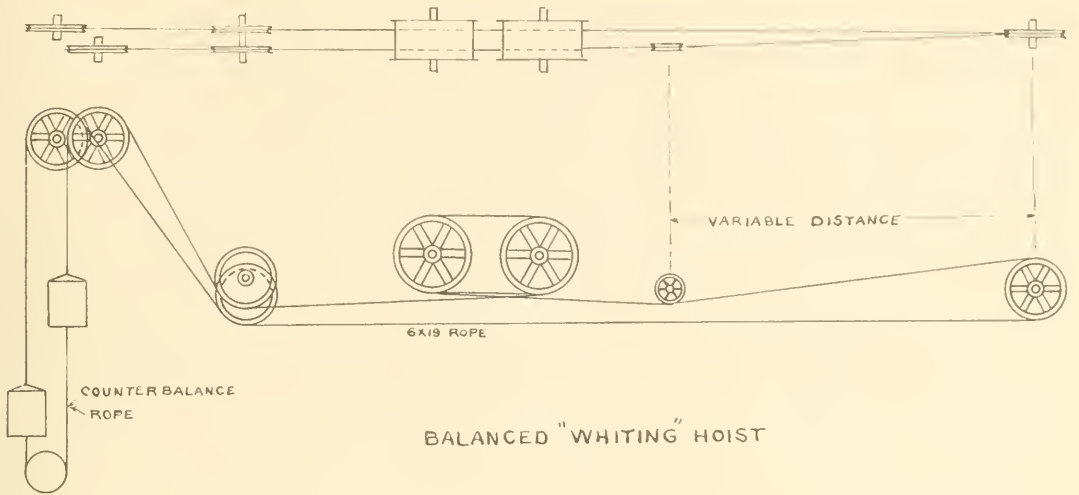

Mine haulage systems are very widely different one from another, so much so that it may almost be said that there are hardly any two alike. At the same time there are in common use three leading systems known respectively as

1. *Endless Haulage Rope System.*
2. *Tail Rope System.*
3. *Gravity Inclined Plane.*

1. The endless system consists of a wire rope usually 6x7 construction, spliced endless with small cars gripped on to the rope at regular intervals either singly or in groups of two or three. Two kinds of drum driving arrangements are usually employed known as the elliptical and the figure 8 style respectively. The elliptical arrangement is preferable to the figure 8 as the rope in the latter case is subjected to reverse bending on the drums. Suitable slip rings should always be used on drums to equalize the tension of the different winds of rope, and a tension carriage with counterweight is also necessary. Position of engine and driving drums is usually dependent upon the location of pit mouth. Slow speed of about 3 to 4 miles per hour is the average of this system.

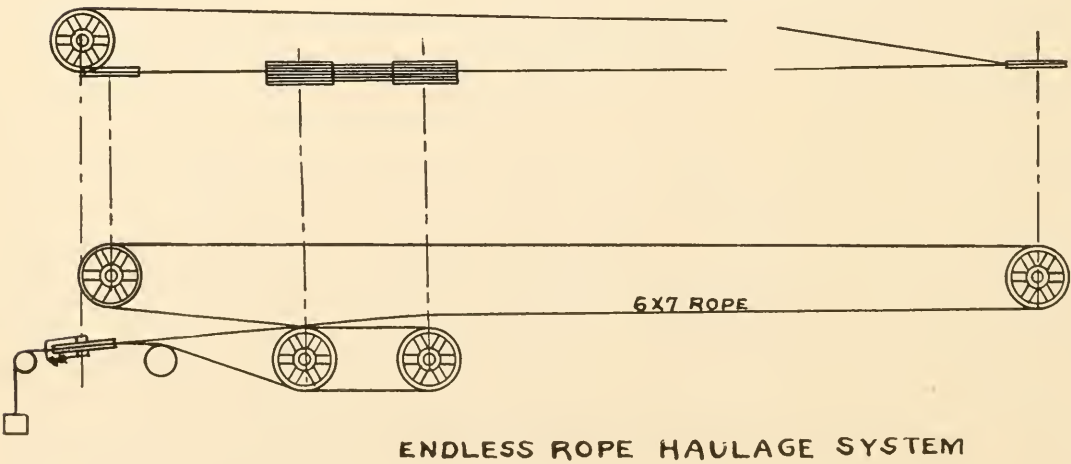
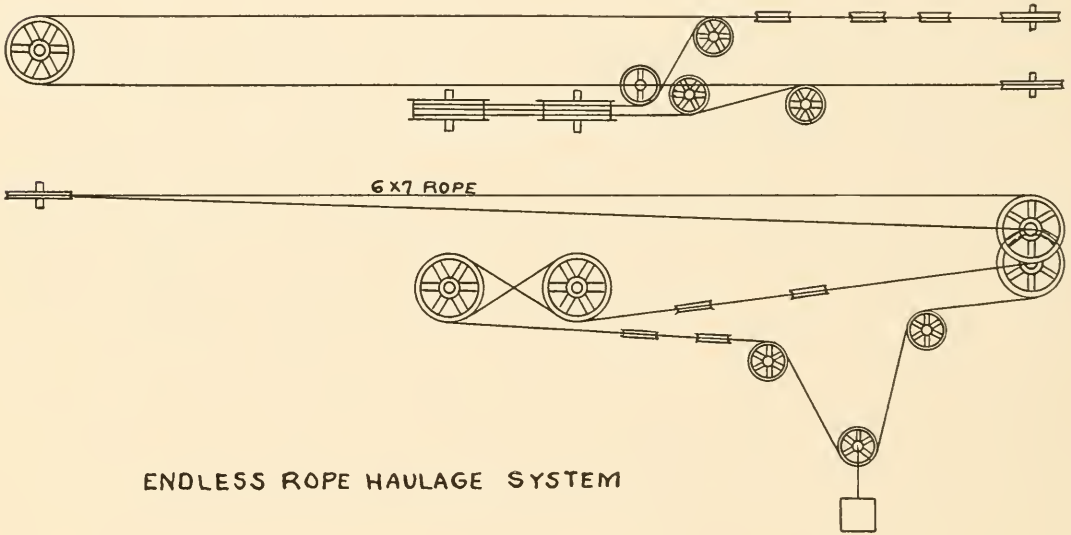

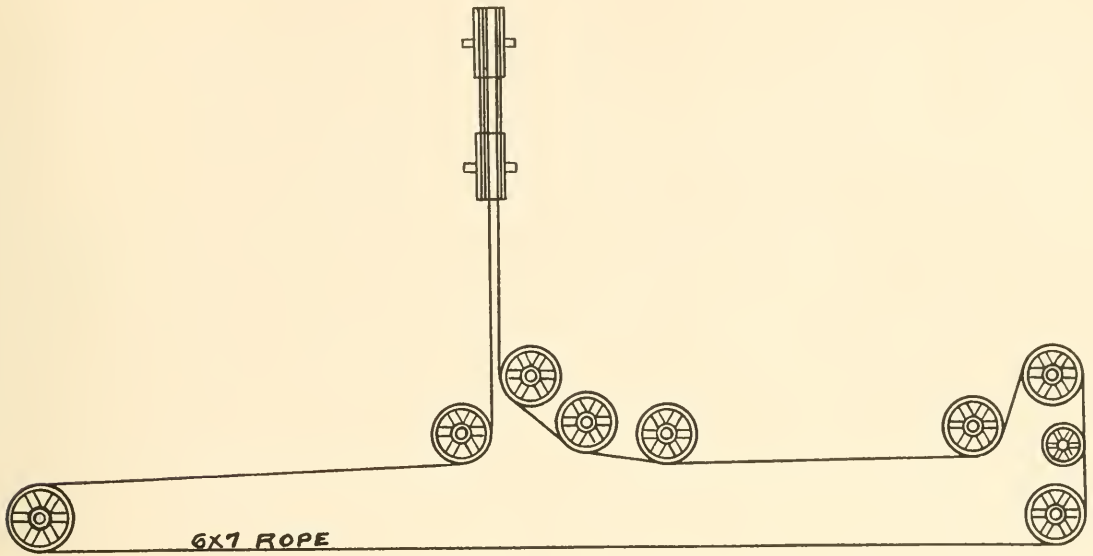

ENDLESS ROPE HAULAGE SYSTEM

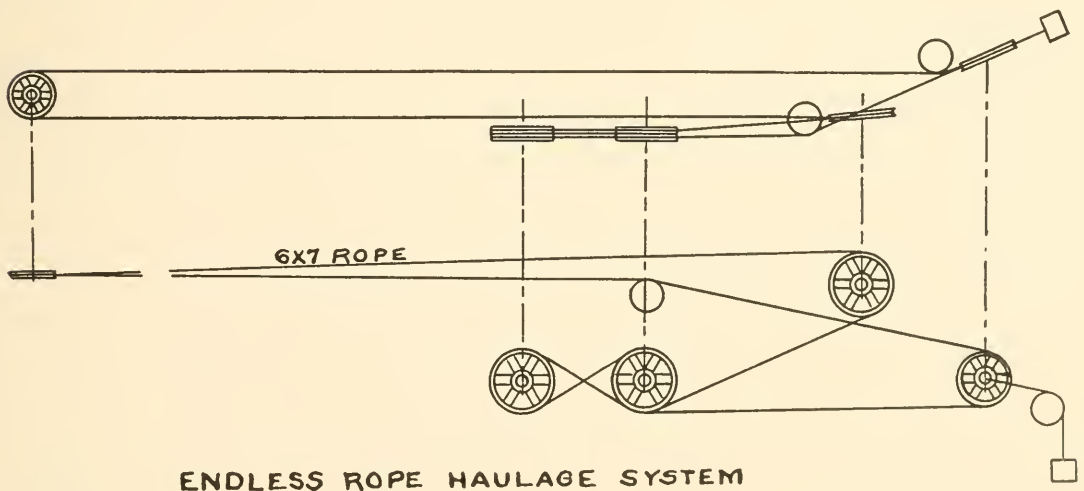

ENDLESS ROPE HAULAGE SYSTEM

2. Tail rope systems consist of two ropes known respectively as head line and tail line, the latter usually being about double the length of the former. Each rope is carried upon a separate drum and it differs from the endless system in that its operation is intermittent and the cycle of operations is for the head line to pull out a trip of about fifty loaded cars at a speed of about ten miles per hour. The time taken for the trip is dependent upon the length of the head line. The tail line is always attached to the rear car of the trip and as soon as the loaded cars have been run to the tippie by gravity, an empty trip of cars is pulled back into the mine by the tail line while the head line is at the same time attached to the front end of the train. The train of loaded cars or empty cars, as the case may be, is thus always under perfect control whether coming from the mine or returning to it.

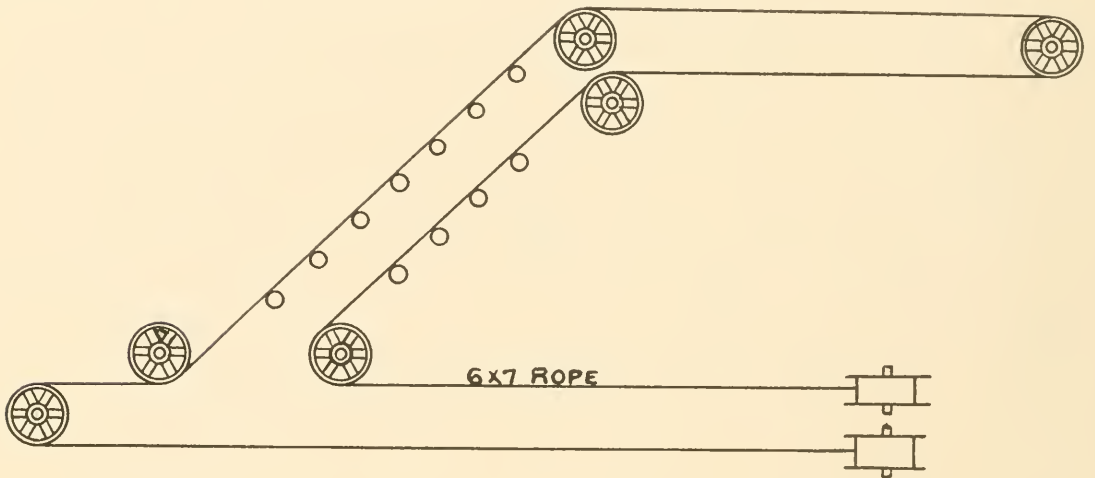

TAIL ROPE HAULAGE SYSTEM

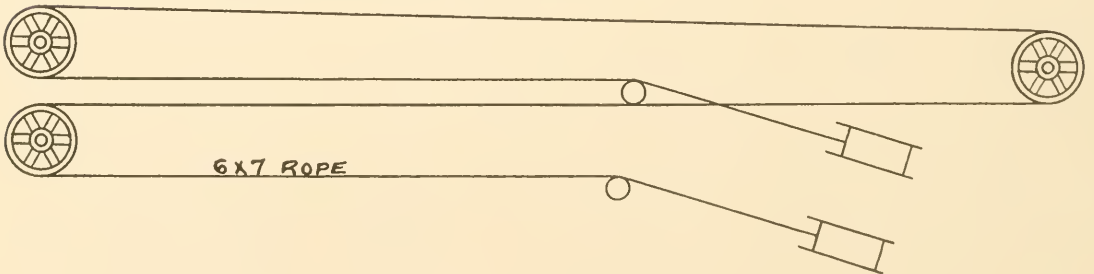

TAIL ROPE HAULAGE SYSTEM

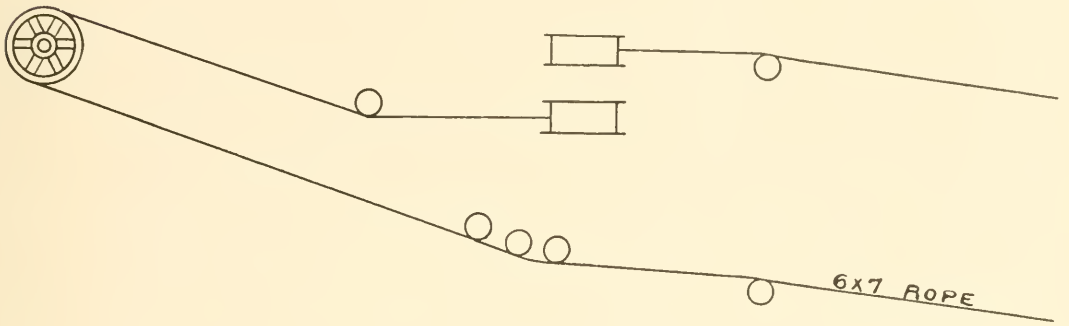

TAIL ROPE HAULAGE SYSTEM

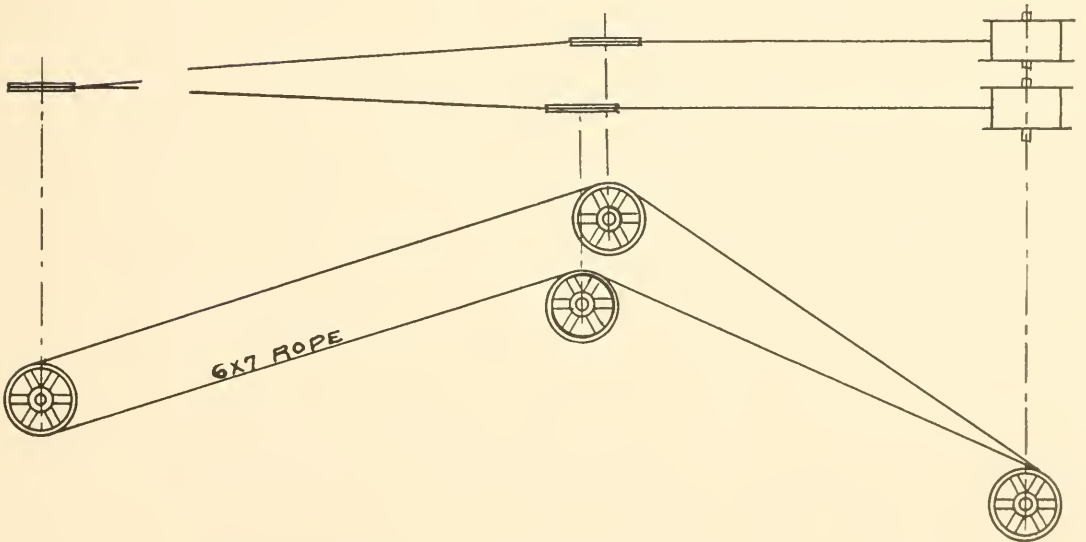

TAIL ROPE HAULAGE SYSTEM

Division 14

Oil Well Drilling The oil wells of the United States use many thousands of feet of wire rope in the drilling of wells. The first thing that is done to drill an oil well is to erect a square tapering tower, or derrick as it is called, some 90 to 100 feet high. At the top of the derrick are located the sheaves for the drilling line and sand line, also the tackle block for the tubing or casing line.

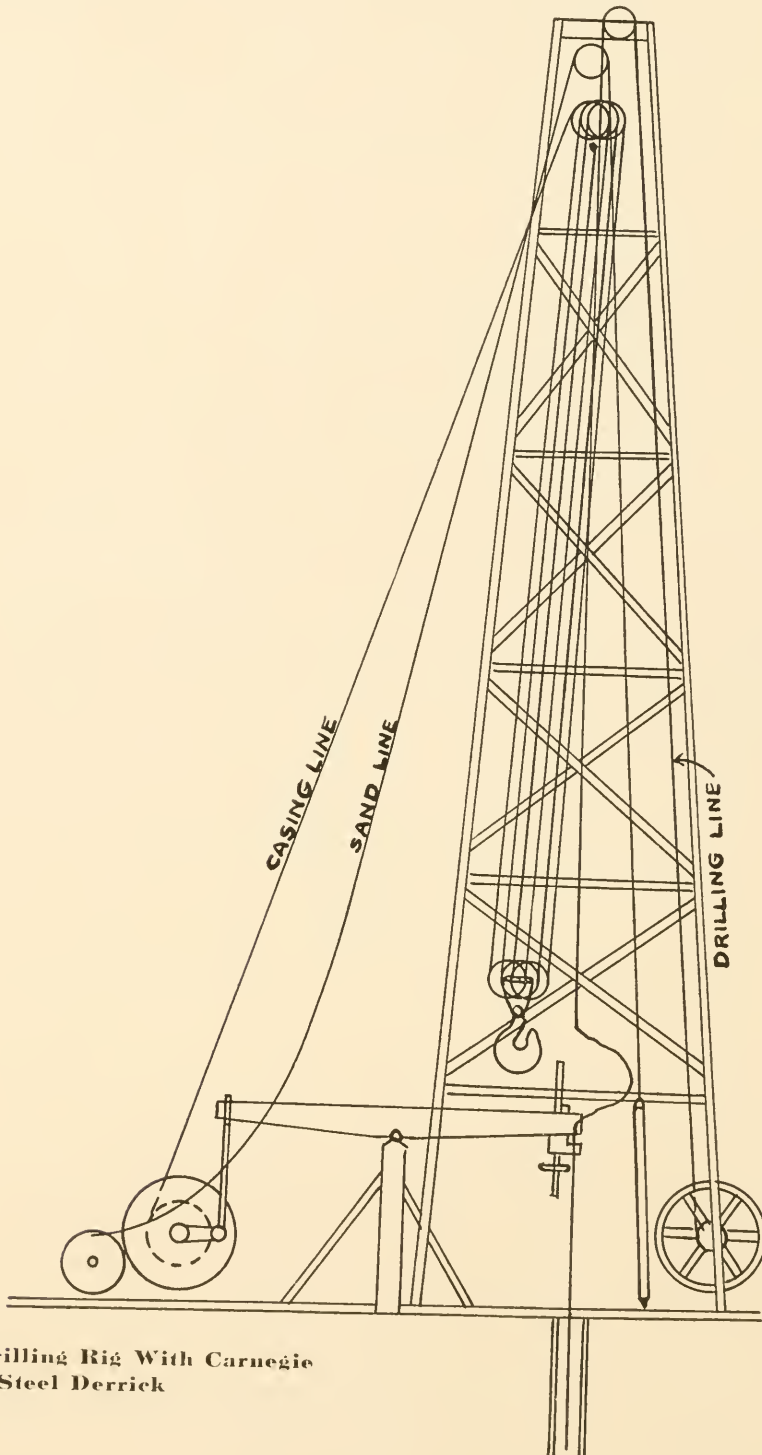

Oil Well Drilling Rig With Carnegie
Steel Derrick

The first operation of drilling is known as spudding and consists in starting the well and drilling a short distance. The early portion of the work is frequently done with manila rope and the well drilled to a depth of 600 to 800 feet. Wire rope is, however, being successfully used for the whole length and gradually displacing manila, especially where drillers are using the most advanced methods. Below a depth of 600 or 800 feet wire rope is almost invariably used.

Wells are usually started with 10-inch or 12-inch casing which is carried down as far as possible, when the next size smaller is inserted and carried down a considerable distance farther. It frequently happens that a well has to be finished with 4-inch casing. For each different size of casings different sizes and weights of tools are used, depending upon the character of the soil through which the well is being dug. After drilling a short time the drilling line and tools are pulled out of the well and the well bailed out with the sand line which is attached to a tube with valve in the bottom known as a bailer that is lowered to the bottom of the well and back again as often as may be necessary to get out the mud and water. Another length of casing is then attached to the main casing after drilling about 20 feet and the casing lowered that far before drilling is resumed. The above method is usually followed where the soil conditions are such that the hole is liable to cave. If, however, the drilling is through rocky ground the casing is usually placed at the time the drilling of the well is completed.

The successful drilling of an oil well is not a matter of chance, but requires a high degree of skill, for the well driller must be able to tell by placing his hand on the drilling line just how his drills are working. Many difficulties may be encountered, such as the casing becoming crooked and the rope wearing it in two, or the tools may stick and the rope break in getting them out, requiring a fishing job to recover the tools. All these conditions must be met by the drilling line. Our drilling lines are especially constructed to meet these conditions. Either the 6 x 19 or the 6 x 7 extra strong crucible steel, left lay, may be used for this work, although the 6 x 19 rope should prove the superior of the two constructions, on account of its greater flexibility. See pages 123 and 130 of this book.

Further particulars about oil wells will be found in a separate pamphlet which will be sent upon request to those who are interested in this line of wire rope activity.

Division 15

Suspension Bridges While very large suspension bridges are not composed of twisted wire cables, still smaller highway bridges and foot bridges may be so easily and cheaply made by using wire ropes as to be worthy of attention. The ropes usually used for this work are those shown on pages 175 and 181 of this book. Two suitable towers are necessary, one on either bank of the stream and the main ropes passed over the towers and carried back to suitable anchorages. Such a bridge is illustrated below.

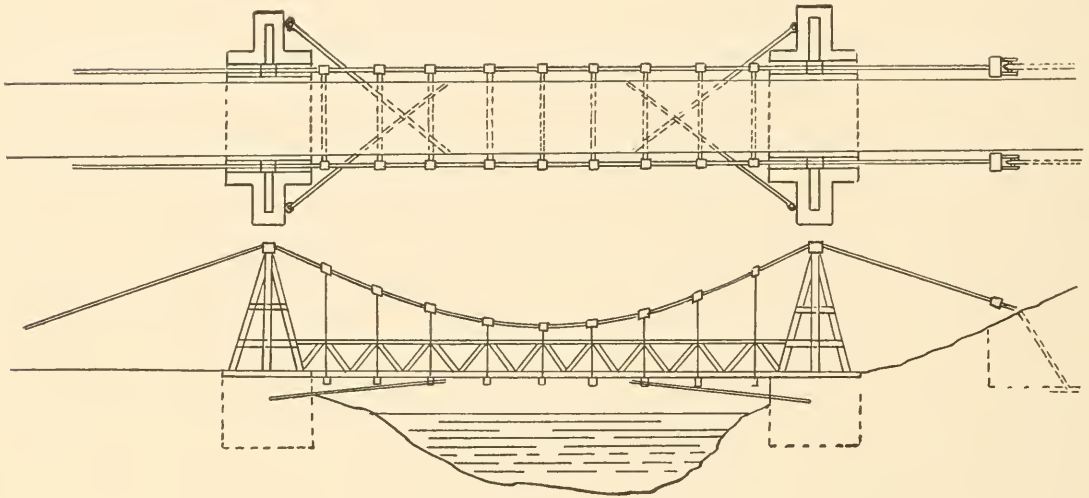

If the vertical suspenders are short, rods may be used together with clamps, washers and nuts and the cross floor timbers attached to them. The figures necessary to calculate the size of the cables are the total weight to be supported by each cable per foot, due to weight of floor and suspender rods, and also the maximum live load on the bridge at any given time, and whether the live load is uniformly distributed or in the center of the span. The formulæ and information in Chapter V, pages 53 and 57, may then be used to calculate the size of bridge cables.

Division 16

Stump Pulling To clear land of stumps or imbedded rocks, a stump pulling or grubbing machine is almost universally used. This grubbing machine consists of a compact horse-power windlass upon which a wire rope is wound, the outer end being fastened around the stump or rock to be removed. Only wire rope of great strength and toughness can withstand the severe strain and the bending stresses incident to this service.

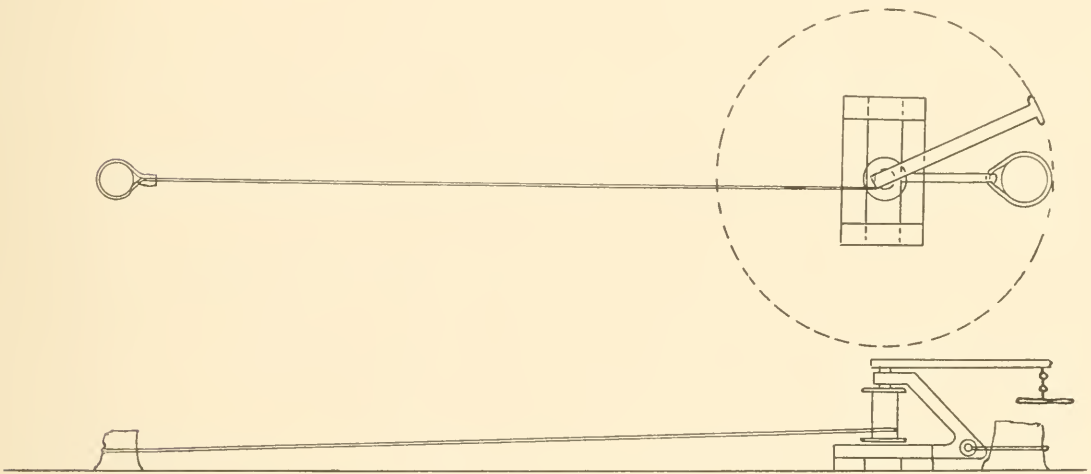

GRUBBING MACHINE FOR STUMP PULLING

Division 17

Towing Devices For all heavy sea and lake towing, tugs and towing steamers are equipped with automatic steam towing machines and galvanized steel wire hawsers. The hawser from the tow leads directly on to the towing machine drum, which is operated by steam. In a sea way, the tension of the hawser varies. Under a heavy strain the hawser is drawn from the drum, but as the drum rotates it opens the engine throttle until the steam pressure in the cylinders equalizes the pull on the hawser. When the tension is diminished, the steam causes the engines to haul in the hawser to its normal position, when the throttle is automatically closed. Thus a uniform tension is maintained on the hawser. The service requires an extra galvanized steel hawser of great flexibility and strength.

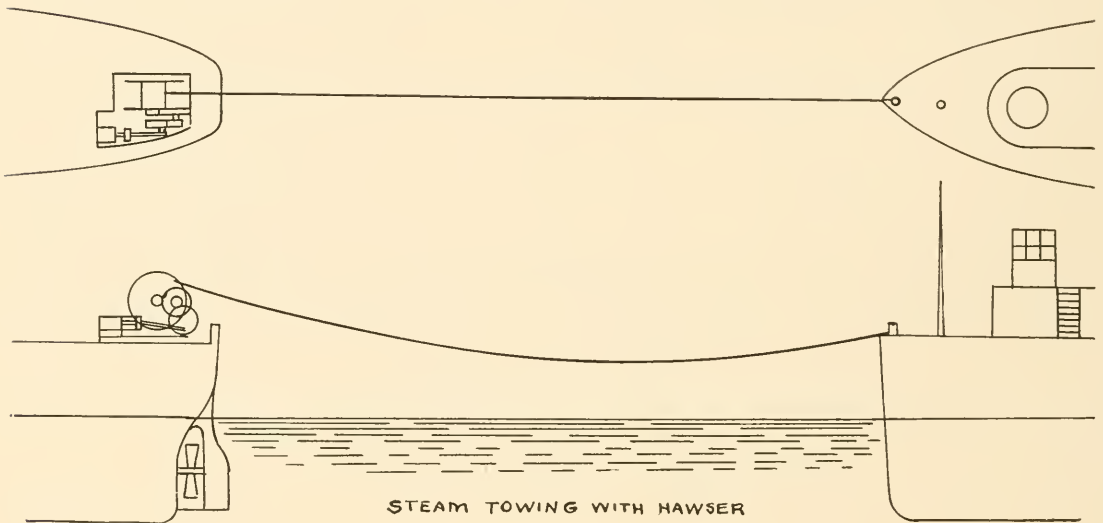

Catalogue Section



Chapter IX

List Prices of Wire Rope

Issued Jan. 1, 1913. Subject to Change Without Notice

No.	Page
1 Transmission Rope	120-125
2 Hoisting Rope	126-132
3 Extra Flexible Rope	133-137
4 Special Flexible Rope	138-143
5 Flattened Strand Rope	144-155
6 Tiller Rope	155
7 Non-spinning Rope	156-160
8 Steel Clad Hoisting Rope	162-171
9 Galvanized Guy Rope	175
10 Galvanized Running Rope	177
11 Galvanized Hawsers and Mooring Lines	178-180
12 Galvanized Bridge Cables	181
13 Sash Cord	182
14 Galvanized High Strength Aeroplane Strand	183
15 Galvanized Flexible Aeroplane or Motor Boat Cord	183
16 Galvanized Mast Arm	184
17 Stone Sawing Strand	184
18 Galvanized Strand	186-188
19 Track Strand, Round and Locked	189-191
20 Clothes Lines	192-193
21 Flat Rope	194-198
22 A. S. & W. Shield Filler	199

Wire Rope Lists

Transmission, Haulage or Standing Rope

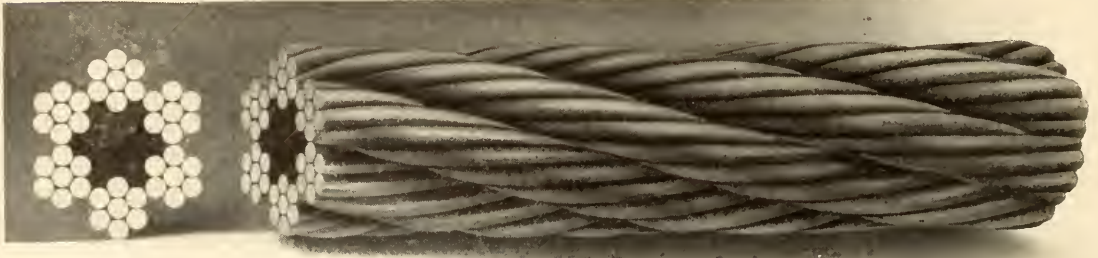

We present these lists in the order of their flexibility, from the least flexible to the most flexible.

This rope is composed of 6 strands of 7 wires each, all laid around a hemp core. Their detail application is explained briefly under each of the five following lists. The particular advantage of this type of construction consists in its coarse wires which resist abrasion and corrosion to the greatest possible extent. It is not a flexible rope, however, and whenever used must have the largest possible sheaves and drums over which to operate.

This rope is made in five grades or strengths, as follows :

1. *Iron*
2. *Crucible Cast Steel*
3. *Extra Strong Crucible Cast Steel*
4. *Plow Steel*
5. *Monitor or Improved Plow Steel and Tico Special*

Iron Transmission, Haulage or Standing Rope

Standard Strengths, Adopted May 1, 1910

6 Strands—7 Wires to the Strand—1 Hemp Core



List Price per Foot	Diameter in Inches	Circumference in Inches	Approximate Weight per Foot in Pounds	Approximate Strength in Tons of 2000 Pounds	Proper Working Load in Tons of 2000 Pounds	Diameter of Drum or Sheave in Feet Advised
\$0.51	1½	4¾	3.55	32	6.4	16
.43	1⅜	4¼	3	28	5.6	15
.36	1¼	4	2.45	23	4.6	13
.30	1⅛	3½	2	19	3.8	12
.24	1	3	1.58	15	3	10.5
.18½	¾	2¾	1.20	12	2.4	9
.14	¾	2¼	.89	8.8	1.7	7.5
.12	⅞	2⅛	.75	7.3	1.5	7.25
.10	⅝	2	.62	6	1.2	7
.08¼	⅞	1¾	.50	4.8	.96	6
.06½	½	1½	.39	3.7	.74	5.5
.05½	⅞	1¼	.30	2.6	.52	4.5
.04½	¾	1⅛	.22	2.2	.44	4
.03¾	⅝	1	.15	1.7	.34	3.5
.03¼	⅞	¾	.12½	1.2	.24	3

All ropes not herein listed and composed of more than 7 and less than 19 wires to the strand, with the exception of 6 x 8, take 19 wire list. Siemens-Martin steel rope, having 25 per cent greater strength than iron rope, at same prices as iron rope. Add 10 per cent to prices for wire center or galvanized rope.

Iron haulage rope is not extensively used at present, except in some of the smaller sizes. It is composed of very soft wires, which do not possess high tensile strength. Some of the sizes given above are never used, but figures are given for comparison with the stronger grades.

Crucible Cast Steel Transmission, Haulage or Standing Rope

Standard Strengths, Adopted May 1, 1910

6 Strands—7 Wires to the Strand—1 Hemp Core

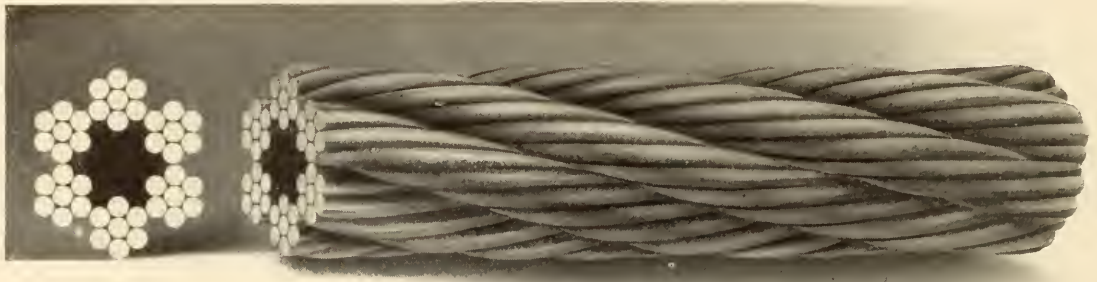

List Price per Foot	Diameter in Inches	Circumference in Inches	Approximate Weight per Foot in Pounds	Approximate Strength in Tons of 2000 Pounds	Proper Working Load in Tons of 2000 Pounds	Diameter of Drum or Sheave in Feet Advised
\$0.60	1½	4¾	3.55	63	12.6	11
.51	1⅜	4¼	3	53	10.6	10
.43	1¼	4	2.45	46	9.2	9
.36	1⅛	3½	2	37	7.4	8
.29	1	3	1.58	31	6.2	7
.22½	¾	2¾	1.20	24	4.8	6
.17	¾	2¼	.89	18.6	3.7	5
.14½	⅞	2⅛	.75	15.4	3.1	4¾
.12	⅝	2	.62	13	2.6	4½
.10	⅞	1¾	.50	10	2	4
.08	½	1½	.39	7.7	1.5	3½
.06½	⅞	1¼	.30	5.5	1.1	3
.05½	⅝	1⅛	.22	4.6	.92	2¾
.04½	⅞	1	.15	3.5	.70	2¼
.04	⅞	¾	.12½	2.5	.50	1¾

All ropes not listed herein and composed of more than 7 and less than 19 wires to the strand, with the exception of 6 x 8, take 19 wire list. Add 10 per cent to list prices for wire center or galvanized rope.

This rope covers a wide range of utility, being particularly adaptable for use in mine haulage work, which includes tail rope and endless haulage systems, gravity hoists, as well as coal and ore dock haulage roads operating small grip cars. In sizes, ⅜, ⅞, ½, ⅞, 5/8, it finds use as sand lines for oil wells, and in the larger sizes, 5/8, ¾, 7/8, 1, is sometimes used for oil well drilling. In general, rope from this list can be used where abrasion is severe and flexibility required a minimum quantity.

Extra Strong Crucible Cast Steel Transmission, Haulage or Standing Rope

Standard Strengths, Adopted May 1, 1910

6 Strands—7 Wires to the Strand—1 Hemp Core

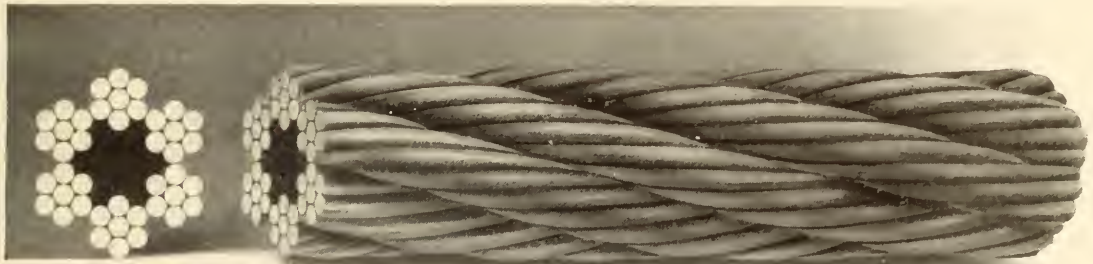

List Price per Foot	Diameter in Inches	Circumference in Inches	Approximate Weight per Foot in Pounds	Approximate Strength in Tons of 2000 Pounds	Proper Working Load in Tons of 2000 Pounds	Diameter of Drum or Sheave in Feet Advised
\$0.75	1 1/2	4 3/4	3.55	73	14.6	11
.64	1 3/8	4 1/4	3	63	12.6	10
.53	1 1/4	4	2.45	54	10.8	9
.44	1 1/8	3 1/2	2	43	8.6	8
.35	1	3	1.58	35	7	7
.27	7/8	2 3/4	1.20	28	5.6	6
.20	3/4	2 1/4	.89	21	4.2	5
.17	11/16	2 1/8	.75	16.7	3.3	4 3/4
.14 1/4	5/8	2	.62	14.5	2.9	4 1/2
.12	9/16	1 3/4	.50	11	2.2	4
.09 1/2	1/2	1 1/2	.39	8.85	1.8	3 1/2
.07 1/2	7/16	1 1/4	.30	6.25	1.25	3
.06	3/8	1 1/8	.22	5.25	1.05	2 3/4
.05 1/2	5/16	1	.15	3.95	.79	2 1/4
.05	9/32	7/8	.12 1/2	2.95	.59	1 3/4

All ropes not listed herein and composed of more than 7 and less than 19 wires to the strand, with the exception of 6 x 8, take 19 wire list. Add 10 per cent to list prices for wire center or galvanized rope.

This being the next stronger rope of this construction, its use is practically the same as that of the crucible steel, except that in many cases a smaller rope can be used and the same strength obtained. This rope also covers a wide range of utility, being particularly adaptable for use in mine haulage work, which includes tail rope and endless haulage systems, gravity hoists, as well as coal and ore dock haulage roads operating small grip cars. In sizes 3/8, 1/2, 5/8, it finds use as sand lines for oil wells, and in the larger sizes, 3/4, 7/8, 1, is sometimes used for oil well drilling. In general, rope from this list can be used where abrasion is severe and flexibility required a minimum quantity.

Plow Steel Transmission, Haulage or Standing Rope

Standard Strengths, Adopted May 1, 1910

6 Strands—7 Wires to the Strand—1 Hemp Core



List Price per Foot	Diameter in Inches	Circumference in Inches	Approximate Weight per Foot in Pounds	Approximate Strength in Tons of 2000 Pounds	Proper Working Load in Tons of 2000 Pounds	Diameter of Drum or Sheave in Feet Advised
\$0.90	1½	4¾	3.55	82	16.4	11
.76	1⅜	4¼	3	72	14.4	10
.62	1¼	4	2.45	60	12	9
.51	1⅛	3½	2	47	9.4	8
.41	1	3	1.58	38	7.6	7
.32	¾	2¾	1.20	31	6.2	6
.24½	¾	2¼	.89	23	4.6	5
.21	⅞	2⅞	.75	18	3.6	4¾
.17½	⅝	2	.62	16	3.2	4½
.14½	⅝	1¾	.50	12	2.4	4
.11½	½	1½	.39	10	2	3½
.09	⅞	1¼	.30	7	1.4	3
.06¾	⅝	1⅛	.22	5.9	1.2	2¾
.06	⅝	1	.15	4.4	.88	2¼
.05½	⅝	¾	.12½	3.4	.68	1¾

All ropes not listed herein and composed of more than 7 and less than 19 wires to the strand, with the exception of 6 x 8, take 19 wire list. Add 10 per cent to list prices for wire center or galvanized rope.

This is a very strong rope, and its wires are harder and capable of withstanding more external wear than the softer crucible steel. Its general scope of application is for mine haulage, including endless, tail rope systems and gravity hoists, as well as ore and coal dock haulage roads operating small grip cars. Where it is necessary to secure increased strength and the physical requirements render it impossible to alter the working conditions, a plow steel rope may be used to distinct advantage without increasing the diameter of the rope.

Monitor Plow Steel Transmission, Haulage or Standing Rope

Standard Strengths, Adopted May 1, 1910

6 Strands—7 Wires to the Strand—1 Hemp Core

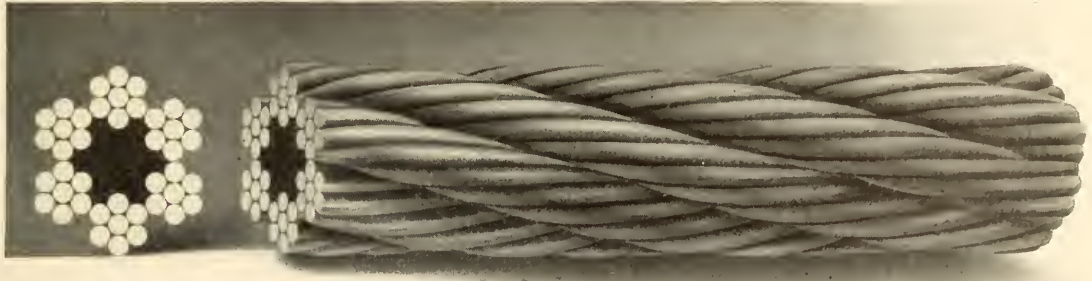

List Price per Foot	Diameter in Inches	Circumference in Inches	Approximate Weight per Foot in Pounds	Approximate Strength in Tons of 2000 Pounds	Proper Working Load in Tons of 2000 Pounds	Diameter of Drum or Sheave in Feet Advised
\$1.05	1½	4¾	3.55	90	18	11
.88	1⅜	4¼	3	79	16	10
.72	1¼	4	2.45	67	13	9
.58	1⅛	3½	2	52	10	8
.48	1	3	1.58	42	8.4	7
.37	¾	2¾	1.20	33	6.6	6
.28½	¾	2¼	.89	25	5	5
.24½	11⁄8	2⅝	.75	20	4	4¾
.20½	5⁄8	2	.62	17½	3.5	4½
.17	9⁄8	1¾	.50	13	2.6	4
.13½	½	1½	.39	11	2.2	3½
.11½	7⁄8	1¼	.30	7¾	1.5	3
.08¾	3⁄8	1⅛	.22	6½	1.3	2½

All ropes not listed herein and composed of more than 7 and less than 19 wires to the strand, with the exception of 6 x 8, take 19 wire list. Add 10 per cent to list prices for wire center or galvanized rope.

This is the strongest rope of this construction, and although somewhat stiffer than the preceding qualities, may be used to advantage where conditions are suitable. For its strength it is the toughest rope that can be made, and in general a smaller diameter rope of this type should be used than any of the preceding qualities. When this is done it will give a good account of itself. Its uses are similar to those described under plow steel, extra strong and crucible steel. Sheaves for this rope should be somewhat larger than for the preceding qualities if possible, in order to get the very best results. This special rope, sold from same list.

Standard Hoisting Rope

6 Strands—19 Wires to the Strand—1 Hemp Core



This term is applied to hoisting rope composed of 6 strands of 19 wires each, laid around a hemp core. It has a wide and varied list of applications, some of the principal ones of which are detailed under their respective lists. It is composed of smaller wires than the 6 x 7 construction and is more readily passed around sheaves and drums of moderate size. Its wires being smaller, it will not stand as much abrasion as the coarser transmission rope.

This rope is made in six grades or strengths as follows:

1. *Iron*
2. *Mild Steel*
3. *Crucible Cast Steel*
4. *Extra Strong Crucible Cast Steel*
5. *Plow Steel*
6. *Monitor or Improved Plow Steel and Tico Special*

Standard Iron Hoisting Rope

Standard Strengths, Adopted May 1, 1910

6 Strands—19 Wires to the Strand—1 Hemp Core



List Price per Foot	Diameter in Inches	Circumference in Inches	Approximate Weight per Foot in Pounds	Approximate Strength in Tons of 2000 Pounds	Proper Working Load in Tons of 2000 Pounds	Diameter of Drum or Sheave in Feet Advised
\$1.70	2¾	8⅝	11.95	111	22.2	17
1.40	2½	7⅞	9.85	92	18.4	15
1.17	2¼	7⅞	8	72	14.4	14
.95	2	6¼	6.30	55	11	12
.88	1⅞	5¾	5.55	50	10	12
.80	1¾	5½	4.85	44	8.8	11
.65	1⅝	5	4.15	38	7.6	10
.57	1½	4¾	3.55	33	6.6	9
.49	1⅜	4¼	3	28	5.6	8.5
.40	1¼	4	2.45	22.8	4.56	7.5
.33	1⅓	3½	2	18.6	3.72	7
.26	1	3	1.58	14.5	2.90	6
.20	⅞	2¾	1.20	11.8	2.36	5.5
.16	¾	2¼	.89	8.5	1.70	4.5
.12	⅝	2	.62	6	1.20	4
.10	⅜	1¾	.50	4.7	.94	3.5
.08½	½	1½	.39	3.9	.78	3
.07½	⅞	1¼	.30	2.9	.58	2.75
.07	⅝	1⅓	.22	2.4	.48	2.25
.06¾	⅝	1	.15	1.5	.30	2
.06½	¼	¾	.10	1.1	.22	1.50

All ropes not listed herein and composed of strands made up of more than 10 and less than 37 wires, take 37 wire list. Siemens-Martin Steel Rope, having 25 per cent greater strength than iron rope, at same price as iron rope. Add 10 per cent to list price for wire center or galvanized rope.

The wires in our iron rope are made from the best quality iron, being soft, tough and pliable. Iron Hoisting Rope is most generally used for elevator hoisting where the strength is sufficient. It is almost universally employed for counterweight ropes, except on traction elevators (see page 91). For traction elevators we recommend the Mild Steel Hoisting Rope described on the following page.

Iron Hoisting Rope is sometimes used for the transmission of power where the pulleys are comparatively small.

Mild Steel Elevator Hoisting Rope

6 Strands—19 Wires to the Strand—1 Hemp Core



List Price per Foot	Diameter in Inches	Circumference in Inches	Approximate Weight per Foot in Pounds	Approximate Strength in Tons of 2000 Pounds	Proper Working Load in Tons of 2000 Pounds	Diameter of Drum or Sheave in Feet
\$0.66	1½	4¾	3.55	54	10.80	7
.56	1⅜	4¼	3	45	9.00	6.25
.46	1¼	4	2.45	38	7.60	5.75
.38	1⅝	3½	2	30.5	6.10	5.25
.31	1	3	1.58	24	4.80	4.50
.24	¾	2¾	1.20	18.5	3.70	4
.19	¾	2¼	.89	13.5	2.70	3.5
.14	⅝	2	.62	9.5	1.90	3
.12	$\frac{9}{16}$	1¾	.50	7.7	1.54	2.70
.11	½	1½	.39	6	1.20	2.30
.10	$\frac{7}{16}$	1¼	.30	4.6	.92	2
.09½	⅜	1⅝	.22	3.4	.68	1.75

Made especially for traction elevators in tall buildings (see page 91) where, on account of usual quick starting and stopping, a stronger and lighter rope is required than the Iron quality. This Mild Steel Elevator Hoisting Rope is not recommended for all styles of elevators. For elevators employing separate counterweight ropes, the Iron Hoisting Rope is recommended.

Standard Crucible Cast Steel Hoisting Rope

Standard Strengths, Adopted May 1, 1910

6 Strands—19 Wires to the Strand—1 Hemp Core

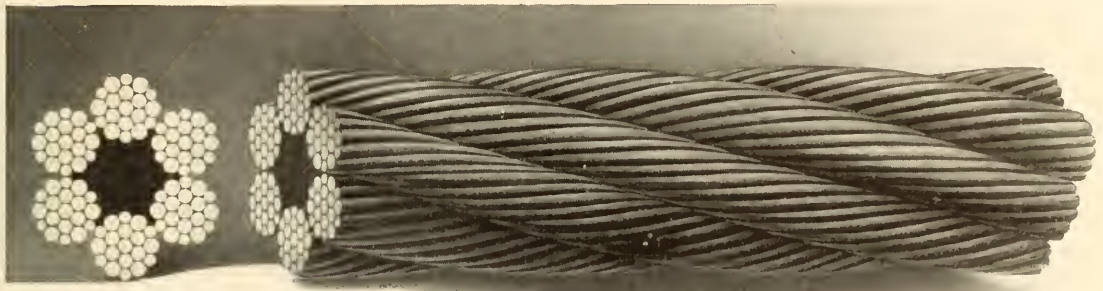

List Price per Foot	Diameter in Inches	Circumference in Inches	Approximate Weight per Foot in Pounds	Approximate Strength in Tons of 2000 Pounds	Proper Working Load in Tons of 2000 Pounds	Diameter of Drum or Sheave in Feet Advised
\$2.10	2 3/4	8 5/8	11.95	211	42.2	11
1.75	2 1/2	7 7/8	9.85	170	34	10
1.44	2 1/4	7 1/8	8	133	26.6	9
1.16	2	6 1/4	6.30	106	21.2	8
1.02	1 7/8	5 3/4	5.55	96	19	8
.90	1 3/4	5 1/2	4.85	85	17	7
.77	1 5/8	5	4.15	72	14.4	6.5
.66	1 1/2	4 3/4	3.55	64	12.8	6
.56	1 3/8	4 1/4	3	56	11.2	5.5
.46	1 1/4	4	2.45	47	9.4	5
.38	1 1/8	3 1/2	2	38	7.6	4.5
.31	1	3	1.58	30	6	4
.24	7/8	2 3/4	1.20	23	4.6	3.5
.19	3/4	2 1/4	.89	17.5	3.5	3
.14	5/8	2	.62	12.5	2.5	2.5
.12	9/16	1 3/4	.50	10	2	2.25
.11	1/2	1 1/2	.39	8.4	1.68	2
.10	7/16	1 1/4	.30	6.5	1.30	1.75
.09 1/2	3/8	1 1/8	.22	4.8	.96	1.50
.09 1/4	5/16	1	.15	3.1	.62	1.25
.09	1/4	3/4	.10	2.2	.44	1

All ropes not listed herein and composed of strands made up of more than 19 and less than 37 wires take 37 wire list. Add 10 per cent to list prices for wire center or galvanized rope.

This rope is a leading seller, being applicable to a great variety of uses, among which might be noted mine hoisting, logging, elevators, derricks, hay presses, dredges, cable-ways, inclined planes, coal hoists, conveyors, ballast unloaders, skip hoist and many other kindred applications. The material used in making this rope is the best quality crucible cast steel, which is about double the strength of iron in the same diameter.

Standard Extra Strong Crucible Cast Steel Hoisting Rope

Standard Strengths, Adopted May 1, 1910

6 Strands—19 Wires to the Strand—1 Hemp Core



List Price per Foot	Diameter in Inches	Circumference in Inches	Approximate Weight per Foot in Pounds	Approximate Strength in Tons of 2000 Pounds	Proper Working Load in Tons of 2000 Pounds	Diameter of Drum or Sheave in Feet Advised
\$2.55	2¾	8⅝	11.95	243	48.6	11
2.10	2½	7⅞	9.85	200	40	10
1.70	2¼	7⅞	8	160	32	9
1.34	2	6¼	6.3	123	24.6	8
1.25	1⅞	5¾	5.55	112	22.4	8
1.10	1¾	5½	4.85	99	19.8	7
.94	1⅝	5	4.15	83	16.6	6.5
.80	1½	4¾	3.55	73	14.6	6
.68	1⅜	4¼	3	64	12.8	5.5
.56	1¼	4	2.45	53	10.6	5
.46	1⅛	3½	2	43	8.6	4.5
.37	1	3	1.58	34	6.80	4
.29	⅞	2¾	1.20	26	5.20	3.5
.22	¾	2¼	.89	20.2	4.04	3
.16½	⅝	2	.62	14	2.80	2.5
.14	⅜	1¾	.50	11.2	2.24	2.25
.12½	½	1½	.39	9.2	1.84	2
.11½	⅞	1¼	.30	7.25	1.45	1.75
.11	⅜	1⅛	.22	5.30	1.06	1.50
.10¾	⅝	1	.15	3.50	.70	1.25
.10½	¼	¾	.10	2.43	.49	1

All ropes not listed herein and composed of strands made up of more than 19 and less than 37 wires take 37 wire list. Add 10 per cent to list prices for wire center or galvanized rope.

This rope is made from selected cast steel wires of higher tensile strength than the crucible steel, and, possessing greater strength, ropes from this list may be used with somewhat heavier loads than crucible steel. It has been found particularly useful for oil well drilling and tubing lines. Its other general uses are similar to those of the crucible steel, except that it may be used where loads are somewhat heavier.

Standard Plow Steel Hoisting Rope

Standard Strengths, Adopted May 1, 1910

6 Strands—19 Wires to the Strand—1 Hemp Core



List Price per Foot	Diameter in Inches	Circumference in Inches	Approximate Weight per Foot in Pounds	Approximate Strength in Tons of 2000 Pounds	Proper Working Load in Tons of 2000 Pounds	Diameter of Drum or Sheave in Feet Advised
\$3.00	2¾	8⅝	11.95	275	55	11
2.50	2½	7⅞	9.85	229	46	10
2.00	2¼	7⅞	8	186	37	9
1.58	2	6¼	6.3	140	28	8
1.46	1⅞	5¾	5.55	127	25	8
1.30	1¾	5½	4.85	112	22	7
1.08	1⅝	5	4.15	94	19	6.5
.93	1½	4¾	3.55	82	16	6
.79	1⅜	4¼	3	72	14	5.5
.65	1¼	4	2.45	58	12	5
.54	1⅛	3½	2	47	9.4	4.5
.43	1	3	1.58	38	7.6	4
.34	⅞	2¾	1.20	29	5.8	3.5
.26	¾	2¼	.89	23	4.6	3
.19	⅝	2	.62	15.5	3.1	2.5
.16	⅞	1¾	.50	12.3	2.4	2.25
.14	½	1½	.39	10	2	2
.13	⅞	1¼	.30	8	1.6	1.75
.12½	⅝	1⅛	.22	5.75	1.15	1.50
.12¼	⅝	1	.15	3.8	.76	1.25
.12	¼	¾	.10	2.65	.53	1

All ropes not listed herein and composed of strands made up of more than 19 and less than 37 wires take 37 wire list. Add 10 per cent to list prices for wire center or galvanized rope.

This is a very strong type of hoisting rope, used particularly for heavy mine hoisting, derricks, inclined planes, dredges, cableways for heavy logging and similar uses. In the case of deep mine shafts and long inclines it is especially efficient, because it possesses great strength for its weight. Consequently, it is the most economical rope to use where the weight of the rope has to be considered, or where the capacity of the machinery is to be increased without a corresponding increase in sheaves and drums.

Monitor Plow Steel Hoisting Rope

Standard Strengths, Adopted May 1, 1910

6 Strands—19 Wires to the Strand—1 Hemp Core



List Price per Foot	Diameter in Inches	Circumference in Inches	Approximate Weight per Foot in Pounds	Approximate Strength in Tons of 2000 Pounds	Proper Working Load in Tons of 2000 Pounds	Diameter of Drum or Sheave in Feet Advised
\$3.45	2 $\frac{3}{4}$	8 $\frac{5}{8}$	11.95	315	63	11
2.80	2 $\frac{1}{2}$	7 $\frac{7}{8}$	9.85	263	53	10
2.50	2 $\frac{1}{4}$	7 $\frac{1}{8}$	8	210	42	9
1.85	2	6 $\frac{1}{4}$	6.30	166	33	8
1.75	1 $\frac{7}{8}$	5 $\frac{3}{4}$	5.55	150	30	8
1.60	1 $\frac{3}{4}$	5 $\frac{1}{2}$	4.85	133	27	7
1.30	1 $\frac{5}{8}$	5	4.15	110	22	6 $\frac{1}{2}$
1.10	1 $\frac{1}{2}$	4 $\frac{3}{4}$	3.55	98	20	6
.90	1 $\frac{3}{8}$	4 $\frac{1}{4}$	3	84	17	5 $\frac{1}{2}$
.75	1 $\frac{1}{4}$	4	2.45	69	14	5
.62	1 $\frac{1}{8}$	3 $\frac{1}{2}$	2	56	11	4 $\frac{1}{2}$
.50	1	3	1.58	45	9	4
.39	$\frac{7}{8}$	2 $\frac{3}{4}$	1.20	35	7	3 $\frac{1}{2}$
.31	$\frac{3}{4}$	2 $\frac{1}{4}$.89	26.3	5.3	3
.22 $\frac{1}{2}$	$\frac{5}{8}$	2	.62	19	3.8	2 $\frac{1}{2}$
.19	$\frac{9}{16}$	1 $\frac{3}{4}$.50	14.5	2.9	2 $\frac{1}{4}$
.17	$\frac{1}{2}$	1 $\frac{1}{2}$.39	12.1	2.4	2
.15 $\frac{1}{2}$	$\frac{7}{16}$	1 $\frac{1}{4}$.30	9.4	1.9	1 $\frac{3}{4}$
.14 $\frac{1}{2}$	$\frac{3}{8}$	1 $\frac{1}{8}$.22	6.75	1.35	1 $\frac{1}{2}$
.13 $\frac{1}{2}$	$\frac{5}{16}$	1	.15	4.50	.9	1 $\frac{1}{4}$
.13	$\frac{1}{4}$	$\frac{3}{4}$.10	3.15	.63	1

All ropes not listed herein and composed of strands made up of more than 19 and less than 37 wires take 37 wire list. Add 10 per cent to list prices for wire center or galvanized rope.

This grade of hoisting rope has been developed to provide a rope of very great strength, and in this respect has no equal. It is particularly useful on derricks, skidders, dredges and stump pullers. Being very strong, a smaller rope may be used than any of the preceding qualities of this construction. It is somewhat stiffer in the same diameter than the plow and crucible steel grades, but strength for strength, it is equally flexible. Sheaves should be somewhat larger for this quality of rope, if possible, to obtain the very best results. Tico special rope sold from same list.

Extra Flexible Steel Hoisting Rope

8 Strands—19 Wires to the Strand—1 Hemp Core



This rope is composed of 8 strands of 19 wires each laid around a hemp core. It will be noted that there are two more strands in this type than in that of the Standard Hoisting Rope. The addition of these two strands increases the flexibility and permits of the rope being used over comparatively small sheaves and drums such as are frequently found on derricks. It is not good practice to use it where there is much overwinding, because it would flatten or lose shape more quickly than 6 x 19 rope.

Galvanized Extra Flexible Crucible Cast Steel hoisting rope is much more pliable than the six-strand hoisting rope, and is preferred by the leading yachtsmen to the galvanized crucible cast steel running rope shown on page 177.

For list prices add 10 per cent to the list for the bright rope.

This rope is made regularly in four grades or strengths as follows :

1. *Crucible Cast Steel.*
2. *Extra Strong Crucible Cast Steel.*
3. *Plow Steel.*
4. *Monitor or Improved Plow Steel, and Tico special.*

NOTE—The words “Extra Flexible” mean 8 strands, 19 wires each, one hemp core. The term “Special Flexible” means 6 strands, 37 wires each, one hemp core. For rope of the latter construction, see page 138.

Extra Flexible Crucible Cast Steel Hoisting Rope

Standard Strengths, Adopted May 1, 1910

8 Strands—19 Wires to the Strand—1 Hemp Core



List Price per Foot	Diameter in Inches	Circumference in Inches	Approximate Weight per Foot in Pounds	Approximate Strength in Tons of 2000 Pounds	Proper Working Load in Tons of 2000 Pounds	Diameter of Drum or Sheave in Feet Advised
\$0.73	1½	4¾	3.19	58	11.6	3.75
.62	1⅜	4¼	2.70	51	10.2	3.5
.51	1¼	4	2.20	42	8.4	3.2
.42	1⅛	3½	1.80	34	6.8	2.83
.34	1	3	1.42	26	5.2	2.5
.27	⅞	2¾	1.08	20	4	2.16
.21	¾	2¼	.80	15.3	3.06	1.83
.16	⅝	2	.56	10.9	2.18	1.75
.14	⅜	1¾	.45	8.7	1.74	1.5
.12	½	1½	.35	7.3	1.46	1.33
.11	⅜	1¼	.27	5.7	1.14	1.16
.10½	⅜	1⅛	.20	4.2	.84	1
.10¼	⅜	1	.13	2.75	.55	.83
.10	¼	¾	.09	1.80	.36	.75

Add 10 per cent to list prices for galvanized rope.

This rope is particularly adaptable for use over fairly small size sheaves on derricks, steam dredges, coal and ore handling machinery, pile drivers, and also for logging purposes, as well as tubing lines for oil wells. It is not quite as strong in the same diameter as the regular hoisting rope, 6 x 19, due to its larger hemp center, but it is more flexible. This rope when galvanized is known as galvanized extra flexible crucible cast steel hoisting rope and is much used by yachtsmen.

Extra Flexible Extra Strong Crucible Cast Steel Hoisting Rope

Standard Strengths, Adopted May 1, 1910

8 Strands—19 Wires to the Strand—1 Hemp Core



List Price per Foot	Diameter in Inches	Circumference in Inches	Approximate Weight per Foot in Pounds	Approximate Strength in Tons of 2000 Pounds	Proper Working Load in Tons of 2000 Pounds	Diameter of Drum or Sheave in Feet Advised
\$0.88	1½	4¾	3.19	66	13	3.75
.75	1⅜	4¼	2.70	57	11	3.5
.62	1¼	4	2.20	47	9.4	3.2
.51	1⅛	3½	1.80	38	7.6	2.83
.41	1	3	1.42	29.7	5.9	2.5
.32	¾	2¾	1.08	23	4.6	2.16
.25	¾	2¼	.80	17.6	3.5	1.83
.18½	⅝	2	.56	12.4	2.5	1.75
.16	⅙	1¾	.45	10.1	2	1.5
.14	½	1½	.35	8.	1.6	1.33
.13	⅙	1¼	.27	6.30	1.26	1.16
.12¼	⅝	1⅛	.20	4.66	.93	1
.12	⅙	1	.13	3.05	.61	.83
.11¾	¼	¾	.09	2.02	.40	.75

Add 10 per cent to list prices for galvanized rope.

This rope is made from selected cast steel wires of higher tensile strength than the crucible steel, and, possessing greater strength, ropes from this list may be used for somewhat heavier loads than crucible steel. Its general uses are similar to those of the crucible steel described on the preceding page.

Extra Flexible Plow Steel Hoisting Rope

Standard Strengths, Adopted May 1, 1910

8 Strands—19 Wires to the Strand—1 Hemp Core



List Price per Foot	Diameter in Inches	Circumference in Inches	Approximate Weight per Foot in Pounds	Approximate Strength in Tons of 2000 Pounds	Proper Working Loads in Tons of 2000 Pounds	Diameter of Drum or Sheave in Feet Advised
\$1.03	1½	4¾	3.19	74	14.8	3.75
.87	1⅜	4¼	2.70	64	12.8	3.5
.72	1¼	4	2.20	52	10.4	3.2
.60	1⅓	3½	1.80	43	8.6	2.83
.48	1	3	1.42	33	6.6	2.5
.38	7⁄8	2¾	1.08	26	5.2	2.16
.29	¾	2¼	.80	20	4	1.83
.21	5⁄8	2	.56	14	2.8	1.75
.18	9⁄16	1¾	.45	11.6	2.32	1.50
.16	½	1½	.35	8.7	1.74	1.33
.15	7⁄16	1¼	.27	6.90	1.38	1.16
.14	3⁄8	1⅓	.20	5.12	1.02	1
.13½	5⁄16	1	.13	3.35	.67	.83
.13¼	¼	¾	.09	2.25	.45	.75

Add 10 per cent to list prices for galvanized rope.

This is a very strong as well as a very flexible rope, principally used on derricks, dredges, coal and ore handling machinery, pile drivers and logging, where small sheaves necessitate a flexible rope and where greater strength than shown for preceding grades is required. This rope is also made galvanized and is then known as galvanized extra flexible plow steel hoisting rope, largely used on ships and yachts.

Extra Flexible Monitor Plow Steel Hoisting Rope

Standard Strengths, Adopted May 1, 1910

8 Strands—19 Wires to the Strand—1 Hemp Core

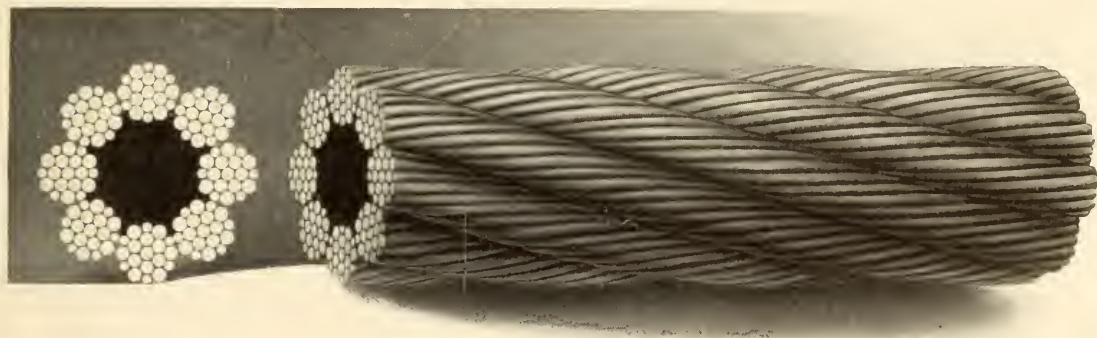

List Price per Foot	Diameter in Inches	Circumference in Inches	Approximate Weight per Foot in Pounds	Approximate Strength in Tons of 2000 Pounds	Proper Working Load in Tons of 2000 Pounds	Diameter of Drum or Sheave in Feet Advised
\$1.19	1½	4¾	3.19	80	16	3.75
.98	1⅜	4¼	2.70	68	13	3.5
.82	1¼	4	2.20	56	11	3.2
.68	1⅛	3½	1.80	46	9.2	2.83
.55	1	3	1.42	36	7.2	2.5
.43	¾	2¾	1.08	28	5.6	2.15
.34	¾	2¼	.80	22	4.4	1.83
.25	⅝	2	.56	15	3	1.75
.22	⅝	1¾	.45	12	2.4	1.5
.19	½	1½	.35	9.5	1.9	1.33

Add 10 per cent to list prices for galvanized rope.

This is a very efficient rope for its strength where loads are heavy, it being the strongest rope that can be made in this type of construction. It is preferable to employ sheaves somewhat larger with this quality so as to insure greater durability. Tico special rope sold from same list.

Special Flexible Hoisting Rope

6 Strands—37 Wires to the Strand—1 Hemp Core



This rope is composed of 6 strands of 37 wires each, laid around a hemp core. It is a very flexible rope and much used on cranes and similar machinery where sheaves are of necessity rather small. Its wires are smaller than in the 6-strand 19-wire rope and consequently will not stand as much abrasive wear. It is a very efficient rope because a little over 50 per cent of the wires—and consequently over 50 per cent of the strength—are in the inner layers of the strand, protected from abrasion. This explains its particular advantage in addition to its flexibility. Hoisting ropes larger than 1 $\frac{3}{4}$ inches are usually made of 6 strands of 37 wires each, rather than of 6 strands of 19 wires.

Special Flexible Hoisting Rope is made in five grades :

1. *Crucible Cast Steel*
2. *Extra Strong Crucible Cast Steel*
3. *Special Flexible Crane Rope (price same as Plow Steel)*
4. *Plow Steel*
5. *Monitor or Improved Plow Steel, and Tico special*

Special Flexible Crane Ropes These are composed of 6 strands of 37 wires to the strand, with a hemp center; are sold from the plow steel list and are especially designed for service on electric cranes.

NOTE—The term “Special Flexible” means 6 strands, 37 wires each, one hemp core. The words “Extra Flexible” mean 8 strands, 19 wires each, one hemp core. For rope of the latter construction, see page 133.

Special Flexible Crucible Cast Steel Hoisting Rope

Standard Strengths, Adopted May 1, 1910

6 Strands—37 Wires to the Strand—1 Hemp Core



List Price per Foot	Diameter in Inches	Circumference in Inches	Approximate Weight per Foot in Pounds	Approximate Strength in Tons of 2000 Pounds	Proper Working Load in Tons of 2000 Pounds	Diameter of Drum or Sheave in Feet Advised
\$2.30	2 3/4	8 5/8	11.95	200	40	
1.92	2 1/2	7 7/8	9.85	160	32	
1.60	2 1/4	7 1/8	8	125	25	
1.35	2	6 1/4	6.30	105	21	
1.20	1 7/8	5 3/4	5.55	94	18.8	
1.05	1 3/4	5 1/2	4.85	84	17	
.89	1 5/8	5	4.15	71	14	
.79	1 1/2	4 3/4	3.55	63	12	3.75
.65	1 3/8	4 1/4	3	55	11	3.5
.55	1 1/4	4	2.45	45	9	3.2
.46	1 1/8	3 1/2	2	34	7	2.83
.37	1	3	1.58	29	6	2.5
.28	7/8	2 3/4	1.20	23	5	2.16
.23	3/4	2 1/4	.89	17.5	3.5	1.83
.18	5/8	2	.62	11.2	2.2	1.75
.15	9/16	1 3/4	.50	9.5	1.9	1.5
.13	1/2	1 1/2	.39	7.25	1.45	1.33
.12 1/2	7/16	1 1/4	.30	5.5	1.1	1.16
.12	3/8	1 1/8	.22	4.2	.84	1

Ropes composed of strands made up of more than 37 wires, add 10 per cent to list price of 6 x 37. Add 10 per cent. for wire center.

Ropes of this construction may be used for general hoisting work where loads are moderate and where sheaves are small. It is a stronger construction than the extra flexible, but somewhat more expensive, and its wires will not stand as much abrasion as the 6 x 19 construction.

Special Flexible Extra Strong Crucible Cast Steel Hoisting Rope

Standard Strengths, Adopted May 1, 1910

6 Strands—37 Wires to the Strand—1 Hemp Core



List Price per Foot	Diameter in Inches	Circumference in Inches	Approximate Weight per Foot in Pounds	Approximate Strength in Tons of 2000 Pounds	Proper Working Load in Tons of 2000 Pounds	Diameter of Drum or Sheave in Feet Advised
\$2.80	2 $\frac{3}{4}$	8 $\frac{5}{8}$	11.95	233	47	
2.35	2 $\frac{1}{2}$	7 $\frac{7}{8}$	9.85	187	37	
1.90	2 $\frac{1}{4}$	7 $\frac{1}{8}$	8	150	30	
1.55	2	6 $\frac{1}{4}$	6.30	117	23	
1.41 $\frac{1}{2}$	1 $\frac{7}{8}$	5 $\frac{3}{4}$	5.55	106	21.2	
1.28	1 $\frac{3}{4}$	5 $\frac{1}{2}$	4.85	95	19	
1.07	1 $\frac{5}{8}$	5	4.15	79	16	
.95	1 $\frac{1}{2}$	4 $\frac{3}{4}$	3.55	71	14	3.75
.78	1 $\frac{3}{8}$	4 $\frac{1}{4}$	3	61	12	3.5
.65	1 $\frac{1}{4}$	4	2.45	50	10	3.20
.55	1 $\frac{1}{8}$	3 $\frac{1}{2}$	2	39	8	2.83
.44	1	3	1.58	32	6.4	2.5
.34	$\frac{7}{8}$	2 $\frac{3}{4}$	1.20	25	5	2.16
.27	$\frac{3}{4}$	2 $\frac{1}{4}$.89	19	3.8	1.83
.21	$\frac{5}{8}$	2	.62	12.6	2.5	1.75
.17 $\frac{1}{2}$	$\frac{9}{16}$	1 $\frac{3}{4}$.50	10.5	2.1	1.5
.15	$\frac{1}{2}$	1 $\frac{1}{2}$.39	8.25	1.65	1.33
.14	$\frac{7}{16}$	1 $\frac{1}{4}$.30	6.35	1.27	1.16
.13	$\frac{3}{8}$	1 $\frac{1}{8}$.22	4.65	.93	1

Ropes composed of strands made up of more than 37 wires, add 10 per cent to list price of 6 x 37. Add 10 per cent. for wire center.

This is the next stronger grade of this construction and can be used for heavier loads than the crucible steel, being considerably stronger in the same diameter. Its general uses are similar to the crucible steel.

Special Flexible Plow Steel Hoisting Rope

Standard Strengths, Adopted May 1, 1910

6 Strands—37 Wires to the Strand—1 Hemp Core



List Price per Foot	Diameter in Inches	Circumference in Inches	Approximate Weight per Foot in Pounds	Approximate Strength in Tons of 2000 Pounds	Proper Working Load in Tons of 2000 Pounds	Diameter of Drum or Sheave in Feet Advised
\$3.30	2¾	8⅝	11.95	265	53	
2.75	2½	7⅞	9.85	214	43	
2.20	2¼	7⅞	8	175	35	
1.80	2	6¼	6.30	130	26	
1.65	1⅞	5¾	5.55	119	23.8	
1.50	1¾	5½	4.85	108	22	
1.25	1⅝	5	4.15	90	18	
1.10	1½	4¾	3.55	80	16	3.75
.91	1⅜	4¼	3	68	14	3.5
.75	1¼	4	2.45	55	11	3.2
.64	1⅛	3½	2	44	9	2.83
.51	1	3	1.58	35	7	2.5
.40	⅞	2¾	1.20	27	5	2.16
.31	¾	2¼	.89	21	4	1.83
.24	⅝	2	.62	14	3	1.75
.20	⅞	1¾	.50	11.5	2.3	1.5
.17	½	1½	.39	9.25	1.85	1.33
.16	⅞	1¼	.30	7.2	1.4	1.16
.15	⅝	1⅞	.22	5.1	1	1

Ropes composed of strands made up of more than 37 wires, add 10 per cent to list price of 6 x 37. Add 10 per cent. for wire center.

Ropes of this construction are largely used on electric traveling cranes, dredges and similar machinery, where loads are heavy and sheaves are of necessity small. These ropes are very efficient and give excellent service where conditions favor their use.

Special Flexible Monitor Plow Steel Hoisting Rope

Standard Strengths, Adopted May 1, 1910

6 Strands—37 Wires to the Strand—1 Hemp Core

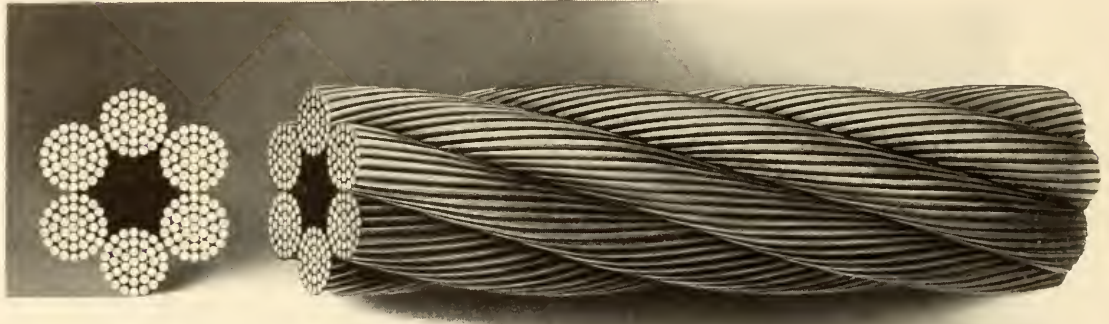

List Price per Foot	Diameter in Inches	Circumference in Inches	Approximate Weight per Foot in Pounds	Approximate Strength in Tons of 2000 Pounds	Proper Working Load in Tons of 2000 Pounds	Diameter of Drum or Sheave in Feet Advised
\$3.75	2 $\frac{3}{4}$	8 $\frac{5}{8}$	11.95	278	55	
3.15	2 $\frac{1}{2}$	7 $\frac{7}{8}$	9.85	225	45	
2.50	2 $\frac{1}{4}$	7 $\frac{1}{8}$	8	184	37	
2.10	2	6 $\frac{1}{4}$	6.30	137	27	
1.92 $\frac{1}{2}$	1 $\frac{7}{8}$	5 $\frac{3}{4}$	5.55	125	25	
1.75	1 $\frac{3}{4}$	5 $\frac{1}{2}$	4.85	113	23	
1.45	1 $\frac{5}{8}$	5	4.15	95	19	
1.25	1 $\frac{1}{2}$	4 $\frac{3}{4}$	3.55	84	17	3.75
1.05	1 $\frac{3}{8}$	4 $\frac{1}{4}$	3	71	14	3.50
.86	1 $\frac{1}{4}$	4	2.45	58	11	3.20
.75	1 $\frac{1}{8}$	3 $\frac{1}{2}$	2	46	9.2	2.83
.59	1	3	1.58	37	7.4	2.50
.46	$\frac{7}{8}$	2 $\frac{3}{4}$	1.20	29	5.8	2.16
.36	$\frac{3}{4}$	2 $\frac{1}{4}$.89	23	4.6	1.83
.27	$\frac{5}{8}$	2	.62	16	3.2	1.75
.23	$\frac{9}{16}$	1 $\frac{3}{4}$.50	12 $\frac{1}{2}$	2.5	1.50
.20	$\frac{1}{2}$	1 $\frac{1}{2}$.39	9.75	1.9	1.33
.18 $\frac{1}{2}$	$\frac{7}{16}$	1 $\frac{1}{4}$.30	7.50	1.5	1.15
.17 $\frac{1}{2}$	$\frac{3}{8}$	1 $\frac{1}{8}$.22	5.30	1.06	1

Ropes composed of strands made up of more than 37 wires, add 10 per cent to list price of 6 x 37. Add 10 per cent. for wire center.

This is the strongest rope of the 6 x 37 construction made and suitable where conditions are unusually severe. It is largely used on dredges both for main hoist and spud ropes. We recommend its use where loads have to be increased without corresponding increase in diameter of rope. Tico special rope sold from same list.

Extra Special Flexible Hoisting Rope

6 Strands—61 Wires to the Strand—1 Hemp Core

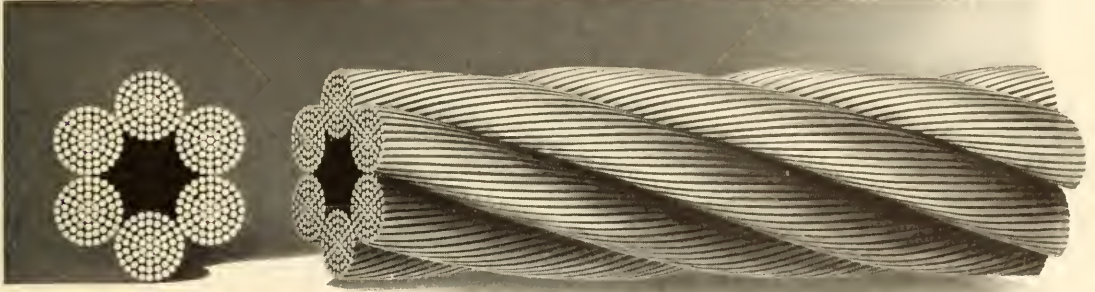

Crucible Cast Steel

List Price per Foot	Diameter in Inches	Circumference in Inches	Approximate Weight per Foot in Pounds	Approximate Strength in Tons of 2000 Pounds	Proper Working Load in Tons of 2000 Pounds	Diameter of Drum or Sheave in Feet Advised
. . .	3¼	10¼	16.60	280	56	11
. . .	3	9½	14.20	240	48	10
\$2.53	2¾	8⅝	11.95	200	40	9
2.112	2½	7⅞	9.85	160	32	8
1.76	2¼	7⅞	8.00	125	25	7
1.485	2	6¼	6.30	105	21	6

Extra Strong Crucible Cast Steel

. . .	3¼	10¼	16.60	315	63	11
. . .	3	9½	14.20	275	55	10
\$3.08	2¾	8⅝	11.95	233	47	9
2.585	2½	7⅞	9.85	187	37	8
2.09	2¼	7⅞	8.00	150	30	7
1.705	2	6¼	6.30	117	23	6

Plow Steel

. . .	3¼	10¼	16.60	350	70	11
. . .	3	9½	14.20	310	62	10
\$3.63	2¾	8⅝	11.95	265	53	9
3.025	2½	7⅞	9.85	214	43	8
2.42	2¼	7⅞	8.00	175	35	7
1.98	2	6¼	6.30	130	26	6

Monitor Plow Steel

. . .	3¼	10¼	16.60	370	74	11
. . .	3	9½	14.20	325	65	10
\$4.125	2¾	8⅝	11.95	278	56	9
3.465	2½	7⅞	9.85	225	45	8
2.75	2¼	7⅞	8.00	184	37	7
2.31	2	6¼	6.30	137	27	6

Add 10 per cent to above list prices for wire center.

Ropes of this construction are particularly recommended for dredging purposes, and are usually made with a special wire center for that purpose. The Plow Steel and Monitor grades are most frequently used.

Flattened Strand Ropes, Hoisting and Haulage



**Type A—5 Strands
28 Wires—1 Hemp Core**

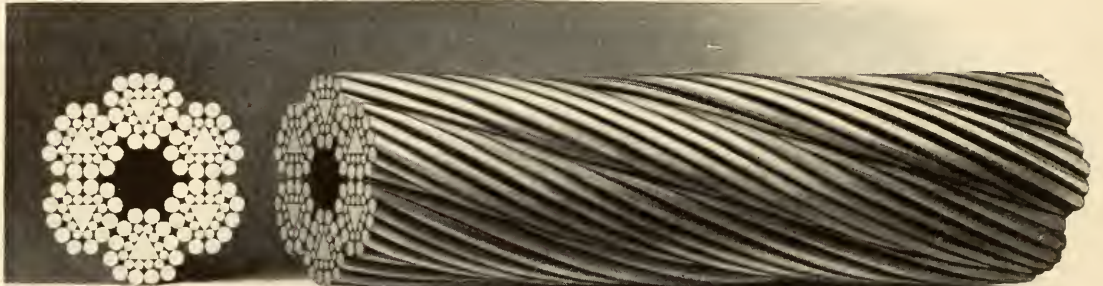

**Type B—6 Strands
25 Wires—1 Hemp Core**

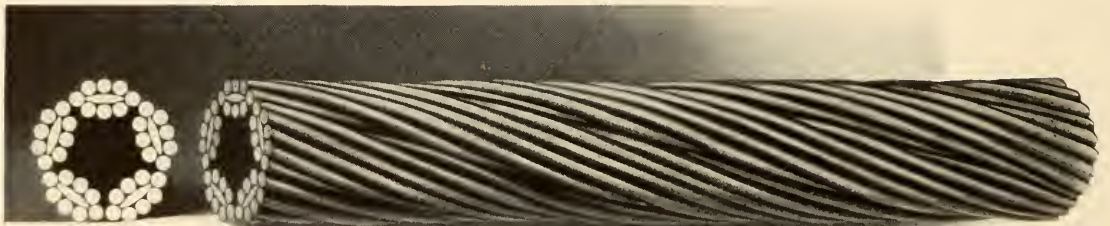

**Type C—5 Strands
9 Wires—1 Hemp Core**

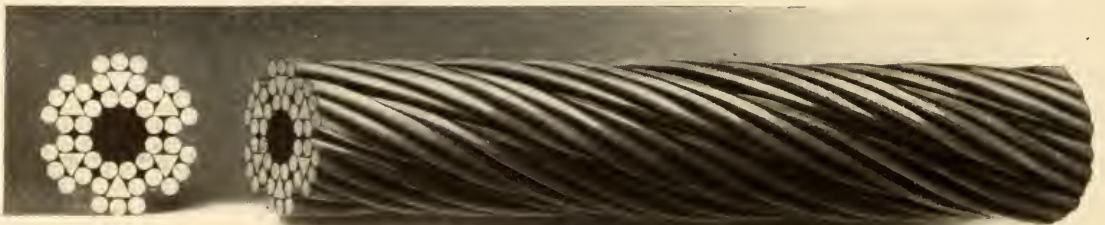

**Type D—6 Strands
8 Wires—1 Hemp Core**



**Type E—5 Strands
11 Wires—1 Hemp Core**

Flattened Strand Haulage Ropes

Type C—5 Strands—9 Wires to the Strand—1 Hemp Core

Type D—6 Strands—8 Wires to the Strand—1 Hemp Core

Type E—5 Strands—11 Wires to the Strand—1 Hemp Core



Type C



Type D



Type E

These ropes are primarily designed to give increased wearing surface above that to be obtained from a round strand rope.

There are three types of this class of rope and four qualities, namely:

1. *Iron*
2. *Crucible Cast Steel*
3. *Extra Strong Crucible Cast Steel*
4. *Monitor or Improved Plow Steel*

Their several uses are detailed under the respective lists.

These ropes are always made Lang's lay.

Flattened Strand Iron Haulage or Transmission Rope

Type C—5 Strands—9 Wires to the Strand—1 Hemp Core

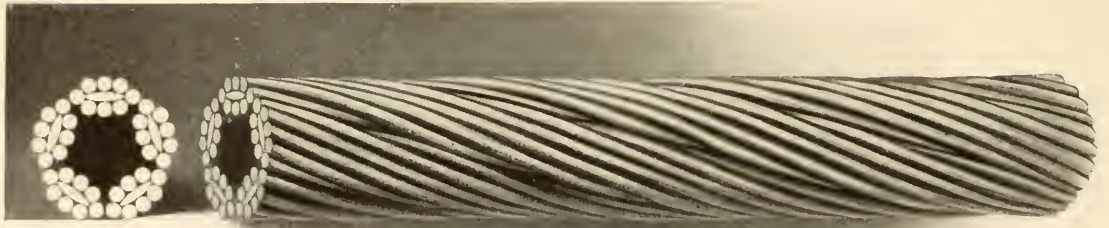

Type C

Diameter in Inches	List Price per Foot	Approximate Strength in Tons of 2000 Pounds	Proper Working Load in Tons of 2000 Pounds	Approximate Weight per Foot in Pounds	Diameter of Drum or Sheave in Feet Advised
1¼	\$0.45	23	4.6	2.55	9½
1⅛	.36½	19	3.8	2.05	8½
1	.29	15	3.0	1.65	7¾
¾	.22	12	2.4	1.24	6¾
¾	.17½	8.8	1.76	.92	6
⅝	.12½	6	1.2	.64	4¾
½	.08¼	3.7	.74	.40	3½

This rope is not used very much on account of the greater strength possessed by crucible cast steel, but the figures are given for comparison with the other different qualities which may be made.

Flattened Strand Crucible Cast Steel Haulage or Transmission Rope

Type C—5 Strands—9 Wires to the Strand—1 Hemp Core

Type D—6 Strands—8 Wires to the Strand—1 Hemp Core

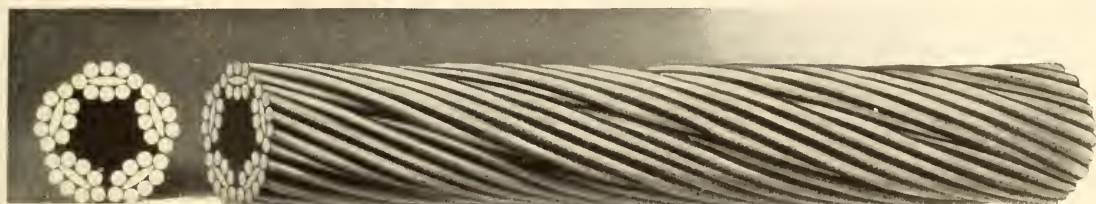

Type C



Type D

Diameter in Inches	List Price per Foot	Type C			Type D			Diameter of Drum or Sheave in Feet Advised
		Approx. Strength in Tons of 2000 Pounds	Proper Working Load in Tons of 2000 Pounds	Approx. Weight per Foot in Pounds	Approx. Strength in Tons of 2000 Pounds	Proper Working Load in Tons of 2000 Pounds	Approx. Weight per Foot in Pounds	
1½	\$0.75	63	12.6	3.65	68	13.6	4.00	8½
1⅜	.64	53	10.6	3.10	57	11.4	3.45	8
1¼	.54	46	9.2	2.55	50	10	2.80	7¼
1⅓	.45	37	7.4	2.05	40	8	2.30	6¼
1	.35	31	6.2	1.65	34	6.8	1.80	5¾
¾	.275	24	4.8	1.24	26	5.2	1.38	5
¾	.205	18.6	3.72	.92	20	4	1.00	4½
⅝	.14	13	2.6	.64	14	2.8	.72	3½
½	.10	7.7	1.54	.40	8.3	1.66	.45	2½
⅜	.07	4.6	.92	.23	5	1	.25	2

Type D is the stronger of the two constructions and is used in logging, coal dock haulage and similar places. Although it is more expensive than round strand rope it is considered more economical by some rope users on account of its longer service under certain conditions. Type C is the older type and not used so much as type D. Always made Lang's lay.

Add 10 per cent. for wire center for Type D.

Flattened Strand Extra Strong Crucible Cast Steel Haulage or Transmission Rope

Type C—5 Strands—9 Wires to the Strand—1 Hemp Core
Type D—6 Strands—8 Wires to the Strand—1 Hemp Core

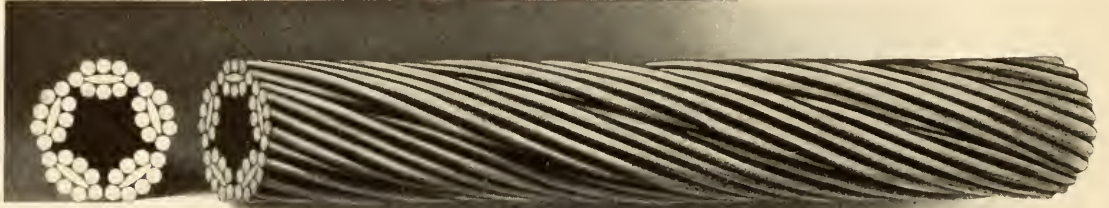

Type C



Type D

Diameter in Inches	List Price per Foot	Type C			Type D			Diameter of Drum or Sheave in Feet Advised
		Approx. Strength in Tons of 2000 Pounds	Proper Working Load in Tons of 2000 Pounds	Approx. Weight per Foot in Pounds	Approx. Strength in Tons of 2000 Pounds	Proper Working Load in Tons of 2000 Pounds	Approx. Weight per Foot in Pounds	
1½	\$0.93	73	14.6	3.65	79	15.8	4.00	8½
1⅓	.80	63	12.6	3.10	68	13.6	3.45	8
1¼	.68	54	10.8	2.55	58	11.6	2.80	7¼
1⅛	.54	43	8.6	2.05	46	9.2	2.30	6¼
1	.45	35	7.0	1.65	38	7.6	1.80	5¾
¾	.35	28	5.6	1.24	30	6.0	1.38	5
¾	.27	21	4.2	.92	22.7	4.54	1.00	4½
⅝	.18	14.5	2.9	.64	15.7	3.14	.72	3½
½	.14	8.85	1.77	.40	9.6	1.92	.45	2½
⅜	.11	5.25	1.05	.23	5.7	1.14	.25	2

This is a stronger rope than crucible cast steel and may be used for heavier loads, as shown by table above. Type D is the most popular construction and is frequently used on coal dock roads and similar places. Always made Lang's lay.

Add 10 per cent. for wire center for Type D.

Flattened Strand Monitor Plow Steel Haulage or Transmission Rope

Type C—5 Strands—9 Wires to the Strand—1 Hemp Core

Type D—6 Strands—8 Wires to the Strand—1 Hemp Core

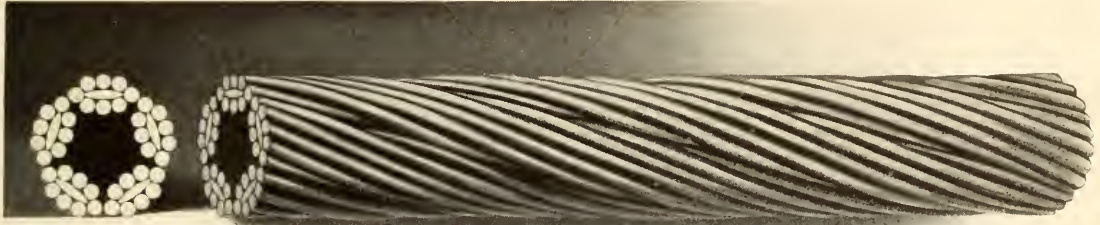

Type C



Type D

Diameter in Inches	List Price per Foot	Type C			Type D			Diameter of Drum or Sheave in Feet Advised
		Approx. Strength in Tons of 2000 Pounds	Proper Working Load in Tons of 2000 Pounds	Approx. Weight per Foot in Pounds	Approx. Strength in Tons of 2000 Pounds	Proper Working Load in Tons of 2000 Pounds	Approx. Weight per Foot in Pounds	
1¼	\$0.88	67	13.4	2.55	73	14.6	2.80	9¼
1⅓	.70	52	10.4	2.05	56	11.2	2.30	8
1	.58	42	8.4	1.65	46	9.2	1.80	6¾
¾	.44	33	6.6	1.24	36	7.2	1.38	6
¾	.35	25	5.0	.92	27	5.4	1.00	5¼
⅝	.25	17½	3.5	.64	19	3.8	.72	4½
½	.16¼	11	2.2	.40	11.9	2.38	.45	3¾

This is the strongest flattened strand haulage rope made and is used principally in type D for some coal dock haulage roads and in small sizes for logging. Always made Lang's lay.

Add 10 per cent. for wire center for Type D.

Flattened Strand Hoisting Ropes

Type A—5 Strands—28 Wires to the Strand—1 Hemp Core

Type B—6 Strands—25 Wires to the Strand—1 Hemp Core

Flattened strand hoisting ropes are made in two types, known as type A and type B; type A being the older construction and type B the newer one.

These ropes compare in flexibility with the standard hoisting rope shown on page 126. They possess, however, about 150 per cent greater wearing surface than the round strand ropes of the same diameter, and they have been used generally in the same places.

Type A is made in four grades, as follows:

1. *Iron*
2. *Crucible Cast Steel*
3. *Extra Strong Crucible Cast Steel*
4. *Monitor or Improved Plow Steel*

Type B is made in three grades, as follows:

1. *Crucible Cast Steel*
2. *Extra Strong Crucible Cast Steel*
3. *Monitor or Improved Plow Steel*

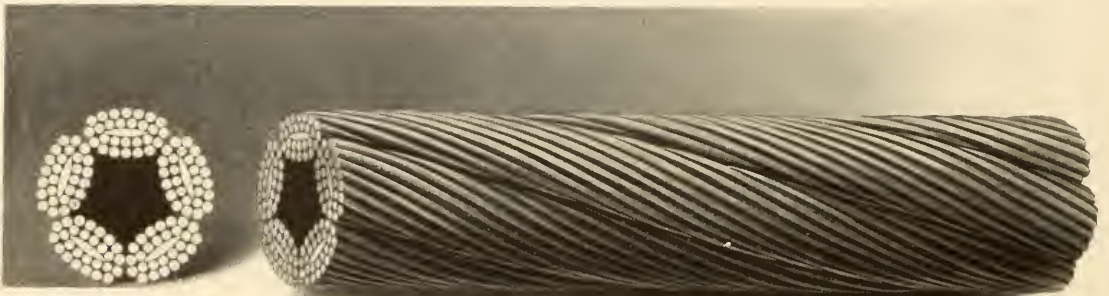

Type A



Type B

Flattened Strand Iron Hoisting Rope

Type A—5 Strands—28 Wires to the Strand—1 Hemp Core

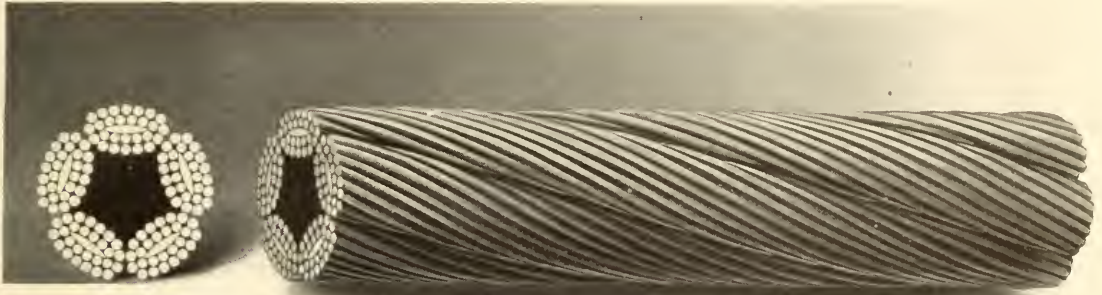

Type A

Diameter in Inches	List Price per Foot	Approximate Strength in Tons of 2000 Pounds	Proper Working Load in Tons of 2000 Pounds	Approximate Weight per Foot in Pounds	Diameter of Drum or Sheave in Feet Advised
2¼	\$1.52	72	14.4	8.00	11¼
2	1.20	55	11	6.30	10¾
1¾	1.04	44	8.8	4.85	9
1⅝	.82	38	7.6	4.15	7½
1½	.74	33	6.6	3.55	6¾
1⅜	.625	28	5.6	3.00	6¼
1¼	.52	22.8	4.56	2.45	5¾
1⅓	.43	18.6	3.72	2.00	5¼
1	.34	14.5	2.90	1.58	4¾
¾	.26	11.8	2.36	1.20	4
¾	.21	8.5	1.70	.89	3½
⅝	.155	6.0	1.20	.62	3
⅘	.13	4.7	.94	.50	2½
⅙	.105	3.9	.78	.39	2
½	.105	3.9	.78	.39	2
⅜	.095	2.4	.48	.22	1

The use of this type of rope is confined almost entirely to elevators, but it is not used as largely as the iron hoisting rope shown on page 127. These ropes are always made Lang's lay.

Flattened Strand Crucible Cast Steel Hoisting Rope

Type A—5 Strands—28 Wires to the Strand—1 Hemp Core

Type B—6 Strands—25 Wires to the Strand—1 Hemp Core

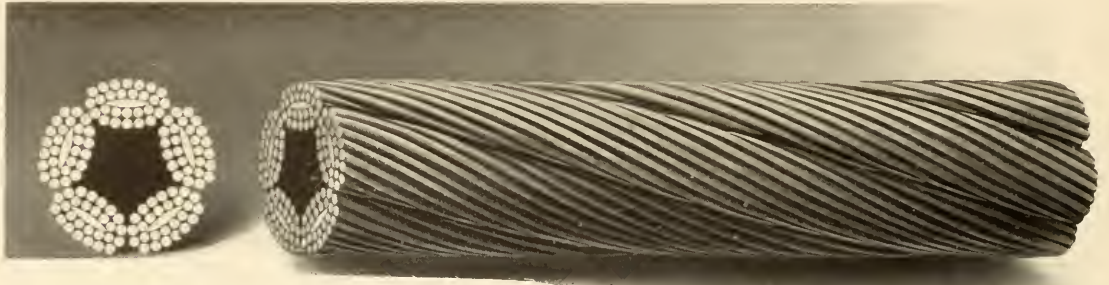

Type A

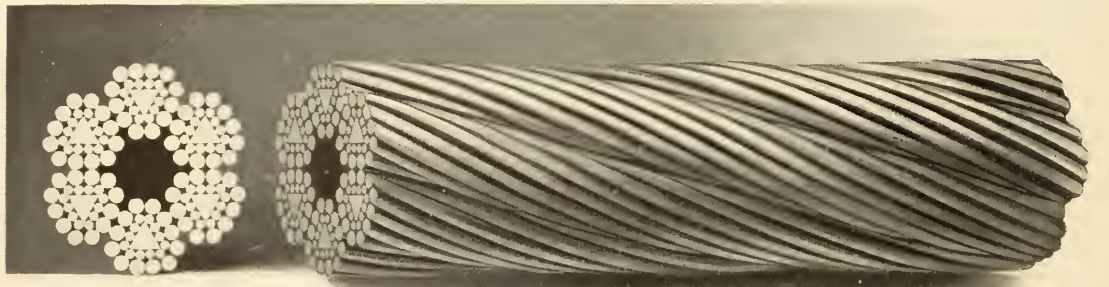

Type B

Diameter in Inches	List Price per Foot	Type A			Type B			Diameter of Drum or Sheave in Feet Advised
		Approx. Strength in Tons of 2000 Pounds	Proper Working Load in Tons of 2000 Pounds	Approx. Weight per Foot in Pounds	Approx. Strength in Tons of 2000 Pounds	Proper Working Load in Tons of 2000 Pounds	Approx. Weight per Foot in Pounds	
2¼	\$1.82	133	26.6	8.00	146	29.2	9.20	8½
2	1.44	106	21.2	6.30	117	23.4	7.25	8
1¾	1.21	85	17.0	4.85	94	18.8	5.60	7¼
1⅝	.96	72	14.4	4.15	79	15.8	4.75	6¼
1½	.86	64	12.8	3.55	70	14.0	4.00	5¾
1⅜	.73	56	11.2	3.00	62	12.4	3.45	5½
1¼	.595	47	9.4	2.45	52	10.4	2.80	5
1⅛	.50	38	7.6	2.00	42	8.4	2.30	4½
1	.395	30	6.0	1.58	33	6.6	1.80	4
¾	.30	23	4.6	1.20	25	5.0	1.38	3½
¾	.24	17.5	3.5	.89	19.3	3.86	1.00	3
⅝	.18¼	12.5	2.5	.62	13.8	2.76	.72	2¼
⅞	.165	10	2	.50	11	2.2	.58	1¾
½	.145	8.4	1.68	.39	9.3	1.86	.45	1½

Type A is more frequently used in the sizes smaller than one inch, although occasionally used in the larger sizes as well. Type B is used in all sizes for coal hoisting, dredging, etc. This rope is always made Lang's lay.

Add 10 per cent. for wire center for Type B.

Flattened Strand Extra Strong Crucible Cast Steel Hoisting Rope

Type A—5 Strands—28 Wires to the Strand—1 Hemp Core
 Type B—6 Strands—25 Wires to the Strand—1 Hemp Core

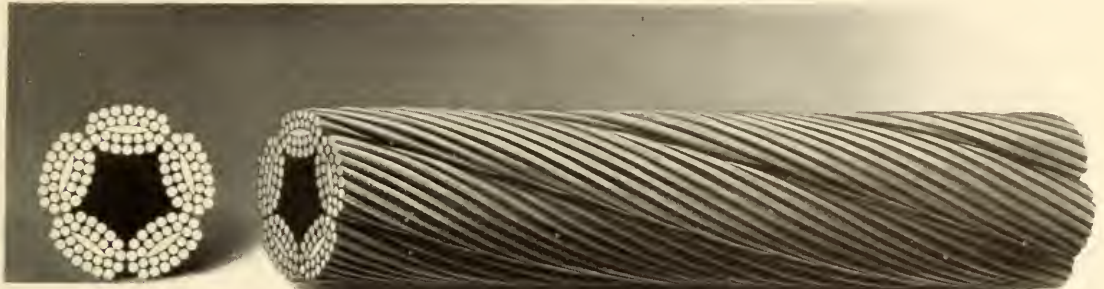

Type A



Type B

Diameter in Inches	List Price per Foot	Type A			Type B			Diameter of Drum or Sheave in Feet Advised
		Approx. Strength in Tons of 2000 Pounds	Proper Working Load in Tons of 2000 Pounds	Approx. Weight per Foot in Pounds	Approx. Strength in Tons of 2000 Pounds	Proper Working Load in Tons of 2000 Pounds	Approx. Weight per Foot in Pounds	
2¼	\$2.20	160	32	8.00	176	35.2	9.20	8½
2	1.77	123	24.6	6.30	135	27	7.25	8
1¾	1.55	99	19.8	4.85	109	21.8	5.60	7¼
1⅝	1.30	83	16.6	4.15	91	18.2	4.75	6¼
1½	1.05	73	14.6	3.55	80	16	4.00	5¾
1⅜	.90	64	12.8	3.00	70	14	3.45	5½
1¼	.70	53	10.6	2.45	58	11.6	2.80	5
1⅛	.59	43	8.6	2.00	47	9.4	2.30	4½
1	.48	34	6.8	1.58	37	7.4	1.80	4
¾	.38	26	5.2	1.20	29	5.8	1.38	3½
¾	.30	20.2	4.04	.89	22.2	4.44	1.00	3
⅝	.225	14	2.80	.62	15.4	3.08	.72	2¼
⅜	.195	11.2	2.24	.50	12.3	2.46	.58	1¾
½	.175	9.2	1.84	.39	10.1	2.02	.45	1½

Types A and B are made and both have the same general uses as Crucible Cast Steel except that somewhat heavier loads may be handled than with the Crucible Cast Steel. This rope is always made Lang's lay.

Add 10 per cent. for wire center for Type B.

Flattened Strand Monitor Plow Steel Hoisting Rope

Type A—5 Strands—28 Wires to the Strand—1 Hemp Core

Type B—6 Strands—25 Wires to the Strand—1 Hemp Core

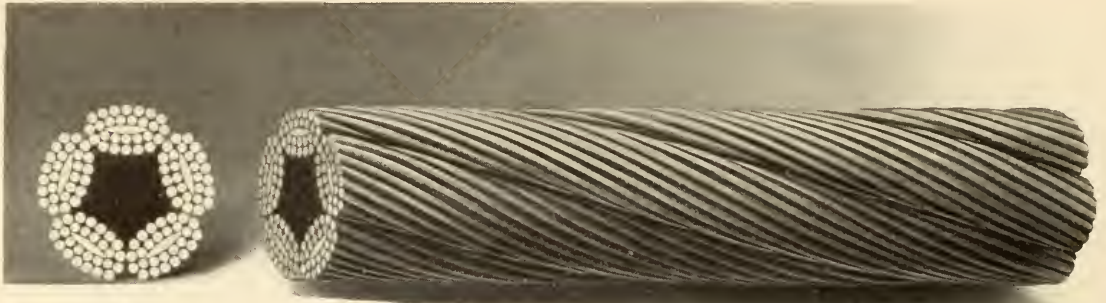

Type A

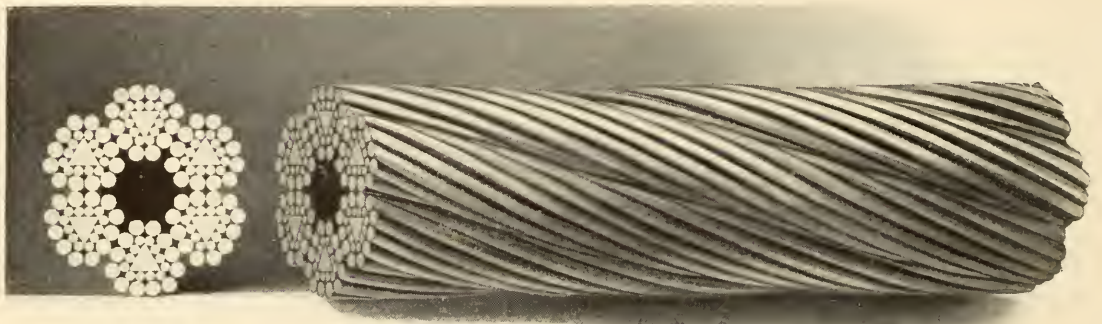

Type B

Diameter in Inches	List Price per Foot	Type A			Type B			Diameter of Drum or Sheave in Feet Advised
		Approx. Strength in Tons of 2000 Pounds	Proper Working Load in Tons of 2000 Pounds	Approx. Weight per Foot in Pounds	Approx. Strength in Tons of 2000 Pounds	Proper Working Load in Tons of 2000 Pounds	Approx. Weight per Foot in Pounds	
2¼	\$2.85	210	42	8.00	231	46.2	9.20	12
2	2.25	166	33.2	6.30	183	36.6	7.25	11
1¾	2.08	133	26.6	4.85	146	29.2	5.60	9
1½	1.56	110	22	4.15	121	24.2	4.75	8½
1½	1.37	98	19.6	3.55	108	21.6	4.00	8
1⅜	1.12	84	16.8	3.00	92	18.4	3.45	7½
1¼	.89	69	13.8	2.45	76	15.2	2.80	7
1⅓	.71	56	11.2	2.00	62	12.4	2.30	6
1	.60	45	9	1.58	50	10.0	1.80	5
¾	.49	35	7	1.20	39	7.8	1.38	4½
¾	.375	26.3	5.26	.89	29	5.8	1.00	4
⅝	.28	19	3.8	.62	21	4.2	.72	3½
⅜	.25	14.5	2.9	.50	16	3.2	.58	3
½	.20¾	12.1	2.42	.39	13.3	2.7	.45	2¾

This is the strongest rope of this construction that is made, and it is particularly adapted for dredging and heavy hoisting. Type B is preferable to type A. This rope is always made Lang's lay.

Add 10 per cent. for wire center for Type B.

Tiller Rope or Hand Rope

6 Strands of 42 Wires Each—252 Wires in All—7 Hemp Cores

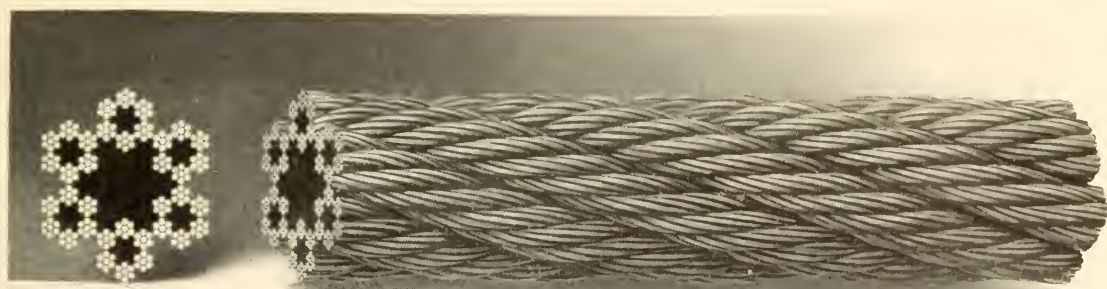

Diameter in Inches	Circumference in Inches	List Price per Foot		Approximate Weight per Foot in Pounds	Diameter of Drum or Sheave in Inches Advised	Approximate Breaking Strength	
		Iron	Crucible Cast Steel			Iron, Lbs.	Crucible Cast Steel, Lbs.
1	3	\$0.33	\$0.43	1.10	24	22,000	35,000
$\frac{7}{8}$	$2\frac{3}{4}$.27	.36	.84	21	15,500	26,000
$\frac{3}{4}$	$2\frac{1}{4}$.22	.30	.62	18	11,000	18,000
$\frac{5}{8}$	2	.17	.24	.43	15	7,000	13,500
$\frac{9}{16}$	$1\frac{3}{4}$.14	.20	.35	$13\frac{1}{2}$	6,300	11,000
$\frac{1}{2}$	$1\frac{1}{2}$.11 $\frac{1}{2}$.17	.28	12	5,800	9,000
$\frac{7}{16}$	$1\frac{1}{4}$.10	.15	.21	$10\frac{1}{2}$	4,000	6,500
$\frac{3}{8}$	$1\frac{1}{8}$.09	.14	.16	9	3,000	4,800
$\frac{5}{16}$	1	.08	.12 $\frac{1}{2}$.11	$7\frac{1}{2}$	1,900	3,600
$\frac{1}{4}$	$\frac{3}{4}$.07 $\frac{1}{2}$.11	.07	6	1,300	2,500

The wires in this rope are very fine, and should not be subjected to much abrasive wear.

It is used to a limited extent for steering lines on yachts and motor boats. Galvanized Crucible Cast Steel Yacht Rope, 6 strands, 19 wires to the strand, 1 hemp core, is preferred by many for motor boats.

Three-eighths and one-half-inch diameter Iron Tiller or Hand Rope is used for starting and stopping elevators. This rope is also called Elevator Shipper Rope.

Tiller Rope of tinned or galvanized iron or steel is furnished if required. For this rope add 10 per cent to the foregoing list prices.

American Non-spinning Hoisting Rope

18 Strands—Composed of 7 Wires Each—1 Hemp Core

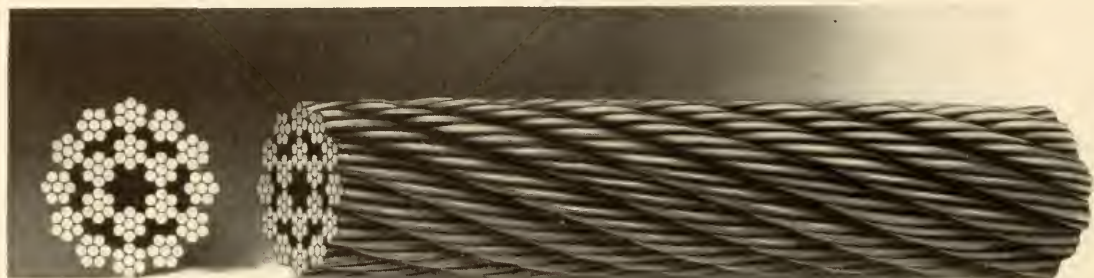

Side View of American Non-spinning Rope, Showing Exact Lay of Inside and Outside Wires

Non-spinning Hoisting Rope is constructed as follows: First, 6 strands of 7 wires each, Lang's lay (wires in the strands and strands themselves twisted to the left), are laid around a hemp core; second, these strands are then covered with an outer layer composed of 12 strands, 7 wires, Regular lay (wires in the strands twisted to the left and strands themselves twisted to the right).

The real object of this combination of lays is to prevent a free load suspended on the end of a single line from rotating. The spinning of a load endangers the lives of employees, and the constant attention required to guide the load in its ascent not only means extra trouble but expense as well.

We recommend this type of rope for "back-haul" or single line derricks; also for shaft sinking and mine hoisting where bucket or cage swings free without guides.

Non-spinning Rope works best where it does not overwind on drum.

Either a closed socket or an open socket makes the best fastening on the end of Non-spinning Rope. See pages 206 and 207.

These may be fastened in the same manner as any rope socket, but great care must be taken in attaching the socket to the rope to see that the strands do not untwist or allow any slack to work back into the rope. It is best to seize the end of the rope tightly for a distance of 4 or 5 inches just outside of the socket until the socketing is completed, when it may be taken off. Whenever possible, it would be advisable for customers to have us attach the socket at our factory to ensure the best possible results.

This rope is made in five qualities or strengths, as follows:

1. *Iron*
2. *Crucible Cast Steel*
3. *Extra Strong Crucible Cast Steel*
4. *Plow Steel*
5. *Monitor or Improved Plow Steel*

Non-spinning Iron Hoisting Rope

Standard Strengths, Adopted May 1, 1910

18 Strands—7 Wires Each—1 Hemp Core

Patented



List Price per Foot	Diameter in Inches	Approximate Circumference in Inches	Weight per Foot in Pounds	Approximate Breaking Stress in Tons of 2000 Pounds	Proper Working Load in Tons of 2000 Pounds	Diameter of Drum or Sheave in Feet Advised
\$0.80	1 3/4	5 1/2	5.50	45.80	9.1	7.00
.65	1 5/8	5	4.90	39.80	7.9	6.50
.57	1 1/2	4 3/4	4.32	34.00	6.8	6.00
.49	1 3/8	4 1/4	3.60	28.20	5.6	5.50
.40	1 1/4	4	2.80	23.40	4.6	5.00
.33	1 1/8	3 1/2	2.34	19.60	3.9	4.50
.26	1	3	1.73	14.95	2.9	4.00
.20	7/8	2 3/4	1.44	11.95	2.3	3.50
.16	3/4	2 1/4	1.02	8.85	1.7	3.00
.12	5/8	2	.70	5.90	1.1	2.50
.10	9/16	1 3/4	.87	4.85	.97	2.25
.08 1/2	1/2	1 1/2	.42	3.65	.73	2.00
.07 1/2	7/16	1 1/4	.31	2.63	.52	1.75
.07	3/8	1 1/8	.25	2.10	.42	1.50

This grade of rope is not used very much, but figures given are largely for comparative purposes.

Non-spinning Crucible Cast Steel Hoisting Rope

Standard Strengths, Adopted May 1, 1910

18 Strands—7 Wires Each—1 Hemp Core

Patented



List Price per Foot	Diameter in Inches	Approximate Circumference in Inches	Weight per Foot in Pounds	Approximate Breaking Stress in Tons of 2000 Pounds	Proper Working Load in Tons of 2000 Pounds	Diameter of Drum or Sheave in Feet Advised
\$0.90	1 $\frac{3}{4}$	5 $\frac{1}{2}$	5.50	85.90	17.1	7.00
.77	1 $\frac{5}{8}$	5	4.90	74.40	14.8	6.50
.66	1 $\frac{1}{2}$	4 $\frac{3}{4}$	4.32	63.80	12.7	6.00
.56	1 $\frac{3}{8}$	4 $\frac{1}{4}$	3.60	52.00	10.4	5.50
.46	1 $\frac{1}{4}$	4	2.80	43.80	8.7	5.00
.38	1 $\frac{1}{8}$	3 $\frac{1}{2}$	2.34	36.80	7.3	4.50
.31	1	3	1.73	28.00	5.6	4.00
.24	$\frac{7}{8}$	2 $\frac{3}{4}$	1.44	22.50	4.5	3.50
.19	$\frac{3}{4}$	2 $\frac{1}{4}$	1.02	16.70	3.3	3.00
.14	$\frac{5}{8}$	2	.70	11.10	2.2	2.50
.12	$\frac{9}{16}$	1 $\frac{3}{4}$.57	9.10	1.8	2.25
.11	$\frac{1}{2}$	1 $\frac{1}{2}$.42	6.90	1.3	2.00
.10	$\frac{7}{16}$	1 $\frac{1}{4}$.31	4.90	.98	1.75
.09 $\frac{1}{2}$	$\frac{3}{8}$	1 $\frac{1}{8}$.25	3.90	.78	1.50

This rope works best when used as a single end line, as it holds a load perfectly still, without untwisting. It should not be loaded as heavily as ordinary hoisting rope. It is especially adapted for single end derricks, mine shaft sinking, etc. It should not overwind on drum.

Non-spinning Extra Strong Crucible Cast Steel Hoisting Rope

Standard Strengths, Adopted May 1, 1910

18 Strands—7 Wires Each—1 Hemp Core

Patented



List Price per Foot	Diameter in Inches	Approximate Circumference in Inches	Weight per Foot in Pounds	Approximate Breaking Stress in Tons of 2000 Pounds	Proper Working Load in Tons of 2000 Pounds	Diameter of Drum or Sheave in Feet Advised
\$1.10	1 3/4	5 1/2	5.50	101.00	20.2	7.00
.94	1 5/8	5	4.90	87.60	17.5	6.50
.80	1 1/2	4 3/4	4.32	75.00	15.0	6.00
.68	1 3/8	4 1/4	3.60	62.40	12.4	5.50
.56	1 1/4	4	2.80	51.60	10.3	5.00
.46	1 1/8	3 1/2	2.34	43.20	8.6	4.50
.37	1	3	1.73	33.00	6.6	4.00
.29	7/8	2 3/4	1.44	26.50	5.3	3.50
.22	3/4	2 1/4	1.02	19.60	3.9	3.00
.16 1/2	5/8	2	.70	13.10	2.6	2.50
.14	9/16	1 3/4	.57	10.70	2.1	2.25
.12 1/2	1/2	1 1/2	.42	8.10	1.6	2.00
.11 1/2	7/16	1 1/4	.31	5.80	1.1	1.75
.11	3/8	1 1/8	.25	4.60	.92	1.50

This rope is stronger than crucible cast steel and will carry somewhat heavier loads. It works best when used as a single end line, as it holds the load perfectly still without untwisting. It should not be loaded so heavily as ordinary hoisting rope if best results are to be obtained. This rope is especially adapted for single line derricks, mine shaft sinking, etc. It should not overwind on drum.

Non-spinning Plow Steel Hoisting Rope

Standard Strengths, Adopted May 1, 1910

18 Strands—7 Wires Each—1 Hemp Core

Patented

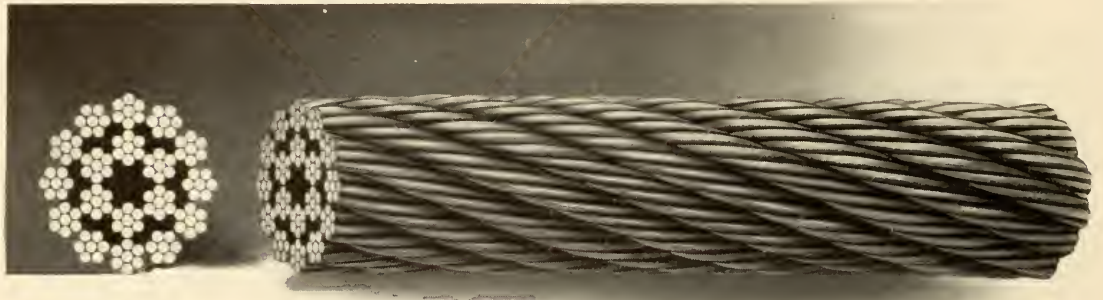

List Price per Foot	Diameter in Inches	Approximate Circumference in Inches	Weight per Foot in Pounds	Approximate Breaking Stress in Tons of 2000 Pounds	Proper Working Load in Tons of 2000 Pounds	Diameter of Drum or Sheave in Feet Advised
\$1.30	1 3/4	5 1/2	5.50	111.10	22.2	7.00
1.08	1 5/8	5	4.90	96.30	19.2	6.50
.93	1 1/2	4 3/4	4.32	82.50	16.5	6.00
.79	1 3/8	4 1/4	3.60	68.60	13.7	5.50
.65	1 1/4	4	2.80	56.80	11.3	5.00
.54	1 1/8	3 1/2	2.34	47.50	9.5	4.50
.43	1	3	1.73	36.30	7.2	4.00
.34	7/8	2 3/4	1.44	31.80	6.3	3.50
.26	3/4	2 1/4	1.02	24.60	4.9	3.00
.19	5/8	2	.70	15.75	3.1	2.50
.16	9/16	1 3/4	.57	12.80	2.5	2.25
.14	1/2	1 1/2	.42	9.75	1.9	2.00
.13	7/16	1 1/4	.31	6.85	1.3	1.75
.12 1/2	3/8	1 1/8	.25	5.55	1.1	1.50

This is a very strong rope, and capable of lifting heavy loads. It works best when used as a single end line, as it holds a load perfectly still without untwisting. It should not be loaded so heavily as ordinary hoisting rope if best results are to be obtained. This rope is especially adapted to single line derricks, mine shaft sinking, etc. It should not overwind on drum.

Non-spinning Monitor Plow Steel Hoisting Rope

Standard Strengths, Adopted May 1, 1910

18 Strands—7 Wires Each—1 Hemp Core

Patented

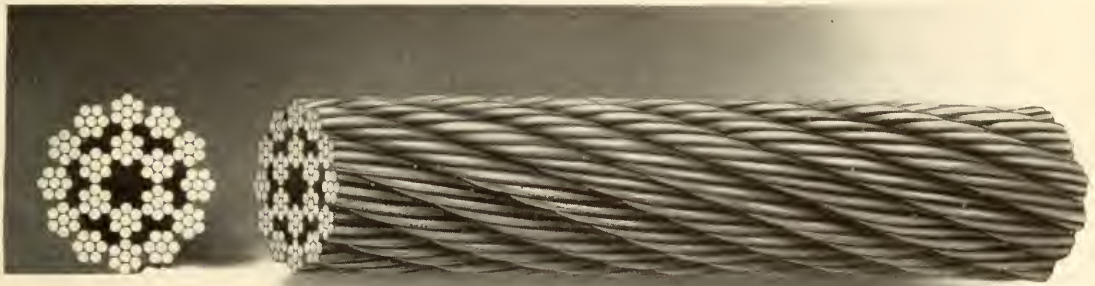

List Price per Foot	Diameter in Inches	Approximate Circumference in Inches	Weight per Foot in Pounds	Approximate Breaking Stress in Tons of 2000 Pounds	Proper Working Load in Tons of 2000 Pounds	Diameter of Drum or Sheave in Feet Advised
\$1.60	1 ³ / ₄	5 ¹ / ₂	5.50	122.00	24.4	7.00
1.10	1 ¹ / ₂	4 ³ / ₄	4.32	90.70	18.1	6.00
.90	1 ³ / ₈	4 ¹ / ₄	3.60	75.50	15.1	5.50
.75	1 ¹ / ₄	4	2.80	62.50	12.5	5.00
.62	1 ¹ / ₈	3 ¹ / ₂	2.34	52.20	10.4	4.50
.50	1	3	1.73	39.00	7.8	4.00
.39	⁷ / ₈	2 ³ / ₄	1.44	35.00	7.0	3.50
.31	³ / ₄	2 ¹ / ₄	1.02	27.00	5.4	3.00
.22 ¹ / ₂	⁵ / ₈	2	.70	17.30	3.4	2.50
.17	¹ / ₂	1 ¹ / ₂	.42	10.70	2.1	2.00
.14 ¹ / ₂	³ / ₈	1 ¹ / ₈	.25	6.10	1.2	1.50

Where the requirements are severe we recommend Monitor Plow Steel Rope. It is the strongest and most efficient rope produced.

It works best when used as a single end line, as it holds a load perfectly still without untwisting. It should not be loaded so heavily as ordinary hoisting rope if best results are to be obtained. This rope is especially adapted for single line derricks, mine shaft sinking, etc. It should not overwind on drum.

Steel Clad Hoisting Rope

6 Strands—19 Wires to the Strand—1 Hemp Core

6 Strands—37 Wires to the Strand—1 Hemp Core

6 Strands—61 Wires to the Strand—1 Hemp Core

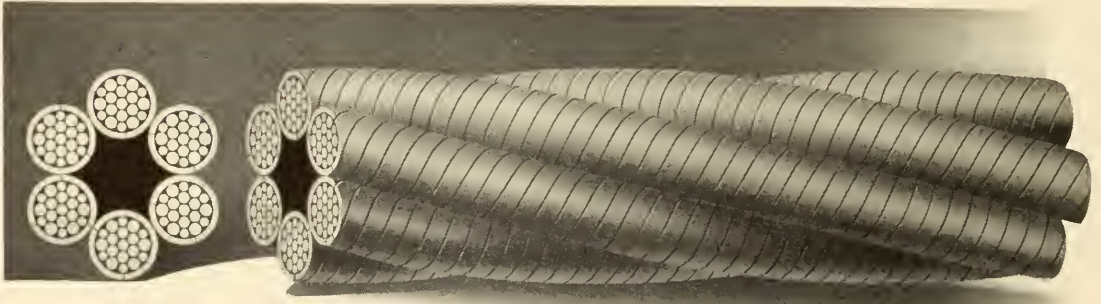

Steel Clad Ropes Are made in three constructions for the purpose of securing different degrees of flexibility. These constructions are the 6 x 19, 6 x 37 and 6 x 61 types, each of which is furnished in four grades:

1. *Crucible Cast Steel.*
2. *Extra Strong Crucible Cast Steel.*
3. *Plow Steel.*
4. *Monitor or Improved Plow Steel.*

The flat strips of steel which are wound spirally around each of the six strands composing the rope, give it additional wearing surface without sacrificing the flexibility in any way. When the outer flat steel winding is worn through in service, a complete hoisting rope remains, with unimpaired strength, the flat strip having served to protect the inner wires from all wear up to this point. The worn flat strips naturally crowd down between the strands of the rope, and in this manner they provide additional wearing surface for the rope where it runs over sheaves or drums.

These ropes are designed to meet very severe conditions of service. The increased life obtained by the use of steel clad rope easily offsets any increased first cost. In many places where conditions are suitable, additional service of from 50 to 100 per cent is frequently obtained.

Steel Clad Hoisting Rope

Crucible Cast Steel

6 Strands—19 Wires to the Strand—1 Hemp Core

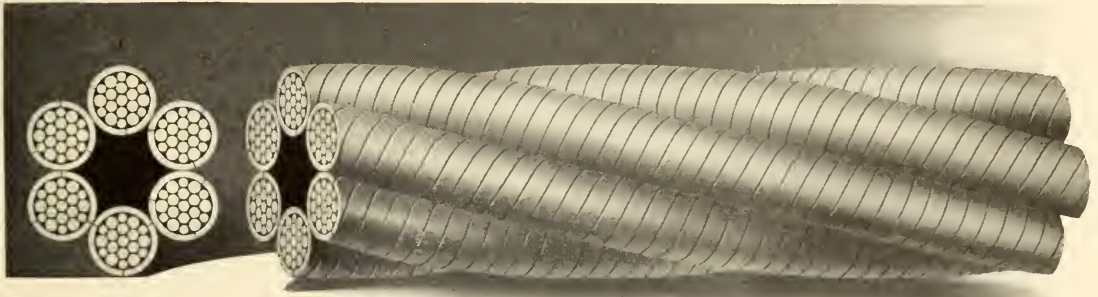

List Price per Foot	Finished Diameter over Serving in Inches	Diameter of Bare Rope in Inches	Approximate Weight per Foot in Pounds	Approximate Strength in Tons of 2000 Pounds	Proper Working Load in Tons of 2000 Pounds	Diameter of Drum or Sheave in Feet Advised
\$1.56	2 1/4	2	8.45	106	21.2	8
1.29	2	1 7/8	6.70	96	19.2	7.5
1.16	1 7/8	1 3/4	6.02	85	17.0	7
1.01	1 3/4	1 5/8	5.25	72	14.4	6.5
.89	1 5/8	1 1/2	4.62	64	12.8	6
.78	1 1/2	1 3/8	3.95	56	11.2	5.5
.67	1 3/8	1 1/4	3.30	47	9.4	5
.57	1 1/4	1 1/8	2.80	38	7.6	4.5
.49	1 1/8	1	2.12	30	6.0	4
.41	1	7/8	1.72	23	4.6	3.5
.36	7/8	3/4	1.30	17.5	3.5	3
.30	3/4	5/8	1.00	12.5	2.5	2.5
.26	5/8	1/2	.70	8.4	1.68	2

Add 10 per cent to above list prices for wire center.

Ropes of this construction may be used for unusually severe conditions of rope service where the additional wearing surface due to the flat strips spirally served, materially increases the durability of the rope thus employed. Its use is recommended particularly for dredging and similar difficult conditions of rope usage.

Steel Clad Hoisting Rope

Extra Strong Crucible Cast Steel

6 Strands—19 Wires to the Strand—1 Hemp Core

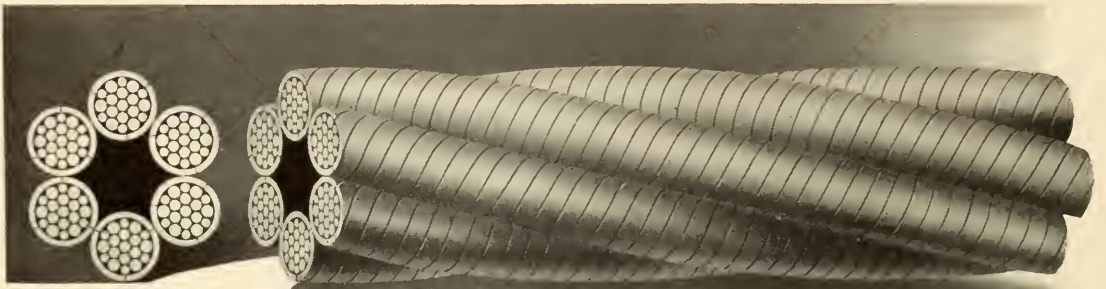

List Price per Foot	Finished Diameter over Serving in Inches	Diameter of Bare Rope in Inches	Approximate Weight per Foot in Pounds	Approximate Strength in Tons of 2000 Pounds	Proper Working Load in Tons of 2000 Pounds	Diameter of Drum or Sheave in Feet Advised
\$1.74	2¼	2	8.45	123	24.6	8
1.52	2	1⅞	6.70	112	22.4	7.5
1.36	1⅞	1¾	6.02	99	19.8	7
1.18	1¾	1⅝	5.25	83	16.6	6.5
1.03	1⅝	1½	4.62	73	14.6	6
.90	1½	1⅜	3.95	64	12.8	5.5
.77	1⅜	1¼	3.30	53	10.6	5
.65	1¼	1⅓	2.80	43	8.6	4.5
.55	1⅓	1	2.12	34	6.80	4
.46	1	⅞	1.72	26	5.20	3.5
.39	⅞	¾	1.30	20.2	4.04	3
.32	¾	⅝	1.00	14	2.80	2.5
.27	⅝	½	.70	9.2	1.84	2

Add 10 per cent to above list prices for wire center.

Ropes of this construction may be used for unusually severe conditions of rope service where the additional wearing surface due to the flat strips spirally served, materially increases the durability of the rope thus employed. Its use is recommended particularly for dredging and similar difficult conditions of rope usage.

Steel Clad Hoisting Rope

Plow Steel

6 Strands—19 Wires to the Strand—1 Hemp Core

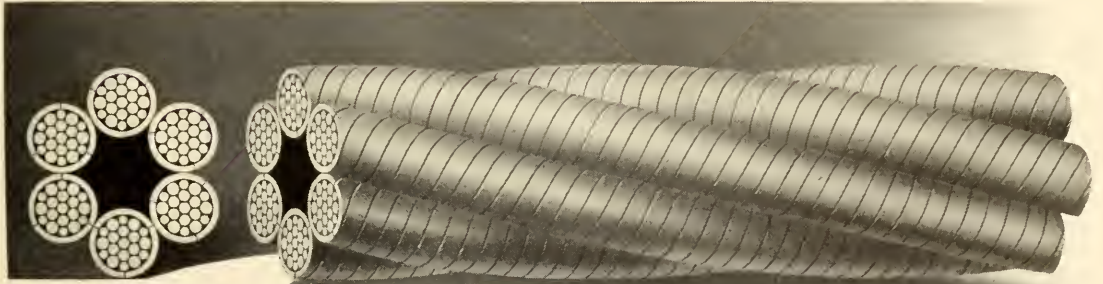

List Price per Foot	Finished Diameter over Serving in Inches	Diameter of Bare Rope in Inches	Approximate Weight per Foot in Pounds	Approximate Strength in Tons of 2000 Pounds	Proper Working Load in Tons of 2000 Pounds	Diameter of Drum or Sheave in Feet Advised
\$1.98	2 1/4	2	8.45	140	28	8
1.73	2	1 7/8	6.70	127	25	7.5
1.56	1 7/8	1 3/4	6.02	112	22	7
1.32	1 3/4	1 5/8	5.25	94	19	6.5
1.16	1 5/8	1 1/2	4.62	82	16	6
1.01	1 1/2	1 3/8	3.95	72	14	5.5
.86	1 3/8	1 1/4	3.30	58	12	5
.73	1 1/4	1 1/8	2.80	47	9.4	4.5
.61	1 1/8	1	2.12	38	7.6	4
.51	1	7/8	1.72	29	5.8	3.5
.43	7/8	3/4	1.30	23	4.6	3
.35	3/4	5/8	1.00	15.5	3.1	2.5
.29	5/8	1/2	.70	10	2.0	2

Add 10 per cent to above list prices for wire center.

Ropes of this construction may be used for unusually severe conditions of rope service where the additional wearing surface due to the flat strips spirally served, materially increases the durability of the rope thus employed. Its use is recommended particularly for dredging and similar difficult conditions of rope usage.

Steel Clad Hoisting Rope

Monitor Plow Steel

6 Strands—19 Wires to the Strand—1 Hemp Core

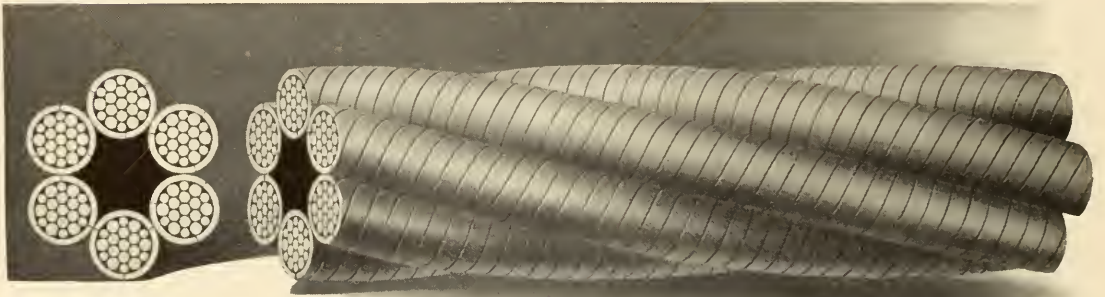

List Price per Foot	Finished Diameter over Serving in Inches	Diameter of Bare Rope in Inches	Approximate Weight per Foot in Pounds	Approximate Strength in Tons of 2000 Pounds	Proper Working Load in Tons of 2000 Pounds	Diameter of Drum or Sheave in Feet Advised
\$2.25	2 $\frac{1}{4}$	2	8.45	166	33	8
2.02	2	1 $\frac{7}{8}$	6.70	150	30	7.5
1.86	1 $\frac{7}{8}$	1 $\frac{3}{4}$	6.02	133	27	7
1.54	1 $\frac{3}{4}$	1 $\frac{5}{8}$	5.25	110	22	6.5
1.33	1 $\frac{5}{8}$	1 $\frac{1}{2}$	4.62	98	20	6
1.12	1 $\frac{1}{2}$	1 $\frac{3}{8}$	3.95	84	17	5.5
.96	1 $\frac{3}{8}$	1 $\frac{1}{4}$	3.30	69	14	5
.81	1 $\frac{1}{4}$	1 $\frac{1}{8}$	2.80	56	11	4.5
.68	1 $\frac{1}{8}$	1	2.12	45	9	4
.56	1	$\frac{7}{8}$	1.72	35	7	3.5
.48	$\frac{7}{8}$	$\frac{3}{4}$	1.30	26.3	5.3	3
.38	$\frac{3}{4}$	$\frac{5}{8}$	1.00	19	3.8	2.5
.32	$\frac{5}{8}$	$\frac{1}{2}$.70	12.1	2.4	2

Add 10 per cent to above list prices for wire center.

Ropes of this construction may be used for unusually severe conditions of rope service where the additional wearing surface due to the flat strips spirally served, materially increases the durability of the rope thus employed. Its use is recommended particularly for dredging and similar difficult conditions of rope usage.

Steel Clad, Special Flexible Hoisting Rope

Crucible Cast Steel

6 Strands—37 Wires to the Strand—1 Hemp Core

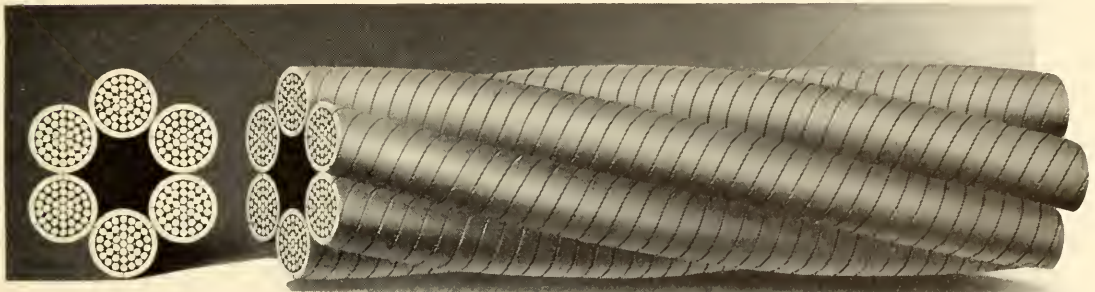

List Price per Foot	Finished Diameter over Serving in Inches	Diameter of Bare Rope in Inches	Approximate Weight per Foot in Pounds	Approximate Strength in Tons of 2000 Pounds	Proper Working Load in Tons of 2000 Pounds	Diameter of Drum or Sheave in Feet Advised
\$2.52	2¾	2½	12.05	160	32	8
2.10	2½	2¼	9.90	125	25	7
1.75	2¼	2	8.00	105	21	6
1.47	2	1¾	6.60	94	18.8	5.25
1.31	1¾	1¾	5.90	84	17	4.75
1.13	1¾	1⅝	4.90	71	14	4.25
1.02	1⅝	1½	4.30	63	12	3.75
.87	1½	1⅜	3.75	55	11	3.5
.76	1⅜	1¼	3.05	45	9	3.2
.65	1¼	1⅛	2.40	34	7	2.83
.55	1⅛	1	2.00	29	6	2.5
.45	1	⅞	1.75	23	5	2.16

Add 10 per cent to above list prices for wire center.

Ropes of this construction may be used for unusually severe conditions of rope service where the additional wearing surface due to the flat strips spirally served, materially increases the durability of the rope thus employed. Its use is recommended particularly for dredging and similar difficult conditions of rope usage.

Steel Clad, Special Flexible Hoisting Rope

Extra Strong Crucible Cast Steel

6 Strands—37 Wires to the Strand—1 Hemp Core

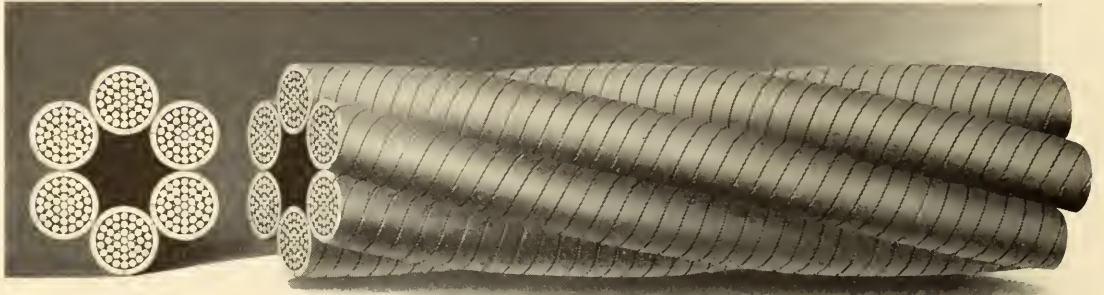

List Price per Foot	Finished Diameter over Serving in Inches	Diameter of Bare Rope in Inches	Approximate Weight per Foot in Pounds	Approximate Strength in Tons of 2000 Pounds	Proper Working Load in Tons of 2000 Pounds	Diameter of Drum or Sheave in Feet Advised
\$2.95	2 $\frac{3}{4}$	2 $\frac{1}{2}$	12.05	187	37	8
2.40	2 $\frac{1}{2}$	2 $\frac{1}{4}$	9.90	150	30	7
1.95	2 $\frac{1}{4}$	2	8.00	117	23	6
1.68	2	1 $\frac{7}{8}$	6.60	106	21.2	5.25
1.54	1 $\frac{7}{8}$	1 $\frac{3}{4}$	5.90	95	19	4.75
1.31	1 $\frac{3}{4}$	1 $\frac{5}{8}$	4.90	79	16	4.25
1.18	1 $\frac{5}{8}$	1 $\frac{1}{2}$	4.30	71	14	3.75
1.00	1 $\frac{1}{2}$	1 $\frac{3}{8}$	3.75	61	12	3.5
.86	1 $\frac{3}{8}$	1 $\frac{1}{4}$	3.05	50	10	3.2
.74	1 $\frac{1}{4}$	1 $\frac{1}{8}$	2.40	39	8	2.83
.62	1 $\frac{1}{8}$	1	2.00	32	6.4	2.5
.51	1	$\frac{7}{8}$	1.75	25	5	2.16

Add 10 per cent to above list prices for wire center.

Ropes of this construction may be used for unusually severe conditions of rope service where the additional wearing surface due to the flat strips spirally served, materially increases the durability of the rope thus employed. Its use is recommended particularly for dredging and similar difficult conditions of rope usage.

Steel Clad, Special Flexible Hoisting Rope

Plow Steel

6 Strands—37 Wires to the Strand—1 Hemp Core

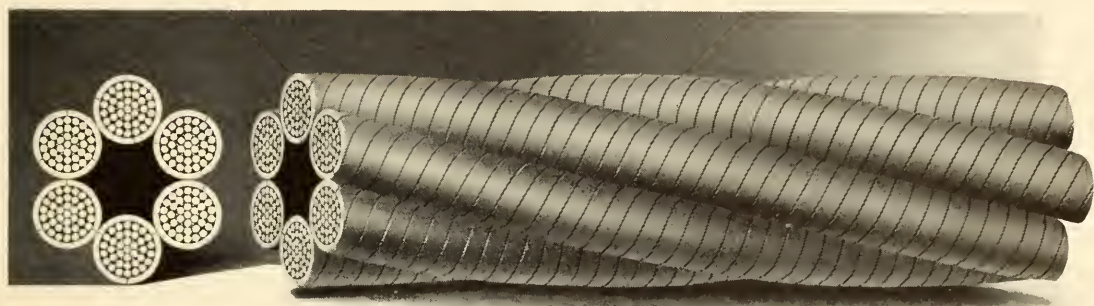

List Price per Foot	Finished Diameter over Serving in Inches	Diameter of Bare Rope in Inches	Approximate Weight per Foot in Pounds	Approximate Strength in Tons of 2000 Pounds	Proper Working Load in Tons of 2000 Pounds	Diameter of Drum or Sheave in Feet Advised
\$3.35	2 ³ / ₄	2 ¹ / ₂	12.05	214	43	8
2.70	2 ¹ / ₂	2 ¹ / ₄	9.90	175	35	7
2.20	2 ¹ / ₄	2	8.00	130	26	6
1.92	2	1 ⁷ / ₈	6.60	119	23.8	5.25
1.76	1 ⁷ / ₈	1 ³ / ₄	5.90	108	22	4.75
1.49	1 ³ / ₄	1 ⁵ / ₈	4.90	90	18	4.25
1.33	1 ⁵ / ₈	1 ¹ / ₂	4.30	80	16	3.75
1.13	1 ¹ / ₂	1 ³ / ₈	3.75	68	14	3.5
.96	1 ³ / ₈	1 ¹ / ₄	3.05	55	11	3.2
.83	1 ¹ / ₄	1 ¹ / ₈	2.40	44	9	2.83
.69	1 ¹ / ₈	1	2.00	35	7	2.5
.57	1	⁷ / ₈	1.75	27	5	2.16

Add 10 per cent to above list prices for wire center.

Ropes of this construction may be used for unusually severe conditions of rope service where the additional wearing surface due to the flat strips spirally served, materially increases the durability of the rope thus employed. Its use is recommended particularly for dredging and similar difficult conditions of rope usage.

Steel Clad, Special Flexible Hoisting Rope

Monitor Plow Steel

6 Strands—37 Wires to the Strand—1 Hemp Core

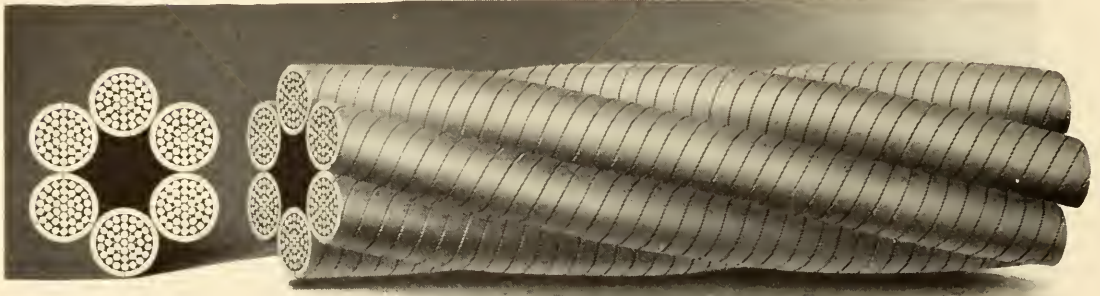

List Price per Foot	Finished Diameter over Serving in Inches	Diameter of Bare Rope in Inches	Approximate Weight per Foot in Pounds	Approximate Strength in Tons of 2000 Pounds	Proper Working Load in Tons of 2000 Pounds	Diameter of Drum or Sheave in Feet Advised
\$3.75	2 $\frac{3}{4}$	2 $\frac{1}{2}$	12.05	225	45	8
3.00	2 $\frac{1}{2}$	2 $\frac{1}{4}$	9.90	184	37	7
2.50	2 $\frac{1}{4}$	2	8.00	137	27	6
2.19	2	1 $\frac{7}{8}$	6.60	125	25	5.25
2.01	1 $\frac{7}{8}$	1 $\frac{3}{4}$	5.90	113	23	4.75
1.69	1 $\frac{3}{4}$	1 $\frac{5}{8}$	4.90	95	19	4.25
1.48	1 $\frac{5}{8}$	1 $\frac{1}{2}$	4.30	84	17	3.75
1.27	1 $\frac{1}{2}$	1 $\frac{3}{8}$	3.75	71	14	3.5
1.07	1 $\frac{3}{8}$	1 $\frac{1}{4}$	3.05	58	11	3.2
.94	1 $\frac{1}{4}$	1 $\frac{1}{8}$	2.40	46	9.2	2.83
.77	1 $\frac{1}{8}$	1	2.00	37	7.4	2.5
.63	1	$\frac{7}{8}$	1.75	29	5.8	2.16

Add 10 per cent to above list prices for wire center.

Ropes of this construction may be used for unusually severe conditions of rope service where the additional wearing surface due to the flat strips spirally served, materially increases the durability of the rope thus employed. Its use is recommended particularly for dredging and similar difficult conditions of rope usage.

Steel Clad, Extra Special Flexible Hoisting Rope

6 Strands - 61 Wires to the Strand - 1 Hemp Core

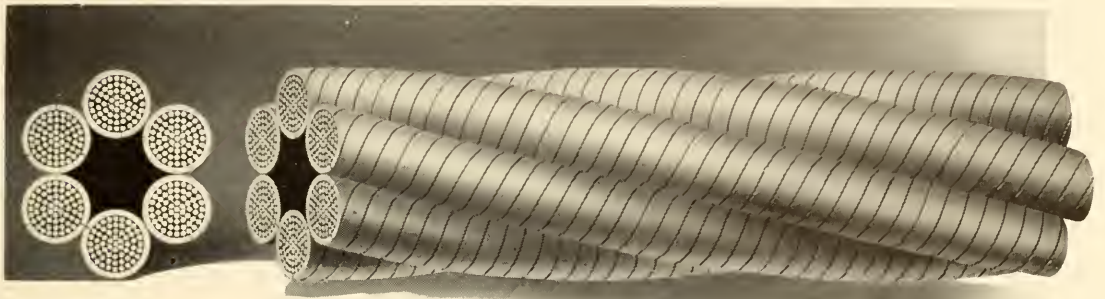

Crucible Cast Steel

List Price per Foot	Finished Diameter over Serving in Inches	Diameter of Bare Rope in Inches	Approximate Weight per Foot in Pounds	Approximate Strength in Tons of 2000 Pounds	Proper Working Load in Tons of 2000 Pounds	Diameter of Drum or Sheave in Feet Advised
\$3.90	3 1/4	3	16.80	240	48	10
3.23	3	2 3/4	14.35	200	40	9
2.71	2 3/4	2 1/2	12.05	160	32	8
2.26	2 1/2	2 1/4	9.90	125	25	7
1.88	2 1/4	2	8.45	105	21	6

Extra Strong Crucible Cast Steel

\$4.55	3 1/4	3	16.80	275	55	10
3.78	3	2 3/4	14.35	233	47	9
3.18	2 3/4	2 1/2	12.05	187	37	8
2.59	2 1/2	2 1/4	9.90	150	30	7
2.10	2 1/4	2	8.45	117	23	6

Plow Steel

\$5.10	3 1/4	3	16.80	310	62	10
4.33	3	2 3/4	14.35	265	53	9
3.62	2 3/4	2 1/2	12.05	214	43	8
2.92	2 1/2	2 1/4	9.90	175	35	7
2.38	2 1/4	2	8.45	130	26	6

Monitor Plow Steel

\$5.70	3 1/4	3	16.80	325	65	10
4.82	3	2 3/4	14.35	278	55	9
4.06	2 3/4	2 1/2	12.05	225	45	8
3.25	2 1/2	2 1/4	9.90	184	37	7
2.71	2 1/4	2	8.45	137	27	6

Add 10 per cent to above list prices for wire center.

Ropes of this construction may be used for unusually severe conditions of rope service where the additional wearing surface due to the flat strips spirally served, materially increases the durability of the rope thus employed. Its use is recommended particularly for dredging and similar difficult conditions of rope usage.

Galvanized Wire Rope

This rope is extra galvanized by our special process, which ensures adhesion of the zinc to the metal. The galvanizing does not crack, chip nor flake. Used where exposure to the weather, constant or periodical moisture, etc., are among the conditions that would tend to corrode a rope not protected in this way.

Ship's Rigging or Guy Rope



Usually made of 6 strands, 7 wires to the strand, 1 hemp core. Large sizes are sometimes constructed of 6 strands, 12 wires to the strand, 1 hemp core. Both constructions may be had in Iron, Crucible Cast Steel and Plow Steel grades, extra galvanized. Galvanized Iron Rope is used for ship's rigging, guys for derricks, smokestacks, etc.

Yacht Rigging or Guy Rope



Made of 6 strands, 7 wires to the strand, for yacht or ship's standing rigging and derrick guys, and of 6 strands, 19 wires to the strand, 1 hemp core, for running rigging and mooring lines.

Our Galvanized Crucible Cast Steel Yacht Rope, 6 strands, 7 wires to the strand, 1 hemp core, because of its light weight, strength and durability, is

now most generally employed for yacht or ship's standing rigging, and for derrick guys. When greater strength is required, we offer Galvanized Plow Steel Rope of 6 strands, 7 wires to the strand, 1 hemp core.

Flexible Galvanized Crucible Cast Steel Yacht Rope, 6 strands, 19 wires to the strand, 1 hemp core, is used for mooring and messenger or warping lines on ocean and lake steamships, steering or tiller rope on motor boats, and for straight-hauls and backstays on yachts. See Galvanized Motor Boat Cord, page 183.

Running Rope

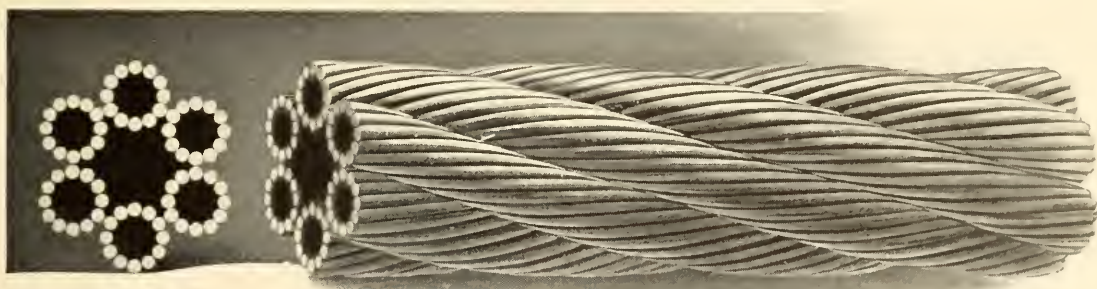

Made of 6 strands, 12 wires to the strand, 7 hemp cores, in Iron and Crucible Cast Steel grades, extra galvanized. Designed for running rigging service where great flexibility is required and exposure to moisture is frequent. This construction, however, has much less strength than Galvanized Crucible Cast Steel Yacht Rope, 6 strands, 19 wires to the strand, 1 hemp core.

Hawsers and Mooring Lines



Made of 6 strands, 12 or 24 wires to the strand, 7 hemp cores, in Crucible Cast Steel quality, extra galvanized. These lines, with a hemp core in each strand as well as in the center of the rope, are commonly called "English Hawsers or Mooring Lines," and are used chiefly on foreign ships and steamers.

Galvanized Steel Deep Sea Towing Hawsers



The construction is 6 strands, 37 wires to the strand, 1 hemp core. These hawsers are used in connection with automatic steam towing machines for sea, river and lake towing, where the greatest strength, flexibility and durability are demanded. More than 50 per cent of the wires in the strands are on the inside, so that the outside layer of wires may be considerably worn before the strength of the inside wires become impaired. Our towing hawsers have been tested under the most severe conditions of service. It is not practicable to coil wire hawsers like manila hawsers; wire hawsers should be wound onto deck reels especially designed for the purpose. See page 118.

Galvanized Iron Ship's Rigging or Guy Rope

Standard Strengths, Adopted May 1, 1910

6 Strands—7 or 12 Wires to the Strand—1 Hemp Core



List Price per Foot		Diameter in Inches	Circumference in Inches	Approximate Weight per Foot in Pounds	Approximate Strength in Tons of 2000 Pounds	Circumference of Manila Rope of Equal Strength
7 Wires per Strand	12 Wires per Strand					
\$0.44	\$0.46	1 3/4	5 1/2	4.85	42	11
.41	.43	1 11/16	5 1/4	4.42	38	10 1/2
.38	.40	1 5/8	5	4.15	35	10
.35	.37	1 1/2	4 3/4	3.55	30	9 1/2
.31 1/2	.33 1/2	1 7/8	4 1/2	3.24	28	9
.28 1/2	.30 1/2	1 3/8	4 1/4	3	26	8 1/2
.25	.26 1/2	1 1/4	4	2.45	23	8
.22 1/2	.24	1 1/8	3 3/4	2.21	19	7 1/2
.19 1/2	.21	1 1/8	3 1/2	2	18	6 1/2
.17 1/2	.18 1/2	1 1/8	3 1/4	1.77	16.1	6
.15	.16	1	3	1.58	14.1	5 3/4
.13	.	7/8	2 3/4	1.20	11.1	5 1/4
.11	.	13/16	2 1/2	1.03	9.4	5
.09	.	3/4	2 1/4	.89	7.8	4 3/4
.08	.	5/8	2	.62	5.7	4 1/2
.07	.	9/16	1 3/4	.50	4.46	3 3/4
.06	.	1/2	1 1/2	.39	3.39	3
.05	.	7/16	1 1/4	.30	2.35	2 1/2
.04 1/2	.	3/8	1 1/8	.22	1.95	2 1/4
.03 1/2	.	5/16	1	.15	1.42	2
5 Strands						
.03	.	9/32	7/8	.125	1.20	1 3/4
.02 1/2	.	1/4	3/4	.09	.99	1 1/2
.02 1/4	.	7/32	3/8	.063	.79	1 1/4
.02	.	3/16	1/2	.04	.61	1 1/8

Galvanized Crucible Cast Steel Yacht Rigging or Guy Rope

Standard Strengths, Adopted May 1, 1910

6 Strands—7 Wires to the Strand—1 Hemp Core



Flexible Galvanized Crucible Cast Steel Yacht Rope

6 Strands—19 Wires to the Strand—1 Hemp Core



List Price per Foot		Diameter in Inches	Circumference in Inches	Approximate Weight per Foot in Pounds	Approximate Strength in Tons of 2000 Pounds	Circumference of Manila Rope of Equal Strength
Guy Rope 7 Wires per Strand	Flexible Yacht Rope 19 Wires per Strand					
\$0.47	\$0.50	1¼	4	2.45	42	13
.44	.46	1 ³ / ₁₆	3¾	2.21	38	12
.39½	.41¾	1½	3½	2	34	11
.35	.38	1 ¹ / ₁₆	3¼	1.77	31	10
.31¾	.34	1	3	1.58	28	9
.24¾	.26¼	7⁄8	2¾	1.20	22	8½
.22	.23½	13⁄16	2½	1.03	19	8
.18½	.20¾	¾	2¼	.89	16.8	7
.13	.15¼	5⁄8	2	.62	11.7	6
.11	.13	9⁄16	1¾	.50	9	5¼
.08¾	.12	½	1½	.39	7	4¾
.08	.11½	15⁄32	1¾	.34	6	4½
.07	.11	7⁄16	1¼	.30	5	4¼
.06	.10¼	3⁄8	1½	.22	4.2	3¾
.04¾	.10	5⁄16	1	.15	3.2	3

In ordering, specify exact construction desired.

Galvanized Iron and Crucible Cast Steel Running Rope

Standard Strengths, Adopted May 1, 1910

6 Strands—12 Wires to the Strand—7 Hemp Cores

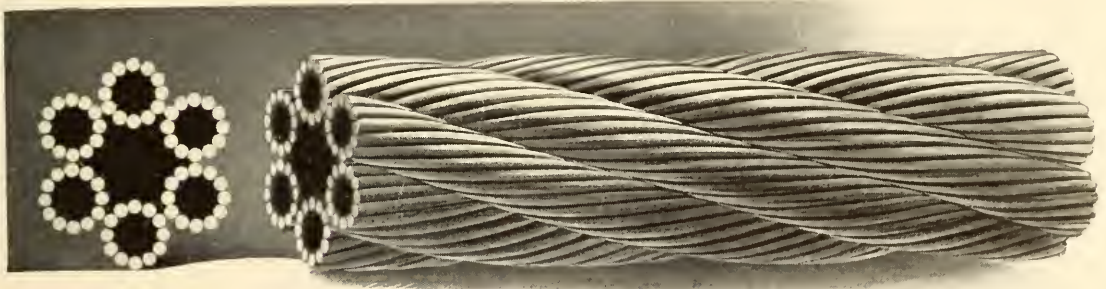

List Price per Foot		Diameter in Inches	Circumference in Inches	Approximate Weight per Foot in Pounds	Approximate Strength in Tons of 2000 Pounds	
Iron	Crucible Cast Steel				Iron	Cast Steel
\$0.22	\$0.30	$1\frac{1}{16}$	$3\frac{1}{4}$	1.18	10.1	22.5
.20	.27	1	3	1.05	8.7	19.5
.17	.23	$\frac{7}{8}$	$2\frac{3}{4}$.80	6.9	15.5
$.14\frac{1}{2}$.20	$\frac{13}{16}$	$2\frac{1}{2}$.68	6	13.5
.12	$.16\frac{1}{2}$	$\frac{3}{4}$	$2\frac{1}{4}$.59	5.1	11.5
.10	.14	$\frac{5}{8}$	2	.42	3.6	8
.08	.11	$\frac{9}{16}$	$1\frac{3}{4}$.33	2.8	6.5
.07	.09	$\frac{1}{2}$	$1\frac{1}{2}$.26	2.2	5
$.06\frac{1}{2}$	$.08\frac{1}{2}$	$\frac{7}{16}$	$1\frac{1}{4}$.20	1.7	3.9
.06	$.07\frac{3}{4}$	$\frac{3}{8}$	$1\frac{1}{8}$.14	1.3	2.85
$.05\frac{1}{2}$.07	$\frac{5}{16}$	1	.10	.82	1.98

In ordering, specify whether Iron or Crucible Cast Steel quality is desired.

Galvanized Steel Hawsers and Mooring Lines

Standard Strengths, Adopted May 1, 1910

6 Strands 12 Wires to the Strand—7 Hemp Cores



List Price per Foot	Diameter in Inches	Circumference in Inches	Approximate Weight per Foot in Pounds	Approximate Strength in Tons of 2000 Pounds	Size of Manila Hawsers of Equal Strength Circumference
\$0.78	$2\frac{1}{16}$	$6\frac{1}{2}$	4.43	83	
.72	2	$6\frac{1}{4}$	4.20	77	
.67	$1\frac{15}{16}$	6	3.89	71	
.62	$1\frac{13}{16}$	$5\frac{3}{4}$	3.42	66	
.57	$1\frac{3}{4}$	$5\frac{1}{2}$	3.23	61	13.5
.53	$1\frac{11}{16}$	$5\frac{1}{4}$	2.94	57	13
.49	$1\frac{5}{8}$	5	2.76	53	12.5
.44	$1\frac{1}{2}$	$4\frac{3}{4}$	2.36	45	12
.41	$1\frac{7}{16}$	$4\frac{1}{2}$	2.16	41	11.5
.38	$1\frac{3}{8}$	$4\frac{1}{4}$	2	38	11
.35	$1\frac{1}{4}$	4	1.63	31	10
.33	$1\frac{3}{16}$	$3\frac{3}{4}$	1.47	28	9.25
.31	$1\frac{1}{8}$	$3\frac{1}{2}$	1.33	26	8.75

For smaller sizes, see Galvanized Running Rope 6 strands, 12 wires to the strand, 7 hemp cores.

Galvanized Steel Hawsers and Mooring Lines

Standard Strengths, Adopted May 1, 1910

6 Strands—24 Wires to the Strand—7 Hemp Cores



List Price per Foot	Diameter in Inches	Circumference in Inches	Approximate Weight per Foot in Pounds	Approximate Strength in Tons of 2000 Pounds	Size of Manila Hawsers of Equal Strength Circumference
\$1.22	$2\frac{1}{16}$	$6\frac{1}{2}$	5.81	113	
1.14	2	$6\frac{1}{4}$	5.51	106	
1.06	$1\frac{15}{16}$	6	5.09	98	
1.00	$1\frac{13}{16}$	$5\frac{3}{4}$	4.48	88	
.93	$1\frac{3}{4}$	$5\frac{1}{2}$	4.24	82	
.86	$1\frac{1}{8}$	$5\frac{1}{4}$	3.86	76	
.80	$1\frac{3}{8}$	5	3.63	74	
.73	$1\frac{1}{2}$	$4\frac{3}{4}$	3.10	63	13.5
.67	$1\frac{7}{16}$	$4\frac{1}{2}$	2.92	55	13.0
.62	$1\frac{5}{8}$	$4\frac{1}{4}$	2.62	50	12.0
.57	$1\frac{1}{4}$	4	2.15	42	12.0
.51	$1\frac{3}{16}$	$3\frac{3}{4}$	1.93	38	11.0
.45	$1\frac{1}{8}$	$3\frac{1}{2}$	1.75	34	10.25
.40	$1\frac{1}{16}$	$3\frac{1}{4}$	1.54	27	9.25
.35	1	3	1.38	25	8.75
.29	$\frac{7}{8}$	$2\frac{3}{4}$	1.05	20	
.25	$\frac{13}{16}$	$2\frac{1}{2}$.90	17	
.22	$\frac{3}{4}$	$2\frac{1}{4}$.78	14	

Galvanized Steel Deep Sea Towing Hawsers

Standard Strengths, Adopted May 1, 1910

6 Strands—37 Wires to the Strand—1 Hemp Core

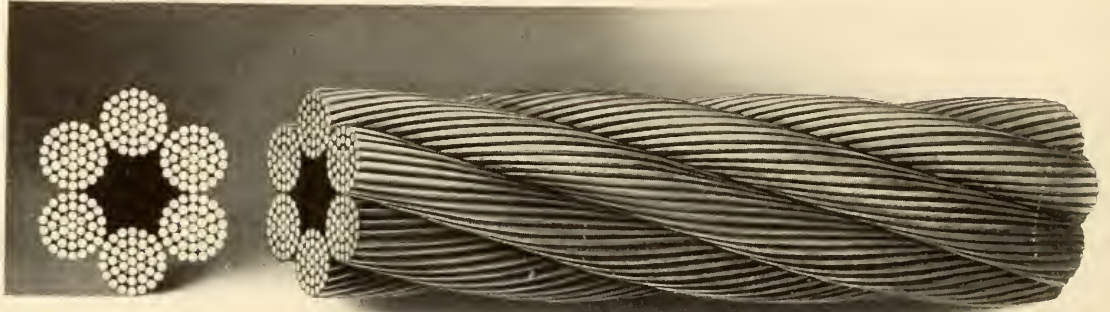

List Price per Foot	Diameter in Inches	Circumference in Inches	Approximate Weight per Foot in Pounds	Approximate Strength in Tons of 2000 Pounds
\$1.60	$2\frac{3}{8}$	$7\frac{1}{2}$	8.82	188
1.52	$2\frac{5}{16}$	$7\frac{1}{4}$	8.36	182
1.44	$2\frac{1}{4}$	$7\frac{1}{8}$	8	171
1.35	$2\frac{1}{8}$	$6\frac{3}{4}$	7.06	155
1.28	$2\frac{1}{16}$	$6\frac{1}{2}$	6.65	140
1.20	2	$6\frac{1}{4}$	6.30	132
1.12	$1\frac{15}{16}$	6	5.84	125
1.05	$1\frac{13}{16}$	$5\frac{3}{4}$	5.13	112
.98	$1\frac{3}{4}$	$5\frac{1}{2}$	4.85	104
.91	$1\frac{11}{16}$	$5\frac{1}{4}$	4.42	97
.84	$1\frac{5}{8}$	5	4.15	87
.77	$1\frac{1}{2}$	$4\frac{3}{4}$	3.55	76
.71	$1\frac{7}{16}$	$4\frac{1}{2}$	3.24	72
.65	$1\frac{3}{8}$	$4\frac{1}{4}$	3	66
.60	$1\frac{1}{4}$	4	2.45	54
.54	$1\frac{3}{16}$	$3\frac{3}{4}$	2.21	47
.48	$1\frac{1}{8}$	$3\frac{1}{2}$	2	42
.42	$1\frac{1}{16}$	$3\frac{1}{4}$	1.77	38
.37	1	3	1.58	31.5
.31	$\frac{7}{8}$	$2\frac{3}{4}$	1.20	26
.26	$\frac{13}{16}$	$2\frac{1}{2}$	1.03	22
.23	$\frac{3}{4}$	$2\frac{1}{4}$.89	20

This rope is only furnished galvanized.

Galvanized Steel Cables for Suspension Bridges

Standard Strengths, Adopted May 1, 1910

Composed of 6 Strauds, with Wire Center

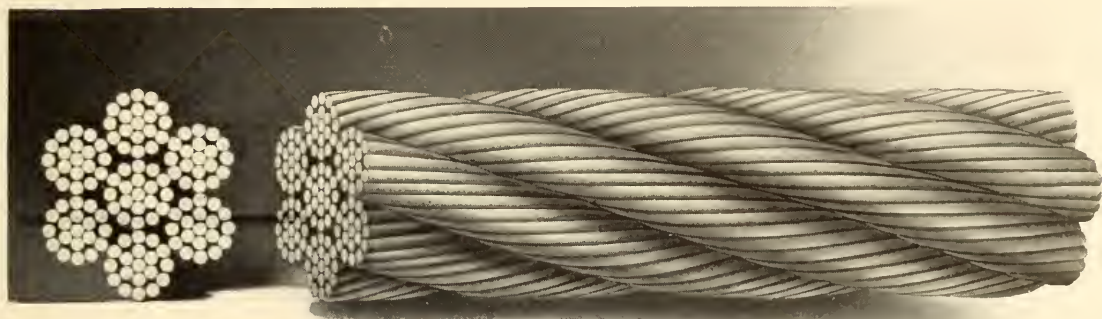

Price per Foot	Diameter in Inches	Approximate Circumference in Inches	Weight per Foot in Pounds	Approximate Breaking Stress in Tons of 2000 Pounds Plow Steel
. .	$2\frac{3}{4}$	$8\frac{5}{8}$	12.7	310
. .	$2\frac{5}{8}$	$8\frac{1}{4}$	11.6	283
. .	$2\frac{1}{2}$	$7\frac{7}{8}$	10.5	256
. .	$2\frac{3}{8}$	$7\frac{1}{2}$	9.50	232
. .	$2\frac{1}{4}$	$7\frac{1}{8}$	8.52	208
. .	$2\frac{1}{8}$	$6\frac{5}{8}$	7.60	185
. .	2	$6\frac{1}{4}$	6.73	164
. .	$1\frac{7}{8}$	$5\frac{7}{8}$	5.90	144
. .	$1\frac{3}{4}$	$5\frac{1}{2}$	5.10	124
. .	$1\frac{5}{8}$	5	4.34	106
. .	$1\frac{1}{2}$	$4\frac{3}{4}$	3.70	90
. .	$1\frac{3}{8}$	$4\frac{1}{4}$	3.10	75
. .	$1\frac{1}{4}$	4	2.57	62

We do not build or erect suspension bridges, but are prepared to supply cables fitted with special bridge sockets ready for attaching to anchorage bolts. Further particulars and prices furnished upon application.

Sash Cord

6 Strands—7 Wires to the Strand—1 Cotton Core



Trade Number	List Price per Foot			Diameter in Inches	Weight per Foot in Pounds		Approximate Breaking Stress in Pounds		
	Iron Annealed or Bright	Tinned or Galvanized Iron	Copper		Iron	Copper	Bright Iron	Annealed Iron	Bright Copper
26	\$0.03	\$0.04	\$0.09	$\frac{1}{4}$.101	.115	2200	1650	1320
27	.02 $\frac{3}{4}$.03 $\frac{1}{2}$.07 $\frac{1}{2}$	$\frac{7}{32}$.077	.087	1800	1411	1080
27 $\frac{1}{2}$.02 $\frac{1}{4}$.03	.06	$\frac{3}{16}$.056	.064	1400	1100	840
28	.01 $\frac{3}{4}$.02 $\frac{1}{4}$.04 $\frac{1}{2}$	$\frac{1}{8}$.025	.029	550	425	350
28 $\frac{1}{2}$.01 $\frac{1}{2}$.02	.03 $\frac{1}{2}$	$\frac{3}{32}$.014	.016	320	250	200
29	.01 $\frac{1}{4}$.01 $\frac{3}{4}$.03	$\frac{1}{16}$.006	.007	140	110	90

Sash cord will be made "dead soft" unless specifically ordered to the contrary. Used principally for window weights, bell cords, automobile brakes and whistles. Three thirty-seconds inch diameter Galvanized Sash Cord is used on electric open-car curtain fixtures. One-sixteenth inch Galvanized Sash Cord is used on steam car curtain fixtures.

Galvanized High Strength Aeroplane Strand



Net Prices per 100 Feet	Diameter in Inches	Number of Wires	Weight per 1000 Feet in Pounds	Breaking Strength in Pounds
\$3.75	$\frac{5}{32}$	19	51.0	3000
2.50	$\frac{1}{8}$	19	33.0	2000
1.75	$\frac{3}{32}$	19	17.0	1100
1.50	$\frac{1}{16}$	19	8.9	500
.75	$\frac{1}{32}$	7	2.3	125

Put up in coils 50, 100, 500, 1000 feet each; or on 5000 or 10,000 feet reels.

For reliable strength, light weight, flexibility, toughness and elasticity, this Galvanized High Strength Aeroplane Strand is unrivaled. This may be readily fastened and resists sudden strains and vibration better than a single stay wire. The sizes most commonly used are $\frac{1}{8}$ -inch and $\frac{3}{32}$ -inch diameter. The smaller sizes, however, are employed for light stays on the elevating and rudder frames. Approximately 600 feet of strand is required to properly guy a biplane, and about 250 feet for a monoplane.

Galvanized or Tinned Flexible Aeroplane or Motor Boat Cord

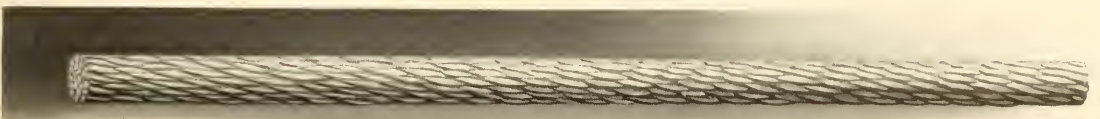

Net Prices per 100 Feet	Diameter in Inches	Construction	Weight per 1000 Feet in Pounds	Breaking Strength in Pounds
\$5.75	$\frac{3}{16}$	19 x 7	55.2	2600
5.00	$\frac{5}{32}$	19 x 7	38.5	1800
4.50	$\frac{1}{8}$	19 x 3	24.5	1150
4.00	$\frac{3}{32}$	12 x 3	15.5	725

Designed to meet the demand for a light weight, flexible steel cord, with a minimum amount of stretch, to connect the control levers or wheel with the flexible wing tips, ailerons, elevating planes and rudder on an aeroplane, or for small motor boat steering cord.

Galvanized Mast-arm or Arc Light Rope

Standard Strengths, Adopted May 1, 1910



List Price per Foot	Diameter in Inches	Weight per Foot in Pounds	Approximate Breaking Stress in Pounds	Construction
\$0.07	$\frac{1}{2}$.335	4700	9 x 7
.06	$\frac{7}{16}$.245	3400	9 x 7
.05	$\frac{3}{8}$.163	2200	9 x 7
.03 $\frac{1}{2}$	$\frac{5}{16}$.107	1530	9 x 4
.02 $\frac{3}{4}$	$\frac{1}{4}$.077	1125	9 x 4

Used for arc lights, mast-arms or other purposes where exposed to moisture. This rope is more durable than manila rope and does not shrink.

Stone Sawing Strand

3 Wires Twisted Together

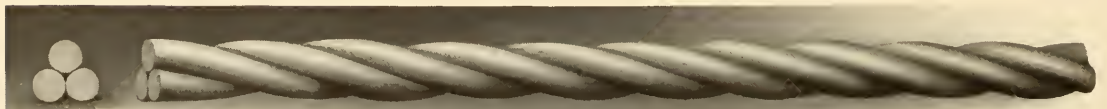

List Price per 1000 Feet	Approximate Diameter in Inches	Approximate Gage of Wire	Approximate Weight per 1000 Feet
\$13.50	.210	12	100
11.50	.184	13	70
9.50	.160	14	50
8.00	.144	15	45
6.75	.126	16	35

This is suitable for sawing blocks of sandstone or similar soft stone but should not be used for marble or granite.

Galvanized Strand

7 Steel Wires Twisted into a Single Strand

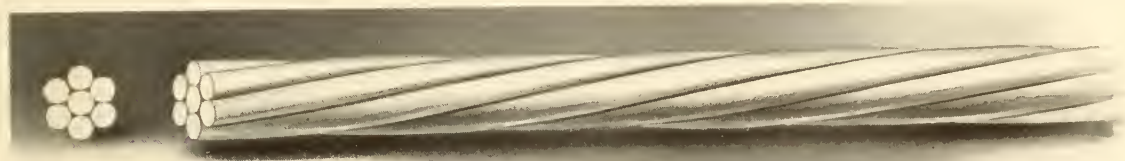

Standard Steel Strand

Galvanized or Extra Galvanized

Diameter in Inches	Seizing Strand Trade Number	Approximate Weight per 1000 Feet Pounds	Approximate Strength in Pounds	List Prices per 100 Feet
$\frac{5}{8}$..	800	14000	\$7.25
$\frac{9}{16}$..	650	11000	5.75
$\frac{1}{2}$..	510	8500	4.50
$\frac{7}{16}$..	415	6500	3.75
$\frac{3}{8}$..	295	5000	2.75
$\frac{5}{16}$..	210	3800	2.25
$\frac{1}{4}$..	125	2300	1.75
$\frac{7}{32}$..	95	1800	1.50
$\frac{3}{16}$..	75	1400	1.25
$\frac{5}{32}$..	55	900	1.15
$\frac{9}{64}$	18	40	700	1.10
$\frac{1}{8}$	19	32	500	1.00
$\frac{7}{64}$	20	25	450	.90
$\frac{3}{32}$	21	20	400	.80
$\frac{5}{64}$	22	13	300	.70

This strand is used chiefly for guying poles and smokestacks, for supporting trolley wire, and for operating railroad signals. For overhead catenary construction of suspending trolley wire, the special grades of strand are considered preferable because they possess greater strength and toughness.

The last five sizes listed are sometimes called Galvanized Seizing Strand, used for seizing or binding the ends of wire rope and thimble splices, and for tying rope into coils.

Extra Galvanized Special Strand

7 Steel Wires Twisted into a Single Strand



We manufacture three qualities of special grades of Extra Galvanized Strand that should meet all requirements for durability, strength, toughness and light weight.

Extra Galvanized Siemens-Martin Strand.

Extra Galvanized High Strength (Crucible Steel) Strand.

Extra Galvanized Extra High Strength (Plow Steel) Strand.

All three qualities are composed of 7 wires, having the heaviest coating of galvanizing that will ensure the longest life.

Extra Galvanized Siemens-Martin Strand

Diameter in Inches	Tensile Strength in Pounds	List Price per 100 Feet	Minimum Elongation Per Cent in 10 Inches	Diameter in Inches	Tensile Strength in Pounds	List Price per 100 Feet	Minimum Elongation Per Cent in 10 Inches
$\frac{5}{8}$	19,000	\$4.35	10	$\frac{1}{4}$	3,060	\$1.00	10
$\frac{1}{2}$	11,000	2.80	10	$\frac{3}{16}$	2,000	.85	10
$\frac{7}{16}$	9,000	2.30	10	$\frac{1}{8}$	900	.55	10
$\frac{3}{8}$	6,800	1.80	10				
$\frac{5}{16}$	4,860	1.48	10				
$\frac{9}{32}$	4,380	1.10	10				

Extra Galvanized High Strength Strand

$\frac{5}{8}$	25,000	\$6.25	6	$\frac{9}{32}$	7,300	\$1.75	6
$\frac{1}{2}$	18,000	3.95	6	$\frac{1}{4}$	5,100	1.50	6
$\frac{7}{16}$	15,000	3.45	6	$\frac{3}{16}$	3,300	1.30	6
$\frac{3}{8}$	11,500	2.70	6	$\frac{1}{8}$	1,500	.80	6
$\frac{5}{16}$	8,100	2.10	6				

Extra Galvanized Extra High Strength Strand

$\frac{5}{8}$	42,500	\$8.75	4	$\frac{9}{32}$	10,900	\$2.10	4
$\frac{1}{2}$	27,000	5.50	4	$\frac{1}{4}$	7,600	1.90	4
$\frac{7}{16}$	22,500	4.60	4	$\frac{3}{16}$	4,900	1.60	4
$\frac{3}{8}$	17,250	3.55	4	$\frac{1}{8}$	2,250	1.05	4
$\frac{5}{16}$	12,100	2.70	4				

When either intermediate sizes or strengths are called for, if they are exactly midway between two sizes provided for, the average price of the two sizes shall apply; otherwise the price of the nearest size and strength shall apply.

The use of special grades of Extra Galvanized Strand is constantly increasing. The principal uses to which these special grades of strands are particularly adapted are as follows:

Guy Strand Extra Galvanized Siemens-Martin Strand is now frequently used because of its strength and uniform quality, to guy electric railway, telegraph and telephone poles.

Messenger Strand The heavy lead encased telephone wire cables are not in themselves sufficiently strong, without an unusual deflection, to safely withstand the strain incident to stringing those cables between poles at considerable distances apart. It is a common practice now to stretch from pole to pole with very little sag $\frac{5}{16}$ -inch diameter Extra Galvanized Siemens-Martin Strand, $\frac{3}{8}$ -inch diameter or $\frac{7}{16}$ -inch diameter Extra Galvanized High Strength Strand, and from this "messenger strand," so called, the heavy telephone cable is suspended by means of clips, wire or cord at short intervals. The messenger strand thus sustains most of the stress due to weight of cable, wind, or ice load. We have mentioned the sizes and qualities now generally employed by the largest telephone companies. The Extra Galvanized, Extra High Strength Strand, while affording the greatest strength for its weight, is naturally stiff and springy and difficult to fasten. The common galvanized strand should never be used for messenger lines as it does not possess the requisite strength and uniform toughness of the special grades of strand.

Catenary Method of Supporting Trolley Wire In the ordinary electric railway overhead construction, the copper trolley wire dips and sags between the supporting points, which are opposite poles and from 100 to 125 feet apart. The catenary method of carrying the trolley wire consists of one or more messenger strands stretched over the center of the tracks. Every few feet along this messenger strand are pendant hangers that clamp on to the trolley wire and retain it in a rigid, straight, horizontal line, an especially desirable feature for the operating of electric cars at high speed. The catenary construction also makes it possible to space the poles at greater distances apart, but this necessarily causes great tension on the messenger strand and poles. The common galvanized strand is not suitable for this work. The selection of the best size and quality of strand depends upon the length of spans, the deflection of the messenger strand, and the weight of the trolley wire. In general, however, for a single messenger strand carrying a 4/0 copper trolley wire, we would recommend the following:

For spans 125 to 150 feet, $\frac{3}{8}$ -inch or $\frac{7}{16}$ -inch diameter Extra Galvanized Siemens-Martin Strand.

For longer spans up to 225 feet, $\frac{3}{8}$ -inch or $\frac{7}{16}$ -inch Extra Galvanized High Strength Strand.

These two qualities have been found the best for catenary work.

The messenger strand and trolley wire may be made to follow track curves by increasing the number of poles at the curve, but this is obviated by attaching to the hangers near the center of the spans what are known as "pull-off" strands. Our 1/4-inch or 5/16-inch diameter Extra Galvanized Siemens-Martin Strand is usually employed for this purpose.

For reasons already explained, the poles should be well guyed, especially at the curves, with 1/4-inch or 5/16-inch diameter extra galvanized Siemens-Martin strand.

Lightning Arrester for Transmission Lines In erecting the high tension current transmission lines, which consist of bare copper cables strung on tall steel towers, it is customary to stretch between the highest points of the towers a 3/8-inch diameter Extra Galvanized Siemens-Martin Strand, known as an "overhead ground strand." The purpose of this is to arrest lightning and convey it safely to the ground. The Extra Galvanized Siemens-Martin Strand is employed almost exclusively because it possesses greater conductivity than the other grades of high strength strand.

Long Spans in High Tension Current Transmission Line Long spans cannot be made with copper cables, because copper has a strength of only 65,000 pounds per square inch. Where it is necessary to cross rivers, lakes or bays with power transmission lines, the current is conducted through an Extra Galvanized Siemens-Martin Strand or an Extra Galvanized High Strength (crucible steel) Strand of the size and strength that will show a safety factor of at least five.

Properties of Special Grades Extra Galvanized Special Strands

Diameter of Strand in Inches	Number of Wires in Strand	Strength S. M. Strand in Tons	Strength Crucible Strand in Tons	Strength Plow Strand in Tons	Approximate Weight per Foot in Pounds
1 1/2	61	55	91.5	121	4.75
1 3/8	61	45.5	76	100	3.95
1 1/4	37	38	63.5	85	3.30
1 1/8	37	32.5	54	72	2.62
1	37	25.5	43.7	60	2.25
7/8	19	19	32	45	1.70
3/4	19	14.2	23.7	35	1.25
5/8	19	10	16.5	23.5	.81

Track Cable for Aerial Tramways

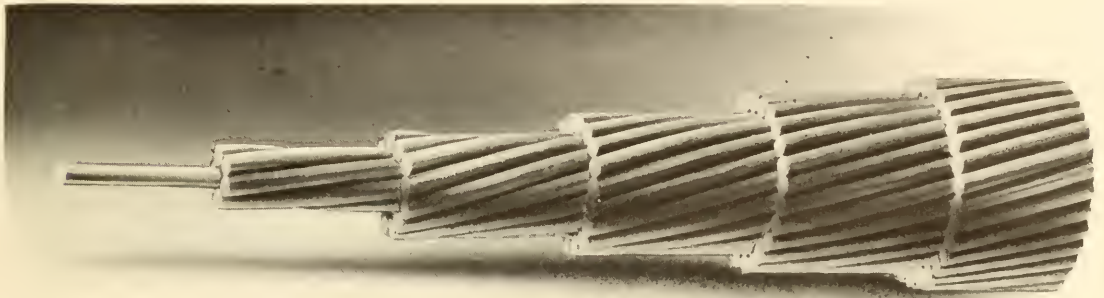

19
Wires

37
Wires

61
Wires

91
Wires

Diameter in Inches	Number of Wires in Strand	Weight per 100 Feet in Pounds	Crucible Steel		Plow Steel	
			List Prices per 100 Feet	Breaking Stress in Tons of 2000 Pounds	List Prices per 100 Feet	Breaking Stress in Tons of 2000 Pounds
2½	91	1310	\$176.00	285.00	\$246.50	335.00
2¼	91	1036	137.50	233.00	192.50	266.00
2⅛	91	935	123.25	204.00	172.50	240.00
2	61	840	115.50	185.00	161.75	218.00
1¾	61	728	101.50	161.00	142.00	189.00
1¾	61	659	87.75	145.80	122.75	171.00
1⅝	61	563	76.00	124.00	106.50	146.00
1½	37	488	68.00	108.40	95.25	127.50
1⅜	37	401	53.00	88.80	74.25	105.00
1¼	37	323	44.25	71.80	62.00	84.60
1⅛	37	270	38.25	60.00	53.50	70.70
1	19	220	31.25	49.20	43.75	58.00
¾	19	169	24.75	37.60	34.75	44.40
¾	19	124	19.00	27.60	26.50	32.50
⅝	19	86	14.75	19.20	20.75	22.30

The importance of the wire rope tramway for transporting all kinds of material makes it expedient to insert the foregoing table of two different grades of track strand. This strand is designed to give as much flexibility as possible as well as a fairly smooth surface for traveler wheels to run upon. The plow steel quality affords the greatest strength with the least weight—a very important advantage, especially in long spans. For end fastenings, see page 208.

Locked Coil Track Cable

Crucible Cast Steel

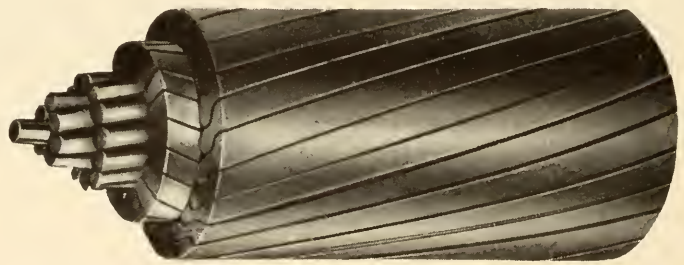
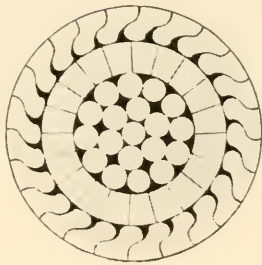

List Price per Foot	Diameter in Inches	Approximate Circumference in Inches	Approximate Weight per Foot in Pounds	Approximate Breaking Stress in Tons of 2000 Pounds
\$1.17	1 $\frac{5}{8}$	5 $\frac{1}{8}$	6.30	103
1.00	1 $\frac{1}{2}$	4 $\frac{3}{4}$	5.30	89
.85	1 $\frac{3}{8}$	4 $\frac{1}{4}$	4.40	75
.72	1 $\frac{1}{4}$	4	3.70	62
.60	1 $\frac{1}{8}$	3 $\frac{1}{2}$	3.00	50
.49	1	3	2.35	40
.37	$\frac{7}{8}$	2 $\frac{3}{4}$	1.80	30

Locked Coil Track Cable, illustrated above, is a modification of the Locked Wire Cable shown on the following page, and differs from it simply in the fewer number of wires composing it. These wires, consequently, are of larger diameter. Hence, the Locked Coil Track Cable is the stiffer of the two kinds, but it possesses sufficient flexibility to allow it to be shipped in coils from 5 feet to 6 feet in diameter. Locked Coil Track Cable is used expressly as a stationary overhead cable for aerial tramways. For such purposes it is superior in durability to any other construction and is used for the Bleichert Aerial Tramways, manufactured by us. If a cheaper track cable than the Locked Coil type is desired, the smooth coil cable shown on the preceding page may be used, but it is not as durable and its external surface is not as smooth for the carriage wheels that run upon it.

Locked Wire Cable

Crucible Cast Steel

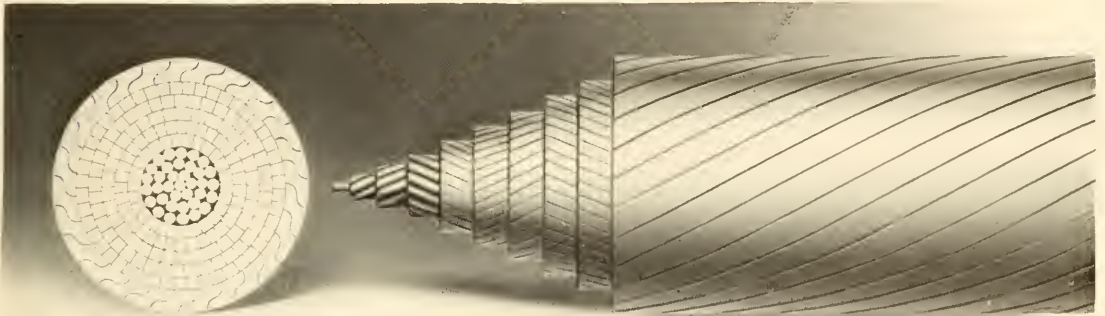

List Price per Foot	Diameter in Inches	Approximate Circumference in Inches	Approximate Weight per Foot in Pounds	Approximate Breaking Stress in Tons of 2000 Pounds
\$3.00	2½	7⅞	15.60	240
2.20	2¼	7⅞	12.50	190
1.75	2	6¼	10.00	160
1.35	1¾	5½	7.65	120
1.17	1⅝	5⅞	6.60	103
1.00	1½	4¾	5.70	89
.85	1⅜	4¼	4.75	75
.72	1¼	4	3.80	62
.60	1⅛	3½	3.15	50
.49	1	3	2.50	40
.37	¾	2¾	1.88	30
.27	¾	2¼	1.30	22
.18	⅝	2	.90	15.5
.16	⅞	1¾	.72	12.5
.14	½	1½	.57	10

This cable may be used for fixed track lines on overhead cableways having fixed spans, and because of its very smooth external surface will not wear out the carriage wheels which run upon it. For such use it has no equal. This cable is suitable only for fixed spans and cannot be used for running purposes. Customers should give full information as to the use to which it is to be put and character of the work. For end fastenings, see pages 208-210.

Hollow Cable Clothes Lines, Galvanized



No. 1—7 Wires—No. 22 Gage



No. 2—9 Wires—No. 22 Gage



No. 3—12 Wires—No. 22 Gage



No. 4—11 Wires—No. 20 Gage



No. 18—6 Wires—No. 18 Gage



No. 19-6 Wires—No. 19 Gage



No. 20-6 Wires—No. 20 Gage

Prices quoted per dozen coils.

Put up in coils of 50, 75 and 100 feet and packed in barrels.

Estimated Average Number of Dozen to Barrel

Style	Sizes	100 Feet	90 Feet	75 Feet	60 Feet	50 Feet	40 Feet
Hollow Cable Lines	No. 1	12	12	15	21	24	25
	No. 2	8	8	12	14	16	16
	No. 3	6	6	8	11	12	12
	No. 4	5	5	8	9	10	10
Twisted Lines	No. 17	5	5	6	7	8	10
	No. 18	2	6	7	7	10	12
	No. 19	8	8	10	12	15	16
	No. 20	10	10	12	14	18	25
Solid Lines (One Wire)	No. 8	4½	5	6	7	8	..
	No. 9	5½	6	7	8	9	..
	No. 10	6½	7	8	9	10	..

Estimated Average Weight in Pounds per Dozen

Hollow Cable Lines	No. 1	18	16	14	11	9	7
	No. 2	22	20	17	13	11	9
	No. 3	30	27	23	18	15	13
	No. 4	42	38	32	25	21	18
Twisted Lines	No. 17	56	50	42	34	28	30
	No. 18	46	41	35	27	24	24
	No. 19	35	31½	25	21	17	17
	No. 20	25	22½	20	15	13	13
Solid Lines (One Wire)	No. 8	84	76	63	50	42	..
	No. 9	70	63	52	42	35	..
	No. 10	58	52	43	35	29	..

Flat Rope

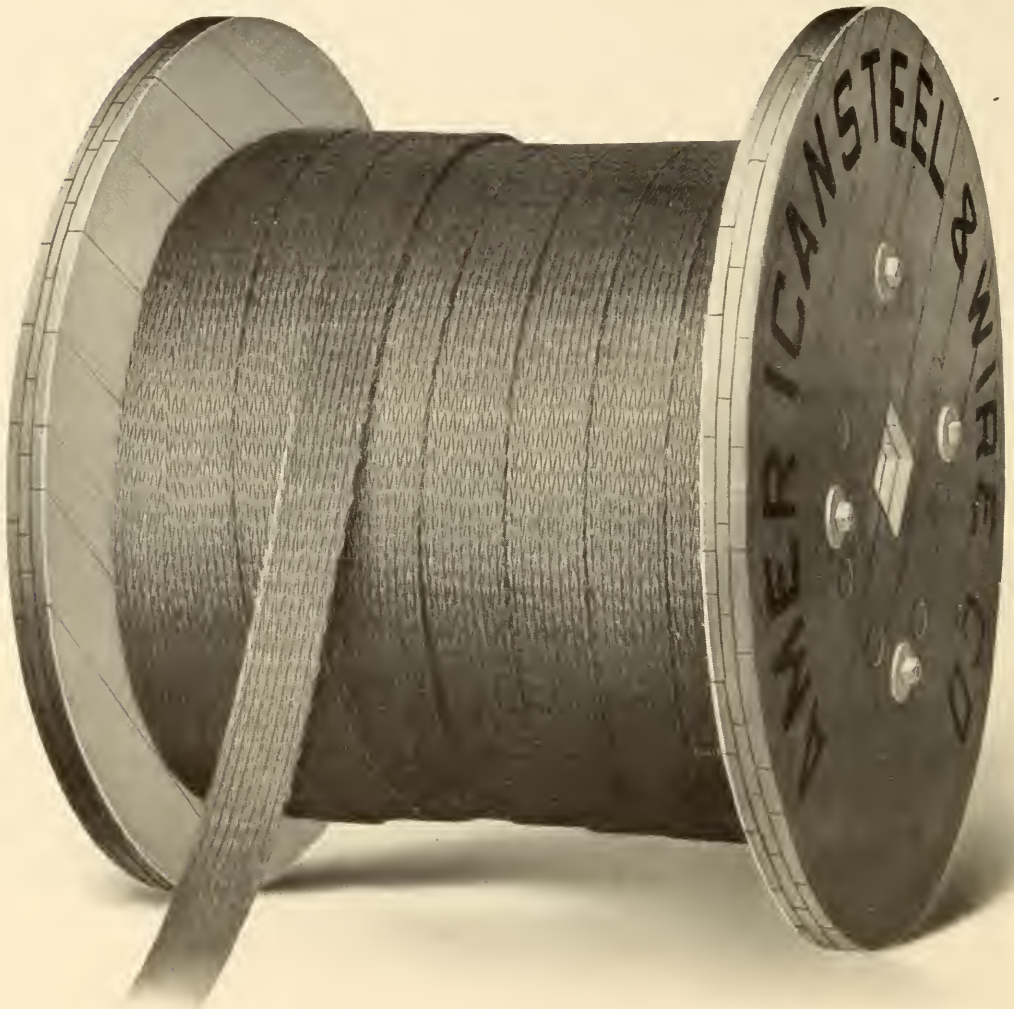

Flat Rope

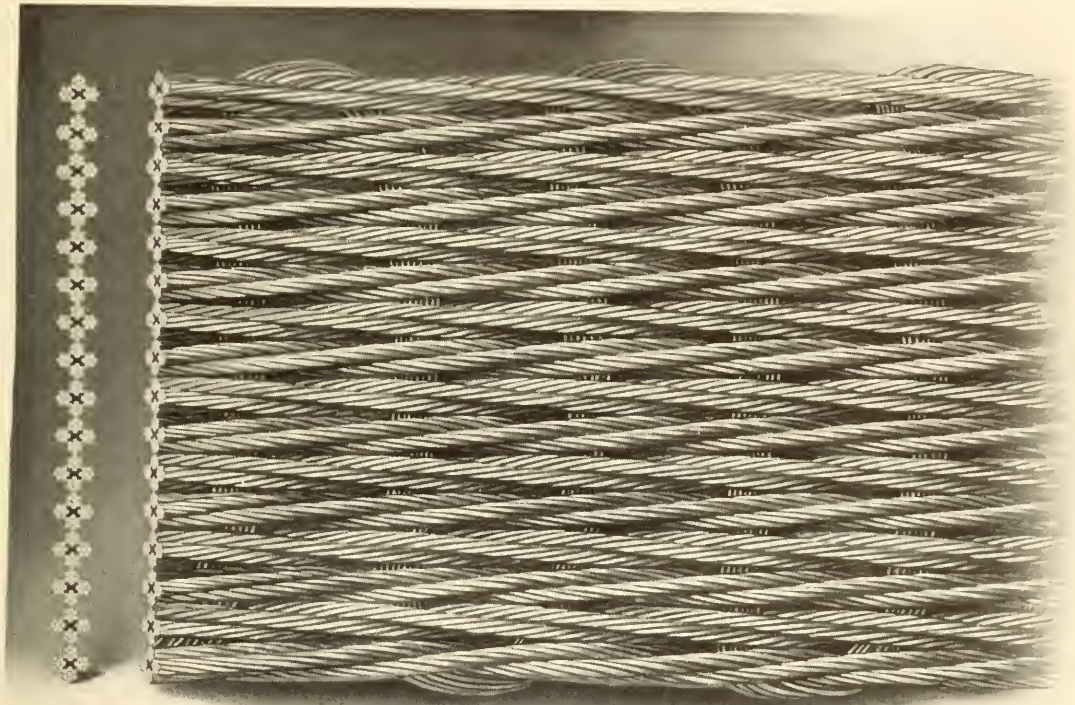

Flat Rope is composed of a number of wire ropes called "flat rope strands," of alternate right and left lay, placed side by side, then secured or sewed together with soft Swedish iron or steel wire, thus forming a complete rope as shown in the cut, usually of crucible steel, although it can be made of iron or plow steel, if necessary. The sewing or filling wires, being so much softer than the steel wires composing the strands of the rope, act as a cushion or soft bed for the strands, and wear out much faster than the harder wires composing the latter. When the sewing wires are worn out, the flat rope can be reseeded with new wire, and if any of the rope strands are also worn or damaged, these can be replaced by new portions. In fact, flat ropes admit of being repaired by the replacing of any worn or injured part. Strands of any kind, size or quality can be furnished. A large stock of Swedish iron sewing wire is carried in warehouse, which can be furnished to repair or sew flat rope at the mine.

Flat Rope is used principally for hoisting purposes. When large and long rope is used in hoisting heavy loads out of deep shafts, round rope requires large and heavy drums on which to wind, while flat rope, winding on itself, needs a reel but little wider than the width of the rope. When space for machinery is an object, the advantage of using the style of rope requiring the smallest

reel is obvious. Furthermore, flat rope does not spin or twist in the shaft. Flat rope can be furnished from $1\frac{3}{4}$ inches to 8 inches in width, and from $\frac{1}{4}$ inch to $\frac{7}{8}$ inch in thickness, the length varying from 20 to 3,000 feet.

Flat Rope

Flat Rope is particularly applicable to the operating of spouts on coal and ore docks, also for raising and lowering of emergency gates on canals and similar machinery, giving long and satisfactory service. Its compact form combines the desirable features of flexibility and great strength, thus making possible the use of simple and compact hoisting machinery. Flat rope will wind on a drum of small diameter, as shown on page 197.

We recommend the use of either a closed or an open socket for fastening the outer end of the rope, as shown on page 210. If desired, a thimble can be sewed into the end of a flat rope but it will not give the full strength of the rope, as shown in the tables. The socket, on the other hand, can be depended upon to give the strength shown in the tables of strength.

For attaching to the drum of a hoisting machine three methods are in vogue, viz: First. Where the drum is large so that the rope can be brought inside, it may be attached by clamps around a pin or spoke. This method is the least desirable. Second. A small loop can be sewed into the end of the rope and fastened to the drum by means of a pin. Third. A tapered hole, wedge-shaped, cast in the drum when it is made, so that rope may be socketed directly to the drum. We recommend this third method as the safest, strongest and simplest method that can be devised, as it requires only a quarter of one lap, compared with a lap and a half for the No. 2 method.

We can furnish details on application regarding No. 3 method to those desiring to purchase this type of rope.

Flat ropes are usually made single stitching, using eight sewing wires. More wires can be used, but we do not recommend the use of over ten or twelve sewing wires. The number of sewing wires is dependent upon the size of wire used in sewing. Double sewing is sometimes used but it increases the thickness of the rope over single sewing and is undesirable for that reason. Its use is not recommended as it frequently gives trouble.

We have expert flat rope sewers constantly in our employ and can make up any of the sizes listed at short notice.

The widths given for flat ropes are nominal, *i. e.*, in some cases $\frac{1}{4}$ inch over or $\frac{1}{8}$ inch under the figures, due to the construction. For example, a half-inch thickness of rope means that approximately $\frac{1}{2}$ inch is added to the width by the insertion of one rope strand so that widths cannot be changed except by regular steps or multiples of the diameter of a single rope strand. If space or clearance is small, customers should so state on their order, giving maximum permissible width for the rope, which can then be made to the nearest corresponding width.

Drums and sheaves for flat rope should, of course, be as large as possible, particularly for mine hoisting work. A good rule is to have the diameter of the drum at the bottom ascertained by the following rule :

$$D = ct$$

D = diameter of drum at bottom in feet.

t = thickness of flat rope in inches.

c = constant value. c = 100 for drum diameter. c = 160 for sheave diameter.

For short flat ropes, drums are usually made smaller as follows :

Thickness of Flat Rope	Diameter of Drum at Bottom, Inches	Diameter of Sheave Inches
$\frac{1}{4}$	6	12
$\frac{5}{8}$	$7\frac{1}{2}$	15
$\frac{3}{8}$	9	18
$\frac{1}{2}$	12	24
$\frac{5}{8}$	15	30
$\frac{3}{4}$	18	36
$\frac{7}{8}$	21	42

Sheaves should be slightly crowned in the center and have good deep flanges to guide the rope.

Flat Rope

Crucible Steel—Plow Steel

List Price per Pound	Width and Thickness in Inches	Approximate Weight per Foot in Pounds	Crucible Steel		Plow Steel	
			Approximate Breaking Stress in Tons of 2000 Pounds	Proper Working Load in Tons of 2000 Pounds	Approximate Breaking Stress in Tons of 2000 Pounds	Proper Working Load in Tons of 2000 Pounds
¼-Inch Thick						
. . .	¼ x 1½	0.65	13	2.6	15.5	3.10
. . .	¼ x 2	.82	17	3.4	20	4.00
. . .	¼ x 2½	1.06	22	4.4	26.5	5.30
. . .	¼ x 3	1.23	26	5.2	31	6.20
⅓-Inch Thick						
. . .	⅓ x 1½	0.79	18	3.6	22	4.4
. . .	⅓ x 2	1.10	23	4.6	28	5.6
. . .	⅓ x 2½	1.35	30	6.0	35	7.0
. . .	⅓ x 3	1.60	36	7.2	43	8.6
. . .	⅓ x 3½	1.88	41	8.2	50	10.0
. . .	⅓ x 4	2.15	48	9.6	57	11.4
⅜-Inch Thick						
. . .	⅜ x 2	1.30	27	5.4	33	6.6
. . .	⅜ x 2½	1.70	36	7.2	43	8.6
. . .	⅜ x 3	1.89	41	8.2	49	9.8
. . .	⅜ x 3½	2.30	50	10.0	60	12.0
. . .	⅜ x 4	2.43	54	10.8	65	13.0
. . .	⅜ x 4½	2.85	63	12.6	76	15.2
. . .	⅜ x 5	3.10	68	13.6	81	16.2
. . .	⅜ x 5½	3.50	77	15.4	92	18.4
. . .	⅜ x 6	3.73	81	16.2	97	19.4
½-Inch Thick						
. . .	½ x 2½	2.20	45	9.0	54	10.8
. . .	½ x 3	2.50	52	10.4	63	12.6
. . .	½ x 3½	2.80	60	12.0	72	14.4
. . .	½ x 4	3.15	69	13.8	82	16.4
. . .	½ x 4½	3.85	83	16.6	99	19.8
. . .	½ x 5	4.20	90	18.0	108	21.6
. . .	½ x 5½	4.55	98	19.6	118	23.6
. . .	½ x 6	4.90	105	21.0	126	25.2
. . .	½ x 7	5.90	128	25.6	153	30.6
⅝-Inch Thick						
. . .	⅝ x 3½	3.50	68	13.6	79	15.8
. . .	⅝ x 4	4.00	79	15.8	92	18.4
. . .	⅝ x 4½	4.55	91	18.2	105	21.0
. . .	⅝ x 5	5.10	102	20.4	119	23.8
. . .	⅝ x 5½	5.65	114	22.8	132	26.4
. . .	⅝ x 6	6.15	125	25.0	145	29.0
. . .	⅝ x 7	7.30	148	29.6	171	34.2
. . .	⅝ x 8	8.40	170	34.0	197	39.4
¾-Inch Thick						
. . .	¾ x 5	6.85	135	27.0	157	31.4
. . .	¾ x 6	7.50	151	30.2	175	35.0
. . .	¾ x 7	8.25	168	33.6	194	38.8
. . .	¾ x 8	19.75	202	40.4	234	46.8
⅞-Inch Thick						
. . .	⅞ x 5	7.50	155	31.0	177	34.4
. . .	⅞ x 6	8.53	180	36.0	209	41.8
. . .	⅞ x 7	9.56	203	40.6	233	46.6
. . .	⅞ x 8	10.60	225	45.0	258	51.6

A. S. & W. Shield Filler

This Shield Filler has been compounded to meet the demand for a first class lubricant of moderate cost, which should be suitable for as many wire rope conditions as possible. It is particularly recommended for mine hoists and haulage systems, coal dock haulage roads, dredge ropes, logging ropes, steam shovel ropes, oil well drilling ropes, quarry ropes, and, in fact, any rope where a heavy lubricant is desirable.

A. S. & W. Shield Filler adheres very tenaciously to a wire rope and may be applied without any difficulty to a rope that has already had a coating of grease. It has a high drip point and is a flexible compound at low temperatures. Tests on mine ropes subjected to bad acid mine water have proven conclusively that it will protect such ropes as completely as possible from the corrosive action of such water, and thus prolong the rope service. It does not dry up quickly and flake off, like many compounds, but retains to a marked degree the elasticity necessary for a rope lubricant.

Application of this lubricant is readily made by passing a rope slowly through a small tank which is filled with hot compound and arranging a wiper to take off any excess of compound. In order to heat the compound for application, a steam coil may be used, or, for small amounts, the cans may be heated by putting into hot water until contents are warmed clear through. If heat is not available, the Shield Filler can be applied without warming, but it will flow better when hot.

For convenience, this material is furnished in 2, 5 and 10-gallon cans or about 50-gallon barrels.

List Prices for A. S. & W. Shield Filler

2-gallon cans	\$3.00 per can
5-gallon cans	6.50 per can
10-gallon cans	12.00 per can
50-gallon barrels11 per pound

Chapter X

Special Equipment

List Prices of Wire Rope Fittings and Methods of Attachment

Issued Jan. 1, 1913. Subject to Change Without Notice

These various methods of attachment in common use, together with the necessary fittings, will be taken up in the following order:

	Page
1 Thimbles or Eyes, Regular or Extra Large, Spliced in End of Rope	202
2 Crosby Clips and Thimbles	204
3 Clamps, Regular and Strand, for Making Loops	205
4 Closed Socket Fastened to End of Rope . . .	206
5 Open Socket Fastened to End of Rope . . .	207
6 Bridge Socket, Closed Type	208
7 Bridge Socket, Open Type	209
8 Step Socket	210
9 Socket with Chain	211
10 Flat Rope Sockets	210
11 Swivel Hook and Thimble, Loose and Spliced In	211
12 Swivel Hook and Socket	212
13 Socket and Hook, Loose and Attached . . .	213
14 Hook and Thimble, Loose and Spliced In . .	214
15 Sister Hook and Thimble, Loose and Spliced In	215
16 Single Locomotive Switching Ropes	216
17 Double Locomotive Switching Ropes . . .	217
18 Wrecking Ropes, Single Fittings	218
19 Wrecking Ropes, Double Fittings	219
20 Turnbuckles	220
21 Shackles	222
22 Wire Rope Blocks	223
23 Wire Rope Sheaves	225
24 Endless Rope Splicing	226
25 Wire Rope Slings	227
26 Drawing-in Cables	229
27 Wire Rope Splicing	230

Chapter X

Special Equipment

Wire Rope Fittings and Methods of Attachment For the proper fastening of wire ropes to different kinds of apparatus and machinery there have been developed various methods which can be successfully used.

There are some types of fastenings which can be made by anyone, but there are others which require a certain amount of skill to make them advantageously. As a general rule, a factory-made fastening may be depended upon to give the best results. We have a large force of skilled workmen constantly employed and are prepared to do all kinds of splicing and attaching of rope fittings at reasonable rates. Customers will find it to their advantage to have such work done at our factory where our complete equipment enables us to handle it promptly as well as at a reasonable price.

The successful use of wire rope frequently depends upon the proper selection of the right kind of fitting or end fastening, and in the succeeding pages will be found illustrations of a large variety of fittings for different purposes. It is possible by a proper combination of them to accomplish any desired result for rapid and economical operation. Each represents the best of its type in general design, being compact, strong and universal in scope and adaptation.

For example :

Two ropes may be joined together in any one of the following ways :

First. Closed socket on one rope and open socket on other, the pin on the open socket passing through the loop of the closed socket.

Second. An open socket on one rope and a thimble spliced in the other rope are quickly connected by passing the pin of the closed socket through the eye of the thimble.

Third. A shackle, page 222, may be used to connect any two ropes equipped in the following manner by removing the pin and putting the shackle through the fittings and reinserting the shackle pin.

- A. Two ropes with open sockets, page 207, on mating ends.
- B. Two ropes with closed sockets, page 206, on mating ends.
- C. Two ropes with thimbles spliced, page 203, on mating ends.
- D. Two ropes with thimbles and links spliced on mating ends.

Fourth. Turnbuckles of one of the styles shown on page 221 are usually used to take up the slack on derrick guys, ships' rigging and other places where such slack would be objectionable. They are made with all styles of ends so as to make a quick and secure fastening to a rope equipped with a thimble, open or closed socket fastening.

Fifth. Swivel hook and thimble, page 211, allows the turning of a rope under load to avoid kinking.

Sixth. Regular sockets, pages 206 and 207, are used on smaller ropes, but for very large ropes on cableways and bridges it is customary to use the bridge sockets, pages 208 and 209.

In addition to the fittings shown herein, we are prepared to make and attach to wire ropes any practical design of fitting required by special work.

Prices on such fittings and attaching them to rope will be furnished upon application to nearest Sales Office.

Galvanized Oval Thimbles

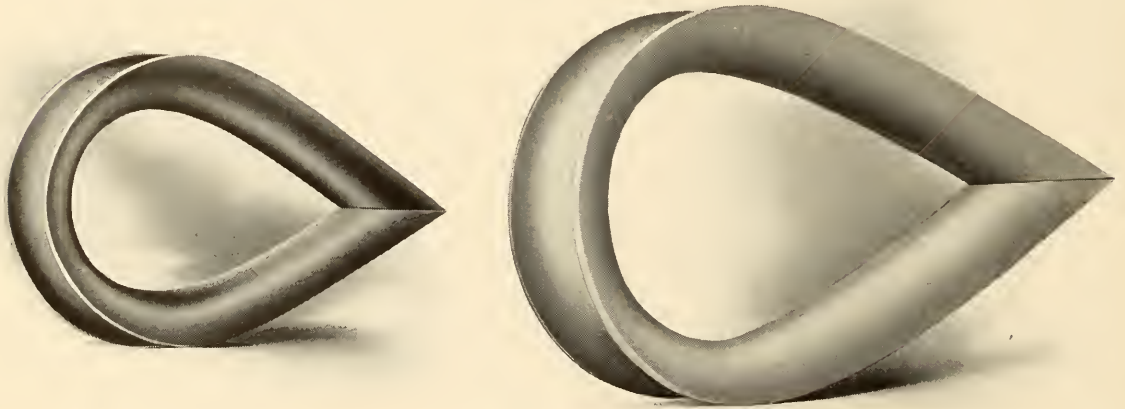

Regular

Extra Large

List Price in Cents Each	Size Thimble Width of Score in Inches	Circumference of Rope in Inches	Diameter of Pin that may be inserted in Regular Thimble in Inches	Diameter of Pin that may be inserted in Extra Large Thimble in Inches	Length Inside in Inches Regular Thimble	Length Inside in Inches Extra Large Thimble	Approximate Weight in Pounds Regular Thimble	Approximate Weight in Pounds Extra Large Thimble
50	1 1/2	4 3/4	2 9/16	.. .	3 7/8	4 3/4	1.80	2.20
42	1 3/8	4 1/4	2 7/16	2 11/16	3 7/8	4 1/2	1.40	2.00
33	1 1/4	4	2 3/8	2 11/16	3 3/4	4 3/8	1.05	1.50
25	1 1/8	3 1/2	1 15/16	2 1/2	3 3/8	4 1/4	.90	1.20
20	1	3	1 13/16	2 5/16	3 1/8	4 1/8	.60	.85
16	7/8	2 3/4	1 9/16	2	2 1/2	3 1/2	.44	.75
15	3/4	2 1/4	1 7/16	1 3/4	2 3/8	3 1/2	.37	.50
13	5/8	2	1 1/4	1 9/16	2 1/8	2 7/8	.22	.30
12	9/16	1 3/4	1 1/8	.. .	213	.. .
11	1/2	1 1/2	1 1/16	.. .	1 7/813	.. .
10	7/16	1 1/4	1	.. .	1 3/409	.. .
9	3/8	1 1/8	7/8	.. .	1 1/206	.. .
8	5/16	1	3/4	.. .	1 1/205	.. .
8	1/4	3/4	5/8	.. .	1 3/803	.. .

Our Galvanized Oval Thimbles are heavily coated with zinc.

Galvanized Thimble Spliced Into Rope

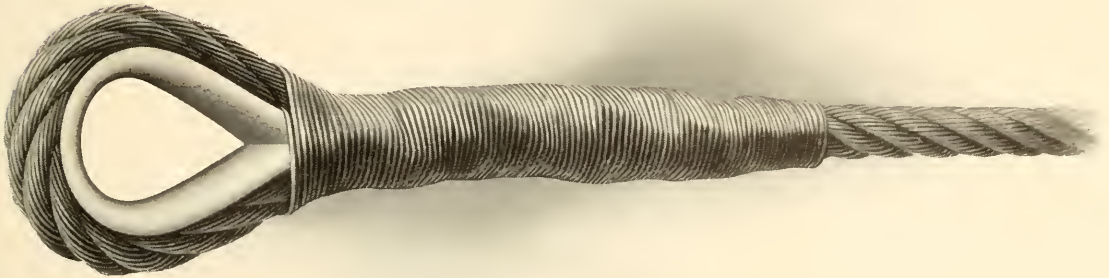

Diameter of Rope in Inches	Circumference of Rope in Inches	List Prices Complete for Steel Rope	List Prices Complete for Iron Rope
1 1/2	4 3/4	\$6.50	\$6.00
1 3/8	4 1/4	5.75	5.25
1 1/4	4	4.70	4.35
1 1/8	3 1/2	3.90	3.65
1	3	3.00	2.85
7/8	2 3/4	2.55	2.40
3/4	2 1/4	2.00	1.85
5/8	2	1.55	1.45
9/16	1 3/4	1.30	1.20
1/2	1 1/2	1.25	1.15
7/16	1 1/4	1.20	1.10
3/8	1 1/8	1.15	1.05
5/16	1	1.10	1.00
1/4	3/4	1.10	1.00

We secure all of the thimbles to the ropes with four tucks of each strand. The seizing is not used for strength purposes, as it serves solely to make a finished rope end and protect the hands of operators from injury when handling it.

Crosby Wire Rope Clips

Galvanized



Size Clip Corresponding to Rope Diameter in Inches	List Price Each	Approximate Weight Each in Pounds	Size Clip Corresponding to Rope Diameter in Inches	List Price Each	Approximate Weight Each in Pounds
2½	\$11.50		1	\$0.85	3.00
2¼	9.50		¾	.75	2.00
2	7.50		¾	.65	1.75
1¾	5.50		⅝	.55	.87
1⅝	3.50		½	.45	.75
1½	1.50	5.75	⅞	.45	.37
1⅜	1.25	5.75	⅜	.40	.37
1¼	1.10	3.75	⅝	.35	.25
1⅛	.95	3.75	¼	.35	.25

Clips are not recommended as permanent fastening on hoisting ropes. They are easily applied and taken off, requiring no special skill, as in the case of thimbles spliced in or sockets attached. Care should be taken to see that the U-bolt bears on the short end of the rope so that the flat base of clip rests on the tension side of the rope, otherwise rope will be injured by putting a crimp into the tension side of rope. Not fewer than 2 clips to be used and preferably 4 to 6, particularly on large sizes of rope.

Wire Rope Clamps



Extra Heavy

List Price Each	Size Clamp and Diameter of Rope in Inches	Circumference of Rope in Inches	List Price Each	Size Clamp and Diameter of Rope in Inches	Circumference of Rope in Inches
\$13.75	2 1/4	7 1/8	\$1.75	1	3
8.50	2	6 1/4	1.30	7/8	2 3/4
5.50	1 3/4	5 1/2	1.15	13/16	2 1/2
5.00	1 5/8	5	1.05	3/4	2 1/4
3.80	1 7/8	4 1/2	.90	5/8	2
2.50	1 1/4	4	.60	9/16	1 3/4
2.25	1 3/16	3 3/4	.60	1/2	1 1/2
1.90	1 1/8	3 1/2	.45	7/16	1 1/4
1.90	1 1/16	3 1/4	.30	5/16	1

Clamps are not recommended for permanent fastenings. From 2 to 6 clamps should be used for one end fastening. Alternate clamps and Crosby Clips are better than all clamps, but for permanent work sockets are preferable to either. See pages 206 to 210.

Galvanized Three-bolt Telephone Clamp

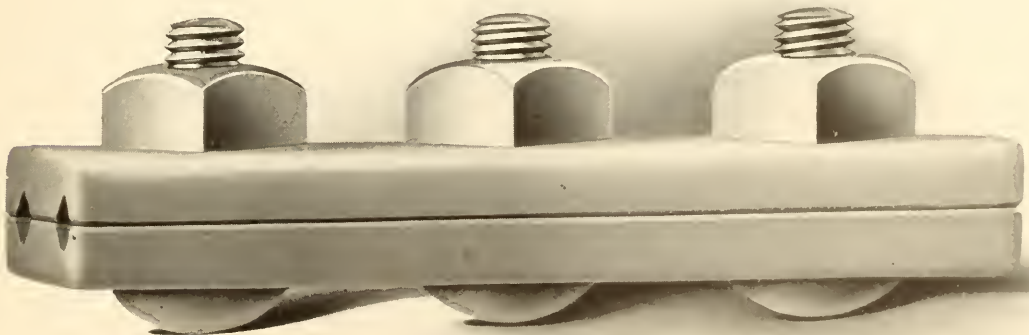

This is known as the standard A. T. & T. Co. hot galvanized rolled steel strand clamp or guy clamp; made from open hearth bar steel. Will hold any size of strand from 1/4 inch to 1/2 inch diameter.

Prices on application.

Closed Sockets

For Use with Either Steel or Iron Rope



Size Socket and Diameter of Rope in Inches	Circum- ference of Rope in Inches	List Price for Steel or Iron Rope		Diameter of Pin that may be inserted in Socket Loop in Inches	Length of Basket in Inches	Length Over All in Inches	Approximate Weight in in Pounds
		Loose	Fastened				
2 1/4	7 1/8	\$21.00	\$32.00				
2	6 1/4	16.00	25.50				
1 3/4	5 1/2	13.00	21.00				
1 5/8	5	12.00	18.00				
1 1/2	4 3/4	6.80	11.80	2 3/4	5 1/2	12 5/8	18.25
1 3/8	4 1/4	6.00	10.25	2 3/4	5	11 1/8	16.00
1 1/4	4	4.50	8.00	2 3/4	5	11 1/8	12.75
1 1/8	3 1/2	3.30	6.15	2 1/4	4 1/2	10 1/2	10.50
1	3	2.40	4.65	2 1/4	4 1/2	10 1/2	8.75
7/8	2 3/4	1.85	3.85	2	4	9 1/4	6.00
3/4	2 1/4	1.65	3.15	1 3/4	3 3/8	8	3.75
5/8	2	1.35	2.65	1 1/2	3	6 5/8	2.25
9/16	1 3/4	1.10	2.35	1 5/16	2 3/4	6	1.85
1/2	1 1/2	1.10	2.25	1 5/16	2 3/4	6	1.50
7/16	1 1/4	.85	2.00	1 1/8	2 1/2	5 1/4	1.25
3/8	1 1/8	.85	1.85	1 1/8	2 1/2	5 1/4	.87
5/16	1	.70	1.60	1 5/16	1 3/8	3 3/4	.65
1/4	3/4	.70	1.60	1 5/16	1 3/8	3 3/4	.44

As we attach them they are the strongest rope fastenings made, utilizing the full published strength of the ropes. All standard type sockets are drop forged weldless and stronger than any rope that may be inserted in them. Sockets of special dimensions take special prices.

Open Sockets

For Use with Either Steel or Iron Rope



Size Socket and Diameter of Rope in Inches	Circumference of Rope in Inches	List Price for Steel or Iron Rope		Width Between Jaws in Inches	Diameter of Pin in Inches	Length of Basket in Inches	Length Over All in Inches	Approximate Weight in Pounds
		Loose	Fastened					
2 1/4	7 1/8	\$23.00	\$34.00	3 3/4	4	9 1/4	22	120
2	6 1/4	16.50	26.00	3 1/2	3 3/4	8 1/4	20	98
1 3/4	5 1/2	15.50	23.50	2 3/4	3 1/4	7 1/4	16 3/4	66
1 5/8	5	13.00	19.00	2 5/16	2 1/4	6 1/8	13 5/8	45
1 1/2	4 3/4	8.00	13.00	2 7/16	2 1/4	5 1/2	13	30
1 3/8	4 1/4	7.50	11.75	2 1/8	1 7/8	5	11 1/2	24
1 1/4	4	6.10	9.60	2 1/8	1 7/8	5	11 1/2	18.5
1 1/8	3 1/2	4.50	7.35	1 7/8	1 5/8	4 1/2	10	15.5
1	3	3.15	5.40	1 7/8	1 5/8	4 1/2	10	12.75
7/8	2 3/4	2.50	4.50	1 9/16	1 1/4	4	8 7/8	8.00
3/4	2 1/4	2.10	3.60	1 5/16	1 1/8	3 3/8	7 3/8	5.25
5/8	2	1.65	2.95	1 1/8	1	3	6 3/4	3.87
9/16	1 3/4	1.35	2.60	1 5/16	7/8	2 3/4	6	3.00
1/2	1 1/2	1.35	2.50	1 5/8	7/8	2 3/4	6	2.25
7/16	1 1/4	1.00	2.15	7/8	5/8	2 1/2	5 1/2	1.75
3/8	1 1/8	1.00	2.00	7/8	5/8	2 1/2	5 1/2	1.25
5/16	1	.85	...	1 1/16	1/2	1 5/8	3 1/2	.95
1/4	3/4	.85	...	1 1/16	1/2	1 3/8	3 1/2	.62

As we attach them they are the strongest rope fastenings made, utilizing the full published strength of the ropes. All standard type sockets are drop forged weldless and stronger than any rope that may be inserted in them. Sockets of special dimensions take special prices.

Bridge Sockets

Closed Type

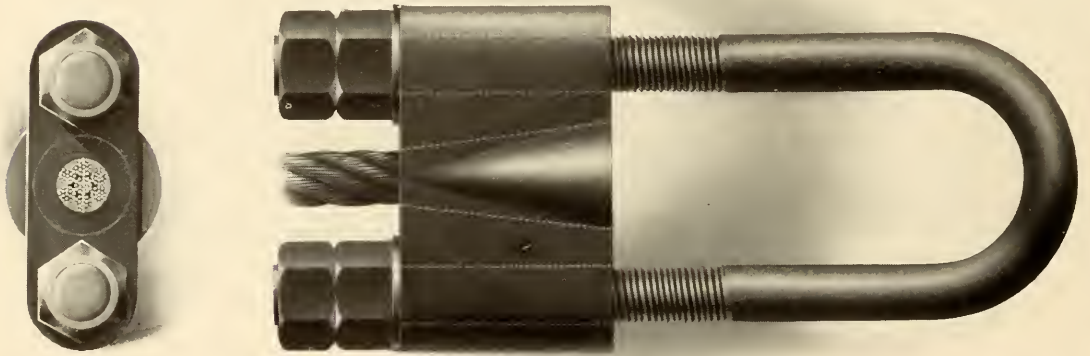

List Price Each		Size and Diameter of Rope in Inches	Diameter in Inches of U-bolts	Center to Center of Bolt Holes	Thickness or Depth of Socket in Inches	Outside Length of Socket in Inches	Length from Pull of U-bolt to End of Bolts	Take-up in Inches	Approx. Weight in Pounds
Fastened	Loose								
\$106.70	\$82.85	2¾	3¼	12	12	19	42	18	589
89.30	68.75	2½	3	11¼	11	17¾	42	18	485
69.90	53.80	2¼	2¾	10¼	10	16¼	40	18	378
53.60	41.25	2	2½	9½	9	15	38	18	290
40.70	31.30	1¾	2¼	8½	8	13½	36	18	218
31.25	24.05	1⅝	2	8	7½	12½	32	15	170
26.50	20.50	1½	1⅞	7¾	7	12	31	15	144
22.00	16.90	1⅜	1¾	7½	6½	11½	28	12	119
15.75	12.15	1¼	1½	7¼	6	10¾	27	12	87

These sockets are constructed throughout of steel and are suitable for attaching to the galvanized bridge cables shown on page 181, and may also be used on the locked tramway and cableway strand shown on pages 190 and 191, or any rope that corresponds in size to the opening. These fittings develop the full strength of the rope when properly attached.

Bridge Sockets

Open Type

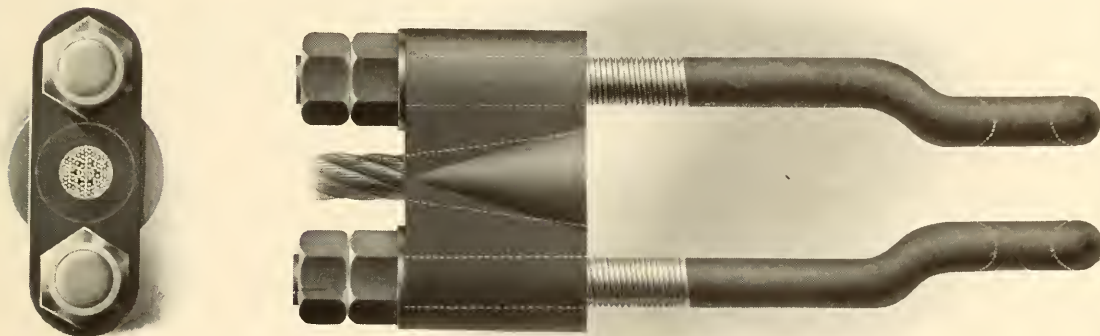

List Price Each		Size and Diameter of Rope in Inches	Diameter in Inches of Eye-bolts	Center to Center of Bolt Holes in Inches	Thick-ness or Depth of Socket in Inches	Size Eye in Inches	Outside Length of Socket in Inches	Length from Center of Eye-bolt to End of Same in Inches	Distance Between Eye-bolts in Inches	Take-up in Inches	Approx. Weight in Pounds
Fastened	Loose										
\$123.75	\$95.25	2 3/4	3 1/4	12	12	5 1/2	19	42	5	18	658
101.60	78.15	2 1/2	3	11 1/4	11	5	17 3/4	42	4 1/2	18	538
80.10	61.60	2 1/4	2 3/4	10 1/4	10	4 1/2	16 1/4	40	4	18	422
63.25	48.65	2	2 1/2	9 1/2	9	4	15	38	3 3/4	18	332
47.60	35.90	1 3/4	2 1/4	8 1/2	8	3 3/4	13 1/2	36	3 1/2	18	244
35.40	27.25	1 5/8	2	8	7 1/2	3 1/2	12 1/2	32	3 1/4	15	188
30.35	23.35	1 1/2	1 7/8	7 3/4	7	3 1/4	12	31	3	15	160
24.70	19.00	1 3/8	1 3/4	7 1/2	6 1/2	2 3/4	11 1/2	28	2 3/4	12	131
16.25	12.50	1 1/4	1 1/2	7 1/4	6	2 1/4	10 3/4	27	2 1/2	12	89

The distance between eyes can be varied to suit point of service. These sockets are made of steel throughout and develop the full strength of the rope to which they are attached. They may be used with galvanized bridge cables, page 181, locked tramway and cableway strand, shown on pages 190 and 191, or any rope that corresponds in size to the opening.

Step Socket

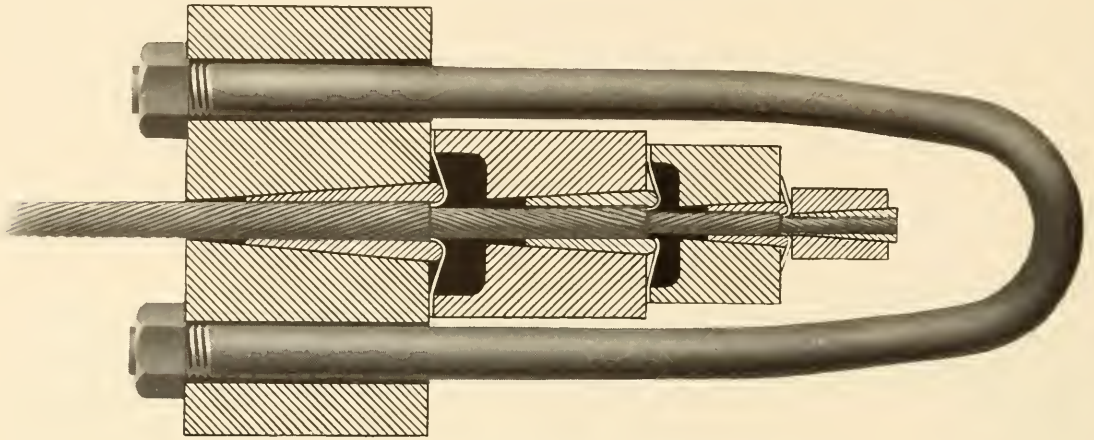

Made especially for Locked Wire Cable, shown on pages 190 and 191. Prices furnished upon application.

Special Flat Rope Sockets

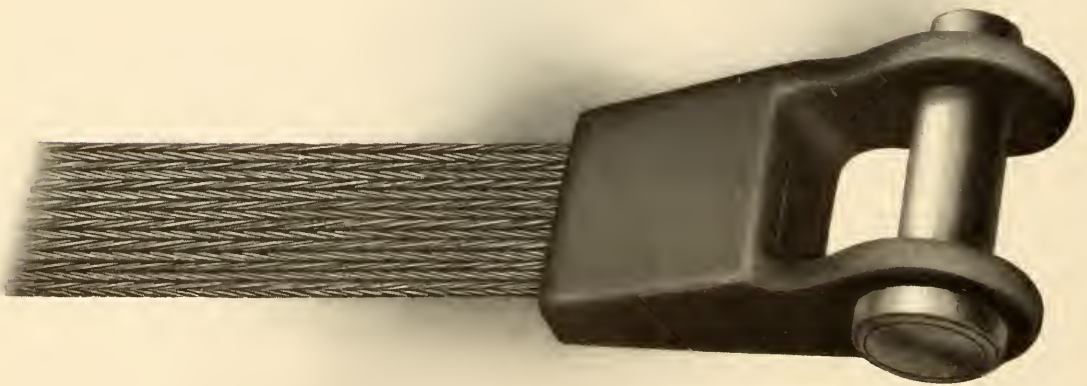

This special steel socket has been designed to meet the rigid requirements of this kind of rope fastening. It is made of steel throughout and when attached to a flat rope will develop the full strength of the rope (see pages 194 to 198). Full particulars as to price and general dimensions for rope of any width and thickness will be furnished upon request.

Hook, Swivel and Thimble
 For Use with Either Steel or Iron Rope



Diameter of Rope in Inches	Circumference of Rope in Inches	List Prices for Steel Rope		List Prices for Iron Rope	
		Loose	Fastened	Loose	Fastened
1½	4¾	\$27.00	\$32.00	\$22.00	\$27.00
1⅜	4¼	21.00	25.25	17.00	21.25
1¼	4	17.00	20.50	13.50	17.00
1⅛	3½	12.00	14.85	9.00	11.85
1	3	8.35	10.60	5.70	7.49
¾	2¾	7.00	9.00	4.75	6.75
⅜	2¼	5.25	6.75	4.00	5.50
⅝	2	4.60	5.90	3.60	4.90
⅞	1¾	3.75	5.00	3.00	4.25
1	1½	3.55	4.70	3.00	4.15
⅞	1¼	2.85	4.00	2.55	3.70
⅝	1⅛	2.70	3.70	2.35	3.35
⅜	1	2.30	3.20	2.00	2.90
⅛	¾	2.30	3.20	2.00	2.90

This hook swivel and thimble permits the load to rotate without unduly untwisting the rope.

Socket and Chain

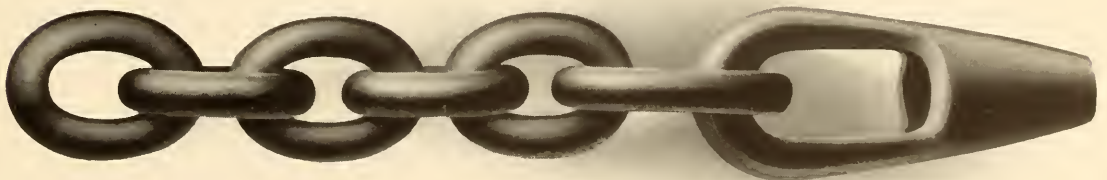

Made for any size rope. Prices depending on length and size of chain.

Swivel Hook and Socket

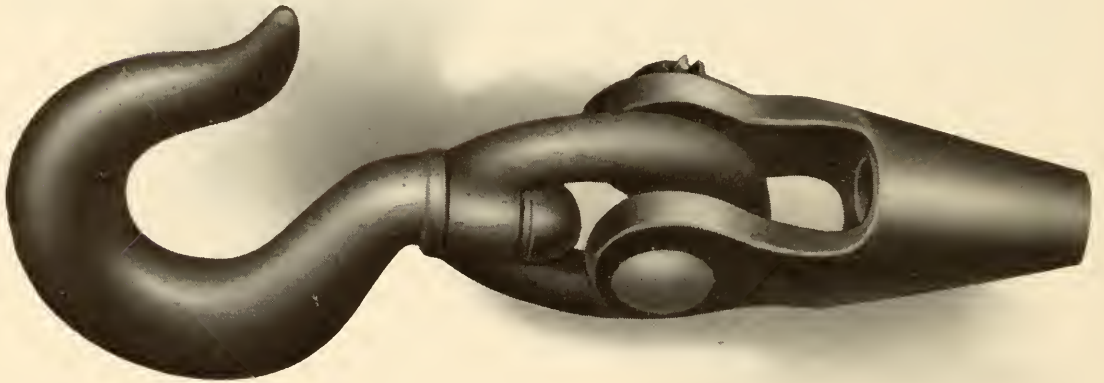

Diameter of Rope in Inches	Circumference of Rope in Inches	List Prices for Steel Rope		List Prices for Iron Rope	
		Loose	Fastened	Loose	Fastened
1½	4¾	\$35.00	\$40.00	\$30.00	\$35.00
1⅝	4¼	28.50	32.75	24.50	28.75
1¼	4	23.10	26.60	19.60	23.10
1⅛	3½	16.50	19.35	13.50	16.35
1	3	11.50	13.75	8.85	11.10
¾	2¾	9.50	11.50	7.25	9.25
¾	2¼	7.35	8.85	6.10	7.60
⅝	2	6.25	7.55	5.25	6.55
⅝	1¾	5.10	6.35	4.35	5.60
½	1½	4.90	6.05	4.35	5.50
⅞	1¼	3.85	5.00	3.55	4.70
⅞	1⅛	3.70	4.70	3.35	4.35
⅞	1	3.15	4.05	2.85	3.75
⅞	¾	3.15	4.05	2.85	3.75

Hook and Socket

For Use with Either Steel or Iron Rope



Diameter of Rope in Inches	Circumference of Rope in Inches	List Prices for Steel Rope		List Prices for Iron Rope	
		Loose	Fastened	Loose	Fastened
1½	4¾	\$14.50	\$19.50	\$12.50	\$17.50
1⅜	4¼	12.30	16.55	10.25	14.50
1¼	4	10.00	13.50	8.00	11.50
1⅛	3½	8.25	11.10	6.25	9.10
1	3	6.50	8.75	4.60	6.85
¾	2¾	5.25	7.25	3.70	5.70
¾	2¼	3.85	5.35	3.00	4.50
⅝	2	2.90	4.20	2.30	3.60
⅜	1¾	2.45	3.70	2.00	3.25
⅜	1½	2.10	3.25	1.95	3.10
⅜	1¼	1.70	2.85	1.55	2.70
⅜	1⅛	1.65	2.65	1.50	2.50
⅜	1	1.45	2.35	1.25	2.15
⅜	¾	1.45	2.35	1.25	2.15

These fittings may be attached to any style or construction of rope, but they are especially useful when attached to our Non-Spinning Rope, pages 156 to 161. An open socket can be supplied, if desired, for a slight advance over above list (prices on application). Hooks are made extra strong to equal strength of rope.

Hook and Thimble

For Use with Either Steel or Iron Rope



Diameter of Rope in Inches	Circumference of Rope in Inches	List Prices for Steel Rope		List Prices for Iron Rope	
		Loose	Fastened	Loose	Fastened
1½	4¾	\$7.00	\$13.50	\$5.00	\$11.00
1⅜	4¼	5.40	11.15	3.40	8.65
1¼	4	4.60	9.20	2.65	6.90
1⅛	3½	4.40	8.15	2.40	5.90
1	3	3.75	6.70	1.90	4.65
¾	2¾	2.90	5.35	1.40	3.70
⅝	2¼	1.85	3.75	1.10	2.85
⅜	2	1.40	2.85	.85	2.20
⅜	1¾	1.10	2.40	.75	1.95
½	1½	.80	2.05	.65	1.80
⅞	1¼	.75	1.95	.60	1.70
⅜	1⅛	.70	1.85	.55	1.60
⅜	1	.65	1.75	.50	1.50
¼	¾	.65	1.75	.50	1.50

Used in many places, such as derricks, cranes, skidders, slings, etc.

Sister Hooks and Thimble

For Use with Either Steel or Iron Rope

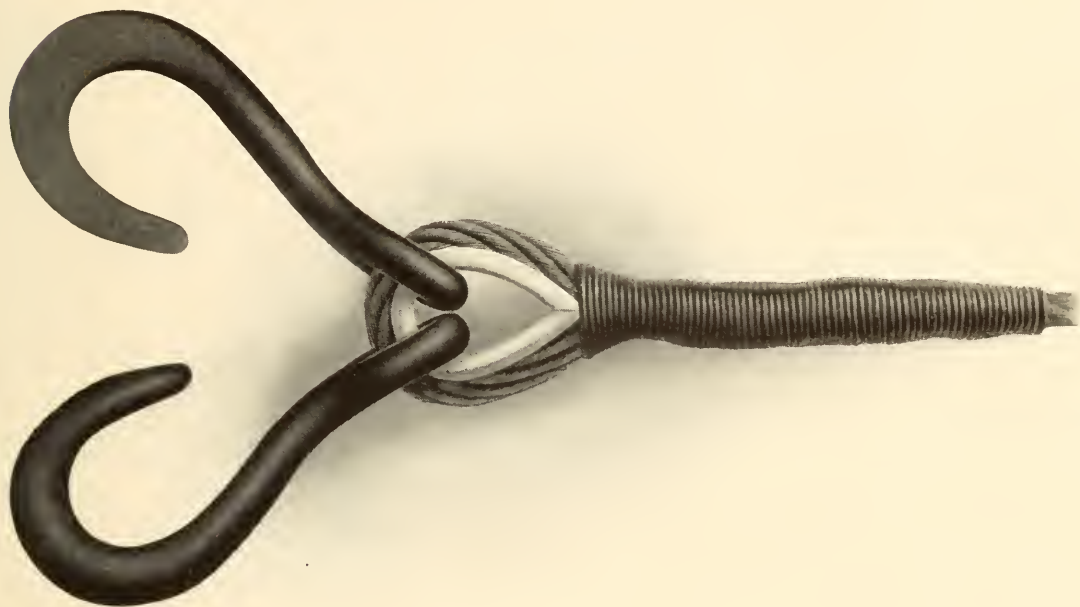

Diameter of Rope in Inches	Circumference of Rope in Inches	List Prices for Steel Rope		List Prices for Iron Rope	
		Loose	Fastened	Loose	Fastened
1½	4¾	\$7.00	\$13.50	\$5.00	\$11.00
1⅜	4¼	5.40	11.15	3.40	8.65
1¼	4	4.60	9.20	2.65	6.90
1⅛	3½	4.40	8.15	2.40	5.90
1	3	3.75	6.70	1.90	4.65
¾	2¾	2.90	5.35	1.40	3.70
¾	2¼	1.85	3.75	1.10	2.85
⅝	2	1.40	2.85	.85	2.20
⅜	1¾	1.10	2.40	.75	1.95
½	1½	.80	2.05	.65	1.80
⅞	1¼	.75	1.95	.60	1.70
⅝	1⅛	.70	1.85	.55	1.60
⅜	1	.65	1.75	.50	1.50
¼	¾	.65	1.75	.50	1.50

Sister hooks are frequently employed where a rope has to be quickly attached and detached from a load and at the same time to hold the load locked in position so long as the rope is under strain. Illustration shows the two parts of the hook apart ready to attach load. Such devices are used frequently for logging and drawing-in cables. (See page 229 for illustration of latter.)

Locomotive Switching, Wrecking and Ballast Unloader Rope

Single Fittings

Hook and thimble in one end; thimble and link in other end.

To determine the list price of Locomotive Switching, Wrecking and Ballast Unloader Ropes, add to the list price of the length, size and quality of rope specified (the length to be added being measured from the bearing of hook in one end to the bearing of the last link in the other end) the following extras for fittings spliced in:

List Prices for Fittings Fastened to Ropes

Diameter in Inches	List Fittings	Diameter in Inches	List Fittings	Diameter in Inches	List Fittings
2	\$36.00	1½	\$17.25	1	\$7.00
1¾	32.00	1⅜	13.25	¾	6.75
1¾	25.00	1¼	10.00	¾ and smaller	4.00
1⅝	21.25	1⅓	9.50		

Example: For 30 feet 1 inch diameter crucible cast steel switch rope, 6 strands, 19 wires to the strand, single fittings:

List price for fittings spliced in	\$7.00
List price of 30 feet 1 inch diameter cast steel rope at 31 cents foot	9.30
List price complete, 30 feet single switch rope	16.30

For convenient use, the list prices of Crucible Cast Steel Switching and Wrecking Ropes, complete, of different sizes and lengths are given below.

List Prices of Complete Locomotive Switching Ropes

Crucible Cast Steel

6 Strands—19 Wires to the Strand—One Hemp Core

Single Fittings

Hook and thimble in one end; thimble and link in the other end.

Length in Feet	Diameter in Inches								
	1¾	1⅝	1½	1⅜	1¼	1⅓	1	¾	¾
20	\$43.00	\$36.65	\$30.45	\$24.45	\$19.20	\$17.10	\$13.20	\$11.55	\$ 7.80
25	47.50	40.50	33.75	27.25	21.50	19.00	14.75	12.75	8.75
30	52.00	44.35	37.05	30.05	23.80	20.90	16.30	13.95	9.70
35	56.50	48.20	40.35	32.85	26.10	22.80	17.85	15.15	10.65
40	61.00	52.05	43.65	35.65	28.40	24.70	19.40	16.35	11.60
45	65.50	55.90	46.95	38.45	30.70	26.60	20.95	17.55	12.55
50	70.00	59.75	50.25	41.25	33.00	28.50	22.50	18.75	13.50

Breaking Strengths Locomotive Switching, Wrecking and Ballast Unloader Ropes

Crucible Cast Steel Rope

Diameter of rope in inches	1¾	1⅝	1½	1⅜	1¼	1⅓	1	¾	¾
Breaking strain in tons	85	72	64	56	47	38	30	23	17.5

Extra High Strength Plow Steel Rope

Diameter of rope in inches	1¾	1⅝	1½	1⅜	1¼	1⅓	1	¾	¾
Breaking strain in tons	112	94	82	72	58	47	38	29	23

**Locomotive Switching, Wrecking or Ballast Unloader
Rope**

Crucible Cast Steel Rope

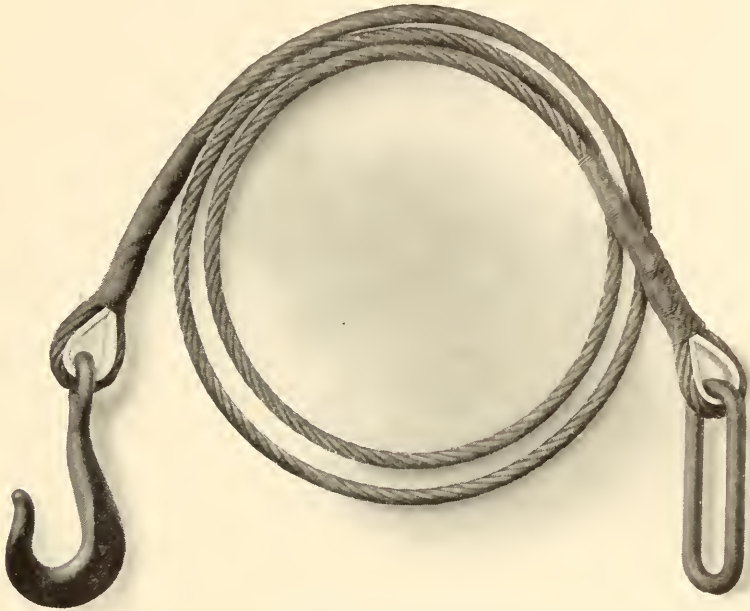

Single Fittings

Hook and thimble in one end; thimble and link in other end

**Extra High Strength Locomotive Switching, Wrecking
or Ballast Unloader Rope**

Plow Steel Rope

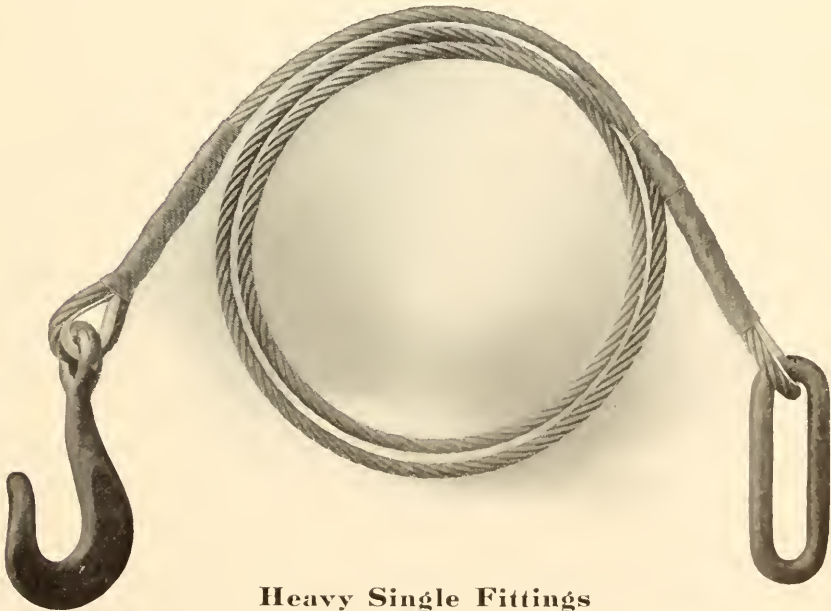

Heavy Single Fittings

Hook and thimble in one end; thimble and link in other end

Locomotive Switching, Wrecking and Ballast Unloader Rope

Double Fittings

Hook, thimble and link at one end; thimble and two links in other end.

List Prices for Fittings Spliced to Rope

Diameter in Inches	List Fittings	Diameter in Inches	List Fittings	Diameter in Inches	List Fittings
2	\$43.00	1½	\$21.25	1	\$9.00
1⅞	38.00	1⅜	16.75	7⁄8	8.50
1¾	30.00	1¼	13.00	¾ and smaller	5.50
1⅝	25.75	1⅓	12.00		

Extras for Other Styles

List for thimble and two links spliced in both ends is same as for *double*.

List for thimble and two links spliced in one end is *one-half* of *double*.

List for thimble and two links spliced in one end and thimble and hook other end, or thimble and link spliced in one end and thimble link and hook other end, is *half-way* between *single* and *double*.

For convenient use, the list prices of Crucible Cast Steel Switching and Wrecking Ropes, complete, of different sizes and lengths are given below.

List Prices of Complete Locomotive Switching Ropes

Crucible Cast Steel

6 Strands—19 Wires to the Strand—One Hemp Core

Double Fittings

Hook, thimble and link in one end; thimble and two links in the other end.

Length in Feet	Diameter in Inches								
	1¾	1⅝	1½	1⅜	1¼	1⅓	1	7⁄8	¾
20	\$48.00	\$41.15	\$34.45	\$27.95	\$22.20	\$19.60	\$15.20	\$13.30	\$ 9.30
25	52.50	45.00	37.75	30.75	24.50	21.50	16.75	14.50	10.25
30	57.00	48.85	41.05	33.55	26.80	23.40	18.30	15.70	11.20
35	61.50	52.70	44.35	36.35	29.10	25.30	19.85	16.90	12.15
40	66.00	56.55	47.65	39.15	31.40	27.20	21.40	18.10	13.10
45	70.50	60.40	50.95	41.95	33.70	29.10	22.95	19.30	14.05
50	75.00	64.25	54.25	44.75	36.00	31.00	24.50	20.50	15.00

Breaking Strengths Locomotive Switching, Wrecking and Ballast Unloader Rope

Crucible Cast Steel Rope

Diameter of rope in inches	1¾	1⅝	1½	1⅜	1¼	1⅓	1	7⁄8	¾
Breaking strain in tons	85	72	64	56	47	38	30	23	17.5

Extra High Strength Plow Steel Rope

Diameter of rope in inches	1¾	1⅝	1½	1⅜	1¼	1⅓	1	7⁄8	¾
Breaking strain in tons	112	94	82	72	58	47	38	29	23

**Locomotive Switching, Wrecking and Ballast Unloader
Rope**

Crucible Cast Steel Rope

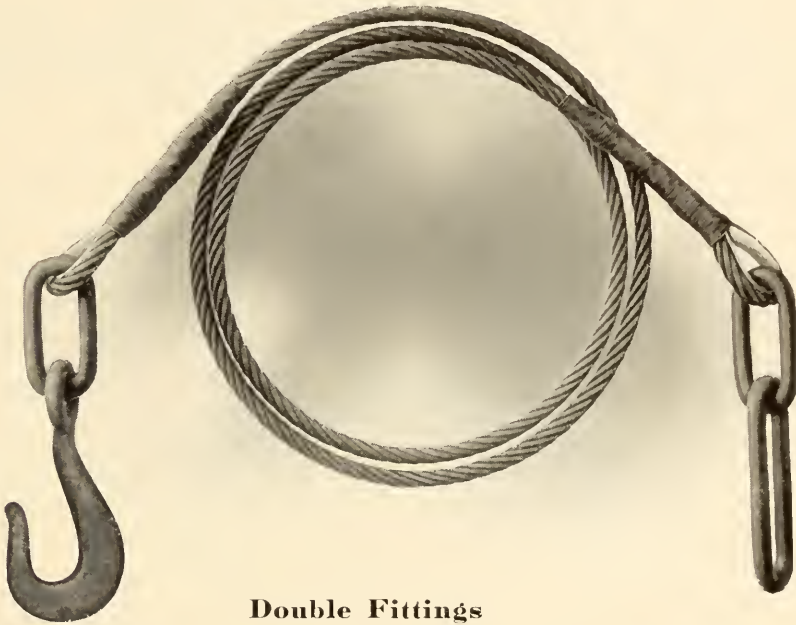

Double Fittings

Hook, thimble and link in one end; thimble and two links in the other end.

**Extra High Strength Locomotive Switching, Wrecking
and Ballast Unloader Rope**

Plow Steel Rope



Heavy Double Fittings

Hook, thimble and link at one end; thimble and two links in other end

Turnbuckles

Size Turnbuckle and Outside Diameter of Thread in Inches	Approximate Breaking Strength in Pounds	Recommended Working Load in Pounds	Amount of Take-up Length in the Clear Between Heads in Inches	Length of Buckle Outside in Inches	Galvanized List, Each	Plain List, Each	Length Pull to Pull When Extended in Inches	Approximate Weight Each in Pounds
$\frac{1}{4}$	1350	270	4	$4\frac{3}{4}$	\$0.85	\$0.75	12	.40
$\frac{5}{16}$	2250	450	$4\frac{1}{4}$	$5\frac{1}{4}$.90	.80	$13\frac{1}{2}$.60
$\frac{3}{8}$	3350	670	$4\frac{1}{2}$	$5\frac{3}{4}$	1.10	.90	14	.90
$\frac{7}{16}$	4650	930	5	$6\frac{1}{4}$	1.25	1.00	$16\frac{1}{2}$	1.31
$\frac{1}{2}$	6250	1250	6	$7\frac{1}{2}$	1.50	1.30	$18\frac{1}{4}$	1.87
$\frac{9}{16}$	8100	1620	$7\frac{1}{4}$	9	1.85	1.70	$23\frac{1}{8}$	3.00
$\frac{3}{8}$	10000	2000	$8\frac{1}{2}$	$10\frac{1}{2}$	2.20	1.80	$24\frac{1}{4}$	3.69
$\frac{3}{4}$	15000	3000	$9\frac{1}{4}$	$11\frac{3}{4}$	3.25	2.50	$27\frac{1}{2}$	5.81
$\frac{7}{8}$	21000	4200	10	$12\frac{3}{4}$	5.00	4.25	$30\frac{1}{2}$	8.81
1	27500	5500	11	14	5.50	4.75	33	12.56
$1\frac{1}{8}$	34500	6900	12	$15\frac{1}{2}$	7.00	5.25	39	17.00
$1\frac{1}{4}$	44500	8900	13	$16\frac{3}{4}$	8.25	6.25	40	25.00
$1\frac{3}{8}$	52500	10500	14	18	9.50	7.50	50	36.00
$1\frac{1}{2}$	64500	12900	15	$19\frac{1}{2}$	11.00	9.00	51	40.00
$1\frac{3}{8}$	75500	15100	16	21	15.00	13.00	$51\frac{1}{2}$	48.00
$1\frac{3}{4}$	87000	17400	18	23	20.00	17.00	$55\frac{1}{2}$	52.00
$1\frac{7}{8}$	102500	20500	18	23	25.00	22.00	66	89.00
2	115000	23000	24	31	28.00	25.00	74	98.00
$2\frac{1}{8}$	132500	26500	24	31	33.50	30.50
$2\frac{1}{4}$	151000	30200	24	32	38.50	35.00

Turnbuckles are necessary in many places, such as guy ropes, etc., to take up slack and maintain a uniform tension on each rope. From the strengths and working loads given the proper size is readily selected, which in every case should be equal to the strength of the rope as given in the price lists. Where greater take-up than given in column No. 4 is required, two turnbuckles may be used. State style of ends wanted.

Style No. 228 is most commonly used.

Turnbuckles

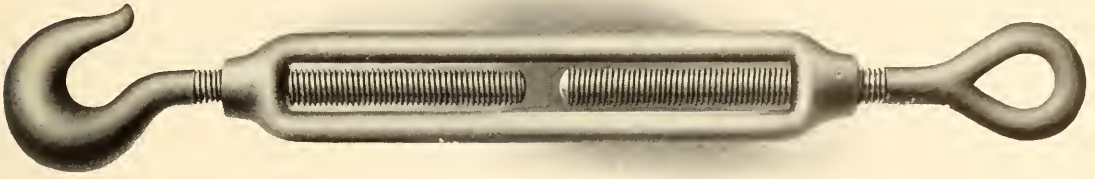

With Eye and Hook. Trade No. 2270

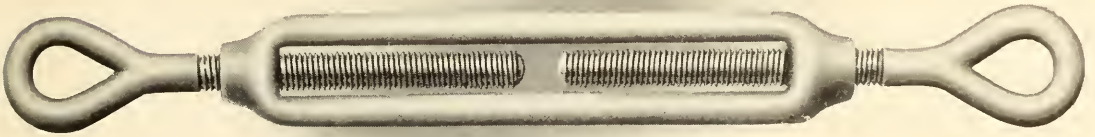

With Two Eyes. Trade No. 228

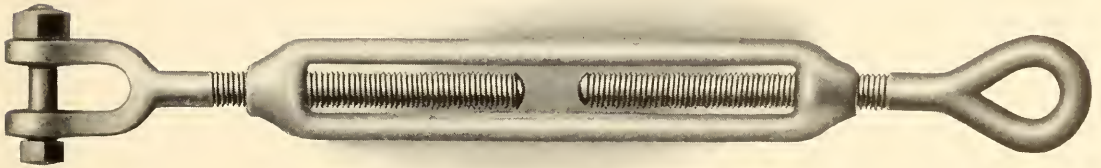

With Shackle and Eye. Trade No. 229

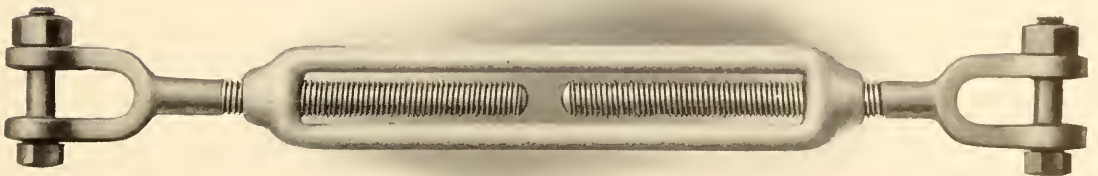

With Two Shackles. Trade No. 2290

Iron Guy Shackles

Galvanized or Black

Select size of shackle having strength equal to rope with which it is to be used.



Size in Inches of Shackle (Diam. of Iron in Bow)	List Galvanized Each	List Black Each	Gov. Test Max. Strength in Pounds	Length Inside Inches	Width Between Eyes Inches	Diam. of Pin in Inches	Approximate Weight of Each in Pounds
$\frac{3}{8}$	\$0.25	\$0.23	10,890	$1\frac{3}{8}$	$\frac{5}{8}$	$\frac{1}{2}$	0.30
$\frac{7}{16}$.30	.28	15,200	$1\frac{3}{4}$	$\frac{13}{16}$	$\frac{9}{16}$	0.48
$\frac{1}{2}$.36	.32	18,390	$1\frac{7}{8}$	$\frac{13}{16}$	$\frac{5}{8}$	0.70
$\frac{9}{16}$.40	.36	24,800	$1\frac{7}{8}$	$\frac{7}{8}$	$\frac{11}{16}$	0.90
$\frac{5}{8}$.46	.40	33,400	$2\frac{1}{4}$	$1\frac{3}{16}$	$\frac{3}{4}$	1.40
$\frac{3}{4}$.55	.46	43,400	3	$1\frac{9}{16}$	$\frac{7}{8}$	2.20
$\frac{7}{8}$.73	.61	55,200	$3\frac{1}{2}$	$1\frac{3}{8}$	1	3.40
1	1.08	.84	74,900	4	$1\frac{3}{4}$	$1\frac{1}{8}$	5.00
$1\frac{1}{8}$	1.67	1.34	90,200	$4\frac{1}{2}$	$1\frac{7}{8}$	$1\frac{1}{4}$	6.80
$1\frac{1}{4}$	2.10	1.67	92,040	5	2	$1\frac{3}{8}$	9.40
$1\frac{3}{8}$	2.70	2.15	94,100	$5\frac{1}{2}$	$2\frac{1}{8}$	$1\frac{1}{2}$	12.20
$1\frac{1}{2}$	3.60	2.90	103,800	6	$2\frac{1}{4}$	$1\frac{5}{8}$	16.40
$1\frac{5}{8}$	4.20	3.35	155,542	$6\frac{1}{2}$	$2\frac{1}{2}$	$1\frac{3}{4}$	19.00
$1\frac{3}{4}$	5.30	4.25	172,400	7	$2\frac{3}{4}$	$1\frac{7}{8}$	24.00
2	9.25	7.55	235,620	8	$3\frac{1}{4}$	$2\frac{1}{8}$	38.20

Shackles are used to connect ropes, the ends of which are equipped with thimbles, sockets, turnbuckles, etc.

Heavy Wire Rope Blocks

“American” Wire Rope Blocks are noted for their liberal dimensions, exceptional strength and weight. They are made in all sizes, single, double, triple and quadruple, with shackles, with and without plain or swivel hooks.

Sheaves are made of specially selected iron, hard enough to prevent rapid wear from rope and tough enough to prevent fracture from such rough handling as a block is constantly required to withstand.

Bushings Sheaves can be furnished plain bore or with the well-known “American” self-lubricating bushing, a factor which increases the life of a sheave fifty per cent. over the ordinary common bushed sheave. They do not cut the axles and new bushings can be put in an old sheave.

Grooves are ground smooth and true to size to prevent undue wear on the rope. Hubs are accurately bored so that bushings can be renewed at any time.

Axles are of generous dimensions, fastened so as to prevent their turning with the sheave. When sheave is to be lubricated by hard grease the axle is center bored and a heavy malleable grease cup is screwed on the axle.

Shells The sheaves on our blocks are guarded by heavy steel plates which protect the sheaves from chipping or breaking, and absolutely prevent the rope from jumping the sheave. They are well turned to prevent chafing of the rope.

Pins are of very hard cold rolled steel of ample size for the requirements.

Hooks The “American” hook is of the finest quality of forging steel and of exceptional weight and strength. Either swivel or plain “American” hooks are interchangeable one with another and between single and double blocks.

Shackles Can be attached to any “American” block when desired. They are of the same quality as the hooks and exceptionally strong.



217

Heavy Wire Rope Block

With Plain Hook

Outside Diameter of Sheaves Inches	Diameter Rope Inches	Iron Bearings		Self-lubricating Bushings	
		Price Single	Price Double	Price Single	Price Double
11	3/8 or 1/2	\$ 9.00	\$14.50	\$10.00	\$16.50
14	5/8 or 3/4	10.00	17.50	11.00	19.50
16	3/4	12.00	23.50	13.00	25.50
18	7/8	19.00	32.00	21.00	36.00
20	1	21.50	35.00	23.50	39.00

Checks for Wire Rope Blocks

The checks are cast iron weights suitable for the requirements made to overhaul the line of the hoisting drum. They are neat and can be attached to any "American" Block.



Cut 218 (With Cheek)



722

Blocks	11 Inches Price	14 Inches Price	16 Inches Price	18 Inches Price	20 Inches Price
Light checks
Heavy checks

Heavy Wire Rope Block

With Swivel Hook



218

Outside Diameter of Sheaves Inches	Diameter Rope Inches	Iron Bearings		Self-lubricating Bushings	
		Price Single	Price Double	Price Single	Price Double
11	3/8 or 1/2	\$13.00	\$15.50	\$14.00	\$17.50
14	5/8 or 3/4	14.00	21.50	15.00	23.50
16	3/4	19.00	34.50	20.00	36.50
18	7/8	34.50	45.00	36.50	49.00
20	1	37.00	48.00	39.00	52.00

Wire Rope Snatch Blocks

This is of the strongest construction possible. The block is locked and unlocked by turning the hook and head to the required angle. This is easily accomplished and still always leaves the block securely locked.



429

Outside Diameter of Sheaves Inches	Diameter Rope Inches	Iron Bearings Price	Self-lubricating Bushings Price
11	3/8 or 1/2	\$15.00	\$16.00
14	5/8 or 3/4	16.50	17.50
16	3/4	24.00	25.00
18	7/8	31.50	33.50



219

Heavy Wire Rope Block

Without Hook

Outside Diameter of Sheave Inches	Diameter of Rope Inches	Iron Bearings		Self-lubricating Bushings	
		Price Single	Price Double	Price Single	Price Double
11	$\frac{3}{8}$ or $\frac{1}{2}$	\$ 6.50	\$ 9.00	\$ 7.50	\$11.00
14	$\frac{5}{8}$ or $\frac{3}{4}$	7.50	11.00	8.50	13.00
16	$\frac{3}{4}$	8.50	12.00	9.50	14.00
18	$\frac{7}{8}$	12.00	17.00	14.00	21.00
20	1	14.50	20.00	16.50	24.00



Heavy Wire Rope Block

With Shackle

Outside Diameter of Sheave Inches	Diameter of Rope Inches	Self-lubricating Bushings	
		Triple, Price	Quadruple, Price
14	$\frac{5}{8}$ or $\frac{3}{4}$	\$26.00	\$32.00
16	$\frac{3}{4}$	35.00	45.00
18	$\frac{7}{8}$	46.00	57.00
20	1	60.00	75.00

Solid Iron Sheaves

For Elevators and Derricks

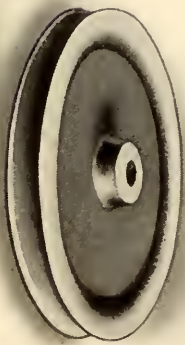

Outside Diameter of Sheave Inches	Diameter at Bottom of Groove Inches	Finished Standard Bore	Thickness Through the Hub	Maximum Size of Rope that can be Used	Net Price Each
30	27	2 1/2	3	1	\$12.00
28	25	2 1/2	3	1	10.50
26	23	2 1/2	3	1	9.00
24	21	2 1/2	3	1	8.00
22	19	2	3	1	7.00
20	17	2	2 1/4	1	5.75
18	15 1/4	1 3/4	2 1/4	1	4.50
16	13 1/2	1 1/2	2	1	4.00
14	12	1 1/2	2	1	3.25
12	10	1 1/2	2	3/4	2.50
10	8 1/2	1 1/4	2	3/8	1.50
8	6 1/2	1 1/4	2	1/2	1.30

List Prices for Labor for Splicing Endless Rope

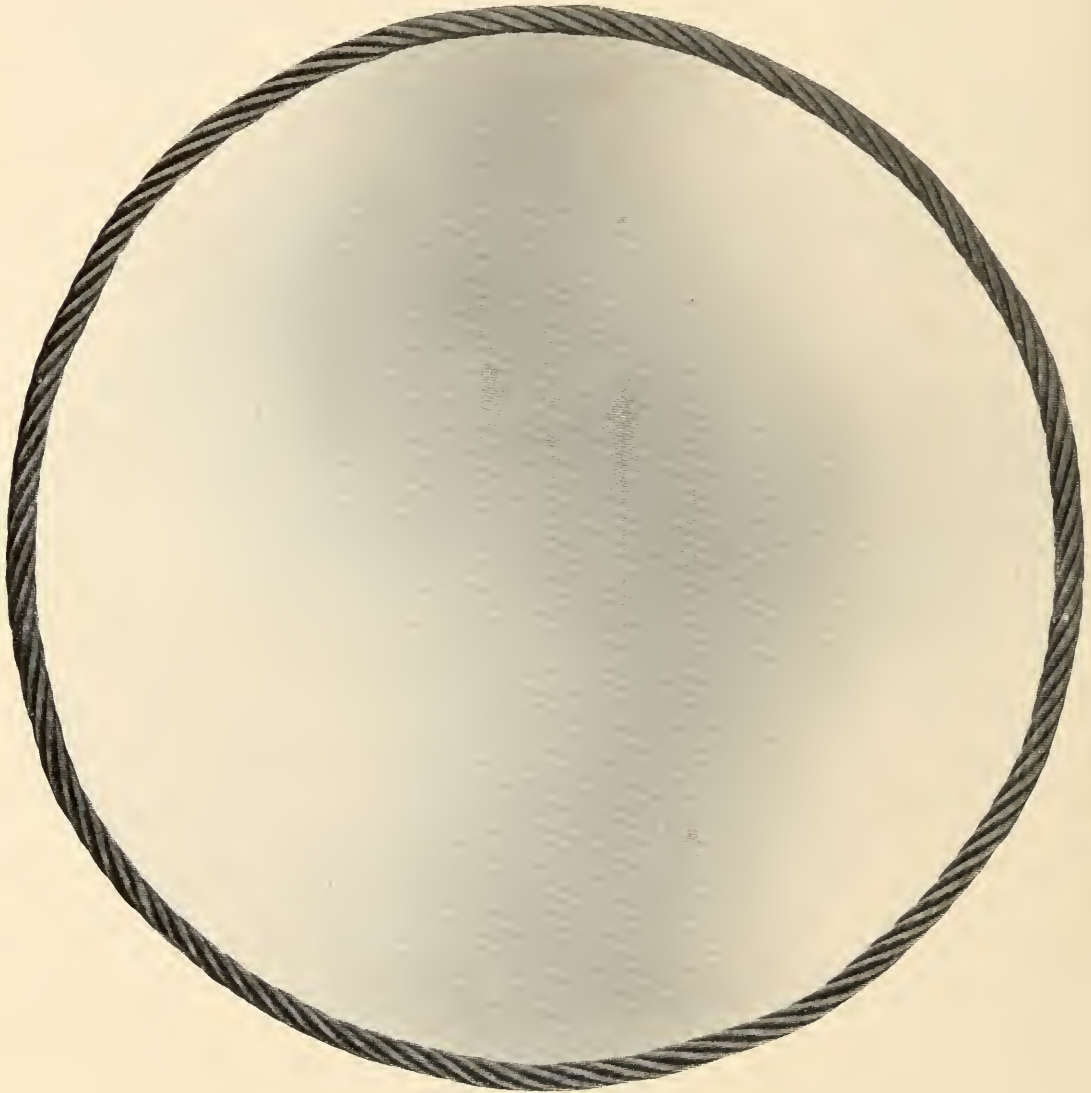

Diameter of Rope in Inches	List Prices	Diameter of Rope in Inches	List Prices
$1\frac{1}{2}$ to $1\frac{1}{4}$	\$4.50	$\frac{7}{16}$ to $\frac{3}{8}$	\$3.00
$1\frac{1}{8}$ to $\frac{7}{8}$	4.00	$\frac{5}{16}$ to $\frac{1}{4}$	2.50
$\frac{3}{4}$ to $\frac{1}{2}$	3.50		

The above charges are for labor in making splices at our works, and do not include the additional 20 to 30 feet of rope used in making the splice. A special charge will be made for splicing done elsewhere, such charge depending on the circumstances of each individual case.

Exact lengths of endless transmission ropes should be specified, or else the exact distance from center to center of wheels, together with circumference of wheels.

Wire Rope Slings

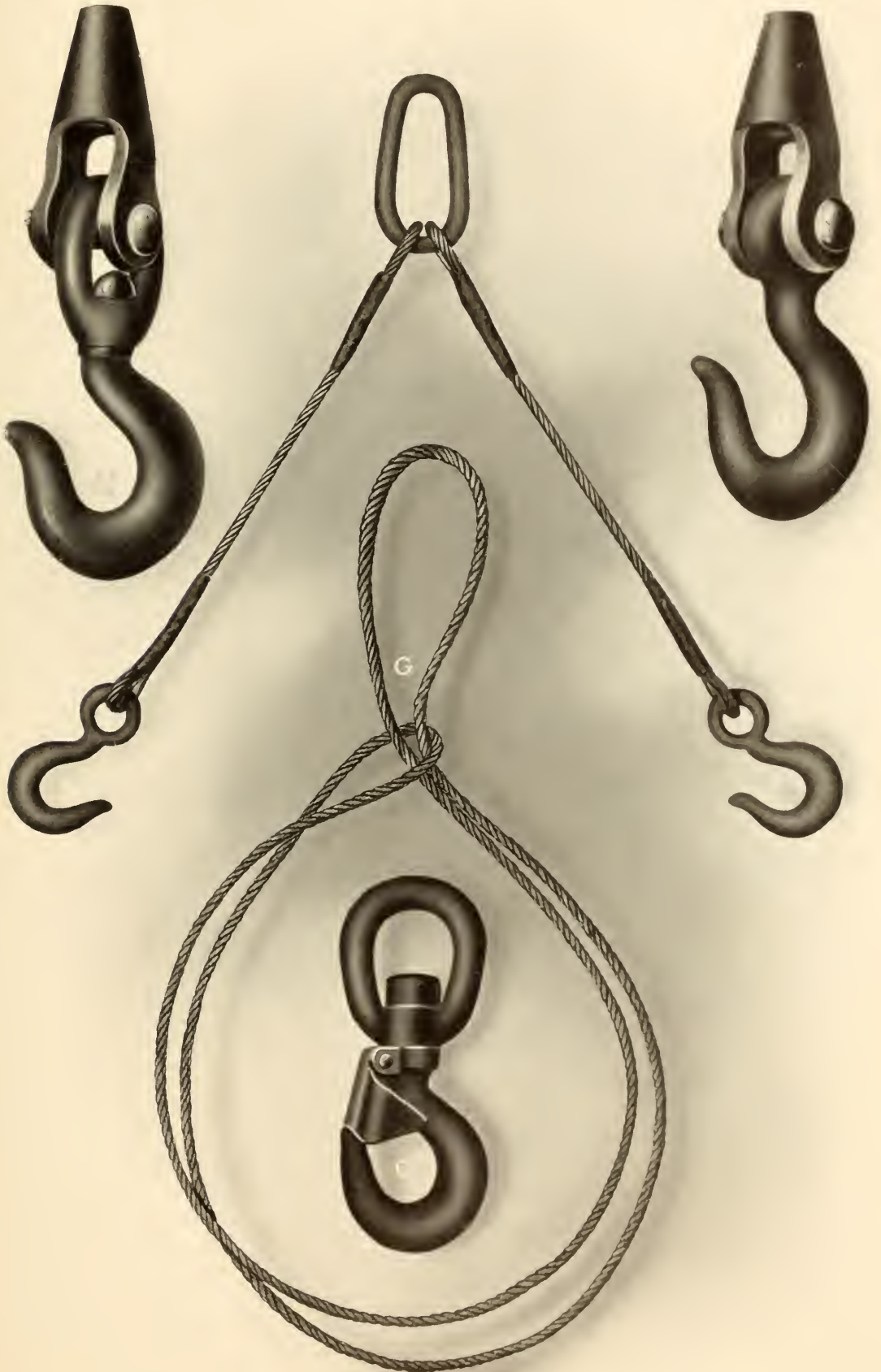

Wire Rope Slings

On the preceding page are illustrated two kinds of wire rope slings selected from the many which may be made. Also several special rope fittings, the use of which is self explanatory.

- A. Socket and swivel hook.*
- B. Socket and hook.*
- C. Self-locking swivel hook.*

Sling "D" as shown is equipped with two hooks, "E" and "F," but it is frequently made with special round links instead of the hooks. Such a modified sling is useful for handling heavy shafting, dynamos, motors, etc., or several slings may be used to lift locomotives or similar machinery.

Sling "G" consists of a wire rope spliced endless. This may be passed around a block of stone or similar object and the end of the loop put into a crane or derrick hook.

Where extra strong slings are required, these are made in such a manner as to give maximum strength.

Suggestions for other types of slings are shown on page 71.

In ordering slings for special work, a blue print or sketch with full particulars should accompany each order.

Extra Flexible Plow Steel Pulling-in Cables

8 Strands—19 Wires Each—1 Hemp Center

Thimble spliced in one end.

Thimble, swivel and sister hooks spliced in other end.

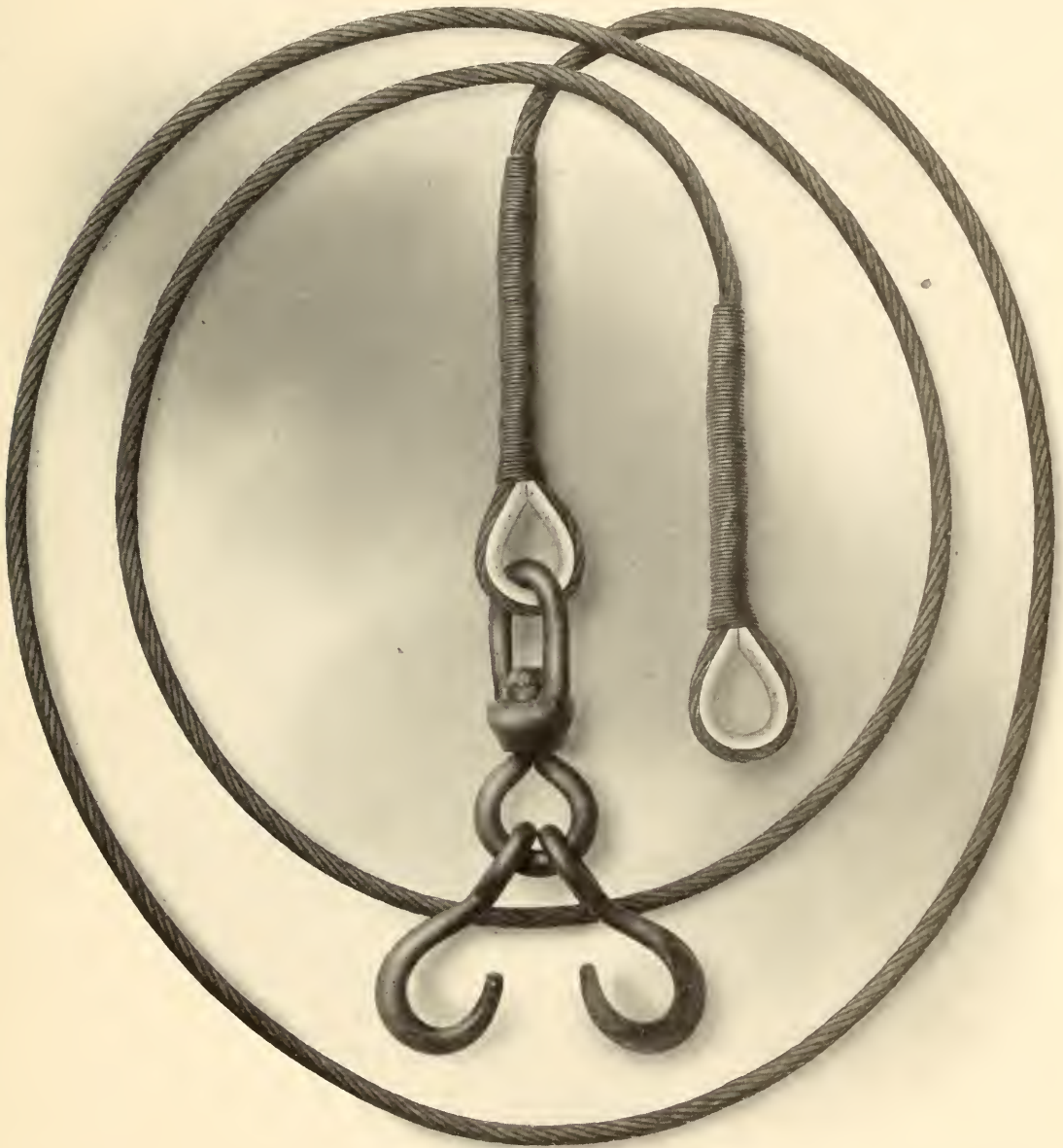

Diameter of Rope in Inches	List Prices of Rope Per Foot	List Prices of Thimble Spliced In	List Prices of Thimble, Swivel and Sister Hooks Complete Spliced In
$\frac{5}{8}$	\$0.21	\$1.55	\$5.90
$\frac{9}{16}$.18	1.30	5.00
$\frac{1}{2}$.16	1.25	4.70
$\frac{7}{16}$.15	1.20	4.00
$\frac{3}{8}$.14	1.15	3.70
$\frac{5}{16}$.13½	1.10	3.20

These cables are used for pulling electrical cables into underground conduits, and for cleaning sewers. The sister hooks snap into the eye of a wire pulling grip that is attached to the end of the cable to be drawn into the conduit. The thimble end of the rope is wound on a small drum or hand winch. The most common sizes are $\frac{3}{8}$ inch and $\frac{1}{2}$ inch diameter. The lengths vary from 300 feet to 600 feet, measured from pull of thimble to pull of sister hooks.

In ordering, state diameter of conduit or pipe in which rope is to be used.

Directions for Splicing Wire Rope

The tools required are a small marline-spike, nipping cutters, and either clamps or a small hemp rope sling with which to wrap around and untwist the rope. If a bench vise is accessible, it will be found very convenient for holding the rope.

In splicing rope, a certain length is used up in making the splice. An allowance of not less than 16 feet for $\frac{1}{2}$ -inch rope, and proportionately longer for larger sizes, must be added to the length of an endless rope, in ordering.

This extra length is equal to the distance "EE" in Fig 1, page 232. The additional length recommended for making a splice in different sizes of wire rope is as follows :

Diameter of Rope in Inches	Extra Length Allowed for the Splice, Feet	Diameter of Rope in Inches	Extra Length Allowed for the Splice, Feet
$\frac{3}{8}$	16	1	32
$\frac{1}{2}$	16	$1\frac{1}{8}$	36
$\frac{5}{8}$	20	$1\frac{1}{4}$	40
$\frac{3}{4}$	24	$1\frac{1}{2}$	44
$\frac{7}{8}$	28		

Having measured carefully the length the rope should be after splicing and marked the points M and M' (Fig. 1), unlay the strands from each end E and E' to M and M' , and cut off the hemp center at M and M' , and then :

First. Interlock the six unlayed strands of each end alternately, cutting off the hemp centers at M and M' and draw wire strands together, so that the points M and M' meet, as shown in Fig. 2.

Second. Unlay a strand from one end, and following the unlay closely, lay into the seam or groove it opens the strand opposite it belonging to the other end of the rope, until there remains a length of strand equal in inches to the length of splice EE in feet, e. g., the straight end of the inlaid strand A on one-half inch rope equal 16 inches for 16-foot splice. Then cut the other strand to about the same length from the point of meeting, as shown at A (Fig. 3).

Third. Unlay the adjacent strand in the opposite direction, and following the unlay closely, lay in its place the corresponding opposite strand, cutting the ends as described before at B (Fig. 3).

The four strands are now laid in place terminating at A and B , with the eight remaining at M and M' , as shown in Fig. 3.

It will be well after laying each pair of strands to tie them temporarily at the points *A* and *B*.

Pursue the same course with the remaining four pairs of opposite strands, stopping each pair of strands so as to divide the space between *A* and *B* into five equal parts, as shown in Fig. 4, and cutting the ends as before.

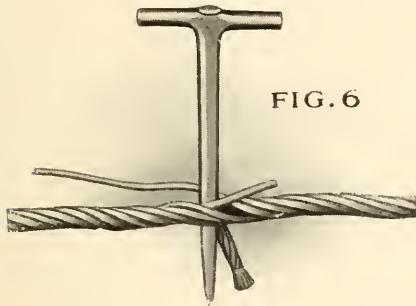

FIG. 6

All the strands are now laid in their proper places with their respective ends passing each other, as shown in Fig. 4.

All methods of rope splicing are identical up to this point; their variety consists in the method of securing the ends. One good way is as follows:

Clamp the rope either in a vise at a point to the left of *A* (Fig. 4), and by a hand clamp applied near *A* open up the rope by untwisting sufficiently to cut the hemp core at *A*, and seizing it with the nippers, let your assistant draw it out slowly. Then insert a marlin spike under the two nearest strands to open up the rope and starting the loose strand into the space left vacant by the hemp center, rotate the marlin spike so as to run the strand into the center. Cut the hemp core where the strand ends, and push the end of hemp back into its place. Remove the clamps and let the rope close together around it. Draw out the hemp core in the opposite direction and lay the other strand in the center of the rope in the same manner. Repeat the operation at the five remaining points, and hammer the rope lightly at the points where the ends pass each other at *A*, *A'*, *B*, *B'*, etc., with small wooden mallets, and the splice is complete, as shown in Fig. 5.

If a clamp and vise are not obtainable, two rope slings and short wooden levers may be used to untwist and open up the rope.

A rope spliced as above will be nearly as strong as the original rope, and smooth everywhere. After running a few days, the splice, if well made, cannot be pointed out except by the close examination of an expert.

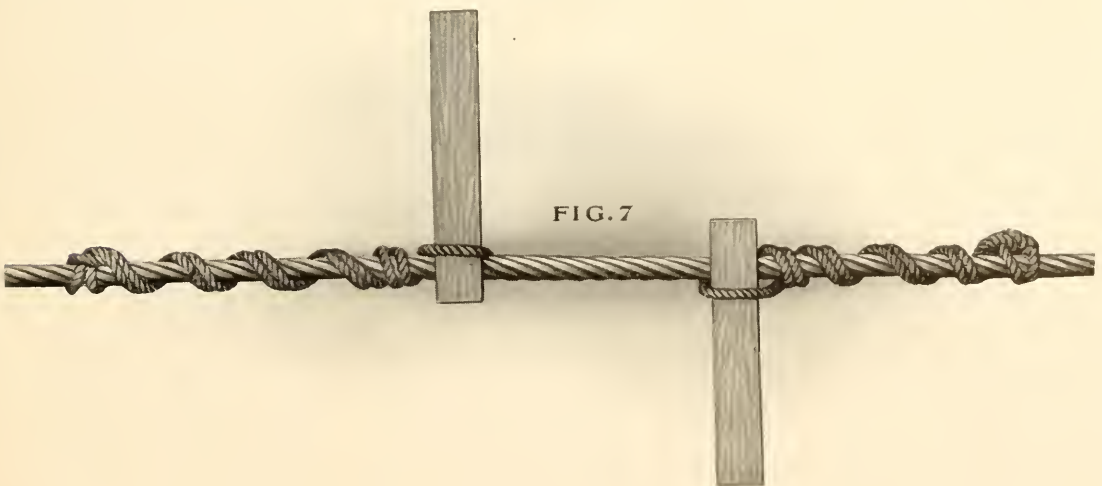

FIG. 7

FIG. 1



M'

E'



FIG. 2

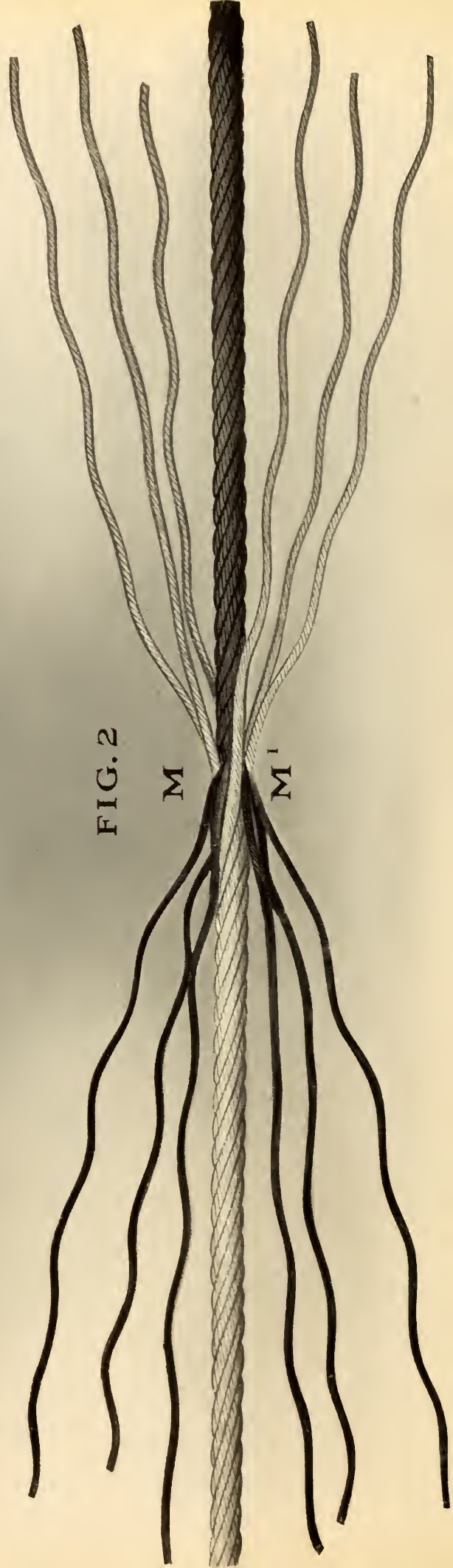

FIG. 3

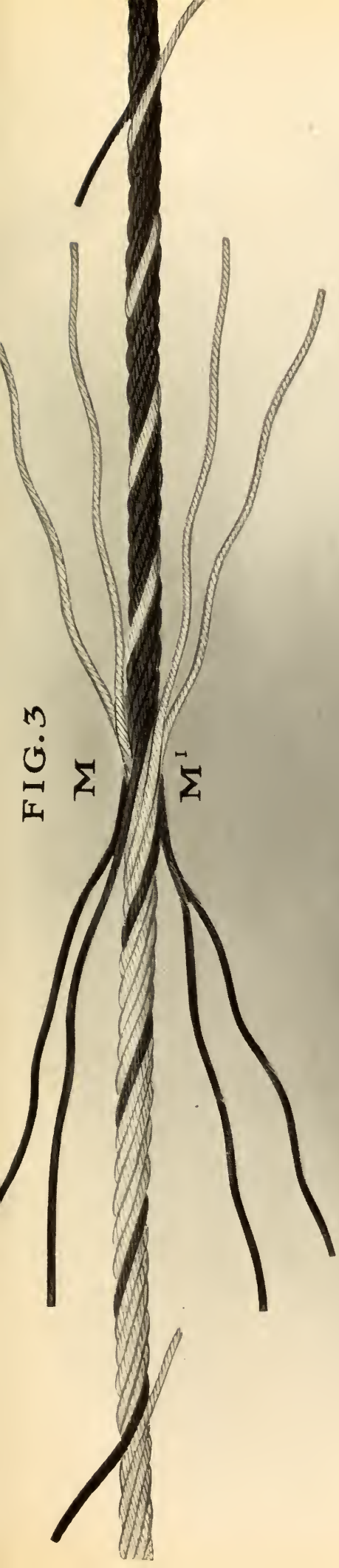

FIG. 4

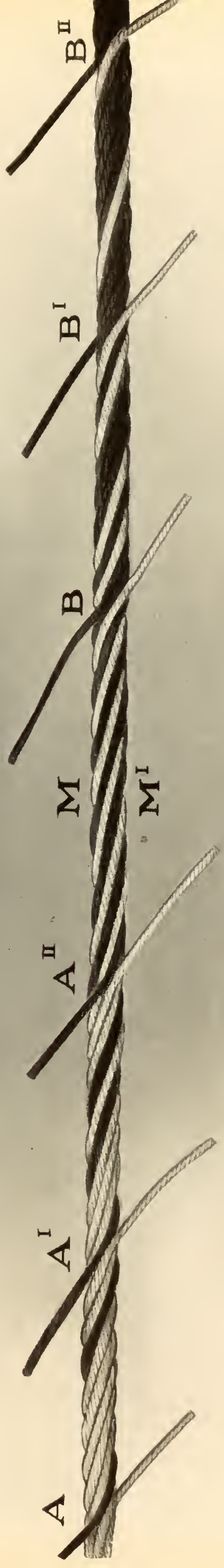
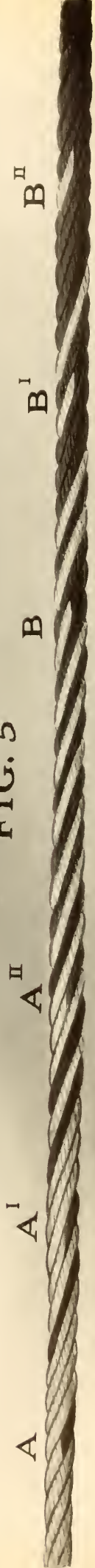

FIG. 5



Power Transmitted by Wire Rope

A table showing the proper relation between the rope and wheels used in transmitting power by means of wire rope, and approximately the amount of power that may be thus transmitted. The calculations are based upon a rope of the 6 strand, 7 wires per strand construction, as described on page 121.

Diameter of Wheel in Feet	Number of Revolutions per Minute	Diameter of Rope	Horse-power	Diameter of Wheel in Feet	Number of Revolutions per Minute	Diameter of Rope	Horse-power
3	80	$\frac{3}{8}$	3	7	140	$\frac{9}{16}$	35
3	100	$\frac{3}{8}$	$3\frac{1}{2}$	8	80	$\frac{5}{8}$	26
3	120	$\frac{3}{8}$	4	8	100	$\frac{5}{8}$	32
3	140	$\frac{3}{8}$	$4\frac{1}{2}$	8	120	$\frac{5}{8}$	39
4	80	$\frac{3}{8}$	4	8	140	$\frac{5}{8}$	45
4	100	$\frac{3}{8}$	5	9	80	$\frac{9}{16}$	47
4	120	$\frac{3}{8}$	6	9	100	$\frac{5}{8}$	48
4	140	$\frac{3}{8}$	7	9	120	$\frac{9}{16}$	58
5	80	$\frac{7}{16}$	9	9	140	$\frac{5}{8}$	60
5	100	$\frac{7}{16}$	11	10	80	$\frac{9}{16}$	69
5	120	$\frac{7}{16}$	13	10	100	$\frac{5}{8}$	73
5	140	$\frac{7}{16}$	15	10	120	$\frac{9}{16}$	82
6	80	$\frac{1}{2}$	14	10	140	$\frac{5}{8}$	84
6	100	$\frac{1}{2}$	17	12	80	$\frac{11}{16}$	64
6	120	$\frac{1}{2}$	20	12	100	$\frac{3}{4}$	68
6	140	$\frac{1}{2}$	23	12	120	$\frac{11}{16}$	80
7	80	$\frac{9}{16}$	20	12	120	$\frac{3}{4}$	85
7	100	$\frac{9}{16}$	25	14	80	$\frac{11}{16}$	96
7	120	$\frac{9}{16}$	30	14	100	$\frac{3}{4}$	102
						$\frac{11}{16}$	112
						$\frac{1}{2}$	119
						$\frac{11}{16}$	93
						$\frac{3}{4}$	99
						$\frac{11}{16}$	116
						$\frac{3}{4}$	124
						$\frac{11}{16}$	140
						$\frac{3}{4}$	149
						$\frac{7}{8}$	173
						1	141
						$1\frac{1}{8}$	148
						1	176
						$1\frac{1}{8}$	185

Comparatively few places now use wire rope for power transmission only, but the above table gives data sufficient for such cases.

Weights of Materials Handled by Wire Rope

Material	Weight per Cubic Foot	Material	Weight per Cubic Foot
Aluminum	166.5	Lead	710
Anthracite, Pennsylvania, solid	96	Lime, quick, loose	53-75
Anthracite, Pennsylvania, broken	55- 66	Limestone	170-200
Ash, dry	38	Magnesium	109
Asphaltum	87	Mahogany, dry	35- 53
Brass	504-524	Maple, dry	49
Brick, soft	100	Marble	160-180
Brick, hard	125	Masonry, granite, limestone or sandstone	144-165
Brick, pressed	135	Mica	183
Brick, fire	140-150	Mortar	90-100
Brickwork	112-140	Mud, dry	80-110
Cast iron	450	Mud, wet, maximum	120
Cement, Portland, loose	60	Oak, live, dry	59
Cement, Rosendale, loose	78	Oak, white, dry	48
Cherry, dry	42	Petroleum	55
Chestnut, dry	35	Pine, white, dry	25-30
Clay	120-150	Pine, yellow, Northern	34
Coal, broken, bituminous	50- 55	Pine, yellow, Southern	45
Coal, solid, bituminous	84	Platinum	1344
Coke	63	Quartz	165
Concrete	120-140	Rosin	69
Copper	554	Salt	45- 49
Earth, common loam, loose	72- 80	Sand, dry and loose	90-106
Earth, common loam, shaken	82- 92	Sand, perfectly wet	118-129
Earth, common loam, rammed moderately	90-100	Sandstone	144
Earth, as soft as flowing mud	104-120	Shales, red or black	162
Elm, dry	35	Silver	655
Felspar	162	Slate	175
Flint	164	Snow	5- 12
Glass	156-172	Soapstone	166-175
Gold	1208	Spruce	25
Grain at 60 pounds per bushel	48	Steel	490
Granite	160-170	Sulphur	125
Gravel	90-106	Sycamore	37
Gypsum (plaster of Paris)	143	Tar	62
Hemlock, dry	24	Tile	110-120
Hickory, dry	53	Tin, cast	459
Ice	58.7	Trap rock	170-200
Iron ore, magnetic	317	Turf or peat, dry	20- 30
Iron ore, red hematite	327	Walnut, black, dry	38
Iron ore, brown hematite	245	Water, pure	62.3
Iron ore, spathic	239	Zinc	437
Iron, cast	450		
Iron, wrought	480		

Numbers and Dimensions of Reels

For Wire Rope and Strand—Worcester Works

No.	Diameter of Head in Inches	Diameter of Barrel in Inches	Width Inside in Inches	Width Outside in Inches	Arbor Hole in Inches	Average Weight in Pounds
W 600	6	4 $\frac{1}{4}$	1 $\frac{1}{4}$	2	2	1
W 601	6	4 $\frac{1}{4}$	2	2 $\frac{3}{4}$	2	1
W 602	8	4 $\frac{1}{2}$	5 $\frac{1}{2}$	7 $\frac{1}{4}$	2	2
W 603	8	4 $\frac{1}{2}$	5 $\frac{1}{2}$	7 $\frac{1}{4}$	1 $\frac{1}{4}$	2
W 604	20	9	8	11 $\frac{1}{2}$	2 $\frac{1}{8}$	12
W 605	28	14	13 $\frac{1}{2}$	18	3 $\frac{3}{4}$	32
W 606	32	15 $\frac{7}{8}$	13 $\frac{1}{2}$	18	3 $\frac{3}{4}$	82
W 607	32	16	15	19 $\frac{1}{2}$	7 $\frac{1}{4}$	80
W 608	38	20	22 $\frac{1}{2}$	27 $\frac{3}{4}$	7 $\frac{1}{4}$	165
W 609	44	24	23	27 $\frac{1}{2}$	7 $\frac{1}{4}$	190
W 610	50	28	32	37 $\frac{1}{4}$	7 $\frac{1}{4}$	340
W 611	56	30	35 $\frac{3}{4}$	42	7 $\frac{1}{4}$	475
W 612	56	30	41 $\frac{3}{4}$	48	7 $\frac{1}{4}$	490
W 613	60	30	41 $\frac{3}{4}$	48	7 $\frac{1}{4}$	550
W 614	66	30	41 $\frac{3}{4}$	48	7 $\frac{1}{4}$	610
W 615	50	25 $\frac{3}{4}$	16	19 $\frac{1}{2}$	11 $\frac{1}{4}$	320
W 617	35	15 $\frac{7}{8}$	13 $\frac{1}{2}$	18	3 $\frac{3}{4}$	80
W 618	36	15 $\frac{7}{8}$	14 $\frac{1}{2}$	18	3 $\frac{3}{4}$	85
W 619	72	30	47	53 $\frac{1}{4}$	7 $\frac{1}{4}$	1045
W 622	80	40	47 $\frac{1}{2}$	58	16 $\frac{1}{2}$	1800
W 623	84	40	60 $\frac{1}{2}$	71	16 $\frac{1}{2}$	2000
W 624	90	40	60 $\frac{1}{2}$	73	16 $\frac{1}{2}$	2600
W 625	90	40	72	84	16 $\frac{1}{2}$	3100
W 626	94	40	72	84	16 $\frac{1}{2}$	4000
W 627	102	42	85	98	16 $\frac{1}{2}$	6000
W 628	112	44	89	102	16 $\frac{1}{2}$	6100
W 629	116	44	85	98	16 $\frac{1}{2}$	6500
W 630	28	13 $\frac{7}{8}$	13 $\frac{1}{2}$	18	3 $\frac{3}{4}$	32
W 631	92	40	44 $\frac{1}{2}$	52	16 $\frac{1}{2}$ & 9	3600
W 633	50	28	23	28 $\frac{1}{4}$	7 $\frac{1}{4}$	360
W 634	56	40	34	40 $\frac{1}{4}$	7 $\frac{1}{4}$	500
W 635	60	40	35 $\frac{3}{4}$	42	7 $\frac{1}{4}$	580
W 636	66	36	33 $\frac{3}{4}$	40	7 $\frac{1}{4}$	650
W 638	80	36	32 $\frac{3}{4}$	39	7 $\frac{1}{4}$	1600
W 641	35	24	16	20 $\frac{1}{2}$	7 $\frac{1}{4}$	106
W 642	50	28	32	37 $\frac{1}{4}$	7 $\frac{1}{4}$	372
W 643	44	24	22 $\frac{1}{2}$	27	7 $\frac{1}{4}$	642
W 644	100	36	40	53	16 $\frac{1}{2}$	2900
W 645	78	36	42	53	16 $\frac{1}{2}$	1600
W 646	20	9	8	11 $\frac{1}{2}$	2 $\frac{1}{8}$	25
W 647	10	3 $\frac{3}{4}$	6	9 $\frac{1}{2}$	$\frac{7}{8}$	10
W 648	15	6	4 $\frac{3}{4}$	8 $\frac{1}{4}$	$\frac{7}{8}$	16 $\frac{1}{2}$
W 649	24	10	20 $\frac{1}{2}$	24	3 $\frac{3}{4}$	38
W 650	22	10	19	22 $\frac{1}{2}$	3 $\frac{3}{4}$	35
W 651	28	14	13 $\frac{1}{2}$	17	4	51
W 653	12	4 $\frac{1}{2}$	5 $\frac{1}{2}$	7 $\frac{1}{4}$	2	4
W 654	16	10	8	10 $\frac{1}{2}$	2 $\frac{3}{8}$	11
W 655	42	30	23	27 $\frac{3}{4}$	7 $\frac{1}{4}$	160
W 656	12	4	5 $\frac{1}{4}$	7	1 $\frac{5}{16}$	6
W 657	12	4 $\frac{1}{2}$	6 $\frac{1}{2}$	8 $\frac{1}{2}$	1 $\frac{3}{8}$	6

Tensile Strength, Manila and Wire Rope Compared Approximate Breaking Stress Calculated in Tons of 2,000 Pounds

Diameter in Inches	Wire Transmission Rope. One hemp core surrounded by six strands of seven wires each.				Wire Hoisting Rope. One hemp core surrounded by six strands of nineteen wires each.				Average Quality New Manila Rope
	Iron	Crucible Cast Steel	Extra Strong Crucible Cast Steel	Plow Steel	Iron	Crucible Cast Steel	Extra Strong Crucible Cast Steel	Plow Steel	
	Tons	Tons	Tons	Tons	Tons	Tons	Tons	Tons	Tons
2 3/4	111	211	243	275	26
2 1/2	92	170	200	229	21
2 1/4	72	133	160	186	17
2	55	106	123	140	13 1/2
1 3/4	44	85	99	112	11
1 5/8	38	72	83	94	9 1/2
1 1/2	32	63	73	82	33	64	73	82	8
1 3/8	28	53	63	72	28	56	64	72	7
1 1/4	23	46	54	60	22.8	47	53	58	6
1 1/8	19	37	43	47	18.6	38	43	47	5
1	15	31	35	38	14.5	30	34	38	4
7/8	12	24	28	31	11.8	23	26	29	3
3/4	8.8	18.6	21	23	8.5	17.5	20.2	23	2 1/4
5/8	6	13	14.5	16	6	12.5	14	15.5	1 1/2
9/16	4.8	10	11	12	4.7	10	11.2	12.3	1 1/4
1/2	3.7	7.7	8.85	10	3.9	8.4	9.2	10	1
7/16	2.6	5.5	6.25	7	2.9	6.5	7.25	8	3/4
3/8	2.2	4.6	5.25	5.9	2.4	4.8	5.30	5.75	1/2
5/16	1.7	3.5	3.95	4.4	1.5	3.1	3.50	3.8	3/8
9/32	1.2	2.5	2.95	3.4	3/10
1/4	1.1	2.2	2.43	2.65	1/4

Signal Strand Reels All Works

No.	Diameter of Head in Inches	Diameter of Barrel in Inches	Width Inside in Inches	Width Outside in Inches	Arbor Hole in inches	Average Weight in Pounds
700	42	20	24	27 1/2	23 1/4	150
701	38	20	24	27 1/2	23 1/4	115
702	36	20	24	27 1/2	21 1/2	105
703	35	16	14 1/2	18	21 1/2	80
704	35	16	13 1/2	17	21 1/4	75
705	34	12	16	19 1/2	21 1/2	80
706	32	12	16	19 1/2	21 1/2	70
707	32	12	13 1/2	17	23 1/4	65
708	32	16	14 1/2	18	21 1/2	68
709	30	12	16	19 1/2	21 1/2	60
710	28	12	16	19 1/2	21 1/2	53
711	28	12	13 1/2	17	23 1/4	47
712	26	12	12	15 1/2	21 1/2	40
713	24	12	12	15 1/2	21 1/2	35
714	22	12	12	15 1/2	25 1/8	32
715	20	12	12	15 1/2	25 1/8	27
716	20	12	8	11 1/2	23 1/4	23
717	18	12	12	15 1/2	25 1/8	25
718	28	13 1/2	16	19 1/2	13 1/4	32
719	28	13 1/2	14 1/2	18	23 1/4	32
720	26	13 1/2	16	19 1/2	13 1/4	28
721	26	13 1/2	12	15 1/2	13 1/4	26
722	26	16	14 1/2	18	21 1/2	27
723	24	13	12	15 1/2	13 1/4	20
724	24	16	14 1/2	18	21 1/2	23
725	22	13	12	15 1/2	13 1/4	18
726	22	13 1/2	14 1/2	18	21 1/2	19
727	20	12	12	15 1/2	13 1/4	14
728	20	10	8	11 1/2	23 1/4	12
729	18	12	12	15 1/2	13 1/4	11

Numbers and Capacity of Reels in Feet of Different Sizes of Rope

Diam. Rope in Inches	No. of Reel									Weight per Foot in Pounds
	653	646	651	606	607	641	617	608	609	
$\frac{1}{4}$...	2000	5000	1000010
$\frac{5}{16}$...	1800	4000	5280	528012½
$\frac{3}{8}$	650	1500	3000	5000	5000	...	8000	11000	15000	.15
$\frac{7}{16}$	450	1000	2500	4000	4000	...	5000	8000	11000	.22
$\frac{1}{2}$	330	800	1500	3300	3300	...	3600	6000	8000	.30
$\frac{9}{16}$	250	600	1150	2500	2500	...	3000	5000	6000	.39
$\frac{5}{8}$	200	500	900	2000	2000	1800	2400	3500	4800	.50
$\frac{3}{4}$	160	400	700	1500	1500	1500	1800	2800	3900	.62
$\frac{7}{8}$...	250	500	1000	1000	1000	1000	1700	2500	.89
1	800	800	800	900	1100	1900	1.20
$1\frac{1}{8}$	600	600	600	800	1000	1400	1.58
$1\frac{1}{4}$	600	700	1200	2
$1\frac{3}{8}$	900	2.45
$1\frac{1}{2}$	800	3
$1\frac{3}{4}$	700	3.55
	633	610	642	635	611	612	613	614	619	
$\frac{7}{16}$...	1400030
$\frac{1}{2}$	8000	10000	10000	14500	16000	1600039
$\frac{9}{16}$...	8250	8250	11400	12000	13000	1500050
$\frac{5}{8}$	5000	6000	6000	9200	10000	11000	14000	17000	26000	.62
$\frac{3}{4}$	3400	4200	4200	6400	6500	7200	9400	12500	20000	.89
$\frac{7}{8}$	2500	3400	3400	4750	5200	6000	7200	9000	13700	1.20
1	1800	2500	2500	3600	3900	4100	5500	7700	10000	1.58
$1\frac{1}{8}$	1400	2000	2000	2800	3000	3200	4500	5400	8200	2
$1\frac{1}{4}$	1100	1600	1600	2300	2500	2600	3600	4400	6700	2.45
$1\frac{3}{8}$	950	1300	1300	1900	2000	2100	3000	3600	5500	3
$1\frac{1}{2}$	750	1150	1150	1600	1800	1800	2400	3100	4650	3.55
$1\frac{3}{4}$...	900	900	1350	1400	1500	2000	2600	4000	4.15
2	...	750	750	1100	1200	1300	1750	2200	3400	4.85
$2\frac{1}{4}$	900	1000	1200	1700	2600	6.30
$2\frac{1}{2}$	700	800	1000	1300	2000	8
$2\frac{3}{4}$	650	750	1100	1650	9.85
3	550	600	900	1350	11.95

Reels mentioned are those most generally used.

Wire Rope Glossary

- Abrasion.** External or surface wear on the wires of a cable. Amount of abrasion is a partial criterion of service given by a cable.
- Aeroplane Strand.** A small seven or nineteen-wire galvanized strand made from high strength plow steel wire. Also made from crucible steel.
- Ammunition Hoists.** A device for hoisting ammunition from the magazine of a warship to guns by means of wire rope.
- Anchorage Bolts.** Foundation bolts to which a wire rope socket is attached on a cableway or bridge.
- Arc Light Rope.** A rope consisting of nine strands of four or seven galvanized wires and hemp center used for supporting arc lights.
- Back Haul Derrick.** A derrick using a single or double end line on which a multiplying tackle is used on the back of the mast to increase power of hoisting engine.
- Bail of a Socket.** The U-shaped loop on a closed socket.
- Ballast Unloaders.** A device consisting of a V-shaped plow, a large wire rope and an engine with geared propelling drum; used for stripping flat cars of gravel, rock, etc., in railroad or excavation work.
- Basket of a Socket.** The hollow conical tapered part of a socket into which a wire rope is inserted.
- Bending Stress.** Stress produced in a wire rope when it is bent around a sheave or drum. It varies with the construction of the rope and the diameter of the sheave or drum. It is constant for a fixed ratio of drum to rope diameter for a given construction of rope.
- Bicycle Cord.** A small rope consisting of nineteen strands of three wires each, made either from crucible or plow steel.
- Boom Fall Hoist.** A rope on a derrick for supporting and also for raising and lowering the boom. Usually used with four to nine parts in the hoisting block.
- Brake Cables.** Short pieces of galvanized flexible steel cables used on electric cars to give spring to the braking mechanism.
- Breaking Strength.** The load which a wire rope will stand at the point of rupture.
- Breaking Stress.** Stress induced in a wire rope at the point of breaking and corresponds to breaking strength.
- Breaking Strain.** Strain produced in a material at the point of rupture. Is not synonymous with the term breaking stress. It is the stress that produces the strain.
- Bridge Crane.** A crane for outdoor work consisting of a fixed girder attached to movable towers, which span a given place.
- Bridge Socket.** A (special) type of wire rope socket used especially for suspension bridge work and large aerial cableways. It is made in two types, viz.: open and closed, the former consisting of a casting with tapered conical hole into which cable is inserted, spread and held up, filling the interstices with babbitt, lead or zinc, and also two eye bolts, nut and pins; the closed type being similar except that it consists of a U-bolt instead of two eye bolts.
- Bright Rope.** Any wire rope that is not galvanized or tinned.
- Brittleness.** A condition of crystallization. Shown by inability of wire to stand bending when new.
- Bucket Dredge.** A dredge having a series of buckets propelled by an endless chain.
- Bull Sheave.** A large single grooved deflecting sheave used in wire rope applications.
- Button Rope.** A wire rope used on a cableway to distribute the trail carriers by means of special clamps fastened to the rope.
- Cable.** An indeterminate name applied frequently to a wire rope. It may consist of stranded, or twisted, or bunched wires, or it may be made of fibrous material.
- Cableine.** A wire rope dressing of a black, sticky nature.
- Cable Laid.** Twisted or laid together like a cable. Usually applied to a compound rope construction, e. g., 6 x 6 x 7. Also sometimes called hawser laid.
- Cable Laid Rope.** A compound laid rope consisting of several ropes or several layers of strands laid together into one rope, e. g., 6 x 6 x 7.
- Cable Road.** A tramway or street railroad operated by means of an endless wire rope furnishing power, and cars propelled therefrom by means of detachable grips.
- Cableway.** A movable piece of machinery consisting of two towers and a cable hung between them for conveying bulk material intermittently back and forth.
- Car Dumper.** A machine for raising and tilting cars to unload contents into bins or chutes, used principally for coal and iron ore.
- Cargo Hoist.** A derrick hoist rigged to a mast on shipboard for unloading and loading boats.
- Carrier.** A moving traveler used on a cableway carriage consisting of a frame and suitable sheave sheels.
- Carriage Rope.** A rope for pulling the carriage of a cableway back and forth.
- Casing Lines.** A line used with a multiplying tackle block for placing the casing on an oil well and raising or lowering the same.
- Center.** The heart of core around which the strands of a wire rope are laid. It may be cotton, hemp, jute, manila or a steel twisted strand or rope.
- Chocker.** A short length of wire rope used in logging operations to attach to a lot to pull it to the loading point.
- Circumference.** The distance around a wire rope, used more frequently in designating the size of ships' rigging and hawsers.
- Clam Shell Bucket.** A bucket consisting of two movable scoops hinged together resembling somewhat a gigantic clam, from which it derives its name. It is largely employed for handling ore, coal, etc.
- Closed Socket.** A rope fastening device consisting of a casting or forging consisting of a U-shaped bail and a tapered conical hole into which the end of a wire rope is spread out and held by filling the interstices with babbitt, lead or zinc.
- Closing Rope.** A wire rope used on a clam shell or orange peel bucket for shutting or closing the bucket and scooping up the load.
- Coal Hoists.** Consist usually of a movable hoisting tower and clam shell bucket with hoisting apparatus for same. Used for unloading coal from boats to cars, docks or stock pile.
- Coil.** A circular bundle of rope or wire of any diameter. Also used in designating wire, etc.
- Concentric Strand.** A geometrical collection of wires twisted helically and symmetrically in any number of layers about a central wire. All the wires in each layer are equidistant from the center of gravity on the strand.
- Conical Drum or Tapered Drum.** A grooved drum of varying diameter designed to give variable speed to a mine hoist and other similar machinery. End of rope is usually attached to the small end of the drum.
- Conveying Rope.** A wire rope used on a cableway for moving the carrier or load from one point to another. Also an endless rope used to handle material in bulk.
- Core.** The center or heart of a wire rope and consists of wire, hemp, jute, manila, sisal or cotton, according to conditions.
- Corrosion.** Oxidation or wearing away of a wire rope due to atmospheric conditions or moisture containing acid of acid fumes. Is usually present in mine work and where ropes are frequently wet.
- Counterweight Rope.** A wire rope used on an elevator for supporting weight used in balancing the weight of empty cage or car; also any rope used on machinery to counterbalance a piece which has to be moved more or less frequently.
- Crane Rope.** A wire rope consisting of six strands of thirty-seven wires around a hemp center.

- Cranes.** A movable bridge or girder with hoisting apparatus for lifting and transferring machinery, etc.
- Crosby Clip.** A grooved casting and U-shaped bolt and nuts for fastening wire ropes together. Named from the patentee.
- Crystallization.** The brittleness induced in a wire rope either from vibration or bending around too small sheaves. It is usually coincident with worn out condition of a wire rope.
- Crucible Steel.** A carbon acid open hearth steel having a tensile strength of 150,000 to 200,000 pounds per square inch in finished wire.
- Cypress Skidder.** Usually an overhead skidder for logging cypress and similar woods in swampy country. Consists of a suspended cable, movable carriage and engine operating carriage and hoisting lines.
- Dead Line - Endless.** A flexible wire rope used for removing discarded oil well tubing.
- Dead Load.** A quiet or steady load on a wire rope.
- Deflection.** The amount of dip at the center in a cableway or bridge span of wire rope.
- Derrick.** A general term for an apparatus consisting of a fixed mast and a movable boom for lifting the load. The mast is usually guyed at the top with six or more lengths of wire rope.
- Diameter.** The normal unit of measurement of the size of a wire rope. It is the distance across a circle circumscribing the strands of the same.
- Digging Rope.** A wire rope used on a clam shell or orange peel grab to close and fill the bucket without lifting the bucket.
- Dip.** The sag in the center of a cable span.
- Dipper Dredge.** A dredge equipped with a dipper for excavating under water.
- Double Galvanized Strand.** Strand made from very heavy galvanized wire capable in most sizes of standing four dip immersion test.
- Double Switch Rope.** A switch rope with hook and link in one end and double link in other end.
- Dragon Rope.** A 6 x 25 triangular flattened strand rope with alternate regular and lang lay strands, usually made with hemp center.
- Drilling Line.** A wire rope of varying construction used for drilling oil wells from a depth of 800 feet and over. Drilling lines are usually made left lay.
- Drum.** A round barrel upon which a wire rope is wound or stored when in use.
- Dump Rope.** A wire rope used on a cableway to discharge by tilting a loaded bucket of material.
- Ears of a Socket.** The two projections on an open socket through which is passed a pin.
- Elastic Limit.** The point at which the ratio of stress to strain ceases to be a constant or the point beyond which the material, if further stressed, takes permanent set.
- Elongation.** Amount of stretch in a material when stressed to breaking point. Usually expressed as a percentage.
- Elevator.** A cage or car operated usually by wire cable for moving passengers or freight.
- Elevator Rope.** Wire rope used for hoisting elevators. It is usually made of iron and composed of six strands, nineteen wires, one hemp core.
- Emergency Hawser.** A very flexible steel hawser for emergency towing purposes.
- Endless Rope.** A wire rope having two ends spliced together and made continuous.
- Extra Flexible Hoisting Rope.** A rope consisting of eight strands of nineteen wires each with a large hemp center.
- Extra High Strength Strand.** A plow steel strand made of extra galvanized wires.
- Extra Strong Crucible Steel.** A carbon acid open hearth steel somewhat stronger than crucible steel. Tensile strength runs from 180,000 to 220,000 pounds per square inch.
- Eye Bolt.** A bolt with a loop welded or forged in one end and the other end threaded. Used for anchorage purposes on guys, etc.
- Eye.** A thimble or loop spliced in the end of a wire rope.
- Factor of Safety.** The number of times stronger a rope is than the load it has to carry.
- Fall Rope.** The main hoisting rope of a derrick used in any number of parts.
- Fall Block.** The main hoisting block of a derrick or cableway.
- Fall Rope Carrier.** A device for supporting the operating rope on a cableway and preventing undue sagging.
- Fast Hoist.** A machine for discharging cargoes of iron ore.
- Ferry Rope.** A rope consisting of six strands, seven wires each, either bright or galvanized, used for guiding a ferry boat across a stream.
- Ferry Traveler.** A carriage operating on a wire cable used for guiding a ferry boat across a river.
- Flat Drum.** A drum of uniform diameter, usually smooth, but sometimes grooved. It is the common type in use.
- Flat Rope.** A rope consisting of alternate right and left lay rope strands, each rope strand consisting of four strands of seven wires, all sewed together with a number of soft iron sewing wires.
- Flattened Strand Rope.** A wire rope having non-cylindrical strands, usually of the oval or triangular type, so called from the fact that the center wire of each strand is an oval or a triangular wire.
- Flexibility.** Pliability. A comparative term employed by rope users to distinguish between different constructions as regards the ease of bending the completed rope.
- Galvanized Rope.** A rope made up from wires coated with zinc for protection from rust.
- Galvanized Signal Strand.** A seven-wire strand made up from single galvanized wire; sometimes made with nineteen wires.
- Glotten.** A wire rope dressing of a heavy nature used on mine rope haulage and hoisting.
- Grass Rope.** A wire rope used in lumbering for pulling back a skidding line.
- Gravity Hoist.** Any balanced hoist arranged so that the loaded car in descending an incline pulls an empty car back. This type of hoist is usually found in mine or quarry work, where the material has to be transferred to a lower level.
- Gravity Plane.** A balanced incline hoist where the empty car is pulled up by a loaded car descending.
- Grip.** An attachment for clamping to a moving cable to transmit power to cars, etc.
- Gripwheel.** A special type of sheave equipped with numerous dogs whose sides grip a rope due to lateral pressure caused by tension on the rope. It takes the place of several wraps around a drum.
- Grooved Drum.** A drum fitted with scores or grooves helically arranged to guide the rope in winding on and off.
- Grooves.** Semi-circular channels cut in drums or sheaves to guide a wire rope in its winding or unwinding.
- Ground Skidder.** Consists of a donkey engine boiler and winding machinery for coiling a wire rope. It is used for pulling logs out of the woods by main strength.
- Grubber Rope.** A strong plow steel rope used for clearing land from stumps after logging operations.
- Guy Rope.** A galvanized rope consisting usually of six strands of seven wires each and one hemp core used principally for derricks and ships' stranding rigging.
- Guy Strand.** Galvanized seven-wire strand for guying poles, smokestacks and such like.
- Hand Rope.** A very flexible rope used to operate the valves on a hydraulic elevator or the clutch on a mechanical lift. It consists of six ropes each, composed of six strands of seven wires each and seven hemp cores.
- Hardness.** An indefinite term allied to stiffness. Is really the measure of the resistance of a material to abrasion from outside sources.
- Haulage Rope.** A rope usually composed of six strands, seven wires each, one hemp core. Used largely in mines, inclined planes, coal docks, etc.
- Hawser.** A wire rope used on ships for towing purposes. Consist usually of six strands, thirty-seven wires, one hemp core, or six strands twenty-four wires, seven hemp cores.

- Haul Down Line.** A wire rope used on a cableway for changing the length of the digging rope by means of a tackle block.
- Hay Press Rope.** A rope used to operate a hay press, usually 6 x 19 or 8 x 19 construction.
- Head Rope.** The pulling out rope on a mine haulage system.
- Head Sheave.** The sheave at the top of a mine shaft.
- Heart.** The center or core of a rope usually of fibrous material.
- Hemp.** A general term applied to manila, jute, sisal and other kindred fibers. Grows in many different countries. Originally a plant of the genus *Cannabis*, the fibrous skin of bark of which is used for cordage.
- High Strength Strand.** A crucible steel strand composed of double galvanized wires.
- Hoisting Rope.** A wire rope consisting of six strands of nineteen wires each, usually made with a hemp center. Also any rope used for lifting or hoisting a load.
- Holding Rope.** The wire rope used on a clam shell or orange peel bucket for holding the empty bucket while opening to take the grab.
- Idler.** Any supporting sheave for a wire rope.
- Inclined Plane.** A system of wire rope application where the rope works up an incline.
- Inertia.** Is that property of a body by virtue of which it tends to continue in its state of rest or motion indefinitely unless acted upon by some external force.
- Inhaul Rope.** A wire rope used on a cableway to pull the carriage back to landing or dumping point.
- Inlay.** To insert or tuck a wire or strand or wind or twist together.
- Interlocked Tramway Strand.** A concentric strand composed largely of special interlocking wires to make a smooth external surface.
- Iron.** As applied to wire rope means a soft Bessemer or basic steel of low phosphorous and sulphur content.
- Ironsides.** A heavy wire rope dressing used in some mines for protecting rope.
- Jupiter Wire Rope Clip.** A wire rope clip consisting of a swinging U-bolt and nut together with cast iron or steel gripping piece.
- Jute.** The strong fiber of the East Indian *Cochorus olitorius* and *Cochorus capsularis* used for making bagging, cordage, paper, etc.
- Kinetic Energy.** The energy possessed by a body due to its weight and velocity. May be applied to any wire rope problem, including moving rope and load.
- Kink.** A short, sharp bend in a wire rope very injurious to the material composing it.
- Knock-off Hook.** A hook arranged with a latch which can be quickly fastened or released.
- Lang Lay.** A wire rope in which both the wires in the strands and the strands in the rope are twisted in the same direction.
- Left Lay.** A wire rope whose strands form a helix like a left-hand screw thread. Made by a right-hand revolution of the laying machine.
- Left Twist.** Made by a left-hand rotation of the rope machine; is also called right lay.
- Laid.** Closed or twisted together, e. g., strands are laid into a rope.
- Lay.** The pitch or angle of the helix of the wires or strands of a rope usually expressed by the ratio of the diameter of the strand or rope to one complete twist.
- Live Load.** A fluctuating, moving or changeable load.
- Lloyd's Hawser.** A hawser composed of six strands, twenty-four wires and seven hemp cores.
- Load Factor.** The quantity by which the actual weight of a load must be multiplied to get the stress corresponding thereto. See inclined planes, spans, etc.
- Loading Line.** A short piece of wire rope used on a skidder for loading logs on to cars.
- Locomotive Crane.** A boom crane mounted on a car capable usually of self propulsion from one point to another.
- Loop.** A large eye of any size spliced in the end of wire rope.
- Manila.** A fibrous hemp obtained from the *Musa textilis*, a plant allied to the banana, growing in the Philippine and other East India islands, called by the natives, "abaca."
- Marline.** A small hemp twine used on ships for serving splices.
- Marline Spike.** A long tapered steel spike used in rope splicing for opening up a wire rope.
- Mast Arm Rope.** The same as arc light rope. Consists of nine strands of four or seven wires each on hemp core.
- Messenger Lines.** Lines or ropes used on shipboard for moving boats short distances at the docks to facilitate loading, etc.
- Messenger Strand.** Seven-wire galvanized strand used for supporting lead-covered telephone cables.
- Modulus of Elasticity.** The ratio of the load applied per square inch to the extension in inches. Is known as Young's modulus. As applied to wire rope we deduct the permanent stretch from the total extension to get the true modulus.
- Monitor.** The strongest and highest grade of plow steel for wire rope purpose. Runs from 220,000 to 280,000 pounds per square inch, according to size.
- Mooring Hawser.** A short piece of galvanized wire rope used for mooring ships; 6 x 12 construction sometimes used.
- Mooring Lines.** Short lengths of galvanized hoisting or galvanized extra flexible hoisting rope with loops in one end, used for holding boats to the dock.
- Non-spinning Rope.** A wire rope consisting of eighteen strands of seven wires each in two layers, the inner layer of six strands lang lay and left lay around a small hemp core, and the outer twelve strands regular lay, right-hand lay. Will carry a load on a single end without untwisting.
- Open Socket.** A rope fastening device consisting of a casting or forging with a tapered conical hole into which the end of a wire rope is spread out and held by filling the interstices with lead, babbitt or zinc, latter material preferred. (Composed of a conical tapered basket with two ears and a pin through the ears.)
- Orange Peel Bucket.** A clam shell bucket with four leaves resembling an orange with the peel partly opened up.
- Ore Bridge.** A crane operated in connection with clam shell buckets for unloading iron ore.
- Outhaul Rope.** A wire rope used on a cableway to haul the carriage from dumping to loading point.
- Overhead Skidder.** One that uses an overhead line and traveller for skidding logs from swamps and similar places.
- Overwinding.** The winding of one layer of rope over another on a drum. Very bad practice for any wire rope and should be avoided if possible.
- Pile Drivers.** A hoisting engine and weight operated by a wire rope for setting piles.
- Pine Skidder.** A semi-overhead skidder used for logging hard pine timber.
- Plow Steel.** A medium high carbon acid open hearth steel having a tensile strength in finished wire from 220,000 to 260,000 pounds per square inch, according to size.
- Pullboat.** A boat used for logging operations. Carries engines and long lengths of wire rope.
- Pulley.** A term sometimes applied to a sheave.
- Regular Lay.** Strands twisted to the right and rope twisted to the left. Helix of the strands takes the direction of a right-hand screw thread.
- Reel.** A round cylindrical wooden drum with two flanges around which wire rope is wound for shipping and storage purposes.
- Reverse Bending.** Consists in passing of a wire rope over sheaves in different directions so that it alternates the strain in the wires from tension to compression, a condition very destructive to life of a wire rope.
- Reverse Laid.** Alternate right and left lay strands in a wire rope.
- Reverse Laid Rope.** A wire rope with alternate strands, right and left lay.

- Rheostat Rope.** A small rope consisting of eight strands of seven wires, used to operate controllers on electric cars.
- Right Lay.** Known also as regular lay. Strands twisted to the right and rope twisted to the left. Corresponds to a right-hand screw thread.
- Right Twist** Corresponds to left lay, or to a left-hand screw thread.
- Rope Clips.** A light compact fastening consisting of U-bolt, casting and two nuts for clamping together ends of a wire rope to make a loop, etc. The best type is known as the Crosby Clip.
- Rope Clamps.** Consist of two castings and two or three bolts for clamping together the ends of a wire rope to make a loop.
- Rope Dressing.** Any compound applied to a wire rope for lubricating or preserving it.
- Rope Drive.** Term applied to wire rope application for power transmission.
- Rope Laid.** A term applied to a rope composed of a number of small ropes laid together into a larger rope. Also applied to a rope composed of the ordinary number of strands and wires in contradistinction to concentric laid.
- Rope Lubricant.** A mixture having for its base an oil or grease adapted to reducing friction on a wire rope, particularly in passing over sheaves or drums.
- Rope Wire.** A general term for wire used in making wire rope, but usually means crucible or plow steel grades.
- Running Rope.** A flexible rope used largely on shipboard usually composed of six strands, twelve wires each and seven hemp cores.
- Sag.** Amount of deflection at center of a cable span when both ends of cable are at same level.
- Selvage.** An early type of wire rope not used now. It consists of a bundle of straight wires.
- Sand Line.** A small rope of six strands, seven wires, used for pumping out sand and water from oil wells during the process of drilling.
- Sash Cord.** A small rope consisting of six strands, seven wires, one hemp core, used for window weights, car curtains, etc.; sizes $\frac{1}{4}$ inch and smaller. Is used galvanized or plain.
- Seale Patent.** A special strand and construction made in one operation consisting of one large center wire surrounded by nine small wires and then by nine large wires, making nineteen in all.
- Seize.** To wrap or wind closely with wires or marline, e. g., a thimble splice is seized.
- Seizing Strand.** A small galvanized seven-wire strand used on shipboard for serving rope splices, usually made $\frac{1}{8}$ inch diameter and smaller.
- Semaphore Strand.** A signal strand used on railroads to operate signals, and made of galvanized wires.
- Serve.** To wrap closely with marline, wire or strand. All thimble and eye rope splices are sewed.
- Sewing Wire.** A soft iron wire for sewing flat ropes.
- Shackles.** A U-shaped clevis with pin for fastening for connecting two pieces of wire rope.
- Shears.** Machinery arranged in connection with wire rope for hoisting materials in bulk. An indefinite term for a semi-derrick apparatus.
- Sheave.** A round grooved wheel around which a wire rope is passed on machinery.
- Ship's Rigging.** A term applied usually to a galvanized rope of six strands, seven wires, one hemp core which is used for guying masts, etc.
- Side Line.** A wire rope used to move logs sidewise in connection with a ground skidder.
- Siemens Martin Steel.** A grade of steel intermediate in strength between iron and crucible steel. Used largely for special grade of strand known as S. M. strand.
- Signal Strand.** Unusually consists of a seven-wire galvanized strand.
- Single Galvanized Strand.** Strand made from single galvanized wire.
- Single Switch Rope.** A switch rope with hook in one end and one link in the other end.
- Sisal.** A hemp fiber prepared from the Agave Americans or American aloe. It is a cactus growing in Yucatan and is named from the port of Sisal.
- Sister Hooks.** A pair of hooks, right and left hand, arranged to prevent the hooks from slipping out under load. Used largely for electric cable installation in underground ducts.
- Skidding Line.** A wire rope used for skidding logs.
- Skidding Machine.** A machine used for logging purposes.
- Skip Hoist.** A term applied to apparatus on a blast furnace for charging it with ore, coke and limestone.
- Skip Rope.** A wire rope attached to a skip or car in a mine or blast furnace hoist.
- Sling.** A short piece of wire rope especially equipped for binding together or holding any load that is to be hoisted or moved from one point to another by means of derrick crane or other appliance. Sometimes made endless.
- Snatch Block.** A quickly detachable wire rope block used in lumbering for side lining purposes.
- Socket.** A rope fastening device consisting of a casting or forging with a tapered conical hole into which the end of a wire rope is spread out and held by filling the interstices with babbitt, lead or zinc, the latter material preferred. The best known type of rope fastening, as well as the strongest and most efficient.
- Span.** The distance between the supporting points of a wire cable suspended between two towers.
- Special Flexible Hoisting Rope.** A wire rope consisting of six strands, thirty-seven wires and one hemp core.
- Splice.** The method of uniting two separate pieces of wire rope, or of making an eye or loop in the end of the same.
- Spud Rope.** A wire rope used for raising and lowering the spuds on a dredge boat.
- Standing Rope.** Another term applied to galvanized guy rope which consists of six strands, seven wires, one hemp core.
- Step Socket.** A series of sockets, one behind the other, for fastening successive layers of wires on a tramway strand. Used principally one interlocked strand, although not necessary as ordinary bridge socket will hold.
- Stone Sawing Strand.** A short lay three-ply strand for sewing limestone rock.
- Strand, n and v.** A geometrically arranged and helically and regularly twisted assembly of wires. To strand is to become untwisted or opened up.
- Stranded.** The state of having become loosened up or untwisted as applied to a strand.
- Street Railway Cable.** A wire cable used for street railway purposes.
- Stump Pulling Rope.** Otherwise known as grubber rope.
- Sucker Rod.** A heavy seven-wire galvanized strand used for operating a number of oil well pumps from a central power plant.
- Suction Dredge.** A dredge consisting of a rotary cutter for churning up mud and rock, and suction pumps for carrying the mud to spoil point. Operated by two wire ropes known as swinging cables.
- Suspended Skidder.** A type of overhead skidder used in lumbering operations.
- Suspension Bridge.** A bridge held or carried by two or more cables, e. g., Brooklyn bridge, etc.
- Suspension Bridge Cable.** A cable used in construction of a suspension bridge consisting in large sizes of straight wires laid parallel and bound together. They are usually constructed in position.
- Swinging Cable.** Wire rope used for swinging dredges, steam shovels, etc.
- Swinging Rope.** Same as swinging cable.
- Switching Rope.** A short length of rope equipped with hook one end and link other end, or with hook and link one end and double link other end, used for railroad shipping.
- Swivel Socket.** A socket with swivel eye in the end.
- Tackle Block.** A collection of sheaves around which a wire rope is passed.
- Tag Line.** A light wire rope used in lumbering to return the skidding line.
- Tail Rope.** A wire rope used in mine haulage for pulling the head rope back into the mine.
- Tail Sheaves.** A sheave for taking up slack in a wire rope system.

- Taper Rope.** A wire rope made of gradually decreased size of wire. A beautiful theory but very bad practice commercially.
- Thimble.** An oval steel reinforcement piece around which a wire rope is bent when splicing an eye in a piece of rope. It also serves as a protector against internal chafing from pin which goes through the eye.
- Tightener.** A sheave used for taking up slack on a wire rope drive.
- Tiller Rope.** A rope consisting of six ropes of six strands each, seven wires and seven hemp cores used originally for steering gear on boats but now almost exclusively for hand ropes or elevators.
- Tinned Rope.** A wire rope composed of tinned wires. Rarely made and used only in sash cord.
- Torsion.** The twisting of a wire about its neutral axis.
- Towing Hawser.** A large flexible wire rope made of galvanized wires. Usual construction, 6 x 37 or 6 x 24.
- Track Strand.** A concentric type of strand used for cableway spans. Made with a smooth outside surface for wheels to run on.
- Trail Carrier.** A device for supporting inhaul and outhaul ropes on a wire rope cableway to prevent undue sagging.
- Tramway.** A combination wire rope system for transferring material in frequent small amounts continuously.
- Transmission Rope.** A wire rope composed of six strands, seven wires each and one hemp core. Also a rope spliced endless for transmitting power from a distance.
- Traveller.** A block containing supporting sheaves and rope sheaves for use on cableway or ferry.
- Triangular Flattened Strand Rope.** A six-strand Lang lay rope with a triangular center wire around which the strand is twisted.
- Trolley.** A combination carriage used on a cableway for running back and forth on the main cable.
- Trolley Rope.** A wire rope used to operate a trolley or carrier on a cableway or similar apparatus.
- Tubing Lines.** Wire rope used for placing oil well tubing.
- Tuck.** The finishing operation of a wire rope splice consisting of inserting the strand into the center of the rope.
- Turnbuckle.** Two nuts connected by two bars, one with right and one with left-hand threaded nuts; and bolts equipped with eyes, clevises or hooks for taking up slack in cables and similar work.
- Twist.** To form a strand or rope.
- Twisted.** Any collection of wires or strands formed helically together.
- Universal Lay.** Another name for Lang lay.
- Warrington Lay.** Known also as three-size wire construction.
- Whipping.** The undue and violent slapping back and forth of a wire rope when in motion.
- Wire Cable.** A geometrically arranged collection of wires into strands evenly and helically twisted and the assembly of strand helically into a wire rope or cable.
- Wire Center.** An arrangement of wires replacing the hemp core under certain very severe conditions. Sometimes made of a single strand of 7, 19 or 37 wires, but it is preferred to make it of a rope 6 x 7, 7 x 7, 6 x 19 or 7 x 19, etc.
- Wire Rope.** A collection of strands helically twisted with a uniform pitch about a central axis or core, each strand consisting of a plurality of wire twisted helically with a uniform pitch around a central axis or core.
- Wire Rope Preservative.** Any compound designed for application to a wire rope for the purpose of preventing rust or corrosion.
- Working Load.** Breaking strength of the rope divided by the safety factor used, which runs from 5 to 10 on wire rope applications.
- Wrecking Rope.** A short piece of strong wire rope equipped with extra heavy wire rope fittings for wrecking purposes on railroad work.
- Yacht Rigging.** Galvanized wire rope either of six strands, seven wires, or six strands, nineteen wires, any size used for guys, etc., on yachts, ships, derricks, etc.
- Yarding Lines.** Short pieces of wire rope used in connection with skidding machinery for piling the skidded logs ready for loading.

Index

	PAGE		PAGE
A eroplanes	73	D ead and Live Loads	30
Aeroplane Strand	183	Derricks	83
Alignment of Sheaves and Drums	68	Derrick Guys	60
A. S. & W. Shield Filler	199	Dictionary of Wire Rope Terms	240
Arc Light Rope	184	Double Galvanized Strand	185
		Dredges, Large, Medium, Suction and Bucket Types	93-95
B ack Haul Derrick	83	Drilling Lines for Oil Wells	123-130
Balanced Mine Hoists, Vertical, with Flat and Conical Drums	107		
Ballast Unloader Rope	103	E lasticity of Wire Rope	47
Bending Stress Curves	42-46	Electric Geared Elevators	89
Bending Stress Tables	35-41	Elevators, Hydraulic, Electric and Power Driven	86-91
Bending Stresses	31	Electric Traction Elevators	91
Breaking Strength of Wire Rope	10	Electric Traveling Cranes	81
Bridge Cables	181	Endless Haulage Systems	110
Bridge Sockets, Open and Closed	208	Extra Galvanized Extra High Strength Strand	186
Bridges, Suspension	116	Extra Galvanized High Strength Strand	186
		Extra Galvanized Siemens Martin Strand	186
C able Roads	77	Extra Galvanized Strand	185
Cableways	74	Extra Flexible Crucible Cast Steel Hoisting Rope	134
Casing Lines	134	Extra Flexible Extra Strong Crucible Cast Steel Hoisting Rope	135
Clamps	205	Extra Flexible Monitor or Improved Plow Steel Hoisting Rope	137
Clam Shell Buckets	77	Extra Flexible Plow Steel Hoisting Rope	136
Closed Sockets	206	Extra Strong Crucible Cast Steel Haulage Rope	123
Closed Bridge Sockets	208	Extra Strong Crucible Cast Steel Hoisting Rope	130
Clothes Lines	192	Extra Strong Crucible Cast Steel Special Flexible Hoisting Rope	140
Closed Sockets, Loose and Fastened	206	Extra Strong Crucible Cast Steel Standing Rope	123
Coal Dock Haulage Roads	79	Extra Strong Crucible Cast Steel Transmission Rope	123
Coal Handling Machinery	102	Extra Strong Crucible Cast Steel Wire	12
(Constructions of Wire Rope)	14	Extra Special Flexible Hoisting Rope	143
Constructions of Strands	14		
Constructions of Ropes	16	F actors of Safety	64
Crane Derrick	84	Ferries	96
Crane Rope	138		
Cranes	81		
Crosby Clips	204		
Crucible Cast Steel Extra Flexible Hoisting Rope	134		
Crucible Cast Steel Haulage Rope	122		
Crucible Cast Steel Hoisting Rope	129		
Crucible Cast Steel Special Hoisting Rope	139		
Crucible Cast Steel Standing Rope	122		
Crucible Cast Steel Transmission Rope	122		
Crucible Cast Steel Wire	11		

	PAGE		PAGE
Flat Rope Construction	23	Gravity Inclined Plane	77
Flat Rope	198	Ground Skidder	106
Flat Rope Sockets	210	Guy Factors	61
Flattened Strand Rope	144	Guying for Derricks, Ships Rigging, etc.	98-99
Flattened Strand Crucible Cast Steel Hoisting Rope	152	Guy Rope	175
Flattened Strand Crucible Cast Steel Haulage Rope	147	H andling of Wire Rope	69
Flattened Strand Extra Strong Crucible Cast Steel Hoisting Rope	153	Hand Rope	155
Flattened Strand Extra Strong Crucible Cast Steel Haulage Rope	148	Haulage Rope, 6 x 7	120
Flattened Strand Hoisting Rope	150	Haulage Rope (Flattened Strand)	145
Flattened Strand Haulage Rope	145	Hawsers, 6 x 37	180
Flattened Strand Monitor Haulage Rope	149	Hawsers, 6 x 24	179
Flattened Strand Monitor Hoisting Rope	154	Hawsers, 6 x 12	178
Flattened Strand Rope Constructions	21	Hoisting Rope (Standard, 6 x 19)	126
Flattened Strand Iron Haulage Rope	146	Hoisting Rope (Flattened Strand)	150
Flattened Strand Iron Hoisting Rope	151	Hoisting Rope (Special Flexible, 6 x 37)	138
G alvanized Crucible Cast Steel Yacht Rigging or Guy Rope	176	Hoisting Rope (Extra Flexible, 8 x 19)	133
Galvanized High Strength Aeroplane Strand	183	Hoisting Rope (Galvanized, 6 x 19)	176
Galvanized Iron and Crucible Cast Steel Running Rope	177	Hook and Chain	210
Galvanized Iron Ships Rigging or Guy Rope	175	Hook and Thimble	214
Galvanized Mast Arm or Arc Light Rope	184	Hook and Sockets	213
Galvanized Sash Cord	182	Hook, Swivel and Thimble	211
Galvanized Siemens Martin Strand	186	Horizontal Plunger Elevators	88
Galvanized or Tinned Flexible Aero- plane or Motor Boat Cord	183	How to Order Wire Rope	71
Galvanized Special Strands	189	Hydraulic Elevators	85
Galvanized Steel Cables for Suspen- sion Bridges	181	How to Gage Wire Rope	67
Galvanized Steel Deep Sea Towing Hawsers, 6 x 37	180	I nclined Cable Ropes	77
Galvanized Steel Hawsers and Moor- ing Lines, 6 x 24	179	Inclines and Slopes	49
Galvanized Steel Hawsers and Moor- ing Lines, 6 x 12	178	Interlocked Track Strand	191
Galvanized Ropes	172	Iron	11
Galvanized Strand	185	Iron Haulage Rope, 5 x 9	145
Galvanized Wire Rope	172	Iron Haulage Rope, 6 x 7	121
		Iron Hoisting Rope, 6 x 19	127
		Iron Hoisting Rope, 5 x 27	151
		Iron Standing Rope	121
		Iron Transmission Rope	121
		L ang Lay Rope	25
		Lay of Rope	25
		Lead of Rope	68
		Left Lay Rope	26
		Loading and Unloading Machinery	102
		Locomotive Cranes	82
		Locomotive Switching Ropes, Single and Double Fittings	216
		Locomotive Wrecking Ropes, Single and Double Fittings	218

	PAGE		PAGE
Log Loaders	106	Plow Steel Transmission Rope, 6 x 7	124
Lumbering, including Skidding and Loading	104	Plow Steel Standing Rope, 6 x 7	124
Lubrication of Wire Rope	70	Plow Steel Wire	12
		Pulling-in Cables	229
M anila Rope Compared with Wire Rope	236	Q uarry Derrick	84
Mast Arm Rope	174	R ange of Rope Application	27
Materials in Wire Rope	11	Regular Lay Rope	26
Mild Steel Elevator Rope	128	Renewal of Sheaves	68
Mining Rope Arrangements	107	Reverse Bending	68
Monitor Haulage Rope	125	Reverse Lay Rope	26
Monitor Hoisting Rope	132	Right Lay Rope	26
Monitor Extra Flexible Hoisting Rope	137	Rope Exposed to Moisture, Heat, etc.	70
Monitor Special Flexible Hoisting Rope	142	Rope Reels, Capacities of	238
Monitor or Improved Plow Steel	12	Rope Reels, Sizes of	239
Monitor Wire	12	Round Track Strand	190
Mooring Hawsers, 6 x 12	178	Running Rigging	177
Multiple Sheave Blocks	59		
N on-spinning Hoisting Rope, Crucible Cast Steel	158	S and Lines	123
Non-spinning Extra Strong Crucible Cast Steel	159	Sash Cord	182
Non-spinning Hoisting Rope, Monitor	161	Seale Patent Rope	17
Non-spinning Hoisting Rope, Plow Steel	160	Sewing Wire for Flat Rope	195
Non-spinning Hoisting Rope, Iron	157	Shackles, Plain and Galvanized	222
		Sheaves and Drums	67
O il Well Drilling	114	Sheaves and Wire Rope Blocks	224
Open Bridge Sockets	209	Ships Rigging, Galvanized Iron	175
Open Sockets, Loose and Attached	207	Siemens Martin Strand	186
Ore Unloading Machinery	102	Single Galvanized Strand	185
Ore Dock Haulage Ropes	78	Sister Hooks and Thimble, Loose and Attached	215
Overhead Skidders	104	Skidding Machines, Single and Double	227
Overwinding	68	Slings	49
		Slopes	210
P ile Drivers, Rope for	129	Socket with Chain	206
Plow Steel	12	Sockets, Open and Closed	208
Plow Steel Haulage Rope, 6 x 7	124	Sockets, Bridge Type	53
Plow Steel Hoisting Rope, 6 x 19	131	Spans	20
Plow Steel Extra Flexible Hoisting Rope, 8 x 19	136	Special Constructions	69
Plow Steel Special Flexible Hoisting Rope, 6 x 37	144	Speed of Wire Rope	189
		Special Extra Galv'd Strands	138
		Special Flexible Hoisting Rope, 6 x 37	227
		Special Wire Rope Fasteners	226
		Splicing Endless, etc.	230
		Splicing Wire Rope, Instructions	126
		Standard Hoisting Rope, 6 x 19	10
		Standard Breaking Strengths of Wire Rope	120
		Standing Rope	

	PAGE		PAGE
Steam Shovels	92	Thimbles, Spliced In	203
Steel Clad Hoisting Rope, 6 x 19	162	Tiller Rope	155
Steel Clad Hoisting Rope, 6 x 37	167	Towing Devices	118
Steel Clad Hoisting Rope, 6 x 61	171	Track Strand, Round and Locked	24
Step Socket	210	Track Strand for Aerial Tramways, Round	190
Stone Sawing Strand	184	Track Strand for Aerial Tramways, Locked	191
Strands, Construction of	14	Tramways	76
Stresses Due to Shocks on Wire Rope	47	Transmission Rope, 6 x 7	120
Stress Limitations of Machinery	58	Transmission Rope, 5 x 9	145
Stresses Due to Bending	31	Turnbuckles with Eyes, Hooks and Clevis End	221
Stresses Due to Dead and Live Loads	30		
Stresses in Multiple Sheave Blocks	59	Weights of Miscellaneous Substances	235
Stresses in Wire Rope Guys	60	Whiting Hoist	109
Stresses Imposed by Machinery	58	Wire Rope Blocks	224
Stresses in Spans	53	Wire Rope Clamps	205
Stresses in Wire Rope	30	Wire Rope Clips	204
Stresses Due to Shocks	30	Wire Rope Lists	119
Stresses of Inclines and Slopes	49	Wire Rope Transmission	234
Stresses of Acceleration and Retarda- tion	47	Working Loads	70
Stump Pulling	117	Worm Geared Elevator, Electric and Belt Driven	86-91
Sudden Stresses	69	Wrecking Trains	103
Suggestions to Wire Rope Users	67	Wrecking Ropes, Single and Double Fittings	218
Suspension Bridges	116		
Switching Ropes, Single and Double Fittings	216	Yacht Rope	176
Swivel Hook and Socket	212	Yarder for Logs	106
Tail Rope Haulage Systems	112		
Telephone Clamps	205		
Testing of Rope and Wire	10		
Thimbles, Loose, Regular and Extra Large	202		



Americore Rubber Covered Wire

American Wire Rope

Aeroplane Wire and Strand

Piano Wire

Mattress Wire

Weaving Wire

Broom Wire

Fence Wire

Flat Wire—Flat Cold Rolled Steel

Spoke Wire for Wire Wheels

Wire Hoops

Nails, Staples, Spikes

Electrical Wires and Cables

Barbed Wire

Rail Bonds

Woven Wire Fences

Bale Ties

Fence Gates

Tacks

Steel Fence Posts

Ignition Wire

Springs

Auto Towing Rope

Concrete Reinforcement

Juniata Horse Shoes and Calks

Sulphate of Iron

Poultry Netting

Wire Rods

Shafting—Cold Drawn Steel

Wire of Every Description



Separate illustrated catalogue issued for each of these products
 Furnished free upon request



LIBRARY OF CONGRESS

0 018 445 293 5